

# Cinema 12SF



**USER'S  
GUIDE**



# Cinema 12SF



---

## User's Guide

Copyright © 2001 by BOXLIGHT  
Poulsbo, Washington. All rights reserved.

---

### **FCC Warning**

This equipment has been tested and found to comply with the limits for a Class B digital device, pursuant to part 15 of the FCC Rules. These limits are designed to provide reasonable protection against harmful interference in a residential installation. This equipment generates, uses and can radiate radio frequency energy and, if not installed and used in accordance with the instructions, may cause harmful interference to radio communications. However, there is no guarantee that interference will not occur in a particular installation. If this equipment does cause harmful interference to radio or television reception, which can be determined by turning the equipment off and on, the user is encouraged to try to correct the interference by one or more of the following measures:

- Reorient or relocate the receiving antenna.
- Increase the separation between the equipment and receiver.
- Connect the equipment into an outlet on a circuit different from that to which the receiver is connected.
- Consult the dealer or an experienced radio/TV technician for help.

### **Canada**

This Class B digital apparatus complies with Canadian ICES-003.  
Cet appareil numérique de la classe B est conforme à la norme NMB-003 du Canada.

### **Safety Certifications**

UL, CUL, TÜV, NOM, IRAM

---

## **Declaration of Conformity**

Manufacturer:BOXLIGHT

19332 Powder Hill Place, Poulsbo, Washington, USA

We declare under our sole responsibility that the Studio Experience Cinema 12SF projector conforms to the following directives and norms:

EMC Directive 89/336/EEC, Amended by 93/68/EEC

EMC: EN 55022

EN 55024

EN 61000-3-2

EN 61000-3-3

Low Voltage Directive 73/23/EEC, Amended by 93/68/EEC

Safety: EN 60950: 1992 + A1 + A2 + A3 + A4: 1997

November, 2001

## **Trademarks**

Apple, Macintosh, and PowerBook are trademarks or registered trademarks of Apple Computer, Inc. IBM and PS/2 are trademarks or registered trademarks of International Business Machines, Inc. Microsoft, PowerPoint, and Windows are trademarks or registered trademarks of Microsoft Corporation. Digital Light Processing is a trademark or registered trademark of Texas Instruments. Faroudja is a trademark or registered trademark of Faroudja Laboratories, Inc.



---

## TABLE OF CONTENTS

<b>Safety Instructions</b>	<b>iii</b>
<b>Introduction</b>	<b>I</b>
Image Resolution	1
Compatibility	1
Unpacking the Projector	1
Usage Guidelines	4
If You Need Assistance	4
Warranty	4
<b>Setting up the Projector</b>	<b>5</b>
Connecting the Enhanced Connectivity Module	7
Connecting a Video Device	9
Displaying a TV signal	11
Displaying a DVD or VHS tape	15
Projecting HDTV	19
Projecting a video game	21
Connecting a camcorder	21
Connecting a Computer	23
Displaying your Computer Source	24
Turning Off the Projector	26
<b>Using the Projector</b>	<b>27</b>
Basic Image Adjustment	27
Adjusting the Projector	27
Using the Remote Control	29
Using the Keypad and Remote Buttons	30
Using the On-Screen Menus	33
Display Menu	34
Audio Menu	36
Image Menu for Video Sources	37
Image Menu for Computer Sources	42
Color Management Menu	44
Control Menu	45
Advanced Menu	46
Language Menu	47
Status Menu	48

<b>Maintenance &amp; Troubleshooting</b>	<b>49</b>
Cleaning the Lens	49
Replacing the Projection Lamp	49
Cleaning the Projection Lamp Filter Screens	52
Replacing the Batteries in the Remote Control	53
Troubleshooting	54
<b>Appendix</b>	<b>61</b>
Specifications	61
Accessories	62
Audio/video inputs on the Enhanced Connectivity Module	63
Projected Image Size	64
<b>Index</b>	<b>67</b>



---

## SAFETY INSTRUCTIONS

Please read and follow all safety instructions provided BEFORE using your new projector. Failure to comply with safety instructions may result in fire, electrical shock, or personal injury and may damage or impair protection provided by equipment. Please save all safety instructions.

### Safety Definitions:

- **Warning:** Statements identify conditions or practices that could result in personal injury.
- **Caution:** Statements identify conditions or practices that could result in damage to your equipment.

### Safety Symbols:



**Attention:** For information about usage of a feature, please refer to the User's Guide.



**Warning:** Hot surface. Do not touch.



An arrow pointing to the lamp door on the projector.

### Safety Terms:

- **Warning:** Don't look directly into the lens when the lamp is turned on.
- **Warning:** To replace the lamp, turn off the projector and unplug the power cord. To avoid burns, wait 30 minutes before opening the lamp door. Follow all instructions provided in this User's Guide.
- **Warning:** Please use the power cord provided. Connect the power cord to a receptacle with a protective safety (earth) ground terminal.

- **Warning:** Refer all service to qualified service personnel. Servicing your own projector will void the warranty. See below for the technical support contact information.
- **Caution:** Don't block ventilation openings. Use of an unauthorized ceiling mount may lead to ventilation blockage and/or personal injury.
- **Caution:** Don't subject projector to prolonged exposure to smoke.
- **Caution:** Don't set liquids on the projector. Spilled liquids may damage your projector.
- **Caution:** Don't place the projector on a hot surface or in direct sunlight.
- **Caution:** Do not drop the projector. Transport the projector in a Studio Experience-approved case; see page 63 for a list of cases.

### Important Operating Considerations

Do not place the projector on a tablecloth or other soft covering that may block the vents. Use only a Studio Experience-approved ceiling mount. In the unlikely event of the bulb rupturing, thoroughly clean the area around the projector and discard any edible items placed in that area.

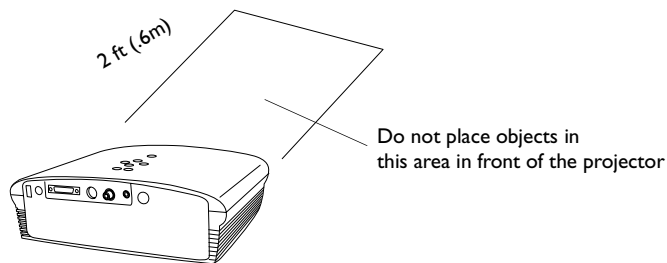

### Technical Support

If you need assistance, call BOXLIGHT Technical Support at **1-800-762-5757** or **360-779-7901**.

---

## INTRODUCTION

The Studio Experience® Cinema 12SF™ multimedia projector is specifically designed for home theater applications. It generates crisp, clear images using Digital Light Processing™ (DLP) technology and Faroudja™ video processing. It is easy to connect, easy to use, easy to transport, and easy to maintain.

### Image Resolution

The projector has a Dual Mode DMD that provides two resolutions: 848x480 for 16:9 format and 800x600 for 4:3 format (see page 9 for more information on video formats).

For computer sources, the SVGA resolution of the Cinema 12SF's projected image is 800x600. The projector is compatible with screen resolutions up to 1024x768. If your computer's screen resolution is higher than 1024x768, reset it to a lower resolution before you connect the projector.

### Compatibility

The projector is compatible with a wide variety of computers and video devices, including:

- Most standard VCRs, DVD players (progressive and interlaced), HDTV sources, DVI sources (including HDCP material), TV and satellite tuners, camcorders, video games, and laser disc players.
- IBM-compatible computers, including laptops, up to 1024x768 resolution.
- Apple® Macintosh® and PowerBook® computers up to 1024x768 resolution.

### Unpacking the Projector

The projector comes with the items shown in Figure 1. Check to make sure all are included. **Contact Studio Experience immediately if anything is missing.**



**NOTE:** The projector automatically expands 640x480 computer images to 800x600. You can display these images at their native resolutions by using the Resize feature. See "Resize" on page 42 for more information.



**NOTE:** The projector is compatible with 1080i, 1035i, and 720P HDTV formats.

If you are experienced in setting up presentation systems, use the *Quick Start* card that was included in the shipping box. For complete details on connecting and operating the projector, refer to this User's Guide.

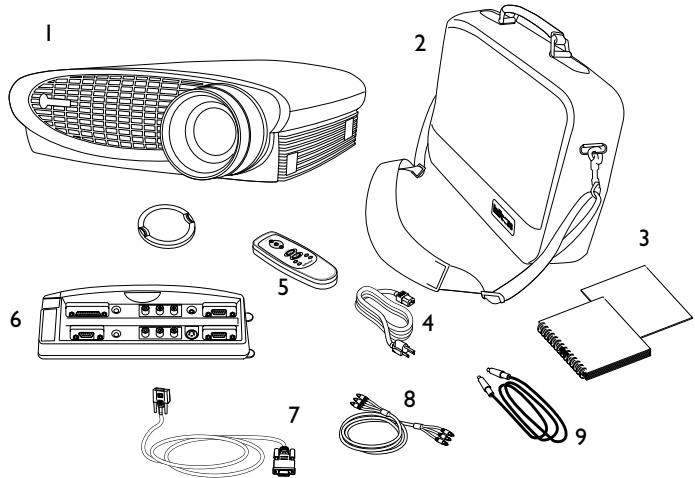

**FIGURE I**  
*Shipping box contents*

- |                                      |                                 |
|--------------------------------------|---------------------------------|
| 1. Projector + lens cap              | 6. Enhanced Connectivity module |
| 2. Soft carry case                   | 7. Computer cable               |
| 3. User's Guide and quick start card | 8. Audio/Video (A/V) cable      |
| 4. Power cord                        | 9. S-video cable                |
| 5. Remote control                    |                                 |

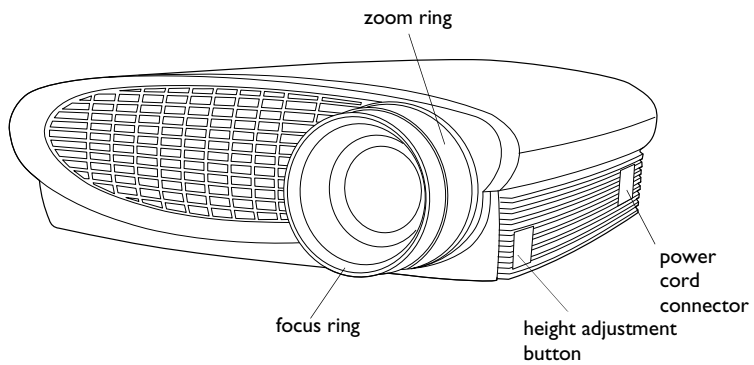

**FIGURE 2**

*Front view of projector*

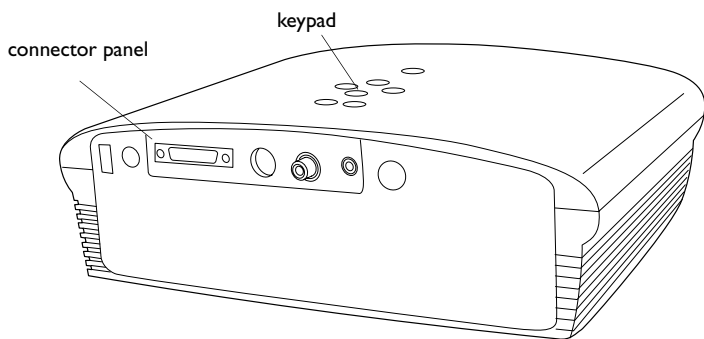

**FIGURE 3**

*Back view of projector*

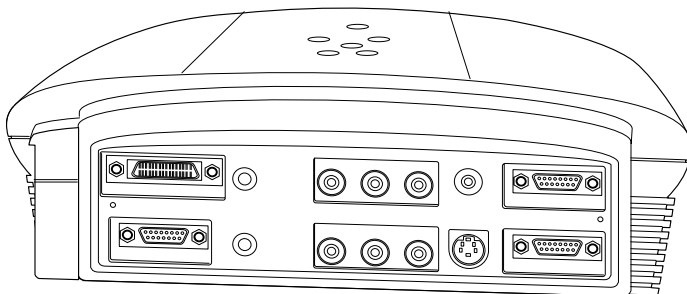

**FIGURE 4**

*Back view of projector with Enhanced Connectivity Module attached*

### **Usage Guidelines**

- Do not look directly into the projection lens when the lamp is turned on. The bright light may harm your eyes.
- Do not block the grills on the projector. Restricting the air flow can cause it to overheat and turn off. If this happens, you must wait a minute before attempting to turn it back on.
- Handle the projector as you would any product with glass components. Be especially careful not to drop it.
- Avoid leaving the projector in direct sunlight or extreme cold for extended periods of time. If this happens, allow it to reach room temperature before use.
- Transport the projector in a vendor-approved hard or soft case.
- Do not subject projector to prolonged exposure to smoke. Smoke may cause damage to the projector.

### **If You Need Assistance**

The first place to look for help is in this manual. Be sure to check the guidelines in “Troubleshooting” on page 54.

If this manual doesn’t answer your question, call BOXLIGHT Technical Support at **1-800-762-5757** or **360-779-7901**.

### **Warranty**

This product is backed by a limited three-year warranty. The details of the warranty are printed at the back of this manual.

---

## SETTING UP THE PROJECTOR

There are a number a factors to consider when determining where to set up the projector, including the size and shape of your screen, the location of your power outlets, and the distance between the projector and the rest of your equipment. Here are some general guidelines.

- 1 Position the projector on a flat surface at a right angle to the screen.
  - The projector must be within 10 feet (3 m) of your power source and within 6 feet (1.8 m) of your video device (unless you purchase extension cables).
  - If you are installing the projector on the ceiling, refer to the installation guide that comes with the Ceiling Mount Kit for more information. To turn the image upside down, see “Ceiling Project” on page 46. Studio Experience recommends use of an authorized ceiling mount. The Ceiling Mount Kit is sold separately, see “Optional Accessories” on page 63.
- 2 Position the projector the desired distance from the screen.
  - The distance from the lens of the projector to the screen, the zoom setting, and the video format determine the size of the projected image. Figure 5 shows three projected image sizes in 16:9 format. For more information about image sizes at different distances and formats, see “Projected Image Size” on page 64.

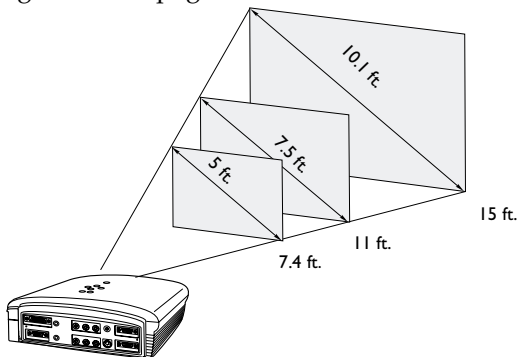

**FIGURE 5**

*Projected image size at minimum zoom*



**NOTE:** To ensure adequate cable access, do not place the projector within 6 inches (.15m) of a wall or other object.



**NOTE:** The projector must be at least 6.5 feet (2 m) from the projection screen.

The image exits the projector at a given angle. This image offset is 125.5% when the projector is in 16:9 mode (the default mode). This means that if you have an image 10' high, the bottom of the image will be 2.55' above the center of the lens.

The value is 113.7% for 4:3 mode.

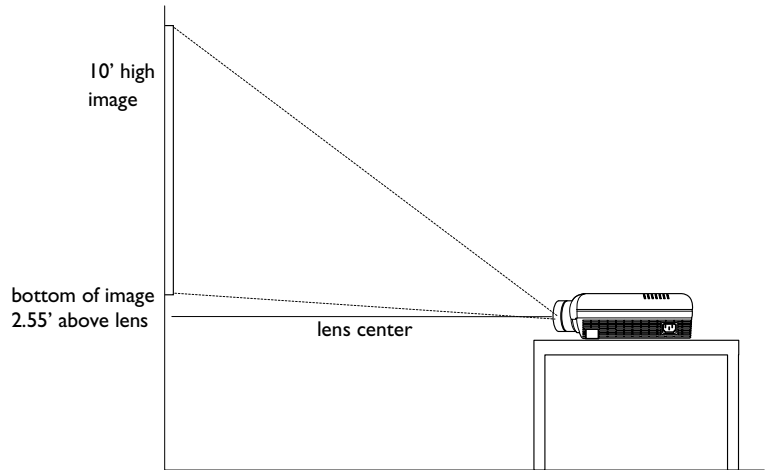

**FIGURE 6**

*Projection angle in 16:9 mode*



**WARNING:** Do not place the projector on a tablecloth or other soft covering that may block the vents. Do not use a non-Studio Experience ceiling mount. In the unlikely event of the bulb rupturing, thoroughly clean the area in front of the projector and discard any edible items placed in that area.

- 3 Make sure the projector is unplugged and your equipment is turned off.



## Connecting the Enhanced Connectivity Module

The connector panel on the back of the projector looks like this:

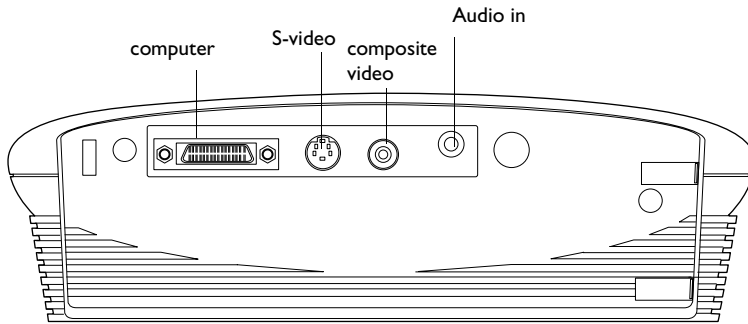

**FIGURE 7**

Connector panel

The projector ships with an enhanced connectivity module. When you attach it to the back of the projector, it looks like this:

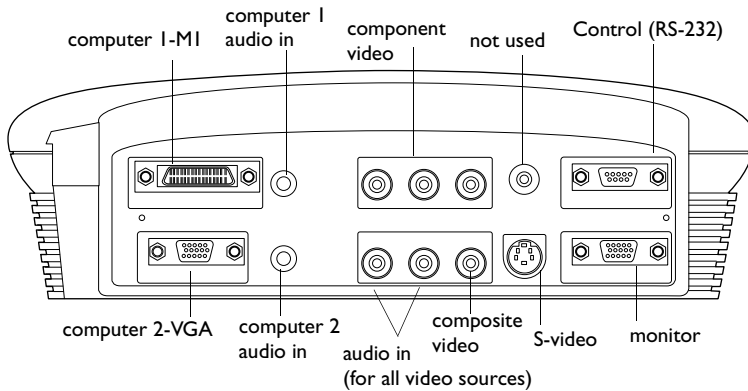

**FIGURE 8**

Connector panel with enhanced connectivity module attached

This module adds all the connectivity you need for your home theater applications.



**NOTE:** Before you continue, make sure the projector is unplugged and your equipment is turned off.



**NOTE:** If you have turned Auto Source off (page 45), you may need to press the source button more than once to display an active source. The sources switch in this order: PC 1-Analog, PC 1-Digital, Video 3-Component HDTV, Video 3-Component, Video 1 S-Video, Video 2-Composite, PC 2-Component, and PC 2-Analog.

The module connects to the projector via the projector's computer connector. Slide the tabs in the module into the grooves on the back of the projector, then press the computer connector into the projector. To remove the module, press down all the way on the textured lever on the top left of the module to release the latch, then slide the module off.

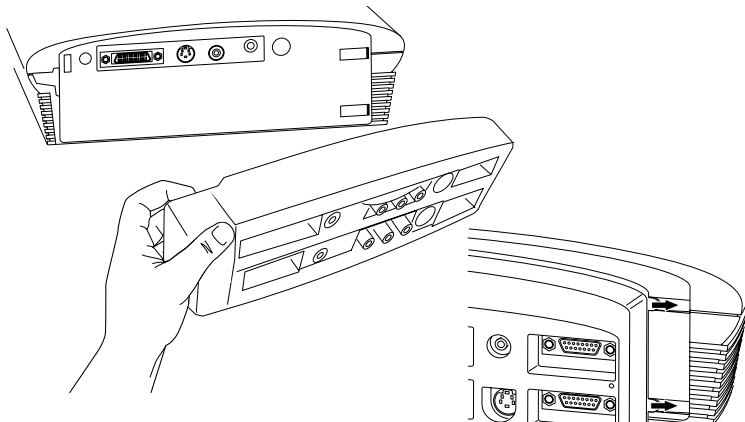

**FIGURE 9**

*Connecting the connectivity module to the projector*

The module provides two computer and three video inputs (see page 63 for a list of sources and audio/video connectors). The module also provides monitor out (used to display images on your desktop computer's monitor as well as on the projection screen), and RS-232 input (to control the projector from an LCD control panel).



**NOTE:** Monitor out is only available for analog computer, 480p, and HDTV sources.

---

## Connecting a Video Device

You can connect VCRs, DVD players, camcorders, digital cameras, video games, HDTV receivers, and TV tuners to the projector. There is an audio input. You can connect the audio directly to the projector to get sound from the 3-watt onboard speaker, or you can connect it to your stereo's receiver to get sound from your own speakers.

Before connecting your projector, you should decide which screen aspect you want to project. Screen aspect is the ratio of the image width to image height. TV screens are usually 1.33:1, also known as 4:3. HDTV and most DVDs are 1.78:1, or 16:9. If you're projecting onto a screen, the size/shape of the screen may answer this question for you. If you are projecting onto a blank wall, you don't have the screen size restriction. What you plan to project will also help you choose between 4:3 and 16:9. Most regular TV shows are 4:3, most movies are 16:9.

If you select 4:3 and play TV, the image will fill the screen. If you select 16:9 and play HDTV, the image will fill the screen. However, if you select 4:3 and play a 16:9 DVD, the image may be compressed horizontally or have black bars along the top and bottom (see Figure 10). If you select 16:9 and play regular TV, the image may be stretched horizontally or have black bars along the sides. You will make this selection later, using the onscreen menus (page 35), but for now, you just need to know which format you'll use most often.

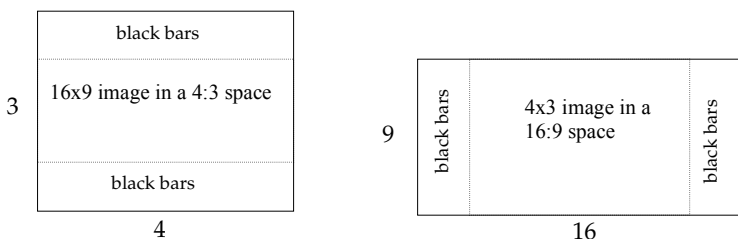

**FIGURE 10**

*4:3 and 16:9 screen aspects*

You can connect the projector to most video devices that can output video. You cannot directly connect the coaxial cable that enters your house from a cable or satellite company, the signal must pass through a tuner first. Examples of tuners are digital cable boxes, VCRs, digital video recorders, and satellite TV boxes.

Basically, any device that can change channels is considered a tuner.

The next step is to figure out what type of connectors/output the equipment you want to connect has. If there is more than one output, select the highest quality one. Component video has the best quality, followed by S-video, then composite video.

Here is a list of possible input signals and the connectors they should be connected to on the projector:

Input Signal	Connector	Connector Label on Projector	Source name on Screen
Standard Broadcast TV (not HDTV), via cable, digital cable, satellite TV, DirectTV	Composite video	video 2	Video 2-Composite
	S-video	video 1	Video 1-S-video
	Component Video	video 3	Video 3-Component
HDTV	Component video	video 3	Video 3-Component
	VGA	PC 2	PC2-Analog
	DVI	PC 1	PC1-Analog or PC1-Digital
DVD	Composite video	video 2	Video 2-Composite
	S-video	video 1	Video 1-S-video
	Component Video	video 3	Video 3-Component
VCR	Composite video	video 2	Video 2-Composite
	S-video	video 1	Video 1-S-video
Video Camera	Composite video	video 2	Video 2-Composite
	S-video	video 1	Video 1-S-video
Video Game	Composite video	video 2	Video 2-Composite
	S-video	video 1	Video 1-S-video

Here are the connection cables included with the projector:

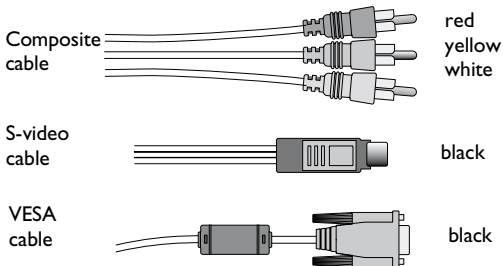

**FIGURE 11**

*Cables included with the projector*

---

## Displaying a TV signal

Determine the cables you'll need (refer to the table on page 10 if necessary). This depends on what type of output is coming from the tuner (remember, you cannot directly connect the coaxial cable that enters your house from a cable or satellite company, the signal must pass through a tuner first.) Also, determine if you want the sound to come out of the projector or out of your own audio system. You can connect the audio directly to the projector to get sound from the 3-watt onboard speaker, or you can connect it to your stereo's receiver to get sound from your own speakers.

### If your TV tuner has S-video output:

- 1 Plug one end of the S-video cable to the "S-video out" connector on your tuner (Figure 12). This connector may be labeled "To Monitor."
- 2 Plug the other end of the cable into the S-video connector (labeled video 1) on the projector.

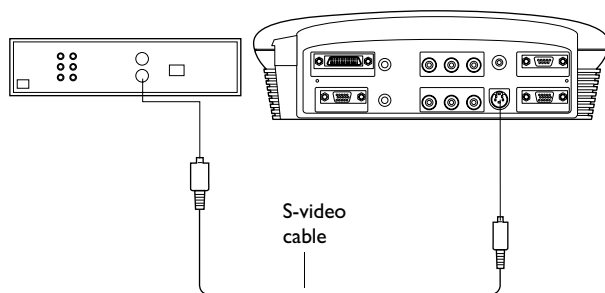

**FIGURE 12**

*Connecting the projector to a TV tuner using the S-video cable*

- 3 If you want sound from the projector's speaker, plug the A/V cable's white connector into the left "audio out" connector on your video device. Plug the cable's red connector into the right "audio out" connector on the video device (Figure 13).
- 4 Plug the A/V cable's other white connector into the white "audio L" connector on the projector. Plug the cable's other red connector into the red "audio R" connector on the projector. The yellow connectors on the A/V cable remain unused.



**NOTE:** *If needed, you can purchase longer cables at your local electronics store.*

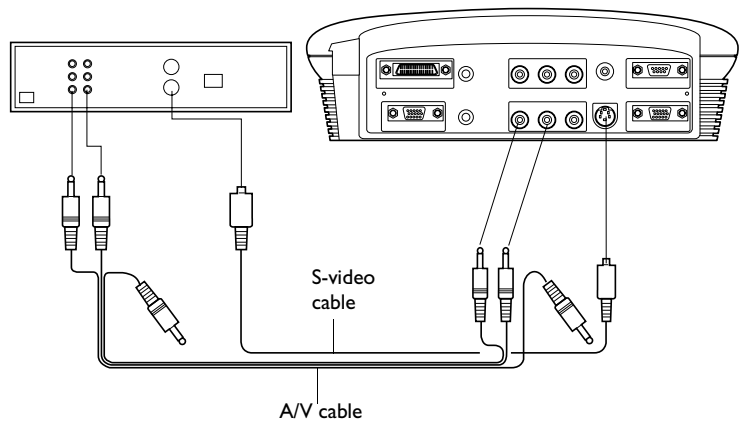

**FIGURE 13**

*Connecting the projector to a TV tuner using the S-video cable and the A/V cable*

- 5** Plug the power cord into the side of the projector, then plug it into your electrical outlet. A surge-protected power strip is recommended.
  - The LED on the top of the projector (Figure 24 on page 30) lights green.

Now you are ready to turn on the equipment and watch TV.

- 6** Remove the projector's lens cap.
- 7** Turn on the lamp by pressing the green **power** button on the keypad or remote.
  - A tone sounds when you press the button, and the LED blinks green while the software initializes. When initialization is complete, the LED lights solid green and the startup screen appears.

---

## 8 Turn on your TV tuner.

- The TV image should display on the projection screen. If it doesn't, press the **source** button on the keypad or the **video** button on the remote to display your TV image (press the button until "S-video" appears in the corner). You can select a default source to determine which source the projector examines first during power-up for active video; see "Default Source" on page 45.
- If necessary, adjust the height of the projector. See page 28.
- If necessary, adjust the zoom or focus of the image by turning the rings around the lens. See page 27.
- If you are projecting on a 4:3 screen, change the screen aspect to 4:3. See page 35.
- If necessary, make adjustments to the image using the projector's on-screen menus. To open the menus, press the **menu/select** button on the keypad or remote, then select the Display or Image sub-menu. For more information about the menus, see page 33.
- If the image is not square, use the keystone buttons on the remote to adjust the image's shape. See page 31.
- If you connected the audio cables to the projector, use the **volume** buttons on the keypad to adjust the volume. If you connected the audio cables from your tuner to your receiver, use the receiver's volume control.

The projector is compatible with these major broadcast video standards: NTSC, NTSC 4.43, PAL, PAL-M, PAL-N, PAL-60, and SECAM. It automatically adjusts to optimize its performance for the incoming video. The input signals for SECAM, PAL-M, PAL-N, and PAL 60 video are similar to other video signals and cannot be automatically detected, therefore they must be chosen manually. See page 41.

**If your TV tuner has composite video output:**

- 1 Plug the A/V cable's round yellow connector into the composite "video-out" connector on your tuner (Figure 14). This connector may be labeled "To Monitor."
- 2 Plug the other yellow connector into the yellow composite connector (labeled video 2) on the projector.

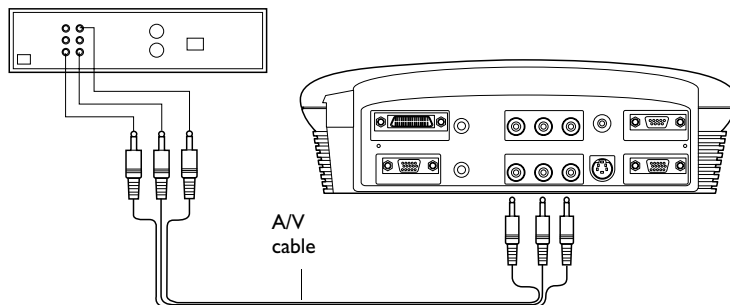

**FIGURE 14**

*Connecting the projector to a TV tuner using the audio video (A/V) cable*

- 3 If you want sound from the projector's speakers, plug the A/V cable's white connector into the left "audio out" connector on your tuner. Plug the cable's red connector into the right "audio out" connector on the tuner.
- 4 Plug the A/V cable's other white connector into the white "audio L" connector on the projector. Plug the cable's other red connector into the red "audio R" connector on the projector.
- 5 Follow steps 5-8 starting on page 12.

**If your TV tuner has component video output:**

Connect the component cable (not included) to the appropriate connectors (labeled video 3) on the projector and on your tuner. Your local electronics store should carry these cables.



---

## Displaying a DVD or VHS tape

Determine the cables you'll need. This depends on what type of output is coming from the video device. Also, determine if you want the sound to come out of the projector or out of your own audio system. You can connect the audio directly to the projector to get sound from the 3-watt onboard speaker, or you can connect it to your stereo's receiver to get sound from your own speakers.

### If your video device has S-video output:

- 1 Plug one end of the S-video cable to the "S-video out" connector on your video device (Figure 15). This connector may be labeled "To Monitor."
- 2 Plug the other end of the cable into the S-video connector (labeled video 1) on the projector.

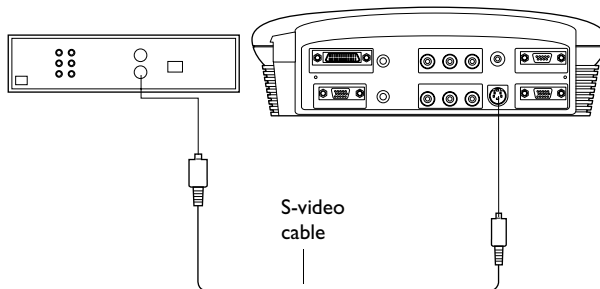

**FIGURE 15**

*Connecting the projector to a video player using the S-video cable*

- 3 If you want sound from the projector's speaker, plug the A/V cable's white connector into the left "audio out" connector on your video device. Plug the cable's red connector into the right "audio out" connector on the video device (Figure 13 on page 12).
- 4 Plug the A/V cable's other white connector into the white "audio L" connector on the projector. Plug the cable's other red connector into the red "audio R" connector on the projector. The yellow connectors on the A/V cable remain unused.



**NOTE:** *If needed, you can purchase longer cables at your local electronics store.*

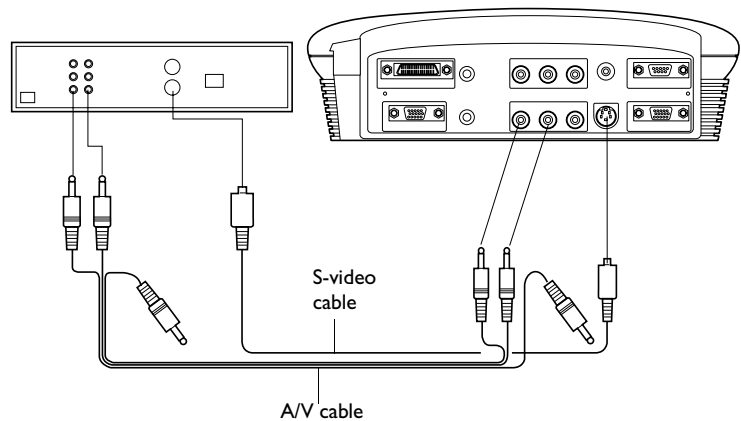

**FIGURE 16**

*Connecting the projector to a video player using the S-video cable and the A/V cable*

- 5** Plug the power cord into the side of the projector, then plug it into your electrical outlet. A surge-protected power strip is recommended.
  - The LED on the top of the projector (Figure 24 on page 30) lights green.

Now you are ready to turn on the equipment and watch a DVD or tape.

- 6** Remove the projector's lens cap.
- 7** Turn on the lamp by pressing the green **power** button on the keypad or remote.
  - A tone sounds when you press the button, and the LED blinks green while the software initializes. When initialization is complete, the LED lights solid green and the startup screen appears.

---

**8** Plug in and turn on your video device.

- The video image should display on the projection screen. If it doesn't, press the **source** button on the keypad or the **video** button on the remote to display your video image. You can select a default source to determine which source the projector examines first during power-up for active video; see "Default Source" on page 45.
- If necessary, adjust the zoom or focus of the image by turning the rings around the lens. See page 27.
- If you are projecting on a 4:3 screen, change the screen aspect to 4:3. See page 35.
- If the image is not square, use the keystone buttons on the remote to adjust the image's shape. See page 31.

**9** Insert the tape or disk you want to play, then start playing it. Some DVDs start automatically, some require you to select Play Movie from the startup screen.

- Select a different resize option, if desired. The choices are standard, widescreen letterbox, enhanced widescreen, and native. See page 42 for details.
- If you connected the audio cables to the projector, use the **volume** buttons on the keypad to adjust the volume. If you connected the audio cables from your video device to your receiver, use the receiver's volume control.
- If necessary, make adjustments to the image using the projector's on-screen menus. To open the menus, press the **menu/select** button on the keypad or remote, then select the Display or Image sub-menu. For more information about the menus, see page 33.

**If your video device has composite video output:**

- 1 Plug the A/V cable's round yellow connector into the composite "video-out" connector on your video device (Figure 17). This connector may be labeled "To Monitor."
- 2 Plug the other yellow connector into the yellow composite connector (labeled video 2) on the projector.

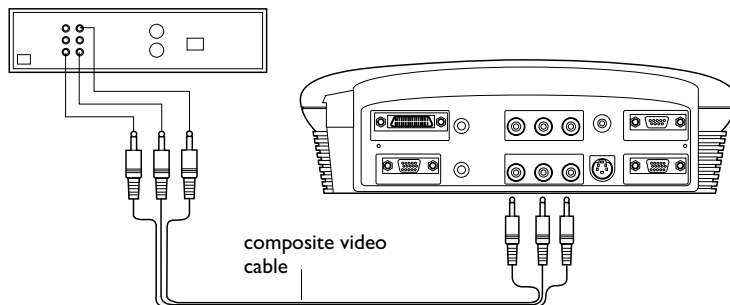

**FIGURE 17**

*Connecting the projector to a video player using the audio video (A/V) cable*

- 3 If you want sound from the projector's speaker, plug the A/V cable's white connector into the left "audio out" connector on your video device. Plug the cable's red connector into the right "audio out" connector on the video device.
- 4 Plug the A/V cable's other white connector into the white "audio L" connector on the projector. Plug the cable's other red connector into the red "audio R" connector on the projector.
- 5 Follow steps 5-10 starting on page 16.

---

## Projecting HDTV

Determine the cables you'll need (refer to the table on page 10 if necessary). This depends on what type of output is coming from the tuner (remember, you cannot directly connect the coaxial cable that enters your house from a cable or satellite company, the signal must pass through a tuner first.) Also, determine if you want the sound to come out of the projector or out of your own audio system. You can connect the audio directly to the projector to get sound from the 3-watt onboard speaker, or you can connect it to your stereo's receiver to get sound from your own speakers.

### If your HDTV tuner has a 15-pin VGA output:

- 1 Plug one end of the VESA cable to the VGA connector on your HDTV source (Figure 18). This connector may be labeled "To Monitor."
- 2 Plug the other end of the cable into the VESA connector (labeled PC 2) on the projector.

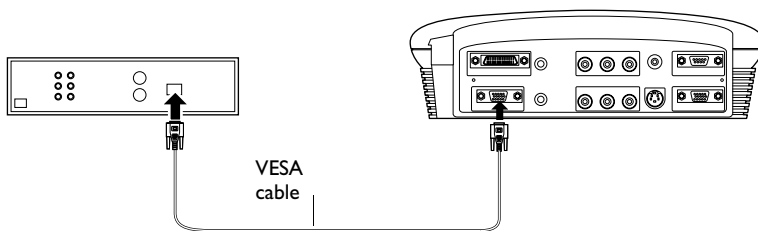

**FIGURE 18**

*Connecting the projector to an HDTV source using the VESA cable*

- 3 If you want sound from the projector's speaker, plug the A/V cable's white connector into the left "audio out" connector on your tuner. Plug the cable's red connector into the right "audio out" connector on the tuner.
- 4 Plug the A/V cable's other white connector into the white "audio L" connector on the projector. Plug the cable's other red connector into the red "audio R" connector on the projector. The yellow connectors on the A/V cable remain unused.



**NOTE:** If needed, you can purchase longer cables at your local electronics store.

- 5 Plug the power cord into the side of the projector, then plug it into your electrical outlet. A surge-protected power strip is recommended.
  - The LED on the top of the projector (Figure 24 on page 30) lights green.

Now you are ready to turn on the equipment and watch HDTV.

- 6 Remove the projector's lens cap.
- 7 Turn on the lamp by pressing the green **power** button on the keypad or remote.
  - A tone sounds when you press the button, and the LED blinks green while the software initializes. When initialization is complete, the LED lights solid green and the startup screen appears.
- 8 Turn on your HDTV tuner.
  - The HDTV image should display on the projection screen. If it doesn't, press the **source** button on the keypad or the **video** button on the remote to display your HDTV image. You can select a default source to determine which source the projector examines first during power-up for active video; see "Default Source" on page 45.
  - If necessary, adjust the zoom or focus of the image by turning the rings around the lens. See page 27.
  - If you are projecting on a 4:3 screen, change the screen aspect to 4:3. See page 35.
  - If necessary, make adjustments to the image using the projector's on-screen menus. To open the menus, press the **menu/select** button on the keypad or remote, then select the Display or Image sub-menu. For more information about the menus, see page 33. If you want to return to the factory default settings, choose Reset in the Advanced menu.
  - If the image is not square, use the keystone buttons on the remote to adjust the image's shape. See page 31.
  - If you connected the audio cables to the projector, use the **volume** buttons on the keypad to adjust the volume. If you connected the audio cables from your video device to your receiver, use the receiver's volume control.

---

**If your HDTV tuner has a DVI or component output:**

For DVI, connect an optional DVI cable into the connector labeled "PC 1". For component, connect an optional component video cable into the connector labeled "video 3". Follow the instructions in the previous section to connect and display these sources.

**Projecting a video game**

**To play a game from a video machine:**

Connect your equipment as described in "Connecting a Video Device" on page 9.

**To play a video game from a computer:**

Connect your equipment as described in "Connecting a Computer" on page 23.

**Connecting a camcorder**

Connect your equipment as described in "Connecting a Video Device" on page 9.

### Turning Off the Projector

If you want to turn off the projector for a short period of time, press the **standby** button on the keypad or remote. This blanks the screen for fifteen minutes, but keeps the projector running. (You can change the amount of time the projector stays in standby mode; see page 45 for details.) After 15 minutes, the lamp goes out. To exit standby mode, press the **standby** button again. (It may take several seconds for the projection lamp to reach full power and project the image again.) See page 32 for details on standby mode.



.....  
**NOTE:** Lamp life will be extended  
if you turn the power off, then wait

*1 minute while the lamp cools  
before unplugging the projector.*

*The Lamp LED will light green  
when the lamp has cooled.*

To turn off the projector, press the **power** button (you can cancel the shutdown by pressing the **power** button again within 10 seconds). The lamp turns off and the LED blinks amber for a minute while the fans continue to run to cool the lamp. When the lamp has cooled, the LED lights green and the fans stop. Unplug the power cord to completely power off the projector.



---

## Connecting a Computer

The projector ships with an analog VESA computer cable. If your computer has a digital output, you can order the optional digital M1 computer cable. Using a digital source generates the highest quality and brightest image possible.

- 1 Plug one end of the computer cable into the PC 2 connector on the projector.
- 2 Plug the other end of the computer cable into the video connector on your computer. If you are using a desktop computer, you need to disconnect your monitor cable from your computer first.

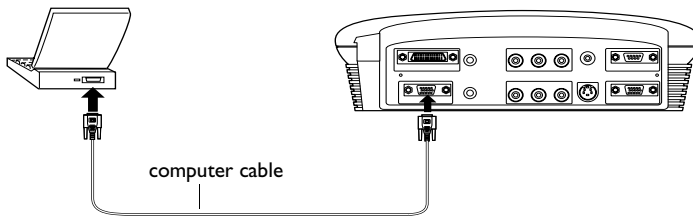

**FIGURE 19**

*Connecting the projector to a computer*



**NOTE:** Many laptop computers do not automatically turn on their external video port when a secondary display device such as a projector is connected. Refer to your computer manual for the command that activates the external video port. Activation commands for some laptop computers are listed in the Customer Support section of our website.

### Do you want to play your computer's audio on the projector?

- 1 Plug either end of an audio cable (not included) into the audio connector on your computer.
- 2 Plug the other end of the audio cable into the "audio in" connector on the projector.

### Do you want to display the image on your desktop computer's monitor as well as on the projection screen?

- 1 Plug the monitor's cable into the "monitor out" connector on the projector.

Now you're ready to power up the projector and your computer.



**NOTE:** Always use the power cord that shipped with the projector.

## Displaying your Computer Source

- 1 Remove the lens cap.
- 2 Plug the power cord into the side of the projector, then plug it into your electrical outlet. A surge-protected power strip is recommended.
  - The LED on the top of the projector (Figure 24 on page 30) lights green.
- 3 Turn on the lamp by pressing the green **power** button on the keypad or remote.
  - A tone sounds when you press the button, and the LED blinks green while the software initializes. When initialization is complete, the LED lights solid green and the startup screen appears.
- 4 Turn on your computer.
  - a The first time you connect a particular computer to the projector, the computer recognizes the projector as “new hardware” and the Add New Hardware Wizard appears. Follow these instructions to use the Wizard to load the correct driver (which was installed with your Windows operating system).

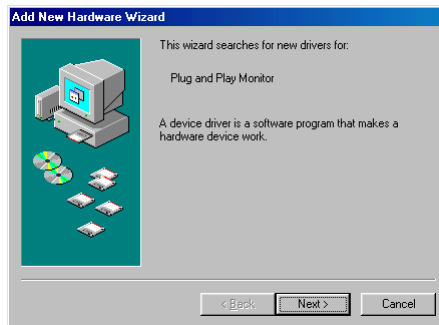

Click Next. Make sure “Search for the best driver” is selected, then click Next.



Uncheck any checked boxes, then click Next. Windows automatically locates the driver. If this driver has been removed, reload the driver using your Windows operating system CD.



When Windows finds the driver, you are ready to install it. Click Next.



Click Finish when installation is complete.



**NOTE:** *With some computers, the order in which you power up the equipment is very important. Most computers should be turned on last, after all other peripherals have been turned on. Refer to your computer's documentation to determine the correct order.*

5 The computer image should display on the projection screen. If it doesn't, press the **source** button on the keypad or the **data** button on the remote to display your computer's image. Make sure your laptop's external video port is activated; see your computer's user guide for details.

- If necessary, make adjustments to the image using the projector's on-screen menus. To open the menus, press the **menu/select** button on the keypad or remote, then select the **Display** or **Image** sub-menu. For more information about the menus, see page 33. You may need to adjust the screen aspect (page 35) or the degamma (page 44).

### Turning Off the Projector

If you want to turn off the projector for a short period of time, press the **standby** button on the keypad or remote. This blanks the screen for fifteen minutes, but keeps the projector running. (You can change the amount of time the projector stays in standby mode; see page 45 for details.) After 15 minutes, the lamp goes out. To exit standby mode, press the **standby** button again. (It may take several seconds for the projection lamp to reach full power and project the image again.) See page 32 for details on standby mode.

To turn off the projector, press the **power** button. The lamp turns off and the LED blinks amber for a minute while the fans continue to run to cool the lamp. When the lamp has cooled, the LED lights green and the fans stop. Unplug the power cord to completely power off the projector.



**NOTE:** *Lamp life will be extended if you turn the power off, then wait 1 minute while the lamp cools before unplugging the projector. The Lamp LED will light green when the lamp has cooled.*

---

## USING THE PROJECTOR

This section describes how to use and make adjustments to the projector. It also provides a reference to the keypad and remote buttons and the options available from the on-screen menus.

### Basic Image Adjustment

- 1 If the image doesn't display completely, zoom the image (page 27), adjust the height of the projector (page 28), choose a different screen aspect (page 35) or choose a different resize option (page 42). Be sure the projector lens is at a 90 degree angle to the screen.
- 2 If the image is out of focus, rotate the focus ring (page 27).
- 3 If the image is not square, adjust the keystone (page 31).
- 4 If the colors don't look right, adjust the brightness, contrast, tint, color, or sharpness (page 34) or the color space or gain (page 44).

### Adjusting the Projector

To focus the image, rotate the focus ring (Figure 20) until the image is clear. To zoom the image, rotate the zoom ring. This adjusts the image size. You can also zoom in on part of the image, see page 32.

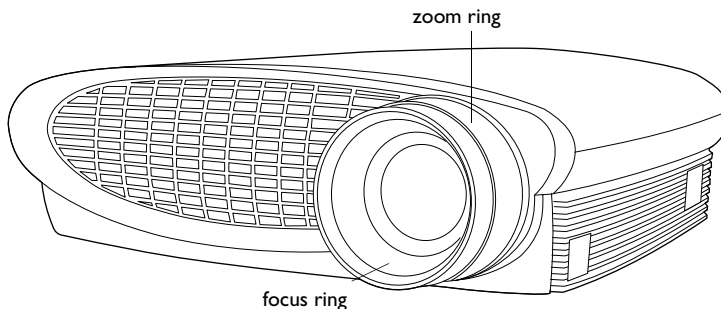

**FIGURE 20**

*Focus ring and zoom ring*



**NOTE:** To obtain the best overall focus quality, open the menu and focus on the text. This will ensure that the best overall image quality is achieved.

The projector is equipped with a self-locking, quick-release elevator foot and button.

To raise the projector:

- 1 Press and hold the elevator button (Figure 21).
- 2 Raise the projector to the height you want, then release the button to lock the elevator foot into position.

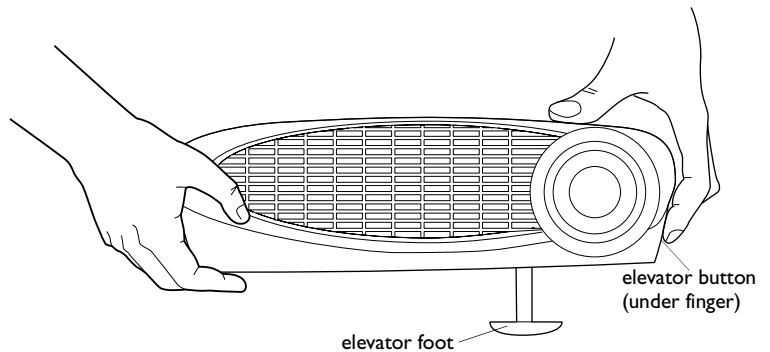

**FIGURE 21**

*Adjusting the height of the projector*

- 3 If necessary, turn the leveling knob to adjust the angle of the projected image.

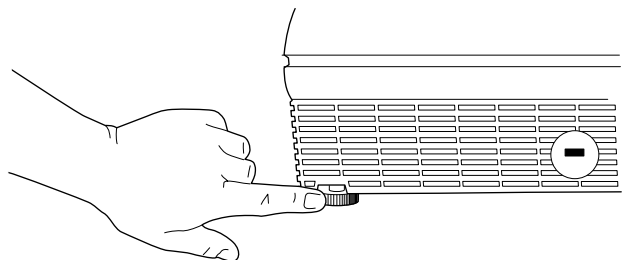

**FIGURE 22**

*Turning the leveling knob*

---

## Using the Remote Control

Install the 2 AAA batteries in the remote. See page 53 if you need help.

Point the remote control at the projection screen or at the front or back of the projector. The range for optimum operation is about 25 feet. If you point the remote at the projection screen, the distance to the screen and back to the projector must be less than or equal to 25 feet. For best results, point the remote directly at the projector.

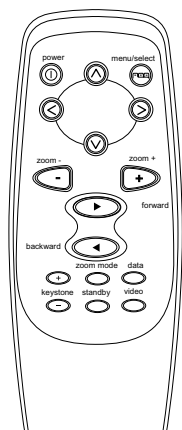
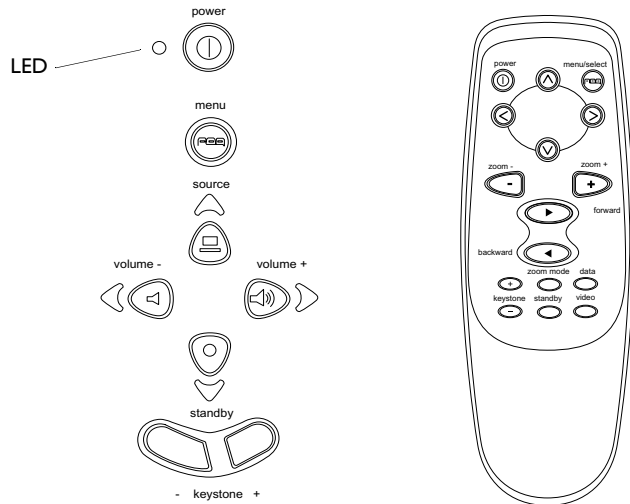

**FIGURE 23**

*Remote control*

### Using the Keypad and Remote Buttons

While the menus are displayed, the volume, source, and standby buttons on the keypad act as menu navigation buttons. See “Using the On-Screen Menus” on page 33 for details.



**FIGURE 24**

Keypad and remote buttons



**NOTE:** If you have turned Auto Source off (page 45), you may need to press the source button more than once to display an active source. The sources switch in this order: PC 1-Analog, PC 1-Digital, Video 3-Component HDTV, Video 3-Component, Video 1 S-Video, Video 2-Composite, PC 2-Component, and PC 2-Analog.

#### Menu/select

Press the **menu/select** button to open the on-screen menus. Press **menu/select** again (while Exit is highlighted) to close the menus. (The menus automatically close after 30 seconds if no buttons are pressed.) When you close the menus, the projector saves any changes you made. For more information about the on-screen menus, see page 33.

#### Source (keypad only) or Data and Video (remote only)

When you have more than one source (computer and video) connected to the projector, select between them by pressing the **source** button on the keypad or the **data** or **video** button on the remote.



---

### Keystone + -

Use this feature to adjust the image vertically and make a squarer image.

- I Press the **keystone +** button to reduce the upper part of the image, and press the **keystone -** button to reduce the lower part. You can also adjust keystone from the Display menu (see page 34 for details on the menu).

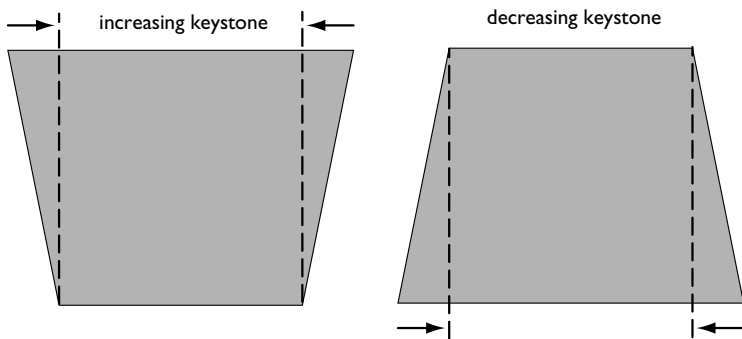

**FIGURE 25**

*Adjusting the keystone*

### Forward/back buttons (remote only)

These buttons are not used with video sources.

These buttons act like the page up and page down buttons on your computer's keyboard. You can use them to advance through a slide show in PowerPoint™ presentations. To use this feature, you must purchase an optional M1-DA cable and connect the USB connector on that cable to the computer.

### Up/down/left/right arrow buttons (remote only)

Use these buttons to navigate through and make adjustments to the on-screen menus. See "Using the On-Screen Menus" on page 33 for details.

### Power button

This turns the lamp on and off. See page 12 for startup instructions and see page 22 for shutdown instructions.

**Zoom mode**

This activates the zoom feature. When you press this button, the zoom icon appears in the lower right corner of the screen. Press the **zoom +** button to zoom in on part of the image, press the **zoom -** button to zoom out. When the image is zoomed, you can use the up/down/left/right arrow buttons to display a different part of the zoomed image (pan the image). Press **zoom mode** again to exit the mode and return the image to normal size.

You can also turn Zoom mode on using the Image menu and zoom and pan the image using the keystone buttons and arrows on the keypad. See page 42 for details.

**Zoom +/- (remote only)**



This allows you to zoom in and out on a part of the image.

**Standby** 

When you press **standby**, the display and audio turn off and a blank screen is displayed for 15 minutes. You can change the amount of time the projector stays in standby mode; see page 45 for details. The LED lights amber while the projector is in standby.

- If you press **standby** again within 15 minutes, the projector returns to normal operations immediately. The LED changes from amber to green.
- If you don't press **standby** again, the lamp turns off after 15 minutes. The LED blinks amber and the fans run while the projector cools down, then the projector shuts off and the LED lights solid green.

**Volume (keypad only)**  

To increase the volume, press **volume +** . To decrease the volume, press **volume -** .

---

## Using the On-Screen Menus

The projector has menus that allow you to make image adjustments and change a variety of settings. Most of these adjustments aren't available directly from the keypad.

To open the on-screen menus, press the **menu/select** button on the keypad or remote. (The menus automatically close after 30 seconds if no buttons are pressed.) This displays the Main menu and changes the volume, source, and standby buttons on the keypad to menu navigation and adjustment buttons (the arrow LEDs around the buttons light green to indicate the change). Press the corresponding buttons to move the cursor up and down, or use the arrow buttons on the remote. The selected menu item is highlighted.

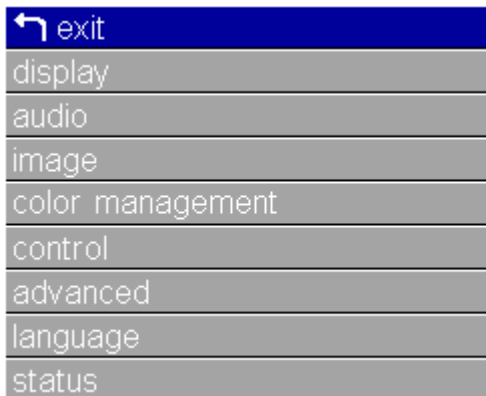

**FIGURE 26**

*Main menu*

To change a menu setting, use the up and down arrow buttons to move the cursor up and down to the item you want to change (the selected item is highlighted), then press **menu/select**. When an item is selected, its button appears depressed to provide a visual indication of selection. Use the left and right arrows to adjust the setting or turn it on and off. Press **menu/select** when you are done. Press the up and down arrows to move to another setting. When you have completed your adjustments, navigate to Exit, then press **menu/select**. You are returned to the top of the Main menu. Press **menu/select** again to exit the Main menu, or navigate to another submenu.



.....

**NOTE:** Some menu items may be grayed out (dimmed) at certain times. This indicates the item is not applicable to your setup or the item is not enabled until another selection is made.

### Display Menu

To access the Display menu settings, press the **menu/select** button to display the Main menu, press the down arrow to highlight Display, then press **menu/select** again to access the Display menu.

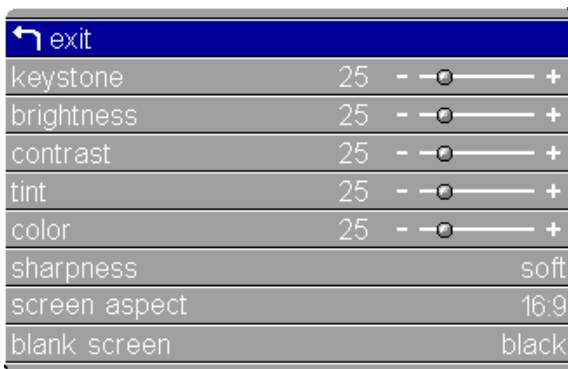

**FIGURE 27**

*Display menu*

#### Keystone

This option helps to keep the image square as the angle of projection is changed. Use this feature to adjust the image vertically and make a squarer image. See page 31 for details on keystone adjustments.

- I Press the down button to highlight Keystone, then press **menu/select**. Use the left and right arrows to adjust the keystone setting. Press **menu/select** to accept your changes.

#### Brightness

Adjusting the brightness changes the intensity of the image.

- I Use the up and down arrows to highlight Brightness, press **menu/select**, use the arrows to adjust the brightness, then press **menu/select** to accept your changes.

#### Contrast

The contrast controls the degree of difference between the lightest and darkest parts of the picture. Adjusting the contrast changes the amount of black and white in the image.

- 
- I Use the up and down arrows to highlight Contrast, press **menu/select**, use the arrows to adjust the contrast, then press **menu/select** to accept your changes.

### Tint

The tint adjusts the red-green color balance in the projected image.

- I Use the up and down arrows to highlight Tint, press **menu/select**, use the arrows to adjust the tint, then press **menu/select** to accept your changes.

### Color

The color setting adjusts a video image from black and white to fully saturated color.

- I Use the up and down arrows to highlight Color, press **menu/select**, use the arrows to adjust the color, then press **menu/select** to accept your changes.

### Sharpness

This setting adjusts sharpness of a video image.

- I Use the up and down arrows to highlight Sharpness, press **menu/select**, use the arrows to cycle through the options soft, med-soft, medium, med-hard, and hard, then press **menu/select** to accept your selection.

### Screen Aspect

This setting adjusts display format of a video image.

- I Use the up and down arrows to highlight Screen Aspect, press **menu/select**, use the arrows to choose between 4:3 and 16:9, then press **menu/select** to accept your selection.

### Blank screen

Blank Screen determines what color is displayed when there is no active source and when the projector is in standby.

- I Use the up and down arrows to highlight Blank screen, press **menu/select**, use the arrows to cycle through the options blue, black, and white, then press **menu/select** to accept your selection.



**NOTE:** The color setting applies to video sources only. The tint setting applies to NTSC video sources only.

## Audio Menu

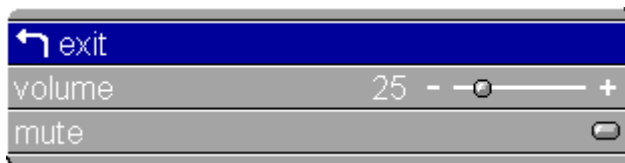

**FIGURE 28**

*Display menu*

### Volume

You can also adjust the volume directly from the projector's keypad.

- I Use the up and down arrows to highlight Volume, press **menu/select**, use the arrows to adjust the volume, then press **menu/select** to accept your changes.

### Mute

This mutes the sound.

- I Use the up and down arrows to highlight Mute, press **menu/select**, use the left or right arrow to turn mute on and off (a green bar indicates a feature is on), then press **menu/select** to accept your changes.

---

## Image Menu for Video Sources

To access the Image menu settings, press the **menu/select** button to display the Main menu, press the down arrow to highlight Image, then press **menu/select** again to access the Image menu.

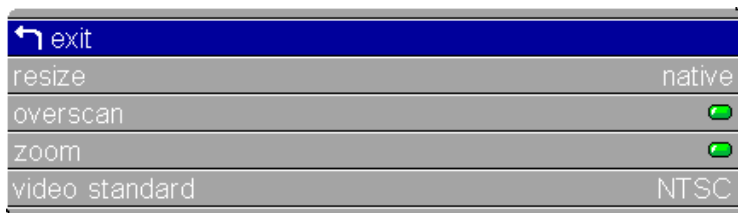

**FIGURE 29**

*Image menu for video sources*

### Resize

**Resize** allows you to select from among four different re-sizing options. The goal is to show the most detail on the screen while preserving the ratio of width to height. Often, the terms “wide-screen letterbox” or “letterbox” or “enhanced for widescreen” or “anamorphic” appear on the back of DVDs. Check for these terms, then see the following table for guidelines for which resize option to select for which setup. Following the table is a description of the Resize options.



**NOTE:** *Your viewing preferences may vary from those listed. Cycle through the resize options and pick the one you like the best.*

**Table I: Resize options for various setups**

<b>If you have this source</b>	<b>and this screen aspect</b>	<b>choose this resize option</b>	<b>to get this image</b>
standard TV	4:3	standard	full screen
standard TV	16:9	standard	4:3 image with side bars
VHS tape	4:3	standard	full screen
VHS tape	16:9	standard	4:3 image with side bars
DVD in standard	4:3	standard	full screen
DVD in standard	16:9	standard	4:3 image with side bars
DVD in widescreen letterbox	4:3	widescreen letterbox	16:9 image with top/bottom bars
DVD in widescreen letterbox	16:9	widescreen letterbox	full screen
DVD in enhanced widescreen/anamorphic	4:3	enhanced widescreen	16:9 image with top/bottom bars
DVD in enhanced widescreen/anamorphic	16:9	enhanced widescreen	full screen
HDTV	4:3	enhanced widescreen	16:9 image with top/bottom bars
HDTV	16:9	enhanced widescreen	full screen



The default Resize option is **Enhanced Widescreen**, which preserves the 16:9 aspect ratio and is designed to be used with content that is Enhanced for Widescreen TVs.

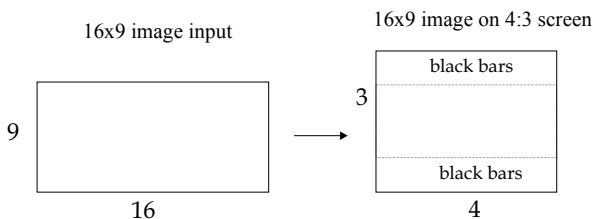

**FIGURE 30**

*16:9 input on 4:3 screen with Resize set to Enhanced Widescreen*

**Widescreen Letterbox** preserves the 16:9 aspect ratio. If you have a 16:9 source and screen, the image fills the screen (Figure 31). If you have a 16:9 source and a 4:3 screen, the image is placed in a 4:3 space, so black bars appear at the top and bottom of the image.

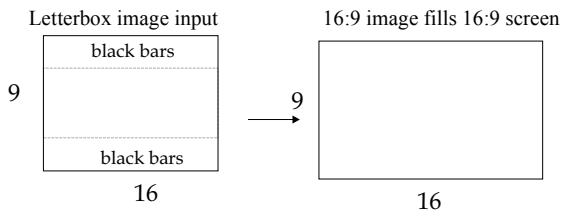

**FIGURE 31**

*16:9 input on 16:9 screen with Resize set to Widescreen Letterbox*



**NOTE:** A source that says “Anamorphic” means the same as “Enhanced for widescreen”.



**NOTE:** A source that says “Widescreen” usually means the same as “Widescreen Letterbox”.

**Standard** resizes the image from its original version to fit a standard 4:3 aspect ratio screen. If you have a 4:3 source and screen, the image fills the screen. If you have a 4:3 source on a 16:9 screen, the image is placed in a 16:9 space, so black bars appear at the sides of the image.

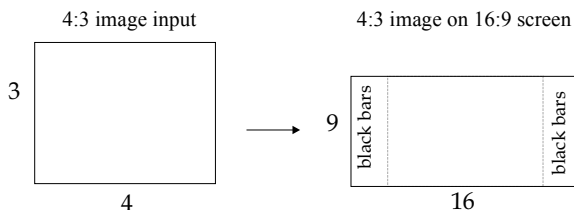

**FIGURE 32**

*4:3 input on 16:9 screen with Resize set to Standard*

**Native** displays the image with no resizing.

Highlight **Resize**, press **menu/select**, use the left or right arrow buttons to cycle through the options, then press **menu/select** to select.

---

### Overscan

This option crops all the edges of the image to remove noise generated on the edges by your source.

### Zoom

This allows you to enter zoom mode without using the remote. Highlight **Zoom**, press **menu/select**, use the left or right arrow buttons to turn zoom mode on, then press **menu/select**. Exit the menus to use the zoom feature. The zoom icon appears in the lower right corner. Use the **keystone +** button to zoom in and use the **keystone -** button to zoom out. Use the keypad navigation buttons on the keypad to pan the zoomed image. To exit zoom mode, either turn the feature off in the Image menu or press the **zoom mode** button on the remote.

### Video Standard

When Video is set to Auto, the projector attempts to pick the video standard (NTSC, NTSC 4.43, PAL, PAL-M, PAL-N, PAL 60 or SECAM) automatically based on the input signal it receives. (The video standard options may vary depending on your region of the world.) The input signals for SECAM, PAL-M, PAL-N, and PAL 60 video are similar to other video signals and cannot be automatically detected, therefore they must be chosen manually. If the projector is unable to detect the correct standard, the colors might not look right or the image might appear “torn.” If this happens, manually select a video standard.

Highlight **Video standard**, press **menu/select**, use the left or right arrows to cycle through the options, then press **menu/select** to select.



.....

**NOTE:** *If you already know the video standard used in your geographical area, it's often best to manually select it.*

### Image Menu for Computer Sources

To access the Image menu settings, press the **menu/select** button to display the Main menu, press the down arrow to highlight Image, then press **menu/select** again to access the Image menu.

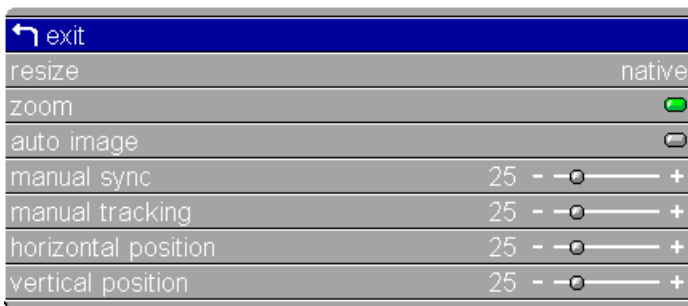

**FIGURE 33**

*Image menu for computer sources*

#### Resize

**Resize** allows you to select from among four different re-sizing options. The default is **Enhanced Widescreen**, which preserves the aspect ratio of the original theater version and is designed to be used with content that is Enhanced for Widescreen TVs. This option yields more detail than Widescreen Letterbox. **Widescreen Letterbox** also preserves the 16x9 aspect ratio of the original theater version, but the image is placed in a 4x3 space, so black bars appear at the top and bottom of the image. **Standard** resizes the image from its original version to fit a standard 4x3 aspect ratio screen. **Native** displays the image with no resizing.

Highlight **Resize**, press **menu/select**, use the left or right arrow buttons to cycle through the options, then press **menu/select** to select.

#### Zoom

This allows you to enter zoom mode without using the remote. Highlight **Zoom**, press **menu/select**, use the left or right arrow buttons to turn zoom mode on, then press **menu/select**. Exit the menus to use the zoom feature. The zoom icon appears in the lower right corner. Use the **keystone +** button to zoom in and use the **keystone -** button to zoom out. Use the keypad navigation buttons on the keypad to pan the zoomed image. To exit zoom mode, either turn the feature off in the Image menu or press the **zoom mode** button on the remote.

---

### Auto Image

The projector automatically adjusts tracking, signal synchronization and vertical and horizontal position for most computers. If you want to adjust these features manually, you must turn off **Auto image** first.

Highlight **Auto image**, press **menu/select**, then press the left or right arrow buttons to turn this feature off and on.

### Manual Sync

The projector adjusts signal synchronization automatically for most computers. But if the projected computer image looks fuzzy or streaked, try turning **Auto image** off then back on again. If the image still looks bad, try adjusting the signal synchronization manually:

- 1 Turn Auto Image off.
- 2 Highlight Manual sync, press **menu/select**, use the arrow buttons to adjust Manual sync until the image is sharp and free of streaks, then press **menu/select**.

### Manual Tracking

The projector adjusts tracking automatically to match the video signal from your computer. However, if the display shows evenly spaced, fuzzy, vertical lines or if the projected image is too wide or too narrow for the screen, try turning **Auto Image** off then back on again. If the image is still bad, try adjusting the tracking manually:

- 1 Turn Auto image off.
- 2 Highlight Manual tracking, press **menu/select**, use the arrow buttons to adjust Manual tracking until the fuzzy vertical bars are gone, then press **menu/select**.

### Horizontal/Vertical Position

Follow these steps to manually adjust the position:

- 1 Turn Auto image off.
- 2 Highlight Horizontal position, press **menu/select**, use the arrow buttons to adjust the Horizontal position, then press **menu/select**. Repeat for Vertical position, if necessary.

Positioning adjustments are saved when you turn off the projector.



**NOTE:** The **Manual Sync**, **Manual Tracking**, **Horizontal Position** and **Vertical Position** options are available only for analog computer sources. The projector sets these options automatically for digital computer and video sources, with no manual override.

## Color Management Menu

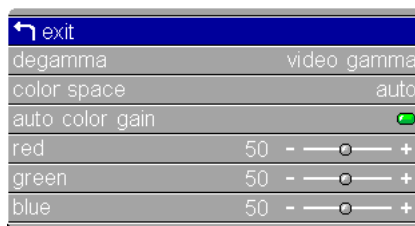

**FIGURE 34**

*Color Management menu*



**NOTE:** Your viewing preferences may vary. Cycle through the degamma options and pick the one you like the best.

### Degamma

Degamma tables contain preset color configurations optimized for the type of source. You can select a degamma table that has been specifically tuned for either computer, video, or film input. Highlight **Degamma**, press **menu/select**, use the left or right arrows to cycle through the options, then press **menu/select** to select.

### Color Space Standard

This option applies to computer and component video sources (it won't appear in the menu for S-video or composite video sources). It allows you to select a color space that has been specifically tuned for your video input. When Auto is selected, the projector automatically determines the standard. Choose RGB for computer sources, choose either SMPTE240, REC709, or REC601 for component video sources.

Highlight **Color Space Standard**, press **menu/select**, use the left or right arrows to cycle through the options, then press **menu/select** to select.

### Auto Color Gain

When this feature is On, the projector automatically sets the red, green, and blue color gains for each source. When it is off, you can manually adjust the color gains.

### Red, Green, Blue

To manually adjust the color gains:

- 1 Turn Auto Color Gain off.
- 2 Highlight Red, Green, or Blue, press **menu/select**, use the arrow buttons to adjust the gain, then press **menu/select**.

---

## Control Menu

To access the Control menu settings, press the **menu/select** button to display the Main menu, press the down arrow to highlight Control, then press **menu/select** again to access the Control menu.

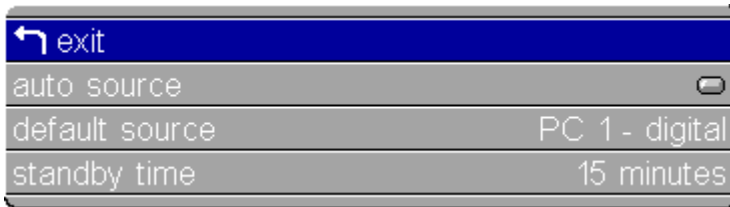

**FIGURE 35**

*Control menu*

### Auto Source

When this feature is On, the projector automatically finds the active source, checking the default source first. When this feature is Off, the projector defaults to the source selected in Default Source. To display another source, you must manually select one by pressing the **source** button on the keypad or the **data** or **video** button on the remote.

Highlight **Auto source**, press **menu/select**, then press the left or right arrow buttons to turn this feature off and on.

### Default Source

This determines which source the projector checks first for active video during power-up. Select among PC 1-Analog, PC 1-Digital, PC 2-Analog, Video1 S-Video, Video 2-Composite, and Video 3-Component.

Highlight **Default source**, press **menu/select**, use the left or right arrows to cycle through the options, then press **menu/select** to select.

### Standby Time

This option lets you select how long the lamp stays on and the blank screen is displayed when the projector enters standby mode before the projector turns off. Select among 1, 5, 10, 15 and 30 minutes and 1 and 2 hours by clicking the left or right arrow buttons and cycling through the options.

## Advanced Menu

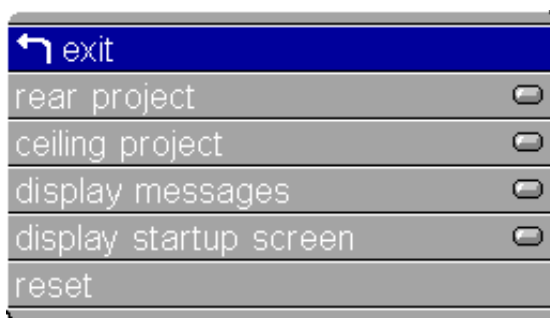

**FIGURE 36**

*Advanced menu*

### **Rear Project**

When you turn **Rear Project** on, the projector reverses the image so you can project from behind a translucent screen.

Highlight **Rear Project**, press **menu/select**, then press the left or right arrow buttons to turn this feature off and on.

### **Ceiling Project**

When you turn **Ceiling Project** on, the projector turns the image upside down for ceiling-mounted projection. Highlight Ceiling Project, press **menu/select**, then press the left or right arrow buttons to turn this feature off and on.

### **Display Messages**

This setting toggles between On and Off. When this feature is On, status messages such as “No signal detected” or “Standby Active” appear in the lower-right corner of the screen.

### **Display Startup Screen**

This setting toggles between On and Off. When this feature is On, the startup screen appears when the projector starts up and remains until an active source is detected. The startup screen contains contact information. When it is off, a plain blue, black or white screen is displayed instead of the startup screen.



---

## Reset

Highlight Reset then press **menu/select** to reset the options in the menus (except Language, Video Standard, Ceiling and Rear Project, Screen Aspect, Video Standard, and Standby Time) to their original settings.

## Language Menu



**FIGURE 37**

*Language menu*

You can display the on-screen menus in English, French, German, Spanish, Portuguese, Chinese, Japanese, or Korean.

- 1 Press the **menu/select** button to display the Main menu, press the arrow buttons to highlight Language, then press **menu/select** again to access the Language menu.
- 2 Press the arrow buttons to highlight the desired language, then press **menu/select**. Press **menu/select** to exit this menu and return to the Main menu.

### Status Menu

This is a read-only menu for informational purposes. To display the Status menu, highlight Status from the Main menu, then press **menu/select**.

↶ exit	
lamp hours used	39
video standard	NTSC
source	video 2 - composite
software version	1013101310

**FIGURE 38**

*Status menu*

#### Lamp Hours Used

Indicates how many hours the current lamp has been in use. The counter starts at zero hours and counts each hour the lamp is in use. Replace the bulb when the brightness is no longer acceptable. See “Replacing the Projection Lamp” on page 49 for details.

#### Video Standard

Shows the video standard being displayed.

#### Computer Resolution (computer sources only)

Shows the resolution of the computer being displayed.

#### Source

Indicates the active source, PC 1-Analog, PC 1-Digital, PC 2-Analog, PC 2-Component, Video 3-Component HDTV, Video 1 S-Video, Video 2-Composite, and Video 3-Component.

#### Software Version

Indicates the projector’s software version. This information is useful when contacting Technical Support.

---

## MAINTENANCE & TROUBLESHOOTING

This section describes how to:

- clean the lens
- replace the projection lamp
- clean the projection lamp filter screens
- replace the batteries in the remote
- troubleshoot the projector

### Cleaning the Lens

Follow these steps to clean the projection lens:

- 1 Apply a non-abrasive camera lens cleaner to a soft, dry cloth.
  - Avoid using an excessive amount of cleaner, and don't apply the cleaner directly to the lens.
  - Abrasive cleaners, solvents or other harsh chemicals might scratch the lens.
- 2 Lightly wipe the cleaning cloth over the lens in a circular motion.
- 3 If you don't intend to use the projector immediately, replace the lens cap.

### Replacing the Projection Lamp

The lamp hour counter in the Status menu counts the number of hours the lamp has been in use. After 1,980 hours of use, the message "Change Lamp" temporarily appears on the screen when the projector is turned on. Change the lamp within the next 20 hours. After 2,000 hours, the lamp will not light. You can order new lamp modules from Studio Experience. See "Accessories" on page 62 for information.

Follow these steps to replace the projection lamp:

- 1 Turn off the projector and unplug the power cord.
- 2 Wait 30 minutes to allow the projector to cool thoroughly.



.....

**WARNING:** To avoid burns, allow the projector to cool for at least 30 minutes before you open the lamp module door. Never extract the lamp module while the projector is operating.



**WARNING:** Be extremely careful when removing the lamp module. In the unlikely event that the bulb ruptures, small glass fragments may be generated. The lamp module is designed to contain these fragments, but use caution when removing the lamp module.

- 3 Invert the projector on a soft flat surface, then push the ridge on the lamp door toward the back (Figure 39). The arrow on the lamp door should point to the unlock icon on the bottom of the projector. Lift the door up.

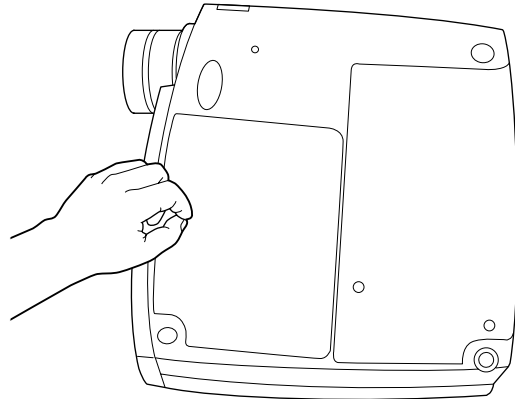

**FIGURE 39**

Removing the lamp door



**CAUTION:** Never operate the projector with the lamp door open or removed. This disrupts the air flow and causes the projector to overheat.

- 4 Loosen the two non-removable screws on the outside of the module (Figure 40).

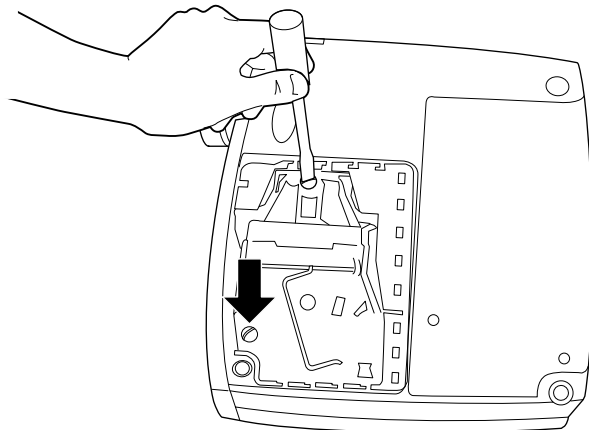

**FIGURE 40**

Loosening the screws on the lamp module

- 5 Lift and grasp the metal bail wire and lift the module out (Figure 41). Dispose of the lamp module in an environmentally proper manner.

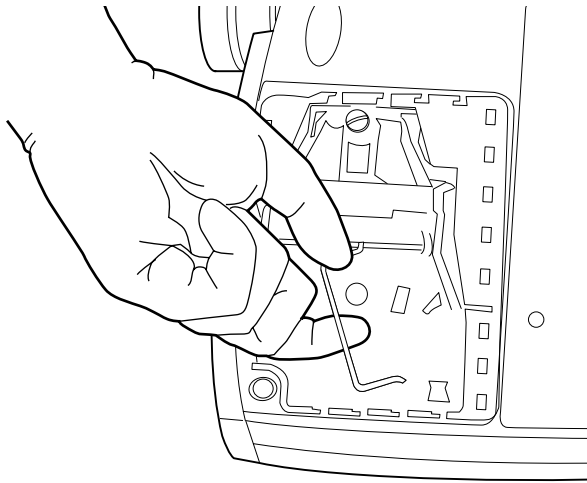

**FIGURE 41**

*Removing the lamp module*

- 6 Install the new lamp module, being sure to align the connectors properly.
- 7 Push the module in until it is flush with the bottom case of the projector.
- 8 Tighten the screws on the outside of the module.
- 9 Replace the lamp door by inserting the hooks on the lamp door into the slots on the projector and pressing the lamp door into place. The arrow on the lamp door should point to the lock icon on the bottom of the projector. If the lamp door does not fit properly or bulges out, remove the door and reseat the lamp module.
- 10 Plug in the power cord and press the green **power** button to turn the projector back on.
- 11 To reset the lamp hour counter in the Status window, press and hold the **volume -** button, then press the **source** button (while still holding down the **volume -** button) for 5 seconds. Verify that the counter was reset by viewing the counter in the Status window.



**WARNING:** Do not drop the lamp module or touch the glass bulb! The glass may shatter and cause injury.

### Cleaning the Projection Lamp Filter Screens

In dirty or dusty environments, the dust filter screens on the lamp module can become clogged, causing high temperatures inside the lamp module. These high temperatures can cause premature lamp failure. Routine maintenance to remove dust and dirt from the screens lowers the lamp operating temperature and prolongs lamp life. To maximize lamp life you may want to clean the screen every 250 hours.

- 1 Remove the lamp module. Refer to "Replacing the Projection Lamp" on page 49 for instructions.
- 2 Examine the dust filter screens on each side of the lamp module. If necessary, use a vacuum cleaner set on low power to clean the screens. Then use a cotton swab dipped in isopropyl alcohol to lightly wipe each screen. After you've wiped each screen, blow away any remaining contaminants.

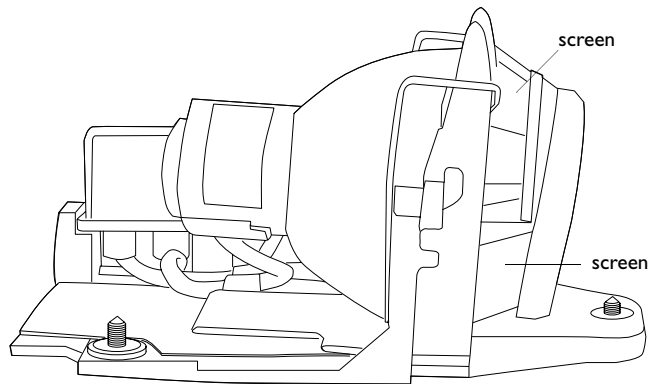

**FIGURE 42**

*Lamp module screens*

- 3 Before you replace the lamp, use the vacuum cleaner to clean the lamp housing in the projector.
- 4 Replace the lamp and lamp door.

---

## Replacing the Batteries in the Remote Control

The life of the batteries depends on how often and how long you use the remote. Symptoms of low battery charge include erratic responses when using the remote and a reduced range of operation.

Follow these steps to replace the batteries:

- 1 Turn the remote face down in your hand.
- 2 Push the tab on the battery door toward the top of the remote and lift the door off.
- 3 Remove the old batteries and dispose of them in an environmentally proper manner.
- 4 Install two new AAA alkaline batteries. Make sure you install each in the correct direction.
- 5 Insert the hooks on the battery door into the remote and press the tab to re-install the door.

**Troubleshooting**

The LED on top of the projector tells you the state of the projector.

**Table 2: LED behavior and meaning**

LED color/behavior	Meaning
solid green	the projector is plugged in, or the projector has been turned on and the software has initialized
blinking green	the power button has been pressed and the software is initializing
solid amber	the projector is in standby mode
blinking amber	the projector is powering down, the fans are running to cool the lamp
fast blinking amber	indicates fan or lamp failure

The following tables list possible symptoms and remedies to situations you may encounter. The first table details potential problems with the projector, the next one details potential problems with a video source, and finally one listing potential problems with a computer source.



**Table 3: Problem with the projector**

<b>Symptom</b>	<b>Remedy</b>
<b>The projector is not running (LED is not lit green)</b>	Make sure that the power cord is properly connected to a fully functional AC electrical outlet. Make sure that the power cord is also properly connected to the projector. If the projector is plugged into a power strip, make sure the power strip is turned on.
<b>The projector is not running (LED is lit green)</b>	Make sure the projector has been turned on by pressing the power button on the remote or keypad.
<b>Projector is running (LED lit green), but nothing appears on projection screen</b>	Make sure you have removed the lens cap on the projection lens at the front of the projector.
<b>Projector is running (LED blinking series of 3 fast amber), but nothing appears on projection screen</b>	Check the projector's lamp to ensure that it is securely connected in the lamp module. Make sure the lamp door is installed. Make sure the lamp has not been in use for over 2,000 hours. The lamp automatically shuts off at 2,000 hours. See "Replacing the Projection Lamp" on page 49.
<b>Only the start-up screen displays</b>	Verify that the cables are connected correctly. Make sure that the cables do not have any bent pins. Verify that the proper input source is connected and selected. See "Source (keypad only) or Data and Video (remote only)" on page 30. If you are watching TV, make sure the projector is connected to a tuner. Attach the source to a TV. If there is no image on the TV, the problem is with the source, not the projector.

**Table 3: Problem with the projector**

<b>No sound</b>	Adjust volume on the keypad. Turn off “mute” in the menu. See page 36. Verify audio/input connections. Adjust audio source.
<b>Lamp seems to be getting dimmer</b>	The lamp begins to lose brightness when it has been in use for a long time. Replace the lamp as described in “Replacing the Projection Lamp” on page 49.
<b>Lamp shuts off</b>	A minor power surge may cause the lamp to shut off. Unplug the projector, wait at least a minute, then plug it back in. Make sure the vents are not blocked. The lamp screens may be clogged. Avoid smoking around the projector. Clean the screens. See page 52. Make sure the lamp has not been in use for over 2000 hours. The lamp automatically shuts off after 2000 hours. See page 49.

**Table 4: Problem with a video image**

<b>Symptom</b>	<b>Remedy</b>
<b>Image is out of focus</b>	Turn the projection lens to focus the image. Make sure the projection screen is at least 5.6 feet (1.7 m) from the projector. Check the projection lens to see if it needs cleaning.
<b>Image isn't centered on the screen</b>	Move the projector to reposition the image. Adjust the height. Be sure the projector lens is at a 90 degree angle to the screen.
<b>Image is too wide or narrow for screen</b>	Adjust the zoom or projector placement. Adjust the screen aspect. Adjust the resize option.
<b>Image is not square</b>	Adjust the keystone. See page 31.
<b>Image is noisy</b>	Turn Overscan on. See page 41.
<b>Color or text not being projected</b>	You might need to adjust the brightness up or down until the text is visible. Refer to "Brightness" on page 34 for more information.
<b>Image and menus are reversed left to right</b>	Rear projection mode is probably turned on. Turn Rear Projection off in the Controls menu. The image should immediately return to forward projection. See "Rear Project" on page 46.
<b>Image and menus are upside down</b>	Ceiling mode is probably turned on. Turn Ceiling off in the Controls menu. See "Ceiling Project" on page 46.
<b>Projected colors don't match the video device's color</b>	Adjust the brightness, tint and/or contrast from the Display menu. See "Brightness" on page 34, "Tint" on page 35 and "Contrast" on page 34. Adjust the color space. See page 44.
<b>Colors are washed out or too deep</b>	Try selecting another Gamma setting. See page 44.

**Table 4: Problem with a video image**

<b>Image from component source appears “greenish”</b>	Try selecting another color space setting. If the source is 1080i, select “smpte240”. If the source is 720p, select “rec709”. If the source is 480p, select “rec601”. See page 44.
<b>Image appears “torn”</b>	The wrong video standard may be selected. See “Video Standard” on page 41.

**Table 5: Problem with a computer image**

<b>Symptom</b>	<b>Remedy</b>
<b>Only the start-up screen displays</b>	<p>Verify that the cables are connected correctly. Make sure that the cables do not have any bent pins.</p> <p>Verify that the proper input source is connected and selected. See “Source (keypad only) or Data and Video (remote only)” on page 30.</p> <p>You might need to turn everything off and power up the equipment again in the proper order. Refer to your computer’s documentation to determine the correct order.</p> <p>Make sure your laptop’s external video port is turned on. See your computer’s manual for details.</p> <p>Make sure your computer’s video board is installed and configured correctly. If you’re using Windows 98, Open “My Computer” icon, the Control Panel folder and then the Display icon. Click the Settings tab. Verify that the Desktop area is set to 1024x768 or less.</p>
<b>Image isn’t centered on the screen</b>	<p>Move the projector to reposition the image. Adjust the height.</p> <p>Be sure the projector lens is at a 90 degree angle to the screen.</p> <p>Reposition the image using the menu. Refer to “Horizontal/Vertical Position” on page 43.</p>

**Table 5: Problem with a computer image**

<b>The screen resolution is not right</b>	Make sure the computer's video card is set for a resolution of no greater than 1024x768.
<b>Image is "noisy" or streaked</b>	Try these steps in this order. <ol style="list-style-type: none"><li>1 Deactivate the screen saver on your computer.</li><li>2 Turn <b>Auto Image</b> off and then back on again. See "Auto Image" on page 43.</li><li>3 Turn <b>Auto Image</b> off and adjust the synchronization and tracking manually to find an optimal setting. See "Manual Sync" on page 43 and "Manual Tracking" on page 43.</li></ol> <ul style="list-style-type: none"><li>•The problem could be with your computer's video card. If possible, connect a different computer.</li></ul>
<b>Projected colors don't match the computer or video player's color</b>	Just as there are differences in the displays of different monitors, there are often differences between the computer image and the projected image. Adjust the brightness, tint and/or contrast from the Display menu. See "Brightness" on page 34, "Tint" on page 35 and "Contrast" on page 34.
<b>Image appears "purplish"</b>	Try selecting RGB as the color space setting. See page 44.

Before calling BOXLIGHT Technical Support for assistance, please have the following information available:

- the model name of your projector
- the projector's serial number (located on the bottom label)

Call BOXLIGHT at **1-800-762-5757** or **360-779-7901**.



---

## APPENDIX

### Specifications

The projector must be operated and stored within the temperature and humidity ranges specified.

#### Temperature

---

Operating	50 to 104° F (10 to 40° C) at sea level 50 to 95° F (10 to 35° C) at 10,000 feet
Non-operating	-4 to 158° F (-20 to 70° C)

#### Altitude

---

Operating	0 to 10,000 feet (3,048 meters)
Non-operating	0 to 20,000 feet (6,096 meters)

#### Humidity

---

Operating and non-oper.	10% to 95% relative humidity, non-condensing
-------------------------	--

#### Dimensions

---

10.4 x 11.1 x 3.3 inches (264 x 283 x 85 mm)  
with module 10.4 x 12.1 x 3.3 inches (264 x 307 x 85 mm)

#### Weight

---

6.1 lbs. (2.8 kg) unpacked  
with module 6.7 lbs. (3.0 kg)

#### Optics

---

Focus Range	6.5 - 33 feet (2-10 m)
-------------	------------------------

#### Lamp

---

Type	220-watt SHP lamp
------	-------------------

#### Input Power Requirements

---

100-120VAC 5A; 50/60Hz  
200-240VAC 3A; 50Hz

## Accessories

### Standard Accessories (ship with the projector)

---

Quick Start card  
User's Guide  
Soft Case  
Shipping Box  
VESA Computer Cable 6 ft (1.8 m)  
Audio/Video Cable 6 ft (1.8 m)  
S-Video Cable 13 ft (4 m)  
Remote  
Projection Lamp Module (included in projector)  
Lens Cap  
Enhanced Connectivity Module



**NOTE:** Use only Studio  
Experience-approved accessories.  
Other products have not been  
tested with the projector.

### Power Cords (one ships with projector, type depends on country)

---

North American Power Cord  
Australian Power Cord  
UK Power Cord  
European Power Cord  
Danish Power Cord  
Swiss Power Cord



---

## Optional Accessories

---

Hard Shell Shipping Case  
Audio/Video Cable  
Projector Ceiling Mount Kit  
Deluxe Insta-Theatre Screen-80" diagonal, 4:3 ratio  
Deluxe Insta-Theatre Screen-60" diagonal, 4:3 ratio  
Wall or Ceiling Mountable Projection Screens  
Projection Lamp Module  
High-definition S-video Cable  
High-definition Component Cable  
BOXLIGHT GyroMouse Presenter RF Remote  
Wireless keyboards and remotes

## Audio/video inputs on the Enhanced Connectivity Module

---

Source	Video	Audio
Computer 2 VESA*	VESA Single-ended analog RGB (HD-15)	mini jack
Computer 1 M1-DA	M1-DA Single-ended analog or digital	mini jack
Component Video	Base-band or HDTV component video (RCA)	Left and right line-level (2 RCAs)
Composite Video*	Base-band composite video (RCA)	Left and right line-level (2 RCAs)
S-Video*	S-video Y/C (4-pin circular)	Left and right line-level (2 RCAs)

---

\*indicates cable included with the projector

---



### Projected Image Size

**NOTE:** Use the graph and table to help you determine projected image sizes.

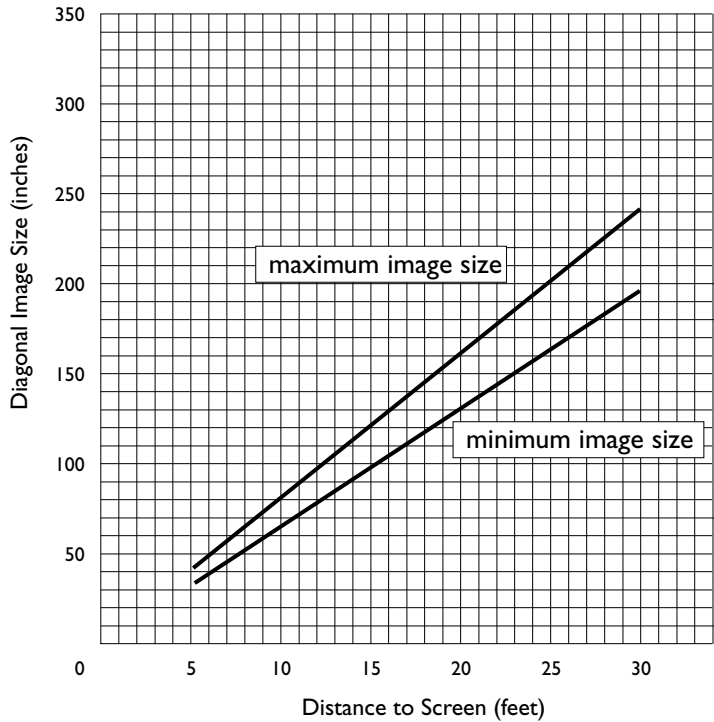
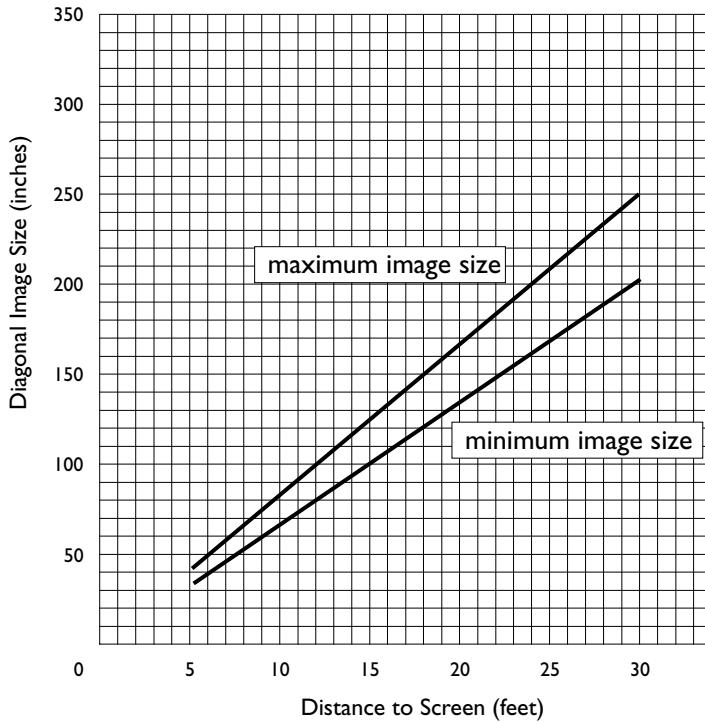

**FIGURE 43**

*Projected image size for 16:9 aspect ratio*

*Table 6:  
Range of distance to the screen for a given screen size for 16:9 aspect ratio*

Diagonal Screen Size (inches/m)	Image Width (inches/m)	Distance to screen	
		Maximum distance (feet/m)	Minimum Distance (feet/m)
60/1.5	52.2/1.33	9.1/2.77	7.4/2.26
72/1.8	62.6/1.59	10.9/3.32	8.8/2.68
84/2.1	73.1/1.86	12.7/3.87	10.3/3.14
90/2.3	78.3/1.99	13.6/4.15	11.0/3.35
100/2.5	87/2.21	15.2/4.63	12.3/3.75
120/3.1	104.4/2.65	18.2/5.55	14.7/4.48



**FIGURE 44**

*Projected image size for 4:3 aspect ratio*

*Table 7:*

*Range of distance to the screen for a given screen size for 4:3 aspect ratio*

<b>Diagonal Screen Size (inches/m)</b>	<b>Image Width (inches/m)</b>	<b>Distance to screen</b>	
		<b>Maximum distance (feet/m)</b>	<b>Minimum Distance (feet/m)</b>
60/1.5	48/1.22	8.9/2.71	7.2/2.19
72/1.8	58/1.47	10.7/3.26	8.7/2.65
84/2.1	67/1.70	12.5/3.81	10.1/3.08
90/2.3	72/1.83	13.4/4.08	10.9/3.32
100/2.5	80/2.03	14.9/4.54	12.1/3.69
120/3.1	96/2.44	17.9/5.46	14.5/4.42



---

## INDEX

### Numerics

16x9 vs 4x3 screen aspect 11

### A

accessories, ordering 64, 65

Add New Hardware Wizard 26

adjusting

brightness 36

color 37

color gain 46

contrast 36

height of the projector 30

keystone 36

tint 37

volume 34

Advanced menu options

Ceiling Project 48

Display Messages 48

Display Startup Screen 48

Rear Project 48

Reset 49

altitude limits 63

aspect ratio 11

assistance. See Technical Support

audio cable, connecting 13, 16, 17, 20,  
21, 25

Audio menu options

Mute 38

Volume 38

Auto color gain 46

auto image 45

auto source 47

### B

batteries

installing 55

type 55

Blank Screen 37

brightness, adjusting 36

buttons on keypad

Keystone 33

Menu/select 32

Power 33

Source 32

Standby 34

Volume 34

### C

cable box 11, 13

cables

audio 13, 16, 17, 20, 21, 25

computer cable 2, 25

included with projector 2, 12, 64

ordering 64

power 64

camcorder, connecting 23

ceiling projection 48

centering the image 30, 45

cleaning the lamp filter screens 54

cleaning the projection lens 51

color gain, adjusting 46

Color Management menu options

Auto color gain 46

Color Space Standard 46

Degamma 46

Color Space Standard 46

colors

adjusting 37

not displayed 59

compatibility

IBM-compatible 1

Macintosh 1

video devices 1

computers

compatible 1

connecting 25

- connecting
  - audio cable 13, 16, 17, 20, 21, 25
  - camcorder 23
  - computers 25
  - DVD or VHS tape players 17
  - power cord 14, 18, 22, 26
  - television tuner 13
  - video device 11
  - video game 23
- connectors on module 9, 12
- contents of the box 2, 64
- contrast, adjusting 36
- Control menu options
  - Auto source 47
  - Default Source 47
  - Standby Time 47
- D**
  - Default Source 47
  - Degamma 46
  - Display menu options
    - Blank screen 37
    - Brightness 36
    - Color 37
    - Contrast 36
    - Keystone 36
    - Screen Aspect 37
    - Sharpness 37
    - Tint 37
  - Display Messages 48
  - Display Startup Screen 48
  - displaying on-screen menus 32
  - distance to the screen 66
  - Dual Mode DMD 1
  - DVDs, playing 17
- E**
  - elevator button/foot 30
  - Enhanced Connectivity Module
    - attaching to the projector 10
    - connectors 9, 65
  - Enhanced Widescreen 41
- F**
  - focusing the image 29
  - forward/back buttons 33
  - fuzzy lines 45
- H**
  - HDTV 1, 21, 37
  - height adjustment 30
  - Horizontal Position 45
- I**
  - IBM-compatible computers 1
  - image
    - adjusting 26, 29
    - centering 45
    - focusing 29
    - fuzzy lines 45
    - offset 8
    - resolution 1
    - reversed 48
    - size 7, 66
    - squaring 33
    - zooming 29
  - Image menu options
    - Auto Image 45
    - Horizontal/Vertical Position 45
    - Manual Sync 45
    - Manual Tracking 45
    - Overscan 43
    - Resize 39, 44
    - Video Standard 43
    - Zoom 43, 44
  - image offset 8
- K**
  - keypad 32
  - keystone 33

---

## **L**

- lamp
  - cleaning filter screens 54
  - ordering 64, 65
  - replacing 51
- lamp hour counter 50, 51, 53
- Language menu 49
- language, selecting for menus 49
- laptop computers
  - compatibility 25
  - connecting 25
- LED 32, 34, 56
- LED behavior 56
- lens
  - cap 64
  - cleaning 51
- letterbox 41

## **M**

- Macintosh computers
  - compatibility 1
- maintenance 51
- Manual Synch 45
- Manual Tracking 45
- menus. See on-screen menus
- mute 38

## **N**

- Native resize option 42
- NTSC video 43

## **O**

- on-screen menus
  - changing language of 49
  - displaying 35
- overscan 43

## **P**

- PAL video 43
- playing a video game 23
- Power button 14, 18, 22, 26, 33
- power cord
  - connecting 14, 18, 22, 26
  - ordering 64
- power up sequence 28, 60
- PowerPoint slides, advancing with the remote 33
- project from behind the screen 48
- project from the ceiling 48
- projection distance 7, 66
- projector
  - accessories 65
  - connecting video devices 11
  - positioning 7
  - project from behind the screen 48
  - returning for repair 5
  - setting up 7
  - specifications 63
  - troubleshooting problems 56
  - turning off 24, 28
  - turning on 26

## **R**

- rear projection 48
- registering your projector 2
- remote control
  - advancing PowerPoint slides with 33
  - replacing the batteries 55
  - using 31, 32
- replacing projection lamp module 51
- re-positioning the image on the screen 45
- resetting adjustments 49
- resetting the lamp hour counter 53
- Resize options 41
- resizing the image 39, 44
- resolution 1
- returning your projector for repair 5
- RS-232 control 10

## **S**

- safety guidelines iii
- Screen Aspect 11, 37
- SECAM video 43
- sharpness 37
- Source button 32
- specifications 63
- squaring the image 33
- Standard resize option 42
- standby 24, 28, 34
- standby time 47
- Status menu 50

## **T**

- Technical Support
  - in Europe 4
  - in USA 4
  - information to have on hand
    - before you call 62
- temperature limits 63
- tint, adjusting 37
- troubleshooting 56
- turning off the projector 24, 28
- turning on the projector 26
- TV tuner 11
- TV, watching 13

## **V**

- vertical lines displayed 45
- Vertical Position 45
- VHS tapes, playing 17
- video game, connecting 23
- video players/VCRs 17
- video standards 43
- Volume buttons 34
- volume, adjusting 34, 38

## **W**

- warranty 5
- watching a DVD or VHS tape 17
- watching HDTV 21
- watching regular TV 13
- Widescreen letterbox 41

## **Z**

- Zoom mode 34
- zooming the image 29, 34, 43, 44



## **Limited Warranty**

BOXLIGHT ("BOXLIGHT") warrants that the Cinema 12SF Projector ("Product") purchased from BOXLIGHT, Studio Experience, a BOXLIGHT distributor, or a BOXLIGHT reseller will conform to the manufacturer's specifications and be free from defects in material or workmanship for the Warranty period provided below. BOXLIGHT does not warrant that the Product will meet the specific requirements of the end-user customer.

If the Product, which is the subject of this Limited Warranty, is defective in material or workmanship during the warranty period, BOXLIGHT, at its option, will REPAIR or REPLACE the Product.

All exchanged parts and products replaced under this Warranty will become property of BOXLIGHT. BOXLIGHT's sole obligation is to supply (or pay for) all labor necessary to repair the Product found to be defective within the Warranty period and to repair or replace defective parts with new parts or, at the option of BOXLIGHT, serviceable used parts that are equivalent or superior to new parts performance.

**Limited Warranty Alternatives:** Subject to the Limitations, Exclusions and Disclaimers, BOXLIGHT Warrants as follows:

- **3 Year Parts and Labor Product Warranty** - From the date of purchase, BOXLIGHT warrants that the Product will conform to the manufacturers' specifications and be free from defects in material or workmanship for a period of three (3) years.
- **1 Year Parts Only Accessory Warranty** - From the date of purchase, BOXLIGHT warrants that the customer replaceable and accessory products will conform to the manufacturers' specifications and be free from defects in material or workmanship for a period of one (1) year.

**120 Day Replacement Lamp Warranty** - BOXLIGHT warrants the Lamp Product purchased in the projector, and Lamp Products purchased separately as replacements after the initial Projector purchase, for 120 days. During the Warranty period for the Product, BOXLIGHT warrants that Replacement lamps, which are purchased at the time of projector purchase, will have a 120-day warranty from the date the spare lamp is put into use.

## **WARRANTY LIMITATION AND EXCLUSION**

THIS WARRANTY SETS FORTH BOXLIGHT'S MAXIMUM LIABILITY FOR ITS PRODUCT. THIS WARRANTY EXTENDS ONLY TO PRODUCTS PURCHASED FROM BOXLIGHT OR A BOXLIGHT AUTHORIZED RESELLER. BOXLIGHT shall have no further obligation under the foregoing Limited Warranty if the Product has been damaged due to abuse, misuse, neglect, smoke exposure (cigarette or otherwise), accident, unusual physical or electrical stress, unauthorized modifications (including use of an unauthorized mount), tampering, alterations, or service other than by BOXLIGHT or its authorized agents, causes other than from ordinary use or failure to properly use the Product in the application for which said Product was intended.

This Warranty excludes Product or accessory cleaning, repair, or replacement of plastics due to cosmetic damage and damage as a result of normal wear. Product repair outside of the terms of the Limited Warranty will be on a time and materials basis. Prolonged Product "demonstration" causes unusual Product wear and is not considered normal use under the terms of this Limited Warranty.

The Accessory Warranty covers the accessory item only and excludes normal wear. The Lamp Product Warranty excludes expected lamp degradation.

Remanufactured Products and Software Products are exempt from the foregoing Limited Warranty. Please refer to the appropriate Remanufactured Product Limited Warranty or Software Product Limited Warranty for applicable Warranty information.

## **DISCLAIMER OF UNSTATED WARRANTIES**

THE WARRANTY PRINTED ABOVE IS THE ONLY WARRANTY APPLICABLE TO THIS PRODUCT. ALL OTHER WARRANTIES, EXPRESS OR IMPLIED, INCLUDING, BUT NOT LIMITED TO, THE IMPLIED WARRANTIES OF MERCHANTABILITY AND FITNESS FOR PARTICULAR PURPOSE ARE DISCLAIMED. THERE ARE NO WARRANTIES THAT EXTEND BEYOND THE DESCRIPTION ON THE FACE HEREOF AND THE FOREGOING WARRANTY SHALL NOT BE EXTENDED, ALTERED OR VARIED EXCEPT BY WRITTEN INSTRUMENT SIGNED BY BOXLIGHT. SOME JURISDICTIONS DO NOT ALLOW LIMITATIONS ON HOW LONG AN IMPLIED WARRANTY MAY LAST, SO

SUCH LIMITATIONS MAY NOT APPLY TO YOU.

### **Limited Warranty Period**

The Limited Warranty period commences on the date of purchase by the end-user customer for both the 3 year Product Warranty and the 1 year Accessory Warranty. These Limited Warranty provisions shall apply only to the end-user purchaser (first person or entity that purchased a new Product for personal or business use and not for the purpose of distribution or resale).

### **To Be Eligible For Limited Warranty Coverage**

Any person exercising a claim under this Limited Warranty must establish to the satisfaction of BOXLIGHT both the date of purchase and that the Product was purchased new. The sales receipt or invoice, showing the date of purchase of the Product or Accessory is the proof of the date of purchase.

### **To Obtain Warranty Service**

During the Limited Warranty period, to exercise this Limited Warranty, the purchaser must first contact 1) BOXLIGHT, 2) a service facility authorized by BOXLIGHT or 3) the place of original purchase.

For Warranty service, the purchaser will be advised to return or deliver the defective Product freight and all fees prepaid, to a BOXLIGHT Service Center or to a service facility authorized by BOXLIGHT. When returning Product to BOXLIGHT, a Return Material Authorization Number (RMA #) is required and must be clearly displayed on the outside of the shipping carton or a similar package affording an equal degree of protection. BOXLIGHT or the service facility authorized by BOXLIGHT will return the repaired/replaced Product freight prepaid to the purchaser.

Products returned for Warranty service must be accompanied by a written letter that: (i) explains the problem; (ii) provides proof of date of purchase; (iii) provides the dealer's name; and (iv) provides the model and serial number of the Product. Upon request of BOXLIGHT or an authorized repair center for BOXLIGHT, proof of legal importation must accompany the warranty repair Product, otherwise the Product must be returned to the place of original purchase, to the manufacturer (Purchaser must bear all tax, duty and freight), or the Purchaser must bear charges for the warranty repair.

No repair or replacement of Product or part thereof shall extend the Limited Warranty period as to the entire Product. Warranty on the repair part and workmanship shall only be effective for a period of ninety (90) days following the repair or replacement of that part or the remaining period of the Product Limited Warranty whichever is greater.

## **LIMITATION OF LIABILITY**

IT IS UNDERSTOOD AND AGREED THAT BOXLIGHT'S LIABILITY WHETHER IN CONTRACT, IN TORT, UNDER ANY WARRANTY, IN NEGLIGENCE OR OTHERWISE SHALL NOT EXCEED THE RETURN OF THE AMOUNT OF THE PURCHASE PRICE PAID BY PURCHASER AND UNDER NO CIRCUMSTANCES SHALL BOXLIGHT BE LIABLE FOR SPECIAL, INDIRECT, INCIDENTAL OR CONSEQUENTIAL DAMAGES OR LOST PROFITS, LOST REVENUES OR LOST SAVINGS. THE PRICE STATED FOR THE PRODUCTS IS A CONSIDERATION IN LIMITING BOXLIGHT'S LIABILITY.

**Limitation on Bringing Action** - No action, regardless of form, arising out of the agreement to purchase the product may be brought by purchaser more than one year after the cause of action has accrued.

**Governing Law** - Any action, regardless of form, arising out of the agreement to purchase the product is governed by Washington State law.

**Mandatory Arbitration** - Any action, regardless of form, arising out of the agreement to purchase the product is subject to mandatory arbitration.

SOME JURISDICTIONS DO NOT ALLOW THE EXCLUSION OR LIMITATION OF INCIDENTAL OR CONSEQUENTIAL DAMAGES SO THE ABOVE LIMITATION OR EXCLUSION MAY NOT APPLY TO YOU. THIS LIMITED WARRANTY GIVES YOU SPECIFIC LEGAL RIGHTS, AND YOU MAY ALSO HAVE OTHER RIGHTS, DEPENDING ON JURISDICTION.

# Cinema 12SF

 **BOXLIGHT®**  
Presenting a Better Way



Boxlight  
19332 Powder Hill Place  
Poulsbo, WA 98370-7407 USA  
[www.boxlight.com](http://www.boxlight.com)  
U.S.A. and Canada 800-762-5757  
International 360-779-7901



010-0315-00



Printed on  
recycled  
paper.

## Free Manuals Download Website

<http://myh66.com>

<http://usermanuals.us>

<http://www.somanuals.com>

<http://www.4manuals.cc>

<http://www.manual-lib.com>

<http://www.404manual.com>

<http://www.luxmanual.com>

<http://aubethermostatmanual.com>

Golf course search by state

<http://golfingnear.com>

Email search by domain

<http://emailbydomain.com>

Auto manuals search

<http://auto.somanuals.com>

TV manuals search

<http://tv.somanuals.com>