

## Multimedia LCD Projector

# CP-635i

## USER'S MANUAL

Please read this user's manual thoroughly to ensure correct usage through understanding.

## BEDIENUNGSANLEITUNG

Bitte lesen Sie diese Bedienungsanleitung zugunsten der korrekten Bedienung aufmerksam.

## MANUEL D'UTILISATION

Nous vous recommandons de lire attentivement ce manuel pour bien assimiler le fonctionnement de l'appareil.

## MANUALE D'ISTRUZIONI

Vi preghiamo voler leggere attentamente il manuale d'istruzioni in modo tale da poter comprendere quanto riportato ai fini di un corretto utilizzo del proiettore.

## MANUAL DE USUARIO

Lea cuidadosamente este manual del usuario para poder utilizar correctamente el producto.

## GEBRUIKSAANWIJZING

Lees voor het gebruik alstublieft deze handleiding aandachtig door, om volledig profijt te hebben van de uitgebreide mogelijkheden.

## BRUKERHÅNDBOK

Vennligst les denne bruksanvisningen grundig for å være garantert driftssikker bruk.

## INSTRUÇÕES DO PROPRIETÁRIO

Para assegurar o uso correto do equipamento, por favor leia atentamente este manual do usuário.

## TECHNICAL

## REGULATORY NOTICES

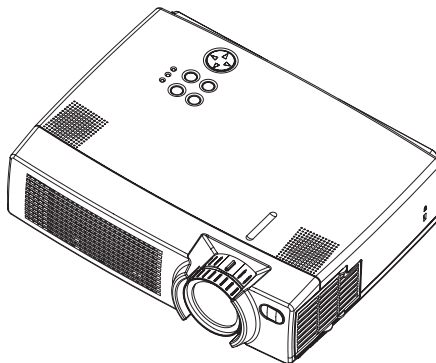

ENGLISH

DEUTSCH

FRANÇAIS

ITALIANO

ESPAÑOL

NEDERLANDS

NORSK

PORTUGÊS

TECHNICAL

# USER'S MANUAL

Thank you for purchasing this LCD projector.

**WARNING** • Please read the accompanying manual “SAFETY INSTRUCTIONS” and this “USER'S MANUAL” thoroughly to ensure correct usage through understanding. After reading, store this instruction manual in a safe place for future reference.

- NOTE** • The information in this manual is subject to change without notice.
- The manufacturer assumes no responsibility for any errors that may appear in this manual
  - The reproduction, transmission or use of this document or contents is not permitted without express written authority.

**TRADEMARK ACKNOWLEDGMENT** : PS/2, VGA and XGA are registered trademarks of International Business Machines Corporation. Apple, Mac and ADB are registered trademarks of Apple Computer, Inc. VESA and SVGA are trademarks of the Video Electronics Standard Association. Windows is a registered trademark of Microsoft Corporation. Carefully observe the trademarks and registered trademarks of all companies, even when not mentioned.

## CONTENTS

	Page		Page
<b>FEATURES</b> .....	2	<b>TROUBLESHOOTING</b> .....	20
<b>BEFORE USE</b> .....	2	OSD Message .....	20
Contents of Package .....	2	Indicators Message .....	21
Part Names.....	3	Symptom .....	22
Loading the Battery .....	5	<b>SPECIFICATIONS</b> .....	<b>23</b>
Fixing the Handle.....	5	<b>WARRANTY</b> .....	<b>24</b>
<b>INSTALLATION</b> .....	<b>6</b>	.....	
Installation of the Projector and Screen.....	6	<b>TABLES</b>	
Angle Adjustment .....	6	Table 1. Installation Reference.....	6
Cabling .....	7	Table 2. Cabling .....	7
Power Connection .....	7	Table 3. Basic Operation .....	10
Example of System Setup .....	8	Table 4. Setup Menu .....	12
Plug & Play .....	8	Table 5. Input Menu.....	13
<b>OPERATIONS</b> .....	<b>9</b>	Table 6. Image Menu.....	14
Power ON .....	9	Table 7. Options Menu .....	15
Power OFF .....	9	Table 8. No Signal Menu .....	16
Basic Operation .....	10	Table 9. OSD Message .....	20
Setup Menu .....	12	Table 10. Indicators Message .....	21
Input Menu.....	13	Table 11. Symptom .....	22
Image Menu.....	14	Table 12. Specifications .....	23
Options Menu .....	15	.....	
No Signal Menu .....	16	For "TECHNICAL" and "REGULATORY	
<b>MAINTENANCE</b> .....	<b>17</b>	NOTICE", see the end of this manual.	
Lamp.....	17		
Air Filter .....	19		
Other Maintenance .....	19		

# FEATURES

This liquid crystal projector is used to project various computer signals as well as NTSC / PAL / SECAM video signals onto a screen. Little space is required for installation and large images can easily be realized.

## Outstanding Brightness

The UHB lamp and high-efficiency optical system assure a high level of brightness.

## Partial Magnification Function

Interesting parts of images can be magnified for closer viewing.

## Distortion Correction Function

Distortion-free images are quickly available.

## Extra-low Noise Function

Acoustic noise level from the unit can be reduced.

# BEFORE USE

## Contents of Package

Make sure all of the following items are included in the package. If anything is missing, please contact BOXLIGHT at 800-762-5757 or 360-779-7901.

**NOTE** • Keep the original packing material for future reshipment.

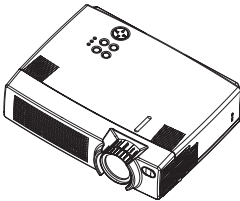

**Projector**



**Power Cord  
(US Type)**



**Power Cord  
(Europe Type)**

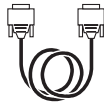

**RGB Cable**



**Component  
Video Cable  
(with green lead)**



**Mouse cable  
(PS/2)**



**User's Manual  
(this manual)**

**Safety Instructions**



**Handle**



**Carrying Bag**

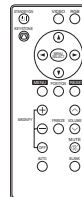

**Remote Controller  
containing Battery**

# BEFORE USE (continued)

## Part Names

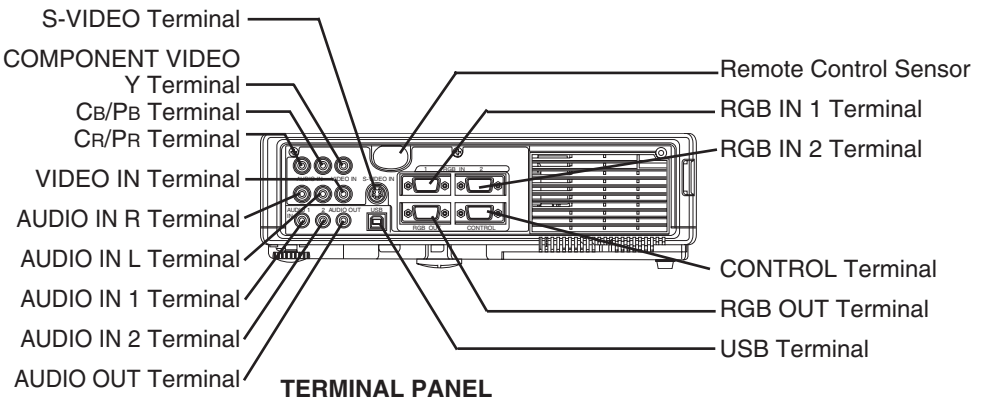
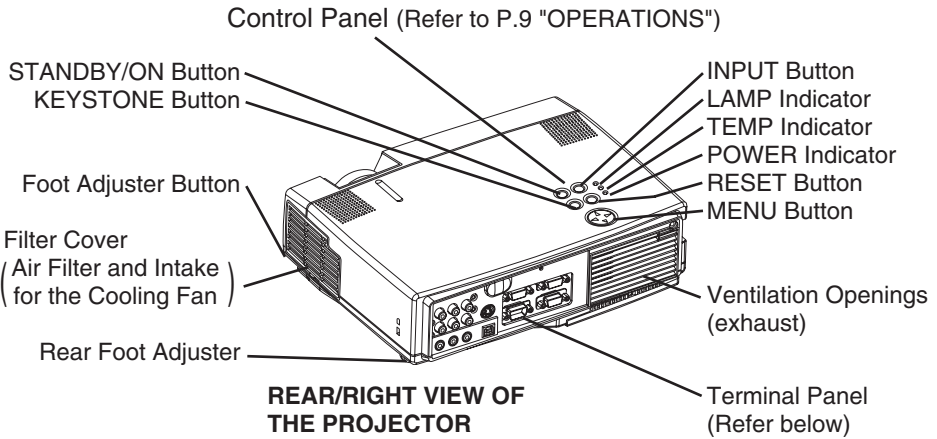
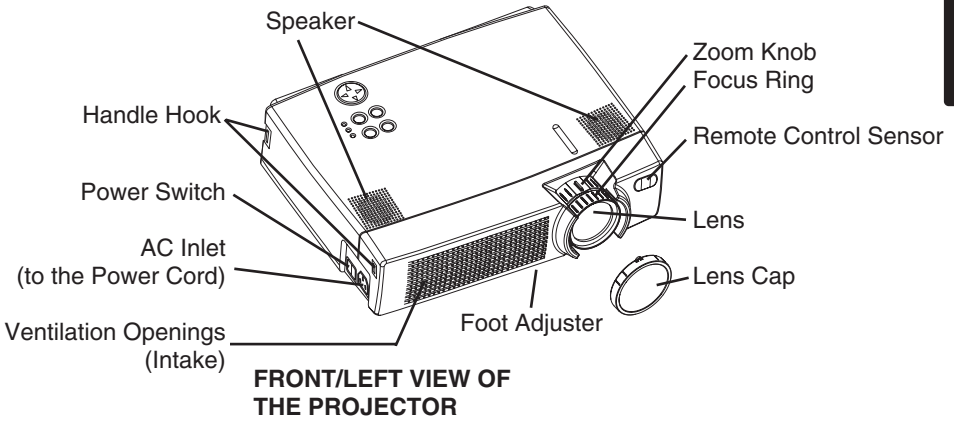

# BEFORE USE (continued)

## Part Names (continued)

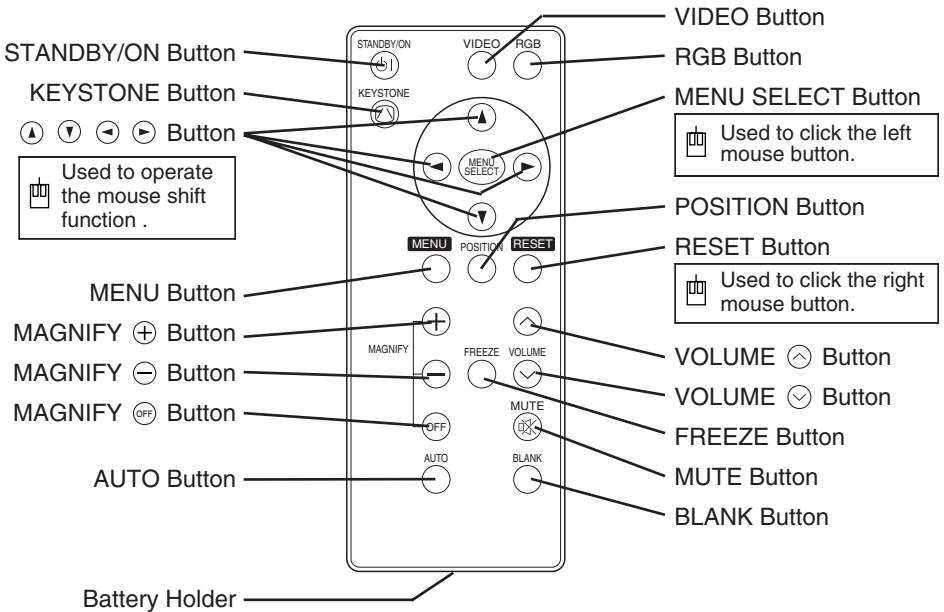

**REMOTE CONTROLLER**  
(Refer to P.9 "OPERATIONS")

 These functions work when the mouse control function is activated. Remember, the POSITION, VOLUME, KEystone, BLANK ON and MENU ON functions disable the mouse control function.

**NOTE** • Keep the remote controller away from children and pets.

- Do not give the remote controller any physical impact. Take care not to drop.
- Do not place the heavy objects on the remote controller.
- Do not wet the remote controller or place it on any wet object.
- Do not place the remote controller close to the cooling fan of the projector.
- Do not disassemble the remote controller.

# BEFORE USE (continued)

## Loading the Battery

### First Loading:

In original packing, the battery is installed in the battery holder of the remote controller with protection film (the transparent film some of which is inside the battery holder). Pull out the protection film to load the battery.

### Replacing:

1. See the reverse side of the remote controller.
2. Pinch the groove and pull out battery holder as the drawing right.
3. Remove the worn battery.
4. Install the new battery with "+" side facing.
5. Push in and click the battery holder.

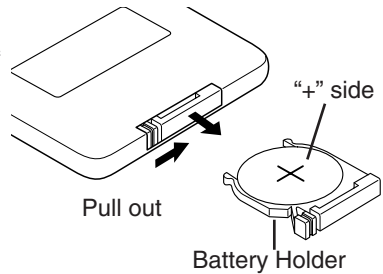

**CAUTION** • Incorrect handling of the battery could result in fire or personal injury. The battery may explode if not handled properly. Be careful in handling the battery according to instructions of accompanying manual "SAFETY INSTRUCTIONS" and this manual.

- Use the 3V micro lithium battery type no.CR2025 only.
- When loading the battery, make sure the plus and minus terminals are correctly oriented as indicated in the remote controller.
- When you dispose the battery, you should obey the law in the relative area or country.
- Keep the battery away from children and pets.
- When not to be used for an extended period, remove the battery from the remote controller.

### NOTE

Replace the batteries when remote control transmitter operation becomes difficult.

## Fixing the Handle

Fix the enclosed handle if you need.

1. Raise up the handle hook, and pass one end of the handle through the hole of handle hook.
2. Buckle the end of the handle, as the right drawing.
3. Fix the other end of the handle to the other handle hook in the same way.

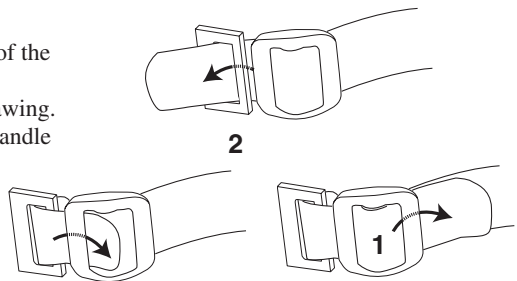

**CAUTION** • Make sure the handle is fixed before carrying the projector with the handle. If the projector should be dropped from the handle should be off, it could result in an injury, and continued use could result in fire or electrical shock. Do not flourish the projector with the handle.

# INSTALLATION

## Installation of the Projector and Screen

Refer to the drawing and table below for determining the screen size and projection distance.

The projection distances shown in the table below are for full size (800 x 600 dots).

a: Distance from the projector to the screen. ( $\pm 10\%$ )

**Table 1. Installation Reference**

Screen size [inches (m)]	a [inches (m)]	
	Min.	Max.
40 (1.0)	62 (1.6)	82 (2.1)
60 (1.5)	94 (2.4)	123 (3.1)
80 (2.0)	127 (3.2)	164 (4.2)
100 (2.5)	160 (4.1)	205 (5.2)
120 (3.0)	192 (4.9)	246 (6.3)
150 (3.8)	241 (6.1)	308 (7.8)
200 (5.0)	323 (8.2)	411 (10.4)

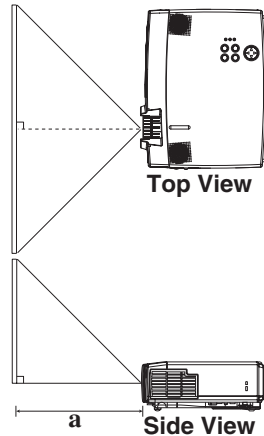

**CAUTION** • Install the projector in a suitable environment according to instructions of the accompanying manual “SAFETY INSTRUCTIONS” and this manual.

• When you fix this unit with a metal tool and the like, you must connect it with ground wire; otherwise, fire or electric shock can result.

Connect the ground terminal of AC inlet of this unit with the ground terminal provided at the building using an optional three-core power-supply cord.

• Please basically use liquid crystal projector at the horizontal position. If you use liquid crystal projector by the lens up position, the lens down position and the side up position, this may cause the heat inside to build up and cause damage. Be especially careful not to install it with ventilation holes blocked.

• Do not install LCD projector in smoke effected environment. Smoke residue may buildup on critical parts (i.e.LCD panel, Lens Assy etc.).

## Angle Adjustment

Use the foot adjusters on the bottom of the projector to adjust the projection angle. It is variable within  $0^\circ$  to  $9^\circ$  approximately.

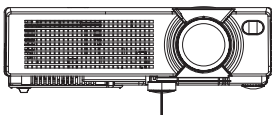

Foot Adjuster

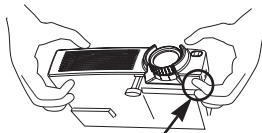

Press the foot adjuster button

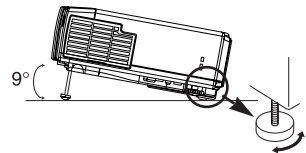

Rear Foot Adjuster

1. Lift up the front side of the projector, and pressing the foot adjuster button, adjust the projection angle.
2. Release the button to lock at the desired angle.
3. Use the rear foot adjuster to adjust the left-right slope. Do not force the foot adjuster screw. This could damage the adjuster or cause the lock to fail.



**CAUTION** • Do not release the foot adjuster button unless the projector is being held; otherwise, the projector could overturn or fingers could get caught and cause personal injury.

# INSTALLATION (continued)

## Cabling

Refer to the table below for connecting each terminal of the projector to a device.

**Table 2. Cabling**

Function	Terminal	Cable
RGB input	RGB IN 1	RGB cable with D-sub 15-pin shrink jack and inch thread screws
	RGB IN 2	
RGB output	RGB OUT	
Audio input (from the computer)	AUDIO IN 1 (interlocked with RGB IN 1)	Audio cable with stereo mini jack
	AUDIO IN 2 (interlocked with RGB IN 2)	
PS/2 mouse control	CONTROL	PS/2 mouse cable
ADB mouse control		ADB mouse cable
Serial mouse control		Serial mouse cable
RS-232C communication		RS-232C cable
USB mouse control	USB	USB cable
S-video input	S-VIDEO IN	S-video cable with mini DIN 4-pin jack
Video input	VIDEO IN	Video/Audio cable
Component video input	COMPONENT VIDEO Y	Component video cable
	COMPONENT VIDEO Cb/PB	
	COMPONENT VIDEO Cr/PR	
Audio input (from video equipment)	AUDIO IN L	Video/Audio cable or optional audio cable with RCA jack
	AUDIO IN R	
Audio output	AUDIO OUT	Audio cable with stereo mini jack



**CAUTION** • Incorrect connecting could result in fire or electrical shock.

Please read this manual and the separate “SAFETY INSTRUCTIONS”.

- Before connecting, turn off to all devices to be connected, except for the USB cable.
- The cables may have to be used with the core set to the projector side. Use the cables which are included with the projector or specified.

**NOTE** • Before connecting, read instruction manuals of the devices to be connected, and make sure that the projector is compatible with the device.

- Secure the screws on the connectors and tighten.
- For some RGB input modes, the optional Mac adapter is necessary.
- Some computers may have multiple display screen modes. Use of some of these modes will not be possible with this projector.
- Refer to the “TECHNICAL” section for the pin assignment of connectors and RS-232C communication data.



# INSTALLATION (continued)

## Power Connection

Use the correct power cord depending on the power outlet to be used.

Connect the AC inlet of the projector to the power outlet firmly by the power cord.



**CAUTION** • Be careful in handling the power cord according to instructions of the accompanying manual "SAFETY INSTRUCTIONS" and this manual.

- Connect the power cord firmly. Avoid using a loose, unsound outlet failed or contact.

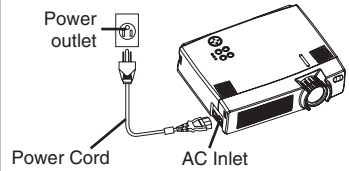

## Example of System Setup

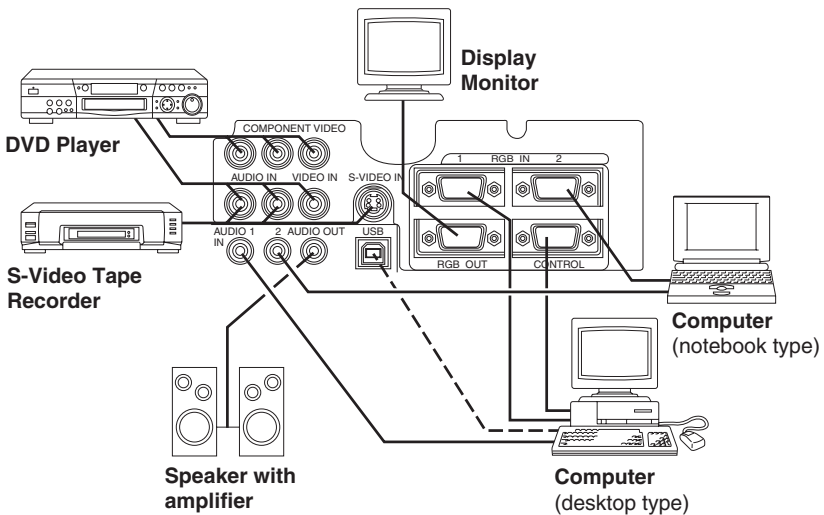

**NOTE** • When connecting with a notebook computer, set the proper RGB external image output (setting CRT display or simultaneous display of LCD and CRT). Please read instruction manual of the notebook for more information.

## Plug & Play

This projector is VESA DDC 1/2B compatible. Plug & play is possible by connecting to a computer that is VESA DDC (Display Data Channel) compatible.

Please use this function by connecting the accessory RGB cable with RGB IN 1 terminal (DDC 1/2B compatible). Plug & play may not operate by other connections.

**NOTE** • Plug & play is a system configured with peripheral equipment including a computer, display and an operating system.

- This projector is recognized as a plug & play monitor. Use the standard display drivers.
- Plug & play may not operate by the computer to connect. Use the RGB IN 2 terminal if plug & play does not operate correctly.

# OPERATIONS

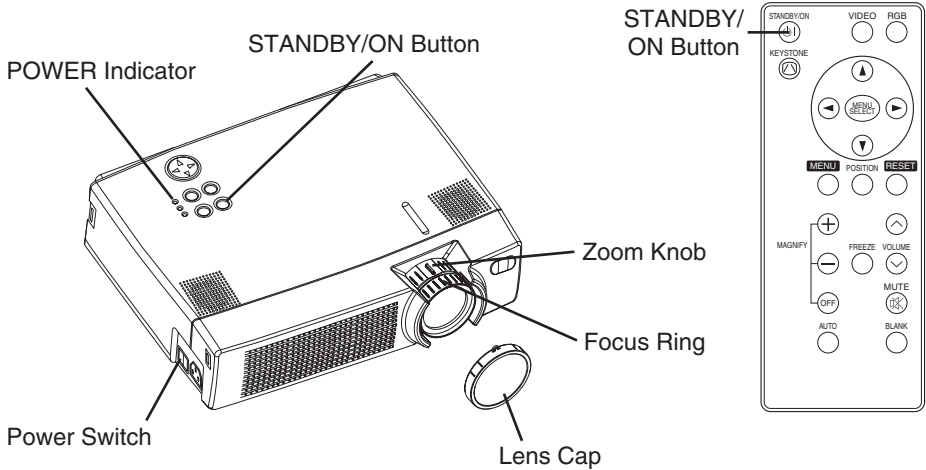

## Power ON

1. Check that the power cord is connected correctly.
2. Set the power switch to [ | ]. The standby mode is selected, and the POWER indicator is turned to orange.
3. Press the STANDBY/ON button (Ⓜ) on the control panel or the remote control transmitter. Warm-up begins and the POWER indicator blinks in green.
4. The POWER indicator ceases blinking and turns to green when power is on. Remove the lens cap.
5. Adjust picture size using the zoom knob.
6. Adjust focus using the focus ring .

## Power OFF

1. Press the STANDBY/ON button (Ⓜ) on the control panel or the remote controller. Then, the message "Power off?" will appear on the screen, and the message will disappear by any operation or no operation for 5 seconds. During this message indication, press the STANDBY/ON (Ⓜ) button again. The projector lamp is extinguished and lamp cooling begins. The POWER indicator blinks orange during lamp cooling. Pressing the STANDBY/ON button (Ⓜ) has no effect while the POWER indicator is blinking.
2. The system assumes the Standby mode when cooling is complete, and the POWER indicator ceases blinking and changes to orange. Check that the indicator is orange and set the power switch to [ O ].
3. The POWER indicator is extinguished when power is off. Do not forget to replace the lens cap.

**WARNING** • Please read this manual, and the separate "SAFETY INSTRUCTIONS" thoroughly before using the equipment. Always ensure that the equipment is used safely.

- NOTE** • Except in emergencies, follow the above-mentioned procedure for turning power off. If the projector is used improperly, it may very difficult to turn off the projector caused by heating inside the unit. And the reduction of life time of lamp and LCD panels will be caused by incorrect procedure.
- To prevent any trouble, turn on/off the projector when the computer or video tape recorder is OFF. Providing a RS-232C cable is connected, turn on the computer before the projector.
  - When a projector continues projecting the same image, the image may remain as an afterimage. Please do not project the image same for a long time.

# OPERATIONS (continued)

## Basic Operation

The basic operations shown in Table 3 is performed from the supplied remote control transmitter or the projector control panel. Items indicated by (\*) may be used from the control panel.

**Table 3 . Basic Operation**



Item	Description
INPUT SELECT	<p><b>Select Input Signal (*)</b> : Press the INPUT button.            RGB IN 1→RGB IN 2→ VIDEO IN → S-VIDEO IN → COMPONENT VIDEO (→ RGB IN 1)</p> <p><b>Select RGB Input</b> : Press the RGB button.            VIDEO IN / S-VIDEO IN / COMPONENT VIDEO → RGB IN 1 / RGB IN 2            RGB IN 1 → RGB IN 2 (→ RGB IN 1)</p> <p><b>Select Video Input</b> : Press the VIDEO button.            RGB IN 1 / RGB IN 2 → VIDEO IN / S-VIDEO IN / COMPONENT VIDEO            VIDEO IN → S-VIDEO IN → COMPONENT VIDEO (→ VIDEO IN)</p> <ul style="list-style-type: none"> <li>The selected signal name is displayed for approximately 3 seconds when the input signal is changed.</li> </ul>
POSITION	<p><b>Set/Clear Position Adjustment Mode</b> : Press the POSITION button. The [ ] icon is displayed in the POSITION mode.</p> <p><b>Image Position Adjustment</b>: Press the ⏪, ⏩, ⏴ and ⏵ buttons in the POSITION mode.</p> <ul style="list-style-type: none"> <li>Valid only in the MAGNIFY mode with a video signal is input.</li> <li>After approximately 10 seconds of inactivity the [ ] icon is extinguished and the POSITION mode is cleared automatically.</li> <li>⏪, ⏩, ⏴ and ⏵ buttons may operate as the mouse control button. Refer to page 4.</li> </ul>
RESET (*)	<p><b>Initialize Each Item</b> : Select an item and press the RESET button.</p> <p><b>Initialize Position Adjustment</b> : Press the RESET button and the POSITION mode. This function is valid only when RGB signal is input.</p> <ul style="list-style-type: none"> <li>Valid except for the VOLUME, LANGUAGE and H PHASE.</li> <li>The RESET button may operate as the mouse control button. Refer to page 4.</li> </ul>
MAGNIFY	<p><b>Set MAGNIFY Mode</b> : Press the MAGNIFY ⊕ button.</p> <p><b>Move Magnified Area</b> : Run the POSITION in the MAGNIFY mode.</p> <p><b>Adjust Magnification</b> : Press the MAGNIFY ⊕ / ⊖ button in MAGNIFY mode.</p> <p><b>Clear MAGNIFY Mode</b> : Press the MAGNIFY ⊗ button.</p> <ul style="list-style-type: none"> <li>The MAGNIFY mode is cleared by running or setting the AUTO, ASPECT, INPUT SELECT or VIDEO, or by changing the input signal.</li> </ul>
FREEZE	<p><b>Set/Clear FREEZE Mode</b> : Press the FREEZE button. The [ ] icon is displayed, and the image is frozen, in the FREEZE mode.</p> <ul style="list-style-type: none"> <li>The FREEZE mode is cleared by running or setting POSITION, VOLUME, MUTE, Automatic Adjustment, BLANK ON/OFF, or MENU ON/OFF, or by changing the input signal.</li> <li>Do not forget to clear frozen static images.</li> </ul>

**NOTE** • Strong light and obstacles will interfere with operation of the remote control transmitter.

# OPERATIONS (continued)

Items indicated by (\*) may be used from the control panel.

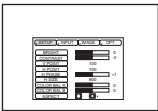
**Table 3. Basic Operation (continued)**

Item	Description
VOLUME	<b>Volume Adjustment :</b> Press the VOLUME ☺ / ☹ button.
MUTE	<b>Set/Clear Mute Mode :</b> Press the MUTE button. No sound is heard in the MUTE mode.
AUTO	<p><b>Automatic Adjustment at RGB Input :</b> Press the AUTO button. Horizontal position(H.POSIT), vertical position (V.POSIT),clock phase (H.PHASE), and horizontal size(H.SIZE) are automatically adjusted. Use with the window at maximum size in the application display.</p> <p><b>Automatic Adjustment at Video Input :</b> Press the AUTO button. A signal type appropriate for the input signal is selected automatically. Valid only when AUTO is set for VIDEO on the menu.</p> <ul style="list-style-type: none"> <li>• This operation requires approximately 10 seconds. It may not function correctly with some input signals.</li> </ul>
BLANK ON/OFF	<b>Set/Clear Blank Mode:</b> Press the BLANK button. No image is displayed in the Blank mode. The screen color is as set in BLANK on the Image menu.
MENU ON/OFF (*)	<p><b>Menu Display Start/Stop:</b> Press the MENU button.</p> <ul style="list-style-type: none"> <li>• The menu display is terminated automatically after approximately 10 seconds of inactivity.</li> </ul>
MENU SELECT	<p><b>Select Menu Type:</b> Press the MENU SELECT button. Allows the user to select the normal menu or the single menu. Only the selected item is displayed on the single menu, and other items are displayed with the ⬆ and ⬇ buttons as with the normal menu.</p> <ul style="list-style-type: none"> <li>• Valid only when the Setup menu is used. Push the MENU SELECT button after selecting items such as "BRIGHTNESS".</li> <li>• The MENU SELECT button may operate as the mouse control button. Refer to page 4.</li> </ul> <div style="display: flex; justify-content: space-around; align-items: center;"> <div style="text-align: center;"> <p><b>Normal menu</b></p>  </div> <div style="text-align: center;"> <p>(MENU SELECT)</p>  </div> <div style="text-align: center;"> <p><b>Single menu</b></p>  </div> </div>
KEYSTONE (*)	<p><b>Set / Clear KEYSTONE Mode :</b> Press the KEYSTONE ☉ button.</p> <p><b>Adjust KEYSTONE :</b> Press the ☺ / ☹ button.</p> <ul style="list-style-type: none"> <li>• The image may not be appeared properly when this function is activated on same input signals.</li> <li>• The adjustable range of distortion correction will be different among input signals.</li> </ul>

# OPERATIONS (continued)

## Setup Menu

The following adjustments and settings are possible when SETUP is selected at the top of the menu. Part of the Setup menu differs between RGB input and video input. Select an item with the  $\odot$  and  $\oplus$  buttons, and start operation. Use the Single menu to reduce menu size (see Table 3, MENU SELECT).

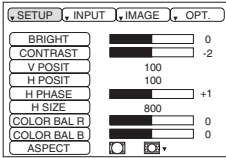

RGB

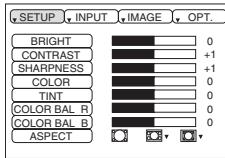

VIDEO/S-VIDEO

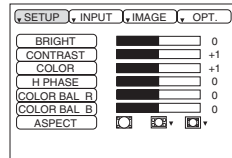

COMPONENT

Table 4. Setup Menu

Item	Description	RGB	VIDEO S-VIDEO	COMPONENT	
				480i 575i 480P	720P 1080i
BRIGHT	Dark $\ominus$ $\leftrightarrow$ $\oplus$ Light	✓	✓	✓	✓
CONTRAST	Weak $\ominus$ $\leftrightarrow$ $\oplus$ Strong	✓	✓	✓	✓
V POSIT	Down $\ominus$ $\leftrightarrow$ $\oplus$ Up	✓	-	-	-
H POSIT	Left $\ominus$ $\leftrightarrow$ $\oplus$ Right	✓	-	-	-
H PHASE	Left $\ominus$ $\leftrightarrow$ $\oplus$ Right • Adjust to eliminate flicker.	✓	-	✓	✓
H SIZE	Small $\ominus$ $\leftrightarrow$ $\oplus$ Large • The image may not be displayed correctly if the horizontal size is excessive. In such cases, press the RESET button, and initialize the horizontal size.	✓	-	-	-
SHARPNESS	Soft $\ominus$ $\leftrightarrow$ $\oplus$ Clear	-	✓	-	-
COLOR	Light $\ominus$ $\leftrightarrow$ $\oplus$ Dark	-	✓	✓	✓
TINT	Red $\ominus$ $\leftrightarrow$ $\oplus$ Green • Valid only when NTSC or NTSC 4.43 signal is received.	-	✓	-	-
COLOR BAL R	Light $\ominus$ $\leftrightarrow$ $\oplus$ Dark	✓	✓	✓	✓
COLOR BAL B	Light $\ominus$ $\leftrightarrow$ $\oplus$ Dark	✓	✓	✓	✓
ASPECT	<b>Select Image Aspect Ratio :</b> 4:3[  ] $\ominus$ $\leftrightarrow$ $\oplus$ 16:9[  ] <b>Select Position of Image:</b> Press the $\oplus$ button while 16:9[  ] is selected. Center $\rightarrow$ $\oplus$ Down $\rightarrow$ $\oplus$ Up ( $\rightarrow$ Center $\oplus$ )	✓	-	-	✓
	<b>Select Image Aspect Ratio:</b> 4:3[  ] $\ominus$ $\leftrightarrow$ $\oplus$ 16:9[  ] $\ominus$ $\leftrightarrow$ $\oplus$ 4:3small[  ] <b>Select Position of Image :</b> Press the $\oplus$ button while 16:9[  ] / 4:3 small[  ] is selected. Center $\rightarrow$ $\oplus$ Down $\rightarrow$ $\oplus$ Up ( $\rightarrow$ Center $\oplus$ ) • 4:3 small may not be displayed correctly with some input signals.	-	✓	✓	-

# OPERATIONS (continued)

## Input Menu

The following functions are available when INPUT is selected on the menu. Select an item with the  $\uparrow$  and  $\downarrow$  buttons, and start or stop operation with the  $\odot$  and  $\ominus$  buttons. The function indicated (\*\*) are effective on video input mode only, not on RGB input mode.

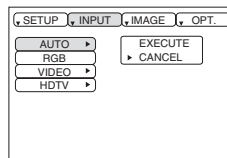

Table 5. Input Menu

Item	Description
AUTO	<p><b>Automatic Adjustment at RGB Input:</b> Select the EXECUTE with the <math>\odot</math> button. Horizontal position (H.POSIT), vertical position (V.POSIT), clock phase (H.PHASE), and horizontal size (H.SIZE) are automatically adjusted. Use with the window at maximum size in the application display.</p> <p><b>Automatic Adjustment at Video Input:</b> Select the EXECUTE with the <math>\odot</math> button. A signal type appropriate for the input signal is selected automatically. Valid only when AUTO is set for VIDEO on the menu.</p> <ul style="list-style-type: none"> <li>• This operation requires approximately 10 seconds. It may not function correctly with some input signals. Pressing the AUTO button in this case may correct this problem.</li> <li>• This function is the same as for the AUTO function in Basic operation.</li> </ul>
RGB	<p><b>Displays RGB Input Frequency:</b> Displays the horizontal and vertical sync signal frequencies for RGB input.</p> <ul style="list-style-type: none"> <li>• Valid only at RGB input.</li> </ul>
VIDEO (**)	<p><b>Select Video Signal Type:</b> Select the signal type with the <math>\uparrow</math> and <math>\downarrow</math> buttons. Select NTSC, PAL, SECAM, NTSC4.43, M-PAL, or N-PAL as appropriate for the input signal. The selection of AUTO enables and executes the function AUTO (Automatic Adjustment at Video Input), except for the N-PAL input.</p> <ul style="list-style-type: none"> <li>• Use this function when the image becomes unstable (eg. the image becomes irregular, or lacks color) at VIDEO/S-VIDEO input.</li> <li>• Automatic Adjustment requires approximately 10 seconds. It may not function correctly with some input signals. Pressing the AUTO button in this case may correct this problem except for the N-PAL input.</li> <li>• For the COMPONENT VIDEO input, this function is not effective and the signal type is distinguished automatically.</li> </ul>
HDTV	<p><b>Select HDTV mode:</b> Select the 1035i mode or 1080i mode suitable for the input signal with the <math>\uparrow</math> / <math>\downarrow</math> button.</p> <ul style="list-style-type: none"> <li>• When the selected HDTV mode is incompatible with the input signal, the image may be incorrect (eg. the display position or color is incorrect).</li> </ul>

# OPERATIONS (continued)

## Image Menu

The following adjustments and settings are available when IMAGE is selected on the menu. Select an item with the  $\uparrow$  and  $\downarrow$  buttons, and start or stop operation with the  $\leftarrow$  and  $\rightarrow$  buttons.

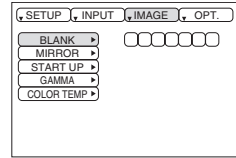

**Table 6. Image Menu**

Item	Description
BLANK	<p><b>Select Blank Screen Color:</b> Select color with the <math>\leftarrow</math> / <math>\rightarrow</math> button.</p> <ul style="list-style-type: none"> <li>The image is cleared and the entire screen is displayed in the selected color, when BLANK mode is set with BLANK ON, or when there is no signal for 5 minutes.</li> </ul>
MIRROR	<p><b>Select Mirror Status:</b> Select mirror status with <math>\uparrow</math> / <math>\downarrow</math> button.</p>
START UP	<p><b>Setup Initial Screen Display:</b> Select TURN ON with the <math>\uparrow</math> button.</p> <p><b>Clear Initial Screen Display:</b> Select TURN OFF with the <math>\downarrow</math> button.</p> <ul style="list-style-type: none"> <li>Note that if TURN OFF is selected the blank screen is displayed in blue when there is no signal.</li> </ul>
GAMMA	<p><b>Select Gamma mode:</b> Select the gamma mode with the <math>\uparrow</math> / <math>\downarrow</math> button.</p> <p>NORMAL <math>\leftarrow</math> ↔ <math>\rightarrow</math> CINEMA <math>\leftarrow</math> ↔ <math>\rightarrow</math> DYNAMIC</p>
COLOR TEMP	<p><b>Select Color Temperature:</b></p> <p>Select the color temperature mode with the <math>\uparrow</math> / <math>\downarrow</math> button.</p> <p>NORMAL <math>\leftarrow</math> ↔ <math>\rightarrow</math> LOW</p>

# OPERATIONS (continued)

## Options Menu

The following adjustments and settings are available when OPT. is selected on the menu. Select an item with the  $\uparrow$  and  $\downarrow$  buttons, and start or stop operation with the  $\leftarrow$  and  $\rightarrow$  buttons.

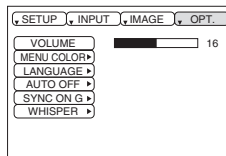

ENGLISH

**Table 7. Options Menu**

Item	Description
VOLUME	Reduce $\leftarrow$ $\leftrightarrow$ $\rightarrow$ Increase
MENU COLOR	<b>Select Menu Background Color:</b> Select with the $\leftarrow$ / $\rightarrow$ button.
LANGUAGE	<b>Select Menu Display Language:</b> Select with the $\uparrow$ / $\downarrow$ button.
AUTO OFF	<b>Set AUTO OFF:</b> Set 1~99 minutes with the $\uparrow$ / $\downarrow$ button. The system automatically enters the standby mode when a signal is not received for the set time. <b>Clear AUTO OFF:</b> Select STOP (0 min.) with the $\downarrow$ button. When STOP is selected the system does not enter the standby mode even if no signal is received.
SYNC ON G	<b>SYNC ON G Valid:</b> Select TURN ON with the $\uparrow$ button. <b>SYNC ON G Invalid:</b> Select TURN OFF with the $\downarrow$ button. • May not be displayed correctly with some input signals when SYNC ON G is valid. In such cases, remove the signal connector so that no signal is received, set SYNC ON G to invalid, and reconnect the signal.
WHISPER	<b>Set <u>Clear</u> WHISPER Mode:</b> Press the $\uparrow$ / $\downarrow$ button. When the WHISPER is selected, the WHISPER mode is active. In the WHISPER mode, acoustic noise level from the unit is reduced, and brightness level on screen is a little lower.



# OPERATIONS (continued)

## No Signal Menu

The same adjustments and settings are available with the Image and Options menus when the MENU button is pressed during display of the “NO INPUT IS DETECTED ON \*\*\*” or “SYNC IS OUT OF RANGE ON \*\*\*” message while no signal is received. Select an item with the  $\blacktriangle$  and  $\blacktriangledown$  buttons, and start or stop operation with the  $\blacktriangleleft$  and  $\blacktriangleright$  buttons.

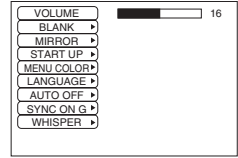

**Table 8. No Signal Menu**

Item	Description
VOLUME	Reduce $\blacktriangleleft$ $\leftrightarrow$ $\blacktriangleright$ Increase <ul style="list-style-type: none"> <li>When this function is used, audio input is automatically switched to video. The audio input can be switched by moving the DISK PAD left and right during the display of the volume adjustment bar. The volume adjustment bar is displayed by pressing VOLUME <math>\blacktriangleleft</math> / <math>\blacktriangleright</math> button.</li> </ul>
BLANK	<b>Select Blank Screen Color:</b> Select the color with the $\blacktriangleleft$ / $\blacktriangleright$ button. <ul style="list-style-type: none"> <li>When the blank mode is set with BLANK ON, by absence of a signal, or by input of a non-standard signal, the image is cleared and the complete screen is displayed in the selected color.</li> </ul>
MIRROR	<b>Select Mirror Status:</b> Select the mirror status with the $\blacktriangle$ / $\blacktriangledown$ button.
START UP	<b>Setup Initial Screen Display:</b> Select the TURN ON with the $\blacktriangle$ button. <b>Clear Initial Screen Display:</b> Select the TURN OFF with the $\blacktriangledown$ button. <ul style="list-style-type: none"> <li>Note that if TURN OFF is selected the blank screen is displayed in blue when there is no signal.</li> </ul>
MENU COLOR	<b>Select Menu Background Color:</b> Select the color with the $\blacktriangleleft$ / $\blacktriangleright$ button.
LANGUAGE	<b>Select Menu Display Language:</b> Select the language with the $\blacktriangle$ / $\blacktriangledown$ button.
AUTO OFF	<b>Set AUTO OFF:</b> Set 1~99 minutes with the $\blacktriangle$ / $\blacktriangledown$ button. The system automatically enters the standby mode when a signal is not received for the set time. <b>Clear AUTO OFF:</b> Select the STOP (0 min.) with the $\blacktriangledown$ button. When the STOP is selected the system does not enter the standby mode even if no signal is received.
SYNC ON G	<b>SYNC ON G Valid:</b> Select the TURN ON with the $\blacktriangle$ button. <b>SYNC ON G Invalid:</b> Select the TURN OFF with the $\blacktriangledown$ button. <ul style="list-style-type: none"> <li>May not be displayed correctly with some input signals when the SYNC ON G is valid. In such cases, remove the signal connector so that no signal is received, set the SYNC ON G to invalid, and reconnect the signal.</li> </ul>
WHISPER	<b>Set / Clear WHISPER Mode:</b> Press the $\blacktriangle$ / $\blacktriangledown$ button. When the WHISPER is selected, the WHISPER mode is active. In the WHISPER mode, acoustic moise level from the unit is reduced, and brightness level on screen is a little lower.

# MAINTENANCE

## Lamp



**HIGH VOLTAGE  
HIGH TEMPERATURE  
HIGH PRESSURE**

Contact BOXLIGHT before replacing the lamp.

For the optional lamp, see the item “Optional Parts” of the Table 12.

Before replacing the lamp, switch power OFF, remove the power cord from the power outlet, and wait approximately 45 minutes until the lamp has cooled. The lamp may explode if handled at high temperatures.



**WARNING** A mercury lamp used in this LCD projector is made of glass and has high internal pressure. The mercury lamp can burst with a big noise due to deterioration resulting from a shock, crack and passage of time, and can end its service life in unlit condition. Lamps also have a considerably different service life and can sometimes end up in burst or turn to unlit condition soon after use. Furthermore, when the lamp is blown up, glass fragments can get scattered around the lamp house and some gas containing mercury inside the lamp can leak out of the projector’s air vent.

- Handle the lamp with utmost care as it can burst during use if subjected to a shock or impact or if scratched or cracked.
  - Probability for the burst will increase if the lamp is used for extended period of time or used exceeding the period of replacement. You are advised to follow instructions for lamp replacement as soon as they are given (Refer to Table 9 of Page 20, Table 10 of Page 21). Avoid any reuse of an old lamp (used lamp) since such reuse can result in burst.
  - In case the lamp gets blown up in a short period of time after use, some electrical failures or troubles other than the lamp itself may be suspected as causes. Under such circumstances, consult **BOXLIGHT**.
  - Should the lamp burst (accompanied by a big bursting noise), perform ventilation sufficiently, and exercise maximum caution not to inhale any gas out of the projector’s air vent or not to let it enter your eyes or mouth.
  - Should the lamp burst (accompanied by a big bursting noise), make absolutely sure to unplug the power cord from the outlet. \_\_\_\_\_
- You should not engage in cleanup or replacement of the lamp by yourself since scattered glass fragments can damage the inside of projector or can result in personal injury when you handle it.
- When you dispose of any used lamps, be sure to observe and follow local ordinances and regulations of the area or district where they are subjected to disposal. Generally speaking, the lamps are treated similarly as glasses and bottles in most cases, but there are areas or districts where lamps are classified as a separate collection, and so be sure to use caution.
  - Never use the lamp in a state where the lamp cover is removed.

## Lamp Life

Projector lamps have a finite life. The image will become darker, and hues will become weaker, after a lamp has been used for a long period of time.

Replace the lamp if the LAMP indicator is red, or the CHANGE THE LAMP message appears when the projector is switched ON. See Table 9 of P.20 and Table 10 of P.21.

**NOTE** • The LAMP indicator is also red when the lamp unit reaches high temperature. Before replacing the lamp, switch power OFF, wait approximately 20 minutes, and switch power ON again. If the LAMP indicator is still red, replace the lamp.

# MAINTENANCE (continued)

## Replacing the Lamp

1. Switch the projector OFF, remove the power cord from the power outlet, and wait at least 45 minutes for the unit to cool.
2. Prepare a new lamp.
3. Check that the projector has cooled sufficiently, and gently turn it upside down.
4. Loosen the two screws as shown in the diagram, and remove the lamp cover.
5. Loosen the three screws, and gently remove the lamp while holding the grips. Touching the inside of the lamp case may result in uneven coloring.
6. Install the new lamp and tighten the three screws firmly. Also steadily push the opposite side of the screwed lamp into the unit.
7. Replace the lamp cover in position and tighten the two screws firmly.
8. Gently turn the projector right-side up.

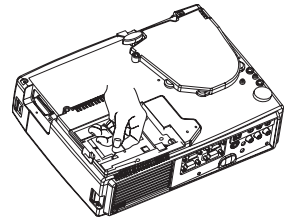
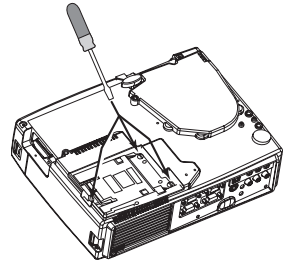
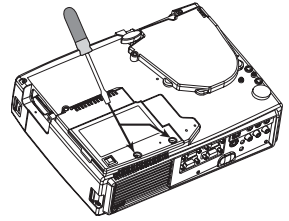

**CAUTION** • Ensure that screws are tightened properly. Screws not tightened fully may result in injury or accidents.  
• Do not use the projector with the lamp cover removed.

## Resetting the Lamp Timer

Reset the lamp timer after replacing the lamp. When the lamp has been replaced after the LAMP indicator is red, or the CHANGE THE LAMP message is displayed, complete the following operation within ten minutes of switching power ON. The power will be turned off automatically in over 10 minutes.

1. Switch power ON, and press the RESET button, for approximately three seconds. The 'LAMP xxxx hr' message will appear on the lamp timer on the bottom of the screen.
2. Press the MENU button on the remote control transmitter, or the RESET button on the control panel, while the lamp timer is displayed. The 'LAMP xxxx □ → 0 ■ CANCEL' message will then appear.
3. Press the  $\ominus$  and select 0, and wait until the timer display is cleared.

**NOTE** • Do not reset the lamp timer without replacing the lamp. Reset the lamp timer always when replacing the lamp. The message functions will not operate properly if the lamp timer is not reset correctly.

# MAINTENANCE (continued)

## Air Filter

### Cleaning the air Filter

The air filter should be cleaned as described below at intervals of approximately 100 hours.

1. Switch the projector power supply OFF, and remove the power cord from the power outlet.
2. Clean the air filter with a vacuum cleaner.

### Replacing the Air Filter

Replace the air filter if contamination cannot be removed, or if it is damaged.

1. Remove the filter cover.
2. Remove the old filter.
3. Set the new filter and the filter cover.

 **CAUTION** • Switch power OFF and remove the power cord from the power outlet before beginning maintenance work. Please read the separate “SAFETY INSTRUCTIONS” thoroughly to ensure that maintenance is performed correctly.

- Replace the air filter if contamination cannot be removed, or if it is damaged. Contact BOXLIGHT for service. For the optional air filter, see the item “Optional Parts” of the Table 12.
- Do not use the equipment with the air filter removed.
- When the air filter is clogged with dust etc. the power supply is switched OFF automatically to prevent the temperature rising inside the projector.

## Other Maintenance

### Maintenance Inside the Equipment

For safety reasons, ensure that the equipment is cleaned and checked by BOXLIGHT once every two years. Maintaining the equipment by yourself is dangerous.

### Cleaning the Lens

Gently wipe the lens with lens cleaning paper. Do not touch the lens with your hands.

### Cleaning the Cabinet and Remote control transmitter

Gently wipe with a soft cloth. If dirt and stains etc. are not easily removed, use a soft cloth dampened with water, or water and a neutral detergent, and wipe dry with a soft, dry cloth.

 **CAUTION** • Switch power OFF and remove the power cord from the power outlet before beginning maintenance work. Please read the separate “SAFETY INSTRUCTIONS” thoroughly to ensure that maintenance is performed correctly.

- Do not use detergents or chemicals other than those noted above (e.g. benzene or thinners).
- Do not use cleaning sprays.
- Do not rub with hard materials, or tap the equipment.

# TROUBLESHOOTING

## OSD Message

The messages as described below may appear on the screen at power ON. Take the appropriate measures when such messages appears.

**Table 9. OSD Message**

Message	Contents
CHANGE THE LAMP AFTER REPLACING LAMP, RESET THE LAMP TIME. (*1)	The usage time of lamp will be reaching 2000 hr shortly.(*2) It is recommended to replace the lamp soon. Prepare a new lamp as a replacement.
CHANGE THE LAMP AFTER REPLACING LAMP, RESET THE LAMP TIME. THE POWER WILL TURN OFF AFTER ** hr. (*1)	The usage time of lamp will be reaching 2000 hr shortly. It is recommended to replace the lamp within * * hours.(*2) It might be happened that the lamp is cut off before * * hr by any chance. Power will be switched OFF automatically in * * hours. Replace the lamp as shown in P.17~18 "Lamp". Always reset the lamp timer after replacing the lamp.
CHANGE THE LAMP AFTER REPLACING LAMP, RESET THE LAMP TIME. THE POWER WILL TURN OFF AFTER 0 hr.	The usage time of lamp is about to reach. Power will be switched OFF in a few minutes.(*2) Switch power OFF immediately and replace the lamp as shown in P.17 ~18 "Lamp". Always reset the lamp timer after replacing the lamp.
NO INPUT IS DETECTED ON ***	No input signal found. Check signal input connections and signal sources.
SYNC IS OUT OF RANGE ON ***	The horizontal or vertical frequency of the input signal is not within the specified range. Check the specifications of the equipment and the signal source.
CHECK THE AIR FLOW	The internal temperature has risen. Switch power OFF, and wait 20 minutes until the equipment cools. Check the following and Switch power ON again. * Are the ventilation openings blocked. * Is the air filter dirty. * Is the ambient temperature in excess of 35°C.

**NOTE** (\*1) This message is cleared automatically after approximately three minutes, and appears every time power is switched ON.

(\*2) The unit has a function to turn the power off which will be active when the usage time reaches 2000 hr. However the life of lamp might be much different among lamps, so that it might be happened that a lamp is cut off before the function is active.

# TROUBLESHOOTING (continued)

## Indicators Message

The POWER indicator, LAMP indicator, and TEMP indicator are lit and blank as follows. Take the appropriate measures.

Table 10. Indicators Message

POWER indicator	LAMP indicator	TEMP indicator	Contents
Lights orange	Turns off	Turns off	The Standby mode has been set.
Blinks green	Turns off	Turns off	Warming up. Please wait.
Lights green	Turns off	Turns off	ON. Normal operation possible.
Blinks orange	Turns off	Turns off	Cooling. Please wait.
Blinks red	-	-	Cooling. Please wait. The error is found. Take the appropriate measures when the POWER indicator ceases blinking
Blinks /Lights red	Lights red	Turns off	Lamp is not lit. The interior of the equipment may be too hot. Switch power OFF, wait 20 minutes until the equipment cools, and check whether the ventilation openings are blocked, whether the air filter is dirty, or whether the ambient temperature exceeds 35 °C. And switch power ON again. Replace the lamp if the same problem occurs.
Blinks /Lights red	Blinks red	Turns off	Lamp or lamp cover is not found, or hasn't been fitted in correctly. Switch power OFF, and wait for 45 minutes until the equipment cools. Check fitting of the lamp and lamp cover, and switch power ON again. Contact BOXLIGHT if the same problem occurs again.
Blinks /Lights red	Turns off	Blinks red	The cooling fan is not operating. Switch power OFF, and wait for 20 minutes until the equipment cools. Check for foreign matters in the fan, and switch power ON again. Contact BOXLIGHT if the same problem occurs again.
Blinks /Lights red	Turns off	Lights red	The interior of the equipment is too hot. Switch power OFF, and wait for 20 minutes until the equipment cools. Check whether the ventilation openings are blocked, whether the air filter is dirty, or whether the ambient temperature exceeds 35 °C. Then switch power ON again. Contact BOXLIGHT if the same problem occurs again.
Lights green	Blinks red	Blinks red	The interior of the equipment is too cool. Check whether the ambient temperature is below 0°C. Contact BOXLIGHT if the same problem occurs when the ambient temperature is 0~35°C.

**NOTE** When the internal temperature becomes excessive power is switched OFF automatically for safety reasons, and the indicator is extinguished. Set the power switch to [O] and wait for 20 minutes until the equipment has cooled sufficiently.

# TROUBLESHOOTING (continued)

## Symptom

Before requesting repair, consult the following chart. If the situation cannot be corrected, then contact BOXLIGHT at 800-762-5757 or 360-779-7901.

**Table 11. Symptom**

Symptom	Possible cause	Remedy	Page
The power is not turned on.	The main power switch is not turned on.	Turn on the main power switch.	8,9
	The power cord is disconnected.	Plug the power cord into an AC power outlet.	
	The main power was disconnected during operation by the power failure and so on.	Turn off the projector with the main power switch (set the power switch to [O]), and wait for about 20 minutes. When the equipment has cooled enough, turn power on.	9
No video or audio.	The input is not correctly set.	Use the projector or remote control transmitter to set.	10
	No signal input.	Connect correctly.	7,8
Video is present but no audio.	The projector is not correctly connected.	Connect correctly.	7,8
	The volume is set to minimum.	Press VOLUME ◀ on the remote control or display the menu screen and adjust the volume.	11,15
	Mute is turned on.	Press the MUTE ⊕ button.	11
Audio is present but no video.	The projector is not correctly connected.	Connect correctly.	7,8
	The brightness adjustment knob is rotated fully clockwise.	Select BRIGHT with the MENU button and the press the ⊖ button.	12
	The lens cap is still attached.	Remove the lens cap.	9
Colors are pale and color matching is poor.	Color density and color matching are not correctly adjusted.	Adjust the video.	12
Images are dark.	Brightness and contrast are not correctly adjusted.	Adjust the video.	12
	The lamp is nearing the end of its service life.	Replace with a new lamp.	17
	WHISPER mode is set.	Clear WHISPER mode.	15
Video is blurred.	Focus or H PHASE is out of adjustment.	Adjust the focus or H PHASE.	9,12

# SPECIFICATIONS

**Table 12. Specifications**

Item		Specification	
Product name		Liquid crystal projector	
Liquid crystal panel	Panel size	2.3 cm (0.9 type)	
	Drive system	TFT active matrix	
	Pixels	480,000 pixels (800 horizontal x 600 vertical)	
Lens		Zoom lens F=1.7 ~ 2.1 f=36.8 ~ 47.8 mm	
Lamp		200 W UHB	
Speaker		1.0W+1.0W (stereo)	
Power supply		AC100 ~ 120V, 3.3A / AC220 ~ 240V, 1.4A	
Power consumption		310W	
Temperature range		0 ~ 35°C (Operating)	
Size		298 (W) x 94.6 (H) x 228 (D) mm	
Weight (mass)		3.25 kg	
RGB signal input	RGB IN	1	Video: Analog 0.7Vp-p, 75Ω terminator (positive) H/V. sync.: TTL level (positive/negative) Composite sync.: TTL level D-sub 15-pin shrink jack
		2	
	AUDIO IN	1	200mVrms, 50 kΩ (max. 3.0Vp-p)
		2	Stereo mini jack
Video signal input	VIDEO IN		1.0Vp-p, 75Ω terminator RCA jack
	S-VIDEO IN		Brightness signal: 1.0Vp-p, 75Ω terminator Color signal: 0.286Vp-p (NTSC, burst signal), 75Ω terminator 0.300Vp-p (PAL/SECAM, burst signal), 75Ω terminator Mini DIN 4-pin jack
	COMPONENT VIDEO	Y	1.0 Vp-p, 75 Ω Terminator (Positive)
		CB/PB	0.7 Vp-p, 75 Ω Terminator (Positive)
		CR/PR	0.7 Vp-p, 75 Ω Terminator (Positive)
	AUDIO IN	L	200mVrms, 50 kΩ (max. 3.0Vp-p)
R		RCA jack	
Signal output	RGB OUT		Video: Analog 0.7Vp-p, 75Ω output impedance (positive) H/V. sync.: TTL level (positive/negative) Composite sync.: TTL level D-sub 15-pin shrink jack
	AUDIO OUT		200mVrms, output impedance 1 kΩ (max. 3.0Vp-p) Stereo mini jack
Control functions	CONTROL		D-sub 15-pin shrink plug
	USB		USB jack (B type)
Optional Parts			Lamp: CP635I-930 (DT00431) Air Filter: MU01421 * For others, consult your dealer.

**NOTE** • This specifications are subject to change without notice.



# WARRANTY

---

## LIMITED WARRANTY

BOXLIGHT CORPORATION("BOXLIGHT") warrants that each Boxlight CP-635i ("the Product") sold hereunder will conform to and function in accordance with the written specifications of BOXLIGHT. Said limited warranty shall apply only to the first person or entity that purchases the Product for personal or business use and not for the purpose of distribution resale. Said warranty shall continue for a period of two (2) years from the date of such purchase. BOXLIGHT does not warrant that the Product will meet the specific requirements of the first person or entity that purchases the Product for personal or business use. Lamp is warranted for 120 days.

BOXLIGHT CORPORATION's liability for the breach of the foregoing limited warranty is limited to the repair or replacement of the Product or refund of the purchase price of the Product, at BOXLIGHT's sole option. To exercise the Purchaser's rights under the foregoing warranty, the Product must be returned at the Purchaser's sole cost and expense, to BOXLIGHT or any authorized service center provided, however, that the Product must be accompanied by a written letter explaining the problem and which includes (i) proof of purchase; (ii) the dealer's name; (iii) the model and serial number of the Product. A return authorization number, issued by the BOXLIGHT customer service department, must also be clearly displayed on the outside of the shipping carton containing the Product.

## WARRANTY LIMITATION AND EXCLUSION

BOXLIGHT CORPORATION shall have no further obligation under the foregoing limited warranty if the Product has been damaged due to abuse, misuse, neglect, accident, unusual physical or electrical stress, unauthorized modification, tampering, alterations, or service other than by BOXLIGHT or its authorized agents, causes other than from ordinary use or failure to properly use the Product in the application for which said Product is intended.

## DISCLAIMER OR UNSTATED WARRANTIES

The warranty printed above is the only warranty applicable to this purchase.

All other warranties express or implied, Including, but not limited to, the implied warranties of merchantability and fitness for a particular purpose are disclaimed. There are no warranties that extend beyond the face of hereof and the forgoing warranty shall not be extended, altered or varied except by written instrument signed by BOXLIGHT CORPORATION.

## LIMITATION OF LIABILITY

It is understood and agreed that BOXLIGHT's liability whether in contract, in tort, under any warranty, in negligence or otherwise, shall not exceed the return of the amount of the purchase price paid by purchaser and under no circumstances shall BOXLIGHT be liable for special, indirect or consequential damages. The price stated for the Product is a consideration in limiting BOXLIGHT's liability. No action regardless of form, arising out of the agreement to purchase the product, may be brought by purchaser more than one year after the cause of action has accrued.

 **BOXLIGHT**<sup>®</sup>  
 Presenting a Better Way  
**Boxlight**  
19332 Powder Hill Place  
Poulsbo, WA 98370-7407-USA  
[www.boxlight.com](http://www.boxlight.com)  
U.S. and Canada 800-762-5757  
International 360-779-7901



\*QR53221\*

Download from [Www.Somanuals.com](http://Www.Somanuals.com). All Manuals Search And Download.

Printed in Japan

## Free Manuals Download Website

<http://myh66.com>

<http://usermanuals.us>

<http://www.somanuals.com>

<http://www.4manuals.cc>

<http://www.manual-lib.com>

<http://www.404manual.com>

<http://www.luxmanual.com>

<http://aubethermostatmanual.com>

Golf course search by state

<http://golfingnear.com>

Email search by domain

<http://emailbydomain.com>

Auto manuals search

<http://auto.somanuals.com>

TV manuals search

<http://tv.somanuals.com>