

USER'S GUIDE

BOXLIGHT MP-41t



TO THE OWNER

Before operating this projector, read this manual thoroughly and operate the projector properly. This projector provides many convenient features and functions. Operating the projector properly enables you to manage those features and maintains it in better condition for a considerable time. Improper operation may result in not only shortening the product-life, but also malfunctions, fire hazard, or other accidents. If your projector seems to operate improperly, read this manual again, check operations and cable connections and try the solutions in the "Trouble-shooting" section of the end of this booklet. If the problem still persists, contact the sales dealer where you purchased the projector or the service center.



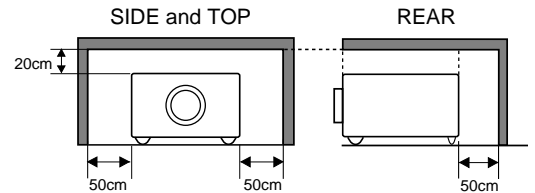

SAFETY PRECAUTIONS

WARNING : TO REDUCE THE RISK OF FIRE OR ELECTRIC SHOCK, DO NOT EXPOSE THIS APPLIANCE TO RAIN OR MOISTURE.

- This projector produces intense light from the projection lens. Do not stare directly into the lens as possible. Eye damage could result. Be especially careful that children do not stare directly into the beam.
- This projector should be set in the way indicated. If not, it may result in a fire hazard.
- Take appropriate space on the top, sides and rear of the projector cabinet for allowing air circulation and cooling the projector. Minimum distance should be taken. If the projector is to be built into a compartment or similarly enclosed, the minimum distances must be maintained. Do not cover the ventilation slot on the projector. Heat build-up can reduce the service life of your projector, and can also be dangerous.
- Do not put any flammable object or spray can near the projector, hot air is exhausted from the ventilation holes.
- Remote Control Unit, supplied to this projector, emits the laser beam as the laser pointer function from Laser Light Window while pressing LASER button (for 1 minute / LASER POINTER INDICATOR lights red to indicate laser emission). Do not look into Laser Light Window or shine the laser beam on yourself or other people. Eye damage may result.
- If the projector is not to be used for an extended time, unplug the projector from the power outlet.



READ AND KEEP THIS USER'S GUIDE FOR LATER USE.

	CAUTION RISK OF ELECTRIC SHOCK DO NOT OPEN	
CAUTION : TO REDUCE THE RISK OF ELECTRIC SHOCK, DO NOT REMOVE COVER (OR BACK). NO USER-SERVICEABLE PARTS INSIDE EXCEPT LAMP REPLACEMENT. REFER SERVICING TO QUALIFIED SERVICE PERSONNEL.		
 THIS SYMBOL INDICATES THAT DANGEROUS VOLTAGE CONSTITUTING A RISK OF ELECTRIC SHOCK IS PRESENT WITHIN THIS UNIT.	 THIS SYMBOL INDICATES THAT THERE ARE IMPORTANT OPERATING AND MAINTENANCE INSTRUCTIONS IN THE USER'S GUIDE WITH THIS UNIT.	

SAFETY INSTRUCTIONS

All the safety and operating instructions should be read before the product is operated.

Read all of the instructions given here and retain them for later use. Unplug this projector from AC power supply before cleaning. Do not use liquid or aerosol cleaners. Use a damp cloth for cleaning.

Follow all warnings and instructions marked on the projector.

For added protection to the projector during a lightning storm, or when it is left unattended and unused for long periods of time, unplug it from the wall outlet. This will prevent damage due to lightning and power line surges.

Do not expose this unit to rain or use near water... for example, in a wet basement, near a swimming pool, etc...

Do not use attachments not recommended by the manufacturer as they may cause hazards.

Do not place this projector on an unstable cart, stand, or table. The projector may fall, causing serious injury to a child or adult, and serious damage to the projector. Use only with a cart or stand recommended by the manufacturer, or sold with the projector. Wall or shelf mounting should follow the manufacturer's instructions, and should use a mounting kit approved by the manufacturers.

An appliance and cart combination should be moved with care. Quick stops, excessive force, and uneven surfaces may cause the appliance and cart combination to overturn.



Slots and openings in the back and bottom of the cabinet are provided for ventilation, to insure reliable operation of the equipment and to protect it from overheating.

The openings should never be covered with cloth or other materials, and the bottom opening should not be blocked by placing the projector on a bed, sofa, rug, or other similar surface. This projector should never be placed near or over a radiator or heat register.

This projector should not be placed in a built-in installation such as a book case unless proper ventilation is provided.

Never push objects of any kind into this projector through cabinet slots as they may touch dangerous voltage points or short out parts that could result in a fire or electric shock. Never spill liquid of any kind on the projector.

This projector should be operated only from the type of power source indicated on the marking label. If you are not sure of the type of power supplied, consult your authorized dealer or local power company.

Do not overload wall outlets and extension cords as this can result in fire or electric shock. Do not allow anything to rest on the power cord. Do not locate this projector where the cord may be damaged by persons walking on it.

Do not attempt to service this projector yourself as opening or removing covers may expose you to dangerous voltage or other hazards. Refer all servicing to qualified service personnel.

Unplug this projector from wall outlet and refer servicing to qualified service personnel under the following conditions:

- a. When the power cord or plug is damaged or frayed.
- b. If liquid has been spilled into the projector.
- c. If the projector has been exposed to rain or water.
- d. If the projector does not operate normally by following the operating instructions. Adjust only those controls that are covered by the operating instructions as improper adjustment of other controls may result in damage and will often require extensive work by a qualified technician to restore the projector to normal operation.
- e. If the projector has been dropped or the cabinet has been damaged.
- f. When the projector exhibits a distinct change in performance-this indicates a need for service.

When replacement parts are required, be sure the service technician has used replacement parts specified by the manufacturer that have the same characteristics as the original part. Unauthorized substitutions may result in fire, electric shock, or injury to persons.

Upon completion of any service or repairs to this projector, ask the service technician to perform routine safety checks to determine that the projector is in safe operating condition.

Voor de klanten in Nederland



Bij dit product zijn batterijen geleverd. Wanneer deze leeg zijn, moet u ze niet weggooien maar inleveren als KCA.

COMPLIANCES

Federal Communication Commission Notice

Note : This equipment has been tested and found to comply with the limits for a Class B digital device, pursuant to part 15 of the FCC Rules. These limits are designed to provide reasonable protection against harmful interference in a residential installation. This equipment generates, uses and can radiate radio frequency energy and, if not installed and used in accordance with the instructions, may cause harmful interference to radio communications. However, there is no guarantee that interference will not occur in a particular installation. If this equipment does cause harmful interference to radio or television reception, which can be determined by turning the equipment off and on, the user is encouraged to try to correct the interference by one or more of the following measures :

- Reorient or relocate the receiving antenna.
- Increase the separation between the equipment and receiver.
- Connect the equipment into an outlet on a circuit different from that to which the receiver is connected.
- Consult the dealer or an experienced radio/TV technician for help.

Use of shielded cable is required to comply with class B limits in Subpart B of Part 15 of FCC Rules.

Do not make any changes or modifications to the equipment unless otherwise specified in the instructions. If such changes or modifications should be made, you could be required to stop operation of the equipment.

Model Number : BOXLIGHT MP-41t
Trade Name : Boxlight
Responsible party : BOXLIGHT
Address : 19332 Powder Hill Place Poulsbo, WA 98370-7407 USA
Telephone No. : (800)762-5757

AC POWER CORD REQUIREMENT

The AC Power Cord supplied with this projector meets the requirement for use in the country you purchased it.

AC Power Cord for the United States and Canada :

AC Power Cord used in the United States and Canada is listed by the Underwriters Laboratories (UL) and certified by the Canadian Standard Association (CSA).

AC Power Cord has a grounding-type AC line plug. This is a safety feature to be sure that the plug will fit into the power outlet. Do not try to defeat this safety feature. Should you be unable to insert the plug into the outlet, contact your electrician.

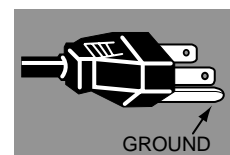

THE SOCKET-OUTLET SHOULD BE INSTALLED NEAR THE EQUIPMENT AND EASILY ACCESSIBLE.

TABLE OF CONTENTS

FEATURES AND DESIGN	6	COMPUTER MODE	22
PREPARATION	7	SELECTING INPUT SOURCE	22
NAME OF EACH PART OF PROJECTOR	7	SELECTING COMPUTER SYSTEM	22
SETTING-UP PROJECTOR	8	PC ADJUSTMENT	23
CONNECTING AC POWER CORD	8	AUTO PC ADJUSTMENT	23
POSITIONING PROJECTOR	9	MANUAL PC ADJUSTMENT	24
ADJUSTABLE FEET	10	COMPATIBLE COMPUTER SPECIFICATIONS	26
MOVING PROJECTOR	10	PICTURE IMAGE ADJUSTMENT	27
		IMAGE LEVEL SELECT	27
		IMAGE LEVEL ADJUSTMENT	28
		PICTURE SCREEN ADJUSTMENT	29
CONNECTING PROJECTOR	11	VIDEO MODE	30
TERMINALS OF PROJECTOR	11	SELECTING INPUT SOURCE	30
CONNECTING TO COMPUTER	12	SELECTING VIDEO SYSTEM	31
CONNECTING TO VIDEO EQUIPMENT	13	PICTURE IMAGE ADJUSTMENT	32
		IMAGE LEVEL SELECT	32
		IMAGE LEVEL ADJUSTMENT	33
		PICTURE SCREEN ADJUSTMENT	34
BEFORE OPERATION	14	SETTING	35
OPERATION OF REMOTE CONTROL	14	SETTING MENU	35
LASER POINTER FUNCTION	14		
REMOTE CONTROL BATTERIES INSTALLATION	15		
TOP CONTROLS AND INDICATORS	16		
OPERATING ON-SCREEN MENU	17		
HOW TO OPERATE ON-SCREEN MENU	17		
FLOW OF ON-SCREEN MENU OPERATION	17		
MENU BAR	18		
BASIC OPERATION	19	APPENDIX	37
TURNING ON / OFF PROJECTOR	19	OPERATING WIRELESS MOUSE	37
ADJUSTING SCREEN	20	MAINTENANCE	38
ZOOM ADJUSTMENT	20	WARNING TEMP. INDICATOR	38
FOCUS ADJUSTMENT	20	AIR FILTER CARE AND CLEANING	38
LENS SHIFT ADJUSTMENT	20	CLEANING PROJECTION LENS	38
KEystone ADJUSTMENT	20	LAMP REPLACEMENT	39
PICTURE FREEZE FUNCTION	21	LAMP REPLACE COUNTER	39
NO SHOW FUNCTION	21	TROUBLESHOOTING	40
P-TIMER FUNCTION	21	TECHNICAL SPECIFICATIONS	42
SOUND ADJUSTMENT	21		

TRADEMARKS

- Apple, Macintosh, and PowerBook are trademarks or registered trademarks of Apple Computer, Inc.
- IBM and PS/2 are trademarks or registered trademarks of International Business Machines, Inc.
- Windows and PowerPoint are registered trademarks of Microsoft Corporation.
- Each name of corporations or products in the user's guide is a trademark or a registered trademark of its respective corporation.

FEATURES AND DESIGN

This Multimedia Projector is designed with most advanced technology for portability, durability, and ease of use. This projector utilizes built-in multimedia features, a palette of 16.77 million colors, and matrix liquid crystal display (LCD) technology.

◆ Compact Design

This projector is extremely compact in size and weight. It is designed to carry and work anywhere you wish to use.

◆ Compatibility

This projector widely accepts various video and computer input signals including;

- **Computers**
IBM-compatible or Macintosh computer up to 1280 x 1024 resolution.
- **6 Color Systems**
NTSC, PAL, SECAM, NTSC 4.43, PAL-M or PAL-N color system can be connected.
- **Component Video**
Component video signal, such as a DVD player output high definition TV signals including 480i, 480p, 575i, 575p, 720p, 1035i or 1080i, can be connected.
- **S-Video**
S-Video signal, such as a S-VHS VCR output signal, can be connected.

◆ High Resolution Image

This projector provides 1024 x 768 dots resolution for computer input and 800 horizontal TV lines. Resolution from a computer between XGA (1024 x 768) and SXGA (1280 x 1024) is compressed into 1024 x 768 dots. This projector cannot display image of over 1280 x 1024 dots. When resolution of your computer is over than 1280 x 1024, reset a computer output for lower resolution.

◆ Multi-Scan System

This projector has Multi-Scan System to conform to almost all computer output signals quickly. There is no need for troublesome manual adjustment of frequency and other settings.

◆ One-Touch Auto PC Adjustment

Incoming computer video signals are recognized and best adjustment is automatically set by Auto PC Adjustment. No complicated setup is necessary and projection is always precise.

◆ Motor-driven Lens Shift

Projection lens can be moved up and down with motor-driven lens shift function. This function makes it easy to provide projected image where you want. Zoom and focus can be also adjusted with motor-driven operation.

◆ Digital Zoom (for Computer)

Digital Zoom function adjusts image size to approx. 1/4 ~ 49 times of original image size, allowing you to focus on crucial information at a presentation.

◆ Keystone Correction

Positioning height of a projector may result in distorted image being displayed in a trapezoid shape. Keystone Correction solves this problem by digitally altering projection to produce undistorted images.

◆ Power Management

Power Management function is provided to reduce power consumption while a projector is not in use. This Power Management function operates to turn Projection Lamp off when a projector detects signal interruption and any button is not pressed over 5 minutes. Projection Lamp is automatically turned on again when a projector detects signal or any operation button is pressed. This projector is shipped with this function ON.

◆ Digital Visual Interface

This projector is equipped with DVI 24-pin terminal for connecting DVI output from a computer.

◆ Laser Pointer Function

Remote Control Unit supplied with this projector includes Laser Pointer function. This function helps you to make a smart presentation on a projected screen.

◆ Wireless Mouse

Remote Control Unit supplied with this projector has Wireless Mouse function for a connected computer. This function enables you to operate both projector and computer with Remote Control Unit only.

◆ Multilanguage Menu Display

Operation menu is displayed in; English, German, French, Italian, Spanish, Portuguese, Dutch, Swedish, Chinese, Korean or Japanese.

PREPARATION

NAME OF EACH PART OF PROJECTOR

FRONT OF CABINET

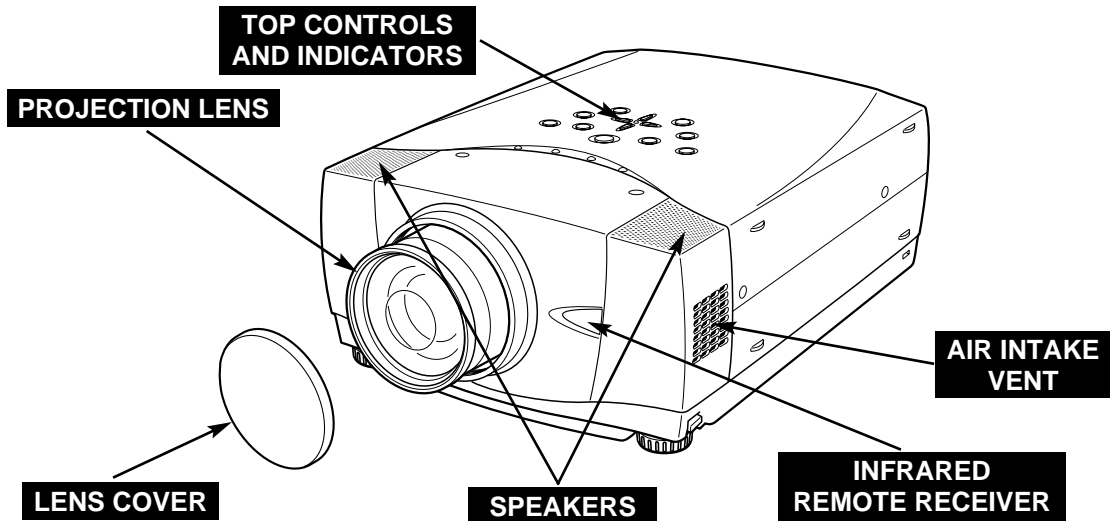

BACK OF CABINET

EXHAUST VENT



HOT AIR EXHAUSTED !

Air blown from exhaust vent is hot. When using or installing a projector, following precautions should be taken.

- Do not put a flammable object near this vent.
- Keep rear grills at least 3'(1 m) away from any object, especially heat-sensitive object.
- Do not touch this area, especially screws and metallic parts. This area will become hot while a projector is used.

This projector detects internal temperature and automatically controls operating power of Cooling Fans.

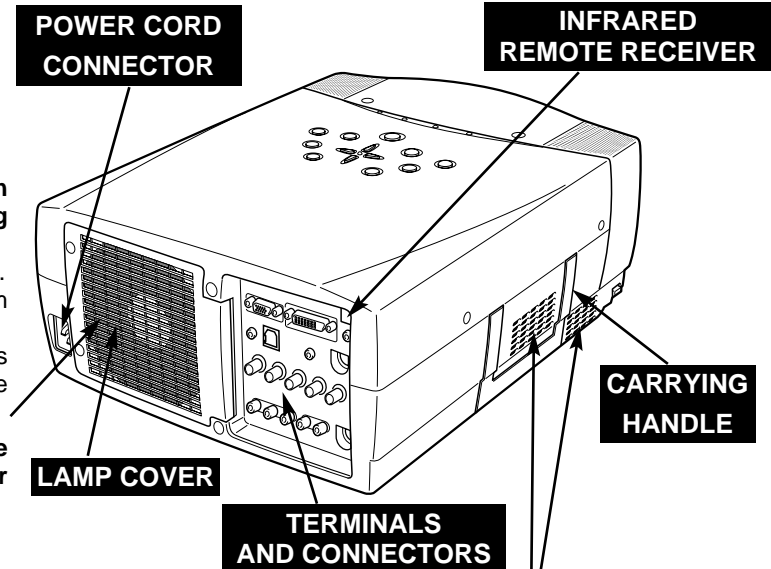

BOTTOM OF CABINET

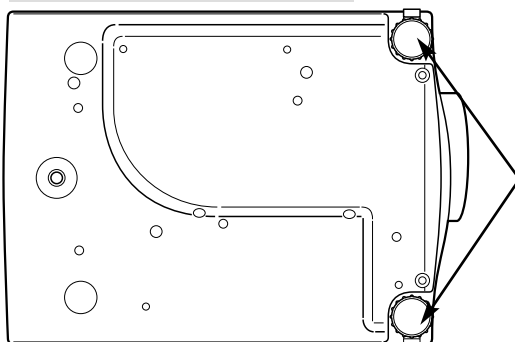

ADJUSTABLE FEET AND FEET LOCK LATCHES

AIR INTAKE VENTS

This projector is equipped with cooling fans for protection from overheating. Pay attention to following to ensure proper ventilation and avoid a possible risk of fire and malfunction.

- Do not cover vent slots.
- Keep side clear of any objects. Obstructions may block cooling air.

SETTING-UP PROJECTOR

CONNECTING AC POWER CORD

This projector uses nominal input voltages of 100-120 V or 200-240 V AC. This projector automatically selects correct input voltage. It is designed to work with single-phase power systems having a grounded neutral conductor. To reduce risk of electrical shock, do not plug into any other type of power system. Consult your authorized dealer or service station if you are not sure of type of power supply being in use. Connect a projector with a peripheral equipment before turning a projector on. (Refer to pages 11 ~ 13 for connection.)

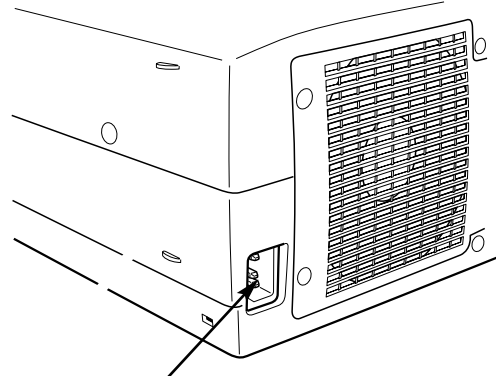

Connect AC Power Cord (supplied) to a projector. AC outlet must be near this equipment and must be easily accessible.



CAUTION

For safety, unplug AC Power Cord when an appliance is not used. When this projector is connected to outlet with AC Power Cord, an appliance is in Stand-by Mode and consumes a little electric power.

NOTE ON POWER CORD

AC Power Cord must meet requirement of country where you use a projector. Confirm AC plug type with chart below and proper AC power cord must be used. If supplied AC Power Cord does not match AC outlet, contact your sales dealer.

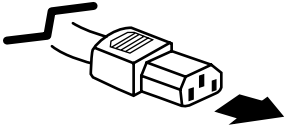
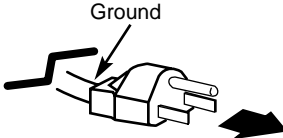
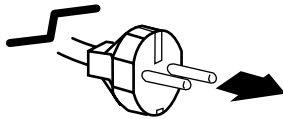
Projector side	AC Outlet side	
 <p data-bbox="363 1388 553 1461">To POWER CORD CONNECTOR on a projector.</p>	<p data-bbox="704 1184 964 1213">For U.S.A. and Canada</p>  <p data-bbox="748 1394 878 1449">To AC Outlet. (120 V AC)</p>	<p data-bbox="1078 1190 1373 1220">For Continental Europe</p>  <p data-bbox="1073 1419 1255 1472">To AC Outlet. (200 - 240 V AC)</p>

POSITIONING PROJECTOR

- This projector is designed to project on a flat projection surface.
- Projector can be focused from 4.6' (1.4m) ~ 48.3' (14.7m).
- Refer to figure below to adjust screen size.

ROOM LIGHT
 Brightness in room has a great influence on picture quality. It is recommended to limit ambient lighting in order to provide best image.

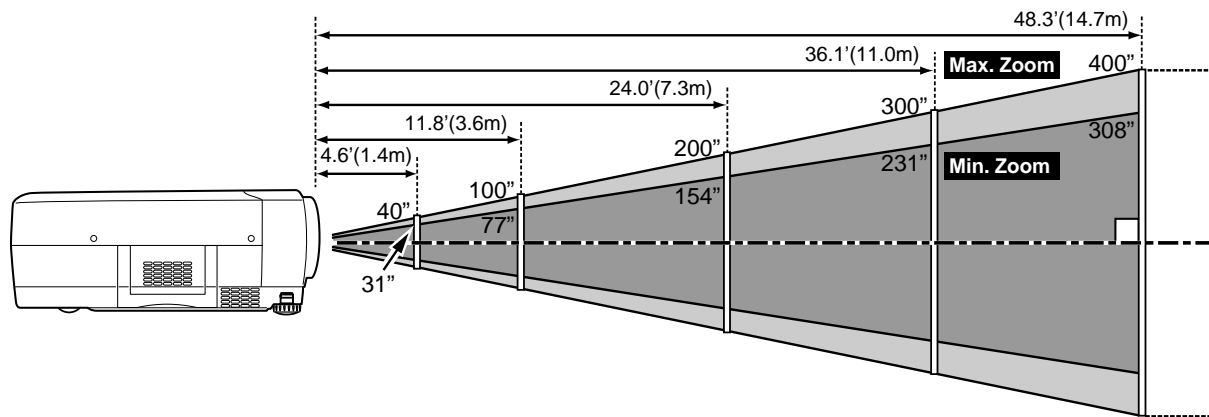

Screen Size	Max. Zoom	40"	100"	150"	200"	250"	300"	400"
	Min. Zoom	31"	77"	115"	154"	192"	231"	308"
Distance		4.6' (1.4m)	11.8' (3.6m)	17.7' (5.4m)	24.0' (7.3m)	30.2' (9.2m)	36.1' (11.0m)	48.3' (14.7m)

LENS SHIFT ADJUSTMENT

Projection lens can be moved up and down with motor-driven lens shift function. This function makes it easy to provide projected image where you want. U/D ratio can be adjusted 10 : 0 ~ 1 : 1 (refer to figure below.). Refer to P 20 for operation.

Highest (10 : 0) ←————→ Lowest (1 : 1)

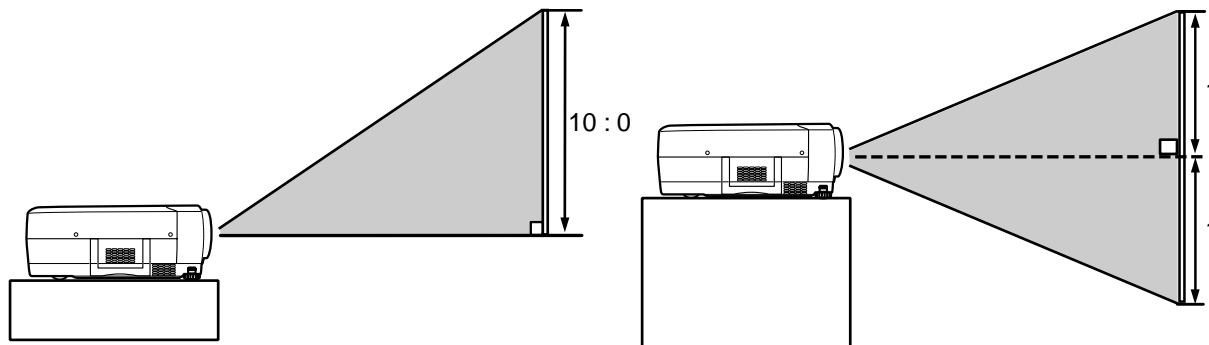

ADJUSTABLE FEET

Picture tilt and projection angle can be adjusted by rotating ADJUSTABLE FEET. Projection angle can be adjusted to 10.5 degrees.

- 1** Lift front of a projector and pull FEET LOCK LATCHES on both sides of a projector.
- 2** Release FEET LOCK LATCHES to lock ADJUSTABLE FEET and rotate ADJUSTABLE FEET to fine tune position and tilt.
- 3** To shorten ADJUSTABLE FEET, lift front of a projector and pull and undo FEET LOCK LATCHES.

Position and keystone distortion of image can be adjusted using Menu Operation. (Refer to P 20 and 35.)

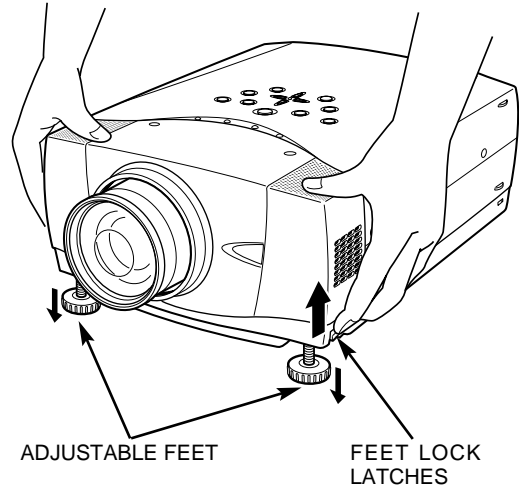

MOVING PROJECTOR

Use Carry Handle when moving a Projector.
When moving a projector, replace lens cover and retract feet to prevent damage to lens and cabinet.
When this projector is not in use for an extended period, put it into case (dust cover) supplied with this projector.

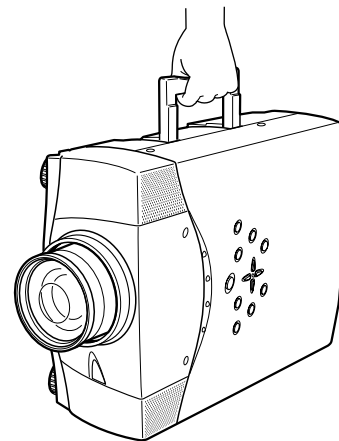

CAUTION IN CARRYING OR TRANSPORTING A PROJECTOR

- Do not drop or bump a projector, otherwise damages or malfunctions may result.
- When carrying a projector, use a suitable carrying case.
- Do not transport a projector by using a courier or transport service in an unsuitable transport case. This may cause damage to a projector. To transport a projector through a courier or transport service, consult your dealer for best way.

CONNECTING PROJECTOR

TERMINALS OF PROJECTOR

This projector has input and output terminals on its back for connecting computers and video equipment. Refer to figures on pages 11 to 13 and connect properly.

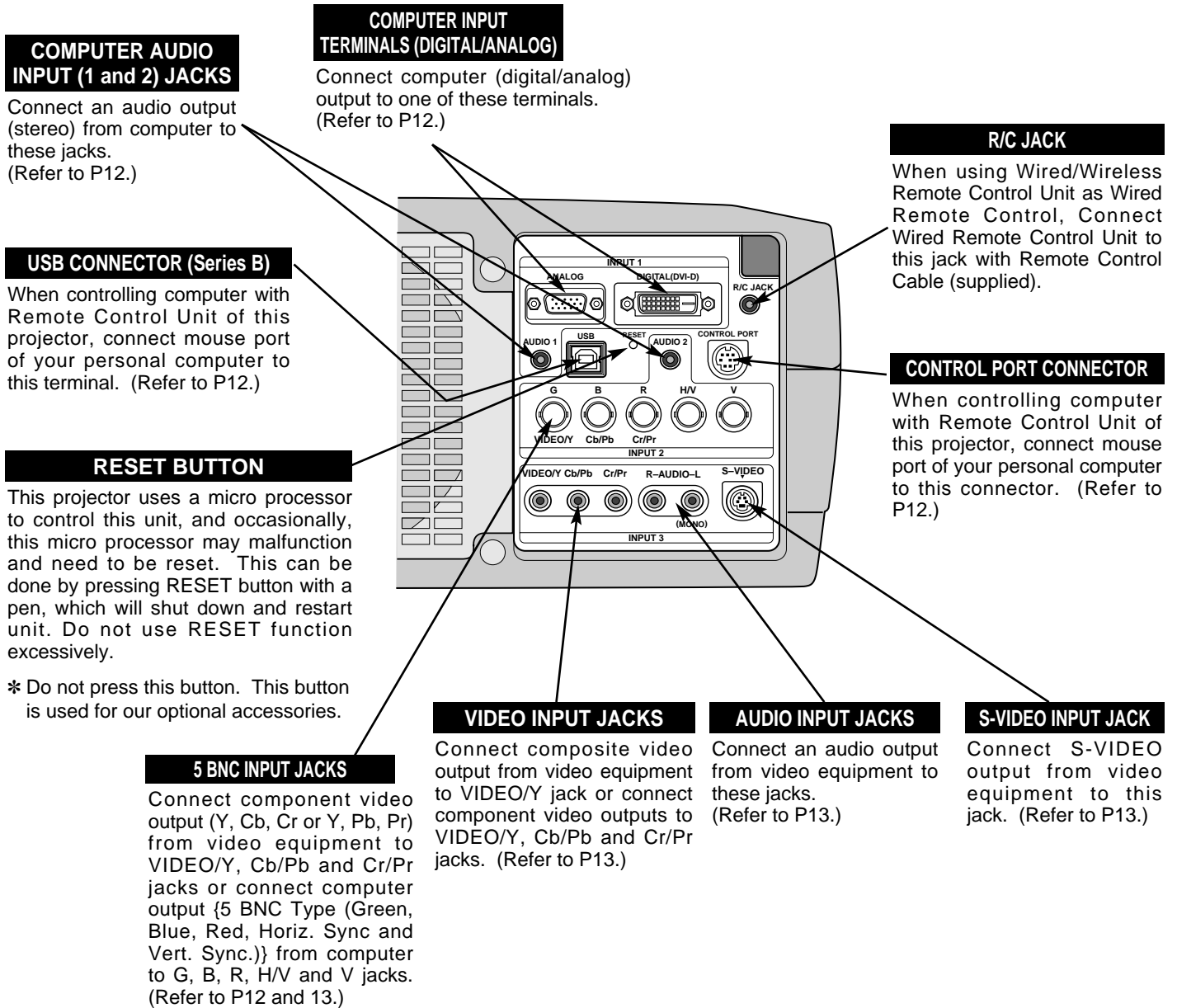

CONNECTING TO COMPUTER

Cables used for connection (* = Cable or adapter is not supplied with this projector.)

- VGA Cable (HDB 15 pin)
- DVI-Digital Cable (for Single Link T.M.D.S.) *
- BNC Cable *
- Control Cable for PS/2 Port, Serial Port or ADB Port
- USB Cable *
- MAC Adapter (When connecting to Macintosh computer)
- Audio Cables (RCA x 2 and Mini Plug (stereo) x 1) *

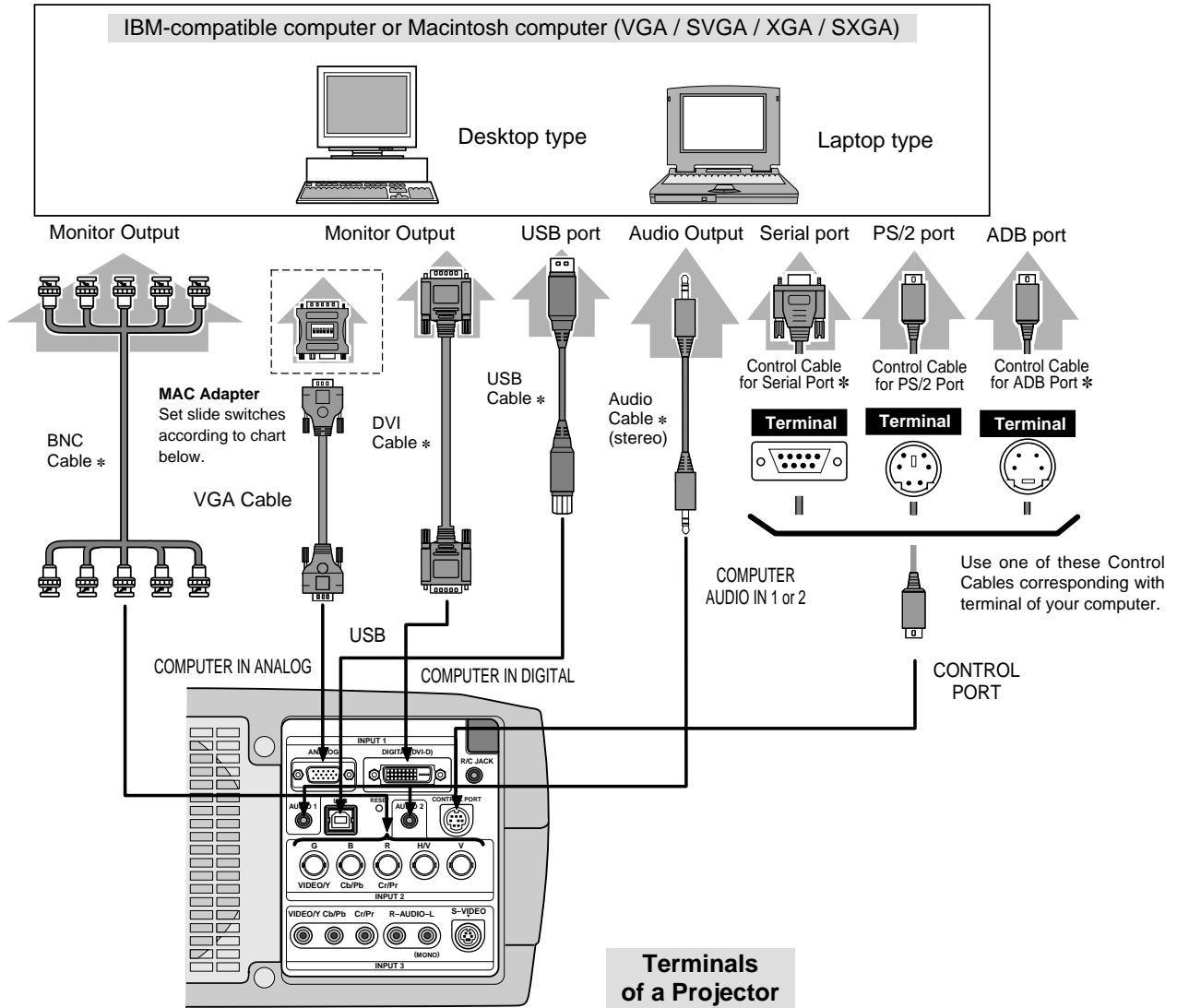

◆ **MAC ADAPTER**

Set switches as shown in table below depending on RESOLUTION MODE that you want to use before you turn on projector and computer.

	1	2	3	4	5	6
13" MODE (640 x 480)	ON	ON	OFF	OFF	OFF	OFF
16" MODE (832 x 624)	OFF	ON	OFF	ON	OFF	OFF
19" MODE (1024 x 768)	OFF	ON	ON	OFF	OFF	OFF
21" MODE (1152 x 870)	ON	ON	ON	ON	OFF	OFF

NOTE :

When connecting cable, power cords of both a projector and external equipment should be disconnected from AC outlet. Turn a projector and peripheral equipment on before computer is switched on.

CONNECTING TO VIDEO EQUIPMENT

Cables used for connection (* = Cable is not supplied with this projector.)

- Video Cable (RCA x 1 or RCA x 3) *
- BNC Cable *
- S-VIDEO Cable *
- Audio Cable (RCA x 2) *

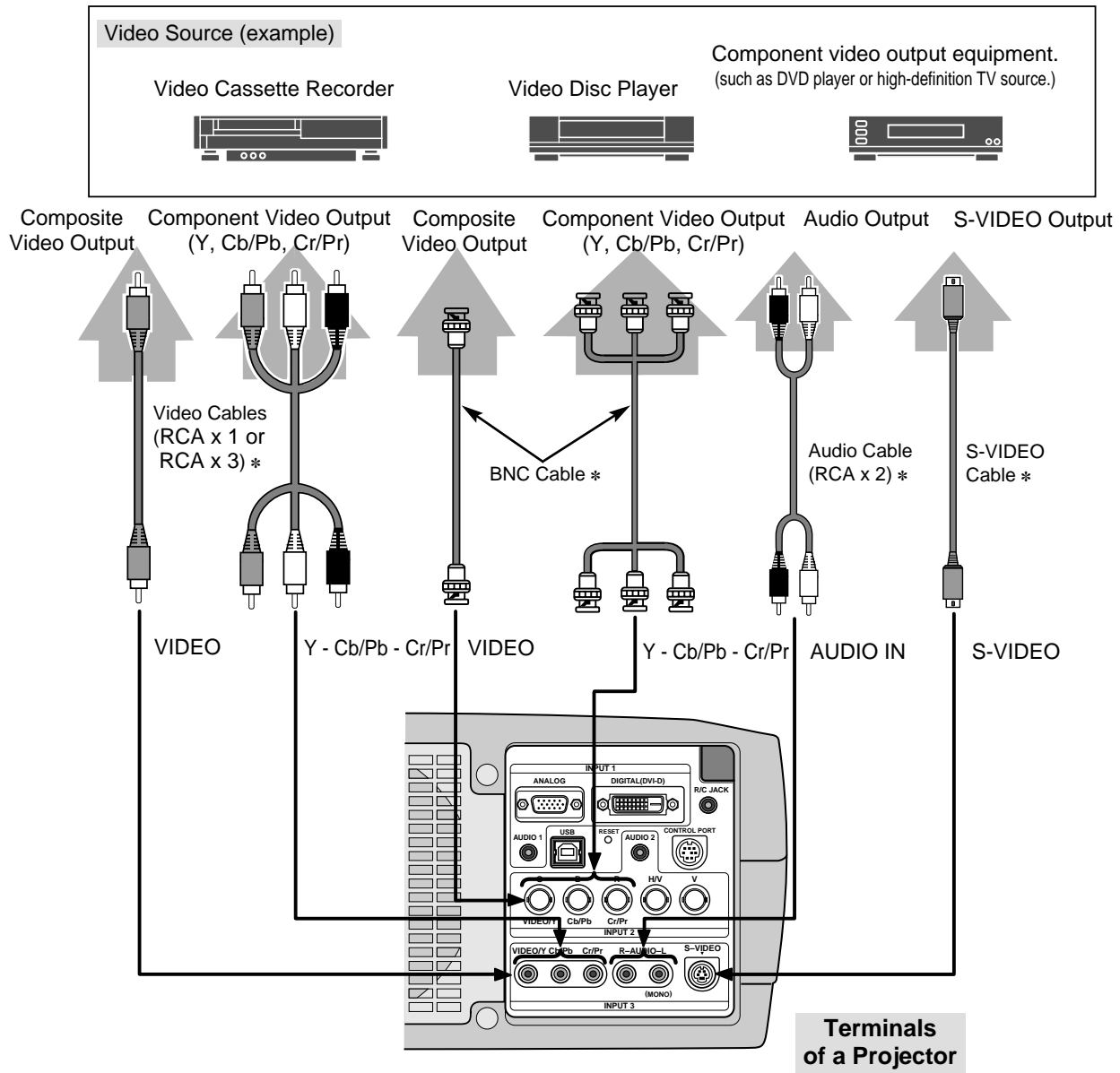

NOTE :
 When connecting cable, power cords of both a projector and external equipment should be disconnected from AC outlet.

BEFORE OPERATION

OPERATION OF REMOTE CONTROL

Left Side

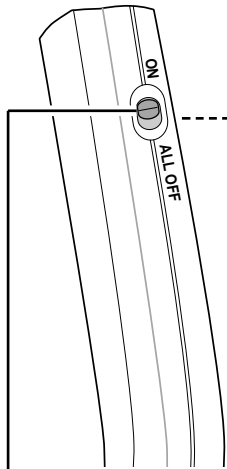

ALL-OFF SWITCH

When using Remote Control Unit, turn this switch to "ON." And turn it to "ALL OFF" when it is not used.

LASER POINTER INDICATOR

Lights red while laser beam is emitted from Laser Light Window.

MENU BUTTON

Used to select MENU operation. (P17, 18)

SELECT BUTTON

Used to execute item selected, or to expand or compress image in DIGITAL ZOOM +/- mode. (P29)
It is also used as a PC mouse in Wireless Mouse Operation. (P37)

LASER BUTTON

Used to operate Laser Pointer Function. Laser beam is emitted while pressing this button within 1 minute.
When using this Laser Pointer for more than 1 minute, release LASER button and press it again.

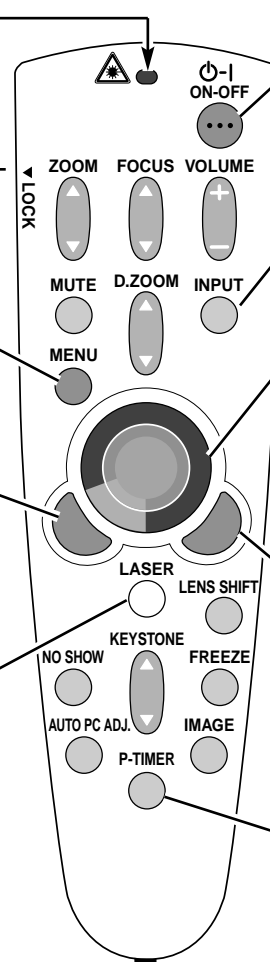

POWER ON-OFF BUTTON

Used to turn projector on or off. (P19)

INPUT BUTTON

Used to select input source. (P22)

POINT BUTTON

Used to move a pointer on ON-SCREEN MENU, adjust each item, or pan image in DIGITAL ZOOM +/- mode. (P29)
It is also used as a PC mouse in Wireless Mouse Operation. (P37)
* When pressing center of this button, it works as SELECT button.

RIGHT CLICK BUTTON

Used as a PC mouse in Wireless Mouse Operation. (P37)

P-TIMER BUTTON

Used to operate P-TIMER function. (P21)

LASER POINTER FUNCTION

This Remote Control Unit emits a laser beam as laser pointer function from Laser Light Window. When LASER button is pressed, laser light goes on. And when LASER button is being pressed for more than 1 minute or LASER button is released, light goes off. LASER POINTER INDICATOR lights RED and Laser is emitted with RED light to indicate laser beam is being emitted.

Laser emitted is a class II laser; therefore, do not look into Laser Light Window or shine laser beam on yourself or other people. Three marks below are caution labels for laser beam.

CAUTION : Use of controls, adjustments or performance of procedures other than those specified herein may result hazardous radiation exposure.

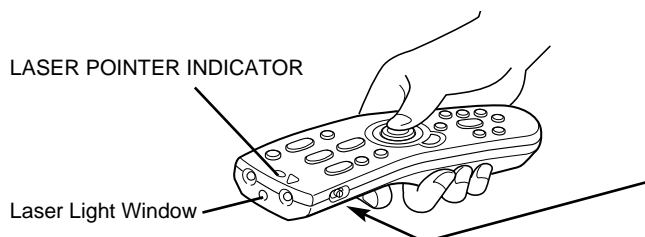

These caution labels are put on remote control.

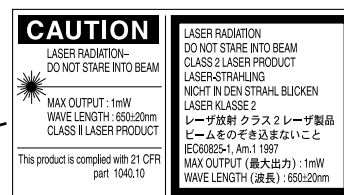

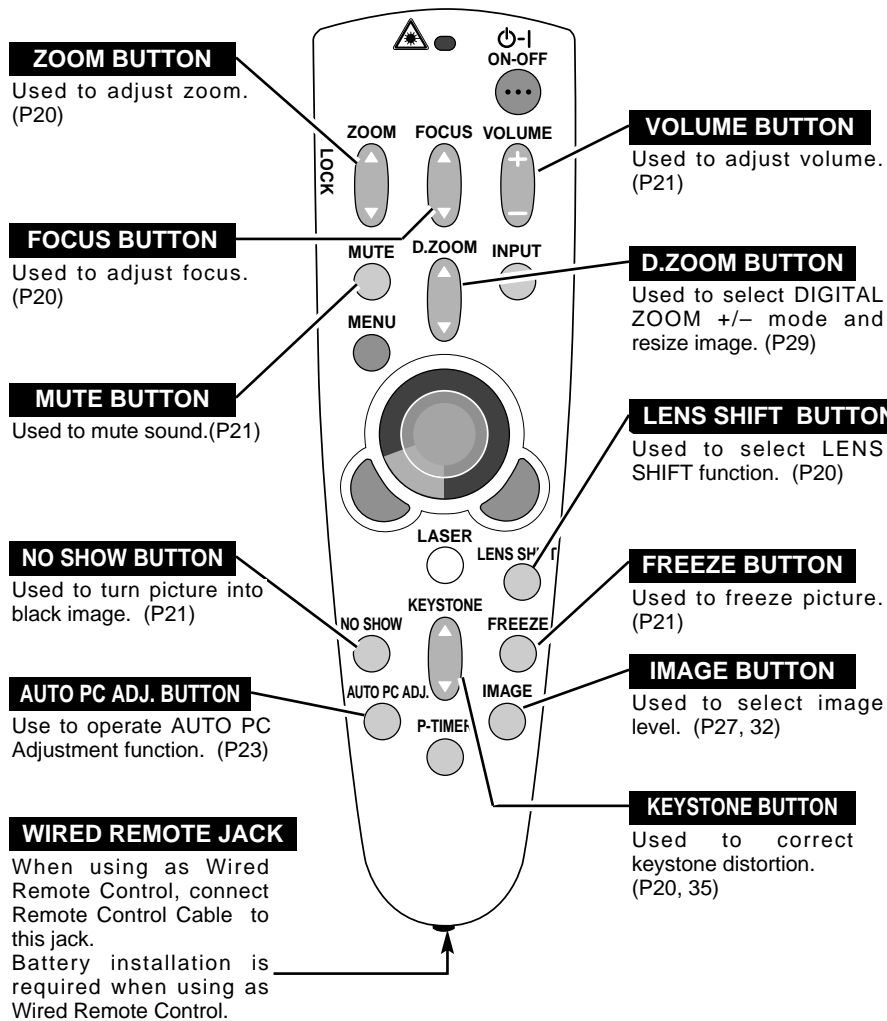

Operating Range

Point Remote Control Unit toward projector (Receiver Window) whenever pressing any button. Maximum operating range for Remote Control Unit is about 16.4' (5m) and 60° in front and rear of a projector.

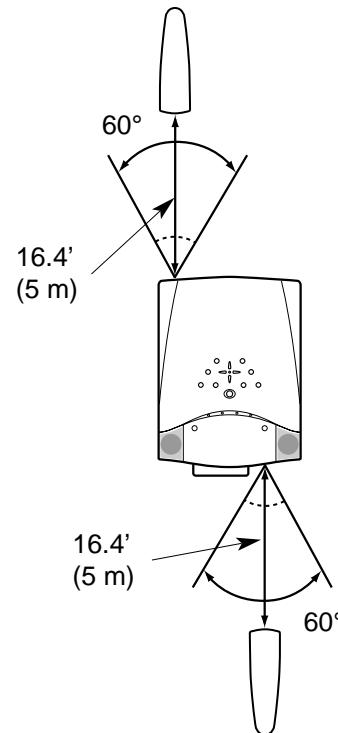

Remote Control Batteries Installation

1 Remove battery compartment lid.

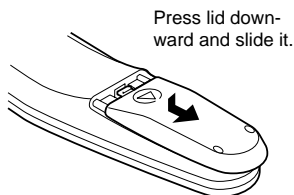

2 Slide batteries into compartment.

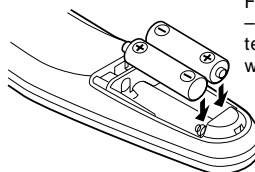

3 Replace compartment lid.

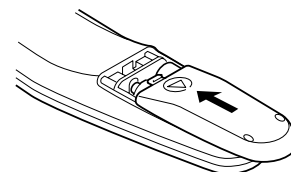

To insure safe operation, please observe following precautions :

- Use (2) AA, UM3 or R06 type alkaline batteries.
- Replace two batteries at same time.
- Do not use a new battery with an used battery.
- Avoid contact with water or liquid.
- Do not expose Remote Control Unit to moisture, or heat.
- Do not drop Remote Control Unit.
- If a battery has leaked on Remote Control Unit, carefully wipe case clean and install new batteries.
- Danger of explosion if battery is incorrectly replaced.
- Dispose of used batteries according to batteries manufacturers instructions and local rules.

TOP CONTROLS AND INDICATORS

This projector has CONTROL BUTTONS (TOP CONTROLS) and INDICATORS on its top.

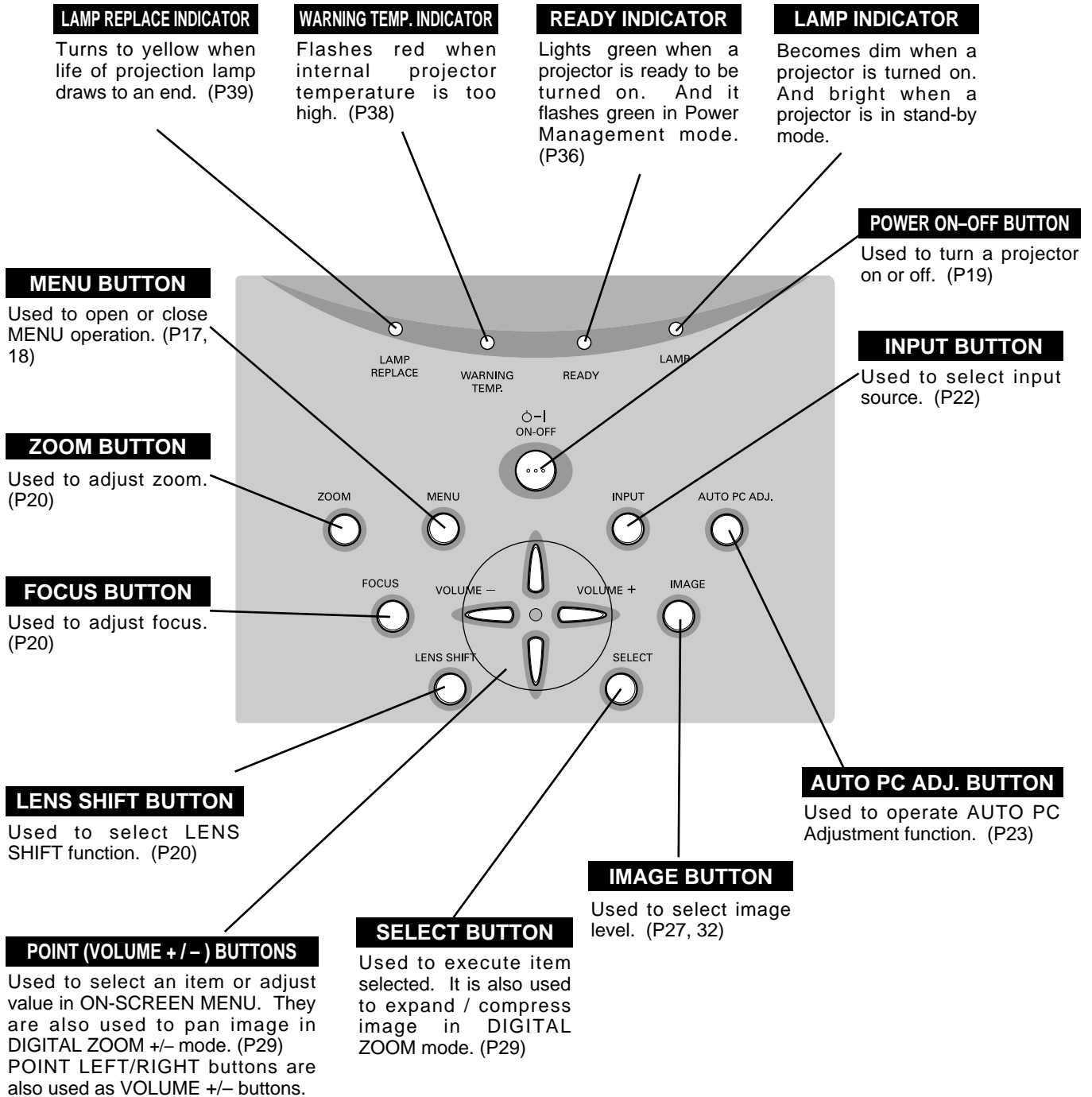

OPERATING ON-SCREEN MENU

HOW TO OPERATE ON-SCREEN MENU

You can control and adjust this projector through ON-SCREEN MENU. Refer to following pages to operate each adjustment on ON-SCREEN MENU.

1 DISPLAY MENU

Press MENU button to display ON-SCREEN MENU.

2 MOVING POINTER

Move pointer (* see below) or adjust value of item by pressing POINT button(s) on Top Control or on Remote Control Unit.

* Pointer is icon on ON-SCREEN MENU to select item. See figures on section "FLOW OF ON-SCREEN MENU OPERATION" below.

3 SELECT ITEM

Select item or set selected function by pressing SELECT button.

WIRELESS REMOTE CONTROL

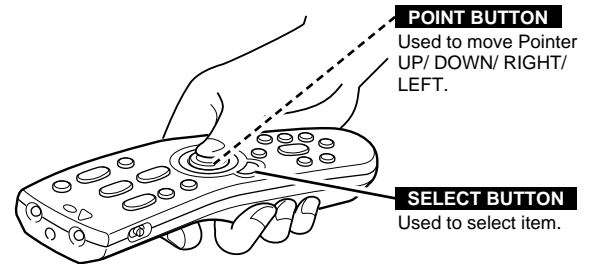

TOP CONTROL

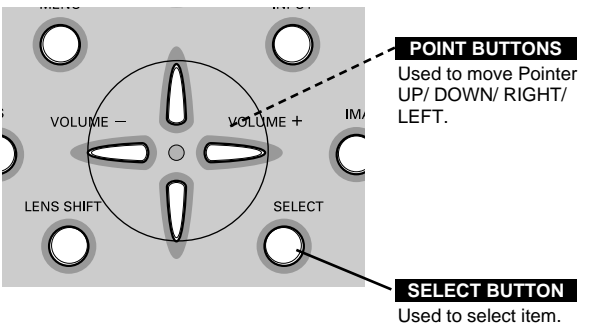

FLOW OF ON-SCREEN MENU OPERATION

Display ON-SCREEN MENU

1 Press MENU button to display ON-SCREEN MENU (MENU BAR). A red frame is POINTER.

Select Menu to be adjusted

2 Move POINTER (red frame) to MENU ICON that you want to select by pressing POINT RIGHT / LEFT buttons.

Control or adjust item through ON-SCREEN MENU

3 Press POINT DOWN button and move POINTER (red frame or red arrow) to ITEM that you want to adjust, and then press SELECT button to show ITEM DATA.

4 Adjust ITEM DATA by pressing POINT RIGHT / LEFT buttons. Refer to following pages for details of respective adjustments.

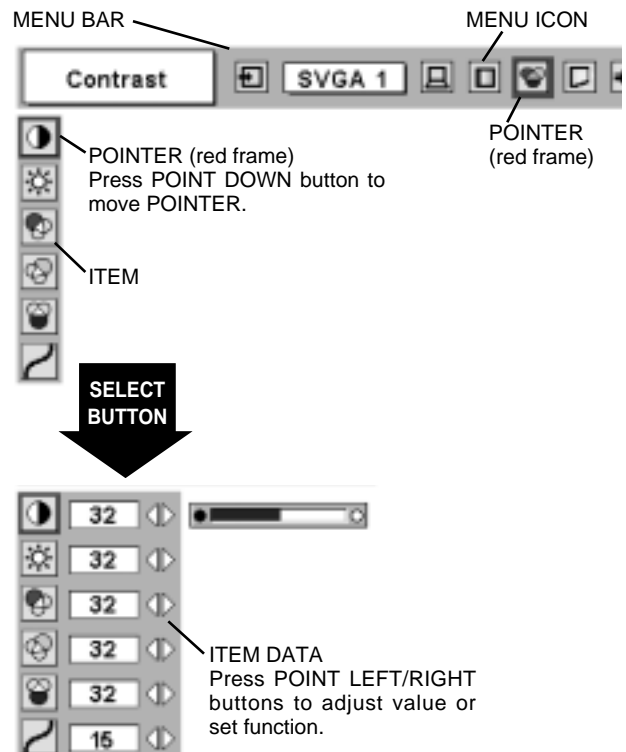

MENU BAR

FOR PC SOURCE

Press MENU BUTTON while connecting to PC input source.

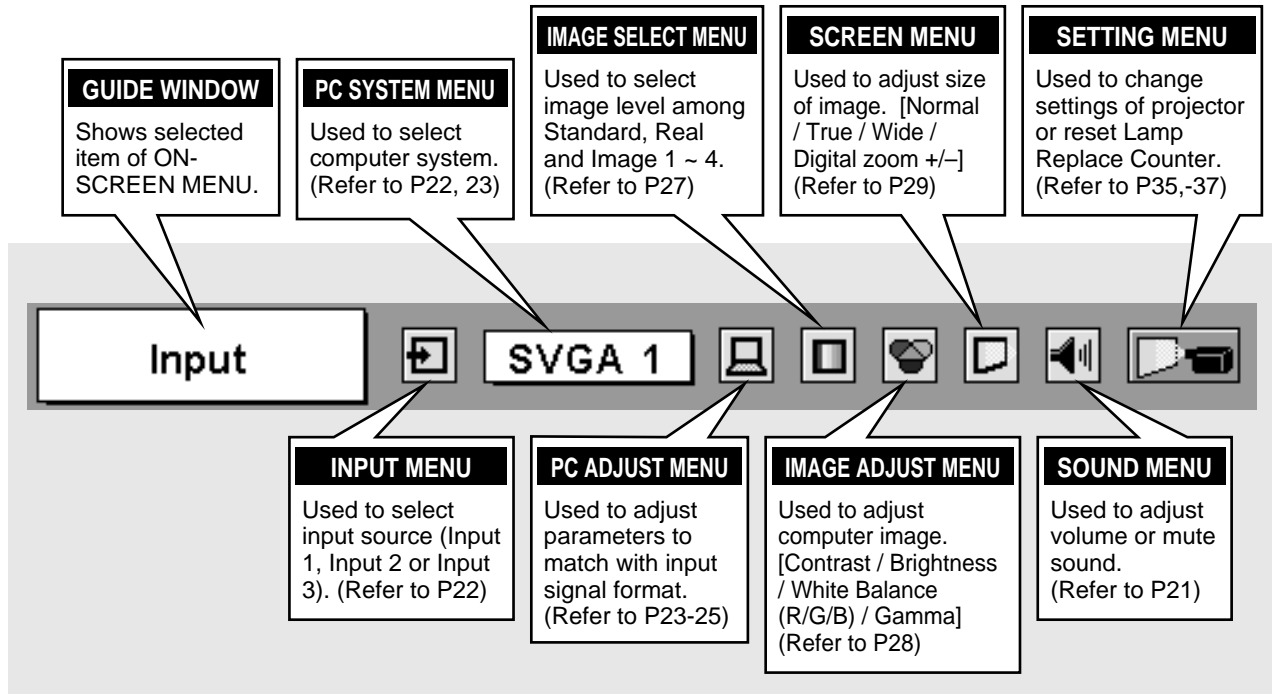

FOR VIDEO SOURCE

Press MENU BUTTON while connecting to VIDEO input source.

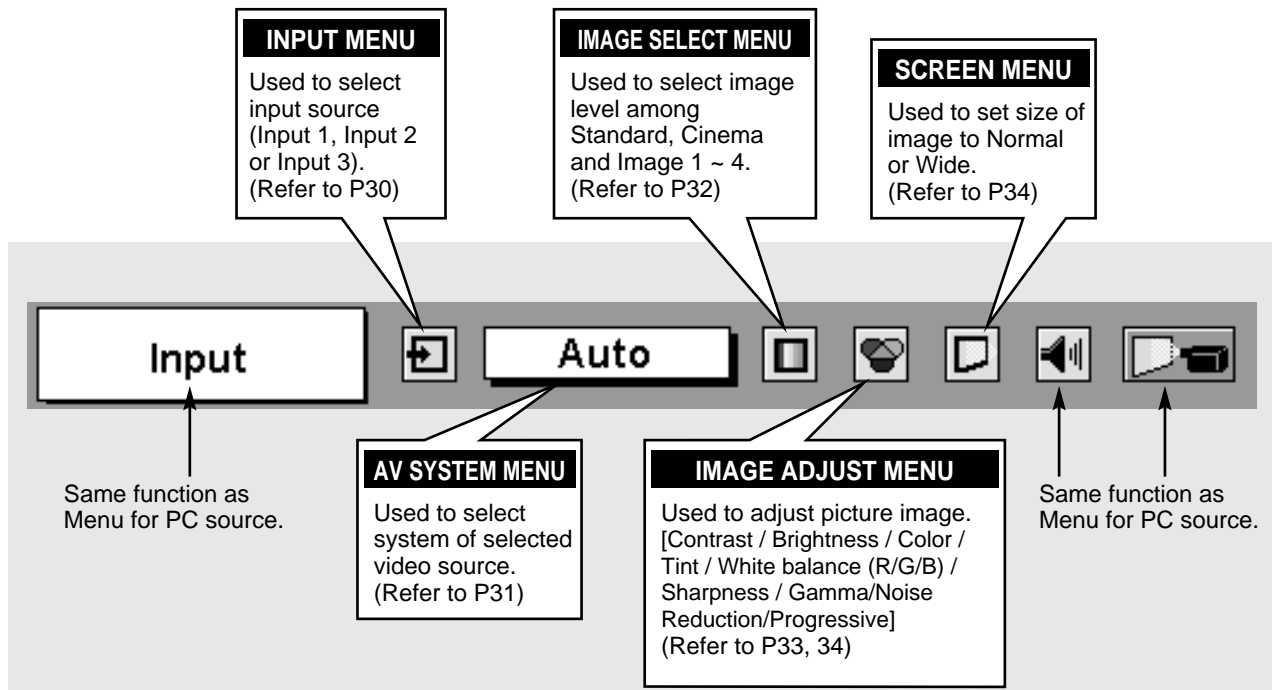

TURNING ON / OFF PROJECTOR

TURNING ON PROJECTOR

- 1** Complete peripheral connections (with Computer, VCR, etc.) before turning on projector. (Refer to "CONNECTING TO PROJECTOR" on pages 11~13 for connecting that equipment.)
- 2** Connect a projector's AC Power Cord into an AC outlet. LAMP Indicator lights RED, and READY Indicator lights GREEN.

NOTE : When "On start" function is ON, this projector is turned on automatically by connecting AC Power Cord to an AC outlet. (Refer to pages 35, 36.)
- 3** Press POWER ON-OFF button on Top Control or on Remote Control Unit to ON. LAMP Indicator dims, and Cooling Fans start to operate. Preparation Display appears on a screen and count-down appears. Signal from PC or Video source appears after 30 seconds.

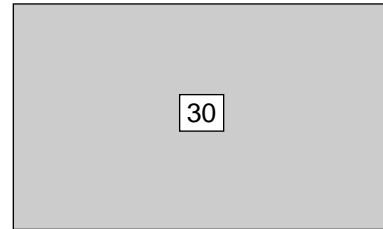

Preparation Display disappears after 30 seconds.

TURNING OFF PROJECTOR

- 1** Press POWER ON-OFF button on Top Control or on Remote Control Unit, and a message "Power off?" appears on a screen.
- 2** Press POWER ON-OFF button again to turn off projector. LAMP Indicator lights bright and READY Indicator turns off. After projector is turned off, Cooling Fans operate (for 90 seconds). During this "Cooling Down" period, this appliance cannot be turned on.
- 3** When projector has cooled down, READY Indicator lights GREEN again and you can turn projector on. After cooling down completely, disconnect AC Power Cord.

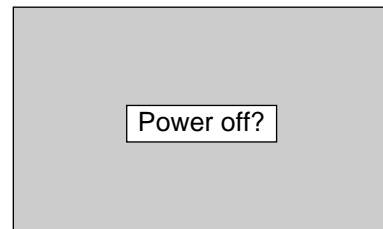

Message disappears after 4 seconds.



TO MAINTAIN LIFE OF LAMP, ONCE YOU TURN PROJECTOR ON, WAIT AT LEAST 5 MINUTES BEFORE TURNING IT OFF.

When "Power Management" function is ON, projector detects signal interruption and turns off Projection Lamp automatically. Refer to "Power Management" on pages 35 and 36.

When WARNING TEMP. Indicator flashes red, projector is automatically turned off. Wait at least 5 minutes before turning on projector again.

When WARNING TEMP. Indicator continues to flash, follow procedures below:

1. Press POWER ON-OFF button to turn a projector off and disconnect AC Power Cord from an AC outlet.
2. Check Air Filters for dust accumulation.
3. Clean Air Filters. (See "AIR FILTER CARE AND CLEANING" section on page 38.)
4. Turn a projector on again.

If WARNING TEMP. Indicator should still continue to flash, call Boxlight Corporation at 1-800-762-5757 or 360-779-7901.

ADJUSTING SCREEN

ZOOM ADJUSTMENT

- 1 Press ZOOM button on Top Control or ZOOM ▲/▼ button on Remote Control Unit. Message "Zoom" is displayed.
- 2 Press ZOOM ▲ button or POINT UP button to make image larger, and press ZOOM ▼ button or POINT DOWN button to make image smaller.

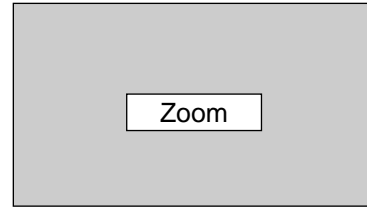

Message disappears after 4 seconds.

FOCUS ADJUSTMENT

- 1 Press FOCUS button on Top Control or FOCUS ▲/▼ button on Remote Control Unit. Message "Focus" is displayed.
- 2 Adjust focus of image by pressing FOCUS ▲/▼ button or POINT UP/DOWN button(s).

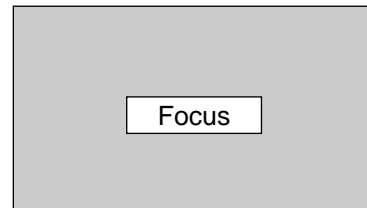

Message disappears after 4 seconds.

LENS SHIFT ADJUSTMENT

- 1 Press LENS SHIFT button on Top Control or on Remote Control Unit. Message "Lens shift" is displayed.
- 2 Press POINT UP button to move image up, press POINT DOWN button to move image down.

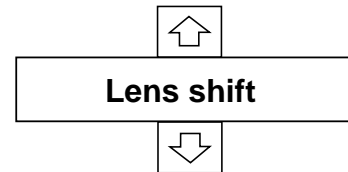

Message disappears after 4 seconds.

KEYSTONE ADJUSTMENT

If a projected picture has keystone distortion, correct image with KEYSTONE adjustment.

- 1 Press KEYSTONE ▲/▼ button on Remote Control Unit or select Keystone on SETTING menu. (Refer to page 35.) Keystone dialog box appears.
- 2 Correct keystone distortion by pressing KEYSTONE ▲/▼ button or POINT UP/DOWN button(s). Press KEYSTONE ▲ button or POINT UP button to reduce upper part of image, and press KEYSTONE ▼ button or POINT DOWN button to reduce lower part.



Reduce upper width with KEY STONE ▲ button or POINT UP button.

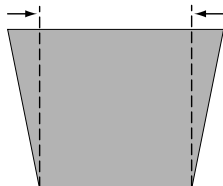

Reduce lower width with KEY STONE ▼ button or POINT DOWN button.

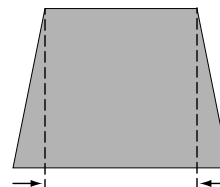

PICTURE FREEZE FUNCTION

Press FREEZE button on Remote Control Unit to freeze picture on-screen. To cancel FREEZE function, press FREEZE button again or press any other button except POINT / SELECT / RIGHT CLICK / P-TIMER / LASER button.

NO SHOW FUNCTION

Press NO SHOW button on Remote Control Unit to black out image. To restore to normal, press NO SHOW button again or press any other button except POINT / SELECT / RIGHT CLICK / P-TIMER / LASER button.

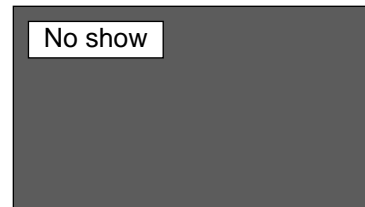

Message disappears after 4 seconds.

P-TIMER FUNCTION

Press P-TIMER button on Remote Control unit. Timer display "00 : 00" appears on screen and timer starts to count time (00 : 00 ~ 59 : 59). To stop P-TIMER display, press P-TIMER button. And then, press P-TIMER button again to cancel P-TIMER function.



SOUND ADJUSTMENT

DIRECT OPERATION

Volume

Press VOLUME (+/-) button(s) on Top Control or on Remote Control Unit to adjust volume. Volume dialog box appears on screen for a few seconds.

(+) button to increase volume, and (-) button for decreasing.

Mute

Press MUTE button on Remote Control Unit to cut off sound. To restore sound to its previous level, press MUTE button again or press Volume (+/-) button(s).

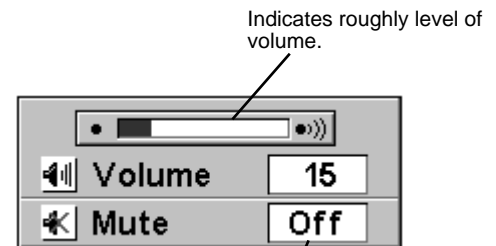

Indicates roughly level of volume.

Press MUTE button to set Mute function On or Off.

Display disappears after 4 seconds.

MENU OPERATION

1 Press MENU button and ON-SCREEN MENU will appear. Press POINT LEFT/RIGHT buttons to move a red frame pointer to SOUND Menu icon.

2 Press POINT DOWN button to move a red frame pointer to item that you want to select, and then press SELECT button.

Volume

To increase volume, press POINT RIGHT button, and press POINT LEFT button for decreasing.

Mute

Press POINT LEFT/RIGHT button(s) to cut off sound. Dialog box display is changed to "On" and sound is cut off. To restore sound to its previous level, press POINT LEFT/RIGHT button(s) again.

SOUND MENU

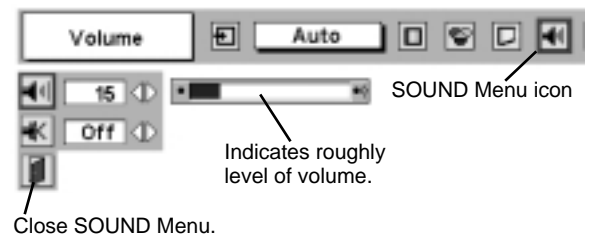

Indicates roughly level of volume.

Close SOUND Menu.

COMPUTER INPUT

SELECTING INPUT SOURCE

DIRECT OPERATION

Choose Computer by pressing INPUT button on Top Control or on Remote Control Unit.

If projector cannot reproduce proper image, select correct input source through MENU OPERATION (see below).

INPUT button

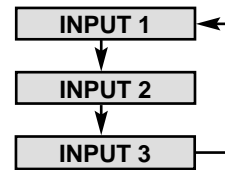

MENU OPERATION

1 Press MENU button and ON-SCREEN MENU will appear. Press POINT LEFT/RIGHT buttons to select Input and press SELECT button. Another dialog box INPUT SELECT Menu will appear.

2 Press POINT DOWN button and a red-arrow icon will appear. Move arrow to INPUT source that you want to select, and then press SELECT button.

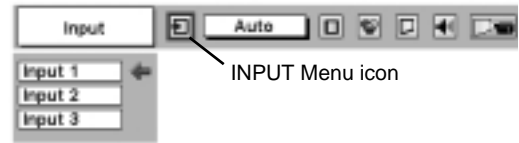

SELECTING COMPUTER SYSTEM

WHEN SELECT INPUT 1 (COMPUTER INPUT TERMINALS)

1 Press MENU button and ON-SCREEN MENU will appear. Press POINT LEFT/RIGHT button to move a red frame pointer to INPUT Menu icon.

2 Press POINT DOWN button to move a red arrow pointer to Input 1 and then press SELECT button. Source Select Menu will appear.

3 Move a pointer to either Digital or Analog and then press SELECT button.

Digital When your computer is connected to COMPUTER INPUT (DIGITAL) terminal, select RGB (Digital).

Analog When your computer is connected to COMPUTER INPUT (ANALOG) terminal, select RGB (Analog).

INPUT MENU

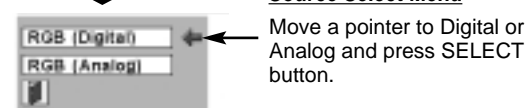
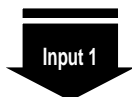
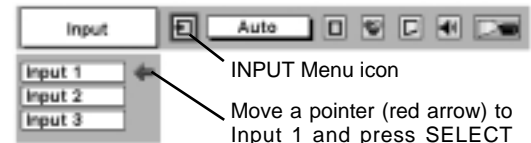

WHEN SELECT INPUT 2 (5 BNC INPUT JACKS)

When connect a computer output [5 BNC Type (Green, Blue, Red, Horiz. Sync and Vert. Sync.)] from a computer to G, B, R, H/HV and V jacks.

1 Press MENU button and ON-SCREEN MENU will appear. Press POINT LEFT/RIGHT button to move a red frame pointer to INPUT Menu icon.

2 Press POINT DOWN button to move a red arrow pointer to Input 2 and then press SELECT button. Source Select Menu will appear.

3 Press POINT DOWN button and a red-arrow icon will appear. Move arrow to "RGB", and then press SELECT button.

INPUT MENU

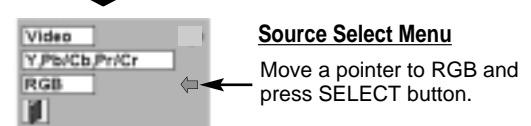
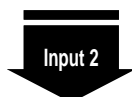
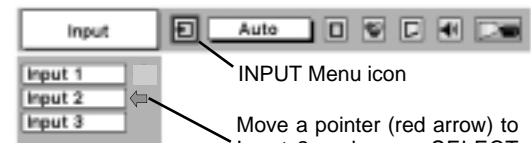

AUTOMATIC MULTI-SCAN SYSTEM

This projector automatically tunes to most different types of computers based on VGA, SVGA, XGA or SXGA (refer to "COMPATIBLE COMPUTER SPECIFICATION" on page 26). When selecting Computer, this projector automatically tunes to incoming signal and projects proper image without any special setting. (Some computers need setting manually.)

Note : Projector may display one of following messages.

Auto When projector cannot recognize connected signal as PC system provided in this projector, Auto PC Adjustment function operates to adjust projector and message "Auto" is displayed on SYSTEM Menu icon. When image is not provided properly, manual adjustment is required. (Refer to P24 and 25.)

--- There is no signal input from computer. Make sure connection of computer and a projector is set correctly. (Refer to TROUBLESHOOTING on page 40.)

D-VGA, D-SVGA or D-XGA

When digital computer signal is received on DVI terminal, above message is displayed on PC SYSTEM Menu icon.

SELECT COMPUTER SYSTEM MANUALLY

This projector automatically selects PC system among those provided in this projector and PC system can be also selected manually.

- 1 Press MENU button and ON-SCREEN MENU will appear. Press POINT LEFT/RIGHT buttons to move a red frame pointer to PC SYSTEM Menu icon.
- 2 Press POINT DOWN button to move a red arrow pointer to system that you want to set, and then press SELECT button.

PC SYSTEM MENU

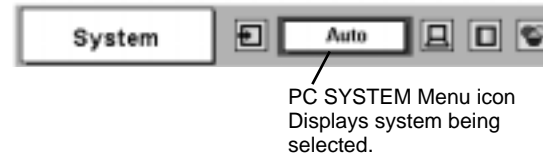

PC SYSTEM MENU

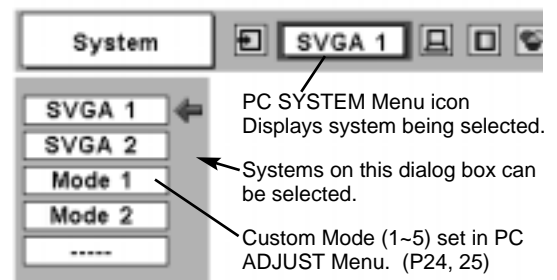

PC ADJUSTMENT

AUTO PC ADJUSTMENT

Auto PC Adjustment function is provided to automatically adjust Fine sync, Total dots and Picture Position to conform to your computer. Auto PC Adjustment function can be operated as follows.

Auto PC Adj.

- 1 Press MENU button and ON-SCREEN MENU will appear. Press POINT LEFT/RIGHT button to move a red frame pointer to PC ADJUST Menu icon.
- 2 Press POINT DOWN button to move a red frame pointer to AUTO PC Adj. icon and then press SELECT button twice. This Auto PC Adjustment can be also executed by pressing AUTO PC ADJ. button on Remote Control Unit.

Store adjustment parameters.

Adjustment parameters from Auto PC Adjustment can be memorized in this projector. Once parameters are memorized, setting can be done just by selecting Mode in PC SYSTEM Menu (P23). Refer to step 3 of MANUAL PC ADJUSTMENT section (P25).

NOTE

- Fine sync, Total dots and Picture Position of some computers can not be fully adjusted with this Auto PC Adjustment function. When image is not provided properly through this function, manual adjustments are required. (Refer to page 24, 25.)
- Auto PC Adjustment function cannot be operated in Digital Signal input on DVI terminal and "RGB", "720p (HDTV)", "1035i (HDTV)" or "1080i (HDTV)" is selected on PC SYSTEM Menu.

PC ADJUST MENU

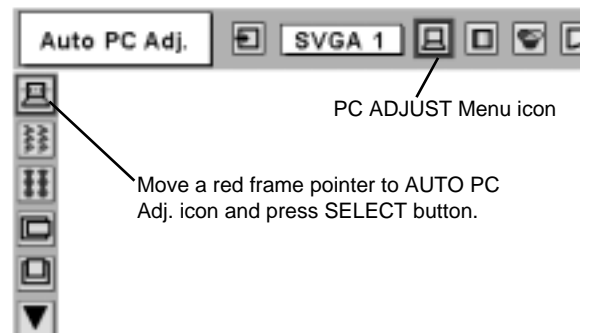

MANUAL PC ADJUSTMENT

This projector can automatically tune to display signals from most personal computers currently distributed. However, some computers employ special signal formats which are different from standard ones and may not be tuned by Multi-Scan system of this projector. If this happens, projector cannot reproduce a proper image and image may be recognized as a flickering picture, a non-synchronized picture, a non-centered picture or a skewed picture.

This projector has a Manual PC Adjustment to enable you to precisely adjust several parameters to match with those special signal formats. This projector has 5 independent memory areas to memorize those parameters manually adjusted. This enables you to recall setting for a specific computer whenever you use it.

Note : This PC ADJUST Menu cannot be operated when in digital signal input on DVI terminal and "RGB" is selected on PC SYSTEM MENU (P23).

- 1 Press MENU button and ON-SCREEN MENU will appear. Press POINT LEFT/RIGHT button to move a red frame pointer to PC ADJUST Menu icon.
- 2 Press POINT DOWN button to move a red frame pointer to item that you want to adjust and then press SELECT button. Adjustment dialog box will appear. Press POINT LEFT/RIGHT button to adjust value.



Fine sync

Adjusts an image as necessary to eliminate flicker from display. Press POINT LEFT/RIGHT button to adjust value.(From 0 to 31.)



Total dots

Number of total dots in one horizontal period. Press POINT LEFT/RIGHT button(s) and adjust number to match your PC image.



Horizontal

Adjusts horizontal picture position. Press POINT LEFT/RIGHT button(s) to adjust position.



Vertical

Adjusts vertical picture position. Press POINT LEFT/RIGHT button(s) to adjust position.



Current mode

Press SELECT button to show information of computer selected.



Clamp

Adjusts clamp position. When image has a dark bar(s), try this adjustment.

PC ADJUST MENU

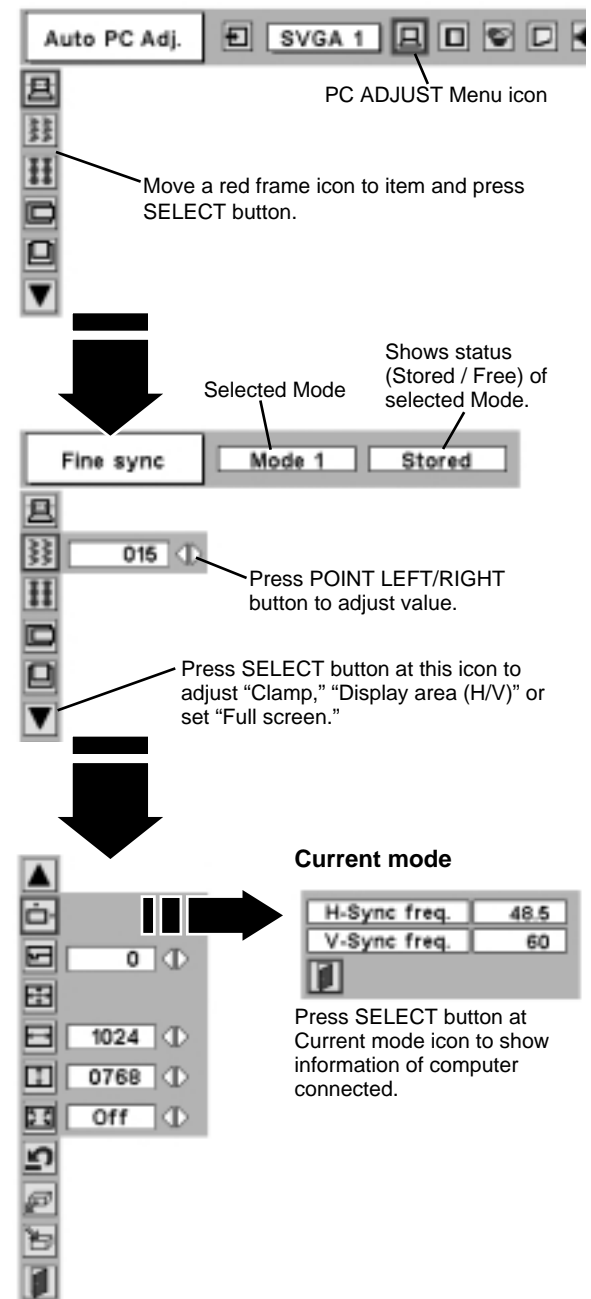

 **Display area**

Selects area displayed with this projector. Select resolution at Display area dialog box.

 **Display area H**

Adjustment of horizontal area displayed with this projector. Press POINT LEFT/RIGHT button(s) to decrease/increase value and then press SELECT button.

 **Display area V**

Adjustment of vertical area displayed with this projector. Press POINT LEFT/RIGHT button(s) to decrease/increase value and then press SELECT button.

 **Full screen**

Press POINT LEFT/RIGHT button(s) to switch Full screen function to "On" or "Off." Set "On" to resize image with 4 x 3 aspect ratio to fit screen.

NOTE : Display area (H/V) and Full screen cannot be adjusted when "1035i (HDTV)" or "1080i (HDTV)" is selected on PC SYSTEM Menu (P23).

3  **Store**

To store adjustment parameters, move a red frame pointer to Store icon and then press SELECT button. Move a red arrow pointer to any of Mode 1 to 5 that you want to store and then press SELECT button.

 **Mode free**

To clear adjustment parameters previously set, move a red frame pointer to Mode free icon and then SELECT button. Move a red arrow pointer to Mode that you want to clear and then press SELECT button.

Other icons operates as follows.

 **Reset**

Reset all adjust parameters on adjustment dialog box to previous figure.

 **Quit**

Closes PC ADJUST MENU.

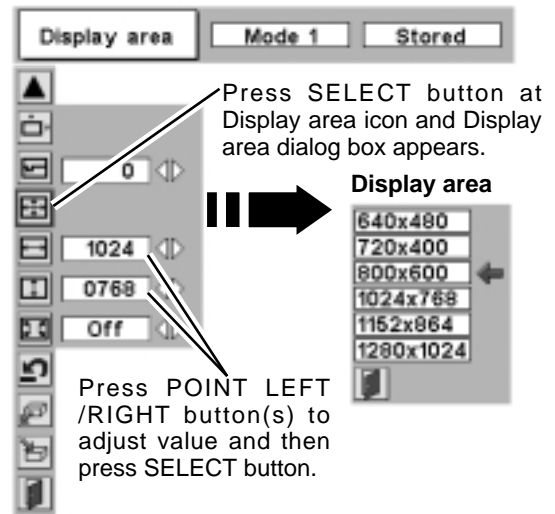

To store adjustment data.

This Mode has parameters being stored.

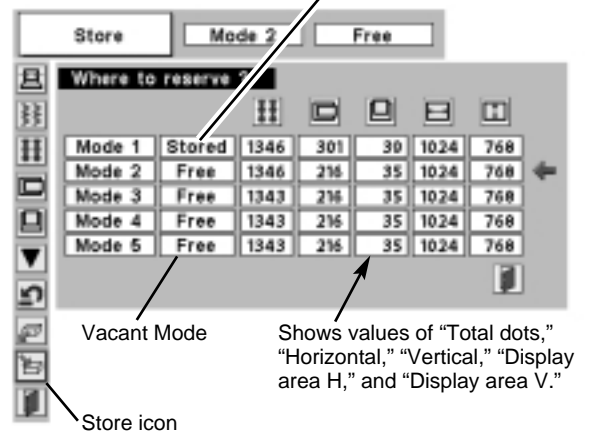

To clear adjustment data.

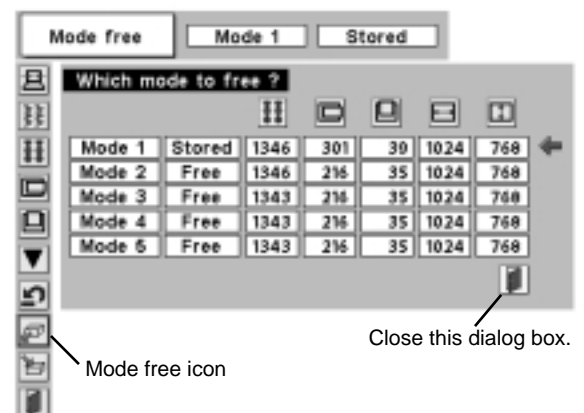

COMPATIBLE COMPUTER SPECIFICATIONS

Basically this projector can accept a signal from all computers with V, H-Frequency mentioned below and less than 160 MHz of Dot Clock.

ON-SCREEN DISPLAY	RESOLUTION	H-Freq. (kHz)	V-Freq. (Hz)	ON-SCREEN DISPLAY	RESOLUTION	H-Freq. (kHz)	V-Freq. (Hz)
VGA 1	640 x 480	31.47	59.88	XGA 10	1024 x 768	62.04	77.07
VGA 2	720 x 400	31.47	70.09	XGA 11	1024 x 768	61.00	75.70
VGA 3	640 x 400	31.47	70.09	XGA 12	1024 x 768 (Interlace)	35.522	43.48
VGA 4	640 x 480	37.86	74.38	XGA 13	1024 x 768	46.90	58.20
VGA 5	640 x 480	37.86	72.81	XGA 14	1024 x 768	47.00	58.30
VGA 6	640 x 480	37.50	75.00	XGA15	1024 x 768	58.03	72.0
VGA 7	640 x 480	43.269	85.00	MAC 19	1024 x 768	60.24	75.08
MAC LC13	640 x 480	34.97	66.60	MAC 21	1152 x 870	68.68	75.06
MAC 13	640 x 480	35.00	66.67	SXGA 1	1152 x 864	64.20	70.40
RGB	(Interlace)	15.734	30	SXGA 2	1280 x 1024	62.50	58.60
RGB	(Interlace)	15.625	25	SXGA 3	1280 x 1024	63.90	60.00
SVGA 1	800 x 600	35.156	56.25	SXGA 4	1280 x 1024	63.34	59.98
SVGA 2	800 x 600	37.88	60.32	SXGA 5	1280 x 1024	63.74	60.01
SVGA 3	800 x 600	46.875	75.00	SXGA 6	1280 x 1024	71.69	67.19
SVGA 4	800 x 600	53.674	85.06	SXGA 7	1280 x 1024	81.13	76.107
SVGA 5	800 x 600	48.08	72.19	SXGA 8	1280 x 1024	63.98	60.02
SVGA 6	800 x 600	37.90	61.03	SXGA 9	1280 x 1024	79.976	75.025
SVGA 7	800 x 600	34.50	55.38	SXGA 10	1280 x 960	60.00	60.00
SVGA 8	800 x 600	38.00	60.51	SXGA 11	1152 x 900	61.20	65.20
SVGA 9	800 x 600	38.60	60.31	SXGA 12	1152 x 900	71.40	75.60
SVGA 10	800 x 600	32.70	51.09	SXGA 13	1280 x 1024 (Interlace)	50.00	43.00
SVGA 11	800 x 600	38.00	60.51	SXGA 14	1280 x 1024 (Interlace)	50.00	47.00
MAC 16	832 x 624	49.72	74.55	SXGA 15	1280 x 1024	63.37	60.01
XGA 1	1024 x 768	48.36	60.00	SXGA 16	1280 x 1024	76.97	72.00
XGA 2	1024 x 768	68.677	84.997	SXGA 17	1152 x 900	61.85	66.00
XGA 3	1024 x 768	60.023	75.03	SXGA 18	1280 x 1024 (Interlace)	46.43	43.35
XGA 4	1024 x 768	56.47	70.07	SXGA 19	1280 x 1024	63.79	60.18
XGA 5	1024 x 768	60.31	74.92	MAC	1280 x 960	75.00	75.08
XGA 6	1024 x 768	48.50	60.02	MAC	1280 x 1024	80.00	75.08
XGA 7	1024 x 768	44.00	54.58	720p (HDTV)	(Progressive)	45.00	60.00
XGA 8	1024 x 768	63.48	79.35	1035i (HDTV)	(Interlace)	33.75	30.00
XGA 9	1024 x 768 (Interlace)	36.00	43.59	1080i (HDTV)	(Interlace)	33.75	30.00

When a input signal is digital from DVI terminal, refer to chart below.

ON-SCREEN DISPLAY	RESOLUTION	H-Freq. (kHz)	V-Freq. (Hz)	ON-SCREEN DISPLAY	RESOLUTION	H-Freq. (kHz)	V-Freq. (Hz)
D-VGA	640 x 480	31.469	59.940	D-XGA	1024 x 768	48.363	60.004
D-SVGA	800 x 600	37.879	60.317				

NOTE : Specifications are subject to change without notice.

PICTURE IMAGE ADJUSTMENTS

IMAGE LEVEL SELECT (DIRECT)

Select image level among Standard, Real, Image 1, Image 2, Image 3 and Image 4 by pressing IMAGE button on Top Control or on Remote Control Unit.

Standard

Normal picture level preset on this projector.

Real

Picture level with improved halftone for graphics.

IMAGE 1~4

User preset picture adjustment in IMAGE ADJUST Menu (P28).

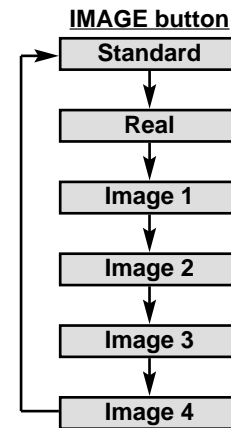

IMAGE LEVEL SELECT (MENU)

- 1 Press MENU button and ON-SCREEN MENU will appear. Press POINT LEFT/RIGHT button to move a red frame pointer to IMAGE SELECT Menu icon.
- 2 Press POINT DOWN button to move a red frame pointer to level that you want to set and then press SELECT button.

Standard

Normal picture level preset on this projector.

Real

Picture level with improved halftone for graphics.

IMAGE 1~4

User preset picture adjustment in IMAGE ADJUST Menu (P28).

IMAGE SELECT MENU

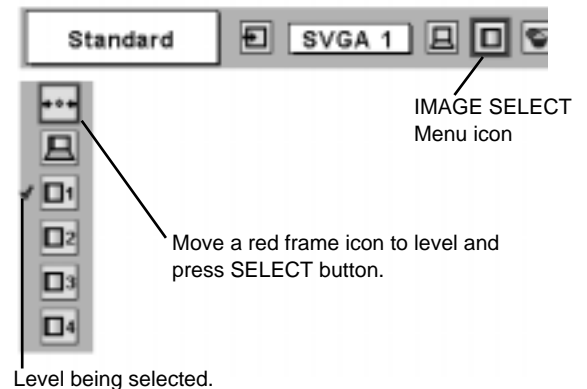

IMAGE LEVEL ADJUSTMENT

- 1 Press MENU button and ON-SCREEN MENU will appear. Press POINT LEFT/RIGHT buttons to move a red frame pointer to IMAGE ADJUST Menu icon.
- 2 Press POINT DOWN button to move a red frame pointer to item that you want to adjust and then press SELECT button. Level of each item is displayed. Adjust each level by pressing POINT LEFT/RIGHT button(s).

Contrast

Press POINT LEFT button to decrease contrast, and POINT RIGHT button to increase contrast. (From 0 to 63.)

Brightness

Press POINT LEFT button to adjust image darker, and POINT RIGHT button to adjust brighter. (From 0 to 63.)

White balance (Red)

Press POINT LEFT button to lighten red tone and POINT RIGHT button to deeper tone. (From 0 to 63.)

White balance (Green)

Press POINT LEFT button to lighten green tone and POINT RIGHT button to deeper tone. (From 0 to 63.)

White balance (Blue)

Press POINT LEFT button to lighten blue tone and POINT RIGHT button to deeper tone. (From 0 to 63.)

Gamma

Press either POINT LEFT button or POINT RIGHT button to obtain better balance of contrast. (From 0 to 15.)

3 **Store**

To store manually preset image, move a red frame pointer to Store icon and press SELECT button. Image Level Menu will appear. Move a red frame pointer to Image 1 to 4 where you want to set and then press SELECT button.

Other icons operates as follows.

Reset

Reset all adjustment to previous figure.

Quit

Closes IMAGE MENU.

IMAGE ADJUST MENU

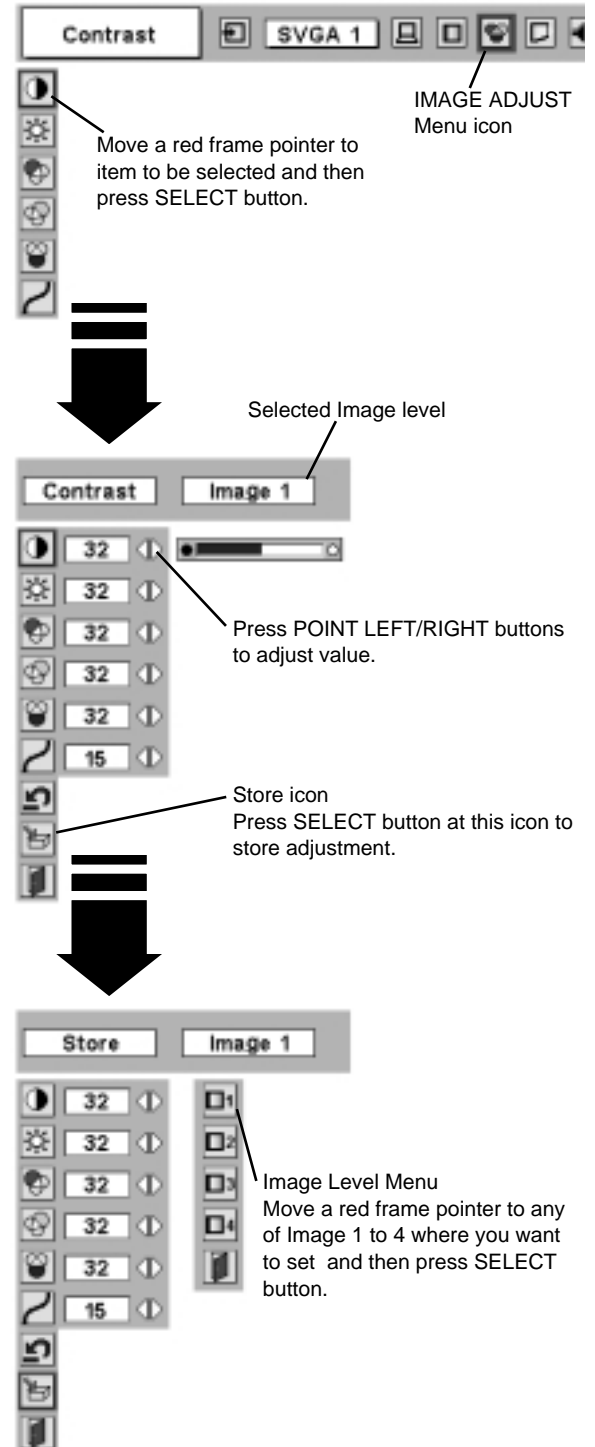

PICTURE SCREEN ADJUSTMENT

This projector has a picture screen resize function, which enables you to display desirable image size.

- 1 Press MENU button and ON-SCREEN MENU will appear. Press POINT LEFT/RIGHT button(s) to move a red frame pointer to SCREEN Menu icon.
- 2 Press POINT DOWN button and move a red frame pointer to function that you want to select and then press SELECT button.



Normal

Provides image to fit screen size.



True

Provides image in its original size. When original image size is larger than screen size (1024 x 768), this projector enters "Digital zoom +" mode automatically.



Wide

Provides image to fit wide video aspect ratio (16 : 9) by expanding image width uniformly. This function can be used for providing a squeezed video signal at 16 : 9.



Digital zoom +

When Digital zoom + is selected, ON-SCREEN MENU disappears and message "D. Zoom +" is displayed. Press SELECT button to expand image size. And press POINT UP/DOWN/LEFT/RIGHT button(s) to pan image. Panning function can work only when image is larger than screen size.

A projected image can be also expanded by pressing D.ZOOM ▲ button on Remote Control Unit.



Digital Zoom -

When Digital zoom - is selected, ON-SCREEN MENU disappears and message "D. Zoom -" is displayed. Press SELECT button to compress image size.

A projected image can be also compressed by pressing D.ZOOM ▼ button on Remote Control Unit.

To cancel Digital Zoom +/- mode, press any button except D.ZOOM ▲/▼, SELECT, POINT and AUTO PC ADJ. buttons.

SCREEN MENU

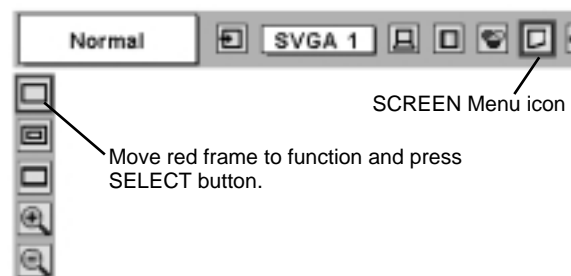

NOTE

- True and Digital zoom +/- cannot be operated when "RGB", "1035i (HDTV)" or "1080i (HDTV)" is selected on PC SYSTEM Menu (P23).
- Wide cannot be selected when "720p (HDTV)", "1035i (HDTV)" or "1080i (HDTV)" is selected on PC SYSTEM Menu (P23).
- This projector cannot display any resolution higher than 1280 X 1024. If your computer's screen resolution is higher than 1280 X 1024, reset resolution to lower before connecting projector.
- Image data in other than XGA (1024 x 768) is modified to fit screen size in initial mode.
- Panning function may not operate properly if computer system prepared on PC ADJUST Menu is used.

SELECTING INPUT SOURCE

WHEN SELECT INPUT 2 (5 BNC INPUT JACKS)

When connecting to those equipment, select a type of Video source in SOURCE SELECT Menu.

- 1 Press MENU button and ON-SCREEN MENU will appear. Press POINT LEFT/RIGHT button to move a red frame pointer to INPUT Menu icon.
- 2 Press POINT DOWN button to move a red arrow pointer to Input 2 and then press SELECT button. Source Select Menu will appear.
- 3 Move a pointer to source that you want to select and then press SELECT button.

Video When video input signal is connected to VIDEO jack, select Video.

Y,Pb/Cb,Pr/Cr When video input signal is connected to Y-Pb/Cb-Pr/Cr jacks, select Y, Pb/Cb, Pr/Cr.

INPUT MENU

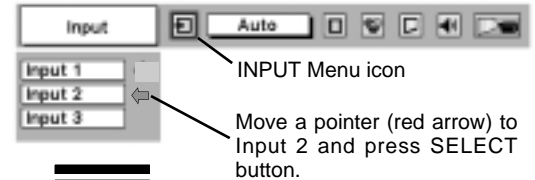

Source Select Menu

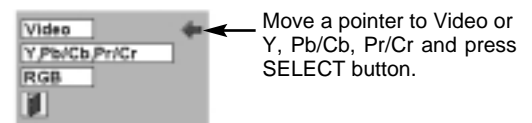

WHEN SELECT INPUT 3 (AV TERMINALS)

When connecting to those equipment, select a type of Video source in SOURCE SELECT (VIDEO) Menu.

- 1 Press MENU button and ON-SCREEN MENU will appear. Press POINT LEFT/RIGHT button to move a red frame pointer to INPUT Menu icon.
- 2 Press POINT DOWN button to move a red arrow pointer to Input 3 and then press SELECT button. Source Select Menu will appear.
- 3 Move a pointer to source that you want to select and then press SELECT button.

Video When video input signal is connected to VIDEO jack, select Video.

Y,Pb/Cb,Pr/Cr When video input signal is connected to Y-Pb/Cb-Pr/Cr jacks, select Y, Pb/Cb, Pr/Cr.

S-Video When video input signal is connected to S-VIDEO jack, select S-Video.

INPUT MENU

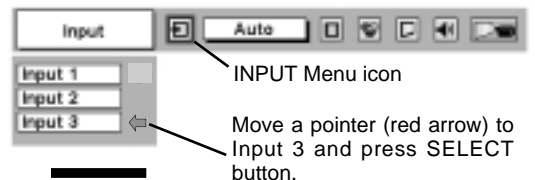

Source Select Menu (VIDEO)

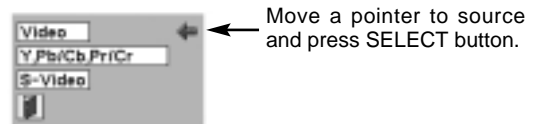

SELECTING VIDEO SYSTEM

- 1 Press MENU button and ON-SCREEN MENU will appear. Press POINT LEFT/RIGHT buttons to move a red frame pointer to AV SYSTEM Menu icon.
- 2 Press POINT DOWN button to move a red arrow pointer to system that you want to select and then press SELECT button.

VIDEO JACK OR S-VIDEO JACK

Auto

Projector automatically detects incoming Video system, and adjusts itself to optimize its performance.

When Video System is PAL-M or PAL-N, select system manually first.

PAL / SECAM / NTSC / NTSC4.43 / PAL-M / PAL-N

If projector cannot reproduce proper video image, it is necessary to select a specific broadcast signal format among PAL, SECAM, NTSC, NTSC 4.43, PAL-M, and PAL-N.

Y, Pb/Cb, Pr/Cr JACKS

Auto

Projector automatically detects incoming Video signal, and adjusts itself to optimize its performance.

When Video System is 1035i or 1080i, select system manually first.

COMPONENT VIDEO SIGNAL FORMAT

If projector cannot reproduce proper video image, it is necessary to select a specific component video signal format among 480i, 575i, 480p, 575p, 720p, 1035i and 1080i.

AV SYSTEM MENU (VIDEO OR S-VIDEO)

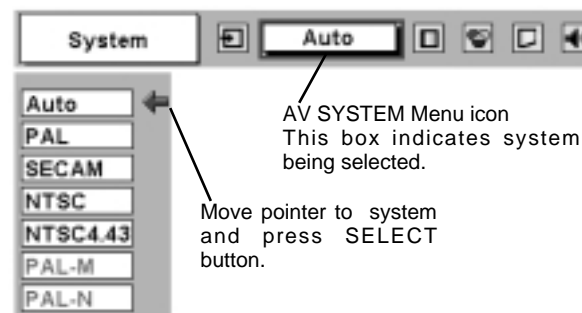

AV SYSTEM MENU (COMPONENT VIDEO)

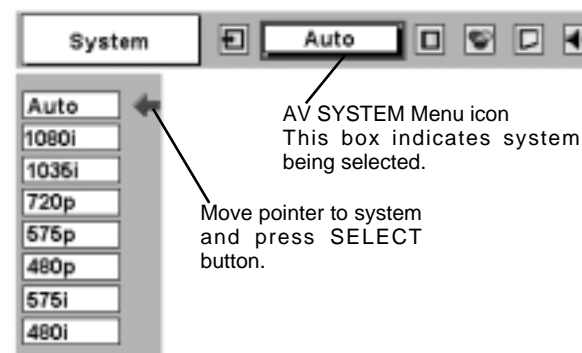

PICTURE IMAGE ADJUSTMENTS

IMAGE LEVEL SELECT (DIRECT)

Select image level among Standard, Cinema, Image 1, Image 2, Image 3 and Image 4 by pressing IMAGE button on Top Control or on Remote Control Unit.

Standard

Normal picture level preset on this projector.

Cinema

Picture level adjusted for picture with fine tone.

IMAGE 1~4

User preset picture adjustment in IMAGE ADJUST Menu (P34).



IMAGE LEVEL SELECT (MENU)

1 Press MENU button and ON-SCREEN MENU will appear. Press POINT LEFT/RIGHT button to move a red frame pointer to IMAGE SELECT Menu icon.

2 Press POINT DOWN button to move a red frame pointer to level that you want to set and then press SELECT button.

 **Standard**

Normal picture level preset on this projector.

 **Cinema**

Picture level adjusted for picture with fine tone.

 **IMAGE 1~4**

User preset picture adjustment in IMAGE ADJUST Menu (P34).

IMAGE SELECT MENU

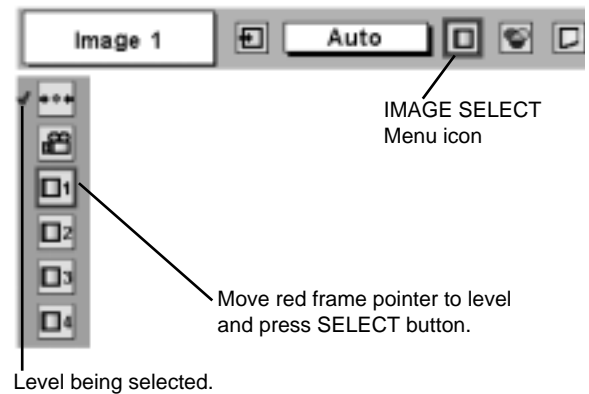

IMAGE LEVEL ADJUSTMENT

- 1 Press MENU button and ON-SCREEN MENU will appear. Press POINT LEFT/RIGHT button(s) to move a red frame pointer to IMAGE ADJUST Menu icon.
- 2 Press POINT DOWN button to move a red frame pointer to item that you want to adjust and then press SELECT button. Level of each item is displayed. Adjust each level by pressing POINT LEFT/RIGHT button(s).

Contrast

Press POINT LEFT button to decrease contrast, and POINT RIGHT button to increase contrast. (From 0 to 63.)

Brightness

Press POINT LEFT button to adjust image darker, and POINT RIGHT button to adjust brighter. (From 0 to 63.)

Color

Press POINT LEFT button to lighten color, and POINT RIGHT button to deeper color. (From 0 to 63.)

Tint

Press POINT LEFT button or POINT RIGHT button to obtain proper color. (From 0 to 63.)

White balance (Red)

Press POINT LEFT button to lighten red tone and POINT RIGHT button to deeper tone. (From 0 to 63.)

White balance (Green)

Press POINT LEFT button to lighten green tone and POINT RIGHT button to deeper tone. (From 0 to 63.)

White balance (Blue)

Press POINT LEFT button to lighten blue tone and POINT RIGHT button to deeper tone. (From 0 to 63.)

Sharpness

Press POINT LEFT button to soften image, and POINT RIGHT button to sharpen image. (From 0 to 15.)

Gamma

Press either POINT LEFT button or POINT RIGHT button to obtain better balance of contrast. (From 0 to 15.)

Noise reduction

Press POINT LEFT/RIGHT button(s) to change noise reduction mode. Dialog box display is changed to "On to reduce noise (rough parts) of image. Press POINT LEFT/RIGHT button(s) again, to change noise reduction mode to off.

Progressive scan

Press POINT LEFT/RIGHT button(s) to change progressive scan mode. Dialog box display is changed to "Off" and progressive scan mode to off. Press POINT LEFT/RIGHT button(s) again, progressive scan mode to on.

IMAGE ADJUST MENU

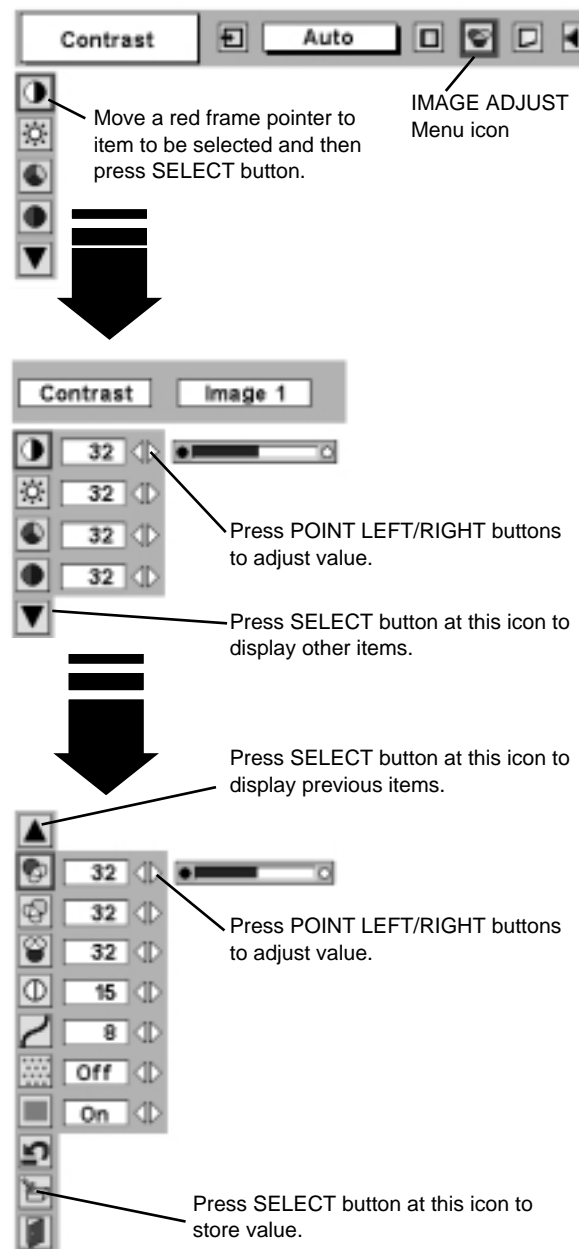

NOTE :

Tint cannot be adjusted when video system is PAL, SECAM, PAL-M or PAL-N.

Noise Reduction cannot be operated when video signal types and systems as follow.

- Composite video signal (SECAM, NTSC4.43, PAL-M and PAL-N systems).
- S-video signal (SECAM, PAL-M and PAL-N systems).
- Component video signal.

Progressive cannot be operated when "480p", "575p", "720p", "1035i" or "1080i" is selected on AV SYSTEM MENU (P31).

3 **Store**

To store adjustment data, move a red frame pointer to Store icon and press SELECT button. Image Level Menu will appear. Move a red frame pointer to Image Level 1 to 4 and then press SELECT button.

Other icons operates as follows.

Reset

Reset all adjustment to previous figure.

Quit

Closes IMAGE MENU.

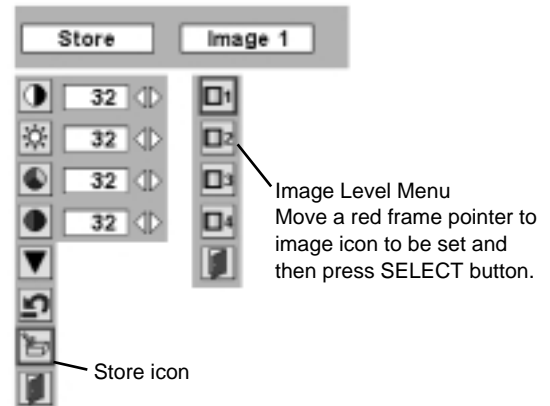

PICTURE SCREEN ADJUSTMENT

This projector has a picture screen resize function, which enables you to display desirable image size.

- 1 Press MENU button and ON-SCREEN MENU will appear. Press POINT LEFT/RIGHT button(s) to move a red frame pointer to SCREEN Menu icon.
- 2 Press POINT DOWN button and move a red frame pointer to function that you want to select and then press SELECT button.

Normal

Provides image at a normal video aspect ratio of 4 : 3.

Wide

Provides image at a wide screen ratio of 16 : 9.

SCREEN MENU

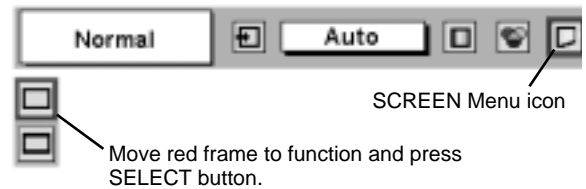

NOTE : SCREEN Menu cannot be operated when "720p," "1035i," or "1080i" is selected on AV SYSTEM Menu (P31).

SETTING MENU

- 1 Press MENU button and ON-SCREEN MENU will appear. Press POINT LEFT/RIGHT button(s) to move a red-frame pointer to SETTING icon.
- 2 Press POINT DOWN button to move a red-frame pointer to item that you want to set and then press SELECT button. Setting dialog box appears.

Language

Language used in ON-SCREEN MENU is selectable from among English, German, French, Italian, Spanish, Portuguese, Dutch, Swedish, Chinese, Korean and Japanese.

Keystone

When image is distorted vertically, select Keystone. ON-SCREEN MENU disappears and Keystone dialog box is displayed. Correct keystone distortion by pressing POINT UP/DOWN button(s). Refer to KEYSTONE ADJUSTMENT on page 20.

Blue back

When this function is "On," this projector will produce a blue image instead of video noise on screen when any input source is unplugged or turned off.

Display

This function decides whether to display On-Screen Displays.

- On ... shows all On-Screen Displays.
- Off ... sets On-Screen Displays disappeared except;
 - ON-SCREEN MENU
 - "Power off?" message

Logo

When this function is "On," projector displays our logo when starting up.

Ceiling

When this function is "On," picture is top / bottom and left / right reversed. This function is used to project image from a ceiling mounted projector.

Rear

When this function is "On," picture is left / right reversed. This function is used to project image to a rear projection screen.

SETTING MENU

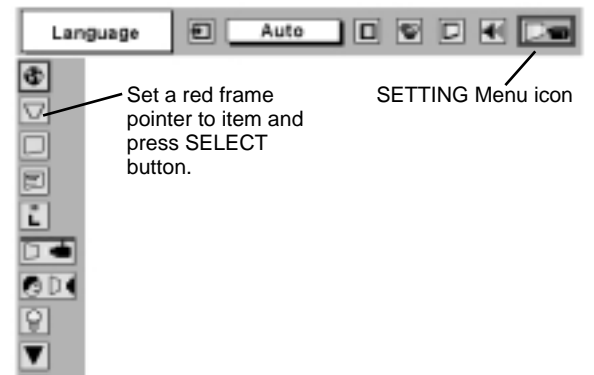

When pressing SELECT button at Language, Language Menu appears.



Ceiling function

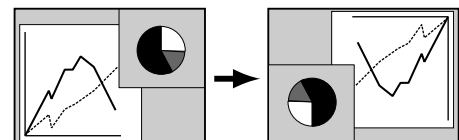

Rear function

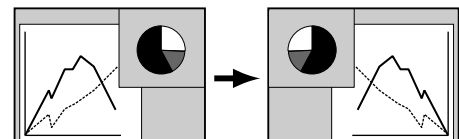



Power management

This function turns Projection Lamp off when this projector detects signal interruption and is not used for a certain period in order to reduce power consumption and maintain Lamp-life. (This projector is shipped with this function ON.)

Power Management function operates to turn Projection Lamp off when input signal is interrupted and any button is not pressed over 5 minutes. This function operates as follows;

1. When any input signal is interrupted, "No signal" and counting down display appears (for 5 minutes).
2. After counting down for 5 minutes, projector lamp and READY indicator are turned off.
3. When READY indicator flashing, Projection Lamp can be turned on again (Power Management mode).

In this Power Management mode, Projection Lamp is automatically turned on when input signal connected or projector is operated with any button on Top Control or on Remote Control Unit again.

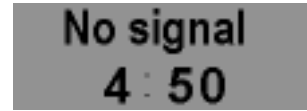

Time left until Lamp off.

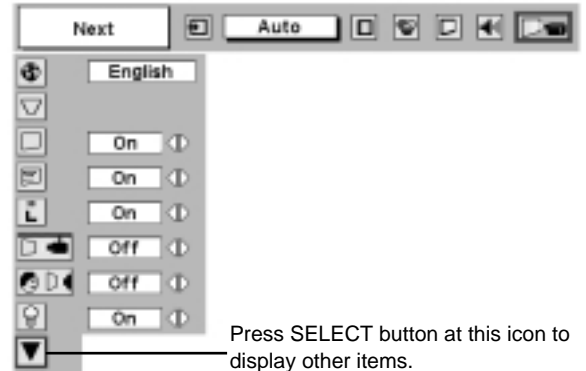

On start

When this function is "On," projector is automatically turned on just by connecting AC Power cord to a wall outlet.

Note ; Be sure to turn projector off properly (refer to section "TURNING OFF PROJECTOR" on P19). If projector is turned off in wrong steps, On Start function does not operate properly.

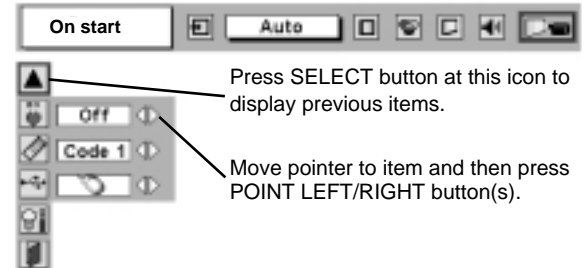

Remote control

This projector has two different remote control codes; factory-set normal code (Code 1) and secondary code (Code 2). This switching function prevents remote control operation mixture (jam) when operating several projectors or video equipment together.

When operating projector in "Code 2," both projector and Remote Control Unit must be switched to "Code 2."

To change code of Projector;

Set Remote control in SETTING MENU to "Code 2."

To change code of Remote Control Unit;

Press both MENU and IMAGE buttons on Remote Control Unit together for over 10 seconds.

After changing code, make sure Remote Control operates properly.

To return to normal code (Code 1), operate both projector and Remote Control in ways above again.

NOTE : When batteries of Remote Control Unit are replaced or ALL-OFF switch is turned to "ALL-OFF," remote transmit code automatically returns to normal code (Code 1).

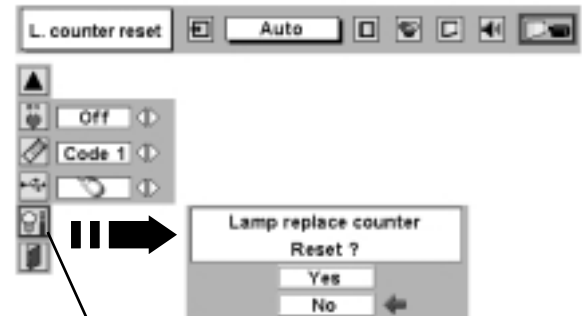

Lamp counter reset

This function is used to reset Lamp Replace Counter. When replacing Projection Lamp, reset Lamp Replace Counter by using this function. Refer to page 39 for operation.

Move pointer to Lamp counter reset and then press SELECT button. Message "Lamp replace counter reset?" is displayed.

SETTING/APPENDIX



USB

This Projector is equipped with USB port for interactive operation between a projector and computer. Set mode following steps below.

Wireless Mouse mode

Select "  " when controlling a computer with Remote Control of this projector.

Projector mode

Select "  " when controlling a projector with computer.

NOTE: Before you control a projector by computer, install USB driver (optionally sold parts) and set up computer following instruction in USB driver package. Contact your authorized dealer.

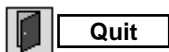
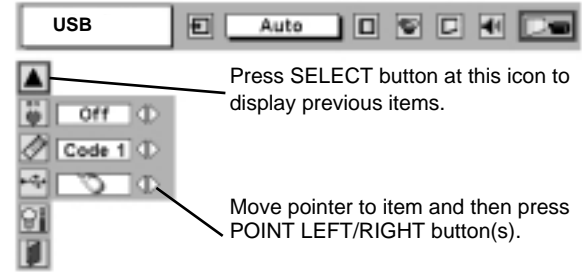

Quit

Closes SETTING MENU.

OPERATING WIRELESS MOUSE

Wireless Remote Control Unit is not only able to operate this projector but also usable as a wireless mouse for most Personal Computers. POINT buttons and two CLICK buttons are used for wireless mouse operation.

This Wireless Mouse function is available only when PC mouse pointer is displayed on a projected screen. When ON-SCREEN MENU or any message / dialog box is displayed on screen instead of PC mouse pointer, this Wireless Mouse function cannot be used.

INSTALLATION

To use Wireless Remote Control Unit as Wireless Mouse for a Personal Computer, installation of mouse driver (not supplied) is required. Make sure that mouse driver is properly installed in your computer. And make sure that mouse port (or USB port) of a Personal Computer is activated.

- 1 Connect mouse port (or USB port) of your computer to Control Port (or USB connector) of this projector with Control Cable (or USB cable). (Refer to page 11, 12 for connection.)
- 2 Turn a projector on first, and then turn on your computer. When computer is switched on first, Wireless Mouse may not work properly.

Note : When your computer has no mouse port, connect Serial Port of your computer to Control Port of a projector with Control Cable for Serial Port (not supplied).

OPERATING WIRELESS MOUSE

When controlling a PC mouse pointer, operate Wireless Mouse with POINT button, SELECT button, and RIGHT CLICK button on Wireless Remote Control Unit.

POINT button

Used to move PC mouse pointer. Pointer is moved corresponding with direction you are pressing.

SELECT (LEFT CLICK) button

This button has same function as left button in a PC mouse.

RIGHT CLICK button

This button has same function as right button in a PC mouse. This button is not available for controlling this projector.

POINT button (Move pointer)

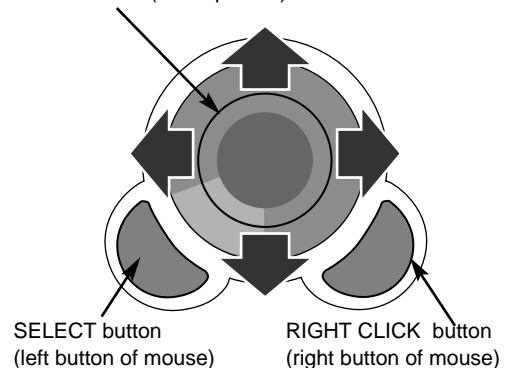

MAINTENANCE

WARNING TEMP. INDICATOR

WARNING TEMP. Indicator flashes red when an internal temperature of a projector exceeds normal temperature. This Indicator stops flashing when temperature of a projector returns to normal.

When WARNING TEMP. Indicator continues to flash, check items listed below.

- 1 Ventilation Slots of a projector may be blocked. In such an event, reposition a projector so that Ventilation Slots are not obstructed.
- 2 Air Filter may be clogged with dust particles. Clean Air Filter by following section AIR FILTER CARE AND CLEANING below.
- 3 If WARNING TEMP. Indicator remains on after performing above checks, Cooling Fans or Internal Circuits may be malfunctioning. Contact service personnel from an authorized dealer or a service station.

AIR FILTER CARE AND CLEANING

Air Filter prevents dust from accumulating on surface of Projection Lens and Projection Mirror. Should Air Filter become clogged with dust particles, it will reduce Cooling Fans' effectiveness and may result in internal heat build up and adversely affect life of a projector. Clean Air Filter following steps below:

- 1 Turn off a projector, and disconnect AC power cord from AC outlet.
- 2 Turn a projector upside down and remove Air Filter (2 used) by pulling latches upward.
- 3 Clean Air Filter with a brush or wash out dust and particles.
- 4 Replace Air Filter properly. Make sure that Air Filter is fully inserted.



CAUTION

Do not operate a projector with Air Filter removed. Dust may accumulate on LCD Panel and Projection Mirror degrading picture quality.
Do not put small parts into Air Intake Vents. It may result in malfunction of a projector.

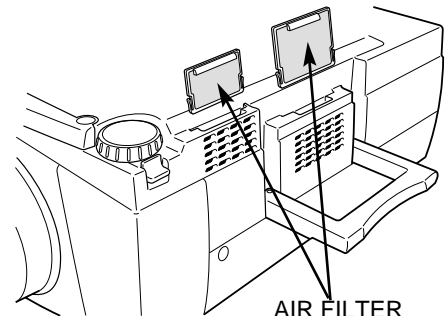

AIR FILTER
Pull up and remove.

RECOMMENDATION

We recommend avoiding dusty/smoky environments when operating a projector. Usage in these environments may cause poor image quality.

When using under dusty or smoky conditions, dust may accumulate on a lens, liquid crystal panels, or optical elements inside a projector. This condition may degrade quality of a projected image.

When above symptoms are noticed, contact a Boxlight Corporation at 1-800-762-5757 or 360-779-7901 for cleaning.

CLEANING PROJECTION LENS

Follow these steps to clean Projection Lens:

- 1 Apply a non-abrasive camera lens cleaner to a soft, dry cleaning cloth. Avoid using an excessive amount of cleaner. Abrasive cleaners, solvents or other harsh chemicals might scratch a surface.
- 2 Lightly wipe a cleaning cloth over Projection Lens.
- 3 When a projector is not in use, replace Lens Cover.

LAMP REPLACEMENT

When life of Projection Lamp of this projector draws to an end, LAMP REPLACEMENT indicator lights yellow. When a projected image becomes dark or color of an image becomes unnatural, replacement of Projection Lamp is required.



CAUTION

For continued safety, replace with a lamp assembly of same type.

Allow a projector to cool for at least 45 minutes before you open Lamp Cover. Inside of a projector can become very hot.



CAUTION

Do not drop a lamp assembly or touch a glass bulb! Glass can shatter and may cause injury.



Follow these steps to replace lamp assembly.

- 1** Turn off a projector and disconnect AC plug. Allow a projector to cool for at least 45 minutes.
- 2** Remove 2 screws with a screwdriver and open Lamp Cover.
- 3** Loosen 2 screws with a screwdriver and pull out Lamp Assembly by grasping Handle.
- 4** Replace Lamp Assembly with a new one and tighten 2 screws back. Make sure that Lamp Assembly is set properly. Replace Lamp Cover and tighten 2 screws.
- 5** Connect AC Power Cord to a projector and turn it on.
- 6** Reset Lamp Replace Counter (refer to section "Lamp Replace Counter" below).

NOTE : Do not reset Lamp Replace Counter when Projection Lamp is not replaced.

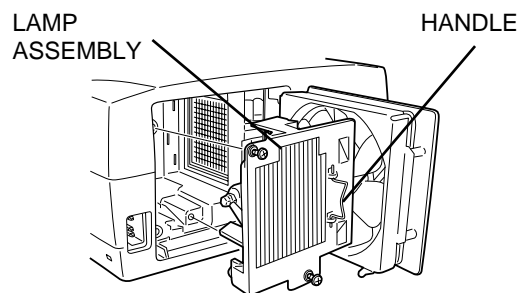
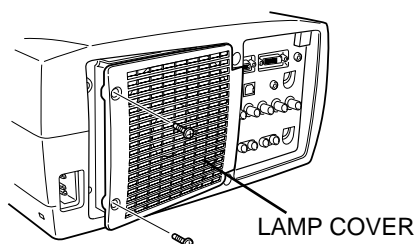

ORDER REPLACEMENT LAMP

Replacement Lamp can be ordered through Boxlight Corporation at 1-800-762-5757 or 360-779-7901. When ordering Projection Lamp, give following information to dealer.

- Model No. of your projector : BOXLIGHT MP-41t
- Replacement Lamp Type No. : POA-LMP38
(Service Parts No. 610 293 5868)

LAMP REPLACE COUNTER

Be sure to reset Lamp Replace Counter when Lamp Assembly is replaced. When Lamp Replace Counter is reset, LAMP REPLACE Indicator stops lighting.

- 1** Turn projector on, press MENU button and ON-SCREEN MENU will appear. Press POINT LEFT/RIGHT button(s) to move a red frame pointer to SETTING Menu icon (refer to page 35, 36).
- 2** Press POINT DOWN button to move a red frame pointer to "Lamp counter reset" and then press SELECT button. Message "Lamp replace counter reset?" is displayed. Move pointer to [Yes] and then press SELECT button.
- 3** Another confirmation dialog box appears and select [Yes] to reset Lamp Replace Counter.

Do not reset Lamp Replace Counter except after Projection Lamp is replaced.

TROUBLESHOOTING

Before calling your dealer or service center for assistance, check matters below once again.

1. Make sure you have connected a projector to your computer or video equipment as described in section "CONNECTING PROJECTOR" on pages 11 ~ 13.
2. Check cable connection. Verify that all computer, video and power cord are properly connected.
3. Verify that all power is switched on.
4. If a projector still does not produce an image, re-start your computer.
5. If an image still does not appear, unplug a projector from your computer and check your computer monitor's display. Problem may be with your graphics controller rather than with a projector. (When you reconnect a projector, be sure to turn computer and monitor off before you power up a projector. Power equipment back on in order of : Projector and computer.)
6. If problem still exists, check following chart.

Problem:	Try these Solutions
No power.	<ul style="list-style-type: none"> ● Plug a projector into your AC outlet. ● Make sure READY Indicator lights. ● Wait 90 seconds after a projector is turned OFF when turning a projector back on. <p>NOTE : After pressing Power ON-OFF button to OFF, make sure a projector works as follows:</p> <ol style="list-style-type: none"> 1. LAMP indicator lights bright and READY indicator turns off. 2. After 90 seconds, READY indicator lights green again and a projector may be turned on by pressing Power ON-OFF button. <ul style="list-style-type: none"> ● Check WARNING TEMP. indicator. If indicator flashes red, a projector cannot be turned on. (See "TURNING ON/OFF PROJECTOR" section on page 19.) ● Check Projection Lamp. (Refer to page 39.)
Image is out of focus.	<ul style="list-style-type: none"> ● Adjust focus of a projector. ● Make sure a projection screen is at least 4.6' (1.4m) from a projector. ● Check Projection Lens to see if it needs cleaning. <p>NOTE : Moving a projector from a cool temperature location to a warm temperature location may result in moisture condensation on Projection Lens. In such an event, leave a projector OFF and wait until condensation disappears.</p>
Picture is Left/Right reversed.	<ul style="list-style-type: none"> ● Check Ceiling / Rear feature. (See "SETTING" section on page 35.)
Picture is Top/Bottom reversed.	<ul style="list-style-type: none"> ● Check Ceiling feature. (See "SETTING" section on page 35.)
Some displays are not seen during Operation.	<ul style="list-style-type: none"> ● Check Display feature.(See "SETTING" section on page 35.)
No image.	<ul style="list-style-type: none"> ● Check connection between your computer or video equipment and a projector. ● When turning a projector on, it takes about 30 seconds to display an image. ● Check system that you select is corresponding with your computer or video equipment. ● Make sure temperature is not out of Operating Temperature (5°C ~ 35°C).
No sound.	<ul style="list-style-type: none"> ● Check audio cable connection from audio input source. ● Adjust audio source. ● Press VOLUME (+) button. ● Press MUTE button.

Problem:	Try these Solution
Remote Control Unit does not work.	<ul style="list-style-type: none"> ● Check batteries. ● Check ALL-OFF switch on Remote Control Unit is set to "ON." ● Make sure nothing is between Infrared Remote Receiver and Remote Control Unit. ● Make sure you are not too far from a projector when using Remote Control Unit. Maximum operating range is 16.4' (5m).
Wireless Mouse function does not work.	<ul style="list-style-type: none"> ● Check cable connection between a projector and your computer. ● Check mouse setting on your computer. ● Turn a projector on before turning on a computer.

SERVICE

WARNING: High voltages are used to operate this projector. Do not attempt to open the cabinet.

Boxlight Service is easily obtained. If after following instructions above, you find that service is necessary, contact Boxlight for assistance at 1-800-762-5757 or 360-779-7901.

Give the model number and explain the difficulty. We will advise you how to obtain service. Please have the following information available:

- Serial Number of Projector.
- Resolution of Computer.
- Refresh rate of Computer.



This symbol on the nameplate means the product is Listed by Underwriters Laboratories Inc. It is designed and manufactured to meet rigid U.L. safety standards against risk of fire, casualty and electrical hazards.



The CE Mark is a Directive conformity mark of the European Community (EC).

TECHNICAL SPECIFICATIONS

Projector Type	Multi-media Projector
Dimensions (W x H x D)	12.6" x 6.6" x 18.5" (319 mm x 168 mm x 470 mm)
Net Weight	18.5 lbs (8.4 kg)
LCD Panel System	1.3" TFT Active Matrix type, 3 panels
Panel Resolution	1024 x 768 dots
Number of Pixels	2,359,296 (1024 x 768 x 3 panels)
Color System	PAL, SECAM, NTSC, NTSC4.43, PAL-M and PAL-N
High Definition TV Signal	480i, 480p, 575i, 575p, 720p, 1035i and 1080i
Scanning Frequency	H-sync. 15 ~ 100 KHz, V-sync. 50 ~ 100 Hz
Projection Lens	F1.7 ~ 2.0 lens with f=48.2 mm ~ 62.6 mm Motor zoom and focus
Throw distance	4.6' (1.4 m) ~ 48.3' (14.7 m)
Motorized Lens Shift	Up and Down
Projection Image Size (Diagonal)	Adjustable from 31" to 400"
Horizontal Resolution	800 TV lines (HDTV)
Projection Lamp	200 watt type
Input 1 Jacks	DVI Terminal (Digital), HDB 15-pin Terminal (Analog) and Stereo Mini Type Jack (Audio)
Input 2 Jacks	BNC Type x 5 (G or VIDEO/Y, B or Cb/Pb, R or Cr/Pr, H and V), Stereo Mini Type Jack (Audio)
Input 3 Jacks	RCA Type x 3 (VIDEO/Y, Cb/Pb and Cr/Pr), RCA Type x 2 (Audio R and L) and DIN 4-pin (S-Video)
Other Jacks	DIN 8-pin (Control port), USB port (Series B receptacle) and Wired Remote Jack
Built-in Speakers	INT. SP. Stereo (R and L), 2 watt RMS (T.H.D. 10%)
Feet Adjustment	0° to 10.5°
Voltage and Power Consumption	AC 100 ~ 120 V (3.6 A Max. Ampere), 50 / 60 Hz (The U.S.A and Canada) AC 200 ~ 240 V (1.8 A Max. Ampere), 50 / 60 Hz (Continental Europe)
Operating Temperature	41 °F ~ 95 °F (5 °C ~ 35 °C)
Storage Temperature	14 °F ~ 140 °F (-10 °C ~ 60 °C)
Remote Control Transmitter	Power Source : AA, UM3 or R06 Type x 2 Operating Range : 16.4' (5m) / ±30° Dimensions : 2.2" x 1.3" x 7.6" (55mm x 34mm x 192mm) Net Weight : 0.36 lbs (165 g) (including batteries) Laser Pointer : Class II Laser (Max. Output : 1mW / Wave length : 650±20nm)
Accessories	User's Guide AC Power Cord Wireless/Wired Remote Control Transmitter and Batteries Remote Control Cable VGA Cable MAC/VGA Adapter 3 Types Control Cable (For PS/2, Serial and ADB port) Protective Dust Cover Lens Cover

● Specifications are subject to change without notice.

CONFIGURATIONS OF TERMINALS

COMPUTER INPUT-1 TERMINAL (ANALOG)

Terminal : HDB15-PIN

Connect display output terminal of computer to this terminal with VGA Cable (supplied). When connecting Macintosh computer, MAC Adapter (not supplied) is required.

Pin Configuration

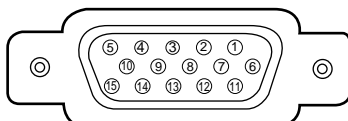

1	Red Input	9	+5V Power
2	Green Input	10	Ground (Vert.sync.)
3	Blue Input	11	Sense 0
4	Sense 2	12	DDC Data
5	Ground (Horiz.sync.)	13	Horiz. sync.
6	Ground (Red)	14	Vert. sync.
7	Ground (Green)	15	DDC Clock
8	Ground (Blue)		

COMPUTER INPUT-1 TERMINAL (DIGITAL)

Terminal : DVI 24-pin

Connect display output terminal of computer to this terminal with DVI cable (for Single Link T.M.D.S. / not supplied).

Pin Configuration

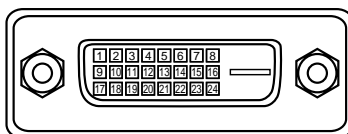

1	T.M.D.S. Data2-	9	T.M.D.S. Data1-	17	T.M.D.S. Data0-
2	T.M.D.S. Data2+	10	T.M.D.S. Data1+	18	T.M.D.S. Data0+
3	T.M.D.S. Data2 Shield	11	T.M.D.S. Data1 Shield	19	T.M.D.S. Data0 Shield
4	No Connect	12	No Connect	20	No Connect
5	No Connect	13	No Connect	21	No Connect
6	DDC Clock	14	+5V Power	22	T.M.D.S. Clock Shield
7	DDC Data	15	Ground (for +5V)	23	T.M.D.S. Clock+
8	No Connect	16	Hot Plug Detect	24	T.M.D.S. Clock-

CONTROL PORT CONNECTOR

Terminal : Mini DIN 8-PIN

Connect control port (PS/2, Serial or ADB port) on your computer to this connector with Control Cable (supplied).

Pin Configuration

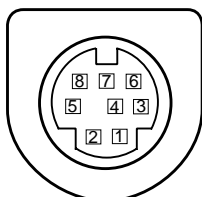

	PS/2	Serial	ADB
1	----	R X D	----
2	CLK	----	ADB
3	DATA	----	----
4	GND	GND	GND
5	----	RTS / CTS	----
6	----	T X D	----
7	GND	GND	----
8	----	GND	GND

USB CONNECTOR (Series B)

Connect USB port terminal on your computer or peripheral equipment to this connector with USB Cable (not supplied).

Pin Configuration

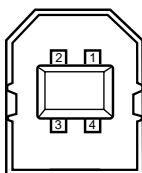

1	Vcc
2	- Data
3	+ Data
4	Ground

LIMITED WARRANTY

BOXLIGHT CORPORATION ("BOXLIGHT") warrants that each Boxlight MP-41t ("the Product") sold hereunder will conform to and function in accordance with the written specifications of BOXLIGHT. Said limited warranty shall apply only to the first person or entity that purchases the Product for personal or business use and not for the purpose of distribution or resale. Said warranty shall continue for a period of two (2) years from the date of such purchase. BOXLIGHT does not warrant that the Product will meet the specific requirements of the first person or entity that purchases the Product for personal or business use. Lamp is warranted for 120 days.

BOXLIGHT CORPORATION's liability for the breach of the foregoing limited warranty is limited to the repair or replacement of the Product or refund of the purchase price of the Product, at BOXLIGHT's sole option. To exercise the Purchaser's rights under the foregoing warranty, the Product must be returned at the Purchaser's sole cost and expense, to BOXLIGHT or any authorized service center provided, however, that the Product must be accompanied by a written letter explaining the problem and which includes (i) proof of purchase; (ii) the dealer's name; and (iii) the model and serial number of the Product. A return authorization number, issued by the BOXLIGHT customer service department, must also be clearly displayed on the outside of the shipping carton containing the Product.

WARRANTY LIMITATION AND EXCLUSION

BOXLIGHT CORPORATION shall have no further obligation under the foregoing limited warranty if the Product has been damaged due to abuse, misuse, neglect, accident, unusual physical or electrical stress, unauthorized modification, tampering, alterations, or service other than by BOXLIGHT or its authorized agents, causes other than from ordinary use or failure to properly use the Product in the application for which said Product is intended.

DISCLAIMER OR UNSTATED WARRANTIES

The warranty printed above is the only warranty applicable to this purchase.

All other warranties express or implied, including, but not limited to, the implied warranties or merchantability and fitness for a particular purpose are disclaimed. There are no warranties that extend beyond the face of hereof and the foregoing warranty shall not be extended, altered or varied except by written instrument signed by BOXLIGHT CORPORATION

LIMITATION OR LIABILITY

It is understood and agreed that BOXLIGHT's liability whether in contract, in tort, under any warranty, in negligence or otherwise shall not exceed the return of the amount of the purchase price paid by purchaser and under no circumstances shall BOXLIGHT be liable for special, indirect or consequential damages. The price stated for the Product is a consideration in limiting BOXLIGHT's liability. No action regardless of form, arising out of the agreement to purchase the product may be brought by purchaser more than one year after the cause of action has accrued.



Boxlight
19332 Powder Hill Place
Poulsbo, WA 98370-7407 USA
www.boxlight.com
U.S. and Canada 800-762-5757
International 360-779-7901

Free Manuals Download Website

<http://myh66.com>

<http://usermanuals.us>

<http://www.somanuals.com>

<http://www.4manuals.cc>

<http://www.manual-lib.com>

<http://www.404manual.com>

<http://www.luxmanual.com>

<http://aubethermostatmanual.com>

Golf course search by state

<http://golfingnear.com>

Email search by domain

<http://emailbydomain.com>

Auto manuals search

<http://auto.somanuals.com>

TV manuals search

<http://tv.somanuals.com>