

DVR1 Series



Security Systems

EN | Instruction Manual
Single Channel,
Color Digital Video
Recorder

Applicable Models:

DVR1EP08, DVR1EP16,
DVR1EP32, and DVR1EP32A

BOSCH

Important Safeguards

1. **Read, Follow, and Retain Instructions** - All safety and operating instructions should be read and followed before operating the unit. Retain instructions for future reference.
2. **Heed Warnings** - Adhere to all warnings on the unit and in the operating instructions.
3. **Attachments** - Attachments not recommended by the product manufacturer should not be used, as they may cause hazards.
4. **Installation Cautions** - Do not place this unit on an unstable stand, tripod, bracket, or mount. The unit may fall, causing serious injury to a person and serious damage to the unit. Use only manufacturer-recommended accessories, or those sold with the product. Mount the unit per the manufacturer's instructions. Appliance and cart combination should be moved with care. Quick stops, excessive force, or uneven surfaces may cause the appliance and cart combination to overturn.
5. **Cleaning** - Unplug the unit from the outlet before cleaning. Follow any instructions provided with the unit. Generally, using a damp cloth for cleaning is sufficient. Do not use liquid cleaners or aerosol cleaners.
6. **Servicing** - Do not attempt to service this unit yourself. Opening or removing covers may expose you to dangerous voltage or other hazards. Refer all servicing to qualified service personnel.
7. **Damage Requiring Service** - Unplug the unit from the main AC power source and refer servicing to qualified service personnel under the following conditions:
 - When the power supply cord or plug is damaged.
 - If liquid has been spilled or an object has fallen into the unit.
 - If the unit has been exposed to water and/or inclement weather (rain, snow, etc.).
 - If the unit does not operate normally, when following the operating instructions. Adjust only those controls specified in the operating instructions. Improper adjustment of other controls may result in damage, and require extensive work by a qualified technician to restore the unit to normal operation.
 - If the unit has been dropped or the cabinet damaged.
 - If the unit exhibits a distinct change in performance, this indicates that service is needed.
8. **Replacement Parts** - When replacement parts are required, the service technician should use replacement parts specified by the manufacturer, or that have the same characteristics as the original part. Unauthorized substitutions may result in fire, electrical shock, or other hazards.
9. **Safety Check** - Upon completion of servicing or repairs to the unit, ask the service technician to perform safety checks to ensure proper operating condition.
10. **Power Sources** - Operate the unit only from the type of power source indicated on the label. If unsure of the type of power supply to use, contact your dealer or local power company.
 - For units intended to operate from battery power, refer to the operating instructions.
 - For units intended to operate **with External Power Supplies**, use only the recommended approved power supplies.
 - For units intended to operate with a limited power source, this power source must comply with EN60950. Substitutions may damage the unit or cause fire or shock.
 - For units intended to operate at 24VAC, normal input voltage is **24VAC**. Voltage applied to the unit's power input should not exceed 30VAC. User-supplied wiring, from the 24VAC supply to unit, must be in compliance with electrical codes (Class 2 power levels). Do not ground the 24VAC supply at the terminals or at the unit's power supply terminals.
11. **Coax Grounding** - If an outside cable system is connected to the unit, ensure that the cable system is grounded. U.S.A. models only--Section 810 of the National Electrical Code, ANSI/NFPA No.70, provides information regarding proper grounding of the mount and supporting structure, grounding of the coax to a discharge unit, size of grounding conductors, location of discharge unit, connection to grounding electrodes, and requirements for the grounding electrode.
12. **Grounding or Polarization** - This unit may be equipped with a polarized alternating current line plug (a plug with one blade wider than the other). This safety feature allows the plug to fit into the power outlet in only one way. If unable to insert the plug fully into the outlet, try reversing the plug. If the plug still fails to fit, contact an electrician to arrange replacement of the obsolete outlet. Do not defeat the safety purpose of the polarized plug. Alternately, this unit may be equipped with a 3-wire grounding plug (a plug with a third pin, for grounding). This safety feature allows the plug to fit into a grounding power outlet only. If unable to insert the plug into the outlet, contact an electrician to arrange replacement of the obsolete outlet. Do not defeat the safety purpose of the grounding plug.
13. **Lightning** - For added protection during a lightning storm, or when this unit is left unattended and unused for long periods of time, unplug the unit from the wall outlet and disconnect the cable system. This will prevent damage to the unit due to lightning and power line surges.

For Indoor Product

1. **Water and Moisture** - Do not use this unit near water - for example, in a wet basement, in an unprotected outdoor installation, or in any area classified as a wet location.
2. **Object and Liquid Entry** - Never push objects of any kind into this unit through openings, as they may touch dangerous voltage points or short out parts that could result in a fire or electrical shock. Never spill liquid of any kind on the unit.
3. **Power Cord and Power Cord Protection** - For units intended to operate with 230VAC, 50Hz, the input and output power cord must comply with the latest versions of IEC Publication 227 or IEC Publication 245.
Power supply cords should be routed so they are not likely to be walked on or pinched. Pay particular attention to location of cords and plugs, convenience receptacles, and the point of exit from the appliance.
4. **Overloading** - Do not overload outlets and extension cords; this can result in a risk of fire or electrical shock.

For Outdoor Product

Power Lines - An outdoor system should not be located in the vicinity of overhead power lines, electric lights, or power circuits, or where it may contact such power lines or circuits. When installing an outdoor system, extreme care should be taken to keep from touching power lines or circuits, as this contact might be fatal. U.S.A. models only - refer to the National Electrical Code Article 820 regarding installation of CATV systems.

For Rack-mount Product

1. **Ventilation** - This unit should not be placed in a built-in installation or rack, unless proper ventilation is provided, or the manufacturer's instructions have been adhered to. The equipment must not exceed its maximum operating temperature requirements.
2. **Mechanical Loading** - Mounting of the equipment in a rack shall be such that a hazardous condition is not achieved due to uneven mechanical loading.



WARNING:
Electrostatic-sensitive device. Use proper CMOS/MOSFET handling precautions to avoid electrostatic discharge.

NOTE: Grounded wrist straps must be worn and proper ESD safety precautions observed when handling the electrostatic-sensitive printed circuit boards.



CAUTION: Lithium Battery
Danger of explosion if battery is incorrectly replaced. Replace only with the same or equivalent type recommended by the manufacturer. Dispose of used batteries according to the battery manufacturer's instructions.

Safety Precautions



CAUTION
RISK OF ELECTRIC SHOCK. DO NOT OPEN!



CAUTION: TO REDUCE THE RISK OF ELECTRIC SHOCK, DO NOT REMOVE COVER (OR BACK). NO USER SERVICEABLE PARTS INSIDE. REFER SERVICING TO QUALIFIED SERVICE PERSONNEL.



This symbol indicates the presence of uninsulated "dangerous voltage" within the product's enclosure. This may constitute a risk of electric shock.



The user should consult the operating and maintenance (servicing) instructions in the literature accompanying the appliance.



Attention: Installation should be performed by qualified service personnel only in accordance with the National Electrical Code or applicable local codes.



Power Disconnect. Units with or without ON-OFF switches have power supplied to the unit whenever the power cord is inserted into the power source; however, the unit is operational only when the ON-OFF switch is in the ON position. The power cord is the main power disconnect for all units.

FCC & ICES INFORMATION

(U.S.A. and Canadian Models Only)

This device complies with part 15 of the FCC Rules. Operation is subject to the following two conditions:







- (1) This device may not cause harmful interference, and
- (2) This device must accept any interference received, including interference that may cause undesired operation.

NOTE: This equipment has been tested and found to comply with the limits for a Class A digital device, pursuant to Part 15 of the FCC Rules and ICES-003 of Industry Canada. These limits are designed to provide reasonable protection against harmful interference when the equipment is operated in a commercial environment. This equipment generates, uses and radiates radio frequency energy, and if not installed and used in accordance with the instruction manual, may cause harmful interference to radio communications. Operation of this equipment in a residential area is likely to cause harmful interference, in which case the user will be required to correct the interference at his expense.

Intentional or unintentional changes or modifications, not expressly approved by the party responsible for compliance, shall not be made. Any such changes or modifications could void the user's authority to operate the equipment. If necessary, the user should consult the dealer or an experienced radio/television technician for corrective action. The user may find the following booklet, prepared by the Federal Communications Commission, helpful: [How to Identify and Resolve Radio-TV Interference Problems](#). This booklet is available from the U.S. Government Printing Office, Washington, DC 20402, Stock No. 004-000-00345-4.

WARNING: This is a Class A product. In a domestic environment, this product may cause radio interference, in which case, the user may be required to take adequate measures.

Sécurité

	ATTENTION RISQUE D'ÉLECTROCUTION. NE PAS OUVRIR !	
ATTENTION : POUR ÉVITER TOUT RISQUE D'ÉLECTROCUTION, N'ESSAYEZ PAS DE RETIRER LE CAPOT (OU LE PANNEAU ARRIÈRE). CET APPAREIL NE CONTIENT AUCUN COMPOSANT SUSCEPTIBLE D'ÊTRE RÉPARÉ PAR L'UTILISATEUR. CONFIEZ LA RÉPARATION DE L'APPAREIL À DU PERSONNEL QUALIFIÉ.		
	Ce symbole signale que le produit renferme une « tension potentiellement dangereuse » non isolée susceptible de provoquer une électrocution.	
	Ce symbole invite l'utilisateur à consulter les instructions d'utilisation et d'entretien (dépannage) reprises dans la documentation qui accompagne l'appareil.	
	Attention : l'installation doit exclusivement être réalisée par du personnel qualifié, conformément au code national d'électricité américain (NEC) ou au code d'électricité local en vigueur.	
	Coupure de l'alimentation. Qu'ils soient pourvus ou non d'un commutateur ON/OFF, tous les appareils reçoivent de l'énergie une fois le cordon branché sur la source d'alimentation. Toutefois, l'appareil ne fonctionne réellement que lorsque le commutateur est réglé sur ON. Le débranchement du cordon d'alimentation permet de couper l'alimentation des appareils.	

Sicherheitshinweise

	VORSICHT ELEKTRISCHE SPANNUNG. NICHT ÖFFNEN!	
VORSICHT: UM EINEN ELEKTRISCHEN SCHLAG ZU VERMEIDEN, IST DIE ABDECKUNG (ODER RÜCKSEITE) NICHT ZU ENTFERNEN. ES BEFINDEN SICH KEINE TEILE IN DIESEM BEREICH, DIE VOM BENUTZER GEWARTET WERDEN KÖNNEN. LASSEN SIE WARTUNGSARBEITEN NUR VON QUALIFIZIERTEM WARTUNGSPERSONAL AUSFÜHREN.		
	Das Symbol macht auf nicht isolierte „gefährliche Spannung“ im Gehäuse aufmerksam. Dies kann zu einem elektrischen Schlag führen.	
	Der Benutzer sollte sich ausführlich über Anweisungen für die Bedienung und Instandhaltung (Wartung) in den begleitenden Unterlagen informieren.	
	Achtung! Die Installation sollte nur von qualifiziertem Kundendienstpersonal gemäß jeweils zutreffender Elektrovorschriften ausgeführt werden.	
	Unterbrechung des Netzanschlusses. Geräte mit oder ohne Netzschalter haben Spannung am Gerät anliegen, sobald der Netzstecker in die Steckdose gesteckt wird. Das Gerät ist jedoch nur betriebsbereit, wenn der Netzschalter (EIN/AUS) auf EIN steht. Wenn das Netzkabel aus der Steckdose gezogen wird, ist die Spannungszuführung zum Gerät vollkommen unterbrochen.	

Precauciones de Seguridad

	ATTENZIONE PERICOLO DI SCOSSA ELETTRICA. NON APRIRE.	
PRECAUCIÓN: PARA DISMINUIR EL RIESGO DE DESCARGA ELÉCTRICA, NO RETIRE LA CUBIERTA (NI LA PARTE POSTERIOR). NO EXISTEN PIEZAS DE RECAMBIO EN EL INTERIOR DEL EQUIPO. EL PERSONAL DE SERVICIO CUALIFICADO SE ENCARGA DE REALIZAR LAS REPARACIONES.		
	Este símbolo indica que existen puntos de tensión peligrosos sin aislamiento dentro de la cubierta de la unidad. Estos puntos pueden constituir un riesgo de descarga eléctrica.	
	El usuario debe consultar las instrucciones de funcionamiento y mantenimiento (reparación) en la documentación que se suministra con el aparato.	
	Atención: la instalación la debe realizar únicamente personal cualificado de conformidad con el National Electric Code o las normas aplicables en su país.	
	Desconexión de la alimentación. Las unidades con o sin interruptores de encendido/apagado reciben alimentación eléctrica siempre que el cable de alimentación esté conectado a la fuente de alimentación. Sin embargo, la unidad sólo funciona cuando el interruptor está en la posición de encendido. El cable de alimentación es la principal fuente de desconexión de todas las unidades.	

Veiligheidsmaatregelen

	VOORZICHTIG GEVAARVOOR ELEKTRISCHE SCHOK. NIET OPENEN!	
VOORZICHTIG: OPEN DE BEHUIZING OF DE ACHTERKANT VAN HET APPARAAT NIET. ZO VERMINDERT U HET RISICO OP ELEKTRISCHE SCHOKKEN. IN HET APPARAAT BEVINDEN ZICH GEEN ONDERDELEN DIE U ZELF KUNT REPAREREN. LAAT SERVICE EN ONDERHOUD UITVOEREN DOOR GEKwalificeerd personeel.		

	Dit symbool geeft aan dat er binnen in het apparaat ongeïsoleerde, gevaarlijke spanning aanwezig is die mogelijk elektrische schokken kan veroorzaken.
---	--

	De gebruiker dient de bedienings- en onderhoudsvorschriften te raadplegen in de documentatie die werd meegeleverd met het apparaat.
---	---

	Attentie: het apparaat mag alleen door gekwalificeerd personeel worden geïnstalleerd. De installatie dient in overeenstemming met de nationale elektrische richtlijnen of de van toepassing zijnde lokale richtlijnen te worden uitgevoerd.
---	---

	Spanning uitschakelen. Apparatuur met of zonder aan-uitschakelaar staat onder spanning zolang de stekker is aangesloten op de wandcontactdoos. De apparatuur is uitsluitend in werking als de aan-uitschakelaar aan staat. Het netsnoer is de "hoofdschakelaar" voor alle apparatuur.
---	---

Sicurezza

	ATTENZIONE PERICOLO DI SCOSSA ELETTRICA. NON APRIRE.	
ATTENZIONE: PER RIDURRE IL RISCHIO DI SCOSSA ELETTRICHE NON RIMUOVERE LA COPERTURA (O IL PANNELLO POSTERIORE). L'UNITÀ NON CONTIENE COMPONENTI INTERNI RIPARABILI DALL'UTENTE. PER QUALSIASI INTERVENTO, RIVOLGERSI A PERSONALE TECNICO QUALIFICATO.		



	Questo simbolo indica la presenza di "tensione pericolosa" non isolata all'interno del contenitore del prodotto. Ciò comporta un potenziale rischio di scosse elettriche.
---	---

	Si consiglia di consultare le istruzioni operative e di manutenzione (interventi tecnici) contenute nella documentazione fornita con il dispositivo.
---	--

	Attenzione: l'installazione deve essere effettuata esclusivamente da personale tecnico qualificato in conformità con il National Electrical Code o con le normative locali vigenti.
---	---

	Scollegamento dell'alimentazione. Le unità dotate o sprovviste di interruttori ON-OFF vengono alimentate quando si inserisce il cavo nella presa dell'alimentazione. L'unità è tuttavia in funzione solo quando l'interruttore ON-OFF si trova nella posizione ON. Il cavo di alimentazione costituisce il dispositivo di scollegamento dell'alimentazione principale per tutte le unità.
---	---

Medidas de Segurança

	CUIDADO RISCO DE CHOQUE ELÉCTRICO. NÃO ABRIR!	
CUIDADO: PARA REDUZIR O RISCO DE CHOQUE ELÉCTRICO, NÃO RETIRE A TAMP A (OU A PARTE POSTERIOR). NO INTERIOR, NÃO EXISTEM PEÇAS QUE POSSAM SER REPARADAS PELO UTILIZADOR. REMETA A ASSISTÊNCIA PARA OS TÉCNICOS QUALIFICADOS.		



	Este símbolo indica a presença de "tensão perigosa" não isolada dentro da estrutura do produto, o que pode constituir risco de choque eléctrico.
---	--

	O utilizador deve consultar as instruções de funcionamento e manutenção (assistência) nos documentos que acompanham o aparelho.
---	---

	Atenção: a instalação deve ser executada apenas por técnicos qualificados da assistência, de acordo com o código eléctrico nacional ou os códigos locais aplicáveis.
---	--

	Corte de corrente. As unidades com ou sem interruptores ON-OFF (ligar/desligar) recebem corrente sempre que o fio de alimentação está introduzido na fonte de alimentação; contudo, a unidade apenas está operacional quando o interruptor ON-OFF está na posição ON. O fio de alimentação destina-se a desligar a corrente em todas as unidades.
---	---

Zasady Bezpieczeństwa

	UWAGA NIEBEZPIECZEŃSTWO PORAZENIA PRĄDEM ELEKTRYCZNYM. NIE OTWIERAĆ!	
PRZESTROGA: ABY ZMNIEJSZYĆ RYZYKO PORAZENIA ELEKTRYCZNEGO, NIE NALEŻY ZDEJMOWAĆ POKRYWY GÓRNEJ (ani tyłnej). WEWNĄTRZ URZĄDZENIA NIE MA ŻADNYCH ELEMENTÓW, KTÓRE MOGĄ BYĆ NAPRAWIANE SAMODZIELNIE PRZEZ UŻYTKOWNIKA. SERWIS NALEŻY ZLECAĆ WYKwalifikowanym pracownikiem obsługi.		

	Ten symbol wskazuje na obecność nieizolowanego „niebezpiecznego napięcia” we wnętrzu urządzenia. Napięcie to grozi porażeniem elektrycznym.
---	---

	Użytkownik powinien zapoznać się z instrukcjami obsługi i konserwacji (serwisu), zamieszczonymi w dokumentacji towarzyszącej urządzeniu.
---	--

	Uwaga: Instalacja może być wykonywana wyłącznie przez wykwalifikowanych pracowników obsługi, zgodnie z zasadami kodeksu National Electrical Code lub innych obowiązujących norm.
---	--

	Odłączanie zasilania. Niezależnie od wyposażenia w wyłącznik zasilania, prąd do urządzenia jest doprowadzany zawsze, gdy przewód zasilania jest podłączony do źródła zasilania; jednak urządzenie działa tylko wtedy, gdy wyłącznik zasilania jest włączony. Przewód zasilania jest głównym wyłącznikiem zasilania we wszystkich urządzeniach.
---	--

TABLE OF CONTENTS

SECTION 1: INTRODUCTION TO THE DVR1 SERIES DIGITAL VIDEO RECORDERS	9
1.1 Guide to This Manual	9
1.2 Unpacking	9
1.3 Understanding the DVR1 Series	9
SECTION 2: INSTALLING THE DVR1	10
2.1 Mounting	10
2.2 Connecting the DVR1	10
SECTION 3: GUIDE TO THE DVR1 CONTROLS	13
3.1 DVR1 Front Panel Controls	13
3.2 DVR1 Front Panel Display	13
3.3 Navigating with the DVR1 Controls	14
SECTION 4: DVR1 MAIN MENU PROGRAMMING	15
4.1 Overview of the DVR1 Main Menu	15
4.2 Setting the Time/Date	15
4.3 Configuring Alarms	15
4.4 Configuring Scheduled Recordings	16
4.5 Configuring the Recording Parameters	16
4.6 Configuring On-screen Display Options	17
4.7 Managing Archive Storage	17
4.8 Accessing the Advanced Menu	19
4.9 About DSR	19
SECTION 5: DVR1 ADVANCED MENU PROGRAMMING	20
5.1 Overview of the DVR1 Advanced Menu	20
5.2 DVR1 Passwords	20
5.3 Overwriting the Hard Disk	21
5.4 Erasing, Deleting, and Recovering Hard Disk Data	21
5.5 Invoking Audio Recording	21
5.6 Using the Auto Delete Feature	21
5.7 Configuring Communications	22
5.8 Configuring the Multiplexer Format	22
5.9 Adjusting Picture Qualities	22
5.10 Locking Out the Front Panel	22
5.11 Restoring Factory Defaults	23
5.12 Changing the Password	23
SECTION 6: OPERATING THE DVR1 SERIES	24
6.1 Initial Startup	24
6.2 Recording	24
6.3 Playback	25
6.4 The Search Interface	26
SECTION 7: ARCHIVING	27
7.1 Archiving Applications Explained	27

7.1.1	<i>Extended Archiving Applications</i>	27
7.1.2	<i>Backup Archiving Applications</i>	27
7.1.3	<i>Selective/Manual Archiving Applications</i>	27
7.2	Using CD-Writers	27
7.2.1	<i>Minimum Requirements</i>	27
7.2.2	<i>Connecting the CD Recorder</i>	27
7.3	Creating a CD-ROM with Video Files	28
7.4	Limitations on CD Operations	28
SECTION 8: SERVICE AND RETURNS		29
8.1	Maintenance	29
8.2	Factory Service	29
APPENDIX A: FACTORY DEFAULT SETTINGS		30
APPENDIX B: TECHNICAL SPECIFICATIONS		31
APPENDIX C: OBSERVATION SYSTEM QUICK INSTALL GUIDE		33
1.1	Introduction	33
1.2	Required Software Version	33
1.3	Installation	33
1.3.1	<i>Connection of Audio/Video Cable (A/V cable)</i>	33
1.3.2	<i>Connection of Alarm Contact</i>	33
1.4	Programming the Observation System Monitor	34
1.5	Programming the DVR1	34
1.6	Remote Viewing Considerations	34
APPENDIX D: INSTALLATION GUIDE FOR THE COMBINED BOSCH MULTIPLEXER, INTUIKEY KEYBOARD & DVR1 SERIES SYSTEM		35
1.1	Overview	35
1.2	Required Software Version	35
1.3	Installation	35
1.4	DVR1 Keyboard Menus	36
1.4.1	<i>DVR1 Controls Menu</i>	36
1.4.2	<i>DVR1 Playback Controls Menu</i>	37
APPENDIX E: RS-232 REMOTE PROTOCOL		38
1.1	Supported Command Sequences	38
1.2	Setting the Clock	38

SECTION I: INTRODUCTION TO THE DVR1 SERIES DIGITAL VIDEO RECORDERS

1.1 Guide to This Manual

This manual contains all of the information necessary to safely install, program, and operate Bosch DVR1 Series Digital Video Recorders. Step-by-step procedures and sample menus guide you through each phase of the DVR1's setup and programming.

The DVR1 package includes the Remote Viewer software, which allows remote access to a DVR1 through a network interface. Complete installation and operation instructions for the Remote Viewer program are included in this manual.

1.2 Unpacking

Unpack carefully. This is electronic equipment and should be handled with care to prevent damage to the unit. Check for the following items:

- ✓ Digital Video Recorder unit
- ✓ Installation Instructions (this manual)
- ✓ Accessories PCB (printed circuit board)
- ✓ One (1) 12-volt power supply with two (2) power cables
- ✓ Rack mount kit
- ✓ Wave Reader software (CD)
- ✓ Wave Reader Manual
- ✓ Wave Watch Manual

If any items appear to have been damaged in shipment, replace the item(s) properly in the shipping carton and notify the shipping company. If any items are missing, notify your nearest Bosch Security Systems, Inc. Sales Representative or Customer Service Representative:

The Americas: 1 800 326 3270

Europe & Middle East: 31 40 278 1222

Asia Pacific Region: 65 350 1859

NOTE: The shipping carton and all packing materials should be retained, in case transporting the unit is necessary. This will ensure safe transport of all components.

1.3 Understanding the DVR1 Series

The DVR1 Series of Digital Video Recorders provide a digital alternative to traditional time-lapse VCRs. Digital video recording allows continuous recording on a hard disk, eliminating the need to replace or rewind videotapes. The DVR1 Series provide menu-based search capabilities for recorded events, as well as access to live or recorded data via the Ethernet.

Additionally, the DVR1 Series offer the following operating features:

- Single-channel composite or S-video input/output connections.
- Ample hard disk storage: 80GB for **DVR1EP08**; 160GB for **DVR1EP16**; 320GB for **DVR1EP32** & **DVR1EP32A**.
- Accepts a single camera or multiplexed inputs from most popular multiplexers.
- Multiple recording rates from 0.1 up to 60 pictures per second (pps; also referred to as images per second, or IPS).
- Two hard disk recording modes: continuous recording (overwrite mode) or no overwrite.
- Two recording quality modes: S-video or VHS.
- Compatibility with many archiving devices (see **Section 4.7**).
- **Remote Viewer** software allows remote viewing of live or recorded images on a PC, as well as many other features (see **Wave Reader Manual [part # 3935 890 44511]** & **Wave Watch Manual [part # 3935 890 44711]**).

NOTE: Refer to the Bosch Web site, www.boschsecuritysystems.com, for a listing of the latest approved external archiving devices.

SECTION 2: INSTALLING THE DVR1

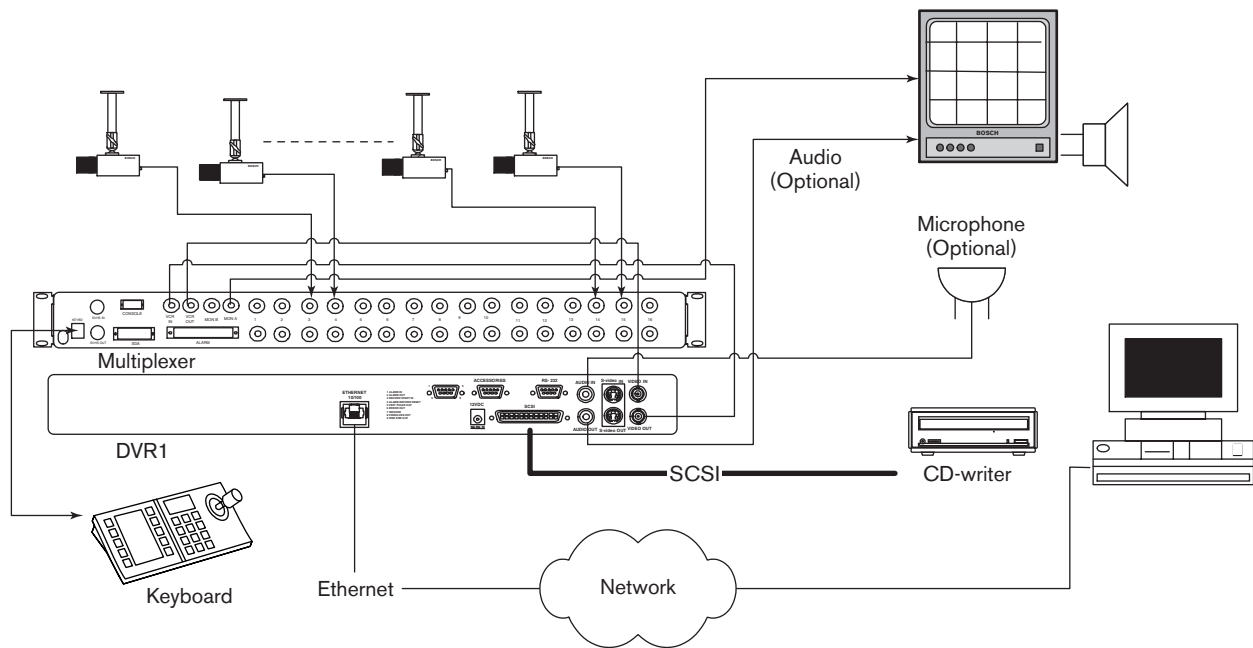

Figure 2A – Sample DVR1 System Installation

Figure 2A provides an illustration of a typical DVR1 system installation. Consider the peripheral devices necessary for your system application, and perform the system connections according to the following installation instructions.

2.1 Mounting

The DVR1 is supplied as a desktop unit. If desired, your unit may be rack mounted using the rack mount kit (included with the unit). Ensure that the mounting/installation location provides adequate ventilation and protection from moisture. Do not obstruct the ventilation holes at the sides of the unit.

2.2 Connecting the DVR1

Rear Panel Connections

1. Refer to **Figure 2B** for details on the input/output connections supplied by the DVR1.

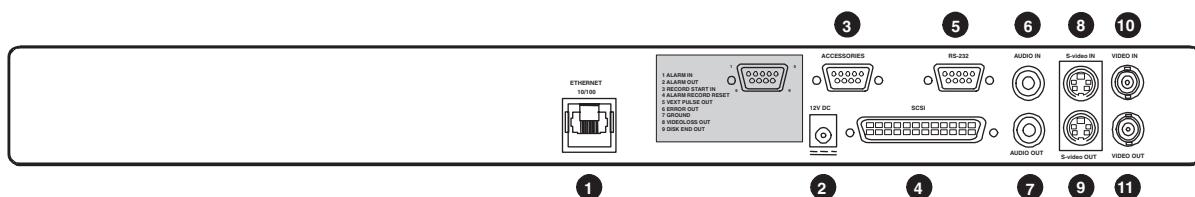

1. **Ethernet Port:** For viewing Live or Recorded Images on a PC via the Ethernet (network).
2. **Power Connector:** Connect 12 Volt DC external power supply (provided).
NOTE: Ensure that the site's AC Power is stable and within the rated voltage of the external power supply. If the site's AC power is likely to have spikes or power dips, use power line conditioning or an Uninterruptible Power Supply (UPS).
3. **Accessory I/O Port:** Used to connect peripheral devices such as alarm devices, alarm relays, or the VEXT (Video External Pulse) connection (see additional pertinent information, including pinout details, in this section).
4. **SCSI Port:** For connecting a SCSI compatible archive device.
5. **RS-232 Serial Port:** Serial port for Flash Upgrading of software. Also used for external control of unit.
NOTE: The RS-232 port does NOT work with a modem. Use a Null Modem type cable (Bosch S1385 cable) to connect to this port.
6. **Audio In (specified version only):** Unbalanced, RCA style jack.
7. **Audio Out (specified version only):** Unbalanced, RCA style jack.
8. **S-video In:** Y/C video input with 4-pin mini-DIN style connector.
9. **S-video Out:** Y/C video output with 4-pin mini-DIN style connector.
10. **Video In:** Composite video input with BNC style connector.
11. **Video Out:** Composite video output with BNC style connector.

Figure 2B – DVR1 Rear Panel Connections

- Connect all peripherals (e.g. cameras, monitors, etc.) to the corresponding inputs/outputs on the DVR1 rear panel.

CAUTION: DO NOT connect both S-video and Composite inputs at the same time. A hardware conflict will occur, which could damage the unit.

- When all connections have been completed, apply power to the system.

S-Video

- Cable must be purchased separately.

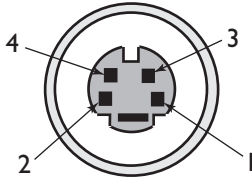

- Pin Signal
- GND (Y)
 - GND (C)
 - Y-signal IN or OUT
 - C-signal IN or OUT

Ethernet Port

Ethernet port uses standard pinout configuration.

- For a DVR1 that connects directly to a Hub, use a straight-through connection.
- For a DVR1 that connects directly to a PC, use a crossover connection.

Accessories Port Connections

The rear panel of the DVR1 is equipped with an Accessories Port (DB-9 style connector). Connect the Accessories PCB (supplied with the unit) to the Accessories Port, then wire all accessories to the Accessories PCB.

If the Accessories PCB is lost or missing, contact Bosch Customer Service for a replacement (Part Number 0900-0127a).

As an alternative to using the PCB connector, you may purchase a female DB-9 connector and perform wiring and connections as detailed in the following pin-out.

Pin 1: Alarm In	Pin 6: Error Out
Pin 2: Alarm Out	Pin 7: Ground
Pin 3: Record Start In	Pin 8: Videoloss Out
Pin 4: Alarm Record Reset (future feature)	Pin 9: Disk End Out
Pin 5: VEXT Pulse Out	Pin 10: Ground

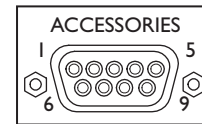

DB-9 Connector on Rear Panel

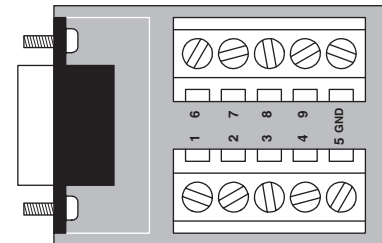

Accessories PCB

NOTE: Refer to the multiplexer and other peripheral device manuals for pertinent connection and synchronization information.

Functional descriptions of the connections provided by the DVR1 Accessories Port follow:

Alarm In: An alarm condition can be activated by an **Active Low TTL** input, or by relay contact devices such as pressure pads, passive infrareds, door switches, or similar devices

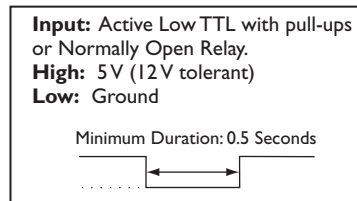

Normally Open Relay Alarm Connection

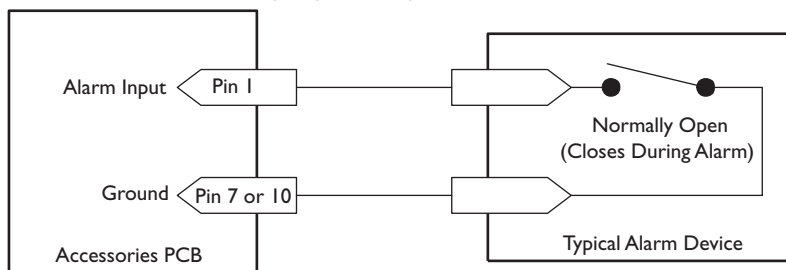

Refer to each alarm device's manual for specific wiring details.

Alarm Out: The **Alarm Output** is activated when a teletext alarm is read, or while the Alarm Input is active. The Alarm output is only active for the duration of the alarm event.

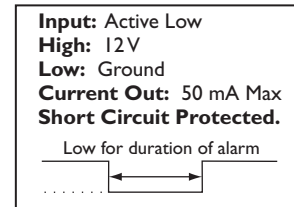

Record Start In: When activated, this connection places the unit in record mode. Compatible with the **Disk End Out** signal from a second unit.

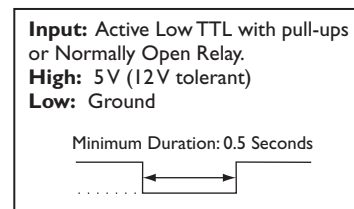

Alarm Record Reset: This feature is for future development and has not yet been implemented.

VEXT Pulse Out: The **Video External Pulse Connection** (VEXT) simplifies multiplexer operation by automatically synchronizing the multiplexer with the DVR1.

The DVR1 sends a VEXT pulse to the multiplexer, indicating that it is ready to record the next image. The multiplexer responds by sending the next image to the **Video Input** on the DVR1.

The VEXT connection is especially beneficial for units configured with dual record speeds (Normal and Alarm).

NOTE: Use of the VEXT connection is highly recommended when connecting the unit to a multiplexer.

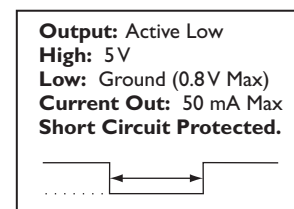

Error Out: The **Error Out** signal is activated when the unit experiences any operational or internal error.

Videoloss Out: The **Videoloss Out** signal is activated when the unit experiences loss of video on the selected video input (Composite or S-video).

In the event of loss of video, **VIDELOSS** will be indicated near the upper left-hand corner of the primary monitor.

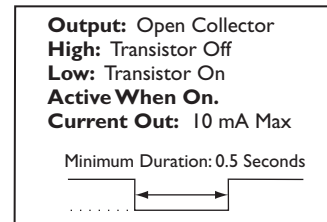

Disk End Out: The **Disk End Out** is activated when there are 5 minutes of recording space left on the hard disk.

SECTION 3: GUIDE TO THE DVRI CONTROLS

Before attempting DVRI programming, you should become familiar with the function of the DVRI controls. This section provides a summary of the front panel controls and indicators, as well as hints for navigating the DVRI menus and entering values via the front panel controls.

3.1 DVRI Front Panel Controls

Figure 3A provides an illustration of the DVRI front panel controls and their functionality. Figure 3B shows the components of the Front Panel LCD display.

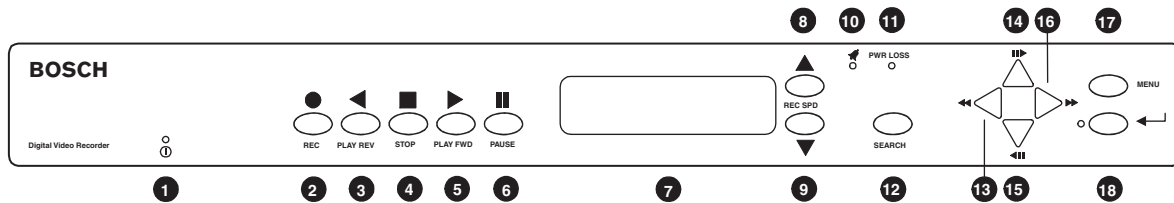

1. **Power On Indicator:** Indicates power is ON when LED is lit.
2. **Record Button:** Press **RECORD** to begin recording.
3. **Play Reverse Button:** Press **PLAY** to play back video in reverse at the normal record speed.
4. **Stop Button:** Press **STOP** to stop recording or playback.
5. **Play Forward Button:** Press **PLAY FORWARD** to play back video at the normal record speed.
6. **Pause Button:** Press **PAUSE** to pause playback.
7. **LCD:** Displays the time, date, mode, and record or playback speed in pictures per second (pps). (Refer to **Figure 3B** for details.)
8. **Increase Record Speed Button:** Press this button to increase the record or playback speed.
9. **Decrease Record Speed Button:** Press this button to decrease the record or playback speed.
10. **Alarm Indicator:** Indicates an alarm condition when this LED is lit.
11. **Power Loss Indicator:** Indicates power loss when this LED is lit.
12. **Search Button:** Press **SEARCH** to enter the search filters menu or to activate certain commands.
13. **Rewind Button:** Press **REWIND** to perform high-speed reverse playback.
NOTE: **Rewind** is also used to navigate the menus and may be referred to in this manual as the **left arrow** button.
14. **Single Frame Advance Button:** Press this button to perform a single frame advance while in Pause mode.
NOTE: **Single Frame Advance** is also used to navigate the menus and may be referred to in this manual as the **up arrow** button.
15. **Single Frame Rewind Button:** Press this button to perform a single frame rewind while in Pause mode.
NOTE: **Single Frame Rewind** is also used to navigate the menus and may be referred to in this manual as the **down arrow** button.
16. **Fast Forward Button:** Press **FAST FORWARD** to perform high-speed playback.
NOTE: **Fast Forward** is also used to navigate the menus and may be referred to in this manual as the **right arrow** button.
17. **Menu Button:** Press **MENU** to enter the menu system. Also used to **EXIT without saving** while in the menu system.
18. **Enter Button and LED Indicator:** Press **ENTER** to make or confirm a selection. When lit, this LED indicates that the menu system is active.

Figure 3A – DVRI Front Panel Controls

3.2 DVRI Front Panel Display

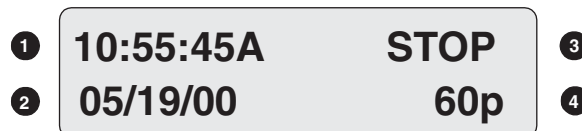

1. **Time:** Displays the current time in **record** and **stop** modes. Displays the time the event was recorded in **play** and **pause** modes.
NOTE: If the letter **A** follows the time (#1 in the above diagram), the unit is configured to record or play back audio.
2. **Date or Capacity:** In **record** and **stop** modes, this field displays the **current** date; in **play** and **pause** modes, it displays the date in which the event was recorded. Or, depending on the programmed **display setting**, this field may show the remaining storage capacity of the hard drive instead (this display is shown in **time** remaining).
3. **Mode:** Displays the current mode that the unit is in.
4. **Record Speed:** Displays the normal record or playback speed in pictures per second (pps).

Figure 3B – DVRI LCD Display

3.3 Navigating with the DVR1 Controls

Navigating and entering parameter values with the DVR1 controls are designed to be easy and intuitive. Most menus use the same navigation for programming operations.

Pull-down Menus

Pull-down menus are the top-level menus, and are accessed by pressing MENU. For example, the following DVR1 Main Menu is a pull-down menu.

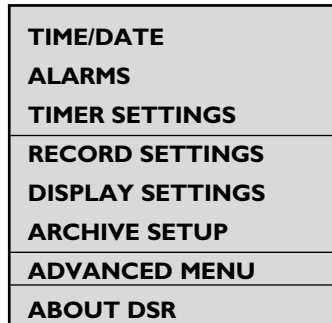

- Use the **Left/Right Arrows** to scroll through the items or fields shown in a menu. When the desired item is highlighted, press ENTER to select that item.
- Choosing an item from a pull-down menu typically leads to a sub-menu (i.e., a **pop-up** menu). Changes to operating parameters are usually made in pop-up menus.
- To exit the program menu or menu level (after all parameter changes have been made), press MENU.

Pop-up Menus

Pop-up menus usually have a parameter(s) from which you can select or change the value. A sample pop-up menu is shown below.

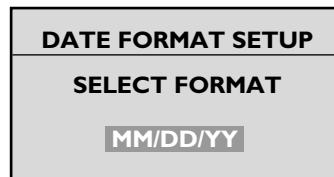

- Use the **Left/Right Arrows** to move between fields in the menu.
- Press ENTER to select any item.
- Use the **Up/Down Arrows** to scroll through the values of that particular parameter.
- **To save changes and exit the pop-up menu:** select [OK] and/or press ENTER.
- **To exit the menu *without making changes*:** press MENU or select [CANCEL], and press ENTER.

Programming Notations in this Manual

Throughout the programming sections in this manual, programming instructions appear in special subheadings, as in the following example:

Main Menu → Record Settings → Normal Record Speed

Meaning: At the **Main Menu**, select RECORD SETTINGS, then ENTER. This opens another menu. In this menu, select NORMAL RECORD SPEED, then press ENTER. A pop-up menu will appear.

On-screen Representations

On-screen representations are shown in this manual as follows (note the distinction between items that appear highlighted on-screen and those that do not):



SECTION 4: DVR1 MAIN MENU PROGRAMMING

4.1 Overview of the DVR1 Main Menu

The DVR1 Series **Main Menu** allows quick and easy programming of vital system data and operating parameters. The following table provides a summary of user actions that are accessible via the DVR1 Main Menu.

User Action	Corresponding Menu Item/Sub-menu
Set Time/Date	TIME/DATE
Configure Alarms	ALARMS
Configure Scheduled Recordings	TIMER SETTINGS
Configure Recording Parameters	RECORD SETTINGS
Configure On-screen Display Options	DISPLAY SETTINGS
Manage Archive Storage	ARCHIVE SETUP
Access the Advanced Menu	ADVANCED MENU
View Important Device Information	ABOUT DSR

NOTE: Upon initial power up, the DVR1 will be set to the factory default parameters (see **Appendix A** for a complete listing of the **Factory Default Settings**).

To access the DVR1 Main Menu, press MENU. The menu below will appear on the system's primary monitor.

TIME/DATE
ALARMS
TIMER SETTINGS
RECORD SETTINGS
DISPLAY SETTINGS
ARCHIVE SETUP
ADVANCED MENU
ABOUT DSR

4.2 Setting the Time/Date

Main Menu → Time/Date

Use this menu to specify the following:

- The time format: 12 or 24 hours.
- The date format: MM/DD/YY, DD/MM/YY, or YY/MM/DD.
- The time: HH/MM/SS.
- The date: MM/DD/YY/DAY.

SET TIME FORMAT
SET DATE FORMAT
SET TIME
SET DATE

4.3 Configuring Alarms

Main Menu → Alarms

Use this menu to specify the following:

- Whether the DVR1 will activate an alarm condition when the unit detects a signal on the **Alarm In** connection of the Accessories PCB. (Parameter: **HARDWIRE ALARM – ENABLE/DISABLE**.)
- Whether the DVR1 will activate an alarm condition corresponding to the teletext alarm signal of a multiplexer or other device. (Parameter: **TELETEXT ALARM – ENABLE/DISABLE**.)
- Whether the DVR1 will sound its internal buzzer during an alarm condition. (Parameter: **ALARM BUZZER – ENABLE/DISABLE**.)

HARDWIRE ALARM ENABLE
TELETEXT ALARM DISABLE
ALARM BUZZER ENABLE
[CANCEL] [OK]

4.4 Configuring Scheduled Recordings

Main Menu → Timer Settings

This menu allows the scheduling of a timed-recorded event. A sample menu is shown here.

DAY	START	STOP	SPD (pps)	QUALITY	ON/OFF
31	16:45	17:05	20	VHS	ON
SAT	7:55	8:10	10	SVHS	OFF
MON-FRI	9:56	11:05	60	VHS	ON
SAT-SUN	14:23	14:50	60	SVHS	ON
MON-SUN	2:23	3:34	20	VHS	OFF
--	--:--	--:--	--	--	--
[OK]					
EDIT MODE		HIT "ENTER" TO TOGGLE EDIT MODE			

The fields to be programmed in the above menu are as follows:

- **Day:** The date or day(s) on which the recording will occur. Choose from the following:
 - 1 through 31 (any period of calendar days named)
 - Monday–Sunday (any individual day)
 - Monday–Friday (weekdays)
 - Saturday–Sunday (weekends)
 - Monday through Sunday (all week long)
- **Start:** Hours/Minutes of the starting time for the scheduled recording (24-hour clock time). Note that hours and minutes are edited separately.
- **Stop:** Hours/Minutes of the ending time for the scheduled recording (24-hour clock time). Note that hours and minutes are edited separately.
- **Spd (pps):** Capture rate for the scheduled, normal recording in pictures per second. Choose from the following:
 - 60, 30, 20, 10, 5, 3, 2, 1, 0.5, 0.2, 0.1, 0.0*

***NOTE:** 0.0 corresponds to **Alarm Only** recording.
- **Quality:** Choose from either **SVHS** (highest picture quality) or **VHS** (standard picture quality, with a longer recording time).
- **On/Off:** Choose from one of three parameters:
 - **On** (recording starts as scheduled)
 - **Off** (recording does not start)
 - **Delete** (all recording schedule parameters are deleted)

NOTE: The fields in the Timer Settings menu can be edited easily using the **Left/Right Arrows** to move between fields and **Up/Down Arrows** to scroll through the various options at each parameter. When you finish setting the parameters, press ENTER. Use the **Left/Right Arrows** to navigate, then highlight [OK], and press ENTER.

4.5 Configuring the Recording Parameters

Main Menu → Record Settings

This menu allows you to set the recording speed and quality for both normal and alarm conditions. Use this menu to specify the following:

- Record input (composite video or S-video) on the DVR1 rear panel.
- Record speed (in pictures per second) for normal recording.
- Record speed (in pictures per second) for an alarm condition.
- Video quality (i.e. compression ratio/image quality) for recorded images (SVHS or VHS). Note that higher compression (VHS) corresponds to standard quality images, with a longer recording time.

<p>RECORD INPUT</p> <p>NORMAL RECORD SPEED</p> <p>ALARM RECORD SPEED</p> <p>VIDEO QUALITY</p>

NOTE: If a **single** camera input is connected to the unit, select **NONE**. See **Section 5.8** for details on Multiplexer applications.

4.6 Configuring On-screen Display Options

Main Menu → Display Settings

Use this menu to specify the status information to be displayed on the primary monitor (usually shown in the upper right or upper left corner of the screen).

Each of the following parameters may be set ON or OFF for the on-screen display:

- Current time and date.
- Remaining amount of time before the hard disk runs out of record capacity (automatically counts down from days/hours to hours/minutes to minutes/seconds).

NOTE: Record capacity will only display if:

- The unit is recording **and**
- The hard disk overwrite mode is set to **no overwrite** or **overwrite once** mode (see Section 5.3).

NOTE: Turning this parameter ON will also show the record capacity on the front panel LCD display, replacing the date field.

- Status of a system archive device connected (i.e. ready/not ready for recording).
- Time and date of the last alarm. Note that the system displays **NONE** if no previous record(s) of alarm(s) exist.
- Record and Playback Speed are displayed
- During Playback, the time/date in which the recording was made.

CURRENT TIME / DATE
RECORD CAPACITY
ARCHIVE STATUS
LAST ALARM
RECORD/PLAYBACK SPEED
PLAYBACK TIME / DATE

4.7 Managing Archive Storage

NOTE: For more information regarding archiving, refer to the **Archiving**.

Due to the complexity of the **Archive Setup** process, detailed instructions follow.

Main Menu → Archive Setup

Use this menu to accomplish the following:

- Select data to be archived and begin the archiving process.
- Restore data from the archive device.
- Turn Background Archiving **On** or **Off**.
- Set Archive Overwrite mode.
- Erase Disk Array.

Main Menu → Archive Setup → Selective Archive

The **Selective Archive** feature allows archiving of recorded data from the hard disk of the DVR1 to an archive device. If the archive device is a CD-writer, you must play back the archived video from a PC's CD-ROM drive using the Remote Viewer software (included with the DVR1 package).

The **Archive Search Filters Menu** allows you to search the hard disk for recorded events (e.g., an alarm condition or a previous recording session), then select those events to be archived for later viewing (note that each activation of **Record** mode is considered to be a separate recording session).

Use this sub-menu to specify:

- Start and stop date of the search.
- Start and stop time of the search.
- Which camera(s) to search.
- A search for recorded alarms.

NOTE: The default settings for **Selective Archive** are set to show a list of all of the files that are on the hard drive. It may be necessary to limit the size of an archive file so that it will fit on the archive medium. The file size for archiving (time span) can be customized by designating start/stop time and date within the archive search filters window. File size can be further reduced by specifying only the cameras of interest.

SELECTIVE ARCHIVE
RESTORE FROM ARCHIVE
BACKGROUND ARCHIVE
ARCHIVE OVERWRITE MODE
ERASE ARCHIVE MEDIUM

ARCHIVE SEARCH FILTERS	
START DATE: 12/25/00 [] (MM/DD/YY)	STOP 01/01/01 [] (MM/DD/YY)
START TIME: 11:11:21 []	STOP 12:34:34 []
1 2 3 4 5 6 7 8 CAMERA: [][][][][][][][]	
ALARM: []	
[CANCEL] [START SEARCH]	

When all required search criteria has been entered, highlight [START SEARCH], then press ENTER. The **Archive Search Results** window will appear.

ARCHIVE SEARCH RESULTS			
	START DATE	START TIME	SIZE (MB)
000	11/28/00	17:52:14	26842 []
001	11/29/00	9:35:20	2062 []
002	11/29/00	10:00:04	278 [X]
003	11/29/00	10:03:25	66 [X]
			SELECTED [383](MB)
			AVAILABLE ON TARGET MEDIUM [652](MB)
"ENTER" TO PLAY		"SEARCH" TO ARCHIVE	

Use the **Left/Right Arrows** to navigate the **Search Results** menu, highlighting the recorded event you wish to select. Use the **Up/Down Arrows** to select a recorded event by placing [X] in the check box.

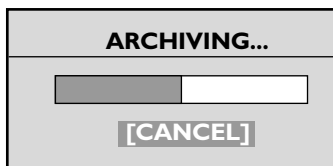

To begin archiving the selected event(s), press SEARCH. The Archiving progress bar will appear. Press ENTER to cancel archiving at any time.

When the unit has finished archiving, the **Archiving Completed** message will appear. Press ENTER to acknowledge the message and complete the archiving process.



Main Menu → Archive Setup → Restore From Archive

This menu is used to either play back archived video from a disk array archive, or restore the video to the DVR1's hard drive.

NOTE: If video was archived on a CD-ROM, you must play back video from a PC using the Remote Viewer software (no audio capabilities are present in this archive format).

The **Restore Search Filters** menu functions similar to the **Archive Search Filters** menu (as described previously). When the search completes, a **Restore Search Results** menu appears.

RESTORE SEARCH FILTERS	
START DATE: 12/25/00 [] (MM/DD/YY)	STOP 01/01/01 [] (MM/DD/YY)
START TIME: 11:11:21 []	STOP 12:34:34 []
1 2 3 4 5 6 7 8 CAMERA: [][][][][][][][]	
ALARM: []	
[CANCEL]	[START SEARCH]

Main Menu → Archive Setup → Background Archive

This archive feature enables automatic and continuous archiving in the *background* while other system operations continue (i.e., all information going to the DVR1 hard drive is continuously sent to the DVAA Series Disk Array). If this mode is enabled, the archive device must provide the required data transfer and storage capacity.

NOTE: Background Archiving should never be used with CD-writer archive devices or with the unit recording at the 60 ips recording rate.

Main Menu → Archive Setup → Archive Overwrite Mode

This setting determines what happens when the archive device is full. The three options are: **Write once**, **No overwrite**, and **Continuous**.

- **Write Once:** When the archive device is full, archiving stops. Archiving will resume after the user acknowledges that the archive device is full and that archiving should resume.
- **No Overwrite:** When the archive device is full, archiving stops. Archiving will resume only after a user enters the advanced menu, manually erases the media, and resumes archiving.
- **Continuous:** When the archive device is full, archiving will continue, writing over the oldest video first.

Main Menu → Archive Setup → Erase Archive Medium

The Erase Archive Medium feature is used to erase the archive media.

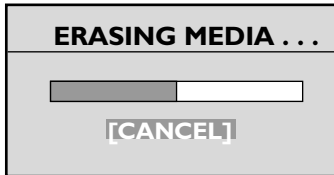

NOTE: Before starting the erasing process, the DVR1 must be set to **Selective Archive**, and **Background Archive** must be set to **OFF**.

To erase the archived data, press **ENTER**. The **Erasing Media** progress bar appears. Press **ENTER** to cancel.

When the unit is finished erasing the pointers to the data, the message box at right appears. Press **ENTER** to acknowledge the message.

4.8 Accessing the Advanced Menu

For information on accessing the **Advanced Programming** menu, please refer to **Section 5** in this manual. Note that the **Advanced Menu** is password protected.



4.9 About DSR

Main Menu → About DSR

This screen allows the user to view important device information at a single glance.

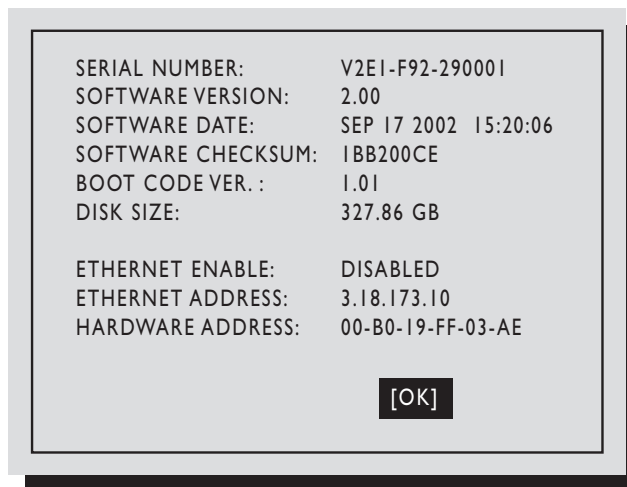

SECTION 5: DVR1 ADVANCED MENU PROGRAMMING

5.1 Overview of the DVR1 Advanced Menu

Enhanced DVR1 operating features are programmed via the **Advanced Menu**. The following table provides a summary of these actions that are accessed via the DVR1 Advanced Menu.

User Action	Corresponding Menu Item/Sub-menu
Overwrite the Hard Disk	DISK OVERWRITE MODE
Erase, Delete, and Recover Hard Disk Data	DISK MAINTENANCE
Invoke Audio Recording	AUDIO RECORD SETTING
Use the Auto Delete Feature	AUTO DELETE MODE
Configure Communications	COMMUNICATIONS
Configure Multiplexer Format	MULTIPLEXER FORMAT
Adjust Picture Qualities	ADJUST PICTURE
Lock Out the Front Panel	FRONT PANEL LOCK
Restore Factory Defaults	FACTORY SETTINGS
Change the Password	CHANGE PASSWORD

Press **MENU** to enter the DVR1 Main Menu. Use the **Left/Right Arrows** to highlight the **ADVANCED MENU** title and press **ENTER**. The Advanced Menu (shown below) appears.

DISK OVERWRITE MODE
DISK MAINTENANCE
AUDIO RECORD SETTING
AUTO DELETE MODE
COMMUNICATIONS
MULTIPLEXER FORMAT
ADJUST PICTURE
FRONT PANEL LOCK
FACTORY SETTINGS
CHANGE PASSWORD

IMPORTANT NOTE: Please review the information in **Section 3** regarding navigation through the DVR1 menus. **Advanced Menu programming should be designated to qualified systems personnel only.**

5.2 DVR1 Passwords

The DVR1 Series is equipped with two (2) passwords.

The first password provides access to the DVR1's **Advanced Menu**. This password can be changed by the System Administrator to prevent unauthorized access to the Advanced Menu functions. Store the password in a secure location. The default password for the Advanced Menu is **0000**, as stated in **Section 5.11**. The second password is used to set the DVR1 to its original factory default settings. This password cannot be altered and is set (permanently) at **0000**.

Accessing the Advanced Menu Using the Password

1. Select **ADVANCED MENU** from the **Main Menu**, then press **ENTER**. The **Password Box** appears.
2. Enter the Advanced Menu password. Use the **Up/Down Arrows** to select a character, then press **ENTER** to move to the next character.
3. Pressing **ENTER** on the last character completes password entry. If the password was correctly entered, the Advanced Menu is displayed.

PASSWORD BOX
PLEASE ENTER THE PASSWORD!
- - - -

5.3 Overwriting the Hard Disk

Advanced Menu → Disk Overwrite Mode

Use this menu to specify how disk overwrite issues are handled once the hard disk becomes full. Select one of three options:

- **No Overwrite** (i.e., recording stops when the disk is full). An on-screen message indicates when the disk is full and the unit has stopped recording. You must acknowledge the message by pressing **ENTER**. Note that recording will not continue until the data is either erased or deleted.
- **Overwrite Once**. Recording always starts at the end of the last recording. The unit overwrites all previously recorded data, then stops before it overwrites any newly recorded data (from the current record session). When the end of the disk is reached, the unit displays an on-screen message stating that the disk is full. You must acknowledge the message by pressing **ENTER**. Note that recording will not continue until **RECORD** is pressed.
- **Continuous Overwrite**. Recording always starts at the end of the last recording. When the disk is full, recording continues by overwriting the oldest video first. In this mode, the unit never stops recording (note that the LCD display does not count down the remaining time till the hard disk is full).

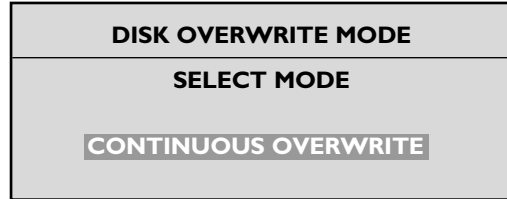

5.4 Erasing, Deleting, and Recovering Hard Disk Data

Advanced Menu → Disk Maintenance

Three options are provided for disk maintenance:

- **Delete Video**: Once video has been deleted, it may be restored with the **Undelete** option if the video has not been overwritten.
- **Undelete Video**: Restores video if it has not yet been overwritten.
- **Erase Video**: Video is removed with no possibility of restoration.



5.5 Invoking Audio Recording

Advanced Menu → Audio Record Setting

Use this menu to accomplish the following:

- Select **OFF** to disable the audio recording capability.
- Select **G.711** to enable the audio recording capability.



5.6 Using the Auto Delete Feature

Advanced Menu → Auto Delete Mode

Configuring the unit with the **Auto Delete** mode **ON** prevents the unit from displaying or archiving any data that is more than 30 days old. This feature may be required by law in some jurisdictions; please consult your local authority. Choose from 7 to 99 days, or **OFF** (**30 Days** is the default setting).

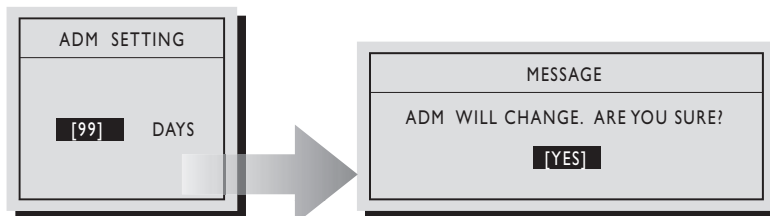

5.7 Configuring Communications

Advanced Menu → Communications

Use this menu to specify the following (select one only):

- Data transfer rate for the RS-232 serial port (select 1200 to 57,600 baud).
- Enable or disable Ethernet connection (network address) settings for the unit.
 - IP address, Subnet Mask, and Gateway. Contact your IT department for details regarding basic network configuration.
- POTS Setup (Plain old telephone system): The default modem string (shown below) is for use with Hayes Accura 56k, Diamond Supra Express 56k, and 5686 US Robotics modems in their default conditions. Consult the modem manual before making any changes. It is strongly recommended that the modem initialization string only be modified by a qualified technician.

BAUD RATE
ETHERNET SETTINGS
MODEM SETTINGS

ETHERNET SETTINGS		
ETHERNET	:	DISABLE
IP ADDRESS	:	10. 90.253.000
SUBNET MASK	:	255.255. 0. 0
GATEWAY	:	10. 90. 0. 1
[CANCEL}		[OK]

POTS SETUP

MODEM INIT STRING : AT&F1&K3M0EIQ0VISO=0&R2&C1&D0&H1

[DEFAULT MODEM STRING] [CANCEL] [OK]

@ABCDEFGHIJKLMN0PQRSTUVWXYZ [\] ^

5.8 Configuring the Multiplexer Format

Advanced Menu → Multiplexer Format

The DVR1 Series recorders are compatible with several brands of multiplexers. Use this menu to specify the type of multiplexer connected to the DVR1. *Making the correct selection for your system configuration ensures proper playback.*

NOTE: If a single camera input is connected to the unit, select **NONE**.

NOTE: The list of compatible multiplexers continues to expand. Please see the Bosch Web site at www.boschsecuritysystems.com for the most current listing.

5.9 Adjusting Picture Qualities

Advanced Menu → Adjust Picture

Use this menu to specify the Brightness, Contrast, and Saturation of the video input. Adjustments made to the video input affect images being recorded, as well as the current display.

For each of these parameters, use the **Left/Right Arrows** to navigate the fields in the sub-menu. Use the **Up/Down Arrows** to increase/decrease the setting.

5.10 Locking Out the Front Panel

Advanced Menu → Front Panel Lock

This menu option locks or unlocks the front panel. *Exception:* the Main Menu will still display when MENU is pressed.

NONE
KALATEL
ROBOT
DM
BOSCH
PELCO
SANYO
PHILIP'S
OBSERVATION
SYSTEM
NAVCO
ATV
ATV QSP
VISTA VLM
QSI

BRIGHTNESS
CONTRAST
SATURATION

UNLOCK KEYBOARD
LOCK KEYBOARD

5.11 Restoring Factory Defaults

Advanced Menu → Factory Settings

Use this menu to restore the DVR1 to the factory defaults.

NOTE: When the factory settings are restored, all programmed settings and volume partitions for archive retrieval are erased.

The factory password is fixed at **0000**. Therefore, you can repeatedly press **ENTER**, and press **ENTER** to complete entry and restore the unit to its factory default settings.

PASSWORD BOX
PLEASE ENTER THE FACTORY PASSWORD
<input type="text" value="0---"/>

5.12 Changing the Password

Advanced Menu → Change Password

Use this menu to change the **Advanced Menu Password**. It is recommended that the System Administrator change this password to prevent unauthorized access to the menu.

Use the **Up/Down Arrows** to select a character, then press **ENTER** and move to the next character.

Pressing **ENTER** on the last character opens the **Confirmation Box**.

Reenter the New password.

Pressing **ENTER** on the last character completes the password selection.

If the password in the **Confirmation Box** *matches* the password from the **Password Box**, the message at right will appear.

Press **ENTER** to select [OK] and exit the menu.

PASSWORD BOX
ENTER A NEW PASSWORD
<input type="text" value="0---"/>

CONFIRMATION BOX
PLEASE RE-ENTER THE PASSWORD
<input type="text" value="0---"/>

MESSAGE
THE NEW PASSWORD HAS BEEN ACCEPTED
[OK]

If the password in the **Confirmation Box** does *not* match the password from the **Password Box**, the message at right will appear.

Press **ENTER** to select [OK] and exit the menu.

MESSAGE
THE PASSWORD WAS NOT CHANGED!
[OK]

SECTION 6: OPERATING THE DVRI SERIES

Operating the DVR1 requires general knowledge in three areas:

- Recording
- Playback
- Searching

Certain operating parameters must be set/programmed as part of initial startup of the DVR1. These activities are outlined in the following section.

6.1 Initial Startup

On initial power-up of the DVR1, the following settings must be programmed:

- Time/Date
- Alarms
- Password

Please refer to **Main Menu Programming, Section 4** for detailed information regarding these functions.

6.2 Recording

To begin recording, press **REC**. The message, **RECORD** appears briefly in the upper left-hand corner of the primary monitor. The unit always starts recording at the end of the previously recorded data.

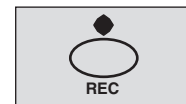

Record Button

Recording continues until one or more of the following occurs:

- Another mode is selected.
- The disk is full (**No Overwrite** and **Overwrite Once** modes). See **Section 5.3** for details regarding **Disk Overwrite** modes.
- Video loss is detected. In the event of video loss, **VIDEOLOSS** will be indicated in the upper left-hand corner of the primary monitor.

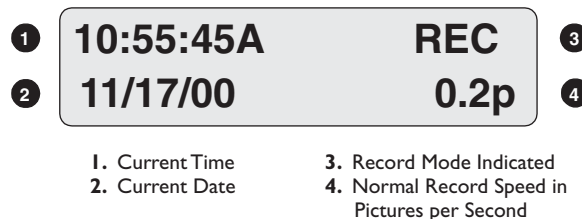

Figure 6A - LCD in Record Mode

Normal Recording

The unit records at the normal record speed until an alarm condition is detected. The normal record speed is indicated on the LCD and can be altered using **Up/Down Record Speed**, or in the menu system.

For information about altering the normal record speed from the menu system, see **Section 4.5**.

The normal record speed can be altered while the unit is recording. The unit continues recording while the menu system is active.

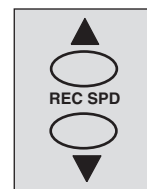

Record Speed Buttons

Alarm Recording

When an alarm condition is detected, the unit automatically switches to the alarm record speed. The alarm condition is indicated in several ways:

- The word **ALARM** is displayed on the primary monitor, in the upper left-hand corner of the screen.
- The red **LED Alarm Indicator** on the front panel of the unit is lit.
- The internal buzzer sounds, if activated via the menu. For information about activating the internal buzzer during alarms, see **Section 4.3**.
- By an external device connected to the alarm output of the unit (if the unit is configured with an alarm output).
- The alarm record speed cannot be changed using **Up/Down Record Speed** on the front panel; it must be changed via the menu system. See **Section 4.5** for details.
- The front panel LCD displays the record speed during an alarm condition. The unit returns to the normal record speed once the alarm condition ends.



Alarm Indicator

Disk Full Notification

This message will appear on the primary monitor to indicate that the unit has stopped recording because the disk is full.

In **No Overwrite** mode, the unit will not record over previously recorded data. To continue recording, the user must acknowledge the *disk full* message by pressing **ENTER**, then **ERASE** (or **DELETE**).



In **Overwrite Once** mode: The user must acknowledge the on-screen message by pressing **ENTER**.

The unit will resume recording when the user presses **RECORD**.

6.3 Playback

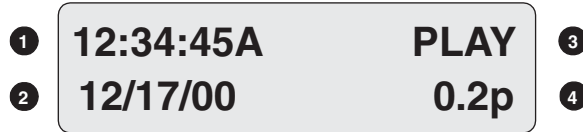

1. Time the Data was Recorded
2. Date the Data was Recorded (If the letter **A** precedes the record rate, the unit is configured to record or play back audio).
3. Play Forward Mode Indicated
4. Normal Record Speed in Pictures per Second

Figure 6B - LCD during Playback

Play Forward

To begin normal playback in the forward direction, press **Play Forward**.

Playback is indicated via the following:

- **PLAY** appears briefly in the upper left-hand corner of the primary monitor.
- **PLAY>** appears on the LCD.

Reverse Play

To begin reverse playback, press **Play Reverse**. Reverse playback is indicated via the following:

- **REVERSE PLAY** appears briefly in the upper left-hand corner of the primary monitor.
- **PLAY<** appears on the LCD.

If there is only one recording session on the hard disk, the unit will indicate **START OF DATA** on the primary monitor.

Playback Speed

The unit plays back the data at the rate at which it was recorded. The user can alter the playback speed using **Up/Down Record Speed**.

Altering the playback speed overrides the speed of any incoming alarms. To clear the override, press **STOP**, then **PLAY** to resume playback at the speed that the data was recorded.

NOTE: For clear audio, playback should be at the same speed at which it was recorded.

Fast Forward

During playback, pressing **Fast Forward** allows viewing of data at a faster than normal rate.

Fast Forward is indicated via the following:

- **FAST FORWARD** appears briefly in the upper left-hand corner of the primary monitor.
- **FFWD** appears on the LCD.



Play Forward Button



Play Reverse Button

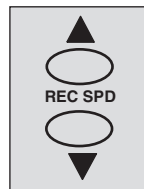

Record Speed Buttons

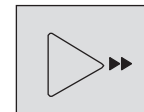

Fast Forward Button

Rewind

During playback, press **REWIND** to view the data (in reverse) at a faster than normal rate.

Rewind is indicated via the following:

- **REWIND** appears briefly in the upper left-hand corner of the primary monitor
- **REW** appears on the LCD.

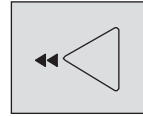

Rewind Button

Pause

During playback, press **PAUSE** to pause playback and display a single frame on-screen.

Pause is indicated via the following:

- **PAUSE** appears briefly in the upper left-hand corner of the primary monitor.
- **PAUSE** appears on the LCD.

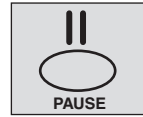

Pause Button

Single Frame Advance & Single Frame Rewind

During **Pause** mode, press **Single Frame Advance** or **Single Frame Rewind** to view the frame directly before or after the frame displayed on-screen.

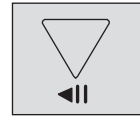

Single Frame Rewind Button

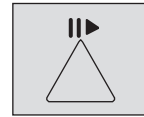

Single Frame Advance Button

Start of Data & End of Data

If the start or end of data is encountered during playback, **START OF DATA** or **END OF DATA** is indicated in the upper left-hand corner of the primary monitor.

6.4 The Search Interface

The **Search Interface** feature allows the user to search the hard disk for recorded events, such as an alarm condition or a previous recording session.



Search Button

NOTE: Each time the **Record** mode is activated, it is considered to be a separate recording session.

To enter the **Search Filters** menu, press **SEARCH**. The Search Filters menu is displayed on the primary monitor.

Use this screen to specify the following:

- Start and stop date of the search.
- Start and stop time of the search.
- Which cameras to search exclusively.
- Which recorded alarms are to be searched.

Use the **Left/Right Arrows** to navigate between the various fields in the menu. Use the **Up/Down Arrows** to scroll through and change the available parameters for each field. When all search criteria has been specified, press **ENTER** to exit the **Edit** mode, then highlight **[START SEARCH]** and press **ENTER**.

SEARCH FILTERS			
	START		STOP
DATE:	12/25/00 []		01/01/01 []
	(MM/DD/YY)		(MM/DD/YY)
	START		STOP
TIME:	11:11:21 []		12:34:34 []
	1	2	3
	4	5	6
	7	8	
CAMERA:	[]	[]	[]
	[]	[]	[]
ALARM:	[]		
	[CANCEL]		[START SEARCH]

The **Search Results** menu will appear.

Use the **Up/Down Arrows** to select a recorded event. Press **ENTER** to select the event, or press **MENU** to exit the **Search Results** menu.

SEARCH RESULTS			
	START DATE	START TIME	DAYS HH MM SS
000	01/01/20	00:07:14	0 00:00:36
001	01/01/20	23:35:20	0 00:08:11
002	02/12/20	23:43:30	0 00:33:49
003	02/12/20	00:17:23	0 01:38:18
"ENTER" TO PLAY EVENT			

SECTION 7: ARCHIVING

7.1 Archiving Applications Explained

The following sections explain the usage of the **Extended Archiving**, **Backup Archiving**, and **Selective/Manual Archiving** applications for the DVR1 Series Digital Video Recorders.

7.1.1 Extended Archiving Applications

- **Explained:** In this application, the DVR is in a **Background Archiving Mode**. Hence, all recorded video is sent to the archive device in a continuous fashion.
- **Typical Usage:** All video recorded on the DVR's hard drive is automatically sent to the archive device. This process continues until the archiving period is met.

7.1.2 Backup Archiving Applications

- **Explained:** This is basically another **Background Archiving Mode**, where all video is sent to the archive device. However, in this case, archiving is used simply to *Back up* the DVR's hard drive.
- **Typical Usage:** In this application, interaction with the archiving device should be minimal. Therefore, when full, the unit prepares for overwriting (oldest data first) and begins the recording cycle all over again.

7.1.3 Selective/Manual Archiving Applications

- **Explained:** If the DVR's internal hard drive provides sufficient storage to accommodate your requirements, then all that is needed is a way to extract specific video events. The following devices can be used for selective archiving.

Device	Advantages
CD-writer	Low cost medium, must be played back at the PC; graphical disk analysis feature of the remote viewer software can be utilized.
PC Software	No cost for archive Device. Use the remote viewer software to retrieve video from the DVR's hard drive to a PC's hard drive (No Disk Analysis feature is available).

- **Typical Usage:** After an incident is identified, the video segment is isolated and then stored on a PC. The file can then be stored on a network or some other storage medium.

7.2 Using CD-Writers

NOTE: It is strongly recommended to use only approved archiving devices, as listed at the Bosch Web site; www.boschsecuritysystems.com.

NOTE: For complete instructions on how to use your CD-writer, please refer to the manufacturer's instruction manual.

7.2.1 Minimum Requirements

The following lists the minimum requirements when using a CD-writer.

- **Minimum Write Speed:** 4X.
- **Minimum Read Speed:** 16X.
- **Interface:** SCSI-2.
- **Medium:** CD-R, CD-RW.

7.2.2 Connecting the CD Recorder

1. Connect an appropriate SCSI cable from the CD-writer to the SCSI port of the digital recorder (digital video recorders require a standard 50-pin high density male SCSI-2 connector).
2. Set the CD-writer's SCSI address to zero (0).



CAUTION: The SCSI device address **MUST** be set to zero (0) or the device will not be recognized. Consult the device's manual for instructions on setting the address. Units are not always shipped with the address set to zero.

3. Ensure the SCSI cable is properly terminated at 110 Ohms. If the CD-writer does not have a built-in termination, then a terminator will be needed.



CAUTION: The SCSI bus must be terminated properly, otherwise the system will not operate properly. Units are not always packaged with the cables and terminators.

4. Using the DVR's (DVR1 or DMX) menu system, set the unit for **Selective** archiving.
5. Remove power from the DVR unit.
6. Apply power to the CD-writer and allow it to initialize.
7. Apply power to the DVR unit.
8. Be sure that the CD-writer is recognized by the DVR unit. This may take a few minutes (to view the archive status, enable the **Archive Status** display via the menus of the DVR unit).
9. Before archiving, make sure the CD is properly inserted into the unit. Otherwise, an **ARCHIVE NOT READY** error message will appear.

7.3 Creating a CD-ROM with Video Files

1. Set the digital video recorder for **Selective Archive** operation.
2. Open the search menu of the DVR and select the file(s) for archiving.
 - Be aware that a CD can hold only about 550 MB (including housekeeping restrictions, while there are several Gigabytes in the digital recorder).
 - If the search shows a file that is larger than this, it will be necessary to *filter* the search (place tighter restrictions on it) until the search results return a file size that can be archived.
 - When multiple small files are selected for archive, the total available space on the CD must be less than 550 MB.
 - CD archiving supports multiple sequential recording sessions. This allows the recording of a video clip, ejecting the CD, inserting the same CD at a later time for the recording of sequential video clip(s).
3. Initiate Archiving.
 - While the CD-writer is recording, the DVR unit indicates the progress of the CD-write operation.
 - While the CD-RW is still in the CD-writer, multiple files can be recorded onto the CD-RW medium.

7.4 Limitations on CD Operations

- Restoring (copying a wavelet file with a .60d extension from the CD to the digital recorder hard disk drive) is not supported.
- Erasing a wavelet file with a .60d extension on CD is not supported.
- Playback of .60d extension files stored on a CD from a digital recorder is not supported. These files are to be played back from a PC running the remote viewer software.
- Background archiving to CD disk is not supported.
- While archiving a CD, the unit can not record to hard disk.

SECTION 8: SERVICE AND RETURNS

8.1 Maintenance

Programmer maintenance of this unit is limited to external cleaning and inspection.

8.2 Factory Service

Ensure that the cooling vents are not blocked and that the unit is installed in a well ventilated location. In addition, do not place the unit on top of other equipment, which may increase the operating temperature of the unit.

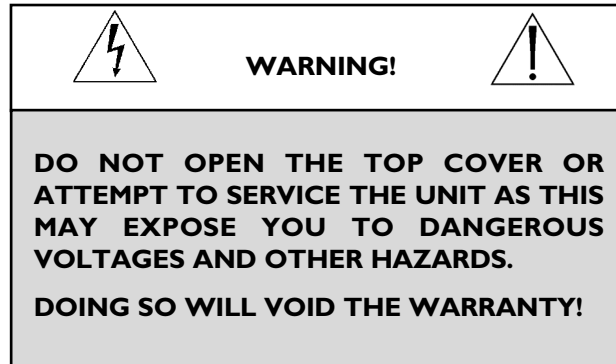

Refer all servicing to qualified personnel.

Contact the local Bosch Representative for Services.

Service Centers

USA: Phone: 800-366-2283 or 717-735-6638

fax: 800-366-1329 or 717-735-6639

CCTV Spare Parts

Phone: 800-894-5215 or 408-956-3853 or 3854

fax: 408-957-3198

e-Mail: BoschCCTVparts@ca.slr.com

Canada: 514-738-2434

Europe, Middle East & Asia Pacific Region:

32-1-440-0711

For additional information, see www.boschsecuritysystems.com.

***All of our products now
come with a 3 year warranty.**



*recorder heads, monitor tubes, and
TC model pan/tilts are the only exceptions
and carry a one year warranty.

APPENDIX A: FACTORY DEFAULT SETTINGS

FUNCTION	SETTING
Time Format	24 Hour
Date Format	MM / DD / YY
Normal Record Speed	60 pictures per seconds (NTSC) or 50 pps (PAL)
Alarm Record Speed	60 pictures per seconds (NTSC) or 50 pps (PAL)
Record Quality	SVHS
Disk Overwrite Mode	Continuous Overwrite
Archive Overwrite Mode	Continuous Overwrite
Auto Delete Mode	30 Days
Background Archive Mode	Off
Input	Composite
Front Panel Locked	Off
Brightness	50%
Contrast	50%
Saturation	50%
Display Current Time and Date	Off
Display Record Capacity	Off
Display Archive Status	Off
Display Last Alarm	Off
Record/Playback Speed	Off
Display Playback Time and Date	Off
Baud Rate	9600
Hardwire Alarm	Enabled
Teletext Alarm	Enabled
Alarm Buzzer	Disabled
Multiplexer	None
Audio	Off

APPENDIX B: TECHNICAL SPECIFICATIONS

GENERAL	
Power Supply	90 V-264 VAC/DC
Input Voltage	12 Volt DC
Power Consumption	For One (1) Disk Unit, 35 Watts Max; For Two (2) Disk Units, 55 Watts Max
Operating Temperature Range	Operating: 0 to 40 °C Storage: -20 to 60 °C
Relative Humidity Range (Noncondensing)	Operating: 10% to 80% Storage: 10% to 95%
Dimensions	Inches: 17.5 x 14 x 1.75 mm: 444 x 356 x 44
Weight	DVR1 & DVR1EP = (5.2 kg) 11.46 lb All Other Models = (5.98 kg) 13.8 lb

CONNECTIONS	
Ethernet Port	RJ-45 10/100BaseT compatible
Power Connector	2.1 mm Barrel Connector, Center Positive
Accessory I/O Port	DB-9 Connector
SCSI-2 Port	50-pin male high density, SCSI-2 connector
RS-232 Serial Port	DB-9 Connector
S-Video In	4-pin mini-DIN connector (see caution below)
S-Video Out	4-pin mini-DIN connector
Composite Video In	BNC connector (see caution below)
Composite Video Out	BNC connector

CAUTION: Do not connect both video inputs at the same time.

AUDIO/VIDEO	
Video Signal Input	0.7 to 1.4 Volts peak-to-peak, with Automatic Gain Control
Video Signal Output	1 Volt peak-to-peak into 75 ohm
Termination	75 ohm
Colors	Y:U:V 4:4:2, 16.8 Million Colors
Gray Scale	256 Levels
Horizontal Resolution	720 Pixels (NTSC & PAL)
Vertical Resolution	484 Lines (NTSC) 586 Lines (PAL)
Compression Standard	Video = Wavelets Audio = G.711
Audio In	RCA jack, 315 mV, 40 kΩ, unbalanced
Audio Out	RCA jack, 315 mV, 600 Ω, unbalanced

ON-SCREEN VIDEO INDICATORS		
Archive Status	Pause	Rewind
End of Data	Play	Start of Data
Fast Forward	Record Capacity	Time and Date
Last Alarm	Reverse Play	Video Loss

PART NUMBERS	
Power Supply	For DVR1 (All Models): Leader N60-120500 For DVAA Disk Arrays (All Models): TOP-250SSA (4010-0019)
Accessories PCB	0900-0127a
Rack Mount Kit	0110-R301. Fits 1U, 19-inch rack unit.
Installation Instructions (this manual)	3935 890 3681#, where # is incremented with each revision cycle.
Wave Reader Manual	3935 890 4451#, where # is incremented with each revision cycle.
Wave Watch Manual	3935 890 4471#, where # is incremented with each revision cycle.
Wave Reader Software CD	0151-0003

APPENDIX C: OBSERVATION SYSTEM QUICK INSTALL GUIDE

1.1 Introduction

This guide provides the steps necessary to install the DVR1 in combination with a Observation System Multiplexer or Switcher Monitor. If you are not familiar with the operations of the DVR1 and the Observation System Monitor, refer to the corresponding instruction manuals.

1.2 Required Software Version

Product	Software Version
DVR1 (all models)	1.14 or higher (available at www.boschsecuritysystems.com)
Observation System Multiplexer Monitor	2.01c or higher
Observation System Switcher Monitor	1.00 or higher

Ensure that the DVR1 and Observation System monitor's software version is equal to or higher than noted below.

1.3 Installation

1.3.1 Connection of Audio/Video Cable (A/V Cable)

To record camera images, the Observation System VCR In/Output allows connection of the DVR1. Connect the Mini Din plug to the VCR connector of the System Monitor.

1. Connect the BNC connectors to the **VIDEO IN** and **VIDEO OUT** of the DVR1.

ATTENTION:
 **VIDEO IN** of the A/V cable must be connected to **VIDEO OUT** of the DVR1.
VIDEO OUT of the A/V cable must be connected to **VIDEO IN** of the DVR1.

2. Connect the black VEXT cable (located in the A/V cable) to the VEXT-pulse output of the DVR1 (**Pin 5 of Accessories port**) for proper synchronization between the System Monitor and DVR1.
3. If the DVR1 also has audio recording capabilities, connect the RCA connectors to **AUDIO IN** and **AUDIO OUT** of the DVR1.

ATTENTION:
 **AUDIO IN** of the A/V cable must be connected to **AUDIO OUT** of the DVR1.
AUDIO OUT of the A/V cable must be connected to **AUDIO IN** of the DVR1.

1.3.2 Connection of Alarm Contact

In case of an alarm, the output relay contact of the Observation System Monitor can change the recording speed from **Normal** recording to **Alarm** recording until the alarm is acknowledged by the user or automatically resets after the programmed alarm time has expired.

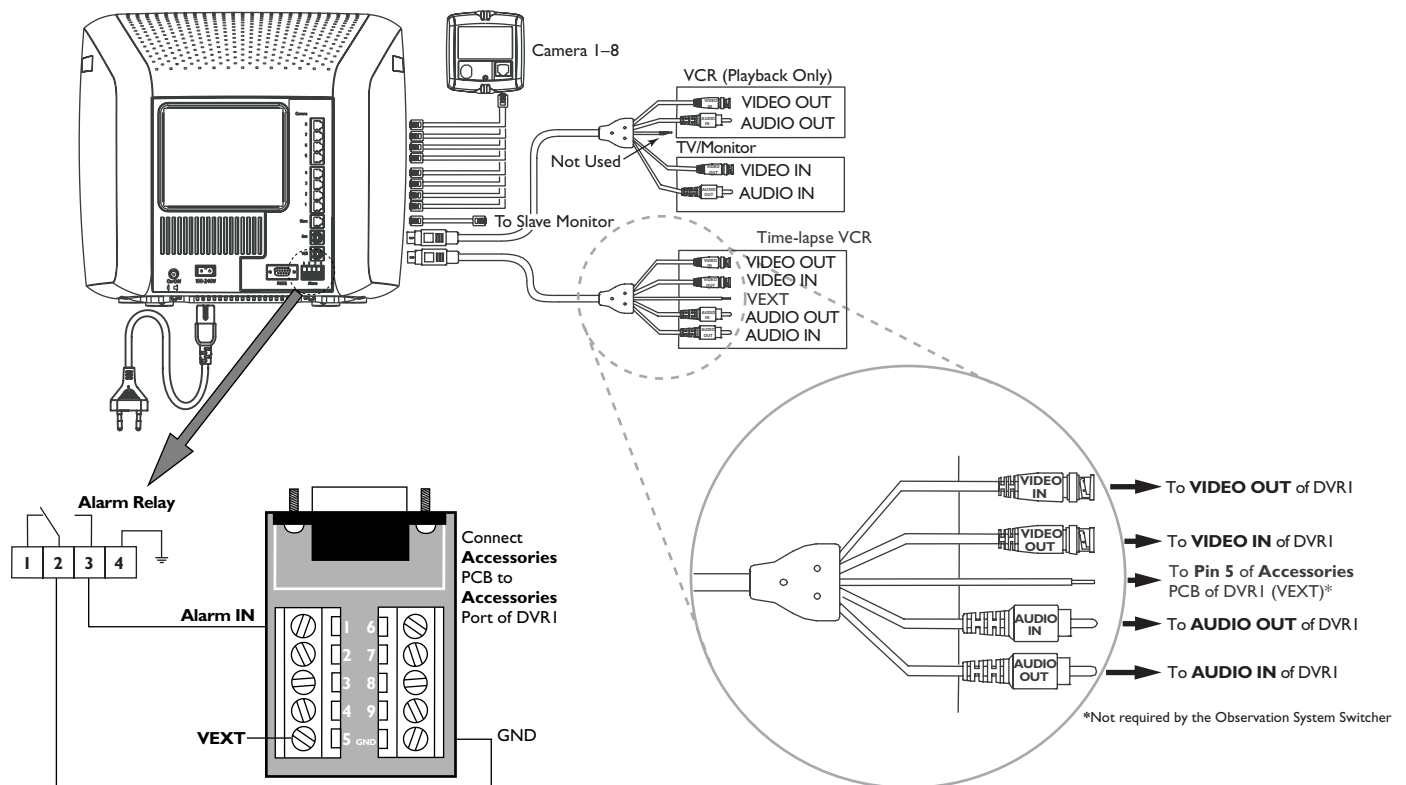

1.4 Programming the Observation System monitor

No special programming is required for the Observation System Switcher. If using the Observation System Multiplexer, ensure that the *Record* mode is set to **Multiplexing** (verify this via the Observation System Main Menu > Settings > VCR).

1.5 Programming the DVR1

To view the DVR1's menu screen using the Observation System Monitor:

- On the Observation System Monitor, press **MENU > SWITCH TO PLAYBACK VIEW**
- On the Observation System DVR1:
 - Select **MENU > ADVANCED MENU**, then press **ENTER**
 - Enter the correct password (default is 0000) and **ENTER**
 - Press **ENTER** to access the *Advanced Menu*
 - Select **MULTIPLEXER FORMAT**, then **ENTER**
 - Select **BOSCH OBSERVATION SYSTEM**, then **ENTER**
 - Press **MENU** twice to exit.

1.6 Remote Viewing Considerations

The following pertains to the **Remote Viewer Software** (included with the DVR1; allows Remote Viewing of video via a PC with this software loaded).

The Ethernet port connection depends on the network configuration:

- For a DVR1 connected directly to a Hub, use a *Straight Through* cable.
- For a DVR1 connected directly to a PC, use a *Crossover* cable.
- For a DVR1 connected via standard phone line (POTS) using LAN modems, refer to the Bosch Security Systems, Inc. Web site.* A PSTN-LAN* modem can be used for remote access to one of the Bosch digital products through a POTS line.
- For a DVR1 connected via standard phone line (POTS) using standard modems, see **Section 5.7** for modem models. A standard DB9 Female to DB25 Male modem cable will also be required for modem communications.

*Refer to our Web site at www.boschsecuritysystems.com under **Tech Tips, #12 Applications Notes, 3COM OfficeConnect 56K LAN Modem**.

APPENDIX D: INSTALLATION GUIDE FOR THE COMBINED BOSCH MULTIPLEXER, INTUIKEY KEYBOARD & DVR1 SERIES SYSTEM

1.1 Overview

The latest software for the Bosch *System4*® Multiplexers, IntuiKey Keyboard, and DVR1 greatly improves the functionality of the system. This new software simplifies retrieval of the DVR1's recorded video via the IntuiKey keyboard.

1.2 Required Software Version

Ensure that the keyboard, DVR1, and Bosch Multiplexer software versions are equal to or higher than those noted below. Software for these products is available at www.philipscsi.com.

Product	Software Version
System4 Multiplexer	3.05 or higher
IntuiKey Keyboard (all models)	1.03 or higher
DVR1 (all models)	1.14 or higher

1.3 Installation

1. Connect an RS-232 null modem cable (Bosch model #S1385) from the Multiplexer's Console port to the DVR1's RS-232 port.
2. Connect the IntuiKey keyboard to the Multiplexer's KYBD port using a standard keyboard cable.
3. Connect a Vext Cable from the Multiplexer to the DVR1 for proper video synchronization between the Multiplexer and DVR1, as follows:
 - Vext Pulse Out: DVR1 Pin 5 to Multiplexer Pin 21.
 - Ground: DVR1 Pin 7 to Multiplexer Pin 25.

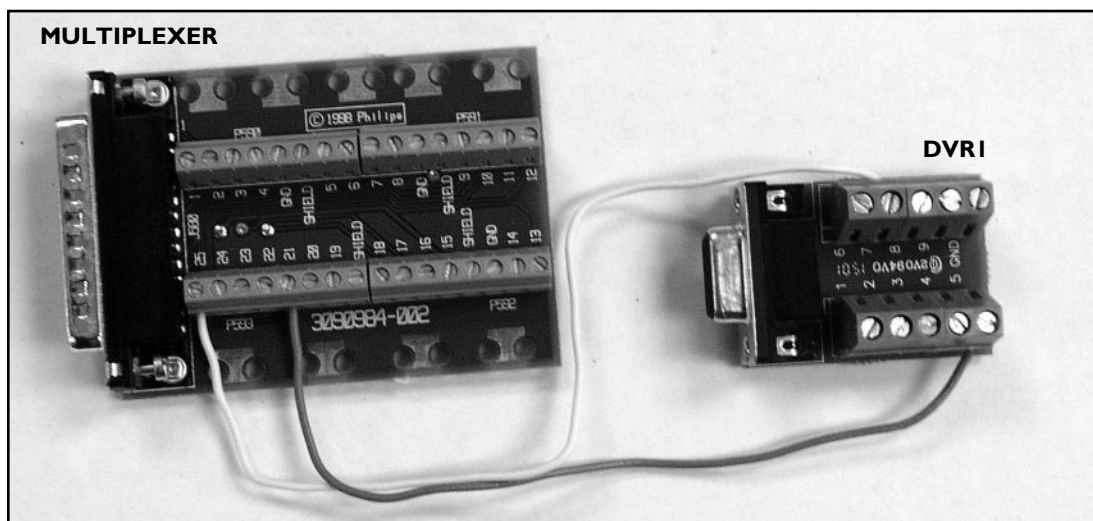

4. Multiplexer Setup (refer to the Multiplexer's Instruction Manual for further details):
 - Connect the Monitor to **MON A** output of the Multiplexer.
 - Execute the following Multiplexer *Advanced Menu* commands:
 - **ADVANCED SETUP** → **VCR SETUP** → **RECORD SETUP VCR OUT** → **VEXT INPUT "ON"**
 - **ADVANCED SETUP** → **VCR SETUP** → **RECORD SETUP VCR OUT** → **SELECT VCR "DVR1"**
 - **ADVANCED SETUP** → **PC/PRINTER** → **CONNECT TO VCR "SERIAL PORT 96,N,8,1"**
5. DVR1 Setup (refer to the DVR1 Instruction Manual for further details):
 - Connect the Monitor to **VCR output** of the DVR1.
 - Execute the following DVR1 *Advanced Menu* commands:
 - **ADVANCED MENU** → **MULTIPLEXER FORMAT "BOSCH"**
 - **ADVANCED MENU** → **COMMUNICATIONS** → **BAUD RATE "9600"**
6. Connect the DVR1's **VCR OUTPUT** to the Multiplexer's **VCR INPUT**. Also connect the Multiplexer's **MON A** output to the Monitor.

1.4 DVRI Keyboard Menus

There are two new keyboard menus that provide direct access to the DVRI menus and its recorded video (refer to the keyboard's instruction manual for further information on keyboard menus).

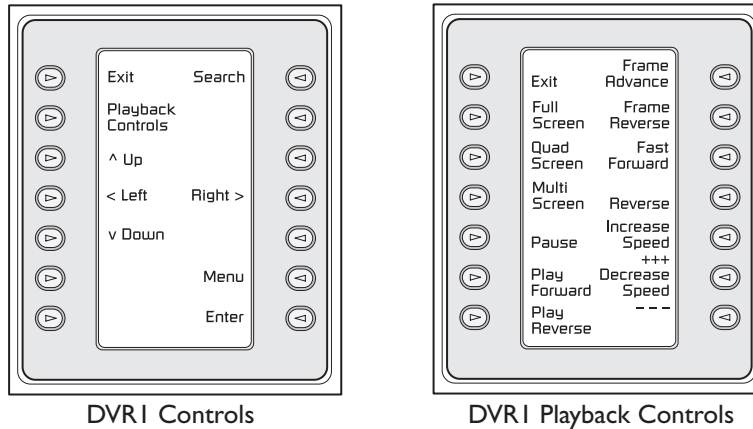

1.4.1 DVRI Controls Menu

To view the **DVRI CONTROLS** menu, at the Keyboard's **MULTIPLEXER MAIN MENU**, select **RECORDER CONTROLS**, then **DVRI CONTROLS**. The multiplexer will enter the VCR *View* mode.

When this screen is selected, the DVRI output signal switches to **MON A** of the multiplexer (the multiplexer *Playback* mode remains unchanged).

Below is a list of the new Keyboard Softkey buttons for the *DVRI Controls* menu along with an explanation of the functions they perform.

Softkey	Functions
Exit*	<ul style="list-style-type: none"> • Presents the previous keyboard menu (RECORDER CONTROLS). • Output signal of the Multiplexer is switched to MON A.
Playback Controls	<ul style="list-style-type: none"> • Presents the DVRI PLAYBACK CONTROLS menu (see Section 2.4.2). • The Multiplexer is forced into <i>Playback</i> mode to decode playback video from the DVRI.
Search	<ul style="list-style-type: none"> • Presents the DVRI's <i>Search</i> screen. • Video selected directly from this menu is not decoded unless the Multiplexer is in <i>Play</i> mode. Press PLAYBACK CONTROLS on the DVRI to properly view decoded video.
Up, Down, Left, Right	Navigate the DVRI's menu screens
Enter	Equivalent to the DVRI's Enter command.
Menu	Equivalent to the DVRI's Menu button.

*To stop playback and resume recording, **EXIT** the **DVRI CONTROLS** and **RECORDER CONTROLS** menus, then press **PLAY** on the Multiplexer's Main menu.

NOTES:

1. The front panel buttons of the Multiplexer and AllPlex keyboard do not provide direct access to the DVRI's *Search* menus.
2. When the IntuiKey keyboard is in the **DVRI CONTROLS** menu, all **MON A** display keys from the front panel and Allplex keyboard are blocked except the following:
 - ALARM ACK
 - ACTION ACK
 - ALT, MON B
 - Display keys for **MON B** are not blocked (except for **Freeze**).
3. If connection has been broken while the Multiplexer is in **DVRI CONTROLS** mode (via the IntuiKey keyboard), the Multiplexer **MON A** display becomes locked in this mode. To force the Multiplexer out of **DVRI CONTROLS** mode, execute the following command via the Multiplexer front panel: **ALT, 1, VCR, SEQ**.
4. If the Multiplexer was placed in *Menu* mode via front panel buttons, and the IntuiKey keyboard goes into **DVRI CONTROLS**, the Multiplexer remains in Multiplexer *Menu* mode. However, the **DVRI CONTROLS** keys on the IntuiKey keyboard will still control the DVRI. To display the DVRI menus, first leave the Multiplexer menus (from the front panel), then leave and reenter **DVRI CONTROLS** on the IntuiKey keyboard.

1.4.2 DVRI Playback Controls Menu

Below is a list of the new Keyboard Softkey buttons for the *DVRI Playback Controls* menu along with an explanation of the functions they perform.

Softkey	Functions
Exit	<ul style="list-style-type: none">• Presents the previous keyboard menu (DVRI CONTROLS).• Output signal of the DVRI is switched to MON A.
Full, Quad, Multi	Presents the various viewing options of the multiplexer.
Pause, Play Forward, Play Reverse, Frame Advance, Frame Reverse, Fast Reverse, Fast Forward, Increase Speed, Decrease Speed	Equivalent to the DVRI's front panel buttons.

APPENDIX E: RS-232 REMOTE PROTOCOL

I.1 Supported Command Sequences

The DVR1 supports the following command sequences, entered via PC once communication has been established between the PC and the DVR1. The Baud Rate should be set at 9600 Baud, with 1 Stop Bit, 8 Data Bits, and Parity at None.

All byte values entered at the PC must be in hexadecimal values. Each command string begins with an STX (02) character and ends with an ETX (03) character.

COMMAND	CHARACTERS	START				END
		1	2	3	4	5
Play Forward	FPL	02	46	50	4C	03
Record	REC	02	52	45	43	03
Stop	STO	02	53	54	4F	03
Pause	PAU	02	50	41	55	03
Fast Forward	FWD	02	46	57	44	03
Rewind	REW	02	52	45	57	03
Frame Advance	FAD	02	46	41	44	03
Reverse Frame Advance	RAD	02	52	41	44	03
Play Reverse	RPL	02	52	50	4C	03
Set Clock	<i>See instructions for setting clock in the following section.</i>					
Increase Speed	ISP	02	49	53	50	03
Decrease Speed	DSP	02	44	53	50	03
Search	SEA	02	53	45	41	03
Arrow Up	ARU	02	41	52	55	03
Arrow Down	ARD	02	41	52	44	03
Arrow Left	ARL	02	41	52	4C	03
Arrow Right	ARR	02	41	52	52	03
Menu	MEN	02	4D	45	4E	03
Enter	ENT	02	45	4E	54	03

Example:

To **Play Forward**, enter the following command at the PC keyboard, using the starting and ending characters and hexadecimal equivalent of the **FPL** from the above chart: **02 46 50 4C 03 <Enter>**

I.2 Setting the Clock

The following table shows the command sequence for setting the clock.

COMMAND	1	2	3	4	5	6	7	8	9	10	11	12	13	14	15	16	17	18	19	20
VALUE	02	43	4C	4B	20	y1	y2	2D	m1	m2	2D	d1	d2	2C	h1	h2	3A	f1	f2	03

The gray cells in the *Value* row of the table indicate the correct positions for each byte of data in the command string.

Place the hexadecimal value of the desired ASCII character into the command string, entering two digit values for Year, Month, Day, Hour, and Minute into the command string. The year is a 2-digit number, and the time is military time (24-hour clock).

See the example to follow.

SET CLOCK Example:

In this example, 14:39 on December 25, 2000 is used to demonstrate the **Set Clock** Command String.

	Notation Used in Value Column	ASCII Character of Desired Value	Hex Value Entered into Command String
Year Character #1	y1	0	30
Year Character #2	y2	0	30
Month Character #1	m1	1	31
Month Character #2	m2	2	32
Day Character #1	d1	2	32
Day Character #2	d2	5	35
Hour Character #1	h1	1	31
Hour Character #2	h2	4	34
Minute Character #1	f1	3	33
Minute Character #2	f2	9	39

The final **Set Clock** Command String for 14:39 on December 25, 2000 is as follows:

COMMAND	1	2	3	4	5	6	7	8	9	10	11	12	13	14	15	16	17	18	19	20
VALUE	02	43	4C	4B	20	30	30	2D	31	32	2D	32	35	2C	31	34	3A	33	39	03

OR:

02 43 4C 4B 20 30 30 2D 31 32 2D 32 35 2C 31 34 3A 33 39 03 <Enter>

WinZip® is a registered trademark of WinZip Computing, Inc.
 Sony® is a registered trademark of Sony Corporation.
 Windows®, Windows NT® and Windows®XP are registered trademarks of Microsoft Corporation
 Pentium® is a registered trademark of Intel Corporation.

Bosch Security Systems, Inc.
850 Greenfield Road
Lancaster, PA 17601 USA
Tel: 800-326-3270
Fax: 1-717-735-6560
www.boschsecuritysystems.com

Bosch Security Systems B.V.
P.O. Box 80002
5600 JB Eindhoven
The Netherlands
Tele +31 40 27 80000

Bosch Security Systems Pte Ltd.
38C Jalan Pemimpin
Singapore 577180
Republic of Singapore
Tel: 65 (6) 319 3486

© 2004 Bosch Security Systems GmbH
3935 890 36814 04-06 | Updated February 06, 2004 | Data subject to change without notice.

BOSCH

Free Manuals Download Website

<http://myh66.com>

<http://usermanuals.us>

<http://www.somanuals.com>

<http://www.4manuals.cc>

<http://www.manual-lib.com>

<http://www.404manual.com>

<http://www.luxmanual.com>

<http://aubethermostatmanual.com>

Golf course search by state

<http://golfingnear.com>

Email search by domain

<http://emailbydomain.com>

Auto manuals search

<http://auto.somanuals.com>

TV manuals search

<http://tv.somanuals.com>