

D1260/D1260B

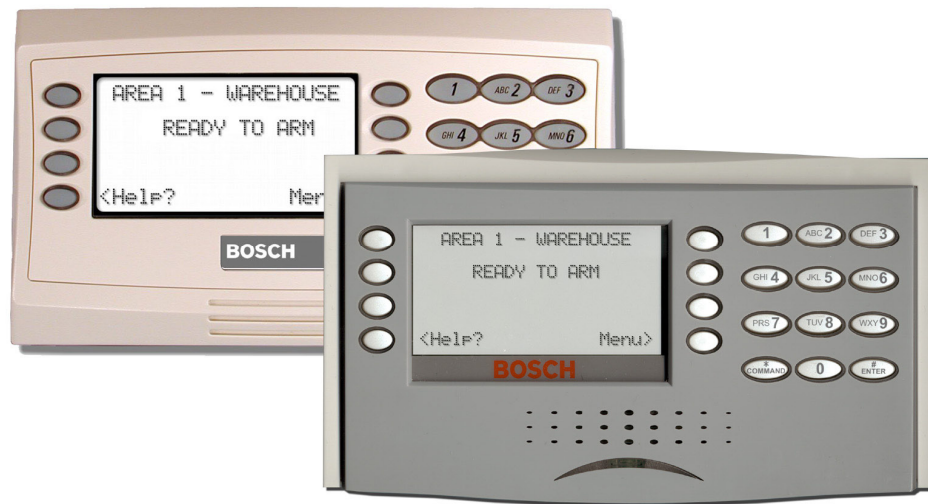

Security Systems

EN | Owner's Manual
Keypad

BOSCH



This system includes a telephone line seizure feature. The system may be programmed to communicate with a central monitoring station to report system events. You will not be able to use your phone while the system is communicating with the central monitoring station. In the unlikely event that the central station is not able to receive the report, your phone may be unavailable for up to 20 minutes while the panel makes additional communication attempts.



Some commands listed below may not be available. Contact your security company for more information.

Contents

Introduction	5	Part II: System Commands.....	15
Your Keypad	5	Entering a Passcode.....	15
About This Owner's Manual	6	Turning On the System (Arming).....	16
Part I: Security system basics	7	To Turn Your Security System On (Arm):.....	16
Using the keypad	7	Turning Off the System (Disarming).....	16
Command center keys.....	7	To Turn Your Security System Off (Disarm):.....	16
Points 8		Turning On the System (Arming) With a Duress Passcode.....	16
What is a Point?	8	Turning On the System (Arming) With Doors or Windows Open.....	17
Controlled Points	8	MASTER ARM ? (COMMAND + 1)	19
24-Hour Points	8	Description	19
Your Custom Display	8	Using Master Arm:.....	19
View Faulted or Bypassed Points.....	9	Master Arming all Areas	20
To automatically scroll faulted or bypassed points.....	9	MASTER ARM INST ? (COMMAND + 1 + 1)	21
Warning Displays and Tones	10	PERIMETR INST (COMMAND + 2).....	22
Keypad Quiets for Keystrokes.....	10	Turn On the Perimeter With No Delays.....	22
Priority of Events	10	Using Perimeter Inst:	22
Fire Alarms	11	PERIMETR DELAY ? (COMMAND + 3)	23
Silencing Fire Alarms	11	Turn On the Perimeter With Delays.....	23
Burglary Alarms	12	Silence the Trouble Sounder & Clear Trouble Display (COMMAND + 4)	24
Silencing Burglary Alarms	12	Description	24
Fire Trouble and Fire Supervisory Events.....	13	Using COMMAND 4:.....	24
Silencing Fire Trouble and Fire Supervisory conditions 13		VIEW MEMORY ? (COMMAND + 4 + 0).....	24
Special Fire Trouble and Fire Supervisory Display	13	View Event Memory.....	24
Viewing Fire Trouble and Fire Supervisory conditions 13		Using View Memory:	24
Non-Fire Trouble and Supervisory Events	13	WALK TEST ? (COMMAND + 4 + 4)	25
Silencing Non-Fire Trouble and Supervisory Events .	13	Walk Test	25
Special System Trouble Display.....	13	RESET SENSORS ? (COMMAND + 4 + 7)	27
Cleared Events Are Not Lost.....	13	Reset Sensors	27
Entry Delay Tone and Display.....	14	Using Reset Sensors:	27
Exit Delay Tone and Display	14	WATCH MODE ? (COMMAND + 6).....	28
Keystroke Checking Tones.....	14	Watch Mode	28
Silencing an Alarm	14	Entering Watch Mode:	28
To SILENCE an alarm:.....	14	Exiting Watch Mode:.....	28
How Your System Reports Alarms.....	14	PERIMETR PART ? (COMMAND + 8).....	29
		Partially Turn On the Perimeter.....	29
		Using Perimetr Part:.....	29

Special Alerts (COMMAND + 7 and COMMAND + 9) 30	Using Default Text..... 66
Using COMMAND 7:.....30	Using Setup 66
Using COMMAND 9:.....31	Part IV: Multi-Area Use..... 68
Part III: Advanced Commands.....32	Working with Multiple Areas from a Single Command Center 68
Advanced Commands32	View Area Status 68
Terms Used in This Section.....32	View Point Status..... 69
BYPASS A POINT? (COMMAND + 0).....33	MOVE TO AREA ? (COMMAND + 5 + 0)..... 70
Description.....33	Turning On the System 71
Using Bypass a Point33	Turning on Selected Areas 71
UNBYPASS A POINT? (COMMAND + 0 + 0).....35	Turning on Multiple Areas with a Passcode 71
Description.....35	Faulted Points in Other Areas..... 72
Using Unbypass a Point:.....35	Turn On the Entire System Without Delays..... 72
SEND REPORT ? (COMMAND + 4+1 or 4+2).....36	Turning on All or Selected Areas..... 72
Description.....36	Turning Off the System 73
Using Send Report.....36	Turning Off Multiple Areas with a Passcode 73
REMOTE PROGRAM ? (COMMAND + 4 + 3).....38	Turning Off Multiple Areas with Disarm All..... 73
Description.....38	Turning Off Selected Areas..... 74
For systems without a phone number.....38	Appendix 76
For systems with a phone number or network connection.....39	Supplementary Information for Adding Passcodes... 76
CHANGE TIME/DATE (COMMAND + 4 + 5)40	User Authority Levels 76
DOOR CONTROL (COMMAND + 4 + 6)41	Passcode Worksheet..... 76
Description.....41	User Interface..... 76
Using Door Control.....41	User Interface..... 77
Access Level43	User (Passcode) Worksheet (User 000 to 038) 78
CHANGE DISPLAY (COMMAND + 4 + 9)44	◆ User (Token) Worksheet (User 000 to 038) 79
Brighten/Dim Display44	D9412G/D7412G Only 79
Show Continuous Time/Date.....44	User (Passcode) Worksheet (User 039 to 075) 80
EXTEND CLOSING (COMMAND + 5 + 1).....45	◆ User (Token) Worksheet (User 039 to 075) 81
CHG SKEDS ? (COMMAND + 5 + 2).....47	D9412G/D7412G Only 81
Description.....47	User (Passcode) Worksheet (User 076 to 114) (101-249 = D9412G only)..... 82
Using Chg SKEDS.....47	◆ User (Token) Worksheet (User 076 to 114) 83
DEL USER ? (COMMAND + 5 + 3)50	D9412G/D7412G Only (101-249 = D9412G only) ... 83
CHG RELAYS ? (COMMAND + 5 + 4).....51	User (Passcode) Worksheet (User 115 to 150) (101-249 = D9412G only)..... 84
CHG PASSCODES ? (COMMAND + 5 + 5).....51	User (Token) Worksheet (User 115 to 150) (101-249 = D9412G only) 85
Description.....51	User (Passcode) Worksheet (User 151 to 189) (101-249 = D9412G only)..... 86
Using Chg Passcodes52	User (Token) Worksheet (User 151 to 189) (101-249 = D9412G only) 87
ADD/CHANGE USER (COMMAND + 5 + 6)53	User (Passcode) Worksheet (User 190 to 226) (101-249 = D9412G only)..... 88
DEFAULT TEXT ? (COMMAND + 5 + 7).....60	◆ User (Token) Worksheet (User 190 to 226) 89
FIRE TEST ? (COMMAND + 5 + 8).....61	D9412G/D7412G Only (101-249 = D9412G only) ... 89
DISPLAY REV ? (COMMAND + 5 + 9).....62	User (Passcode) Worksheet (User 227 to 249) (101-249 = D9412G only)..... 90
SERVICE MENU ? (9 + 9 + Enter).....63	
Using View Log64	
Using Print Log65	
Using Display Rev65	
Using Service Walk Test.....65	

User (Token) Worksheet (User 227 to 249) (101-249 = D9412G only)	91
User (Passcode) Worksheet (Blank)	92
User (Token) Worksheet (Blank).....	93
Security System Limitations.....	93
Fire Safety and Evacuation	94
Standard Displays	95
System Trouble Displays.....	96
Security System Glossary	98
Maintenance and Service	99
How to Clean the Command Center	99
Your Alarm Company	99

Figures

Figure 1: D1260/D1260B front panels	5
Figure 2: D1260/D1260B Digital Keypad	6
Figure 3: Using soft keys for display menus	6
Figure 4: Smoke Detector Locations (Plan View) ..	94
Figure 5: Smoke Detector Locations (Elevation View).....	94
Figure 6: Escape Route	94

Tables

Table 1: D1260/D1260B Keypad keys	7
Table 2: Keypad Commands	15
Table 3: Door Status.....	42
Table 4: Sked Table.....	49
Table 5: Screen Area Definitions.....	69

Introduction

Your security system helps to secure life, property, and investments against fire, theft, and bodily harm. The keypad is an advanced digital device that offers a variety of features not available with other systems. Its highly visible, backlit keypad and built-in sounder alert you to a number of system events. A familiar ATM style design and ease-of-use make it ideal for property monitoring.

Your Keypad

Your Keypad is composed of two main sections: the numeric keypad section and the display/selection keys (also referred to as “soft keys”).

Figure 1: D1260/D1260B front panels

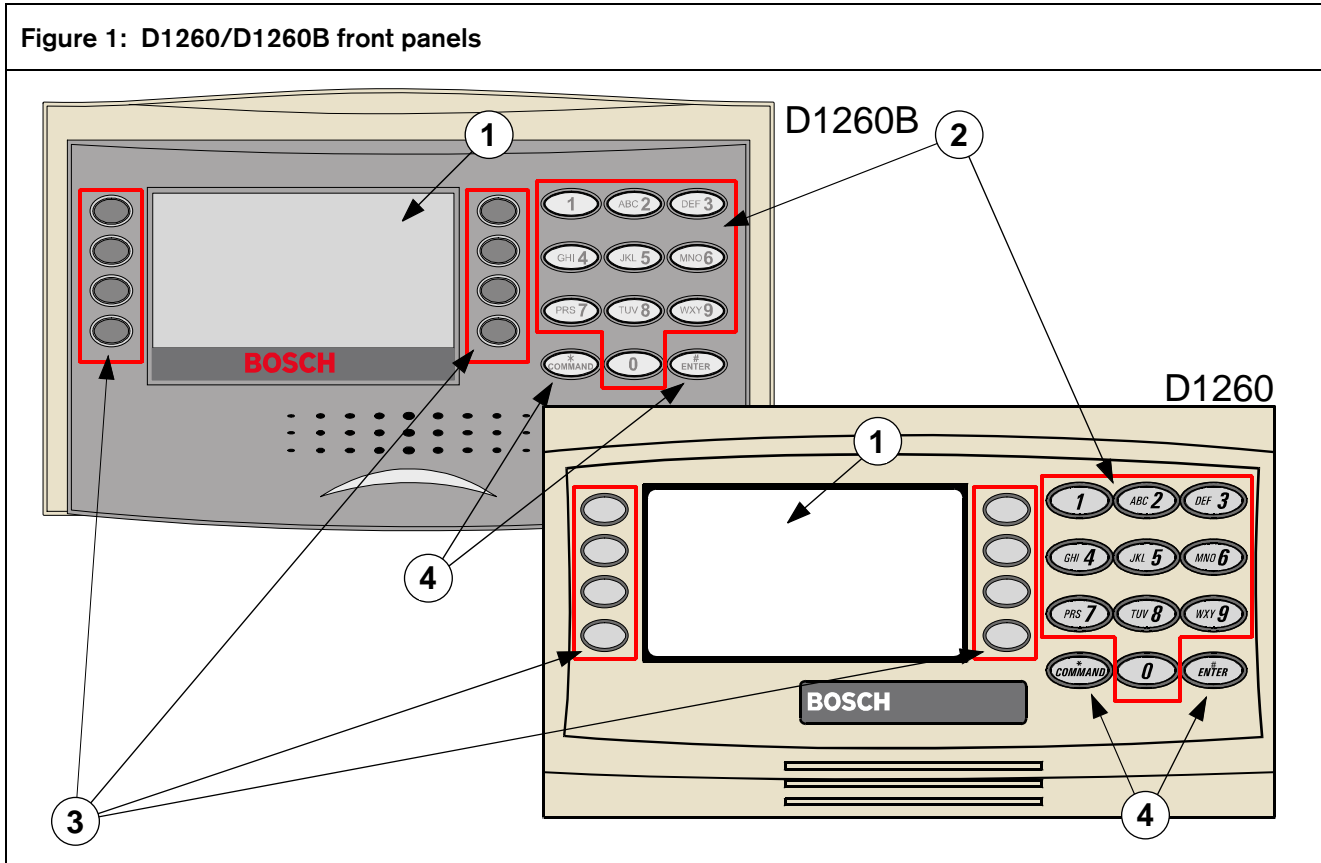

1 - LCD Display
2 - Digital Keypad

3- Soft Keys
4 - Keypad Function Keys

The numeric keypad section is a standard 3x4-keypad matrix that should be very familiar to you. It has been designed to closely resemble that of a standard telephone with the numeric keys of 1-0; and * and # keys. The display is an easy-to-read 4 line by 20-character liquid crystal display that becomes backlit when a key is pressed or a system event occurs.

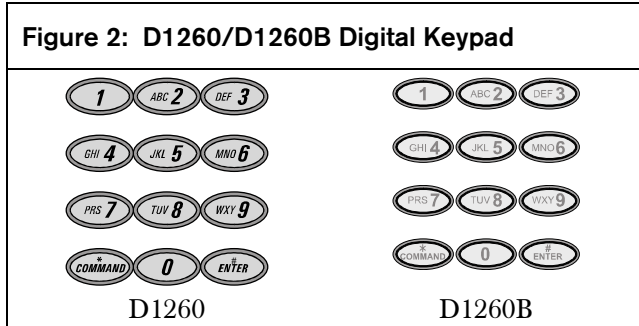

The soft keys are used to make selections when the display shows an arrow pointing next to it. For example, the display shown to the right is what will appear when there are faulted points in your system. Pressing the soft key adjacent to the View Points> display will then begin to scroll the faulted point(s) in your system.

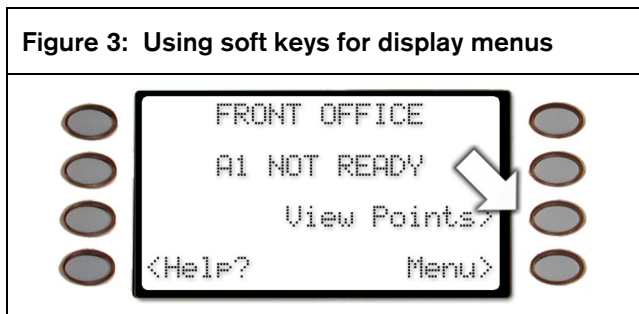

About This Owner's Manual

This owner's manual is divided into five main sections:

- **Security System Basics:** Covers how to use the Keypad, the various keys on the Keypad, what a "Point" is and the various types of Points, and custom displays.
- **System Commands:** This section covers system commands, such as turning the system on and off, resetting sensors, etc. Your security company programs the functions described in this section. Some of them may not be included in your system. Some of the functions covered may require you to enter your personal passcode.

- **Advanced Commands:** Allow users to perform advanced system functions like add and delete user passcodes, reassign authority levels to user passcodes and operate or change programmed scheduled events (Skeds) from the keypads. As you make changes to the system, update the information contained in the tables in this guide to provide an accurate account of the programmed information.
- **Multi-Area Use:** Each of the functions described in the preceding section on Advanced Commands is presented as though your system includes only one area. If your system includes more than one area, it can be set up one of two ways by the installing company: (1) Each keypad will only have access to the local area to which it is assigned, or (2) Each keypad may access either some or all areas beyond the one to which it is assigned.
- **Appendix:** Covers the limitations of a Security System, Fire Safety and Evacuation, Maintenance and Service of your Security System and How to Clean the Keypad.

Part I: Security system basics

Using the keypad

Your security system provides quick access to functions by pressing the **COMMAND** key and one or two additional keys.



D1260



D1260B

Another way to access functions is through the Command Menu. To access the Command Menu, press the soft key adjacent to **Menu>** shown in the display.



Pressing the **<Previous** or **Next>** soft key while in the Menu List allows you to scroll up or down through the list of functions programmed by your security company.

Command center keys

Table 1: D1260/D1260B Keypad keys

Key		Name	Description
D1260	D1260B		
		COMMAND	Use the COMMAND key in combination with one or two numeric keys to perform a function
		ENTER	The ENTER key is used to complete the entry of your passcode at the keypad. Whenever a function requires that you enter your passcode at the keypad, first press the digits of the code and then press the ENTER key. Your system will not recognize your passcode until you press ENTER.
		EXIT	When Exit> or <Exit appears in the keypad display, pressing the soft key adjacent to it will bring you one level up in the function or will exit you out of the function you are in. These functions may be displayed on either side of the display.
		Previous	When viewing a list, pressing the <Previous soft key will take you back to the previously shown item.
		Next	Press the Next> soft key to pass over the present item(s) in a menu or function.

Pressing the soft key adjacent to the function being displayed initiates the function.



To exit the Command Menu, press the **<Exit** soft key.



Use the Command Menu to locate functions you don't use often or that don't have a command number.

Points

What is a Point?

A “point” is a detection device, or group of devices connected to your security system. Points display individually at the keypad with custom text. The text can describe a single door, motion sensor, smoke detector, or an area such as UPSTAIRS or GARAGE. There are two basic types of points, controlled and 24-hour.

Controlled Points

Controlled points respond to alarm conditions depending upon whether the system is turned on (armed) or turned off (disarmed). Controlled points are programmed to respond instantly to alarm conditions or to provide a delay for you to reach the keypad and disarm the system.

The type of alarm appears before the point text when there is an alarm. There are two types of controlled points, perimeter points and interior points.

Perimeter Points

These points usually include all exterior doors and windows of the building.

Interior Points

These points usually include interior forms of burglary detection devices, such as motion sensors, or inside doors, for example.

24-Hour Points

24-hour points are always on, even when the burglary system is disarmed (turned off). There are two types of 24-hour points, fire points and non-fire points.

Fire Points

Fire points exclusively monitor fire detection devices. They are always armed and cannot be disarmed. You can clearly distinguish fire points from other non-fire points at the keypad.

When there is a fire alarm, the display shows the following:

FIRE ALARM is displayed on the first line, text identifying the point as a fire point is displayed on the second line, and instructions for silencing the alarm are displayed on the third and fourth lines.

Fire alarms have a unique audible warning signal.

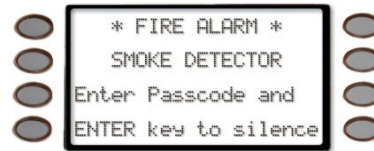

Non-Fire Points



Non-fire 24-hour points are always armed and cannot be disarmed.

Your Custom Display

“At an idle state” means that the system is not currently performing a function entered by a user. There are three idle states the system may be in:

- Turned on (Armed)
- Turned off (Disarmed) with no points faulted (doors or windows open) in the area
- Turned off with faulted points (doors or windows open) in the area.

This manual uses the default idle state displays for examples of these idle states. Your security company may have programmed custom text for the idle displays in your system. The custom text and the default text for the three system idle displays follow.

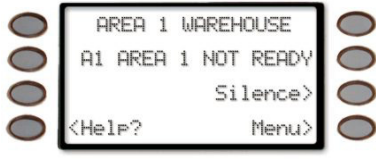
	Default Text	Custom Text
Area Name Text Appears on the top line of the display	AREA # NAME TEXT	-----
<input checked="" type="checkbox"/> Throughout this manual, all examples of "AREA # NAME TEXT" will use "AREA 1 WAREHOUSE." The actual name of Area 1 will differ depending on the specifics of your system.		
Area Is On Text		-----
<input checked="" type="checkbox"/> The Silence> soft key is only shown when the keypad buzzer is active		
Area Off Text Indicates the area is turned off (disarmed). 24-hour points remain armed.		-----
Area Not Ready Text Indicates that the area is turned off, but not ready to arm.		-----

View Faulted or Bypassed Points

To properly arm your system, all the doors and windows in the system must be in the normal (not faulted) condition. Viewing the faulted points helps you find faulted points and correct them so proper arming is possible.

Your keypad offers two ways of displaying faulted and bypassed point information. The first causes the faulted or bypassed point information to scroll automatically through the display. The second allows you to manually scroll through each individual point description.

To automatically scroll faulted or bypassed points

1. Ensure your keypad shows idle text.

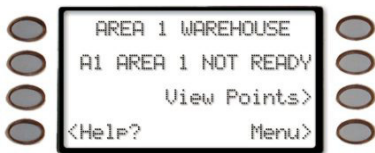

The View Points> soft key may be displayed on the third line of the keypad if there are faulted points.

2. Press any number key. The text for Area 1 is displayed first followed by the number (#) of faulted points on the next line

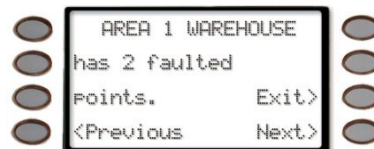

3. The display changes to show the point text description of the faulted points. If there is more than one faulted point, the display will automatically cycle through all of them before returning to idle text.

These displays scroll at the rate of 3 seconds each.



- The display returns to idle text after scrolling through the faulted and bypassed point information.

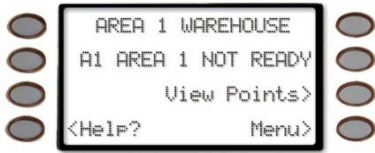

The View Points> soft key will be shown when there are faulted points.

To manually scroll faulted or bypassed points:

- Ensure your keypad shows idle text.
- Press the **View Points>** soft key to display the first faulted point.

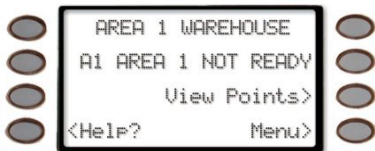

Press the **Next>** soft key or the **<Previous** soft key repeatedly to display the faulted and bypassed point information.

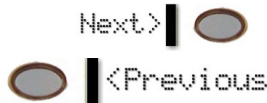

If faulted or bypassed points in other areas exist, then the display changes to show these points before returning to idle text.

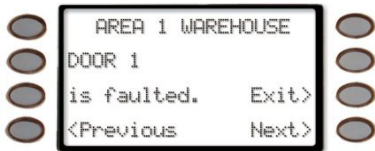

Warning Displays and Tones

Your keypad emits one of several distinct tones and displays custom text to alert you to system events. Additional bells or sirens may also be connected to your system. Bells or sirens mounted on the exterior of your premises alert neighbors to emergencies and provide an audible guide for police and fire fighters.

Keypad Quiets for Keystrokes

Pressing any key on the keypad lights the keys and quiets any warning tones. If you don't press another key within 20 seconds, the keypad lights go out and the warning tones resume.

Priority of Events

If more than one event occurs, your system sorts them into one of four groups. The groups (highest priority first) are:

- Fire Alarms
- Burglary Alarms
- Fire Troubles and Fire Supervisory conditions
- Non-Fire Troubles and Non-Fire Supervisory conditions.

The group with the highest priority scrolls first in the keypad's display. Descriptions of the tones and displays for each group and instructions for silencing the tones are included in the descriptions that follow.

Fire Alarms

Fire alarms are the highest priority events. When a fire point activates, your keypad emits a pulsating high-pitched fire tone. Evacuate all occupants and investigate for smoke or fire. Ensure that all occupants know the difference between the burglary tone and the fire tone. The tone sounds for the time set by your security company.

Silencing Fire Alarms

Entering a personal passcode with the proper authority level silences a fire alarm and disarms the system if it was armed.

The system will now display **Alarm Silenced** on the second line and *Clear Display>* appears on the fourth.

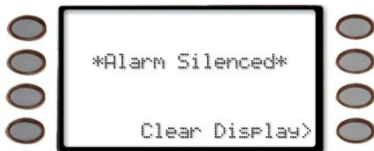

Then the number of points in alarm (*# FIRE ALARMS*) and then the area text appears (*AREA 1 NAME TEXT*) followed by the custom text of all the points in alarm (*SMOKE DETECTOR*), in the order of occurrence.

If there is more than one point causing an alarm, the display will show each point for three seconds before showing the next one.

When the last alarm is shown, the next display is the idle text. The cycle is repeated until **COMMAND 4** is pressed.

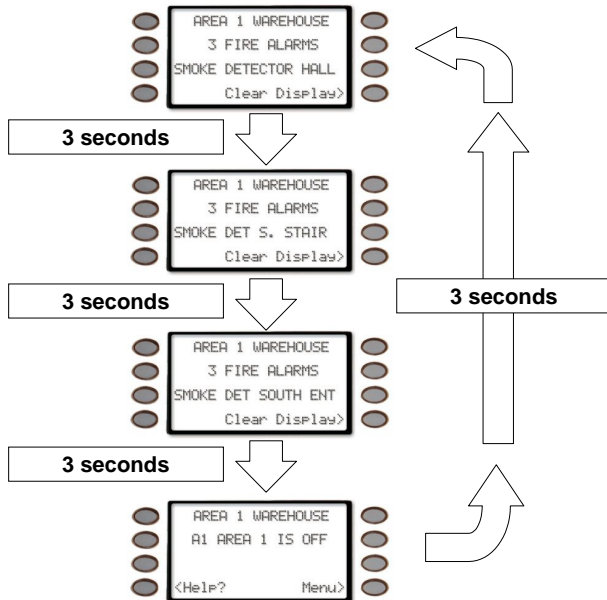

Your system may be programmed so that you cannot silence some fire alarms until the fire event clears. Entering **COMMAND 4** clears the scrolling point text from the display.

The **Alarm Silenced** message will continue to alternate with idle text as a reminder that it is still possible to view the text of the points in alarm by using the View Memory function. See *VIEW MEMORY ?* (Command 40) for more information.



To clear the event memory and remove the **Alarm Silenced** message from the display, press the *Clear Display>* soft key.

The display will show the instructions for clearing the message. Enter a valid passcode and press the *Clear>* soft key.

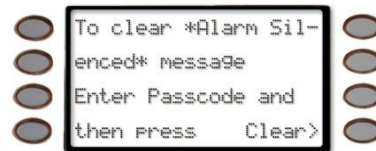

If a fire trouble still exists after acknowledging the alarm, the display shows *Fire Trouble*.



To remove this display, the fire point(s) must be returned to normal. If you wish to review cleared events, use **COMMAND 40**.

Burglary Alarms

Burglary alarms are the second priority. When a burglary point activates while your system is armed, your keypad emits a steady high-pitched burglary tone. The tone sounds for the time set by your security company.

The keypad display shows the number of burglary points activated, the point text then idle text.

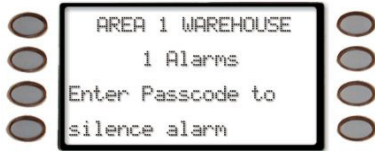

If there is more than one point causing an alarm, the display will show each point for three seconds before showing the next one. When the last alarm is shown, the next display is idle text followed by the first alarm

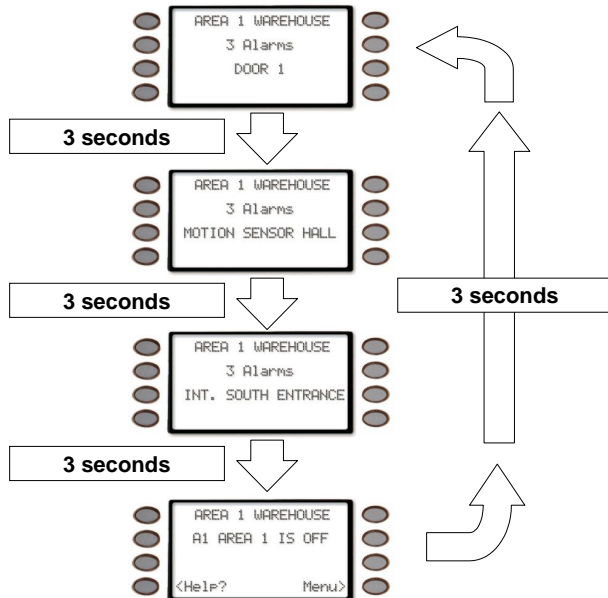

Silencing Burglary Alarms

Entering a personal passcode with the proper authority level silences a burglary alarm and disarms the system if it was armed.

The system will now display **Alarm Silenced**



and then the number of points in alarm **### Alarms** and the custom text of all the points in alarm, in the order of occurrence.



Entering **COMMAND 4** clears the scrolling point text from the display.

The **Alarm Silenced** message will continue to alternate with idle text as a reminder that it is still possible to view the text of the points in alarm by using the View Memory function. See **VIEW MEMORY ?** (Command 40) for more information.

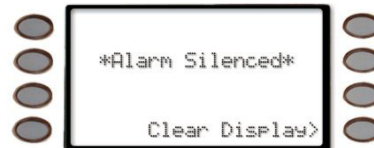

To clear the event memory and remove the **Alarm Silenced** message from the display, press the **Clear Display>** soft key.

The display will show the instructions for clearing the message. Enter a valid passcode and press the **Clear>** soft key.

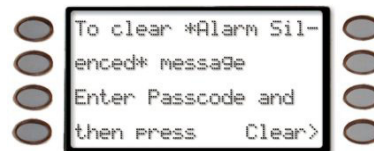

Fire Trouble and Fire Supervisory Events

When a fire trouble or fire supervisory condition occurs, your keypad emits three warble tones, then a pause (repeatedly).

The system displays the number of fire points that are in a trouble or supervisory condition as well as the point text of the affected points.

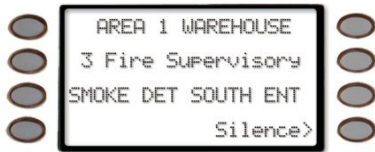

Silencing Fire Trouble and Fire Supervisory conditions

Pressing **COMMAND 4** or the *Silence*> soft key silences the conditions. In addition to this, entering a personal passcode with the proper authority level silences the condition and disarms the panel if it was armed. If you wish to review these cleared troubles, using **COMMAND 40** can do this.



Some systems may be programmed to automatically re-sound the keypad's trouble tone after a period of time if the fire trouble or fire supervisory condition remains. Consult your security company for further information.

Special Fire Trouble and Fire Supervisory Display

If you silence the keypad or clear a trouble or supervisory condition for a Fire Point from the display and the fire point remains in trouble, *Fire Trouble* or *Fire Supervisory* appears in the keypad's display. This remains in the display until the condition causing the trouble is cleared.



Some fire points, when tripped, will display FIRE TROUBLE for a preset amount of time. If no other fire activity is detected, this condition will automatically clear. If the condition remains or another fire detector is tripped, a fire alarm will occur.

Viewing Fire Trouble and Fire Supervisory conditions

After pressing **COMMAND 4** or entering your passcode, the text of the fire point in trouble continues to automatically scroll through the display. Press *View Points*> soft key and then *Next*> soft key to scroll these displays manually if you wish. Events scroll in chronological order.

Non-Fire Trouble and Supervisory Events

When a trouble event occurs, your keypad may be programmed to emit three warble tones, then a pause (repeatedly).

If the system was armed the keypad display shows the number of non-fire trouble events or non-fire supervisory events and then custom text for each activated point.

Silencing Non-Fire Trouble and Supervisory Events

Pressing **COMMAND 4** or the *Silence*> soft key silences the Trouble and/or non-fire Supervisory conditions. In addition to this, entering a personal passcode with the proper authority level silences a trouble and disarms the panel if it was armed. Press the *View Points*> soft key then the *Next*> soft key to scroll these displays manually. If you wish to review these cleared troubles, use **COMMAND 40** to do this.

Special System Trouble Display

These displays appear on all keypads in the system. See *Standard Displays* for a description of each system trouble display. Entering your passcode, **COMMAND 4** or pressing the *Silence*> soft key will silence a system trouble tone, but the System Trouble display will not clear until the faulted condition is corrected.

A system trouble display begins by sounding a trouble tone and then three seconds later the specific System Trouble Display is shown, such as *Service AC Fail*.



Some system may be programmed to not initiate a trouble tone during these conditions.

Cleared Events Are Not Lost

If you clear the alarms and troubles from the display, you can still view all the events that occurred since the last time the system was armed by using **COMMAND 40** (View Event Memory).

Entry Delay Tone and Display

When you enter an armed system through a point programmed for entry delay, the keypad emits a repeating warble tone and displays the following to remind you to turn off your security system.



If you fail to turn off the security system before the entry delay time expires, it may sound the burglary tone and may also send an alarm report to your security company.

Exit Delay Tone and Display

After you arm your system, the keypad emits a repeating beep tone, displays **AREA 1 NAME TEXT is now arming...** then



EXIT NOW! and counts down the exit delay time.

Keystroke Checking Tones

Valid Entry

If you press an appropriate key for the function or entry you desire, the keypad emits a muted beep tone, indicating it accepted your keystroke.

Invalid Entry

A flat buzz tone sounds when you perform a function that is not allowed or when the keypad has no information to display.

Silencing an Alarm

The audible alarm sounds for a specific period of time before it automatically shuts off. If an alarm occurs and you want to silence the siren before the time expires, simply enter your personal passcode and press **ENTER**.

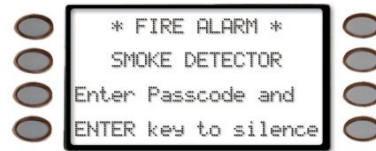

To SILENCE an alarm:

Enter your passcode and press **ENTER**.



How Your System Reports Alarms

Your security system may be programmed to automatically disconnect your telephones when sending reports to your security company. Once the report is completed, your security system returns the telephones to normal operation (check with your security company). Other methods of communicating alarm conditions are also available. Please consult your security company for services available in your area.

Your system makes repeated attempts to send reports to your security company.

In the event your security system fails to communicate, the keypad sounds a Trouble Tone and displays **AREA 1 WAREHOUSE Comm Fail Route Grp1** (where the Route Group can be 1, 2, 3, or 4):

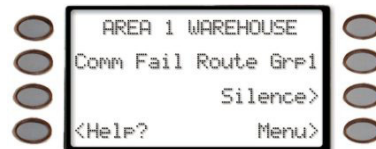

Notify your security company of the communications failure.



If your system uses telephone lines as its means of communication and telephone service is interrupted, your security system cannot send reports to your security company unless it has an alternate means of transmitting them.

Part II: System Commands

Below is a summary of the commands covered in this section.



Some of these functions may not be available in your system. Please consult your security company to determine which commands have been made available to you.

If you attempt to enter a function that's not available or if the function is available in the system but your passcode is not authorized to perform the function, then ****No Authority**** will display on the Keypad.



Press the **COMMAND** key and then the one or two digits shown in the table below to perform the function. When you use a command to perform a function, the displays in the function list below do not appear at your keypad.



Some commands listed below may not be available. Contact your security company for more information.

Table 2: Keypad Commands

COMMAND	Function
	Master Arm
+	Master Arm Instant
	Perimeter Instant
	Perimeter Delay
	Silence Trouble Sounder & Clear Trouble Display
+	View Memory
+	Walk Test
+	Reset Sensors
	Watch Mode
	Special Alert
	Perimeter Partial
	Special Alert
+	Walk Test

Entering a Passcode

1. The display may prompt you to enter your passcode.

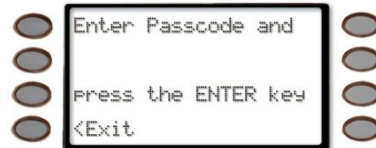

2. The passcode is shown as asterisks (*) when entered and advance from the right side of the display to the left until all passcode digits (from a minimum of 3 to a maximum of six) are entered.

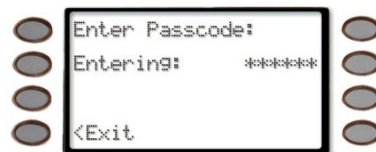

3. Press **ENTER**.



Turning On the System (Arming)

Your security system can be turned on (armed) in many different ways, depending on the arming command used. Arming Commands are those commands used to turn on the system. The most basic arming command is to arm the entire system. The simplest way to arm your system is to enter your personal passcode or press [COMMAND] [1].

There are several other arming commands to turn on the system. These are described later in this manual.

To Turn Your Security System On (Arm):

1. Enter your passcode and press **ENTER**.



2. The keypad briefly displays **AREA 1 NAME TEXT is now arming...**,



and the exit delay tone begins. After exit delay time expires,

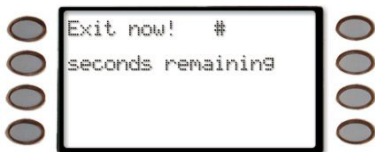

the display changes to idle armed text.



Turning Off the System (Disarming)

Entering your personal passcode turns off your security system. When the system is turned on, you must enter through a designated entry door to prevent an instant alarm condition. Opening the door starts entry delay time and the Keypad emits a pulsing “beep” tone to remind you to turn off the system. Enter your passcode before the delay time expires and the system will turn off.

If you enter through the wrong door or fail to disarm before the entry delay time expires, you will cause an alarm.

If this happens, silence the alarm (by entering your personal passcode and pressing **ENTER**) and call your security company to let them know that it is not an emergency situation.



To Turn Your Security System Off (Disarm):

1. Enter your passcode and press **ENTER**.



5. You must press the **ENTER** key within 5 seconds of entering your passcode, or the passcode entry will be invalid.
6. The display returns to idle disarmed text.



Turning On the System (Arming) With a Duress Passcode

Your passcode may have a special duress feature that is simply your personal passcode with its last digit increased by 1 or 2.

If an intruder demands that you arm or disarm the security system, you can use your duress passcode. The duress passcode arms or disarms the system **and** sends an alarm report to your security company. There is no alarm tone or visual indication at the premises that the report is sent. Check with your security company before attempting to use this feature.

Turning On the System (Arming) With Doors or Windows Open

If a protected door or window is open, you may have the option of “force arming” with that point faulted. Faulted points (opened doors or windows) that are force armed are not included in the system. The remaining points arm normally.

Force armed points either return to normal operation after you turn off your system or return to normal when the door or window is closed. Your system might not offer force arming or it may be restricted to specific points. Contact your security company for more information.

1. Use your passcode or an arming function to start the arming process.
7. The display shows **Check Area #**.



8. One of the messages below may display in place of **Check Area #**.



Indicates the system is programmed not to arm with particular points faulted (doors or windows open).

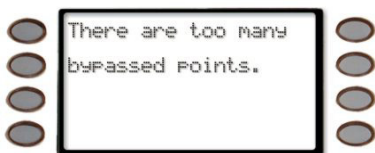

Indicates that the system's number of allowable bypassed points has been reached. Your system's maximum number of bypassed and/or force armed points is set by your security company. Check with them to learn this number.

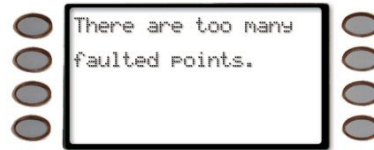

Indicates that more than the number of allowable points are faulted. Bypassed points are counted as faulted. Your system's maximum number of bypassed and/or force armed points is set by your security company. Check with them to learn this number.

9. The display shows **AREA 1 WAREHOUSE Not Ready to Arm**.

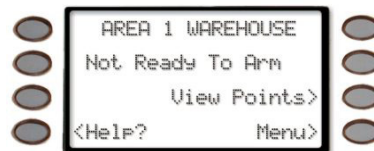

10. Pressing the **View Points>** soft key will show the specifics for any points that are faulted, if any, and bypassed, if any.

Faulted points are displayed first then bypassed points.

11. The display changes to show the number of faulted points in the area.

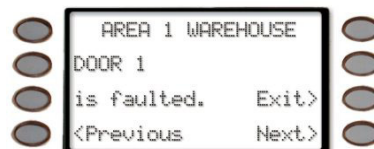

Press **Next>** soft key repeatedly to scroll through the point text for each faulted point.

If you do not want to go through the list of faulted points and want to go directly to the **Force Arm>** soft key or **Force Bypass>** soft key, press the **COMMAND** button.



- Once the last faulted point is displayed, pressing the **Next>** soft key will start displaying a summary and then specifics of any bypassed points.



- Once the last bypassed point is displayed, the display will change to show the soft key to either force arm the faulted points (**Force Arm>**) or force arm the faulted/bypassed points (**Force/Bypass Arm>**).



- Press the appropriate soft key to arm your system with the faulted/bypassed points removed from service.

MASTER ARM ? (COMMAND + 1)

Description

Use this function to turn on the entire system, both perimeter and interior. When you turn on the system, the display shows how many seconds of exit delay time you have to exit the protected area. You should leave before exit delay time expires.

Leaving after exit delay has expired will cause the entry delay to start. You may also cause an alarm on an interior device. Enter your personal passcode to disarm the system.

This function may be used by your cleaning service, a serviceman, or others who need to turn on your system when they leave.

Using Master Arm:



Using the COMMAND +1 shortcut will only arm the area where the keypad has been assigned. Example, if the D1260 is assigned to Area 1, only Area 1 will be armed when COMMAND + 1 is pressed.

1. The display shows disarmed idle text.

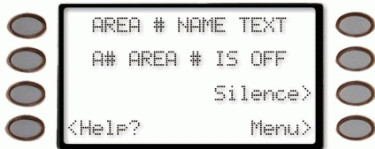

2. Press the **COMMAND** key.
3. The display shows ***System Command***.



4. Press the **1** key
5. If your system is programmed to require a passcode when performing a COMMAND 1, the display prompts you to enter your passcode.

The passcode is shown as asterisks (*).

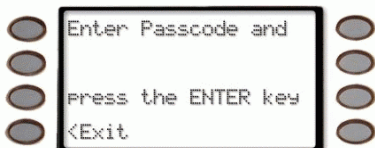

6. If the passcode has valid authority for this command, the display shows **Exit now #** (# = exit delay time remaining) **seconds remaining**.

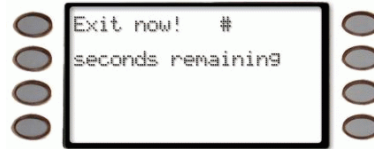

After the exit delay time expires, the display changes to idle armed text.



7. To disarm your security system, enter your personal passcode and press **ENTER**.

Master Arming all Areas

If you prefer, you may use the **Master Arm ?>** command in the Command Menu to initiate this function which will arm all available areas according to your authority level.

1. The display shows disarmed idle text.

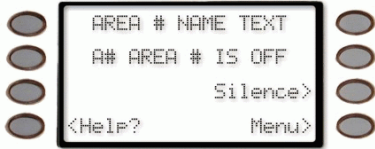

2. Press the **MENU>** soft key to enter the Command Menu,
3. then press **NEXT>** soft key repeatedly



4. until you reach the **MASTER ARM ?>** prompt. Press the soft key.



5. The display may prompt you to enter your passcode. The passcode is shown as asterisks (*) when entered.

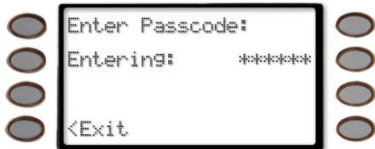

6. If there is more than one area that is set up, the option is given to arm all of them with **MASTER ARM ALL ?**



or by pressing the **Next>** soft key...



to view each unarmed area and optionally arm each one.



7. To arm a selected area, press **Next>** until the desired area appears (Area name text along with **Arm Area # ?**).



8. Then press **Arm>**



9. The next available area will appear with the option to arm it.

Every time the **Next>**, **<Previous** or **Arm>** soft keys are pressed, the display scrolls to the next unarmed area.

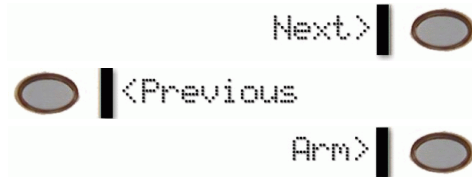

10. To arm all available areas, press the **Arm>** soft key when the display reads **Master Arm All ?**



11. The display changes to show that all areas are arming. Depending on what areas are armed or areas that you have authority, **12345678** may or may not appear.



12. then displays **Exit now #** (# = exit delay time remaining).

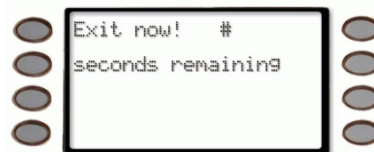

After the exit delay time expires, the display changes to idle armed text.



13. To disarm your security system, enter your personal passcode and press **ENTER**.
14. The display changes to show that all the areas are disarmed.

Depending on what areas are armed or areas that you have authority, **12345678** may or may not appear.



The display returns to idle text.



MASTER ARM INST ? (COMMAND + 1 + 1)

Use this function to turn on a single area, both perimeter and interior without delays. When entering COMMAND 11, remember that the second 1 must be pressed within 2 seconds after pressing the first 1.

The menu entry **MASTER ARM INST>** is different in that it allows all or selected areas to be armed instantly.

- COMMAND 11 does not comply with SIA CP-01 Standard.
- Using the COMMAND + 1 + 1 shortcut will only instantly arm the area where the keypad has been assigned. Example, if the D1260 is assigned to Area 1, only Area 1 will be armed when COMMAND + 1 + 1 is pressed.

1. The display shows disarmed idle text.



2. Press the **COMMAND** key. The display shows ***System Command***.



3. Press the **1** key. Now press the **1** key again.
4. The keypad display shows **AREA 1 WAREHOUSE All On Instant**.



5. To disarm your security system, enter your personal passcode and press **ENTER**.

PERIMETR INST (COMMAND + 2)

Turn On the Perimeter With No Delays

Description

Use this function to turn on only the perimeter of your building, leaving the interior of the building disarmed. This function allows no exit or entry delay time through the perimeter, including the designated exit delay door.

This function is useful in residential systems when everyone is home and ready to retire for the evening. You can have the security of an armed perimeter, yet move freely throughout the interior of the premises.

It is also useful in commercial systems when you are working before or after business hours and wish to have the perimeter armed. Remember there are no entry or exit delays when you use this function. You must disarm (turn off) the system to enter or exit the premises.

Using Perimeter Inst:

1. Interior points are not armed with this command and may remain faulted while arming with COMMAND 2.
2. Press the **COMMAND** key.

The display shows **System Command**.



3. Press the **2** key.



If you prefer, you may use the Command Menu in place of steps 2 and 3 to initiate this function.

Press the **MENU>** soft key to enter the Command Menu,



then press **NEXT>** soft key repeatedly.



until you reach the **PERIMETR INST ?>** prompt, then press the adjacent soft key.



4. The display shows *Perimeter On Instant*.



After arming the perimeter without delays, you cannot enter or exit the premises without disarming the system. Opening a perimeter door before disarming will generate an alarm. If this happens, silence the alarm by turning off your system and call your security company to let them know that it is not an emergency situation.

5. To disarm your security system, enter your personal passcode and press **ENTER**.

The display then returns to idle text.



PERIMETR DELAY ? (COMMAND + 3)

Turn On the Perimeter With Delays

Description

In residential systems this function allows you to only arm the perimeter and exit through a door programmed for exit delay. The interior of the building remains disarmed. People or pets are free to move throughout the interior of the premises.

This function is also useful in commercial systems when you are working before or after business hours and wish to have the perimeter armed. Other system users can enter through doors programmed for entry delay, which will start the entry delay sounder and countdown.

Using Perimeter Delay

1. Interior points are not armed with this command and may remain faulted while arming with COMMAND 3.
2. Press the **COMMAND** key.

The display shows **System Command**:



3. Press the **3** key.



If you prefer, you may use the Command Menu in place of steps 2 and 3 to initiate this function.

Press the **MENU>** soft key to enter the Command Menu,



then press **NEXT>** soft key repeatedly.



until you reach the **PERIMETR DELAY ?>** prompt, then press the adjacent soft key.



4. The display shows **Exit now! #** (# = exit delay time remaining).

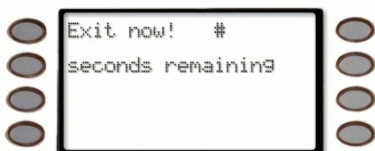

After the exit delay expires, **Perimeter On Delayed** is displayed.



5. To disarm your security system, enter your personal passcode and press **ENTER**.



The display then returns to idle text.

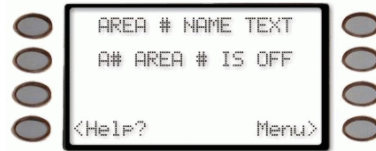

Silence the Trouble Sounder & Clear Trouble Display (COMMAND + 4)

Description

Use COMMAND 4 to silence the trouble sounder during system events. This command also clears system messages from the display. If an alarm has occurred and was silenced, the ***ALARM SILENCED*** display will continue to scroll to remind you that cleared events can be seen with the View Memory function (refer to *VIEW MEMORY ? (COMMAND + 4 + 0)* on page 24).

Using COMMAND 4:

1. The display shows disarmed idle text.



Press the **COMMAND** key. The display shows ***System Command***.



2. Press the 4 key.
3. The Keypad sounder is silenced.

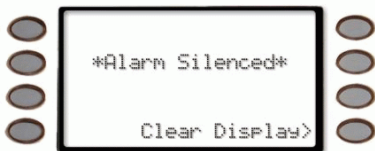

VIEW MEMORY ? (COMMAND + 4 + 0)

View Event Memory

Description

Your system stores events that occurred since the last time memory was cleared. Use COMMAND 40 to view Event Memory.

Event Memory allows you or a service technician to review events after they are cleared from the keypad's display. ***ALARM SILENCED*** will continue to scroll to remind you that events are stored in Event Memory.

Each time you turn on the system on, the Event Memory is erased and the **ALARM SILENCED** message is cleared.

Using View Memory:

1. The display shows disarmed idle text.

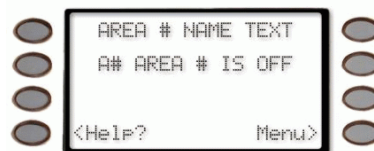

2. Press the **COMMAND** key. The display shows ***System Command***.



3. Press the 4 key and then the 0 key.

If you prefer, you may use the Command Menu in place of steps 2 and 3 to initiate this function.

Press the MENU> soft key to enter the Command Menu.

Menu>

Press NEXT> soft key repeatedly.

Next>

When you reach the VIEW MEMORY ?> prompt, press its adjacent soft key.

VIEW MEMORY ?>

Press ENTER.

4. Your system displays event summary lines and point text in this order:
 - a. fire alarm summary line
 - b. point text for each fire alarm event
 - c. alarm summary line
 - d. point text for each alarm event
 - e. fire trouble summary line
 - f. point text for each fire trouble event
 - g. trouble summary line
 - h. point text for each trouble event.
5. Press **NEXT>** to scroll through the events.



If there are no events to view, **There are currently no events in memory** displays.

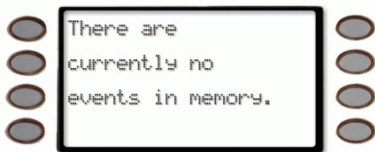

6. You can return to idle text at any time by pressing **Exit>** soft key.



WALK TEST ? (COMMAND + 4 + 4)

Walk Test

Description

Use this function to test keypads, detection devices, and sounders (both interior and exterior) to be certain they function properly. You can review untested points at your keypad to help pinpoint any problems.

You cannot arm your system while in the walk test mode, and no alarm reports are sent to your security company unless a 24-hour point is activated (such as fire or panic). A Walk Test Start Report may be programmed to be sent to your security company.

Upon initiation, the walk test will test the burglary bell pattern on the bell output and ring the keypad burglary bell for 2 seconds. The AC will be disabled for 4 minutes in order to test the system's battery power. If the battery cannot maintain the system for the 4-minute period, the keypad will appear to go dead. If your keypads are programmed to be supervised, the main alarm panel will beep intermittently during this 4-minute period. If this happens, contact your security company. At the end of the 4-minute period, AC is returned to the system and the panel restores. To test individual detection devices, simply activate sensors and open protected doors and windows one-at-a-time. As each detection device is faulted, the Keypad emits a brief tone and the display indicates for 60 seconds that the point has been tested. This verifies that each detection device is working properly.

Using Walk Test:

1. The display shows disarmed idle text.

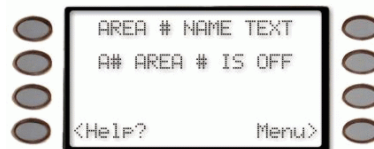

2. Press the **COMMAND** key. The display shows ***System Command***.



3. Press the **4** key and then the **4** key.

 If you prefer, you may use the Command Menu in place of steps 2 and 3 to initiate this function.

Press the MENU> soft key to enter the Command Menu.



Press NEXT> soft key repeatedly.



When you reach the WALK TEST ?> prompt, press its adjacent soft key.



Press ENTER.



- The burglary bell sounds for 2 seconds. When the display shows **### points remain to be tested** (### is the number of points) you can begin.

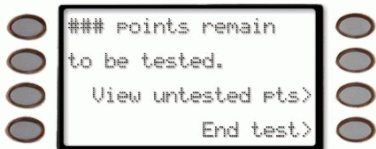

 If you know the point number, you can enter it by pressing its number key and then the ENTER key

The display will change to show the point that was entered. If the point is invalid the message "Invalid Point" or "This is not a valid walk point" appears.

Test each point by first opening and then closing the door or window or other detection device.

Check the display after testing each point. For interior points, walking past the device once is sufficient. If any point does not test correctly, contact your security company for service.

- During the Walk Test you may want to see the points that remain untested by pressing the **View untested pts>** soft key.

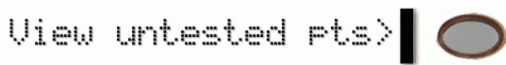

The display shows **### points untested**.

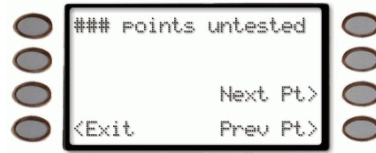

Press the **Next Pt>** or **Prev Pt>** soft keys to see information about specific points that have not yet been tested.

- Move through this list by pressing the **Next Pt>** soft key.

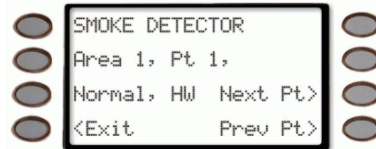

The display changes to show the information for that point.

Press the **Exit>** soft key to return to the **### points remain to be tested** screen before continuing with the walk test.

- When all points have been tested, **0 points remain to be tested** is displayed.

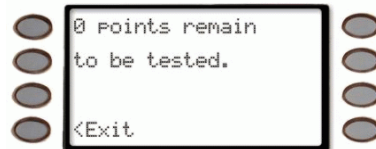

Press the **<Exit** soft key.

The display momentarily shows **All points have been tested**.

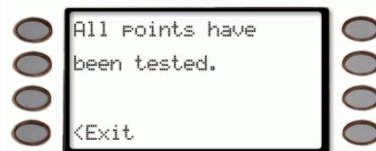

The displays then shows idle text.



RESET SENSORS ? (COMMAND + 4 + 7)

Reset Sensors

Description

Detection devices, such as smoke detectors and shock sensors, must be reset after being activated. This function momentarily removes power from these sensors to reset them.

It also clears point information from the display, leaving the ***ALARM SILENCED*** message in the display as a reminder that the View Memory function can be used to view the cleared point information.

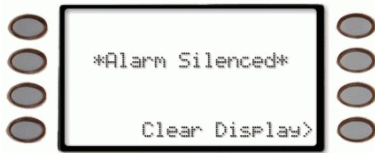

To clear the event memory and remove the ***Alarm Silenced*** message from the display, press the **Clear Display>** soft key.

The display will show the instructions for clearing the message. Enter a valid passcode and press the **Clear>** soft key.

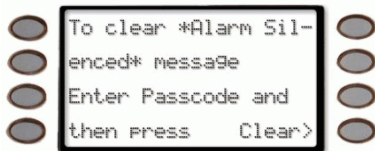

Arming the system will also clear the display and the event memory.

Using Reset Sensors:

1. The display shows disarmed idle text.



2. Press the **COMMAND** key. The display shows ***System Command***.



3. Press the 4 key, followed by the 7 key.



If you prefer, you may use the Command Menu in place of steps 2 and 3 to initiate this function.

Press the MENU> soft key to enter the Command Menu.



Press NEXT> soft key repeatedly.



When you reach the RESET SENSORS ?> prompt, press its adjacent soft key.

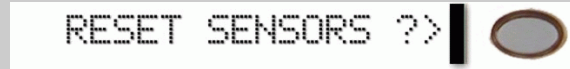

Press ENTER.



4. The display shows for approximately 15 to 20 seconds.

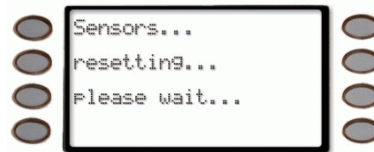

The display then shows retrieving the panel information.

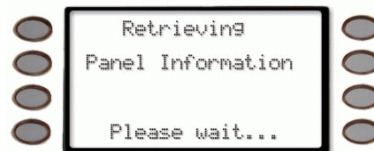

The display then returns to show idle text.



If you enter this function and the detector or sensor resets momentarily, but then returns to a faulted condition, the conditions causing the activation may still be present or the detector may be faulty. Check to be certain that there is no smoke, fire, or other danger present. If you can't reset the detector or sensor contact your security company.

WATCH MODE ? (COMMAND + 6)

Watch Mode

Description

With your security system disarmed, you can use watch mode to monitor some points. Each time some points are faulted (door or window is opened) the keypad chimes once and displays the point text for 60 seconds. No alarms are generated by this mode except 24-hour alarms (fire, panic, etc.).

When the keypad's keypad lighting is on, the keypad does not chime. The keys light for 20 seconds whenever you press a key.

Use this function in residential systems to monitor entries or exits in your home. In commercial systems it can serve as a door chime to alert you when a customer or delivery person enters your business.



Contact your security company to find out which points are watch points and whether or not your system automatically turns the Watch Mode on whenever you disarm.

Entering Watch Mode:

1. The display shows disarmed idle text.



Press the **COMMAND** key. The display shows ***System Command***.



2. Press the 6 key.



If you prefer, you may use the Command Menu in place of steps 2 and 3 to initiate this function.

Press the MENU> soft key to enter the Command Menu.



Press NEXT> soft key repeatedly.



When you reach the WATCH MODE ?> prompt, press its adjacent soft key.



Press ENTER.



3. The display briefly shows **Watch Mode is now on.**

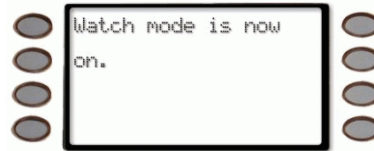

The display returns to show idle text.



Exiting Watch Mode:

1. The display shows disarmed idle text.

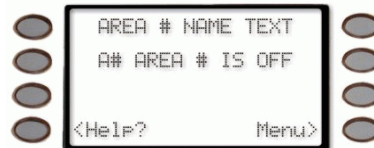

Press the **COMMAND** key. The display shows ***System Command***.



2. Press the 6 key.

 If you prefer, you may use the Command Menu in place of steps 2 and 3 to initiate this function.

Press the MENU> soft key to enter the Command Menu.



Press NEXT> soft key repeatedly.



When you reach the WATCH MODE ?> prompt, press its adjacent soft key.



Press ENTER.



- The display briefly shows **Watch Mode is now off.**

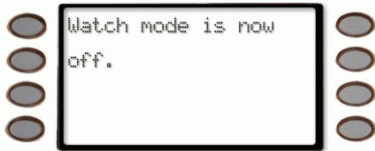

The display returns to show idle text.



PERIMETR PART ? (COMMAND + 8)

Partially Turn On the Perimeter

Description

This function is used to turn on the perimeter of your building while selected portions of the perimeter remain turned off. Perimeter points that are not secure (faulted) when this function is entered are automatically bypassed and are not included in the system. This function does not turn on the interior of your building. Entry/exit delays are provided with this arming command.

Use this function in residential systems to turn on the front of your house while the interior and the rear perimeter doors are left turned off, giving you freedom of movement between the house and patio.

In commercial systems, when you need access to the large overhead doors to receive deliveries, using this function will allow you to keep the rest of the building perimeter armed.

Using Perimetr Part:

- The display shows disarmed idle text.

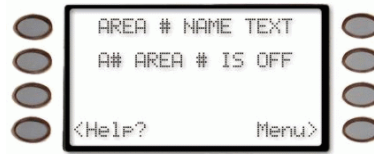

Press the **COMMAND** key. The display shows ***System Command***.



- Press the **8** key.

 If you prefer, you may use the Command Menu in place of steps 2 and 3 to initiate this function.

Press the MENU> soft key to enter the Command Menu.



Press NEXT> soft key repeatedly.



When you reach the PERIMETR PART ?> prompt, press its adjacent soft key.



Press ENTER.



- The display prompts the user to exit the area and starts counting down from 10 seconds to arm the system.

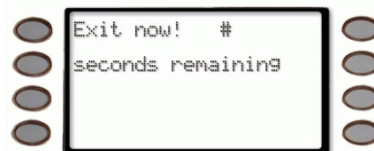

is the number of seconds remaining, counting down from 10 seconds, before the system is armed.

- When exit delay time expires and the system turns on, the display shows:



- When performing a COMMAND 8 and no points are faulted or if the points return to normal before the exit delay time expires, the system is turned on as in COMMAND 3.
- To disarm, enter your personal passcode and press **ENTER**.

Special Alerts (COMMAND + 7 and COMMAND + 9)

Description

Commands 7 and 9 can be programmed to respond to a choice of numerous situations that may need immediate attention. They may also be used to send a silent alarm to your security company without sounding an alarm signal on the premises. Check with your security company for the options they offer.

Using COMMAND 7:

- The display shows disarmed idle text.

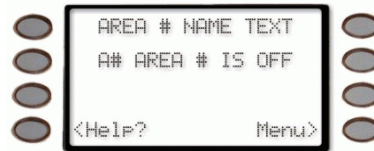

Press the **COMMAND** key. The display shows ***System Command***.



- Press the 7 key.

If you prefer, you may use the Command Menu in place of steps 2 and 3 to initiate this function.

Press the MENU> soft key to enter the Command Menu.

Menu>

Press NEXT> soft key repeatedly.

Next>

When you reach the USER CMD 7 ?> prompt, press its adjacent soft key.

USER CMD 7 ?>

Press ENTER.

3. Your COMMAND 7 special alert has been programmed to:

- notify your alarm company
- ring a bell on your premises
- display at your keypad

Description:

3. Your COMMAND 9 special alert has been programmed to:

- notify your alarm company
- ring a bell on your premises
- display at your keypad

Description:

Using COMMAND 9:

1. The display shows disarmed idle text.



Press the **COMMAND** key. The display shows ***System Command***.



2. Press the 9 key.

If you prefer, you may use the Command Menu in place of steps 2 and 3 to initiate this function.

Press the MENU> soft key to enter the Command Menu.

Menu>

Press NEXT> soft key repeatedly.

Next>

When you reach the USER CMD 9 ?> prompt, press its adjacent soft key.

USER CMD 9 ?>

Press ENTER.

Part III: Advanced Commands

Use this section of the manual to perform advanced system functions like add and delete user passcodes, reassign authority levels to user passcodes and operate or change programmed scheduled events (Skeds) from the keypads. As you make changes to the system, update the information contained in the tables in this guide to provide an accurate account of the programmed information.

Advanced Commands



Some commands listed below may not be available. Contact your security company for more information.

Advanced		Advanced	
COMMAND	Function	COMMAND	Function
	Bypass a Point		Change Sked
	Unbypass a Point		Delete Passcode
	Test Report		Change Relay
	Status Report		Change Passcode
	Remote Program		Add Passcode
	Change Time/Date		Default Text
	Door Control		Fire Test
	Access Level Change		Display Rev
	Change Display		Print Log
	Move to Area		View Log
	Extend Closing		View Point Status

Terms Used in This Section

Listed below are some of the terms you'll see throughout this section. Each term is covered in greater detail later in this section and in Part II: System Commands.

Account	One or more areas reporting under a particular account number.
Area	A group of detection devices connected to your security system.
Arm and Disarm	To switch your burglar detection devices "on" and "off." When the burglar detection device is armed and is tripped, an alarm may be set off. When the burglar detection devices are disarmed, the security system will not detect intruders. Detection devices programmed as 24-Hour or Fire points are always on.
Authority Levels	Levels of access authority assigned to passcodes.
Keypad	Arming station used to operate your security system.
Keypad Scope	Determines which areas a particular keypad can access.
Panel	The main control unit, which is locked in a steel enclosure. It sends data to and receives inputs from the keypads.
Relays	Optional dry contact outputs that respond to system events.
Skeds	Functions programmed by your security company that occur at predetermined

times.

User Passcodes

A three to six digit number entered at a keypad to access the system.

BYPASS A POINT? (COMMAND + 0)

Description

This command allows you to bypass points that you do not want included in the system. Points that are not included in the system do not detect intruders and cannot send any reports. You can bypass points when an area is disarmed. Bypassing a point reduces the level of security and should be used with discretion. Points remain bypassed until you unbypass them or some points may return when the area is disarmed. See *Unbypassing a Point* (COMMAND 00).

You could use **COMMAND 0** to leave a window open over night without initiating an alarm. Also see *Turning the System On With Doors or Windows Open*.

Using Bypass a Point

1. The display shows disarmed idle text.



Press the **COMMAND** key. The display shows ***System Command***.



2. Press the 0 key.

If you prefer, you may use the Command Menu in place of steps 2 and 3 to initiate this function.

Press the MENU> soft key to enter the Command Menu.

Menu>

Press NEXT> soft key repeatedly.

Next>

When you reach the BYPASS A POINT ?> prompt, press its adjacent soft key.

BYPASS A POINT ?>

Press ENTER.

3. You will prompted for your passcode. It will appear on the display as asterisks (*).

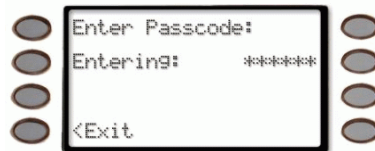

4. The display changes to show **Enter point number or press next key.**

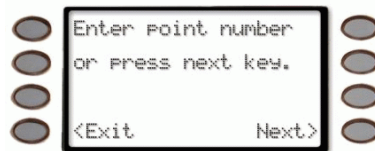

- If a digit is pressed, the display shows **Enter point number: #**. As soon as a digit key is pressed, the display changes to **Entering point number:**

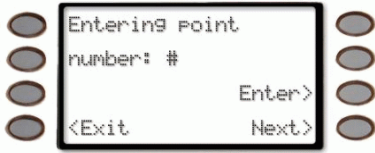

(# is the point number entered)

If you know the point number you wish to bypass, enter the number and press the **Enter>** soft key or the **ENTER** button.

If you don't know the number of the point you wish to bypass, you can view the list of devices that can be bypassed by pressing the **Next>** soft key.

Continuously pressing **Next>** scrolls through the available points that can be bypassed.

When the point text of the point you wish to bypass appears, press the **Bypass>** soft key.

One of the following messages displays (FRONT DOOR is used here as an example):

- FRONT DOOR is not bypassed** indicates the point is not bypassed and the option is given to bypass it.

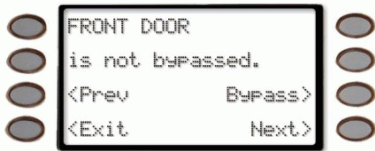

- FRONT DOOR is now bypassed.** indicates the point was successfully bypassed.



- FRONT DOOR is already bypassed.** indicates that the point has already been bypassed.

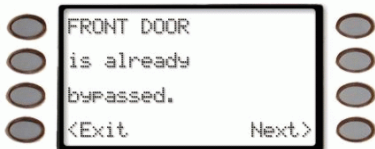

- FRONT DOOR cannot be bypassed.** indicates the system is programmed not to allow that point to be bypassed.

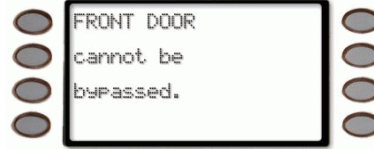

- Invalid point Please try again.** indicates that the entered point doesn't exist and the display returns to allow another point to be entered.



- No additional points.** indicates that there are no more points that can be bypassed.

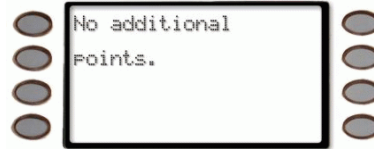

- You can return to idle text by pressing **<Exit**.
- If the bypassed point is a 24-hour point, the message **24Hr Point Bypassed** begins alternating in the display with **A1 AREA IS OFF**.

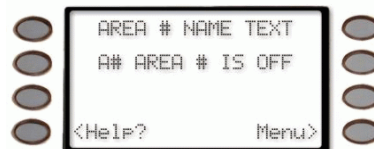
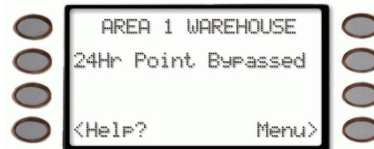

If the bypassed point is a Fire Point, the message **Fire Point Bypassed** begins alternating in the display with **A1 AREA IS OFF**.

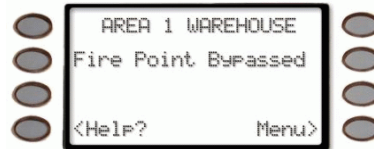

UNBYPASS A POINT? (COMMAND + 0 + 0)

Description

Unbypassing a point is a way to return a bypassed point to the security system so that it can once again respond to trouble and alarm conditions.

Using Unbypass a Point:

1. The display shows disarmed idle text.

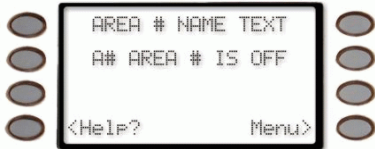

Press the **COMMAND** key. The display shows ***System Command***.



2. Press the **0** key twice.

If you prefer, you may use the Command Menu in place of steps 2 and 3 to initiate this function.

Press the MENU> soft key to enter the Command Menu.

Press NEXT> soft key repeatedly.

When you reach the UNBYPAS A POINT ?> prompt, press its adjacent soft key.

Press ENTER.

3. You will be prompted for your passcode. It will appear on the display as asterisks (*).

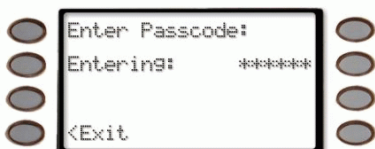

4. The display changes to show **Enter point number or press next key.**

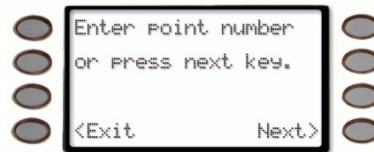

5. If digits are pressed, the display shows **Enter point number: #.** As soon as a digit key is pressed, the display changes to **Entering point number:**

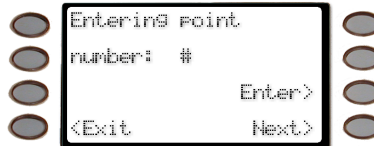

(# is the point number that was entered)

If you know the point number you wish to unbypass, enter the number and press the **Enter>** soft key or the **ENTER** button.

If you don't know the number of the point you wish to unbypass, you can view the list of devices that can be unbypassed by pressing the **Next>** soft key.

Continuously pressing **Next>** scrolls through the available points that are currently bypassed.

When the point text of the point you wish to unbypass appears, press the **Unbypass>** soft key.



One of the following messages displays (FRONT DOOR is used here as an example):

- **FRONT DOOR is not bypassed** indicates the point is not bypassed and the option is given to bypass it.



- **FRONT DOOR is now bypassed** indicates the point was successfully bypassed.



- **FRONT DOOR is already bypassed.** indicates that the point has already been bypassed.



- **FRONT DOOR cannot be bypassed.** indicates the system is programmed not to allow that point to be bypassed.



- **Invalid point Please try again.** indicates that the entered point doesn't exist and the display returns to allow another point to be entered.

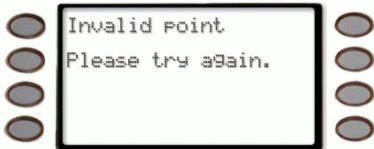

- **No additional points.** indicates that there are no more points that can be bypassed.

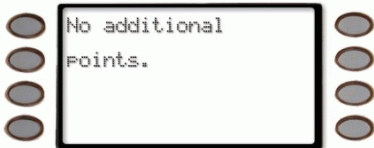

6. You can return to idle text by pressing **<Exit**.
7. If you are attempting to unbyypass a 24-Hour or Fire Point that is still faulted, the keypad will display **Cannot unbyypass 24hr faulted points.**

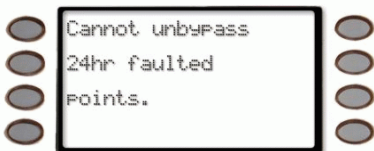

SEND REPORT ? (COMMAND + 4+1 or 4+2)

Description

This function tests the communication link between your security system and your security company. It is an important part of maintaining a high level of security for your property.

Two types of test reports may be sent. The first type of report is a simple test report (Command 41). The second type of report is a status report (Command 42). This status report indicates the current condition of your system.

Using Send Report

1. Always call your security company before sending a test report.
2. The display shows disarmed idle text.



Press the **COMMAND** key. The display shows ***System Command***.



3. Press the **4** key then the **1** key to send a test report. Press the **4** key then the **2** key to send a status report.



If you prefer, you may use the Command Menu in place of steps 2 and 3 to initiate this function.

Press the MENU> soft key to enter the Command Menu.



Press NEXT> soft key repeatedly.



When you reach the SEND REPORT ?> prompt, press its adjacent soft key.



Another menu appears allowing for the selection of sending a test report (Test Rpt?>) or a status report (Status Rpt?>). Press either one of the adjacent soft keys.

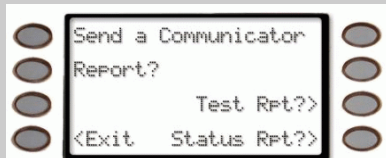

- If the test (or status) report doesn't successfully transmit to the central station, the keypad may sound a trouble tone and display **Comm Fail Route Grp#** (# = 1-4) after numerous unsuccessful attempts.

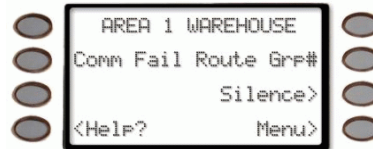

- The keypad displays **Sending report... Please wait...** until the report is transmitted to the security company.

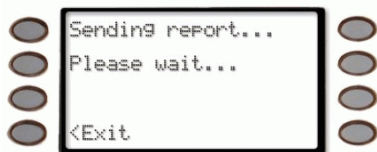

- When the transmission is complete the keypad displays **Report sent** for 5 seconds.

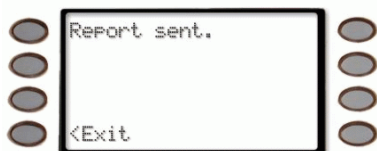

If the <Exit soft key is pressed before 5 seconds have elapsed, idle text will be displayed.

The display returns to idle text.

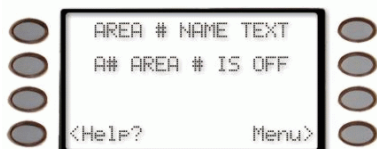

REMOTE PROGRAM ? (COMMAND + 4 + 3)

Description

This function allows the user to initiate Remote Account Manager sessions. When the phone is ringing at the panel, the user initiates this function to have the panel seize the line.

Your security company can remotely program your security system using the telephone line to which your panel is connected. Typical remote programming functions include: changing personal passcodes, changing entry/exit delays, resetting the system clock/calendar, and adding/deleting system arming commands.

Your security company may ask you to follow the steps below to begin a remote programming session. The time it takes to program the panel is dependent on the number of changes made to the program.

You'll notice that two sets of **procedures** are presented. The one you use will depend upon whether your system has a pre-programmed telephone number in its memory.

- My system has a phone number
- My system does not have a phone number

For systems without a phone number

1. The display shows disarmed idle text.



2. Call this phone number:

This number is designated for the Remote Account Manager.

You must make the call using the telephone located at:

3. Identify yourself and your premises (account number, name, address, etc.) and advise the operator of the services you wish to have performed. When the operator instructs you, proceed to steps 4 and 5.
4. Press the **COMMAND** key. The display shows ***System Command***.



5. Press the 4 key then the 3 key.
6. Do not hang up the telephone.

If you prefer, you may use the Command Menu in place of steps 2 and 3 to initiate this function.

Press the MENU> soft key to enter the Command Menu.

Press NEXT> soft key repeatedly.

When you reach the REMOTE PROGRAM ?> prompt, press its adjacent soft key.

Press ENTER.

7. The display changes to show the two choices that are available for connecting to RAM:
 - Contact RAM: RAM via phone or network
 - Answer Now



8. Press the **Answer Now**> soft key to connect to RAM.

When your security company is communicating with your panel during a RAM session, the D1260 may display **Call for Service...**

9. The display shows **RAM connecting...**



10. The security system will now disconnect telephones sharing its telephone line during the remote programming session. Hang up the telephone now.

11. At the conclusion of the programming session your system sends a report to the security company and then returns your telephone to normal service and your display to idle text.



For systems with a phone number or network connection

- ❑ My system uses a phone number for Remote Programming
- ❑ My system uses an IP Address and network connection for Remote Programming

12. Ensure your keypad shows idle disarmed text.



13. Press the **COMMAND** key. The display shows ***System Command***.



14. Press the 4 key then the 3 key.

If you prefer, you may use the Command Menu in place of steps 2 and 3 to initiate this function.

Press the MENU> soft key to enter the Command Menu.

Menu>

Press NEXT> soft key repeatedly.

Next>

When you reach the REMOTE PROGRAM ?> prompt, press its adjacent soft key.

REMOTE PROGRAM ?>

Press ENTER.

15. The display changes to show the two choices that are available for connecting to RAM:
- Contact RAM: RAM via phone or network
 - Answer Now



16. Press the **Contact RAM**> soft key to specify the connection method to RAM.

17. Press either the **RAM via phone**> (to connect the panel to the RAM software via a pre-programmed phone number) or **RAM via network**> soft key (to connect the panel to the RAM software via a pre-programmed IP network address).

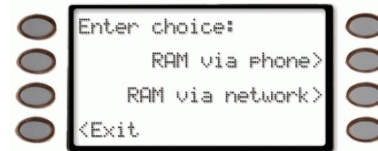

18. The display shows **RAM connecting...**



19. The security system will now call the telephone number or connect to the IP Address specified for network connection during the remote programming session.
20. At the conclusion of the programming session your system sends a report to the security company and then returns your telephone to normal service and your display to idle text.

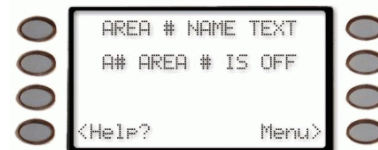

CHANGE TIME/DATE (COMMAND + 4 + 5)

The time and date in your system must be correct for scheduled events to occur at the correct times. Check the time at least once a month to ensure accuracy. Use this function to set both the time and date. The system uses a 12-hour, AM/PM format. There is the option to continuously display the time and date in place of area status. The Time and Date will be shown continuously until a new command is entered or the current area's status has changed. See CHANGE DISPLAY (COMMAND + 4 + 9), Time/Date Display for more information.

1. Ensure your keypad shows idle disarmed text.

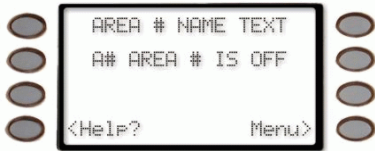

2. Press the **COMMAND** key. The display shows ***System Command***.



3. Press the 4 and then the 5 key.

If you prefer, you may use the Command Menu in place of steps 2 and 3 to initiate this function.

Press the **MENU>** soft key to enter the Command Menu.

Menu> |

Press **NEXT>** soft key repeatedly.

Next> |

When you reach the **CHG TIME/DATE ?>** prompt, press its adjacent soft key.

CHG TIME/DATE ?> |

4. The display changes to **Enter new time:**



To just change the date, press the **Set Date>** soft key, See Step 6.

If you input the wrong time, press the **<Exit** soft key to clear the time.

Enter the new time using a 12-hour (HH:MM) format.

Ex: If the desired time is 12:34, press 1 + 2 + 3 + 4



The **Set Date>** soft key will disappear when the first digit is entered.

Press the **Enter>** soft key or the **[ENTER]** button.

5. The display changes to show **AM>** or **PM>** soft keys.



Press the **AM>** soft key to select AM.

Press the **PM>** soft key to select PM.

6. The display shows **Enter new date:**



See Step 9 for use of the **Time/Date Display>** soft key.

If you input the wrong date, press the **<Exit** soft key to clear the time.



Enter the new date using a MM/DD/YY format.

Ex: If the desired time is January 1, 2002, press 0 + 1 + 0 + 1 + 0 + 2



7. Press the **Enter>** soft key or the [ENTER] button.
8. The **Time/Date Display>** soft key is used to show how the time and date entered will look.



9. The new time and/or date is displayed for 20 seconds before the display returns to idle text.

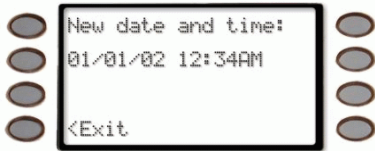

Press the **<Exit** soft key to return to idle text.

DOOR CONTROL (COMMAND + 4 + 6)

Description

There are three functions with the door control function:

- **Cycle Door** – momentarily unlocks a door to allow a person into an area
- **Unlock Door** – unlocks a door to allow free access
- **Secure Door** – locks a door and prohibits access regardless of a user's authority level

Using Door Control

1. Ensure your keypad shows idle disarmed text.



2. Press the **COMMAND** key. The display shows ***System Command***.



3. Press the **4** key and the **6** key.

If you prefer, you may use the Command Menu in place of steps 2 and 3 to initiate this function.

Press the MENU> soft key to enter the Command Menu.

Menu>

Press NEXT> soft key repeatedly.

Next>

When you reach the DOOR CONTROL ?> prompt, press its adjacent soft key.

DOOR CONTROL ?>

4. The display will change and show a choice of **Cycle Door>**, **Unlock Door>**, and **Secure Door>**.

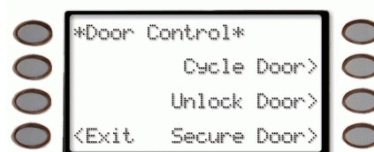

Press the adjacent soft key.

Cycle Door

1. If you wish to momentarily unlock an access door to allow a person into an area, press the **Cycle Door**> soft key.
2. The display will read ***Cycle Door*1 2 3 4 5 6 7 8** if all door are at a normal state and are available.

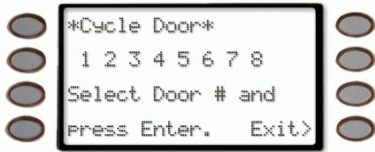

If a door is not at a normal state, the number of the door would be replaced with a symbol indicated in *Table 3*.

Table 3: Door Status	
Symbol	Meaning
-	Door is not active, in scope, or user does not have access level authority.
C	Door is on timed door sequence.
U	Strike and shunt are latched active (held open).
X	Strike and shunt are deactivated (secured).
F	There is a problem with the door. Call your security company.

3. Enter the number of the door you wish to cycle then press the **ENTER** key. This door will be cycled and the display will change to reflect the new status of the doors.
- For example, if you wanted to cycle Door 3, press **3** then press the **ENTER** key.

The display changes to show that all the doors are at a normal state except for Door 3, which is cycled.

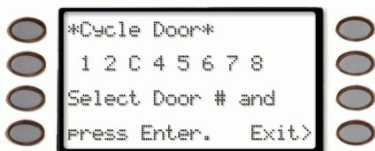

4. Enter another door number to cycle or press the **Exit**> soft key to leave this function.

Unlock Door

1. If you wish to unlock an access door to allow free access, press the **Unlock Door**> soft key.

2. The display will read ***Unlock Door*1 2 3 4 5 6 7 8** if all door are at a normal state and are available.

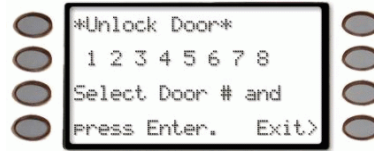

If a door is not at a normal state, the number of the door would be replaced with a symbol indicated in *Table 3*.

3. Enter the number of the door you wish to unlock then press the **ENTER** key. This door will be unlocked and the display will change to reflect the new status of the doors.

For example, if you wanted to unlock Door 3, press **3** then press the **ENTER** key.

The display changes to show that all the doors are at a normal state except for Door 3, which is unlocked.

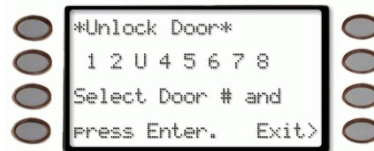

4. Enter another door number to unlock or press the **Exit**> soft key to leave this function.

Secure Door

1. If you wish to unlock an access door to allow free access, press the **Unlock Door**> soft key.
2. The display will read ***Secure Door*1 2 3 4 5 6 7 8** if all door are at a normal state and are available.

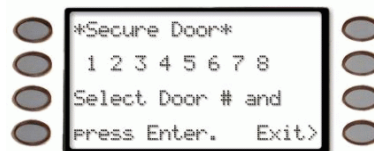

If a door is not at a normal state, the number of the door would be replaced with a symbol indicated in *Table 3* on page 42.

3. Enter the number of the door you wish to secure then press the **ENTER** key. This door will be secured and the display will change to reflect the new status of the doors.

For example, if you wanted to secure Door 3, press **3** then press the **ENTER** key.

The display changes to show that all the doors are at a normal state except for Door 3, which is secured.

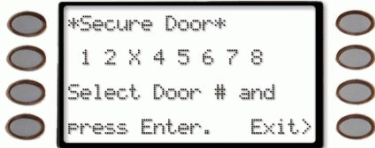

4. Enter another door number to secure or press the **Exit>** soft key to leave this function.

Access Level

This function is used to manually enable/disable access authority levels assigned to users. It can also be used to temporarily disable a user's access level instead of deleting and then re-adding the user.

- I have this feature.
- I do not have this feature.

1. Ensure your keypad shows idle disarmed text.



2. Press the **Menu>** soft key to enter the Command Menu.
3. Press **Next>** soft key repeatedly until you reach the **CHANGE LEVEL ?>** prompt.



Press the adjacent soft key.

4. A prompt will appear asking for entry of the Authority Level to be modified.



5. Enter the level number (1 – 14) and press the **Enter>** soft key.
6. If the level entered is currently enabled, the keypad will ask if you want to disable this level.

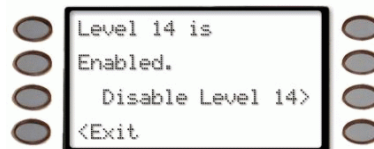

(Level 14 is used here as an example.)

7. If the level entered is currently disabled, the keypad will ask if you want to enable this level.

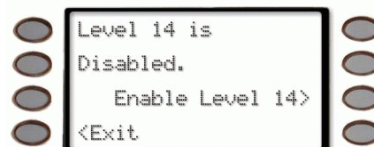

(Level 14 is used here as an example.)

8. After selecting whether to disable or enable the level, the display prompts you again to enter an Authority Level to modify.

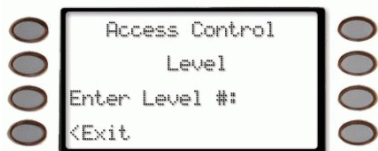

9. Press the **<Exit** soft key when you are finished.

CHANGE DISPLAY (COMMAND + 4 + 9)

This function presents three options:

- dim the display
- brighten the display
- continuously show the time and date in the display.

Brighten/Dim Display

You can change your keypad's display to make the backlit LCD display bright or dim. When the display is dim, the tones are softer than when the display is bright. Use this option for keypads in bedrooms where a brighter display and louder tones could interfere with sleep.

If you dim the keypad backlit display and an alarm or trouble condition arises, the display automatically brightens and the volume increases. The backlit display returns to dim lighting when you clear the alarm or trouble condition.

Show Continuous Time/Date

Use this function to replace the disarmed idle text with a continuous time and date display and to prevent a passersby from knowing the status of your system.

Any time your keypad has an event to display, the time and date display is automatically removed. To return the time and date display, you must perform this function again.

1. Ensure your keypad shows idle disarmed text.

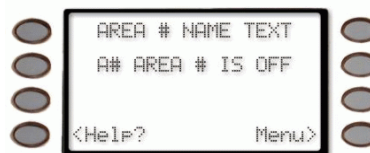

2. Press the **COMMAND** key. The display shows ***System Command***.



3. Press the **4** and then the **9** key.

 If you prefer, you may use the Command Menu in place of steps 2 and 3 to initiate this function.

Press the MENU> soft key to enter the Command Menu.



Press NEXT> soft key repeatedly.



When you reach the CHG DISPLAY ?> prompt, press its adjacent soft key.



4. The display changes to show the display options:



- **Bright Display>** - Press to increase the LCD's backlight brightness. The backlight adjustment will take effect after 20 seconds of inactivity.
- **Dim Display>** - Press to decrease the LCD's backlight brightness. The backlight adjustment will take effect after 20 seconds of inactivity.
- **Time/Date Display>** - Press to continuously show the time and date instead of idle text.

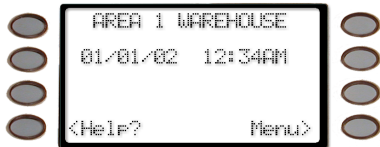

 If your system is turned on (armed), you cannot display the time.

To further adjust the LCD's brightness, the settings for the Bright Display> and Dim Display> soft keys can be changed by accessing the Service Manual (99 + Enter).

EXTEND CLOSING (COMMAND + 5 + 1)

Your system may be programmed to expect you to arm within a scheduled closing window, which is a duration of time that is programmed by your alarm company. Your system may also be programmed to automatically arm at the end of the window.

COMMAND 51 lets you extend the scheduled closing window time either prior to the closing window time or during the closing window time. Use this function when you expect to stay past the scheduled end of the closing window. Your alarm company sets the length of time prior to the start of the closing window in which you are allowed to extend the closing window.

Close window is not currently active displays during the time when the keypad won't allow the window to be extended.

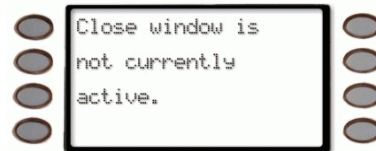

At the beginning of the closing window, the keypad beeps and displays **Please Close Now** to remind you to arm your system. It remains in the display until you arm, the close window ends, or you extend closing.

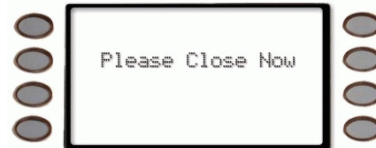

 The closing window can only be extended once the window has started.

Alarm or trouble messages replace this message in the event of an alarm or trouble condition.

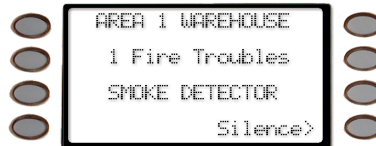

Pressing the **Silence>** soft key will silence the beep and clear the message for 10 minutes.

If the alarm or trouble condition clears before the end of the close window **Please Close Now** message returns to the keypad display.

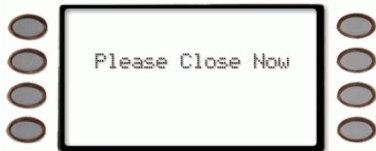

If you have not armed or extended closing, the **Please Close Now** message and beep will reappear after 10 minutes. Your alarm company sets the length of time for the closing window. To extend the window, enter the new time at which you would like the reminder tone to begin. This time will be the new beginning of the closing window. The time length of the closing window is programmed by your security company and remains fixed.

When you hear the warning you can:

- Press the **Silence**> soft key will silence the beep and clear the message for 10 minutes
- Leave before the end of the closing window
- Stay past the scheduled end of the closing window, by using COMMAND 51 to extend the closing window.



Extending the closing window does not effect the amount of time available to close.

For example, if your closing window starts at 4:00 p.m. and stops at 4:30 p.m. and you extend closing to 5:00 p.m., the closing window will now be between 5:00 and 5:30 p.m.

1. Ensure your keypad shows idle disarmed text.

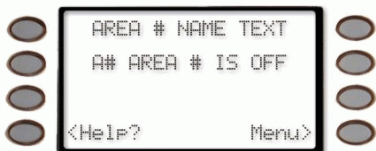

2. Press the **COMMAND** key. The display shows ***System Command***.



3. Press the 5 key and then the 1 key.



If you prefer, you may use the Command Menu in place of steps 2 and 3 to initiate this function.

Press the MENU> soft key to enter the Command Menu.



Press NEXT> soft key repeatedly.



When you reach the EXTEND CLOSING ?> prompt, press its adjacent soft key.



4. The display changes to show the current start time.

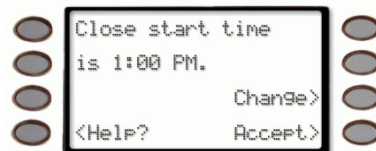

Press the **Change**> soft key to change the start time.

Press the **Accept**> soft key to accept the start time and return to idle text.

5. Enter the new time using a 12-hour (HH:MM) format.

Ex: If the desired time is 12:34, press [1] [2] [3] [4]

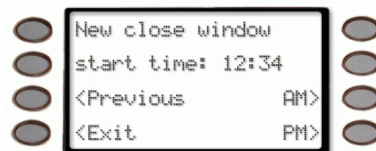

Press the **AM**> soft key to select AM.

Press the **PM**> soft key to select PM.

6. The display changes to show the new start time briefly before returning to idle text.



7. Press the **Accept**> soft key to accept the Close Start time.

CHG SKEDS ? (COMMAND + 5 + 2)

Description

A Sked is a function programmed to be performed automatically at a scheduled time by your security system. You can change the scheduled time for some functions, disable the Sked and thus prevent it from automatically happening or restart a previously disabled Sked. Contact your security representative to determine what Skeds may be programmed for your system.

To change a Sked's time, enable a Sked, or disable a Sked, follow the procedure below to first select the Sked from a list of Skeds programmed for your system.

Using Chg SKEDS

1. Ensure your keypad shows idle disarmed text.

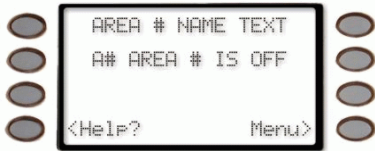

2. Press the **COMMAND** key. The display shows ***System Command***.



3. Press the **5** key and then the **2** key.

If you prefer, you may use the Command Menu in place of steps 2 and 3 to initiate this function.

Press the **MENU>** soft key to enter the Command Menu.

Menu> |

Press **NEXT>** soft key repeatedly.

Next> |

When you reach the **CHG SKEDS ?>** prompt, press its adjacent soft key.

CHG SKEDS ?> |

4. The number of the first Sked programmed into your system is displayed, plus either its time or an indication that it is disabled.

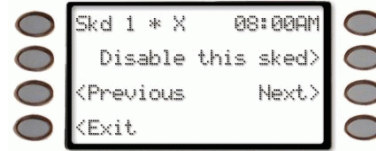

Press the **Next>** soft key to scroll through the list of Sked numbers to find the one you wish to change.

Your alarm system may be programmed with up to 40 Skeds. If the Sked number being displayed is not programmed, the keypad will display **Skd11 - No program.** (11 is used as an example).

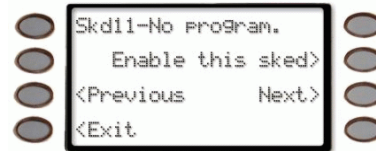

When an **X** appears in the Sked display, it is an indication that "Except on Holidays" is enabled.

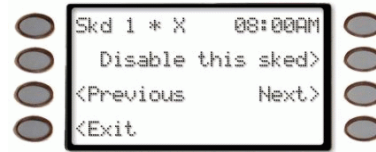

Specific holidays are programmed by your security company.

When an ***** appears in the Sked display, it is an indication that the Sked has or will happen today.

5. If the Sked is currently enabled, the sked is shown with **Disable this sked>** on the second line. Press the adjacent soft key.
6. The display changes to show that the sked is disabled.

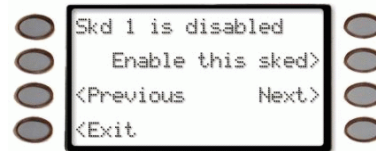

If the Sked is currently disabled, the display says **Skd 1 is disabled.**

Press the **Enable this sked>** soft key.

7. The display shows two soft keys:

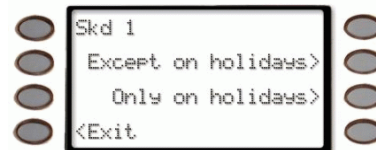

- **Only on holiday>**



Pressing this soft key will enable the sked only on holidays and change the first line of the display to **Skd 1 X 08:00AM** without the **X**.

- **Except on holiday>**



Pressing this soft key will disable the sked on holidays and change the first line of the display to **Skd 1 08:00am** with the **X**.

Consult your security company and determine which holidays have been programmed in your system.

The display changes to allow a new time to be entered.

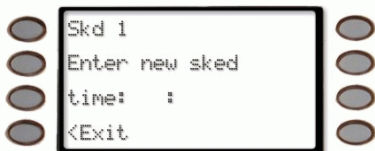

Enter the new time using a 12-hour (HH:MM) format.

Ex: If the desired time is 8:00, press **8 + 0 + 0**.

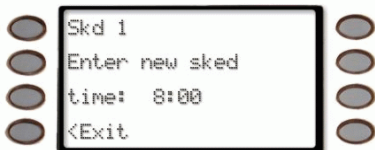

Press the **Enter>** soft key or the **ENTER** button.

8. If the time is a valid time, the keypad display changes to show the new time with a selection of AM or PM.

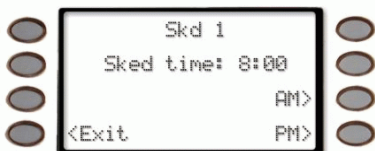

Press the **AM>** soft key to select AM.

Press the **PM>** soft key to select PM.

9. The display shows the Sked with the new time.

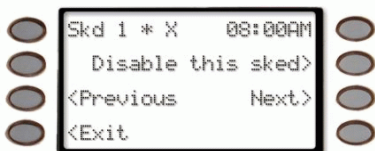

Press the **<Exit** soft key to return to idle text.

Table 4: Sked Table

SKED #	Except on Holiday	Time	Date	Day of Week	Function
SKED 1	Yes / No			SMTWTFS	
SKED 2	Yes / No			SMTWTFS	
SKED 3	Yes / No			SMTWTFS	
SKED 4	Yes / No			SMTWTFS	
SKED 5	Yes / No			SMTWTFS	
SKED 6	Yes / No			SMTWTFS	
SKED 7	Yes / No			SMTWTFS	
SKED 8	Yes / No			SMTWTFS	
SKED 9	Yes / No			SMTWTFS	
SKED 10	Yes / No			SMTWTFS	
SKED 11	Yes / No			SMTWTFS	
SKED 12	Yes / No			SMTWTFS	
SKED 13	Yes / No			SMTWTFS	
SKED 14	Yes / No			SMTWTFS	
SKED 15	Yes / No			SMTWTFS	
SKED 16	Yes / No			SMTWTFS	
SKED 17	Yes / No			SMTWTFS	
SKED 18	Yes / No			SMTWTFS	
SKED 19	Yes / No			SMTWTFS	
SKED 20	Yes / No			SMTWTFS	
SKED 21	Yes / No			SMTWTFS	
SKED 22	Yes / No			SMTWTFS	
SKED 23	Yes / No			SMTWTFS	
SKED 24	Yes / No			SMTWTFS	
SKED 25	Yes / No			SMTWTFS	
SKED 26	Yes / No			SMTWTFS	
SKED 27	Yes / No			SMTWTFS	
SKED 28	Yes / No			SMTWTFS	
SKED 29	Yes / No			SMTWTFS	
SKED 30	Yes / No			SMTWTFS	
SKED 31	Yes / No			SMTWTFS	
SKED 32	Yes / No			SMTWTFS	
SKED 33	Yes / No			SMTWTFS	
SKED 34	Yes / No			SMTWTFS	
SKED 35	Yes / No			SMTWTFS	
SKED 36	Yes / No			SMTWTFS	
SKED 37	Yes / No			SMTWTFS	
SKED 38	Yes / No			SMTWTFS	
SKED 39	Yes / No			SMTWTFS	
SKED 40	Yes / No			SMTWTFS	

DEL USER ? (COMMAND + 5 + 3)

This function allows a user to be deleted.



This function will delete the passcode, Master User, and all sub-users associated with the user number.

1. Ensure your keypad shows idle disarmed text.

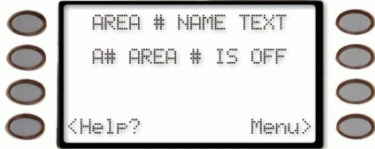

2. Press the **COMMAND** key. The display shows ***System Command***.



3. Press the **5** key and then the **3** key.



If you prefer, you may use the Command Menu in place of steps 2 and 3 to initiate this function.

Press the **MENU>** soft key to enter the Command Menu.



Press **NEXT>** soft key repeatedly.



When you reach the **DEL USER ?>** prompt, press its adjacent soft key.



4. The display changes to show **Enter user # to be deleted:**



Enter the user number, not the passcode. (123 is as an example.)

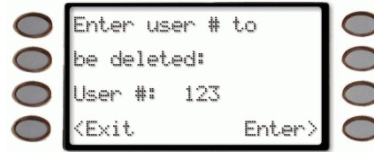

Press either the **Enter>** soft key or the **ENTER** button.

5. If the user number entered is a valid user in the system, the display will show **Delete User 123? Are you sure?**



(123 is as an example.)

If the user number entered is not a valid user in the system, the display will show **This user is currently not in use.**



6. Press the **Yes>** soft key to delete the user.

The display briefly shows that the user has been deleted before returning to idle text (123 is used as an example).



The user text is not deleted when deleting a user. To modify a user's text, see Add/Change User (Command 56).

CHG RELAYS ? (COMMAND + 5 + 4)

Your security company may program relays for automatic control and/or control from your keypad of devices such as premises lighting or entry gates. Contact them for further information regarding the use of relays in your security system.

1. Ensure your keypad shows idle disarmed text.

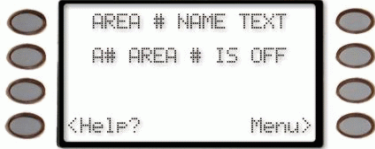

2. Press the **COMMAND** key. The display shows ***System Command***.



3. Press the 5 key and then the 4 key.

If you prefer, you may use the Command Menu in place of steps 2 and 3 to initiate this function.

Press the MENU> soft key to enter the Command Menu.

Menu>

Press NEXT> soft key repeatedly.

Next>

When you reach the CHG RELAYS ?> prompt, press its adjacent soft key.

WALK TEST ?>

4. The command center display changes ***Change Relay* Enter relay number:**

Valid entries are 1 to 128, depending how the system is configured.



Enter the relay number then press either the **Enter>** soft key or the **ENTER** button.



5. If the relay is valid and turned off, the display changes to **Change Relay* Relay 123 is currently off.**

(123 is used as an example.)

Press the **Turn on>** soft key to turn on the relay.

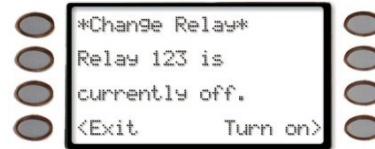

6. If the relay is valid and turned on, the display changes to **Change Relay* Relay 123 is currently on.**

(123 is used as an example.)

Press the **Turn off>** soft key to turn off the relay.

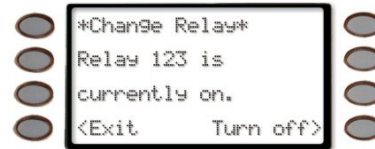

7. The display returns to the ***Change Relay* Enter relay number:**

Press the **<Exit** soft key to return to idle text.



CHG PASSCODES ? (COMMAND + 5 + 5)

Description

Use this function to change your personal passcode without assistance from the security company.

Before you begin:

- Choose a new passcode three to six digits long. If you choose a passcode with the same digit in consecutive order (for example “33” in 334697), take care when entering it.

- To avoid conflicting with other passcodes and duress codes, your system does not let you change passcodes to an existing passcode or to within plus or minus 2 of an existing passcode. For example, if 1234 were an existing code, your system would not let you change your code to 1232, 1233, 1234, 1235, or 1236.

Using Chg Passcodes

- Ensure your keypad shows idle disarmed text.



- Press the **COMMAND** key. The display shows ***System Command***.



- Press the 5 key and then the 5 key.

If you prefer, you may use the Command Menu in place of steps 2 and 3 to initiate this function.

Press the MENU> soft key to enter the Command Menu.

Menu>

Press NEXT> soft key repeatedly.

Next>

When you reach the CHG PASSCODES ?> prompt, press its adjacent soft key.

CHG PASSCODES ?>

- You will prompted for your passcode.
As soon as a number is pressed, **Entering:** appears on the third line next to the asterisks.
The passcode is shown as asterisks (*) when entered and advance from the right side of the display to the left until all passcode digits are entered.

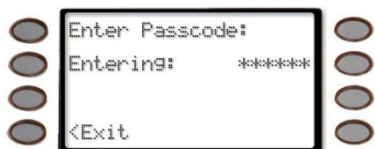

- The display changes to **Enter new passcode:**
Enter the new passcode.
As soon as a number is pressed, **Entering:** appears on the third line next to the asterisks.



The passcode is shown as asterisks (*) when entered and advance from the right side of the display to the left until all passcode digits are entered.

- Press the ENTER button.
If an invalid passcode is entered, the command center will momentarily display **Passcode is already in use. Please try again.**

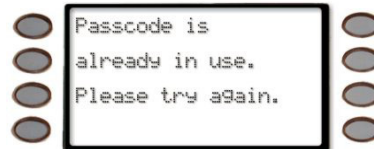

- If the new passcode is valid, the display changes to **Enter new passcode again:**
Enter the new passcode again.
As soon as a number is pressed, **Entering:** appears on the third line next to the asterisks.



The passcode is shown as asterisks (*) when entered and advance from the right side of the display to the left until all six passcode digits are entered.

- If the passcode matches the previously entered passcode, the display changes to **Passcode changed.**

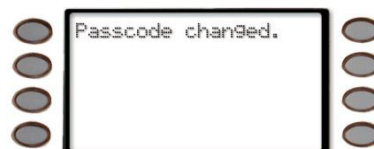

If the passcode does not match, the command center will emit a error tone and display **Passcode not changed.**

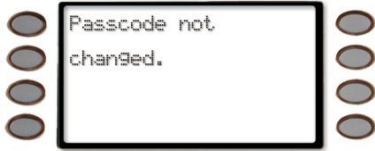

- The display automatically returns to idle text after three seconds.



ADD/CHANGE USER (COMMAND + 5 + 6)

Use this function to add or change a user to your system without assistance from your security company. You need to know which user numbers are available, the authority level you want to assign to the new passcode and the areas in which it will be valid before you add it.

The user numbers identify users in reports transmitted from your system. Additionally, you will be able to change the following:

- the authority level (which determines what system functions the passcode can access)
- the area number (which identifies which parts of your security system the user will have access to)
- the name of the user
- the card number they use for access control
- whether they are a Master or Sub-User.

Contact your security company if you don't know what user numbers, authority levels, or areas are available. See the Appendix for further information on adding passcodes.

Before you begin, keep these points in mind:

- Do not try to add new users without knowing the available user numbers. An already defined user number will be overwritten when the new user is defined. These are two or three digit numbers, not to be confused with passcodes, that identify users at your security company.
- When choosing passcodes, choose a new passcode three to six digits long. If you choose a passcode with the same digit in consecutive order (for example "33" in 334697), take care when entering it.

- To avoid conflicting with other passcodes and duress codes, your system does not let you change passcodes that are the same within plus or minus 2 of an existing passcode. For example, if 1234 were an existing code, your system would not let you add or change your code to 1232, 1233, 1234, 1235, or 1236.
 - Choose an authority level for each area. Not assigning the authority level for an area denies the passcode access to that area.
- Ensure your keypad shows idle disarmed text.



- Press the **COMMAND** key. The display shows ***System Command***.



- Press the **5** key and then the **6** key.

If you prefer, you may use the Command Menu in place of steps 2 and 3 to initiate this function.

Press the MENU> soft key to enter the Command Menu.

Menu>

Press NEXT> soft key repeatedly.

Next>

When you reach the ADD/CHG USER ?> prompt, press its adjacent soft key.

ADD/CHG USER ?>

- The display changes to show **Add / Change User Enter user #:**

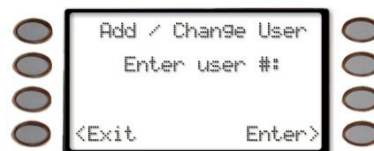

5. Enter the user number and press either the *Enter*> soft key or the **ENTER** button.



6. The display changes to show the user number entered and the user's name (if any).

(User 2 is used as an example.)

Press the *Continue*> soft key to proceed on to changing the user's information.

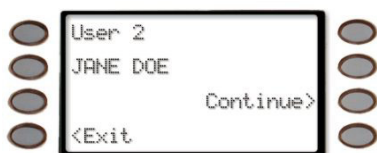

If there is no name for the user, the text *USER 2* appears in the second line.

(User 2 is used as an example.)

Press the *Continue*> soft key to change the user's information.

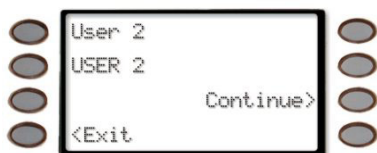

7. The display changes to *Add/Change Menu*.

The display varies depending on the type of control panel that was installed in your system.

- ❑ My system has a D9412 or D7412 Control Panel
- ❑ My system has a D9112 or D7212 Control Panel

If your system has a D9412 or D7412 Control Panel, this menu allows the following User items to be changed:

- Passcode - Press the *<Passcode* soft key to change the user's passcode.
- Level - Press the *<Level* soft key to change the user's Authority Level.
- Name - Press the *Name*> soft key to change the user's name.
- Card - Press the *Card*> soft key to change the user's card.
- Sub-User - Press the *Sub-User*> soft key to change the user's sub-user status.

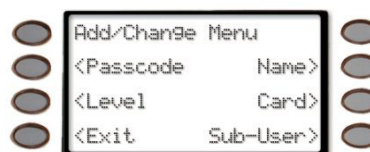

If your system has a D9112 or D7212 Control Panel, this menu allows the following User items to be changed:

- Name - Press the *Name*> soft key to change the user's name.
- Passcode - Press the *<Passcode* soft key to change the user's passcode.
- Level - Press the *<Level* soft key to change the user's Authority Level.

Add/Change Passcode

1. Pressing the *<Passcode* or the *Passcode*> soft key will allow you to add/change a user's passcode.

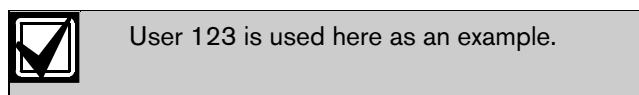

2. The display changes to User 123 Add a passcode for this user?

Press the *Yes*> soft key to add a new passcode.

Go to *Step 3*.

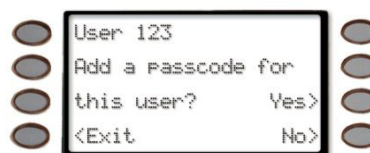

Pressing the *No*> soft key advances to Add/Change Level, if the panel is a D9112 or D7212, or Add/Change Card, if the panel is a D9412 or D7412.

If the user already has an assigned passcode. it will be detected by the panel and will automatically go to *Step 4*.

3. The display changes to **Enter new passcode:**

Enter the new passcode.

As soon as a number is pressed, **Entering:** appears on the third line next to the asterisks.



The passcode is shown as asterisks (*) when entered and advance from the right side of the display to the left until all passcode digits are entered.

Press the **ENTER** button.

If the passcode matches the previously enter passcode, the display changes to Passcode added.

Pressing the **Next>** soft key advances to the Add/Change Level (if the panel is a D9112 or D7212) or Add/Change Card (if the panel is a D9412 or D7412).

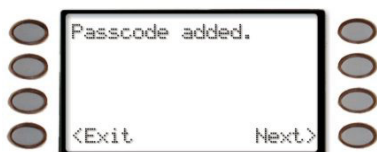

If an invalid passcode is entered, the command center will momentarily display **Passcode is already in use. Please try again.**

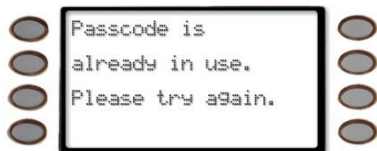

If the passcode does not match, the command center will emit an error tone and display **Passcode not changed.**

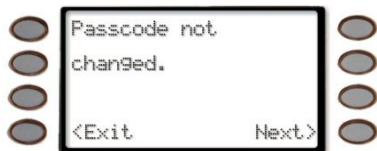

Pressing the **Next>** soft key advances to the Add/Change Level (if the panel is a D9112 or D7212) or Add/Change Card (if the panel is a D9412 or D7412).

4. The display changes to User 123 Change this user's passcode?

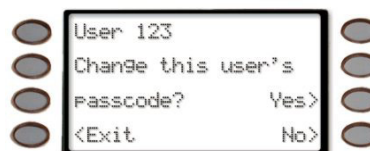

Press the **Yes>** soft key to change the passcode.

Press the **No>** soft key not to change the passcode and skip ahead to **Add/Change Level** (if the panel type is a D9112 or D7212) otherwise if the panel is a D9412 or D7412, the **Add/Change Card** appears next.

You will prompted for the user's passcode.

As soon as a number is pressed, **Entering:** appears on the third line next to the asterisks.

It will appear on the display as asterisks (*).

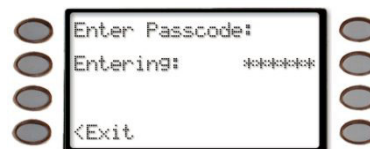

Press the **ENTER** button.

The display changes to Enter new passcode again:

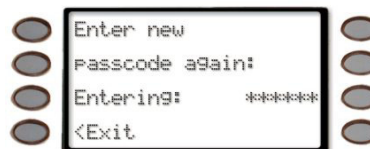

Enter the new passcode again.

Press the **ENTER** button.

If an invalid passcode is entered, the command center will momentarily display **Passcode is already in use. Please try again.**

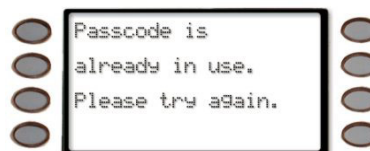

If the passcode matches the previously enter passcode, the display changes to **Passcode changed.**

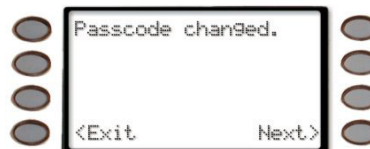

If the passcode does not match, the command center will emit an error tone and display **Passcode not changed.**

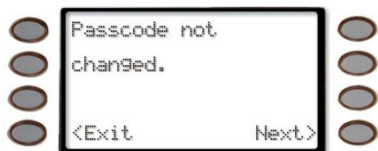

5. Press the **<Exit** soft key to return to the **Add/Change Menu.**

Add/Change Level

1. Pressing the **<Level** or the **Level>** soft key will allow you to add/change a user's authority level.
2. The display changes to **User 123 Add Auth. Level for this user?**

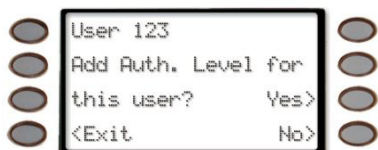

Press the **Yes>** soft key to add an Authority Level. Press the **No>** soft key to advance to Add/Change Passcode - if the panel is a D9112 or a D7212) or to Change Sub-User ID - if the panel is a D9412 or a D7412).

Press the **<Exit** soft key to exit out of this menu and return to the **Level changed.** display (Refer *Step 7*).

3. The display changes to **Is this user authorized in Area 1?**

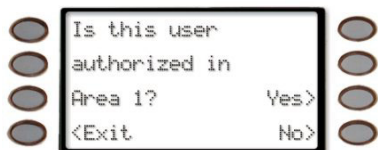

Press the **Yes>** soft key to/add change this user's authority level in Area 1.

Press the **No>** soft key if the user isn't authorized in Area 1 and proceed to display user's authorization in Area 2.

Press the **<Exit** soft key to exit out of this menu and return to the Level changed display.

If the user is authorized in Area 1, the displays changes to **User's current authority level: 14** for Area 1.

(14 is used as an example here)



To change the Authority Level, Enter a new authority level (from 1 to 14), if desired, and press either the **Enter>** soft key or the **ENTER** button.

Before determining the Authority Level for a user, please consult your security company to assist you in selecting the correct authority level.

Press the **<Exit** soft key to exit out of this menu and return to the **Level changed** display.

4. Repeat *Step 3* for each area through Area 8.

5. The display changes to **User 123 Change this user's Auth. Level?**

Press the **Yes>** soft key to add/change this user's authority level in Area 1.

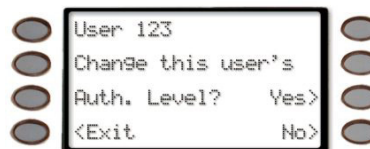

Press the **No>** soft key to advance to Add/Change Passcode (if the panel is a D9112 or a D7212) or to Change Sub-User ID (if the panel is a D9412 or a D7412).

Press the **<Exit** soft key to exit out of this menu and return to the **Level changed.** display (refer to *Step 7*).

If the user is authorized in Area 1, the displays changes to **User's current authority level: 14** for Area 1.

(14 is used as an example here)



To change the Authority Level, Enter a new authority level (from 1 to 14), if desired, and press either the **Enter>** soft key or the **ENTER** button.

Before determining the Authority Level for a user, please consult your security company to assist you in selecting the correct authority level.

Press the **<Exit** soft key to exit out of this menu and return to the **Level changed.** display.

- Repeat *Step 5* for each area through Area 8.
- Once the user's authority level has been verified for Area 8, the display changes to **Level changed.**

If the **Next** soft key is pressed, the display changes to Add/Change Sub-User ID (for D9412/D7412 panels) or Add/Change Passcode (for D9112/D7212 panels).

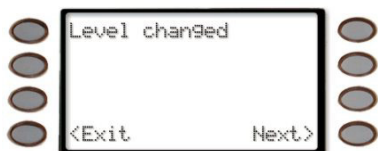

If the **<Exit** soft key is pressed, the display changes to **Add / Change User Enter User #:**

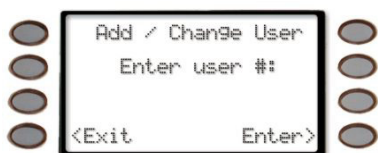

Adding/Changing a User's Name

- Pressing the **Name** soft key will change the display to **<? JANE DOE** (JANE DOE is used as an example.)

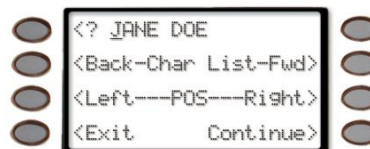

- To change the name use the following soft keys:



Pressing this soft key will display a series of help screens where the keypad can be used to enter specific letters.



Pressing either of these soft keys will cause the currently underlined character to change the previous or next character in the list. The available characters are A-Z, 0-9, @, #, \$, &, *, /, -, _, ?, and +.



Pressing either of these soft keys will cause the cursor of the currently underlined character to move left to the previous position in the name or right to the next position in the name.

Another option is to use the numeric keys to add characters to the text. For the keys with letters, pressing the digit will allow you to cycle through the letters on the key. For instance, pressing '2' will display an A. Pressing it again will display a B, and pressing it a third time will display a C. The '0' (zero) key will display a 0. The '1' key functions like a space bar - it puts a space in the current position, and advances to the next position.

- Once the name appears as desired, press the **Continue** soft key.
- The display will change to **New user name is JANE DOE Is this correct?**

At this point you can accept or reject the changes.

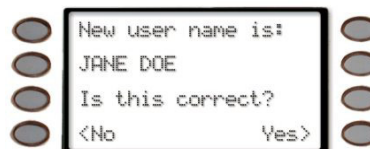

Press the **Yes** soft key to accept the name and return to the main **Add/Change Menu** (depending on panel model).

D9412/D7412:

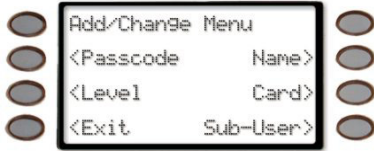

D9112/D7212:

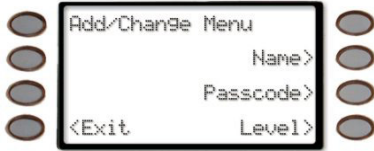

Press the **<No** soft key to reject the name and return to *Step 1*.

Add/Change Card

1. Pressing the **Card>** soft key will allow you to add/change a user's access card or credential.
2. The display changes to either one of the following depending on if an access card exists for the user:
User 123 Add Access Card for this user? - if no access card exists for that user.

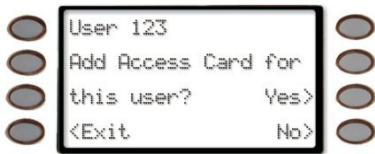

Pressing the **Yes>** soft key will jump to *Step 3*.

Pressing the **No>** soft key will jump to Add/Change Level.

User 123 Change this user's Access Card? -if an access card already exists for this user and you wish to change it. (In both cases, 123 is used as an example)

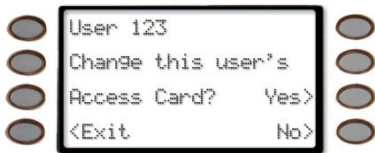

Pressing the **Yes>** soft key will jump to *Step 3*.

Pressing the **No>** soft key will jump to Add/Change Level.

3. If a card reader is connected to your system, the display changes to **Present card to card reader now.**

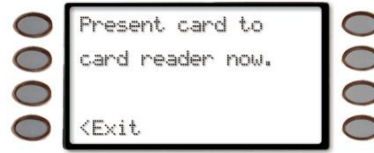

Pressing the **<Exit** soft key exits out of this function and returns the display to idle text.

If the display changes to **D9210 not ready,** **contact your security company.**



Pressing the **<Exit** soft key exits out of this function and returns the display to idle text.

4. If the card you are trying to add to the system already exists, an error tone sounds and the display changes to **Card already exists. Please try again.**



Pressing the **<Exit** soft key exits out of this function and returns the display to idle text.

Then the display returns to **Present card to card reader now.**



Pressing the **<Exit** soft key exits out of this function and returns the display to idle text.

5. If the card is accepted, the display changes to either **Card added.** or **Card changed** if the card already exists in your system.

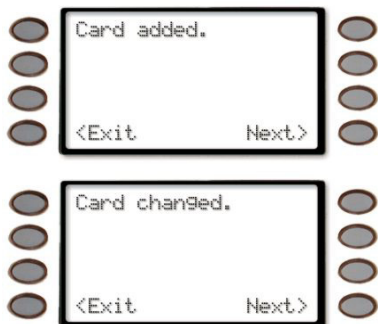

Pressing the **<Exit** soft key exits out of this function and returns the display to idle text.

Pressing the **Next>** soft key exits out of this function and returns the display to either Add/Change Level.

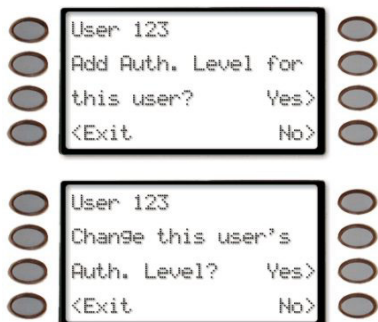

Add/Change Sub-User ID

For each user in the system, there can be up to four access cards; one Master User (assigned in the **Card>** prompt) and up to three sub-users.

- Pressing the **Sub-User>** soft key will allow you to add/change a user's Sub-User access card or credential.
- The display changes to **User 123 Add/Change Sub-User IDs?** to add or change any of this user's sub-user IDs.

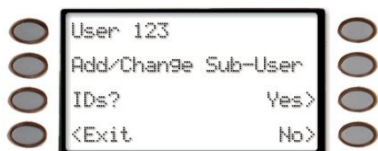

Pressing the **Yes>** soft key will jump to Step 3.

Pressing the **No>** soft key will jump to Add/Change Passcode.

3. The display changes to **Select Sub-User:**

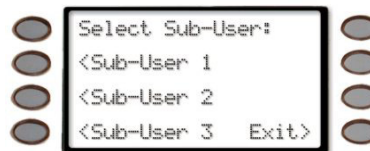

Press the **<Sub-User 1** soft key to add or change sub-user 1.

Press the **<Sub-User 2** soft key to add or change sub-user 2.

Press the **<Sub-User 3** soft key to add or change sub-user 3.

Press the **Exit>** soft key to return to the main **Add / Change User** display.

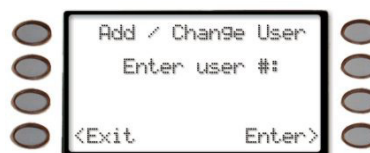

4. If adding or changing a sub-user and a card reader is connected to your system, the display changes to **Add (or Change) Sub-User 1: Present card to card reader now.**

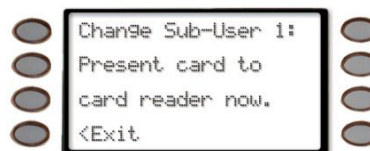
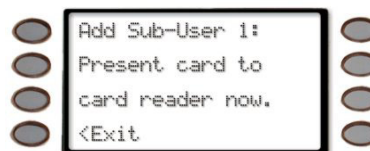

If the display changes to **D9210 not ready**, contact your security company.

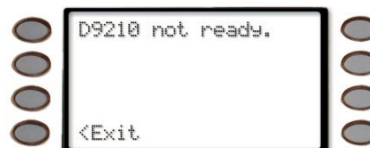

If 20 seconds elapse without pressing a key the display returns to idle text. Pressing the **<Exit** soft key exits out of this function and returns the display to the main **Add / Change User** display.

- If the card you are trying to add to the system already exists, an error tone sounds and the display changes to **Card already exists. Please try again.**



If 20 seconds elapse without pressing a key returns the display to idle text. Pressing the **<Exit** soft key exits out of this function and returns the display to the main **Add / Change User** display.

Then the display returns to **Present card to card reader now.**

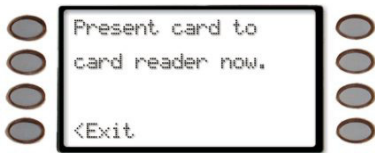

Present the card to the reader to continue or press the **<Exit** soft key to exit out of this function and return the display to idle text.

- If the card is accepted, the display changes to either **Card added.** or **Card changed** if the card already exists in your system.



Pressing the **<Exit** soft key exits out of this function and returns the display to the main **Add / Change User** display.

Pressing the **Next>** soft key exits out of this function and returns the display to Add/Change Passcode depending on if a passcode already exists for the user.

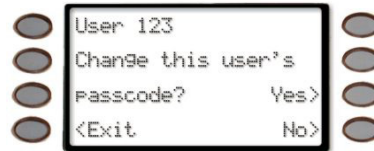
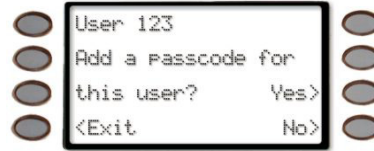

DEFAULT TEXT ? (COMMAND + 5 + 7)

This function allows the current state of the area for 3 seconds before returning to idle text.

- Ensure your keypad shows idle disarmed text.



- Press the **COMMAND** key. The display shows ***System Command***.



- Press the **5** key and then the **7** key.

If you prefer, you may use the Command Menu in place of steps 2 and 3 to initiate this function.

Press the **MENU>** soft key to enter the Command Menu.

Menu> |

Press **NEXT>** soft key repeatedly.

Next> |

When you reach the **DEFAULT TEXT ?>** prompt, press its adjacent soft key.

DEFAULT TEXT ?> |

4. The current state of the area is displayed for 3 seconds before returning to idle text.



FIRE TEST ? (COMMAND + 5 + 8)

Use this function to test fire points and other 24-hour points to be certain they function properly. You can review both the tested and untested points at your command center to help pinpoint any problems.

Upon initiation, the fire test will test the fire bell pattern on the bell output and ring the command center fire bell for 2 seconds. The AC will be disabled for 4 minutes in order to test the system's battery power. If the battery cannot maintain the system for the 4-minute period, the command center will appear to go dead. If this happens, contact your security company. At the end of the 4-minute period, AC is returned to the system and the panel restores. A message will be sent to your security company upon initiation and completion of the Fire Test. **During the Fire Test, no 24-hour alarms will be sent to your security company.**

If there is no activity on the system for 20 minutes, the system will automatically exit from the Fire Test.

Using Fire Test:

1. Ensure your keypad shows idle disarmed text.

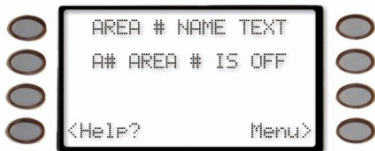

2. Press the **COMMAND** key. The display shows ***System Command***.



3. Press the **5** key and then the **8** key.



If you prefer, you may use the Command Menu in place of steps 2 and 3 to initiate this function.

Press the MENU> soft key to enter the Command Menu.



Press NEXT> soft key repeatedly.



When you reach the FIRE TEST ?> prompt, press its adjacent soft key.



4. When the display shows **### points remain to be tested** you can begin. (### is the number of points).

Test each point by first activating the detection device to fault the point.

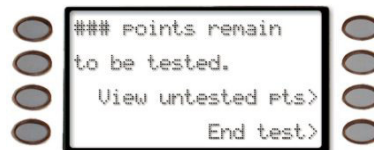

If you know the point number, you can enter it by pressing its number key and then the ENTER key.

The display will change to show the point that was entered. If the point is invalid the message "Invalid Point" or "This is not a valid walk point" appears.

- As you fault each point, your command center will display the point text for 60 seconds and ring the fire sounders for 2 seconds. This verifies that the detection device is working properly. Your system automatically resets smoke detectors.

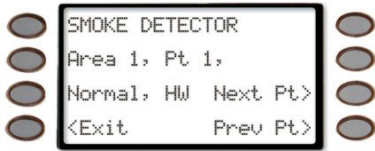

- When a resettable point (such as a smoke detector) is faulted, the display shows **Sensors...resetting...please wait...** for 5 seconds. During this time power is removed from smoke power relays.

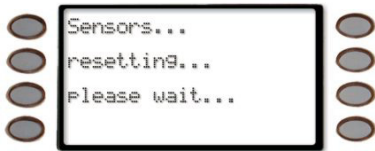

- Faulting a point more than once does not increment the test count. However, the command center emits a brief tone and displays the point text each time you fault the point allowing you to test multiple devices assigned to one point.

- When the point has been tested, the display changes to show **SMOKE DETECTOR tested.**



- During the Fire Test you may want to see the points that remain untested by pressing the **View untested pts>** soft key.

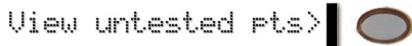

The display shows ### pts untested.

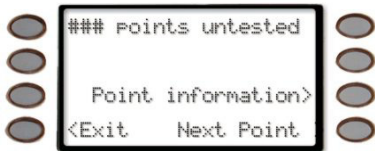

Press the **Point information>** soft key to see information about specific points that have not yet been tested.

The display changes to show the information for that point.

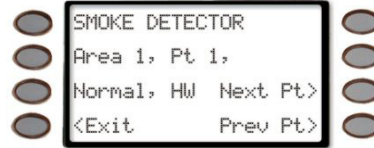

Move through this list by pressing the **Next Point>** soft key.

Press the **<Exit** soft key to return to the **### points remain to be tested.** before continuing the Fire Test.

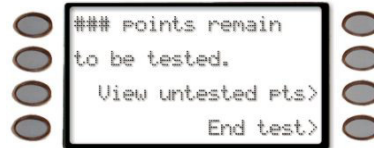

- When all 24-hour points have been tested, **0 points remain to be tested** is displayed.

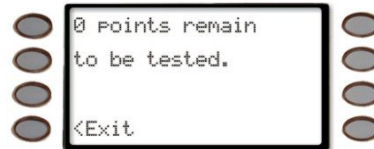

Press the **<Exit** soft key.

The display momentarily shows **All points have been tested.**

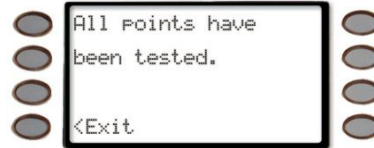

before returning to idle text.



DISPLAY REV ? (COMMAND + 5 + 9)

- Ensure your keypad shows idle disarmed text.



- Press the **COMMAND** key. The display shows **System Command**.



- Press the **5** key and then the **9** key.

If you prefer, you may use the Command Menu in place of steps 2 and 3 to initiate this function.

Press the MENU> soft key to enter the Command Menu.

Menu>

Press NEXT> soft key repeatedly.

Next>

When you reach the DISPLAY REV ?> prompt, press its adjacent soft key.

DISPLAY REV ?>

- The display will change to Radionics D9412* Version 6-40
(D9412 and 6-40 are used as an example, other panels could be D9112, D7412, D7212)



- The display will return to idle text after 5 seconds.



SERVICE MENU ? (9 + 9 + Enter)

The service menu is used to access the following commands:

- View Log** - Use this function to review events in your system at your command center. Reviewing past events may help you identify problems. Viewing events does not require any additional equipment since the information is displayed at your command center. Events are stored in the panel's memory in order of occurrence and tagged with the date and time.
- Print Log** - The Print Log function lets you print the events stored in your security system's log. You can choose to print the entire log or set a start date and print the events recorded from that date up to today. Your system must include a parallel printer interface and a printer to perform this function.
- Display Rev (COMMAND + 5 + 9)** - The command will retrieve the panel's software version and display it.
- Service Walk (D9412/D9112 only)** - The command will allow all the points on the system to be walk tested regardless of the type of point. For D7412 and D7212 panels this function must be added to the keypad's menu. Contact your security company for more information.
- Default Text** - This command will show the current state of the area for 3 seconds before returning to idle text.

- Ensure your keypad shows idle disarmed text.



- Press the **9** key twice.
- Press the **ENTER** key.
- The display changes to show the service menu.

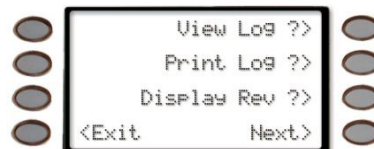

Service Walk Test?> appears on D9412/D9112 Panels only

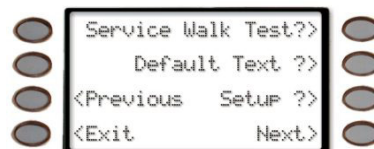

Using View Log

1. Press the **View Log ?>** soft key.

View Log ?> 

2. The display changes to Enter start date:

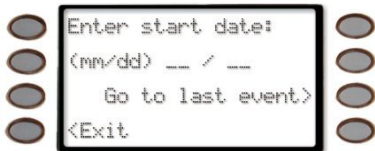

Press the **Go to last event>** soft key to go to the last event in the log.

Press the **<Exit** soft key to exit this function and return to idle text.

3. Enter the start date in the form of mm/dd.

For example, to enter 7/14 as the start date, press **0 + 7 + 1 + 4**

Once you start entering digits, the **Go to last event>** soft key is replaced with the **Enter>** soft key.

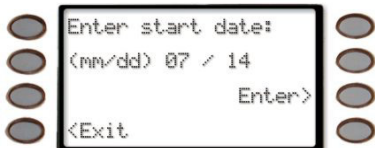

Press the **<Exit** soft key to exit this function and return to idle text.

4. Press either the **Enter>** soft key or the **ENTER** button.
5. If the date entered is valid, the first event for that date will appear.

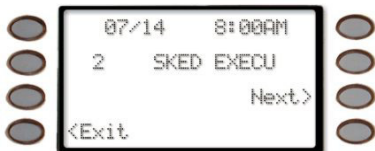

Press the **<Exit** soft key to exit this function and return to idle text.

If the date entered is invalid (there are no events with that date in the log), it will display the next latest event in the log.

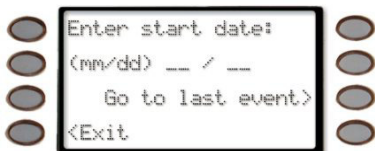

Press the **<Exit** soft key to exit this function and return to idle text.

6. The display will show one of two ways depending on if the date entered was for an event first in the log or not.

- If the date was for the first event in the log, it will display the next latest event in the log.

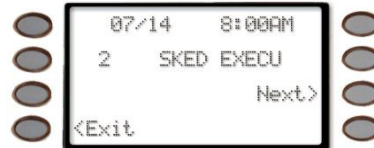

- If the date was for an event (not the first) in the log, the display will be the same except the **<Previous** soft key has been added.

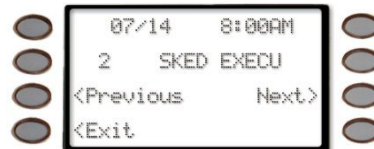

Press the **<Exit** soft key to exit this function and return to idle text.

7. Press the **Next>** soft key to go to the next event in the log.

If there are no more events in the log, ***End of Log*** will appear.

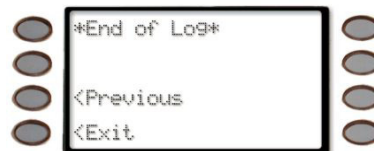

Press the **<Previous** soft key to go to the previous event in the log.

Press the **<Exit** soft key to exit this function and return to idle text.

Using Print Log

1. Press the **Print Log ?>** soft key.

Print Log ?> 

2. The display changes to **Enter start date:**

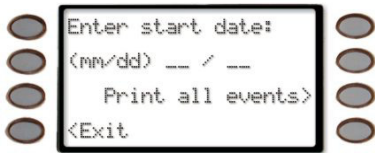

Press the **Print all events>** soft key to print all events in the log.

Press the **<Exit** soft key to exit this function and return to idle text.

The events are sent to a connected printer and display changes to **Printing all events in history** for three seconds before returning to idle text.



3. Enter the start date in the form of mm/dd.

For example, to enter 12/21 as the start date, press **1 + 2 + 2 + 1**.

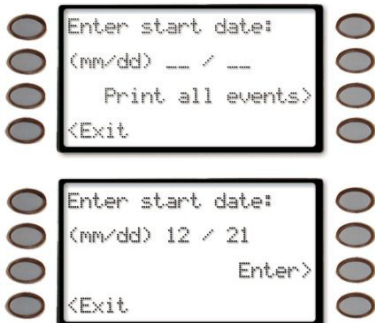

Once you start entering digits, the **Print all events>** soft key is replaced with the **Enter>** soft key.

Press either the **Enter>** soft key or the **ENTER** button.

4. If the date entered is valid, the events for that date will be sent to a connected printer and the display will show **Printing events.** for three seconds, before returning to idle text.



Using Display Rev

1. Press the **Display Rev ?>** soft key.

Display Rev?> 

2. The display will change to ***Bosch D9412* Version 6-40**

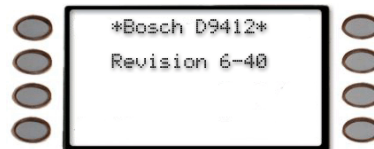

(D9412 and 6-40 are used as an example, other panels could be D9112, D7412, D7212).

3. The display will return to idle text after 5 seconds.



Using Service Walk Test



The Service Walk Test function is only available in the Service Menu for D9412 and D9112 panels. If the panel model is D7412 or D7212, the Service Walk Test will have to be enabled on the Function list for the command center through the panel's programming.

1. When the display shows **### points remain to be tested** you can begin. (### is the number of points).

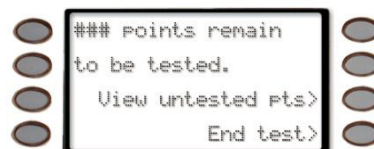



If you know the point number, you can enter it by pressing its number key and then the ENTER key.

The display will change to show the point that was entered. If the point is invalid the message "Invalid Point" or "This is not a valid walk point" appears.

Test each point by first opening and then closing the door or window or other detection device.

Check the display after testing each point. For interior points, walking past the device once is sufficient. If any point does not test correctly, contact your security company for service.

2. During the Walk Test you may want to see the points that remain untested by pressing the **View untested pts**> soft key.

View untested pts>

The display shows **### pts untested**.

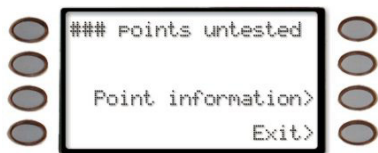

Press the **Point information**> soft key to see information about specific points that have not yet been tested.

The display changes to show the information for that point.

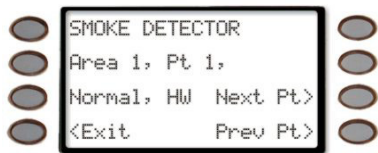

Move through this list by pressing the **Next Point**> soft key.

Press the **<Exit** soft key to return to the **### points remain to be tested**. before continuing the Service Walk Test.

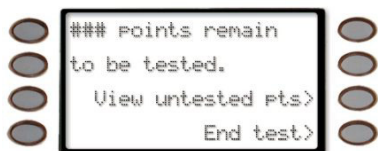

3. When all points have been tested, **0 points remain to be tested** is displayed.

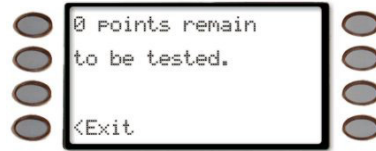

Press the **<Exit** soft key.

The display momentarily shows **All points have been tested**.

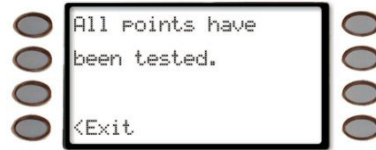

before returning to idle text.



Using Default Text

This function allows the current state of the area for 3 seconds before returning to idle text.

1. Press the **Default Text?>** soft key to display the current state of the area.

Default Text?>

2. The current state of the area is displayed for 3 seconds before returning to idle text.



Using Setup

The Setup function is accessed by pressing the **Setup?>** soft key.

The adjustable functions that are available in this menu are:

- High Brightness,



- Low Brightness,



- Contrast.



Each of these selections have <- **Level** +> soft keys on either side of the display that allows you to increase (+) or decrease (-) the setting being displayed. The High and Low Brightness are associated to Command 49's Bright Display and Dim Display settings.

Also shown in this menu is the Command Center address, whether the Encoding Tone is On or Off,



and the Command Center software revision.



Part IV: Multi-Area Use

Working with Multiple Areas from a Single Command Center

Each of the functions described in the preceding section on Advanced Commands is presented as though your system includes only one area. If your system includes more than one area, it can be set up in one of two ways by the installing company:

- Each command center will only have access to the local area to which it is assigned, or
- Each command center may access either some or all areas beyond the one to which it is assigned. This factor is referred to hereafter as **command center scope**.

If your command center allows access to areas other than the local area (that is to say, has scope in other areas), then the command center will limit your access to those areas within the command center scope and for which your personal passcode has authority.

Given that you have access to areas beyond the local area, the means of accessing the various system functions depends upon the specific function.

For some functions, the command center allows you to select the area (or point) in which to perform the function. These “selectable” functions are:

- DISARM ?,
- MASTER ARM AREA ?.
- BYPASS A POINT? and
- UNBYPASS A POINT?

Another group of functions may automatically work in all areas in which you have passcode authority and which are within the scope of the command center. These are:

- Turning On Multiple Areas with a Passcode,
- Turning Off Multiple Areas with a Passcode,
- DISARM ALL ?,
- MASTER ARM ALL?,
- VIEW MEMORY?,
- WALK TEST?,
- RESET SENSORS ?,
- ADD PASSCODES ?,
- FIRE TEST?,
- VIEW POINT STATUS? and
- VIEW AREA STATUS?

Some functions may be area-specific. To perform these functions, you must first use the MOVE TO AREA ? function (Command 50) to gain access to the desired area. Once in the desired area you can perform the functions you wish. Area-specific functions include:

- PERIMETR INST? (Perimeter On Instant),
- PERIMETR DELAY ? (Perimeter On Delay),
- PERIMETR PART ? (Perimeter On Partial),
- EXTEND CLOSING ?,
- WATCH MODE ?,
- COMMAND 7 ?,
- COMMAND 9 ? and
- CHG DISPLAY ?.

A last group of functions don't relate to specific areas and are thus system-wide. These are:

- SEND REPORT?,
- REMOTE PROG ?,
- CHG TIME/DATE ?,
- CHG SKEDS ?,
- DEL PASSCODES ?,
- CHG RELAYS ?,
- CHG PASSCODES ?,
- PRINT LOG ? and
- VIEW LOG?

View Area Status

Use this function when you need to know the status (whether armed or disarmed) of areas other than the one you're in.

1. Ensure your keypad shows idle disarmed text.



2. Press the **Menu>** key to enter the Command Menu.
3. Press **Next>** repeatedly until you reach the **VIEW AREA STAT ?>** prompt.

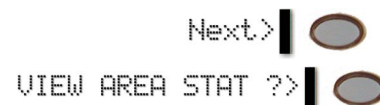

Press the adjacent soft key.

- The display will change to show on the top line the area name and the current status on the second line.

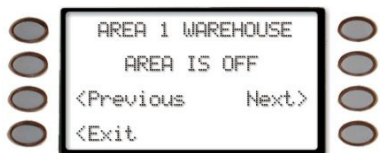

Pressing the **Next**> soft key will change the display to the next area and remain for 20 seconds or until the **Next**> soft key is pressed for the next area. If the time has elapsed, the display returns to idle text.

Pressing the **<Previous** soft key will change the display to the previous area.

- Press the **<Exit** soft key to return to idle text.



View Point Status

Use this function to identify the number or location of each point in an area, and to show the current condition of any point you select.

- Ensure your keypad shows idle disarmed text.



- Press the **Menu**> key to enter the Command Menu.
- Press **Next**> repeatedly until you reach the **VIEW PT STATUS ?>** prompt.



Press the adjacent soft key.

- In this example, Area 1 is the area and there are eight points assigned to area 1 that can be viewed.

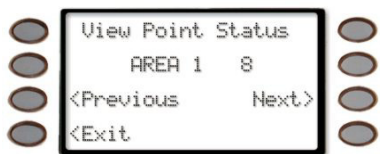

Press the **Next**> soft key to view the first point in the area; press the **<Previous** soft key to view the last point in the area. You may press the **<Exit** soft key at any time to exit this function.

- The top line indicates that you are still in View Point Status mode. The second line will display the point text.

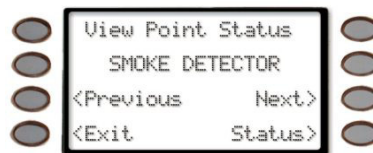

Pressing the **Next**> soft key takes you to the next point in the area whereas the **<Previous** soft key will take you to the previous point in the area.

To view the status of a point, press the **Status**> soft key.

- After pressing the **Status**> key, the command center will display the following information:

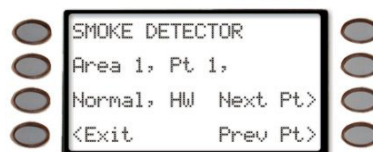

Refer to *Table 5* for more information.

Line #	Area Name	Definition	
1	Area #	This may display numbers 1 to 8.	
	Pt #	This may display point numbers 1 to 127 and 129 to 247,	
2	(Point State), HW	Normal	indicates that the point is not in the faulted state.
		Open	indicates that the point is in an open state.
		Short	indicates that the point is in a shorted state.
		Missing	indicates that the point is missing.

MOVE TO AREA ? (COMMAND + 5 + 0)

With this function you can perform tasks in an area other than the one you're in without having to physically go to that area. Your access to other areas is limited by the scope of the command center and your authority level. For example, if your passcode gives you authority to all 8 areas, but the command center you're working with is limited in scope to areas 1 and 2, then you will only be able to move to either area 1 or area 2.

Upon moving to another area, the range of tasks you may perform depends upon the command center you're working with. Once you've performed a task (such as *Turning the Area On*), the command center reverts back to its programmed area after 10 seconds. Thus only one task can be performed in another area at a time.

1. Ensure your keypad shows idle disarmed text.



2. Press the **COMMAND** key. The display shows ***System Command***.



3. Press the **5** key and then the **0** key.

If you prefer, you may use the Command Menu in place of steps 2 and 3 to initiate this function.

Press the MENU> soft key to enter the Command Menu.

Menu>

Press NEXT> soft key repeatedly.

Next>

When you reach the MOVE TO AREA ?> prompt, press its adjacent soft key.

MOVE TO AREA ?>

4. You may be prompted for your passcode. If so, enter your passcode and press the **ENTER** key. It will appear on the display as asterisks (*).



The **<Exit** soft key will quit this function and return to idle text.

5. The command center will then display the Area Name Text of each area that falls within the scope of the command center and authority level of the user, if applicable. (All 8 area names are shown as an example).

If the user's authority level does not permit access to a certain area and that area is not within the scope of the command center, or the area is not enabled, it will not appear in the display.

If the area you wish to move to does not appear in this list, press the Next> key to display additional areas.



To select an area, simply press the soft key corresponding to the Area Name.

6. **Moving to...AREA 1 WAREHOUSE** displays briefly, and then the text of the area you've moved to is displayed (AREA 1 WAREHOUSE is used as an example here).



- You are now able to perform tasks in this area. The number of areas to which you can move will be limited by the scope of the command center.



If you try to move to an area for which the command center does not have scope, ***NO AUTHORITY*** is displayed.

- When you have completed all tasks in the area you've moved to, simply allow the command center to time-out and revert to the area from which you started or enter the Move to Area function again.

Turning On the System

Turning on Selected Areas

Areas covered in the scope of the command center can be armed individually by accessing the Master Arm function through the menu.

- Press the **Menu>** key to enter the Command Menu.



- Press the **Next>** soft key repeatedly until you reach the **MASTER ARM ?>** prompt then press the adjacent soft key.

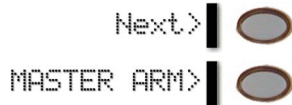

- You will be prompted for your passcode. It will appear on the display as asterisks (*).

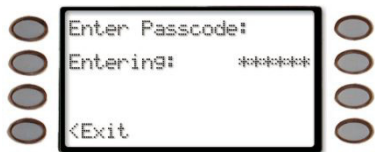

- The display changes and shows **MASTER ARM ALL ?** with the following options:
 - <Previous** soft key – will scroll to the last area that can be armed (based on passcode and authority level)
 - Next>** soft key – will scroll to the first area that can be armed (based on passcode and authority level)
 - Arm>** soft key – will arm all areas (based on passcode and authority level)
 - <Exit** soft key – will return the display to idle text



- If the **Next>** soft key is pressed, the first area that can be armed (based on passcode entered and user authority level) is displayed (**AREA 1 WAREHOUSE** is used an example of the first area that can be armed).



- Pressing the **Arm>** soft key will cause **AREA 1 WAREHOUSE is now arming...** to display for 3 seconds before the prompt to arm the next available area is displayed.

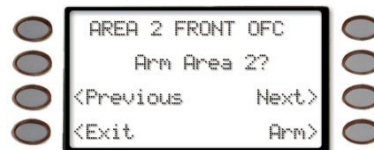

Turning on Multiple Areas with a Passcode

You can use your personal passcode to turn on both perimeter and interior points in all areas where your passcode has authority. If there are areas already turned on, this function turns on all areas that are off without changing the status of the areas that are already on.

1. Enter your passcode and press **ENTER**.



2. The command center will display the following:



Command center scope and/or your authority level limit the actual number of areas you may turn on. For example, if you have authority to arm all 8 areas but the scope of the command center you're using is limited to areas 1, 2, and 5, then you will only be able to turn on areas 1, 2, and 5.

3. If a point is faulted (door or window open for example), see *Turning On the System (Arming) With Doors or Windows Open* for further information.

Faulted Points in Other Areas

If there is a faulted point in an area you select (other than the one you are in), **Check Area 1** (1 is used as an example here) appears for 3 seconds and then the display returns to the area disarmed idle text.



If there is a faulted point in more than one area and the system is being armed, the display will prompt **Check Area 1 3** meaning there are faulted points in Areas 1 and 3.



Try one of the following:

- Clear faulted points (close doors and/or windows) and return to step 1.
- Bypass faulted points (if your system and/or authority allows) and return to step 1.
- Force arm (if your system and/or authority allows). See *Turning On the System (Arming) With Doors or Windows Open* for more information.

Turn On the Entire System Without Delays

You can use this Command Menu function to turn on the entire system, both perimeter and interior, without delays. You may use this function in all of the areas or some of the areas where your passcode has authority. If there are areas already turned on, this function turns on all areas that are off without changing the status of the areas that are already on.

Turning on All or Selected Areas

Areas covered in the scope of the command center can be armed individually by accessing the Master Arm function through the menu.

1. Press the **Menu>** key to enter the Command Menu.



2. Press the **Next>** soft key repeatedly until you reach the **MASTER ARM INST ?>** prompt then press the adjacent soft key.

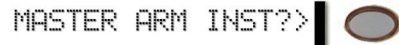

3. You will be prompted for your passcode. It will appear on the display as asterisks (*).

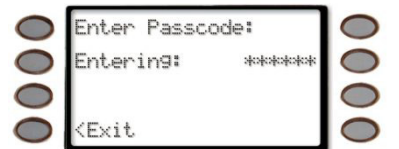

4. The display changes and shows **MASTER ARM ALL ?** with the following options:

- **<Previous** soft key – will scroll to the last area that can be armed (based on passcode and authority level)
- **Next>** soft key – will scroll to the first area that can be armed (based on passcode and authority level)
- **Arm>** soft key – will arm all areas (based on passcode and authority level)
- **<Exit** soft key – will return the display to idle text

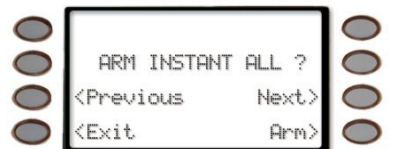

5. If the **Next**> soft key is pressed, the first area that can be armed (based on passcode entered and user authority level) is displayed (**AREA 1 WAREHOUSE** is used an example of the first area that can be armed).

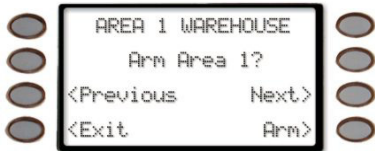

6. Pressing the **Arm**> soft key will cause **AREA 1 WAREHOUSE is now arming...** to display for 3 seconds before the prompt to arm the next available area is displayed.

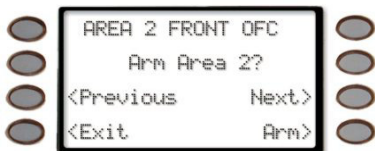

7. Once all available areas have been displayed, the display returns to **ARM INSTANT ALL ?**

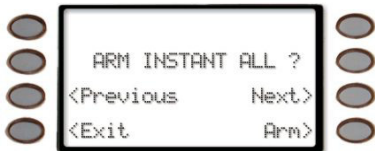

8. To instantly arm all the areas that are within the scope of the command center, press the **Arm**> soft key.
9. This display changes to show **AREA 1 WAREHOUSE All On Instant** indicating that the all areas are armed.

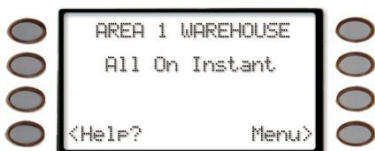

Turning Off the System

Turning Off Multiple Areas with a Passcode

This function is useful for turning off multiple areas with a few keystrokes. It is quicker than disarming several areas independently. Your passcode must have the proper authority level for each area.

- After enter your passcode, the following will display **Disarm: 12345678 All user-authorized areas are now disarmed.** (Not all area number may appear due to what areas are in the scope of the command center.



- When an area is turned on (armed), you must enter a door programmed for entry delay time. Opening the door, starts the entry delay time. Failing to turn off the system before the entry delay time expires or entering through a door not programmed for entry delay time, causes an alarm.
- If this happens, silence the alarm by entering your personal passcode and pressing **ENTER**. Call your security company to let them know that it is not an emergency situation.

Turning Off Multiple Areas with Disarm All

- This function turns off multiple areas with a few keystrokes. It is quicker than disarming several areas independently. Your passcode must have the proper authority level for each area. This function works the same as entering your passcode to disarm, but allows the Disarm All feature to be included in the Command Menu.
 - When an area is turned on (armed), you must enter a door programmed for entry delay time. Opening the door, starts the entry delay time. Failing to turn off the system before the entry delay time expires or entering through a door not programmed for entry delay time, causes an alarm.
 - If this happens, silence the alarm by entering your personal passcode and pressing **ENTER**. Call your security company to let them know that it is not an emergency situation.
- The display initially shows that the system is armed.



- Press the **Menu>** key to enter the Command Menu.



- Press the **Next>** soft key repeatedly until you reach the **DISARM ?>** prompt then press the adjacent soft key.



- If entering through a door which is part of an area that is armed, the display changes to show:

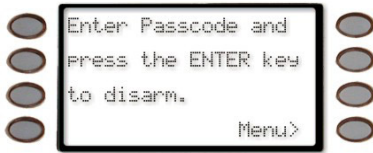

- Enter your passcode and press **ENTER**.
The passcode is shown as asterisks (*) when entered and advance from the right side of the display to the left until all the passcode digits are entered.

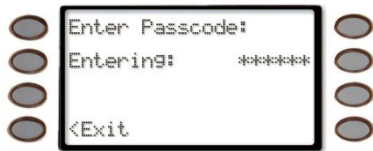

- If the entered passcode is valid, the display changes to show **DISARM ALL?**

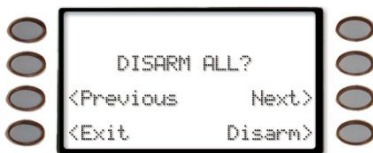

Press the **Disarm>** soft key to disarm all armed areas.
Press the **Next>** soft key to go to the first armed area (see Turning Off Selected Areas).
Press the **<Previous** soft key to go to the last armed area.
Press the **<Exit** soft key to return to idle text.

- If the **Disarm>** soft key is pressed to disarm all areas, the display changes to show **Disarm: 12345678 All user-authorized areas are now disarmed.** indicating that all areas are being turned off. Command center scope and/or your authority level limit the actual number of areas you may turn off.



For example, if you have authority to disarm all 8 areas but the scope of the command center you're using is limited to areas 1, 2, and 5, then you will only be able to turn off areas 1, 2, and 5.

Turning Off Selected Areas

If your passcode has the proper authority level this function allows you to turn off areas other than the one you are in.

- The display initially shows that the system is armed.



- Press the **Menu>** key to enter the Command Menu.



- Press the **Next>** soft key repeatedly until you reach the **DISARM ?>** prompt then press the adjacent soft key.

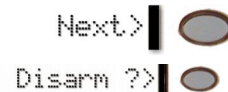

- If entering through a door which is part of an area that is armed, the display changes to show:

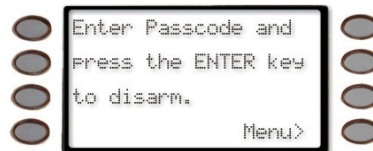

5. Enter your passcode and press **ENTER**.

The passcode is shown as asterisks (*) when entered and advance from the right side of the display to the left until all the passcode digits are entered.



6. If the entered passcode is valid, the display changes to show **DISARM ALL?**

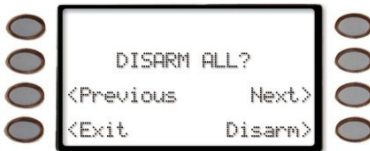

Press the **Disarm>** soft key to disarm all armed areas.

7. Press the **Next>** soft key to go to the first armed area.
8. The display changes to show **DISARM AREA 1 ?** (or the first area that is armed).



Press the **Disarm>** soft key to disarm this area.

Press the **Next>** soft key to scroll through the remaining areas you have the authority to turn off.

To disarm the area, press the **Disarm>** soft key.

9. After turning off other areas, the command center's display returns to the idle text for the area you are in.



Appendix

Supplementary Information for Adding Passcodes

Use the information contained in this Supplement to help you add user passcodes.

User Authority Levels

Your security company uses the information contained on this page to establish authority levels for system users. For each of the 1- 14 authority levels, each command center function is either enabled (E), disabled (blank), or Passcode enabled (P). A function that is enabled (E) is available to all users. A function that is passcode enabled (P) is only available to users assigned an authority level that includes that function. If you do not want a particular command included in a given authority level, leave it blank.

If you are having trouble understanding the concept of authority levels, try this simple exercise. Refer to the column titled E/P on the next page. Notice that your security technician has marked some of the cells in this column with the letter "E", others the letter "P", while others are left blank. An "E" indicates that this function is enabled for all authority levels. A "P" indicates that the function is passcode protected. Look across the same row, and notice that some of the cells in the authority level area have the letter "E". For each authority level in which an "E" appears, this function is enabled (with a passcode required). A blank cell in the E/P column means that this function is unavailable for any authority level.

Under the heading Authority Level, you'll see columns 1-14, representing the fourteen authority levels. Now look at the column labeled 1. Following down this column, you'll see that some cells are blank while some contain the letter "E", which stands for enabled. Wherever there is an "E", it means that that function is available to users with an authority level of 1.

Passcode Worksheet

The passcode worksheet presents the information discussed previously onto one page, and also includes the user's ID number, assigned passcode, and his or her name.

An important piece of information included in the passcode worksheet is the listing of areas to which the user has access, along with the authority level assignment for each of those areas.

User Interface

#	Functions*	Command	E/P	Authority Levels														
				1	2	3	4	5	6	7	8	9	10	11	12	13	14	
1	Disarm ?		P	E	E	E	E	E										
2	Master Arm Delay ?	CMD 1	P	E	E	E	E	E										
3	Master Arm Instant?	CMD 11		E	E													
4	Perimeter Instant ?	CMD 2	P	E	E	E	E											
5	Perimeter Delay ?	CMD 3	P	E	E	E	E											
6	Watch Mode ?	CMD 6	E	E	E	E												
7	Perimeter Part ?	CMD 8	P	E	E	E	E											
8	View Area Status ?		P	E	E													
9	View Memory ?	CMD 40	E	E	E	E												
10	View Pt Status ?		E	E	E	E												
11	Walk Test ?	CMD 44	E	E	E													
12	Fire Test ?	CMD 58	P	E	E													
13	Send Report ?	CMD 41/42	P															
14	◆Door Control ?	CMD 46	P	E	E													
	◆Cycle Door ?		E	E	E													
	◆Unlock Door ?		E	E	E													
	◆Secure Door ?		E	E														
37	◆Access Control Level?		P	E														
15	Change Display ?	CMD 49	E	E														
16	Change Time/Date ?	CMD 45	E	E														
17	Change Passcode ?	CMD 55	P	E														
18	Add User ?	CMD 56	P	E														
19	Del User ?	CMD 53	P	E														
20	Extend Close ?	CMD 51	P															
21	View Log ?		E	E														

				Authority Levels															
22	Print Log ?		P	<i>E</i>															
23	User Command 7 ?	CMD 7	P																
24	User Command 9 ?	CMD 9	P																
25	Bypass a Point ?	CMD 0	P	<i>E</i>	<i>E</i>	<i>E</i>	<i>E</i>												
26	Unbypass a Point ?	CMD 00	P	<i>E</i>	<i>E</i>	<i>E</i>	<i>E</i>												
27	Reset Sensors ?	CMD 47	E	<i>E</i>	<i>E</i>	<i>E</i>	<i>E</i>												
28	Change Relays ?	CMD 54	P	<i>E</i>	<i>E</i>														
29	Remote Program ?	CMD 43	P	<i>E</i>	<i>E</i>	<i>E</i>	<i>E</i>												
30	Move To Area ?	CMD 50	P	<i>E</i>	<i>E</i>														
32	Display Rev ?	CMD 59	E	<i>E</i>															
33	Service Walk ?		P																
34	Default Text ?	CMD 57	P																
35	Change Skeds ?	CMD 52	P	<i>E</i>															

* Command Center Function Authority Level Options: Blank = Disabled, E = Enabled.

◆ D9412G/D7412G only.

Authority Level 15 can not be edited.

User Interface

				Authority Levels													
#	Functions*	Command	E/P	1	2	3	4	5	6	7	8	9	10	11	12	13	14
#	Custom Functions																
128	Custom Function 128		P	<i>E</i>													
129	Custom Function 129		P	<i>E</i>													
130	Custom Function 130		P	<i>E</i>													
131	Custom Function 131		P	<i>E</i>													
132	Custom Function 132		P	<i>E</i>													
133	Custom Function 133		P	<i>E</i>													
134	Custom Function 134		P	<i>E</i>													
135	Custom Function 135		P	<i>E</i>													
136	Custom Function 136		P	<i>E</i>													
137	Custom Function 137		P	<i>E</i>													
138	Custom Function 138		P	<i>E</i>													
139	Custom Function 139		P	<i>E</i>													
140	Custom Function 140		P	<i>E</i>													
141	Custom Function 141		P	<i>E</i>													
142	Custom Function 142		P	<i>E</i>													
143	Custom Function 143		P	<i>E</i>													
◆ Access Levels**																	
	◆ Security Level ?		E	<i>M</i>	<i>M</i>	<i>P</i>	<i>P</i>	<i>P</i>	<i>D</i>								
	◆ Disarm Level ?		E	<i>I</i>	<i>D</i>	<i>D</i>	<i>D</i>	<i>D</i>									

* Command Center Function Authority Level Options: Blank = Disabled, E = Enabled.

Authority Level 15 can not be edited.

◆ D9412G/D7412G only.

** Access Authority Level Options:

Security Level?	M = Any Armed State, P = Perimeter Armed, D = Disarmed, Blank = No Access
Disarm Level?	I = Disarm to Perimeter Instant, D = Disarm All, Blank = No Disarm Rights

User (Passcode) Worksheet (User 000 to 038)

Note: Text shown in Times font (ex. 15) indicates sample text.

User ###	Passcode	User Group	Area Authority								User Name		
			1	2	3	4	5	6	7	8			
000	<i>1 2 3</i> _____		<i>15</i>	<i>15</i>	<i>15</i>	<i>15</i>	<i>15</i>	<i>15</i>	<i>15</i>	<i>15</i>	<i>15</i>	<i>SERVICE</i>	<i>PASSCODE</i>
001	<i>123456</i> _____	_____	<i>1</i>	_____	_____	_____	_____	_____	_____	_____	_____	<i>USER 1</i>	_____
002	_____	_____	_____	_____	_____	_____	_____	_____	_____	_____	_____	<i>USER 2</i>	_____
003	_____	_____	_____	_____	_____	_____	_____	_____	_____	_____	_____	<i>USER 3</i>	_____
004	_____	_____	_____	_____	_____	_____	_____	_____	_____	_____	_____	<i>USER 4</i>	_____
005	_____	_____	_____	_____	_____	_____	_____	_____	_____	_____	_____	<i>USER 5</i>	_____
006	_____	_____	_____	_____	_____	_____	_____	_____	_____	_____	_____	<i>USER 6</i>	_____
007	_____	_____	_____	_____	_____	_____	_____	_____	_____	_____	_____	<i>USER 7</i>	_____
008	_____	_____	_____	_____	_____	_____	_____	_____	_____	_____	_____	<i>USER 8</i>	_____
009	_____	_____	_____	_____	_____	_____	_____	_____	_____	_____	_____	<i>USER 9</i>	_____
010	_____	_____	_____	_____	_____	_____	_____	_____	_____	_____	_____	<i>USER 10</i>	_____
011	_____	_____	_____	_____	_____	_____	_____	_____	_____	_____	_____	<i>USER 11</i>	_____
012	_____	_____	_____	_____	_____	_____	_____	_____	_____	_____	_____	<i>USER 12</i>	_____
013	_____	_____	_____	_____	_____	_____	_____	_____	_____	_____	_____	<i>USER 13</i>	_____
014	_____	_____	_____	_____	_____	_____	_____	_____	_____	_____	_____	<i>USER 14</i>	_____
015	_____	_____	_____	_____	_____	_____	_____	_____	_____	_____	_____	<i>USER 15</i>	_____
016	_____	_____	_____	_____	_____	_____	_____	_____	_____	_____	_____	<i>USER 16</i>	_____
017	_____	_____	_____	_____	_____	_____	_____	_____	_____	_____	_____	<i>USER 17</i>	_____
018	_____	_____	_____	_____	_____	_____	_____	_____	_____	_____	_____	<i>USER 18</i>	_____
019	_____	_____	_____	_____	_____	_____	_____	_____	_____	_____	_____	<i>USER 19</i>	_____
020	_____	_____	_____	_____	_____	_____	_____	_____	_____	_____	_____	<i>USER 20</i>	_____
021	_____	_____	_____	_____	_____	_____	_____	_____	_____	_____	_____	<i>USER 21</i>	_____
022	_____	_____	_____	_____	_____	_____	_____	_____	_____	_____	_____	<i>USER 22</i>	_____
023	_____	_____	_____	_____	_____	_____	_____	_____	_____	_____	_____	<i>USER 23</i>	_____
024	_____	_____	_____	_____	_____	_____	_____	_____	_____	_____	_____	<i>USER 24</i>	_____
025	_____	_____	_____	_____	_____	_____	_____	_____	_____	_____	_____	<i>USER 25</i>	_____
026	_____	_____	_____	_____	_____	_____	_____	_____	_____	_____	_____	<i>USER 26</i>	_____
027	_____	_____	_____	_____	_____	_____	_____	_____	_____	_____	_____	<i>USER 27</i>	_____
028	_____	_____	_____	_____	_____	_____	_____	_____	_____	_____	_____	<i>USER 28</i>	_____
029	_____	_____	_____	_____	_____	_____	_____	_____	_____	_____	_____	<i>USER 29</i>	_____
030	_____	_____	_____	_____	_____	_____	_____	_____	_____	_____	_____	<i>USER 30</i>	_____
031	_____	_____	_____	_____	_____	_____	_____	_____	_____	_____	_____	<i>USER 31</i>	_____
032	_____	_____	_____	_____	_____	_____	_____	_____	_____	_____	_____	<i>USER 32</i>	_____
033	_____	_____	_____	_____	_____	_____	_____	_____	_____	_____	_____	<i>USER 33</i>	_____
034	_____	_____	_____	_____	_____	_____	_____	_____	_____	_____	_____	<i>USER 34</i>	_____
035	_____	_____	_____	_____	_____	_____	_____	_____	_____	_____	_____	<i>USER 35</i>	_____
036	_____	_____	_____	_____	_____	_____	_____	_____	_____	_____	_____	<i>USER 36</i>	_____
037	_____	_____	_____	_____	_____	_____	_____	_____	_____	_____	_____	<i>USER 37</i>	_____
038	_____	_____	_____	_____	_____	_____	_____	_____	_____	_____	_____	<i>USER 38</i>	_____

Product Handler Note: RADXUSR1 is for Users 000 - 124; RADXUSR2 is for Users 125 - 249.

◆ User (Token) Worksheet (User 000 to 038) D9412G/D7412G Only

User #	Master ID ###-0		Sub-User ###-1		Sub-User ###-2		Sub-User ###-3	
	Site	Card Data	Site	Card Data	Site	Card Data	Site	Card Data
000	Not Available							
001								
002								
003								
004								
005								
006								
007								
008								
009								
010								
011								
012								
013								
014								
015								
016								
017								
018								
019								
020								
021								
022								
023								
024								
025								
026								
027								
028								
029								
030								
031								
032								
033								
034								
035								
036								
037								
038								

User (Passcode) Worksheet (User 039 to 075)

User ###	Passcode	User Group	Area Authority								User Name
			1	2	3	4	5	6	7	8	
039	-----	---	-	-	-	-	-	-	-	-	<u>USER 39</u>
040	-----	---	-	-	-	-	-	-	-	-	<u>USER 40</u>
041	-----	---	-	-	-	-	-	-	-	-	<u>USER 41</u>
042	-----	---	-	-	-	-	-	-	-	-	<u>USER 42</u>
043	-----	---	-	-	-	-	-	-	-	-	<u>USER 43</u>
044	-----	---	-	-	-	-	-	-	-	-	<u>USER 44</u>
045	-----	---	-	-	-	-	-	-	-	-	<u>USER 45</u>
046	-----	---	-	-	-	-	-	-	-	-	<u>USER 46</u>
047	-----	---	-	-	-	-	-	-	-	-	<u>USER 47</u>
048	-----	---	-	-	-	-	-	-	-	-	<u>USER 48</u>
049	-----	---	-	-	-	-	-	-	-	-	<u>USER 49</u>
050	-----	---	-	-	-	-	-	-	-	-	<u>USER 50</u>
051	-----	---	-	-	-	-	-	-	-	-	<u>USER 51</u>
052	-----	---	-	-	-	-	-	-	-	-	<u>USER 52</u>
053	-----	---	-	-	-	-	-	-	-	-	<u>USER 53</u>
054	-----	---	-	-	-	-	-	-	-	-	<u>USER 54</u>
055	-----	---	-	-	-	-	-	-	-	-	<u>USER 55</u>
056	-----	---	-	-	-	-	-	-	-	-	<u>USER 56</u>
057	-----	---	-	-	-	-	-	-	-	-	<u>USER 57</u>
058	-----	---	-	-	-	-	-	-	-	-	<u>USER 58</u>
059	-----	---	-	-	-	-	-	-	-	-	<u>USER 59</u>
060	-----	---	-	-	-	-	-	-	-	-	<u>USER 60</u>
061	-----	---	-	-	-	-	-	-	-	-	<u>USER 61</u>
062	-----	---	-	-	-	-	-	-	-	-	<u>USER 62</u>
063	-----	---	-	-	-	-	-	-	-	-	<u>USER 63</u>
064	-----	---	-	-	-	-	-	-	-	-	<u>USER 64</u>
065	-----	---	-	-	-	-	-	-	-	-	<u>USER 65</u>
066	-----	---	-	-	-	-	-	-	-	-	<u>USER 66</u>
067	-----	---	-	-	-	-	-	-	-	-	<u>USER 67</u>
068	-----	---	-	-	-	-	-	-	-	-	<u>USER 68</u>
069	-----	---	-	-	-	-	-	-	-	-	<u>USER 69</u>
070	-----	---	-	-	-	-	-	-	-	-	<u>USER 70</u>
071	-----	---	-	-	-	-	-	-	-	-	<u>USER 71</u>
072	-----	---	-	-	-	-	-	-	-	-	<u>USER 72</u>
073	-----	---	-	-	-	-	-	-	-	-	<u>USER 73</u>
074	-----	---	-	-	-	-	-	-	-	-	<u>USER 74</u>
075	-----	---	-	-	-	-	-	-	-	-	<u>USER 75</u>

◆ User (Token) Worksheet (User 039 to 075) D9412G/D7412G Only

User ###	Master ID ###-0		Sub-User ###-1		Sub-User ###-2		Sub-User ###-3	
	Site	Card Data	Site	Card Data	Site	Card Data	Site	Card Data
039								
040								
041								
042								
043								
044								
045								
046								
047								
048								
049								
050								
051								
052								
053								
054								
055								
056								
057								
058								
059								
060								
061								
062								
063								
064								
065								
066								
067								
068								
069								
070								
071								
072								
073								
074								
075								

User (Passcode) Worksheet (User 076 to 114) (101-249 = D9412G only)

User ###	Passcode	User Group	Area Authority								User Name
			1	2	3	4	5	6	7	8	
076	-----	---	--	--	--	--	--	--	--	--	<u>USER 76</u>
077	-----	---	--	--	--	--	--	--	--	--	<u>USER 77</u>
078	-----	---	--	--	--	--	--	--	--	--	<u>USER 78</u>
079	-----	---	--	--	--	--	--	--	--	--	<u>USER 79</u>
080	-----	---	--	--	--	--	--	--	--	--	<u>USER 80</u>
081	-----	---	--	--	--	--	--	--	--	--	<u>USER 81</u>
082	-----	---	--	--	--	--	--	--	--	--	<u>USER 82</u>
083	-----	---	--	--	--	--	--	--	--	--	<u>USER 83</u>
084	-----	---	--	--	--	--	--	--	--	--	<u>USER 84</u>
085	-----	---	--	--	--	--	--	--	--	--	<u>USER 85</u>
086	-----	---	--	--	--	--	--	--	--	--	<u>USER 86</u>
087	-----	---	--	--	--	--	--	--	--	--	<u>USER 87</u>
088	-----	---	--	--	--	--	--	--	--	--	<u>USER 88</u>
089	-----	---	--	--	--	--	--	--	--	--	<u>USER 89</u>
090	-----	---	--	--	--	--	--	--	--	--	<u>USER 90</u>
091	-----	---	--	--	--	--	--	--	--	--	<u>USER 91</u>
092	-----	---	--	--	--	--	--	--	--	--	<u>USER 92</u>
093	-----	---	--	--	--	--	--	--	--	--	<u>USER 93</u>
094	-----	---	--	--	--	--	--	--	--	--	<u>USER 94</u>
095	-----	---	--	--	--	--	--	--	--	--	<u>USER 95</u>
096	-----	---	--	--	--	--	--	--	--	--	<u>USER 96</u>
097	-----	---	--	--	--	--	--	--	--	--	<u>USER 97</u>
098	-----	---	--	--	--	--	--	--	--	--	<u>USER 98</u>
099	-----	---	--	--	--	--	--	--	--	--	<u>USER 99</u>
100	-----	---	--	--	--	--	--	--	--	--	<u>USER 100</u>
101	-----	---	--	--	--	--	--	--	--	--	<u>USER 101</u>
102	-----	---	--	--	--	--	--	--	--	--	<u>USER 102</u>
103	-----	---	--	--	--	--	--	--	--	--	<u>USER 103</u>
104	-----	---	--	--	--	--	--	--	--	--	<u>USER 104</u>
105	-----	---	--	--	--	--	--	--	--	--	<u>USER 105</u>
106	-----	---	--	--	--	--	--	--	--	--	<u>USER 106</u>
107	-----	---	--	--	--	--	--	--	--	--	<u>USER 107</u>
108	-----	---	--	--	--	--	--	--	--	--	<u>USER 108</u>
109	-----	---	--	--	--	--	--	--	--	--	<u>USER 109</u>
110	-----	---	--	--	--	--	--	--	--	--	<u>USER 110</u>
111	-----	---	--	--	--	--	--	--	--	--	<u>USER 111</u>
112	-----	---	--	--	--	--	--	--	--	--	<u>USER 112</u>
113	-----	---	--	--	--	--	--	--	--	--	<u>USER 113</u>
114	-----	---	--	--	--	--	--	--	--	--	<u>USER 114</u>

◆ User (Token) Worksheet (User 076 to 114) D9412G/D7412G Only (101-249 = D9412G only)

User ###	Master ID ###-0		Sub-User ###-1		Sub-User ###-2		Sub-User ###-3	
	Site	Card Data	Site	Card Data	Site	Card Data	Site	Card Data
076								
077								
078								
079								
080								
081								
082								
083								
084								
085								
086								
087								
088								
089								
090								
091								
092								
093								
094								
095								
096								
097								
098								
099								
100								
101								
102								
103								
104								
105								
106								
107								
108								
109								
110								
111								
112								
113								
114								

User (Passcode) Worksheet (User 115 to 150) (101-249 = D9412G only)

User ###	Passcode	User Group	Area Authority								User Name
			1	2	3	4	5	6	7	8	
115	-----		-	-	-	-	-	-	-	-	<u>USER 115</u>
116	-----		-	-	-	-	-	-	-	-	<u>USER 116</u>
117	-----		-	-	-	-	-	-	-	-	<u>USER 117</u>
118	-----		-	-	-	-	-	-	-	-	<u>USER 118</u>
119	-----		-	-	-	-	-	-	-	-	<u>USER 119</u>
120	-----		-	-	-	-	-	-	-	-	<u>USER 120</u>
121	-----		-	-	-	-	-	-	-	-	<u>USER 121</u>
122	-----		-	-	-	-	-	-	-	-	<u>USER 122</u>
123	-----		-	-	-	-	-	-	-	-	<u>USER 123</u>
124	-----		-	-	-	-	-	-	-	-	<u>USER 124</u>

End RADXUSR1 Handler

125	-----		-	-	-	-	-	-	-	-	<u>USER 125</u>
126	-----		-	-	-	-	-	-	-	-	<u>USER 126</u>
127	-----		-	-	-	-	-	-	-	-	<u>USER 127</u>
128	-----		-	-	-	-	-	-	-	-	<u>USER 128</u>
129	-----		-	-	-	-	-	-	-	-	<u>USER 129</u>
130	-----		-	-	-	-	-	-	-	-	<u>USER 130</u>
131	-----		-	-	-	-	-	-	-	-	<u>USER 131</u>
132	-----		-	-	-	-	-	-	-	-	<u>USER 132</u>
133	-----		-	-	-	-	-	-	-	-	<u>USER 133</u>
134	-----		-	-	-	-	-	-	-	-	<u>USER 134</u>
135	-----		-	-	-	-	-	-	-	-	<u>USER 135</u>
136	-----		-	-	-	-	-	-	-	-	<u>USER 136</u>
137	-----		-	-	-	-	-	-	-	-	<u>USER 137</u>
138	-----		-	-	-	-	-	-	-	-	<u>USER 138</u>
139	-----		-	-	-	-	-	-	-	-	<u>USER 139</u>
140	-----		-	-	-	-	-	-	-	-	<u>USER 140</u>
141	-----		-	-	-	-	-	-	-	-	<u>USER 141</u>
142	-----		-	-	-	-	-	-	-	-	<u>USER 142</u>
143	-----		-	-	-	-	-	-	-	-	<u>USER 143</u>
144	-----		-	-	-	-	-	-	-	-	<u>USER 144</u>
145	-----		-	-	-	-	-	-	-	-	<u>USER 145</u>
146	-----		-	-	-	-	-	-	-	-	<u>USER 146</u>
147	-----		-	-	-	-	-	-	-	-	<u>USER 147</u>
148	-----		-	-	-	-	-	-	-	-	<u>USER 148</u>
149	-----		-	-	-	-	-	-	-	-	<u>USER 149</u>
150	-----		-	-	-	-	-	-	-	-	<u>USER 150</u>

User (Token) Worksheet (User 115 to 150) (101-249 = D9412G only)

User ###	Master ID ###-0		Sub-User ###-1		Sub-User ###-2		Sub-User ###-3	
	Site	Card Data	Site	Card Data	Site	Card Data	Site	Card Data
115								
116								
117								
118								
119								
120								
121								
122								
123								
124								

End RADXUSR1 Handler

125								
126								
127								
128								
129								
130								
131								
132								
133								
134								
135								
136								
137								
138								
139								
140								
141								
142								
143								
144								
145								
146								
147								
148								
149								
150								

User (Passcode) Worksheet (User 151 to 189) (101-249 = D9412G only)

User ###	Passcode	User Group	Area Authority								User Name
			1	2	3	4	5	6	7	8	
151	-----	---	-	-	-	-	-	-	-	-	<u>USER 151</u>
152	-----	---	-	-	-	-	-	-	-	-	<u>USER 152</u>
153	-----	---	-	-	-	-	-	-	-	-	<u>USER 153</u>
154	-----	---	-	-	-	-	-	-	-	-	<u>USER 154</u>
155	-----	---	-	-	-	-	-	-	-	-	<u>USER 155</u>
156	-----	---	-	-	-	-	-	-	-	-	<u>USER 156</u>
157	-----	---	-	-	-	-	-	-	-	-	<u>USER 157</u>
158	-----	---	-	-	-	-	-	-	-	-	<u>USER 158</u>
159	-----	---	-	-	-	-	-	-	-	-	<u>USER 159</u>
160	-----	---	-	-	-	-	-	-	-	-	<u>USER 160</u>
161	-----	---	-	-	-	-	-	-	-	-	<u>USER 161</u>
162	-----	---	-	-	-	-	-	-	-	-	<u>USER 162</u>
163	-----	---	-	-	-	-	-	-	-	-	<u>USER 163</u>
164	-----	---	-	-	-	-	-	-	-	-	<u>USER 164</u>
165	-----	---	-	-	-	-	-	-	-	-	<u>USER 165</u>
166	-----	---	-	-	-	-	-	-	-	-	<u>USER 166</u>
167	-----	---	-	-	-	-	-	-	-	-	<u>USER 167</u>
168	-----	---	-	-	-	-	-	-	-	-	<u>USER 168</u>
169	-----	---	-	-	-	-	-	-	-	-	<u>USER 169</u>
170	-----	---	-	-	-	-	-	-	-	-	<u>USER 170</u>
171	-----	---	-	-	-	-	-	-	-	-	<u>USER 171</u>
172	-----	---	-	-	-	-	-	-	-	-	<u>USER 172</u>
173	-----	---	-	-	-	-	-	-	-	-	<u>USER 173</u>
174	-----	---	-	-	-	-	-	-	-	-	<u>USER 174</u>
175	-----	---	-	-	-	-	-	-	-	-	<u>USER 175</u>
176	-----	---	-	-	-	-	-	-	-	-	<u>USER 176</u>
177	-----	---	-	-	-	-	-	-	-	-	<u>USER 177</u>
178	-----	---	-	-	-	-	-	-	-	-	<u>USER 178</u>
179	-----	---	-	-	-	-	-	-	-	-	<u>USER 179</u>
180	-----	---	-	-	-	-	-	-	-	-	<u>USER 180</u>
181	-----	---	-	-	-	-	-	-	-	-	<u>USER 181</u>
182	-----	---	-	-	-	-	-	-	-	-	<u>USER 182</u>
183	-----	---	-	-	-	-	-	-	-	-	<u>USER 183</u>
184	-----	---	-	-	-	-	-	-	-	-	<u>USER 184</u>
185	-----	---	-	-	-	-	-	-	-	-	<u>USER 185</u>
186	-----	---	-	-	-	-	-	-	-	-	<u>USER 186</u>
187	-----	---	-	-	-	-	-	-	-	-	<u>USER 187</u>
188	-----	---	-	-	-	-	-	-	-	-	<u>USER 188</u>
189	-----	---	-	-	-	-	-	-	-	-	<u>USER 189</u>

User (Token) Worksheet (User 151 to 189) (101-249 = D9412G only)

User ###	Master ID ###-0		Sub-User ###-1		Sub-User ###-2		Sub-User ###-3	
	Site	Card Data	Site	Card Data	Site	Card Data	Site	Card Data
151								
152								
153								
154								
155								
156								
157								
158								
159								
160								
161								
162								
163								
164								
165								
166								
167								
168								
169								
170								
171								
172								
173								
174								
175								
176								
177								
178								
179								
180								
181								
182								
183								
184								
185								
186								
187								
188								
189								

User (Passcode) Worksheet (User 190 to 226) (101-249 = D9412G only)

User ###	Passcode	User Group	Area Authority								User Name
			1	2	3	4	5	6	7	8	
190	-----	---	-	-	-	-	-	-	-	-	<u>USER 190</u>
191	-----	---	-	-	-	-	-	-	-	-	<u>USER 191</u>
192	-----	---	-	-	-	-	-	-	-	-	<u>USER 192</u>
193	-----	---	-	-	-	-	-	-	-	-	<u>USER 193</u>
194	-----	---	-	-	-	-	-	-	-	-	<u>USER 194</u>
195	-----	---	-	-	-	-	-	-	-	-	<u>USER 195</u>
196	-----	---	-	-	-	-	-	-	-	-	<u>USER 196</u>
197	-----	---	-	-	-	-	-	-	-	-	<u>USER 197</u>
198	-----	---	-	-	-	-	-	-	-	-	<u>USER 198</u>
199	-----	---	-	-	-	-	-	-	-	-	<u>USER 199</u>
200	-----	---	-	-	-	-	-	-	-	-	<u>USER 200</u>
201	-----	---	-	-	-	-	-	-	-	-	<u>USER 201</u>
202	-----	---	-	-	-	-	-	-	-	-	<u>USER 202</u>
203	-----	---	-	-	-	-	-	-	-	-	<u>USER 203</u>
204	-----	---	-	-	-	-	-	-	-	-	<u>USER 204</u>
205	-----	---	-	-	-	-	-	-	-	-	<u>USER 205</u>
206	-----	---	-	-	-	-	-	-	-	-	<u>USER 206</u>
207	-----	---	-	-	-	-	-	-	-	-	<u>USER 207</u>
208	-----	---	-	-	-	-	-	-	-	-	<u>USER 208</u>
209	-----	---	-	-	-	-	-	-	-	-	<u>USER 209</u>
210	-----	---	-	-	-	-	-	-	-	-	<u>USER 210</u>
211	-----	---	-	-	-	-	-	-	-	-	<u>USER 211</u>
212	-----	---	-	-	-	-	-	-	-	-	<u>USER 212</u>
213	-----	---	-	-	-	-	-	-	-	-	<u>USER 213</u>
214	-----	---	-	-	-	-	-	-	-	-	<u>USER 214</u>
215	-----	---	-	-	-	-	-	-	-	-	<u>USER 215</u>
216	-----	---	-	-	-	-	-	-	-	-	<u>USER 216</u>
217	-----	---	-	-	-	-	-	-	-	-	<u>USER 217</u>
218	-----	---	-	-	-	-	-	-	-	-	<u>USER 218</u>
219	-----	---	-	-	-	-	-	-	-	-	<u>USER 219</u>
220	-----	---	-	-	-	-	-	-	-	-	<u>USER 220</u>
221	-----	---	-	-	-	-	-	-	-	-	<u>USER 221</u>
222	-----	---	-	-	-	-	-	-	-	-	<u>USER 222</u>
223	-----	---	-	-	-	-	-	-	-	-	<u>USER 223</u>
224	-----	---	-	-	-	-	-	-	-	-	<u>USER 224</u>
225	-----	---	-	-	-	-	-	-	-	-	<u>USER 225</u>
226	-----	---	-	-	-	-	-	-	-	-	<u>USER 226</u>

◆ User (Token) Worksheet (User 190 to 226) D9412G/D7412G Only (101-249 = D9412G only)

User ###	Master ID ###-0		Sub-User ###-1		Sub-User ###-2		Sub-User ###-3	
	Site	Card Data	Site	Card Data	Site	Card Data	Site	Card Data
190								
191								
192								
193								
194								
195								
196								
197								
198								
199								
200								
201								
202								
203								
204								
205								
206								
207								
208								
209								
210								
211								
212								
213								
214								
215								
216								
217								
218								
219								
220								
221								
222								
223								
224								
225								
226								

User (Passcode) Worksheet (User 227 to 249) (101-249 = D9412G only)

User ###	Passcode	User Group	Area Authority								User Name
			1	2	3	4	5	6	7	8	
227	_____	___	—	—	—	—	—	—	—	—	<u>USER 227</u>
228	_____	___	—	—	—	—	—	—	—	—	<u>USER 228</u>
229	_____	___	—	—	—	—	—	—	—	—	<u>USER 229</u>
230	_____	___	—	—	—	—	—	—	—	—	<u>USER 230</u>
231	_____	___	—	—	—	—	—	—	—	—	<u>USER 231</u>
232	_____	___	—	—	—	—	—	—	—	—	<u>USER 232</u>
233	_____	___	—	—	—	—	—	—	—	—	<u>USER 233</u>
234	_____	___	—	—	—	—	—	—	—	—	<u>USER 234</u>
235	_____	___	—	—	—	—	—	—	—	—	<u>USER 235</u>
236	_____	___	—	—	—	—	—	—	—	—	<u>USER 236</u>
237	_____	___	—	—	—	—	—	—	—	—	<u>USER 237</u>
238	_____	___	—	—	—	—	—	—	—	—	<u>USER 238</u>
239	_____	___	—	—	—	—	—	—	—	—	<u>USER 239</u>
240	_____	___	—	—	—	—	—	—	—	—	<u>USER 240</u>
241	_____	___	—	—	—	—	—	—	—	—	<u>USER 241</u>
242	_____	___	—	—	—	—	—	—	—	—	<u>USER 242</u>
243	_____	___	—	—	—	—	—	—	—	—	<u>USER 243</u>
244	_____	___	—	—	—	—	—	—	—	—	<u>USER 244</u>
245	_____	___	—	—	—	—	—	—	—	—	<u>USER 245</u>
246	_____	___	—	—	—	—	—	—	—	—	<u>USER 246</u>
247	_____	___	—	—	—	—	—	—	—	—	<u>USER 247</u>
248	_____	___	—	—	—	—	—	—	—	—	<u>USER 248</u>
249	_____	___	—	—	—	—	—	—	—	—	<u>USER 249</u>

User (Token) Worksheet (User 227 to 249) (101-249 = D9412G only)

User ###	Master ID ###-0		Sub-User ###-1		Sub-User ###-2		Sub-User ###-3	
	Site	Card Data	Site	Card Data	Site	Card Data	Site	Card Data
227								
228								
229								
230								
231								
232								
233								
234								
235								
236								
237								
238								
239								
240								
241								
242								
243								
244								
245								
246								
247								
248								
249								

User (Passcode) Worksheet (Blank)

User ###	Passcode	User Group	Area Authority								User Name	
			1	2	3	4	5	6	7	8		
	-----	---	--	--	--	--	--	--	--	--	USER	---
	-----	---	--	--	--	--	--	--	--	--	USER	---
	-----	---	--	--	--	--	--	--	--	--	USER	---
	-----	---	--	--	--	--	--	--	--	--	USER	---
	-----	---	--	--	--	--	--	--	--	--	USER	---
	-----	---	--	--	--	--	--	--	--	--	USER	---
	-----	---	--	--	--	--	--	--	--	--	USER	---
	-----	---	--	--	--	--	--	--	--	--	USER	---
	-----	---	--	--	--	--	--	--	--	--	USER	---
	-----	---	--	--	--	--	--	--	--	--	USER	---
	-----	---	--	--	--	--	--	--	--	--	USER	---
	-----	---	--	--	--	--	--	--	--	--	USER	---
	-----	---	--	--	--	--	--	--	--	--	USER	---
	-----	---	--	--	--	--	--	--	--	--	USER	---
	-----	---	--	--	--	--	--	--	--	--	USER	---
	-----	---	--	--	--	--	--	--	--	--	USER	---
	-----	---	--	--	--	--	--	--	--	--	USER	---
	-----	---	--	--	--	--	--	--	--	--	USER	---
	-----	---	--	--	--	--	--	--	--	--	USER	---
	-----	---	--	--	--	--	--	--	--	--	USER	---
	-----	---	--	--	--	--	--	--	--	--	USER	---
	-----	---	--	--	--	--	--	--	--	--	USER	---
	-----	---	--	--	--	--	--	--	--	--	USER	---

User (Token) Worksheet (Blank)

User ###	Master ID ###-0		Sub-User ###-1		Sub-User ###-2		Sub-User ###-3	
	Site	Card Data	Site	Card Data	Site	Card Data	Site	Card Data

Security System Limitations

Not even the most advanced security system can guarantee protection against burglary, fire, or environmental threats. All security systems are subject to possible compromise or failure-to-warn for a variety of reasons including, but not limited to, the following:

- If sirens or horns are placed outside the hearing range of people in remote areas of the building or in areas, which are frequently closed off, they do not provide the intended protection.
- If intruders gain access through unprotected points of entry, the system will not detect their entrance.
- If intruders have the technical means of bypassing, jamming, or disconnecting all or part of the system, they will not be detected.
- If the AC power supply is OFF and the back-up battery is either missing or dead, sensors will not detect intrusion.

- Smoke detectors cannot detect smoke in chimneys, walls, or roofs, or smoke blocked by a closed door. They may not detect smoke or fire on a level of the building different from the one on which they are located. Smoke detectors may not be able to warn in time about fires started by explosions, improper storage of flammables, overloaded electrical circuits, or other types of hazardous conditions.
- If phone lines are out of service, reports from the security system to the Security Company cannot be sent unless there is an alternate means of communication. Telephone lines are vulnerable to compromise by several means.

Inadequate maintenance and failure to test are the most common causes of alarm failure. It is strongly recommended that you test your system once a week to be sure that all system components are working properly.

Although having a security system may make you eligible for reduced insurance premiums, the system is no substitute for insurance. Warning devices cannot compensate you for loss of life or property.

Fire Safety and Evacuation

Residential fire is a leading cause of accidental death. Most fire related deaths occur at night when occupants suffocate in their sleep from smoke and toxic gases, rather than from burns. To help reduce this risk, the following program should be implemented.

1. Minimize fire hazards. Smoking in bed, cleaning with flammable liquids such as gasoline, leaving children home alone, and using unsafe holiday decorations are some of the common causes of household fire.
2. Install a fire alarm system. The primary purpose of this system is to protect lives by giving the earliest possible warning of danger.
3. A smoke detector should be provided to protect each sleeping area in a home (Figure 4 and Figure 5).

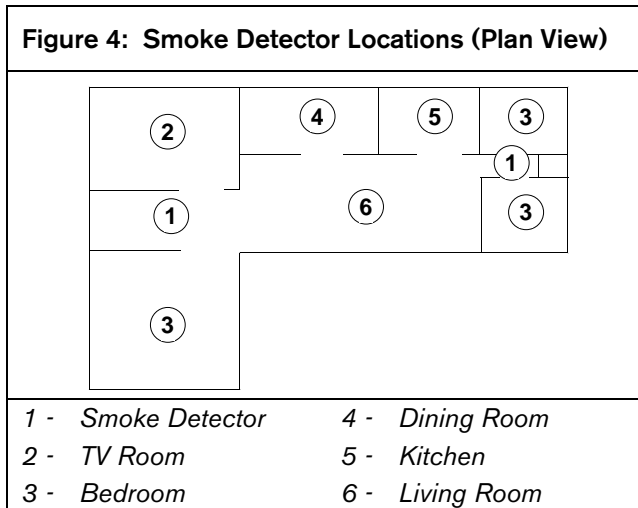
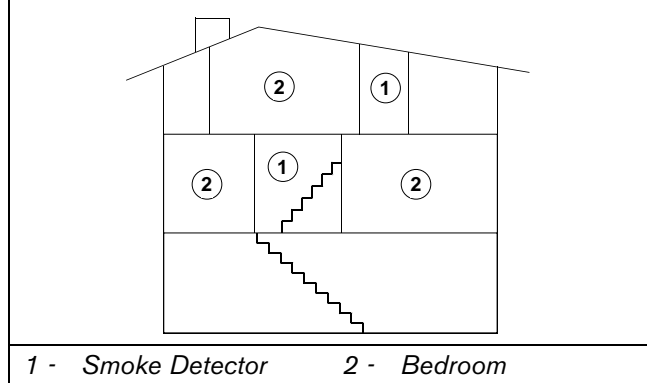
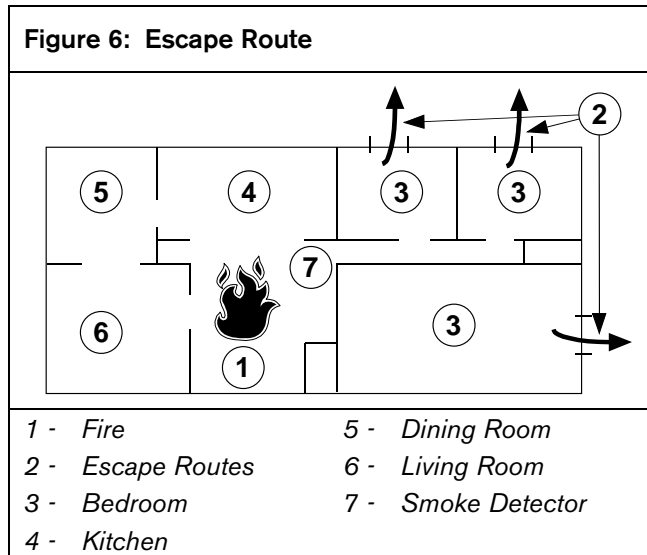

Figure 5: Smoke Detector Locations (Elevation View)



4. Practice an escape plan. Because there may be very little time between detection of a fire and the time it becomes deadly, it is important that every member of the family understand how to quickly evacuate according to the plan.
5. Plan both primary and alternate escape routes. Since stairwells and hallways may be blocked during a fire, exiting through a bedroom window must be a part of the escape plan. If the sleeping area is above the ground floor, install a means of safely descending outside the building if one does not already exist.
6. As a part of this plan, all family members should arrange to meet at a location away from the house (such as a neighbor's house) so you will know that everyone is accounted for.



7. If it is determined that the alarm was accidentally sounded, the bell should be silenced, the detectors reset, and your security company notified immediately that there is no emergency situation.

Standard Displays

Your command center uses standard and custom displays to show the status of the security system. Many standard displays are described below. Your system may not use all of them. Descriptions of your custom text follow.

System Command

Displays when you press the **COMMAND** key. The system is waiting for you to enter a one or two digit number to complete the command.



Enter Passcode to Disarm

When the system is turned on, entering through a delay door starts entry delay time.

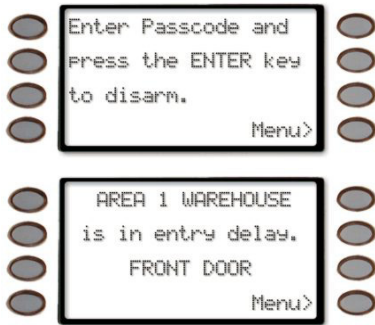

The command center emits a tweedle tone and alternates between **Enter Passcode and press the ENTER key to disarm** and **AREA 1 WAREHOUSE is in entry delay**. (AREA 1 WAREHOUSE is used as an example.)

You must turn off the system before entry delay time expires to avoid creating an alarm event.

Exit Now

Arming your system starts exit delay time. The command center emits a repeating beep tone and displays **AREA 1 WAREHOUSE is now arming** for 3 seconds and then displays **Exit Now!**.



No Authority

The system does not recognize the passcode entered.



Perimeter Delay

Indicates that the perimeter is armed (turned on) with entry/exit delay time. (See *Turning On the System With Delays*)



Perimeter Instant

Indicates that the perimeter is armed (turned on) without entry/exit delay time. (See *Turning On the System Without Delays*).

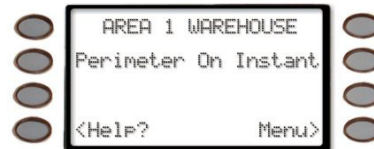

First Disarm – Area must be disarmed first

Indicates that the function requested can only be performed when the area is disarmed. Disarm the area to perform the function.

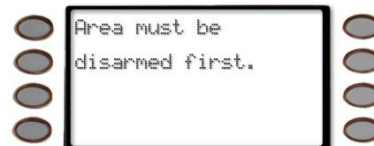

System Trouble Displays

If you see any of the system trouble displays shown below, contact your security company to determine whether repairs are needed.



The Silence> soft key is only displayed if a trouble tone is present. Press the Silence> soft key to silence the following trouble conditions.

Call for Service



Call your security company. Your security system may have failed (Your Security Co. will be replaced with the name of your security company).

Service Panel



Indicates a problem with the panel. The panel is not operating (Your Security Co. will be replaced with the name of your security company). Call your security company for service.

Service Parameter

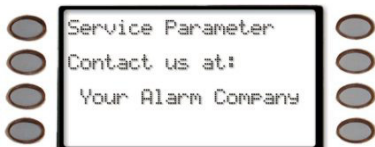

Indicates a problem with the panel. Your panel may not be operating properly (Your Alarm Company will be replaced with the name of your security company). Call your security company for service.

Service Low Battery

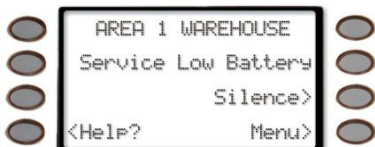

Indicates the security system's battery is low, or temporarily draining faster than the system can charge it. If this display remains or appears frequently, call your security company for service.

Service AC Fail



Indicates that AC power to the security system is interrupted. Check the plug-in transformer and circuit breaker. Entering COMMAND 4 silences the trouble buzz. The display clears when AC power returns.

Service Missing Battery



Indicates the security system's battery is disconnected or shorted.

Service Communication Fail

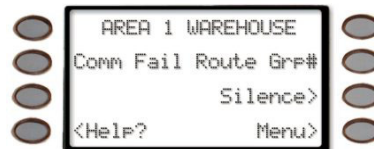

Your security system makes repeated attempts to communicate with the security company.

In the event your security system fails to communicate, the command center buzzes and displays **Comm Fail Route Grp1** (Route Group number can be from 1 to 4)

Notify your security company of the communication trouble.

Service Keypad

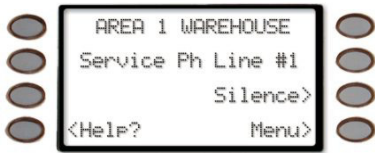

Indicates that a command center, other than the one displaying the message, is in a trouble condition. Notify your security company.

Service Phone Line #1 (or #2)

Indicates telephone line trouble. Call your phone company from another phone to report telephone trouble. This message may not appear in some systems.

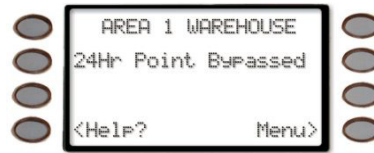
24 Hour Point Bypass

This display indicates that 24-hour points have been bypassed.

Service Printer**Printer number could also be 18 or 19**

Indicates that a local printer (if installed) at your premises is in a trouble condition. Check to be sure the printer is powered on, the paper is correctly inserted, and the printer is selected. Contact your security company if you have questions or the display doesn't clear. Your system may not include a local printer.

Service D9210

Indicates that one of the D9210 Access Control Modules (possible of 8 total) connected to the panel has encountered a problem. Contact your security company.

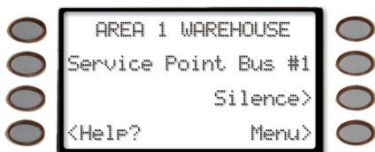
Service Point Bus 1 (or 2)

Displays when a problem has occurred with the panel's Point Bus Wiring. Call your security company.

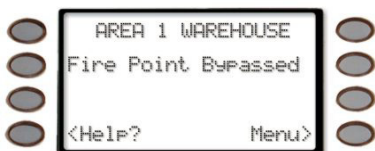
Fire Point Bypass

This display indicates that fire points have been bypassed.

Security System Glossary

Area	A group of detection devices connected to your security system.	Exit Delay	A programmed delay of system alarm response, which allows you to exit after arming an area. If you don't exit before the delay time expires, entry delay begins. You must disarm the system. If you don't disarm before the delay time expires, the system begins an alarm response, which may include reports to the central station.
Arm	To turn on your controlled points (burglar detection devices). When an area is armed and a controlled point trips, an alarm occurs or entry delay begins. When an area is disarmed, faulting controlled points does not generate alarms.	Faulted Point	A point that is not normal (a door or window is open).
Authority Level	Your security company or security representative assigns an authority level to your passcode. The authority level determines what command center functions you can execute.	Force Arm	To turn on (arm) the security system even though one or more points are faulted. Force arming bypasses the faulted points.
Bypass	Selectively remove points from the security system. You might bypass a point in order to arm the perimeter with a window open.	Idle Text	The security system displays idle text at command centers when it is not performing a user-requested function. Idle text shows the arming status of the system.
Central Station	A facility where trained personnel monitor your security system 24 hours a day. Your security system may be programmed to contact the central station during alarm conditions, enabling central station personnel to dispatch the proper authorities.	Master Arm	To turn on (arm) both interior points and perimeter points.
Closing Report	A report your system can be programmed to send to the central station indicating that an area has been armed. Opening and closing reports are commonly used by commercial accounts.	Menu	A list of functions you execute from a command center.
Command Menu	A list of functions programmed by your security company. They can perform most command center functions with only two or three keystrokes.	Opening Report	A report your system can be programmed to send to the central station indicating that an area has been disarmed. Opening and closing reports are commonly used by commercial accounts.
Entry Delay	A programmed delay of system alarm response, which allows you to enter an armed area through the correct point and disarm the area. If you don't disarm before the delay time expires, the system begins an alarm response, which may include reports to the central station.	Perimeter Arm	An arming command that arms only the perimeter points.
		Point	A detection device or group of devices connected to your security system. Points display individually at the command center with custom text. The text can describe a single door, motion sensor, smoke detector, or an area such as UPSTAIRS or GARAGE.
		Relay	Your system may have relays programmed to provide control of devices such as premises lighting or entry gates. Your security company programs relays for automatic control and/or control from your command center.
		Trouble	A service condition that needs to be corrected, such as a broken wire

Maintenance and Service

This security system requires very little maintenance, however, you should test the system weekly to ensure it is working properly. A test schedule and maintenance program can be arranged. If you notice a change in operation during normal use or testing, call for service as soon as possible. Do not attempt to repair the control panel, command centers, or detectors yourself.

How to Clean the Command Center

If your command center gets dirty, apply a household glass cleaner to a clean cloth or paper towel and wipe the surface. Do not spray any liquid directly onto the command center. It could run inside the case and damage electrical circuits.

Your Alarm Company

Name: _____
Call This
Number
Before
Testing _____

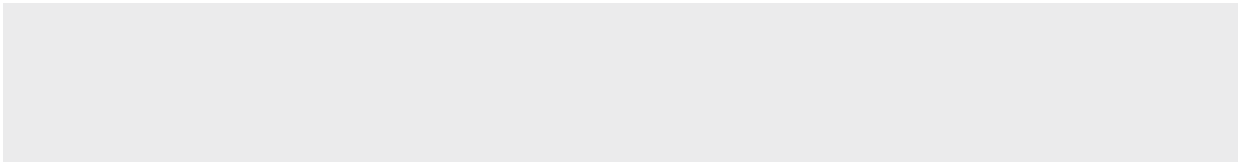

Bosch Security Systems
130 Perinton Parkway
Fairport, NY 14450-9199
Customer Service: (800) 289-0096
Technical Support: (888) 886-6189

© 2004 Bosch Security Systems
50410D

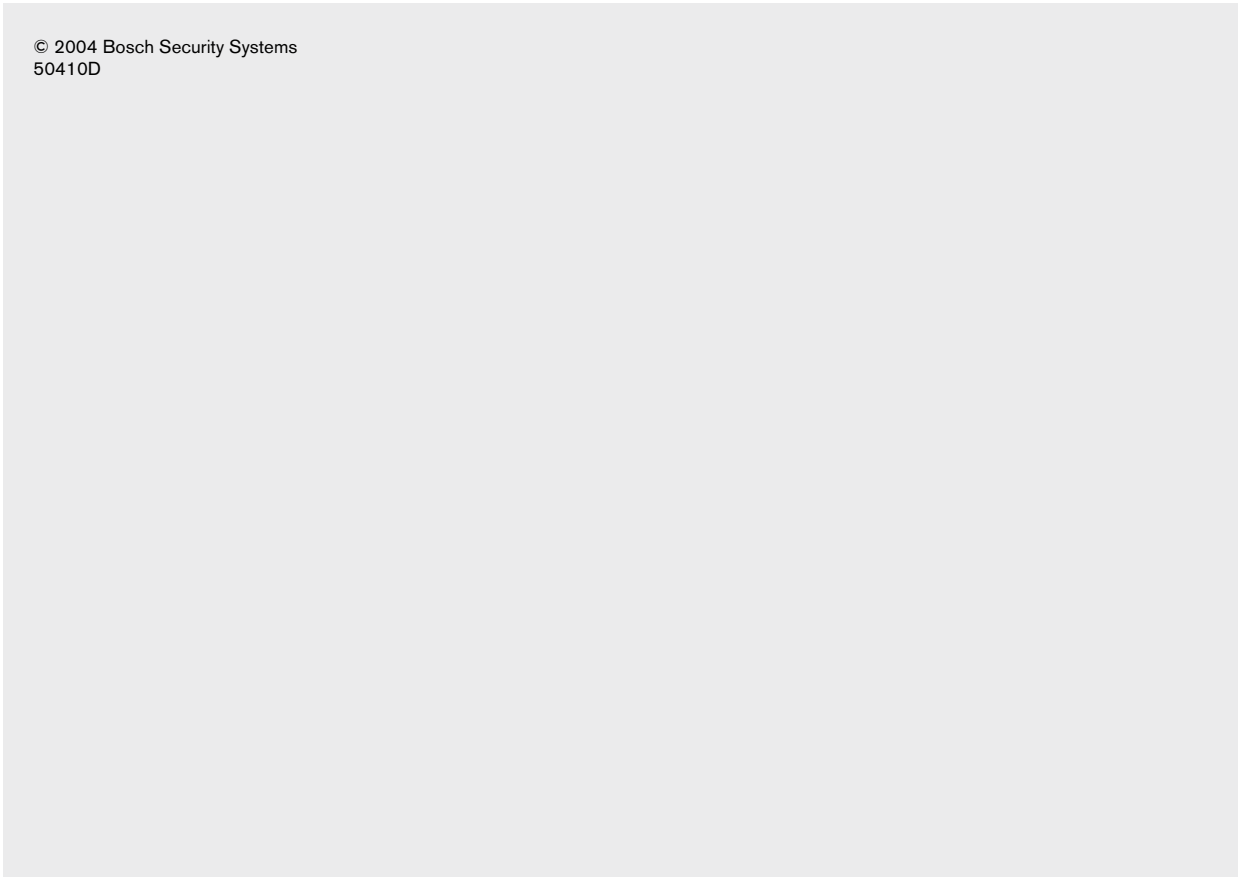

BOSCH

Free Manuals Download Website

<http://myh66.com>

<http://usermanuals.us>

<http://www.somanuals.com>

<http://www.4manuals.cc>

<http://www.manual-lib.com>

<http://www.404manual.com>

<http://www.luxmanual.com>

<http://aubethermostatmanual.com>

Golf course search by state

<http://golfingnear.com>

Email search by domain

<http://emailbydomain.com>

Auto manuals search

<http://auto.somanuals.com>

TV manuals search

<http://tv.somanuals.com>