



**User's Manual**

**BV90F**

**9" WIDESCREEN FLIP-DOWN  
TFT MONITOR**

**FEATURING BUILT-IN INFRARED  
TRANSMITTER**

**BOSS<sup>®</sup>**  
**AUDIO SYSTEMS**

# Content

<b>Caution</b> -----	2
<b>Buttons Instructions</b> -----	3
<b>Remote Control</b> -----	3
<b>TFT Menu Setting</b> -----	4
<b>Connection Diagram</b> -----	5
<b>Instllation</b> -----	6
<b>Specifications</b> -----	7

# Caution

Please read and observe all warnings and instructions in this owner's manual and those marked on the unit . Retain this booklet for future reference.

There are two kinds of caution symbols as follows:



**WARNING**

This symbol is intended to alert the user on the presence of dangerous voltage within the product's enclosure that may cause electric shock to you.



**CAUTION**

The exclamation point within an equilateral triangle is intended to direct attention to the presence of important operating and maintenance (servicing) instructions in the literature accompanying the product.



**WARNING**



Installation of all TV monitors must be out of the driver's field of sight.



Do not mount the product where it will obstruct the deployment of the airbag or in an area where it would affect the vehicular control. Also be careful to avoid mounting the product where it can become hazardous during sudden stops or in the event of an accident.



Do not try and service these products yourself . Seek only a qualified service center or factory service center.



Be careful not to drop or apply under pressure to the front panel of your video monitor. If the screen cracks due to misuse, your warranty will be void!



Use only a damp cloth to clean the screen and use only purified water on the cloth ,wring out all excess water prior to wiping the screen. Do not use any cleaners or chemicals to clean the screen. In most cases a dry cloth will do!



**CAUTION**



Quality installations are best performed by qualified and certified installers.



Watching the monitor for an extended period of time without the engine running may deplete the vehicle's battery, to the point where the engine can no longer be started.



Don't touch the unit if there is lightning as this may cause an electric shock to you.



This product is designed for operation with a 12 Volt DC, negative ground vehicle .It is not suitable for operation under other conditions or voltages.

# Buttons Instructions

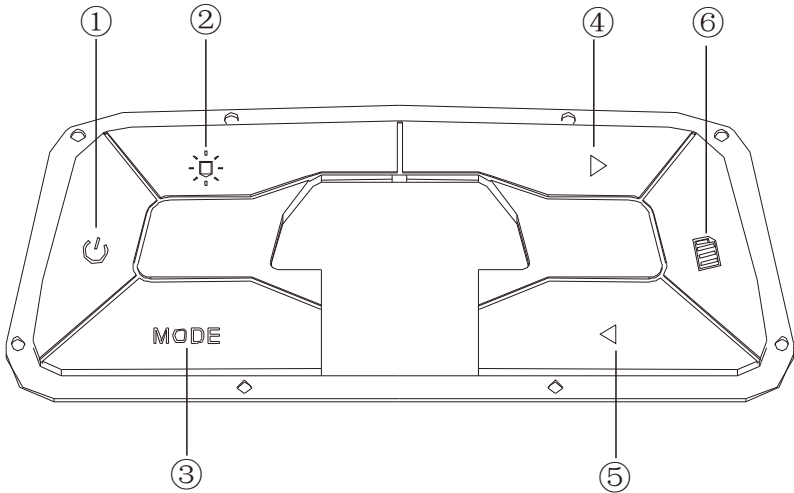

- ① POWER
- ② DOME LIGHT
- ③ V1/V2 INPUT SELECT
- ④ MENU VALUES INCREASE
- ⑤ MENU VALUES DECREASE
- ⑥ MENU

## Remote Control

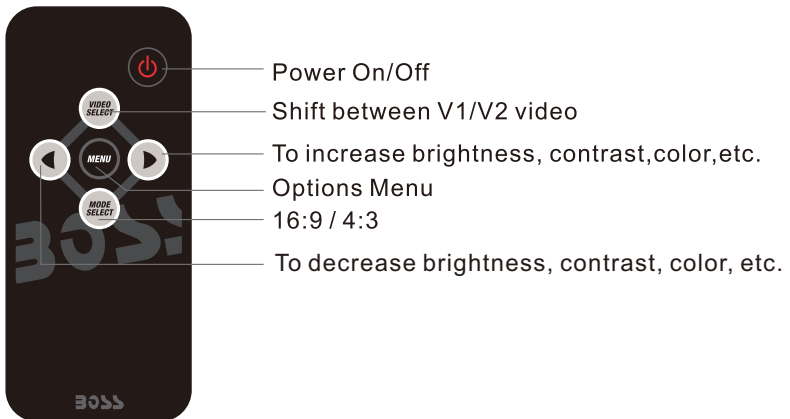

# TFT Menu Setting

## • PICTURE SETTING

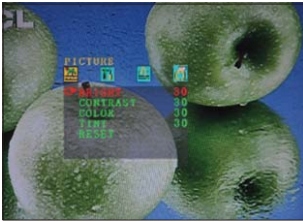

Can adjust **BRIGHT/CONTRAST/COLOR/TINT** Values as per what you desired.

**RESET:** Return to all to factory setting

## • SYSTEM SETTING

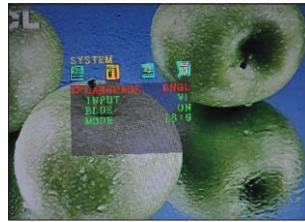

**LANGUAGE:** Can choose menu language what you want

**INPUT:** Video signal input source choose

**BLUE:** Blue screen when no input signal ON/OFF setting

**MODE:** Screen display model (16:9 and 4:3) choose

## • AUDIO



Choose IR channel A or B and OFF

## • CLOCK



Screen Auto turn on/off time setting.

# Connection Diagram

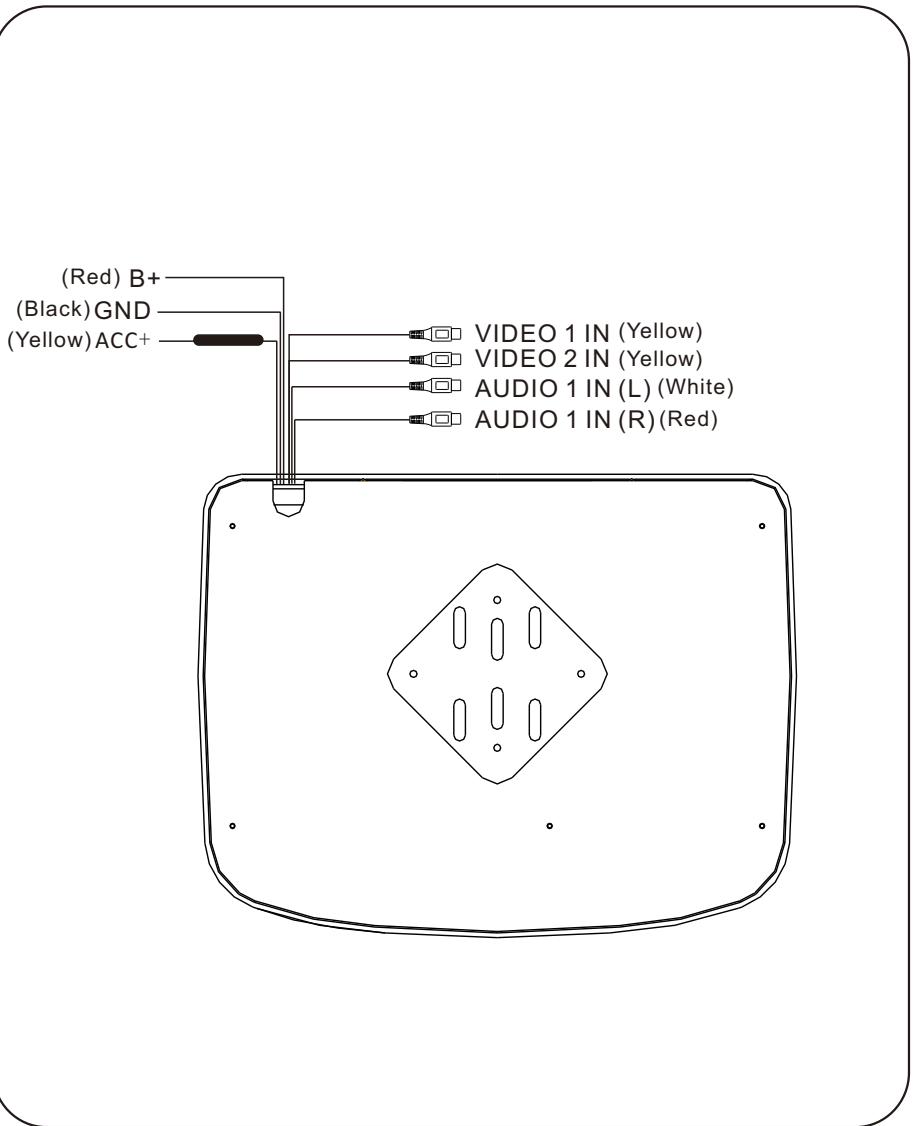

# Installation

1. Open the color box and check the contents.

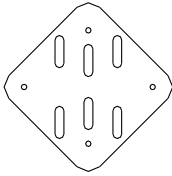

INSTALLATION PLATE

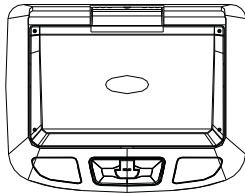

UNIT

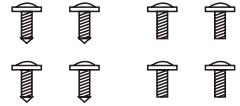

SCREW A

SCREW B

2. Match the position installation bracket and installation plate with screw A.

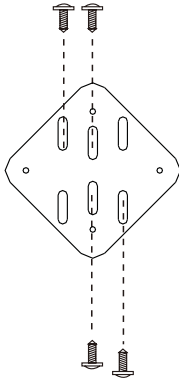

3. Tighten the unit with the screw B.

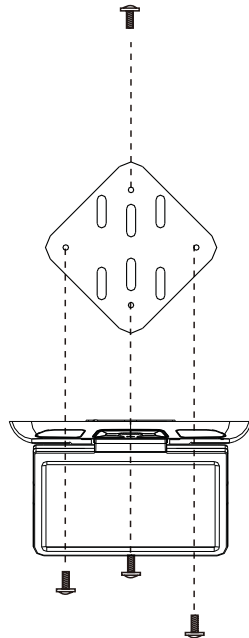

# Specifications

<b>Power</b>	DC 12V
<b>Screen Format</b>	16 : 9
<b>Screen Size</b>	9-inch TFT LCD Panel
<b>Resolution</b>	800(H)*RGB*480(V)
<b>Color System</b>	NTSC / PAL Auto Selection
<b>V Input</b>	2 EA
<b>Dimension</b>	286(w)x221(D)x29(H)mm/ 11.25(W)x 8.7(D)x 1.14(H) in

Note : This equipment has been tested and has been found to comply with the limits for a Class A digital device , pursuant to part 15 of the FCC Rules .These limits are designed to provide reasonable protection against harmful interference when the equipment is operated in a commercial environment .This equipment generates , uses , and can radiate radio frequency energy and , if not installed and used in accordance with the instruction manual , may cause harmful interference to radio communications . Operation of this equipment in a residential area is likely to cause harmful interference in some case the user will be required to correct the interference at his own expense.





## Free Manuals Download Website

<http://myh66.com>

<http://usermanuals.us>

<http://www.somanuals.com>

<http://www.4manuals.cc>

<http://www.manual-lib.com>

<http://www.404manual.com>

<http://www.luxmanual.com>

<http://aubethermostatmanual.com>

Golf course search by state

<http://golfingnear.com>

Email search by domain

<http://emailbydomain.com>

Auto manuals search

<http://auto.somanuals.com>

TV manuals search

<http://tv.somanuals.com>