

SETBACK CONTROL



BRADFORD WHITE[®]
W A T E R H E A T E R S

Ambler, PA 19002
www.bradfordwhite.com
Tech. Service.....(800) 334-3393
Service Parts(800) 538-2020
Warranty Department(800) 531-2111



This manual must be used in conjunction with the Installation and Operation Manual for the water heater.

- Do not store or use gasoline or other flammable vapors and liquids in the vicinity of the water heater or any other appliance.
- What to do if you smell gas:
 - Do not try to light any appliance.
 - Do not touch any electrical switch; do not use any phone in your building.
 - Immediately call your gas supplier from a neighbor phone. Follow the gas supplier instructions.
 - If you cannot reach your gas supplier, call the fire department.
- For your family comfort, safety and convenience, it is recommended this Setback Control be installed and serviced by a plumbing professional.

INSTALLATION & OPERATION MANUAL With Troubleshooting Guide

PLACE THESE INSTRUCTIONS ADJACENT TO WATER HEATER AND NOTIFY OWNER TO KEEP FOR FUTURE REFERENCE

238-47808-00A 7/09

Important Information

CONGRATULATIONS!

You have just purchased one of the finest water heater accessories on the market today!

This Installation and Operation Manual will explain in detail how to install and operate your new Setback Control. We strongly recommend you contact a plumbing professional for the installation of this new control.

We require that you carefully read this manual and the manual supplied with the water heater when questions arise. If you have any specific questions concerning your warranty, please consult the plumbing professional from whom your Setback Control was purchased. For your records, we recommend that you write the installation date for this control in the back of this manual.

This manual should be kept with the Setback Control.

Water Heater Setback Control:

This Setback Control works with the water heater gas control. It has the capability to adjust the setpoint of the water heater during periods where little or no hot water is required for use. The Setback Control adjusts the setpoint of a water heater similarly to the way a programmable thermostat does for a furnace.

Setback Control Features:

- 7 day / 4 period programming
- Conserves energy
- Hot water capacity indicator (provides an estimate of available hot water)
- Battery back-up stores programming during a power outage
- Can be programmed to comply with Sabbath requirements
- Similar interface to furnace / air conditioning thermostats
- Precision control of water temperature

READ CAREFULLY

The following terms are used throughout this manual to bring attention to the presence of hazards at various risk levels, or to important information concerning product life.

 **DANGER**

Indicates an imminently hazardous situation, which, if not avoided, will result in death, serious injury or substantial property damage.

 **CAUTION**

Indicates potentially hazardous situation, which, if not avoided, may result in moderate or minor injury or property damage.

 **WARNING**

Indicates a potentially hazardous situation, which, if not avoided, could result in death, serious injury or substantial property damage.

NOTICE

Indicates special instructions on installation, operation or maintenance, which are important but not related to personal injury hazards.

NOTICE

This water heater is equipped with an energy cut out device to prevent overheating. Should overheating occur or the gas supply fails to shut off, turn off the manual gas control valve to the water heater and call a qualified service technician.

Whenever the water heater is filled with cold water, condensate will form on the cool tank surface and drops of water will fall on the hot burner and combustion chamber surfaces producing a “sizzling” noise. Condensation is normal and does not indicate a leak. It will disappear when the tank becomes heated.

 **DANGER**

Hotter water increases the risk of scald injury. Scalding may occur within five (5) seconds at a temperature setting of 140°F (60°C). To protect against hot water injury, install an ASSE approved mixing valve in the water system. This valve will reduce point of discharge temperature by mixing cold and hot water in branch water lines. A licensed plumbing professional or local plumbing authority should be consulted.

NOTICE

The lower the temperature setting, the greater the energy efficiency, both to heat the water and to maintain the storage temperature during standby periods. Lower water temperatures also extend tank life. Remember, no water heating system will provide exact temperatures at all times. Allow a few days of operation at this setting to determine the correct temperature setting consistent with the requirements for the installation.

Important Information

	<p>Water temperature over 125°F can cause severe burns instantly or death from scalds.</p> <p>Children, disabled and elderly are at highest risk of being scalded.</p> <p>Review this instruction manual before setting temperature at water heater.</p> <p>Feel water before bathing or showering.</p> <p>Temperature limiting valves are available.</p>
---	---

⚠ CAUTION

This water heater, when set at a lower temperature setting, is not capable of producing hot water of sufficient temperature for sanitizing purposes.

⚠ WARNING

Do not operate the water heater or Setback Control without the Setback Control Junction Box Assembly cover in place.

Do not operate water heater and Setback Control with jumpered or absent controls or safety devices.

Turn off or disconnect the electrical power supply to the water heater and Setback Control before servicing. Label all wires prior to disconnection when servicing controls. Wiring errors can cause improper and dangerous operation. Verify proper operation after servicing.

All electrical wiring must be installed and grounded in accordance with local codes, or in the absence of local codes, the National Electrical Code, ANSI/NFPA 70 and/or CSA C22. Electrical Code.

For energy efficient operation of your water heater, the suggested initial water temperature setting is 120°F (49°C). During the winter season, or any cold period, you may desire a higher water temperature setting to adjust for the colder incoming water. This adjustment, however, may cause additional condensation to form on the cooler tank surface. This does not mean the tank is leaking. During summer months, the warmer incoming water temperatures will benefit the performance of your water heater and reduce the amount of condensation developed.

Condensation does not mean your tank is leaking. Over 40% of reported tank leaks on installation are proven to be condensation. To avoid unnecessary expense and inconvenience, make sure the tank is leaking before calling a service technician.

As was stated previously, the recommended water temperature during periods when hot water is required is 120°F (49°C). During setback periods, the recommended water temperature is 85°F (29°C). If it is possible that hot water will be needed during the Leave and/or Sleep periods, set the Setback to 105°F (41°C). This control may be used for the Sabbath. Please consult your local rabbi for recommended water temperatures and appropriate times for the Sabbath.

Initially, the Setback Control will default all water temperatures to the setpoint on the water heater gas control.

	Page
Installing the Setback Control.....	6
Remote Mounting the Setback Control.....	9
Changing the Batteries.....	21
Overview of Control Display and Buttons.....	24
Display Key	25
Display Features	25
Reference Time / Water Temperature Table.....	26
The Start-up Procedure	27
Setting the Setback Control Schedule – Initial Set-up.....	31
Editing the Setback Schedule	40
Setting a Temporary Temperature Hold.....	50
Setting a Permanent Temperature Hold.....	51
Editing the Clock / Day	52
Sabbath Time Period Editing.....	55
Diagnostic Codes	65

Installing the Setback Control

This section covers the installation of the Setback Control to the Setback Control Junction Box Assembly, which is mounted to the water heater. The Setback Control Junction Box Assembly was already factory installed or installed as part of the Performance Package.

Unplug the Water Heater and Setback Control

Step 1: Unplug the water heater and Setback Control. This is shown in Figure 1.

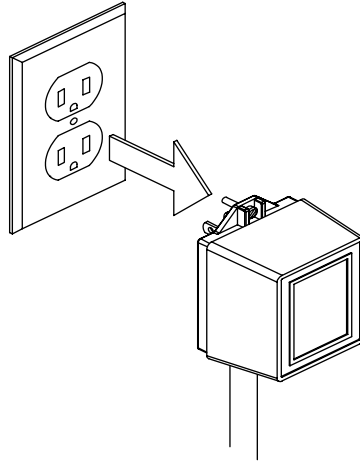

Figure 1

Inspection of Setback Control

Step 2: Remove the Setback Control from its packaging, and inspect it for any damage that occurred during shipping. This is shown in Figure 2.

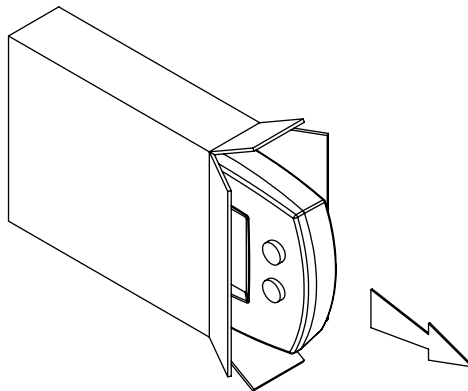

Figure 2

Installing the Setback Control

Removal of Setback Control Protective Plate

Step 3: Remove the Setback Control Protective Plate from the Setback Control by pulling these components in opposite directions, as shown in Figure 3. Retain the protective plate if the Setback Control will be remote mounted.

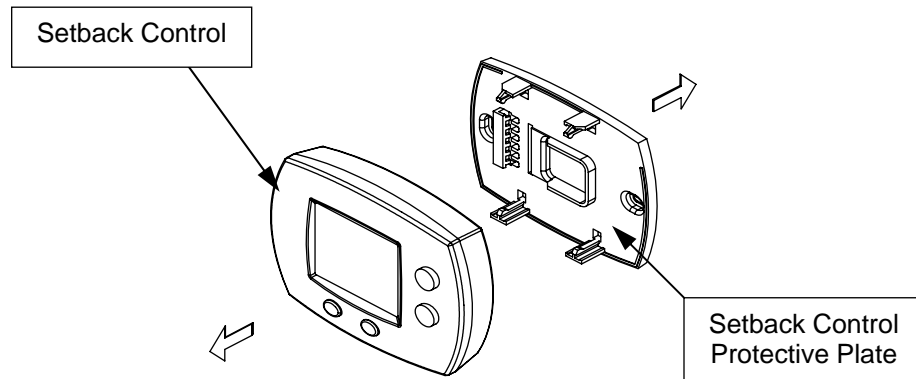

Figure 3

Install Batteries

Step 4: Remove the battery holder from the Setback Control, and install (2) AAA batteries. Replace the battery holder after the batteries are installed. This is shown in Figure 4.

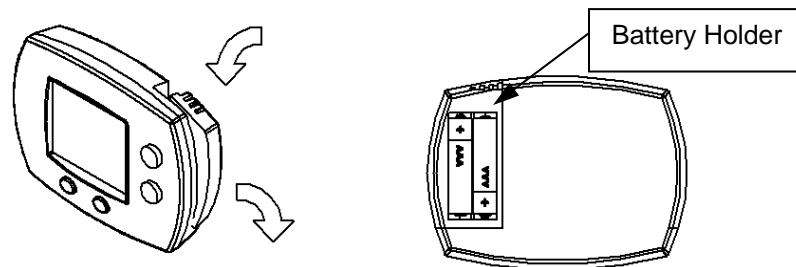
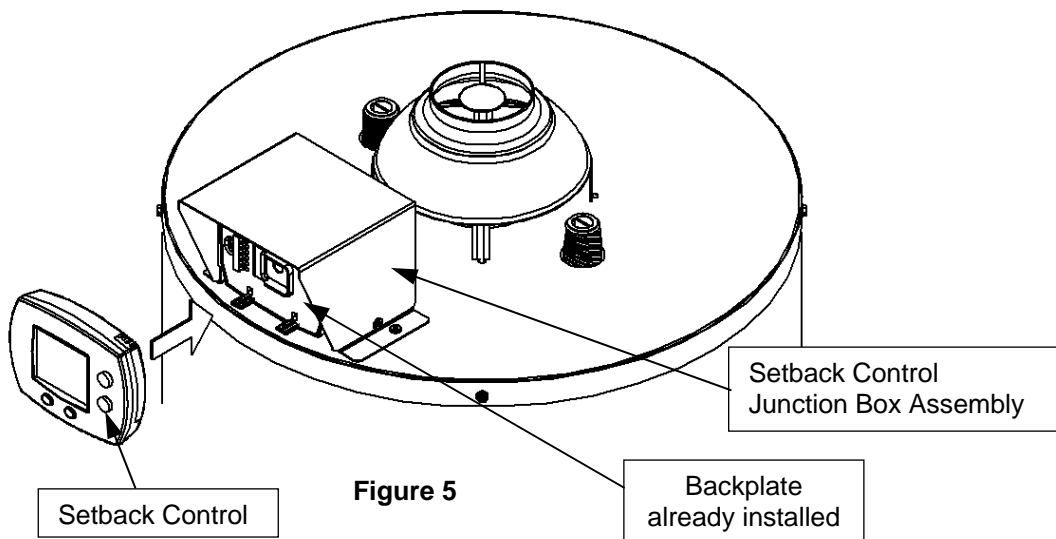

Figure 4

Installing the Setback Control

Installing Setback Control

Step 5: Using the Setback Control Junction Box Assembly (already installed on water heater), snap the Setback Control into the backplate connected to the Setback Control Junction Box Assembly, as shown in Figure 5.



Powering the Water Heater and Setback Control

Step 6: Plug in the water heater and the transformer to power the Setback Control. This is shown in Figure 6.

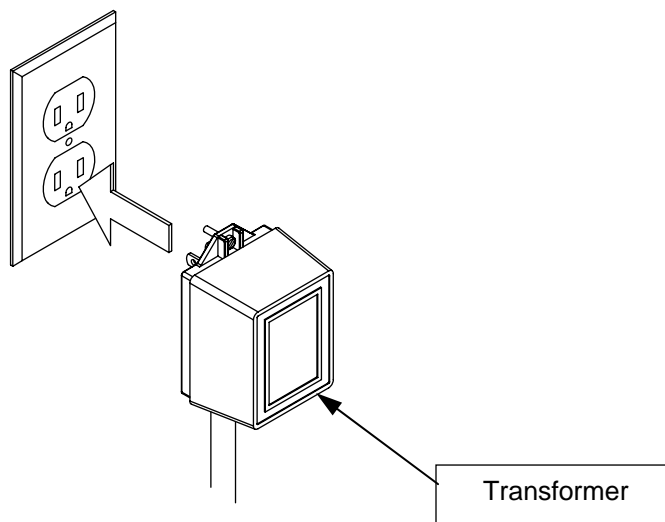

Figure 6

Remote Mounting the Setback Control

In the following section, the instructions detail how to Remote Mount the Setback Control.

Unplug the Water Heater and Setback Control

Step 1: Unplug the water heater and Setback Control. This is shown in Figure 7.

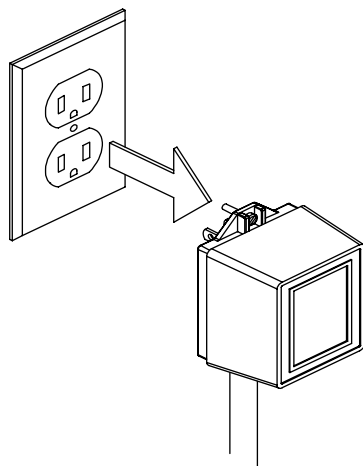

Figure 7

Remove the Setback Control from the Backplate

Step 2: Remove the Setback Control from the backplate attached to the Setback Control Junction Box Assembly. Some force may be required. This is shown in Figure 8.

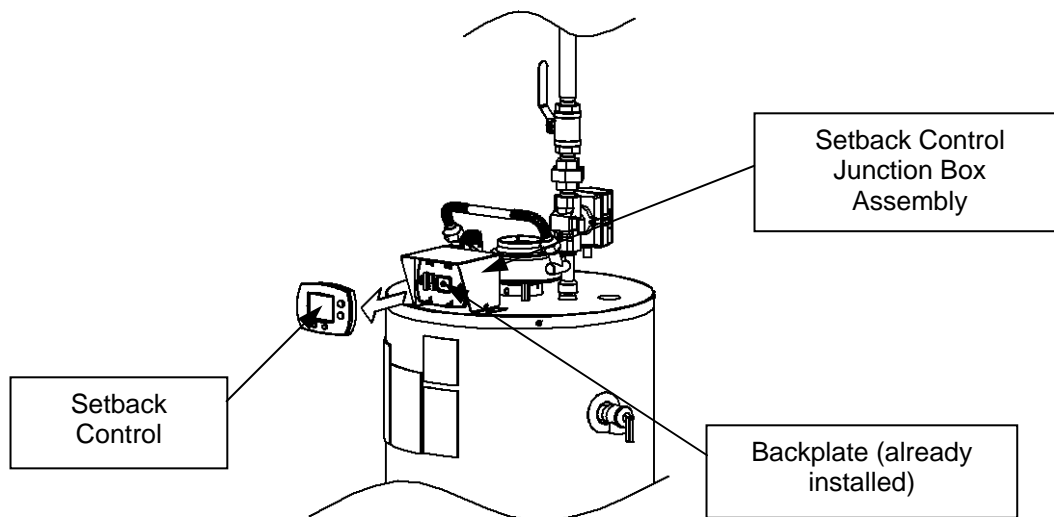

Figure 8

Remote Mounting the Setback Control

Prepare the Backplate for Wiring

Step 3: Loosen the (3) slotted screws on the backplate attached to the Setback Control Junction Box Assembly. This is shown in Figure 9.

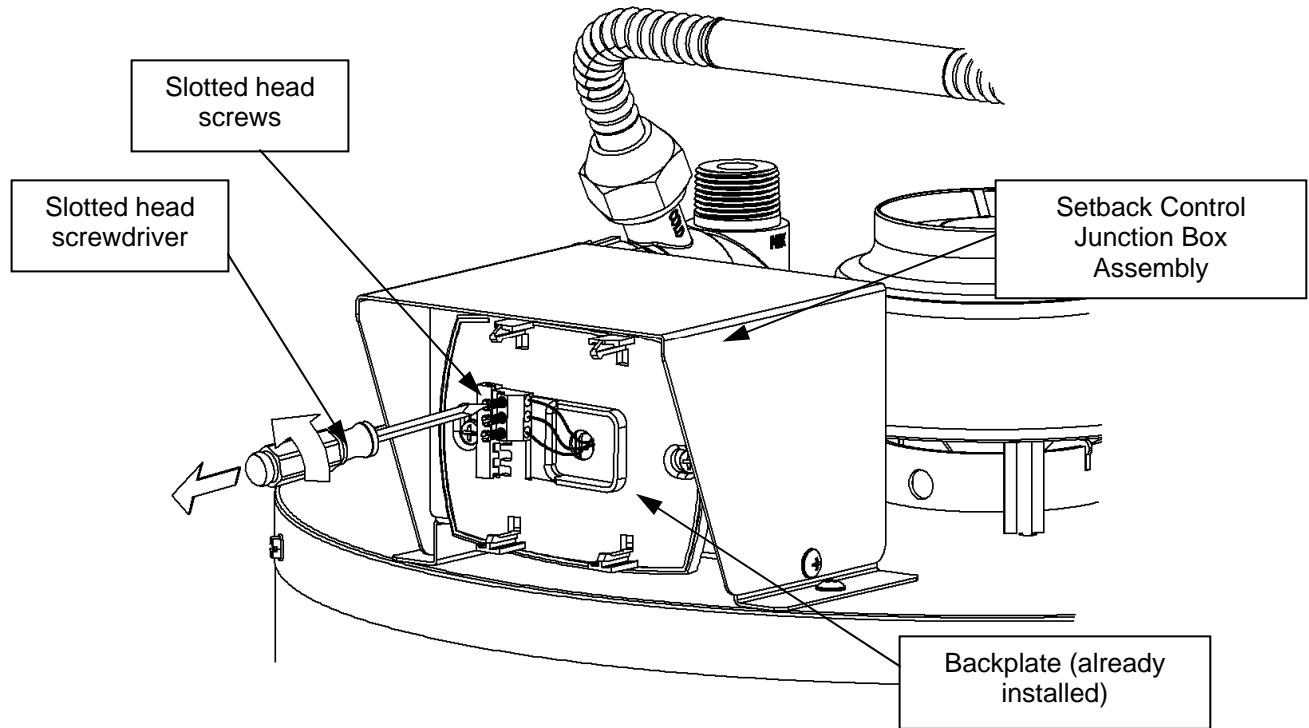

Figure 9

Mount the Protective Plate

Step 4: Mount the Setback Control Protective Plate in a desired location. Be sure that the Setback Control will not be direct sunlight, as the display may be difficult to read. This is shown in Figure 10.

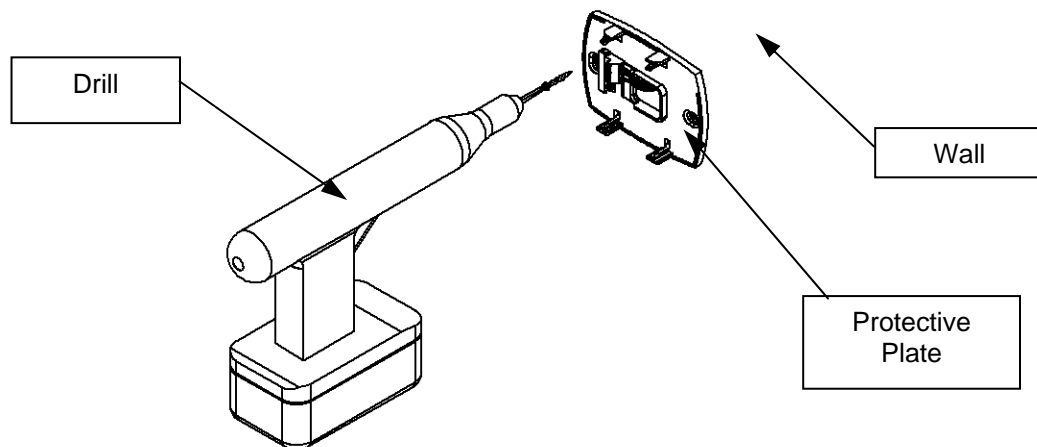

Figure 10

Remote Mounting the Setback Control

Measure Wire for Remote Mounting

Step 5: Measure and cut (3) pieces of 18 AWG wire to a sufficient length to reach from the backplate on the Setback Control Junction Box Assembly to the Setback Control Protective Plate. This is shown in Figure 11.

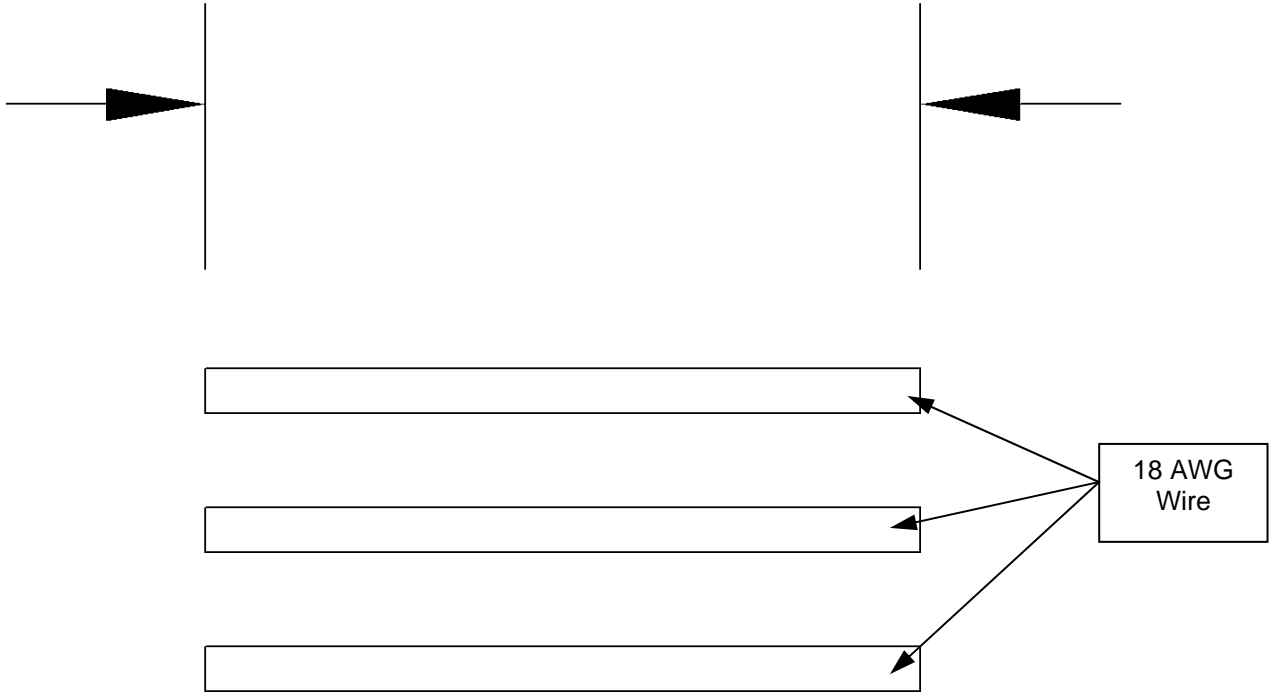

Figure 11

Label the Wires for Remote Mounting

Step 6: Label the (3) cut wires (A), (B), and (C) respectively. Label both ends of the wires. This is shown in Figure 12. Masking tape can be used to label the wires.

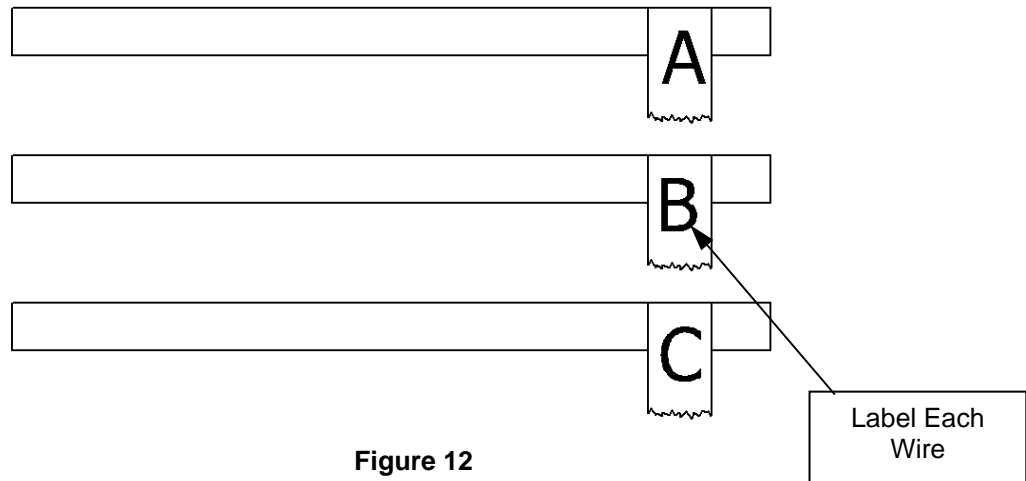

Figure 12

Remote Mounting the Setback Control

Prepare the Wires for Installation

Step 7: Strip approximately $\frac{1}{4}$ " of the wire's insulation from each end of the three wires. This is shown in Figure 13.

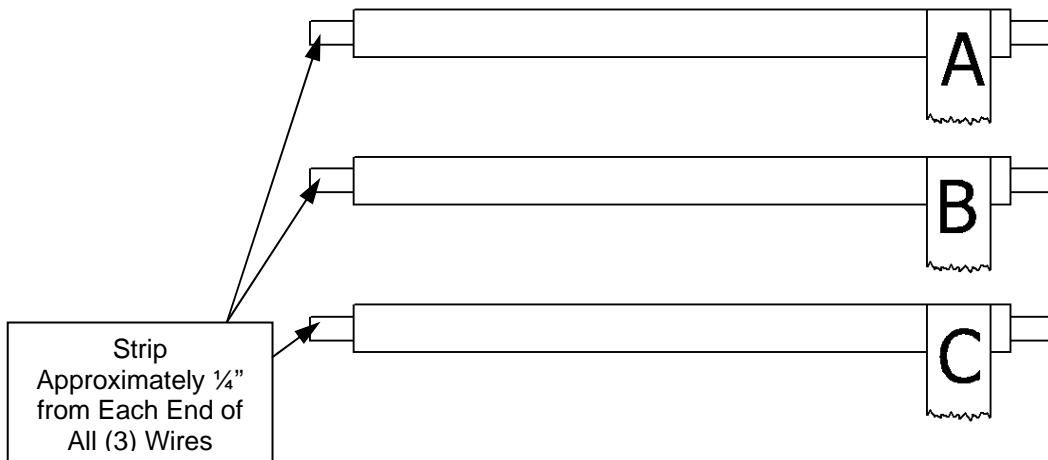

Figure 13

Install Wire (A) – Backplate

Step 8: Using wire (A), insert one end into the top terminal location on the backplate (located on the Setback Control Junction Box Assembly). This is shown in Figure 14. Be sure that the wire already located in this location is not dislodged.

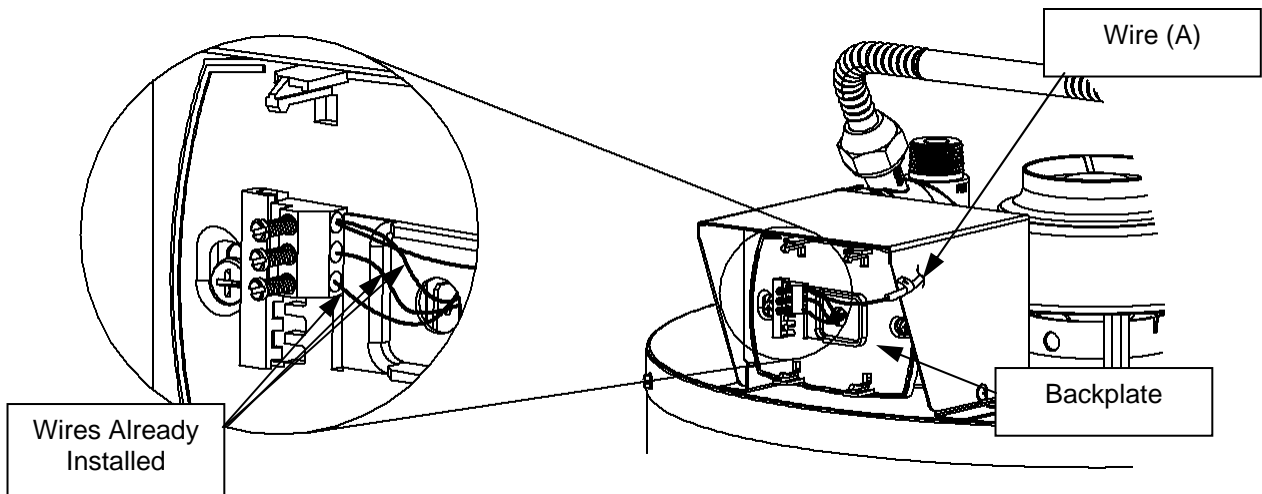
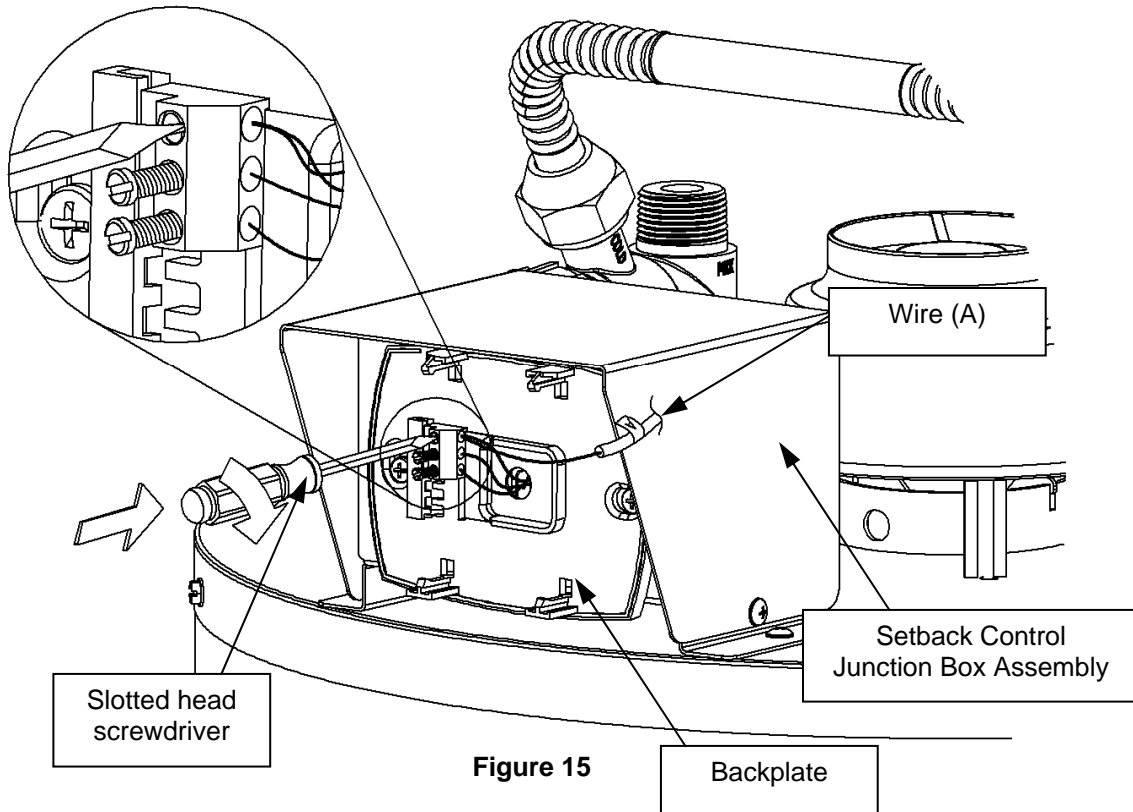

Figure 14

Remote Mounting the Setback Control

Fasten Wire (A) into its Designated Location – Backplate

Step 9: Tighten the slotted screw in the top terminal location on the backplate (located on the Setback Control Junction Box Assembly). This is shown in Figure 15.



Install Wire (B) – Backplate

Step 10: Using wire (B), insert one end into the middle terminal location on the backplate (located on the Setback Control Junction Box Assembly). This is shown in Figure 16. Be sure that the wire already located in this location is not dislodged.

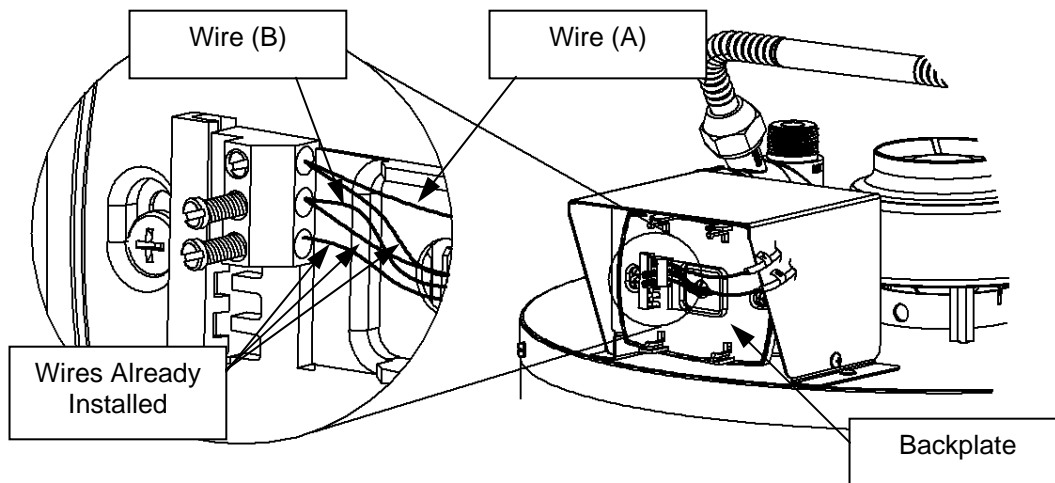
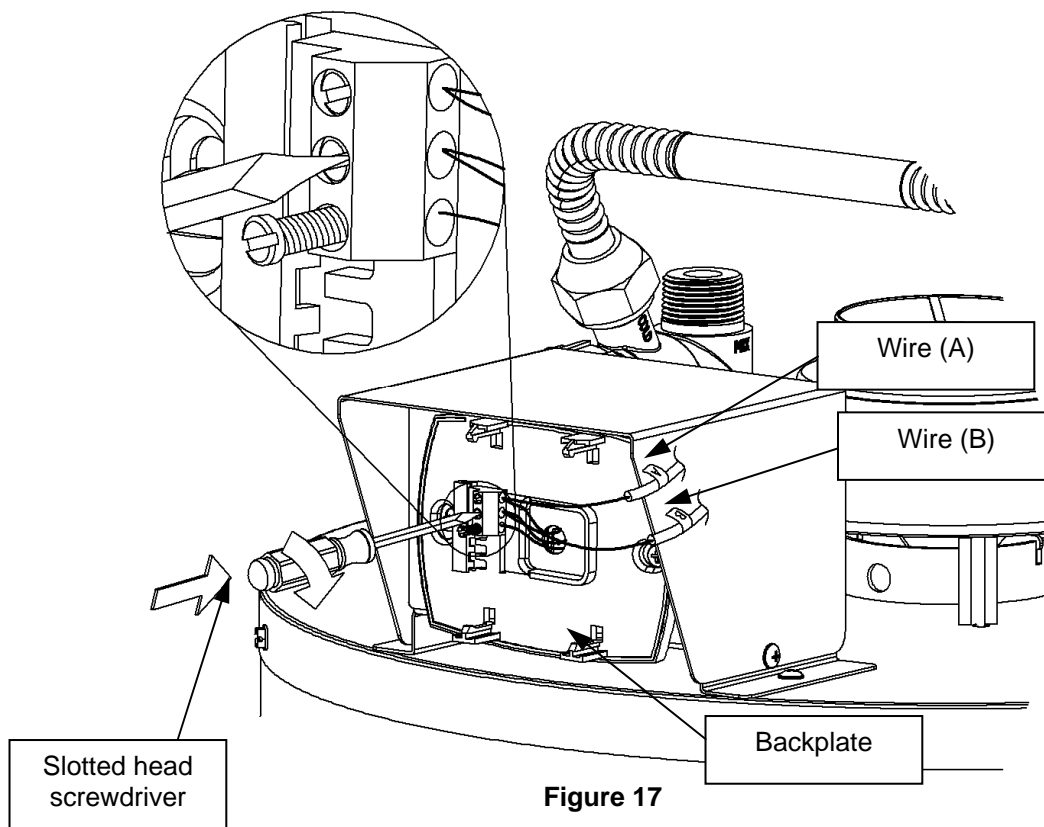

Figure 16

Remote Mounting the Setback Control

Fasten Wire (B) into its Designated Location – Backplate

Step 11: Tighten the slotted screw in the middle terminal location on the backplate (located on the Setback Control Junction Box Assembly). This is shown in Figure 17.



Install Wire (C) – Backplate

Step 12: Using wire (C), insert one end into the bottom terminal location on the backplate (located on the Setback Control Junction Box Assembly). Be sure that the wire already located in this location is not dislodged.

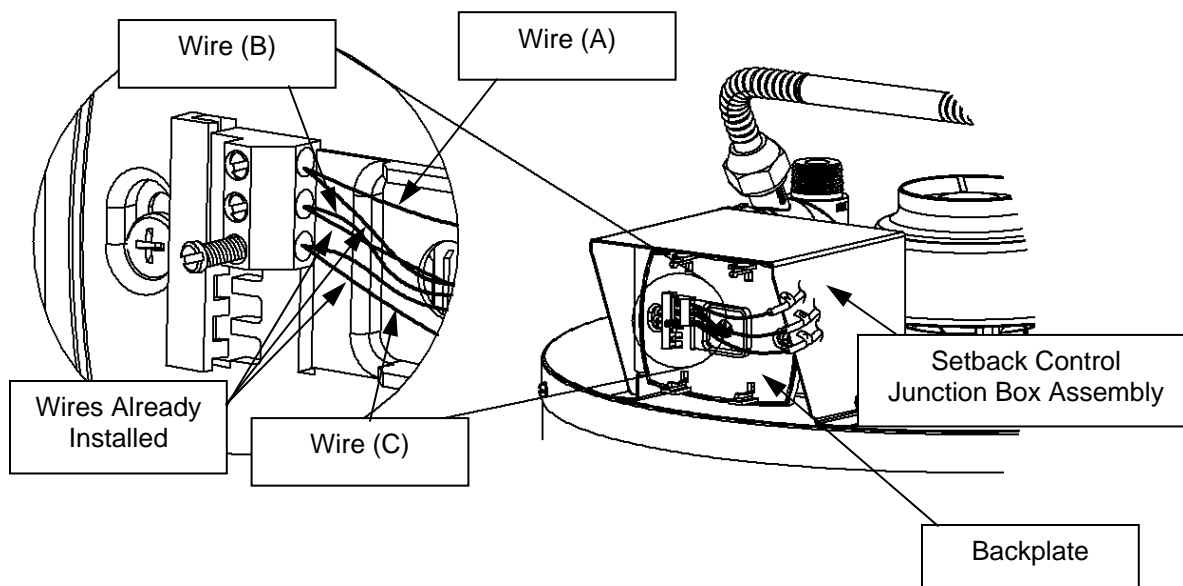

Remote Mounting the Setback Control

Fasten Wire (C) into its Designated Location – Backplate

Step 13: Tighten the slotted screw in the bottom terminal location on the backplate (located on the Setback Control Junction Box Assembly). This is shown in Figure 19.

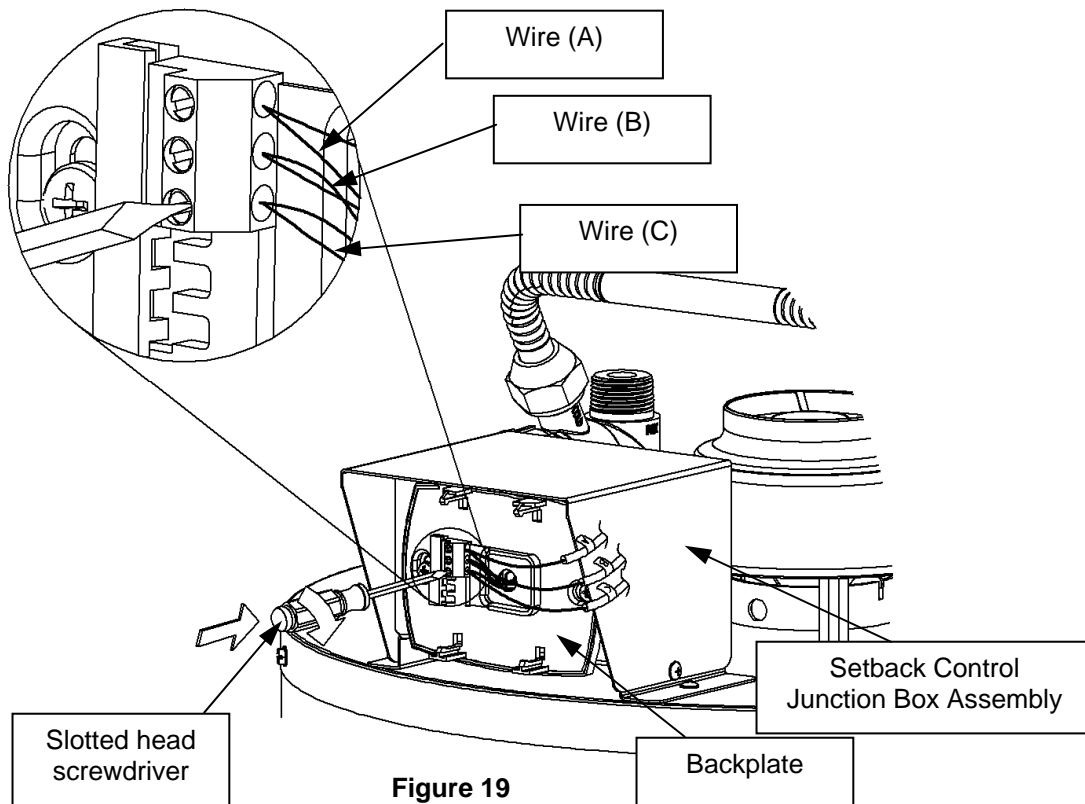

Figure 19

Route Wires to Protective Plate

Step 14: Route all three wires to the Setback Control Protective Plate.

Remote Mounting the Setback Control

Install Wire (A) – Protective Plate

Step 15: Using wire (A), insert one end into the top terminal location on the Protective Plate. This is shown in Figure 20.

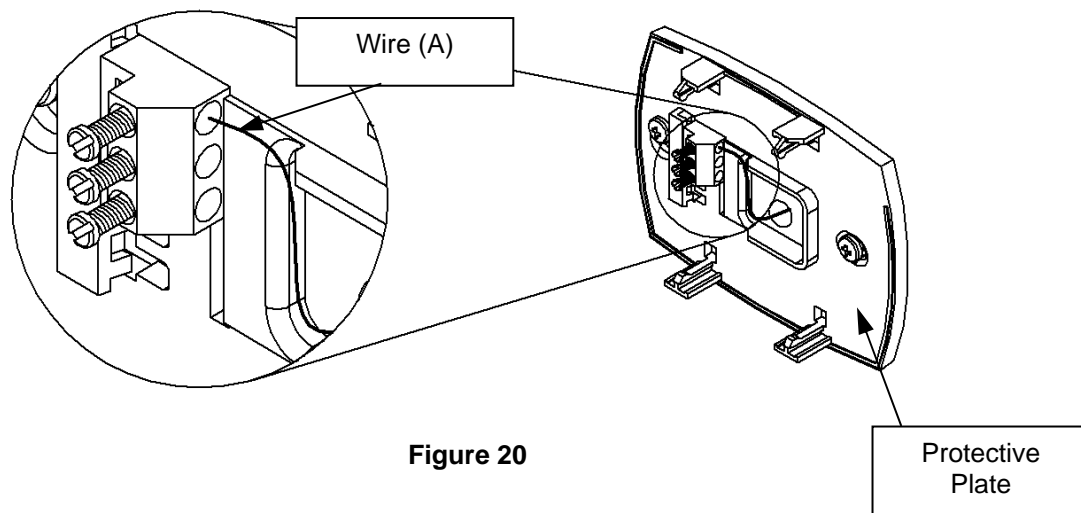

Figure 20

Fasten Wire (A) into its Designated Location – Protective Plate

Step 16: Tighten the slotted screw in the top terminal location on the Protective Plate. This is shown in Figure 21.

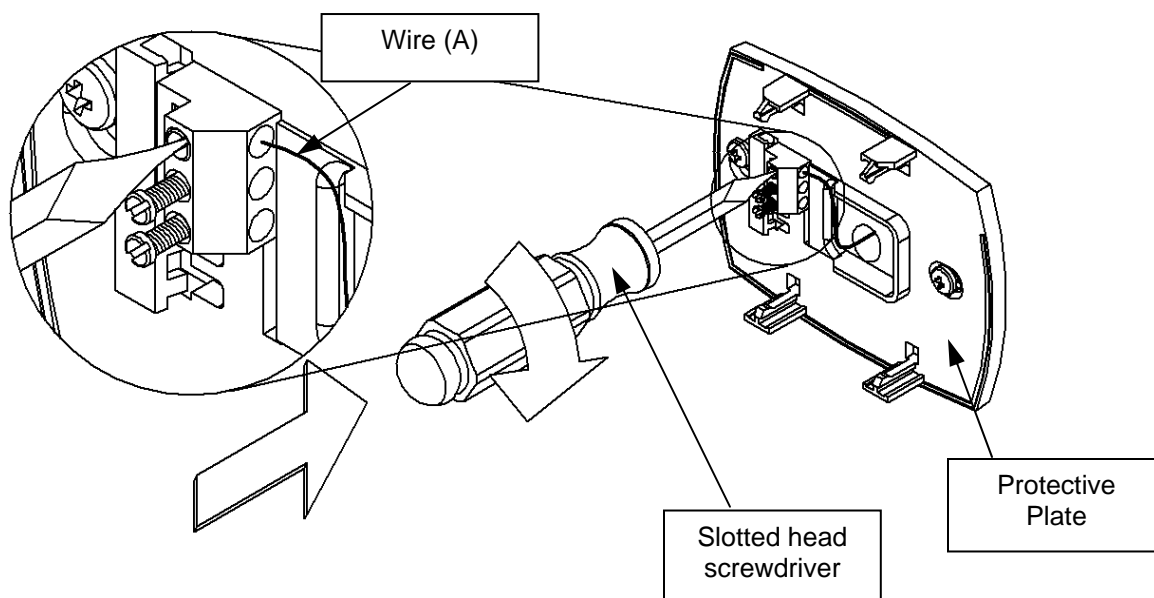

Figure 21

Remote Mounting the Setback Control

Install Wire (B) – Protective Plate

Step 17: Using wire (B), insert one end into the middle terminal location on the Protective Plate. This is shown in Figure 22.

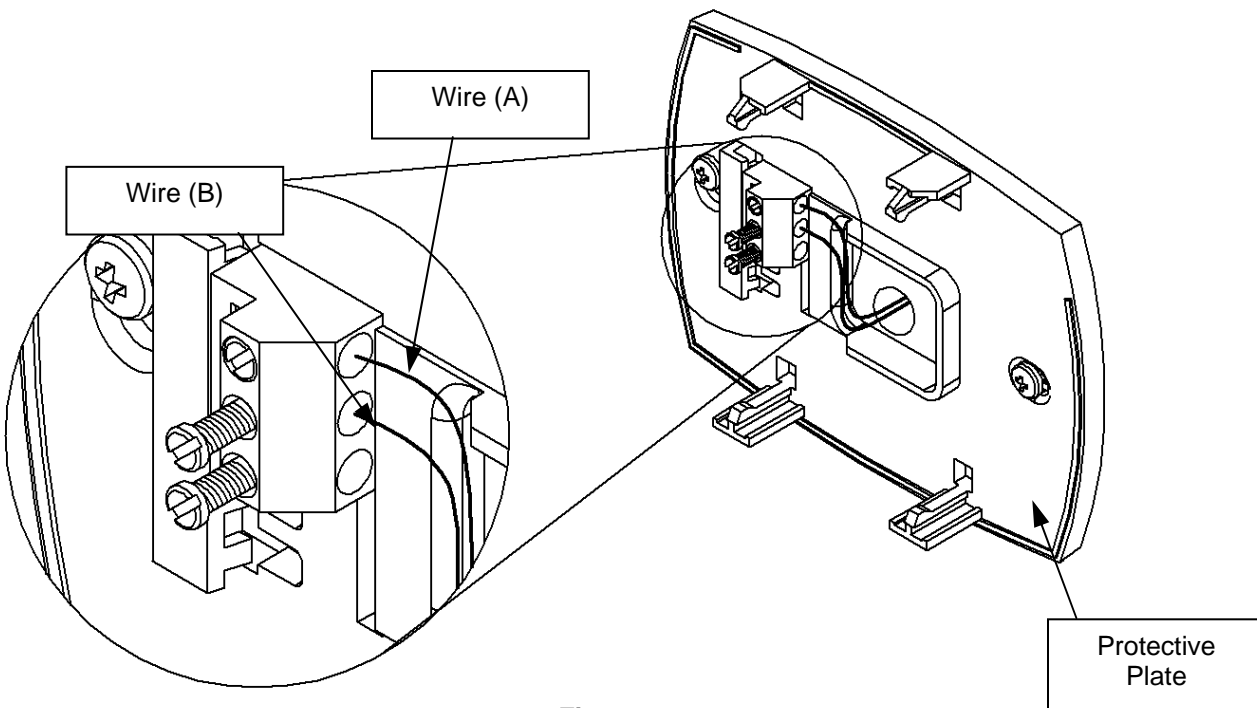

Figure 22

Fasten Wire (B) into its Designated Location – Protective Plate

Step 18: Tighten the slotted screw in the middle terminal location on the Protective Plate. This is shown in Figure 23.

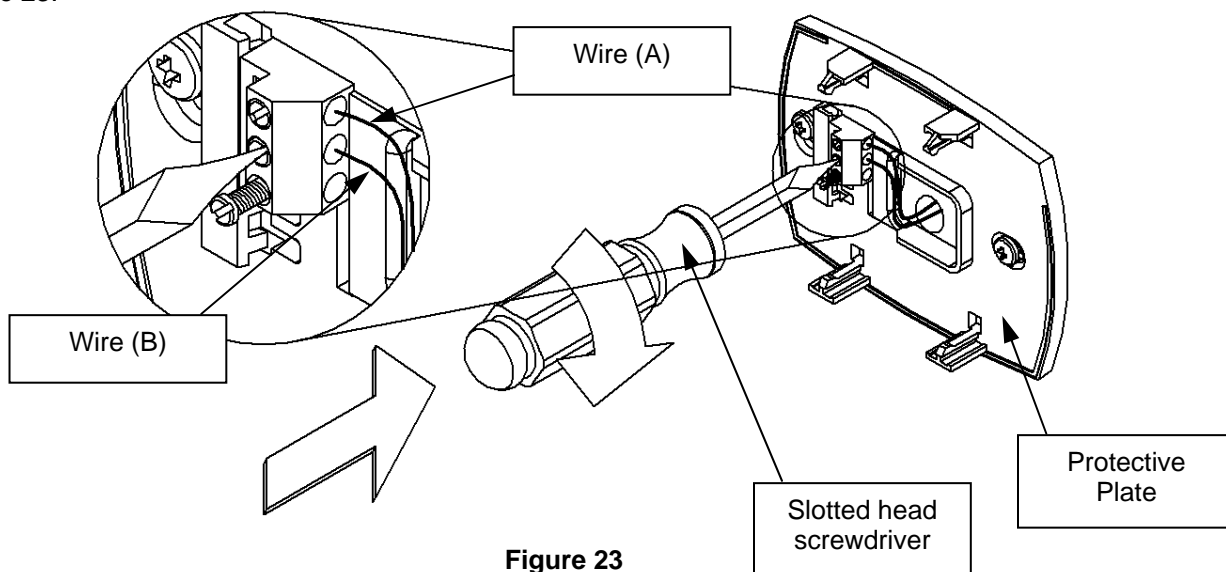

Figure 23

Remote Mounting the Setback Control

Install Wire (C) – Protective Plate

Step 19: Using wire (C), insert one end into the bottom terminal location on the Protective Plate. This is shown in Figure 24.

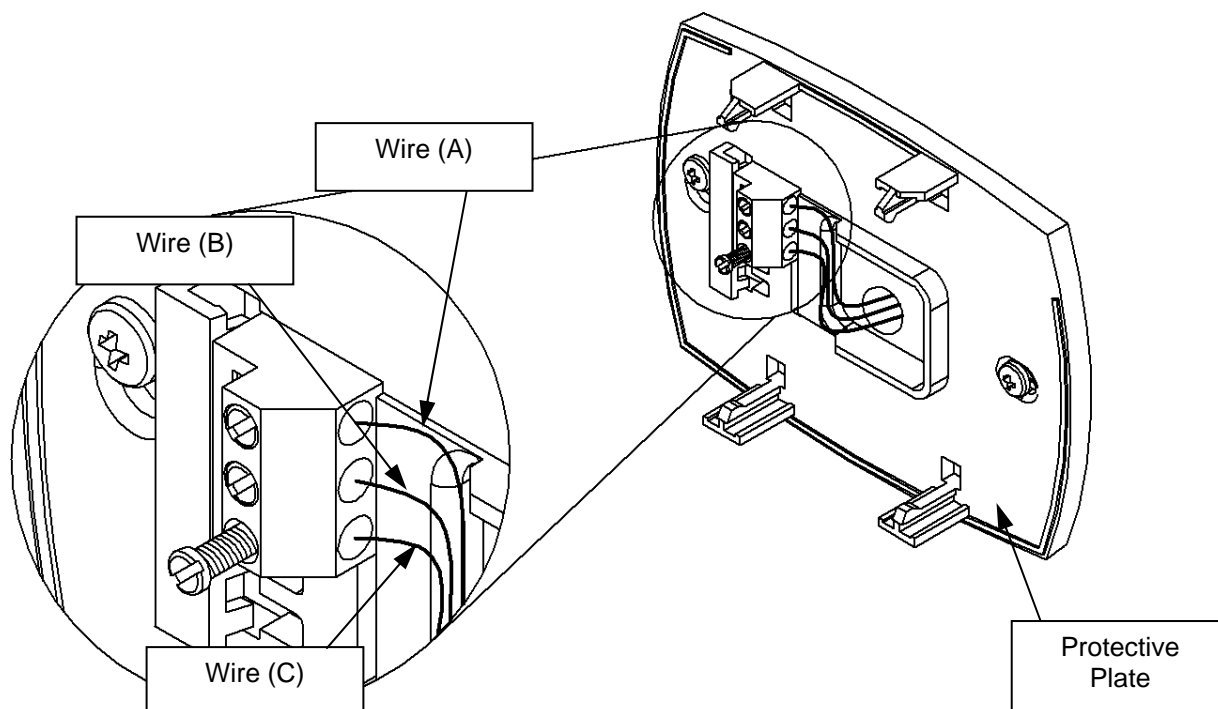

Figure 24

Fasten Wire (C) into its Designated Location – Protective Plate

Step 20: Tighten the slotted screw in the bottom terminal location on the Protective Plate. This is shown in Figure 25.

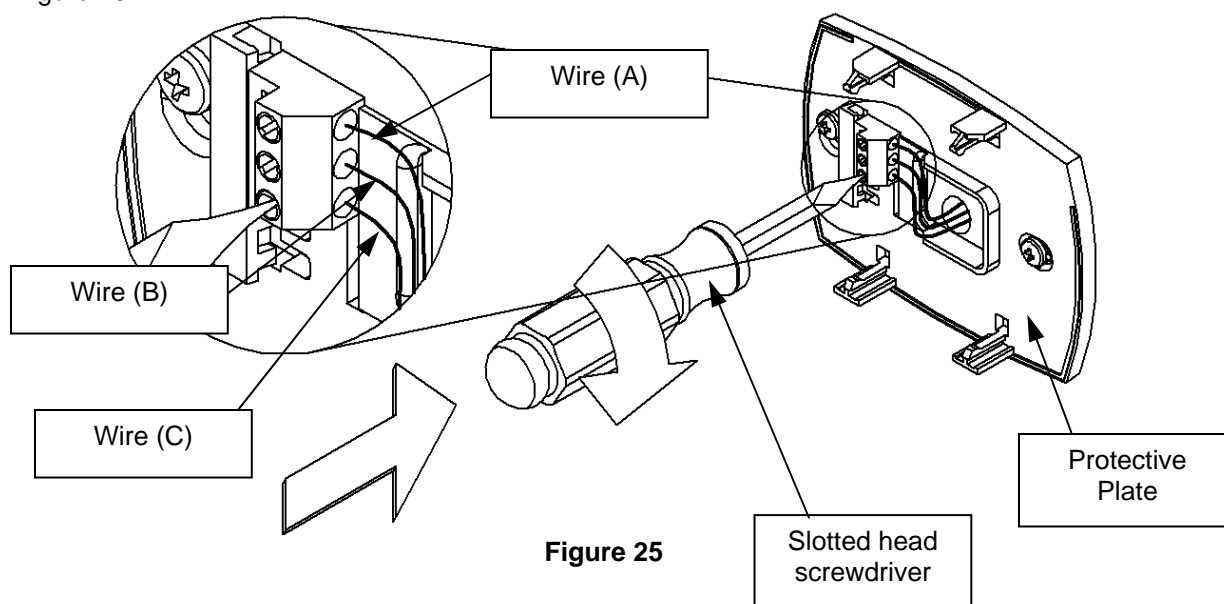

Figure 25

Remote Mounting the Setback Control

Install Setback Control

Step 21: Snap the Setback Control into the Protective Plate. Align the Setback Control to the Protective Plate, and press until it is fully seated. This is shown in Figure 26.

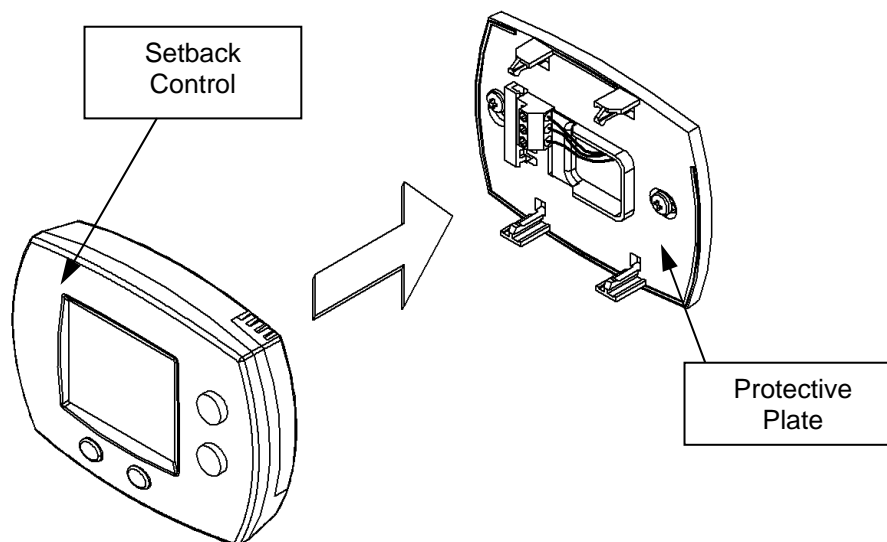

Figure 26

Install Cover Plate

Step 22: Snap the Setback Cover Plate onto the backplate (located on the Setback Control Junction Box Assembly). This is shown in Figure 27.

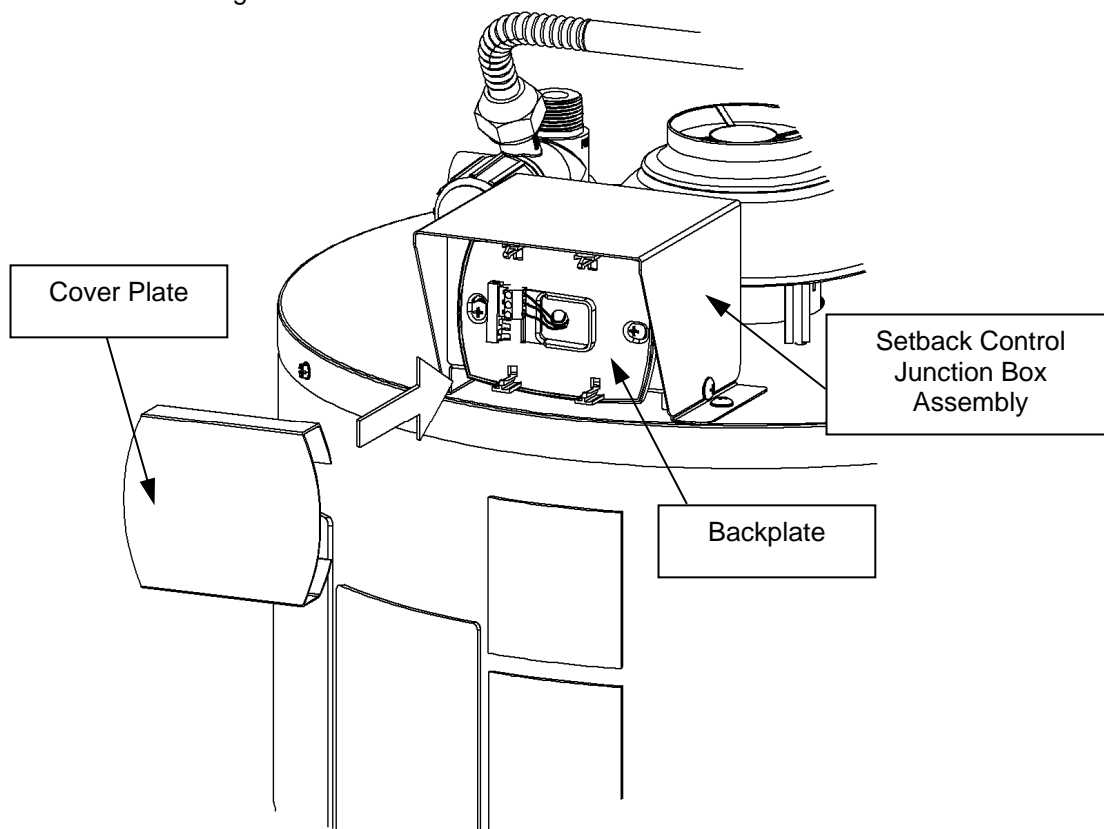

Figure 27

Remote Mounting the Setback Control

Powering the Water Heater and Setback Control

Step 23: Plug in the water heater and the transformer to power the Setback Control. This is shown in Figure 28.

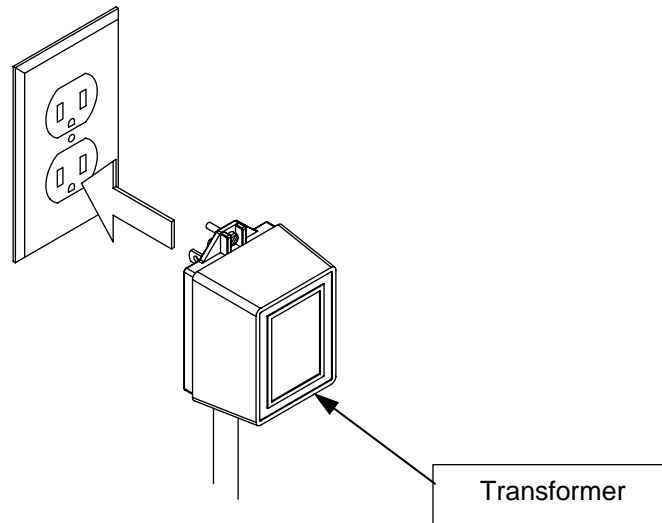

Figure 28

Changing the Batteries

This section covers the replacement of the batteries used as a back-up power source for the Setback Control.

Unplug the Water Heater and Setback Control

Step 1: Unplug the water heater and Setback Control. This is shown in Figure 29.

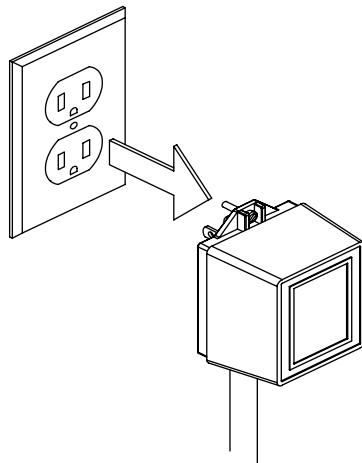

Figure 29

Removal of Setback Control Junction Box Assembly Cover

Step 2: Remove Setback Control Junction Box Assembly cover by unscrewing the two Philips head screws holding it to the Setback Control Junction Box Assembly base. Retain these screws for later use. Remove the cover. This process is shown in Figure 30.

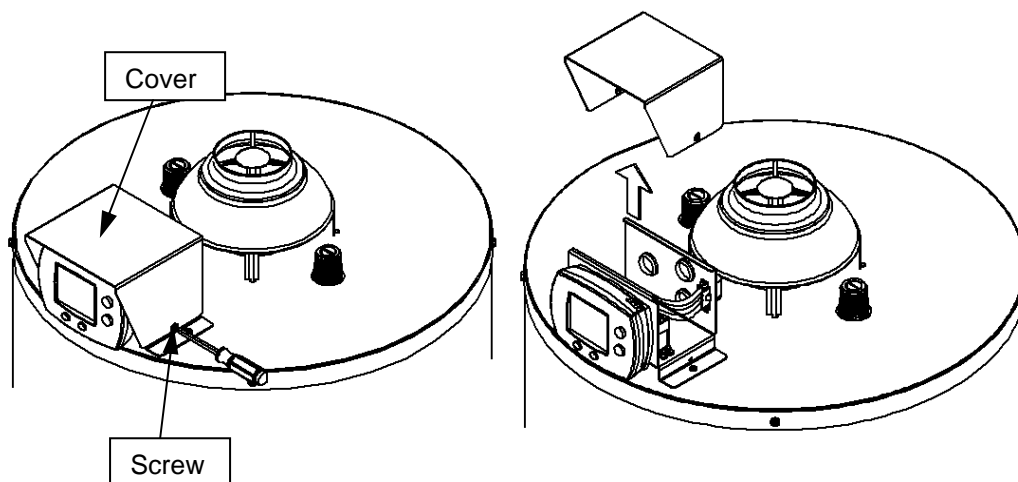

Figure 30

Changing the Batteries

Removal of Battery Holder

Step 3: Remove the battery holder by depressing its top edge and pulling the holder to the right, as shown in Figure 31.

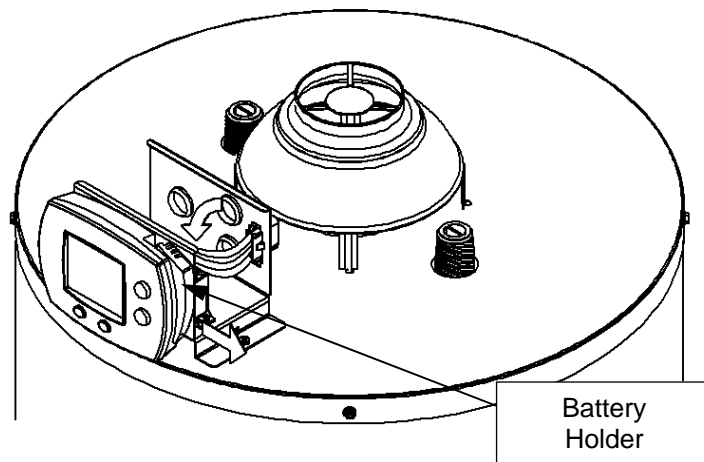

Figure 31

Replacement of Batteries

Step 4: Replace the two batteries with (2) AAA batteries. The batteries should be oriented, as shown in Figure 32.

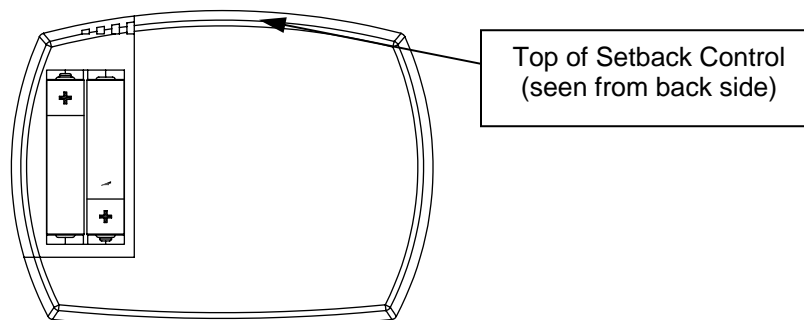

Figure 32

Re-installation of Battery Holder

Step 5: Replace the battery holder with the new batteries by depressing the top side of the battery holder and pushing on the right side of the holder. This is shown in Figure 33.

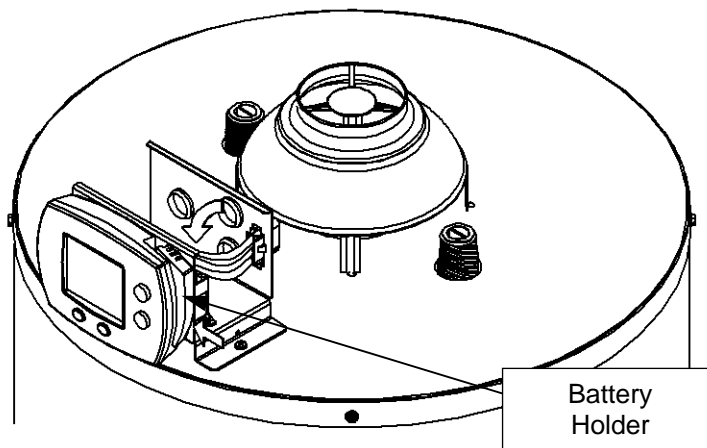

Figure 33

Re-installation of Setback Control Junction Box Assembly Cover

Step 6: Place the cover back on the Setback Control Junction Box Assembly and reinstall the Philips head screws previously removed, as shown in Figure 34.

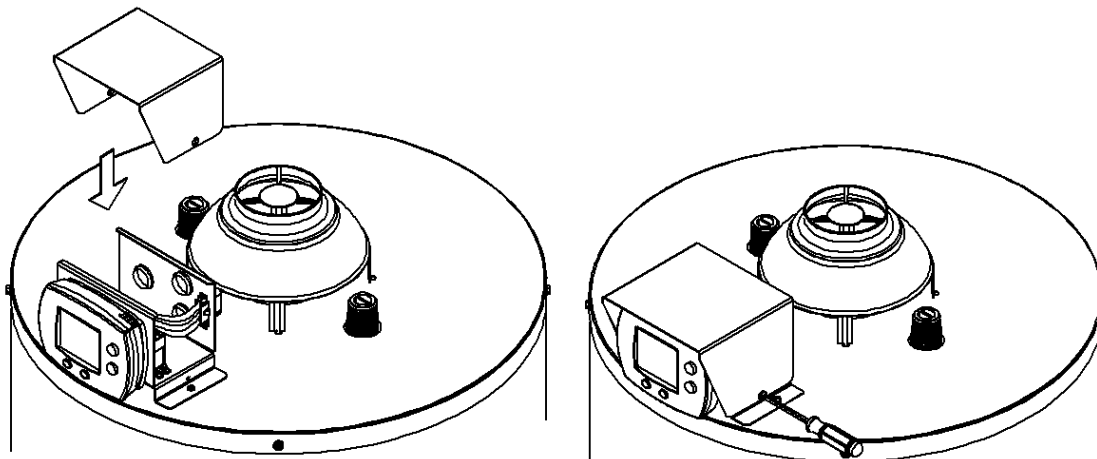

Figure 34

Powering the Water Heater and Setback Control

Step 7: Plug in the water heater and transformer to power the Setback Control. This is shown in Figure 35.

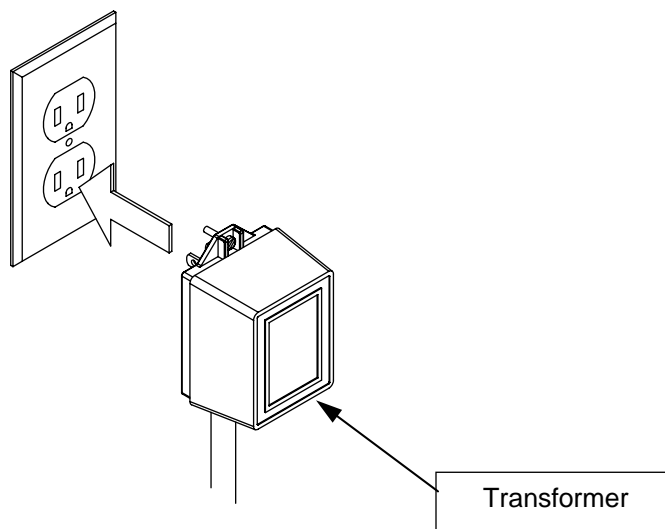

Figure 35

Overview of Control Display and Buttons

The image, below, shows the Setback Control with all of its options shown on the screen. When the Setback Control is in use, only some of these items will be shown.

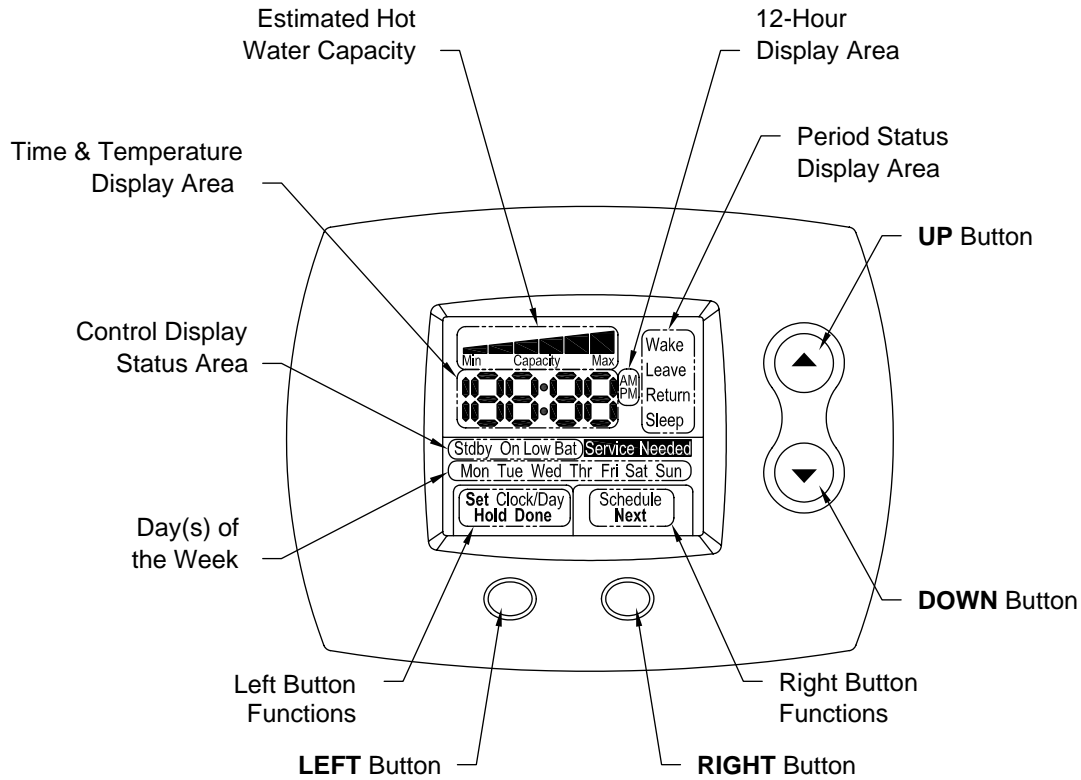

Figure 36

The image below is an example of what the Setback Control displays while operating in the HOME screen.

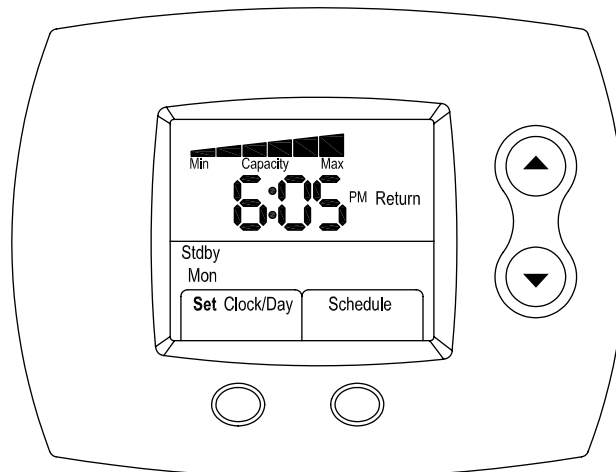

Figure 37

Display Key:

Wake: the time when the water heater setpoint should be raised to an appropriate temperature for its use.

Leave: the time when the water heater setpoint should be lowered when little to no hot water is needed.

Return: the time when the water heater setpoint should be raised for your return and eventual need for hot water.

Sleep: the time when the water heater setpoint should be lowered when no hot water is needed for the day.

Stdby (Standby): the water heater is not calling for heat (the water heater burner is not on).

On: the water heater is calling for heat (the water heater burner is on).

Low Bat (Low Battery): the Setback Control batteries are low and should be changed.

Service Needed: a fault has occurred and a serviceable issue needs to be addressed on the water heater or control. Contact a qualified service technician.

Display Features:

When the Setback Control is operating normally and is operating in its set schedule (no temporary or permanent hold set), the water temperature setpoint and time will be alternately shown. The current period water temperature setpoint will be shown for approximately five seconds, followed by the current time for approximately five seconds.

If the Setback Control has been set to a different water temperature, as part of a temporary or permanent hold, the hold water temperature will only be shown.

One of the features on the Setback Control is the display of the approximate hot water volume contained in the water heater. A sophisticated algorithm in the Setback Control determines the hot water volume based on the water heater gas control setpoint. The capacity shown is not based on the setpoints that are a part of the Setback Control schedule. The capacity is based off from the setpoint on the gas control. A maximum of six bars can be shown.

If six bars are shown, this means the maximum hot water is available for use given the current control setpoint. Alternatively, if only two bars are shown, this means that only one-third of the maximum hot water is available for use given the current control setpoint. The Setback Control assumes hot water over 90°F (32°C) is of sufficient temperature to be used.

The Setback Control water temperatures can be set to a maximum temperature the same as that set on the gas control.

Reference Time / Water Temperature Table

The table, shown below, can be filled out with your schedule for future reference.

	Wake		Leave		Return		Sleep	
	Start Time	Water Temperature	Start Time	Water Temperature	Start Time	Water Temperature	Start Time	Water Temperature
Monday								
Tuesday								
Wednesday								
Thursday								
Friday								
Saturday								
Sunday								

The Start-up Procedure

This section covers what steps need to be performed when the Setback Control is installed on a water heater.

Screen When Power is Applied

Step 1: Initially, all the segments on the screen are shown when the Setback Control is powered up. This is shown in Figure 38.

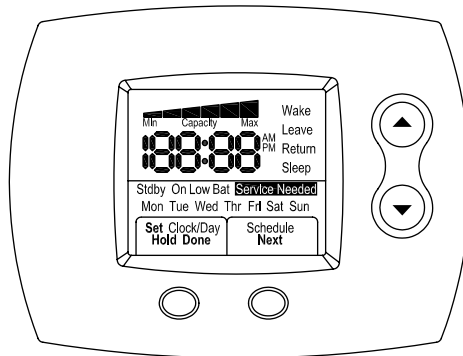

Figure 38

Revision Level Screen

Step 2: After a few seconds, the software revision level of the Setback Control is shown. An example is shown in Figure 39.

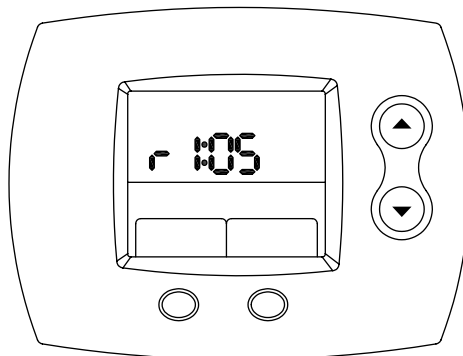

Figure 39

Select the Correct Hour

Step 3: The hour digit or digits will begin to flash initially. Using the **UP** (increase hour) or **DOWN** (decrease hour) buttons, change the hour until the correct hour is shown. This is shown in Figure 40.

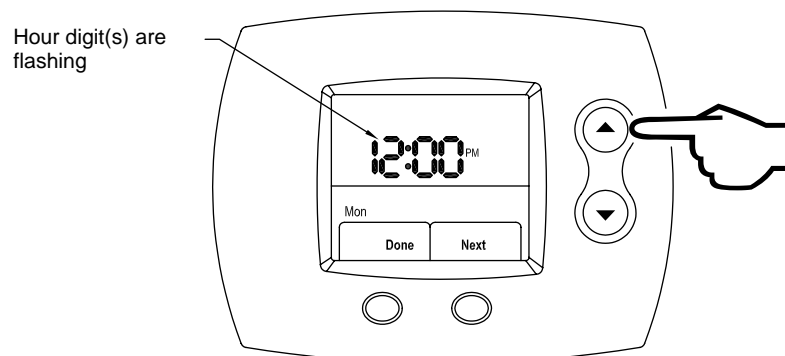

Figure 40

The Start-up Procedure

Locking in the Correct Hour

Step 4: When the correct hour is shown, press the **RIGHT** (Next) button. This is shown in Figure 41.

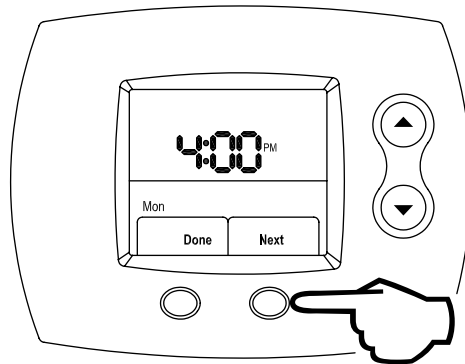

Figure 41

Select the Correct Minute

Step 5: Using the **UP** (increase minute) or **DOWN** (decrease minute) buttons, adjust the minute until the correct minute is shown. This process is shown in Figure 42.

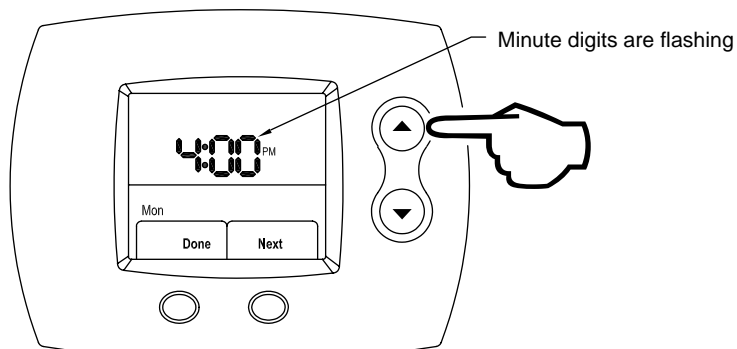

Figure 42

Lock in the Correct Minute

Step 6: When the correct minute is shown, press the **RIGHT** (Next) button. This is shown in Figure 43.

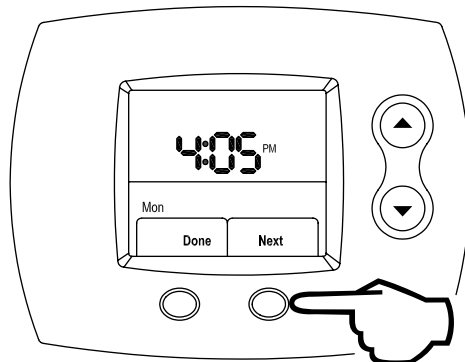

Figure 43

The Start-up Procedure

Select AM / PM

Step 7: Next, the AM / PM symbol will begin to flash. Using the **UP** (index AM / PM) or **DOWN** (index AM / PM) buttons, select AM / PM. See Figure 44.

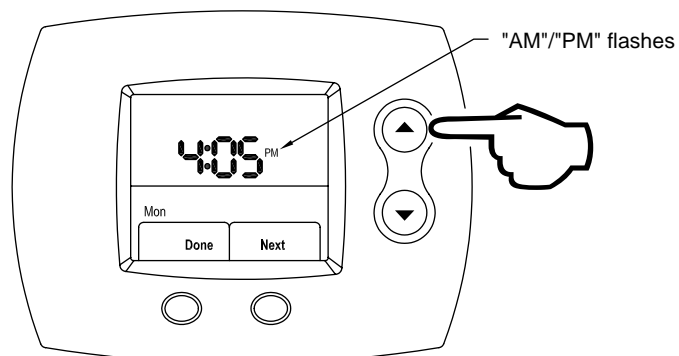

Figure 44

Lock in AM / PM

Step 8: Press the **RIGHT** (Next) button to proceed. This is shown in Figure 45.

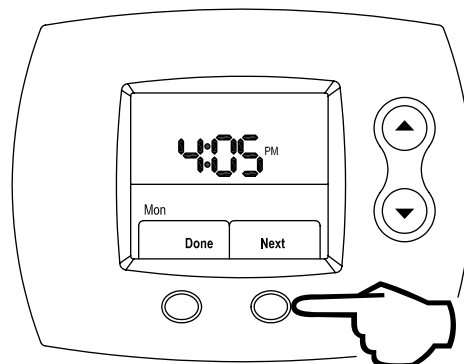

Figure 45

Select the Day

Step 9: Finally, select the day. A day will be flashing initially. Using the **UP** (increase one day) or **DOWN** (decrease one day) buttons, change the day until the correct day is shown. See Figure 46.

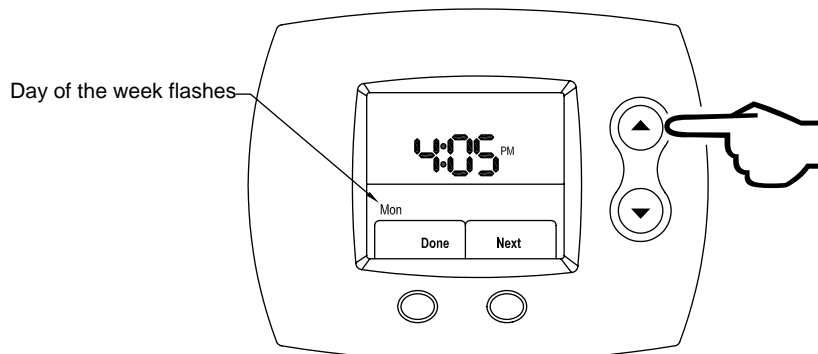

Figure 46

The Start-up Procedure

Finishing the Start-up Procedure

Step 10: Press the **LEFT** (Done) button, as shown in Figure 47. This completes the Setback Control Start-up Procedure. You will now be taken to the HOME screen.

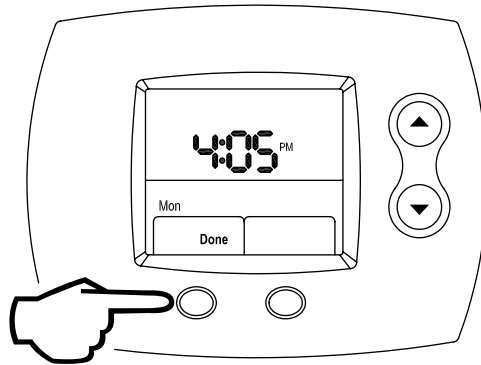

Figure 47

Setting the Setback Control Schedule – Initial Set-up

Once the Setback Control Start-up procedure has been performed, the Setback schedule must be entered. This section gives step-by-step instructions on how to enter the Setback schedule.

Setting the Schedule

Step 1: From the Home screen, press the **RIGHT** (Schedule) button, as shown in Figure 48.

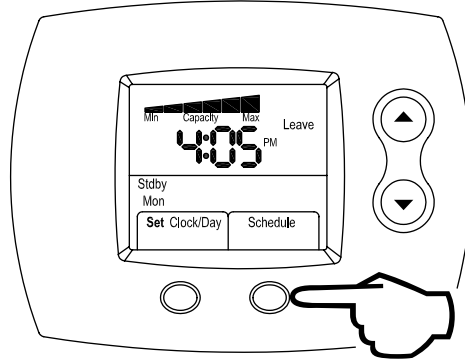

Figure 48

Select the Day

Step 2: Monday is flashing initially. Press the **RIGHT** (Next) button to proceed to the Wake Period for Monday. This is shown in Figure 49. When the remaining days of the week are to be programmed, the **UP** (increase day) or **DOWN** (decrease day) buttons must be used to change the day.

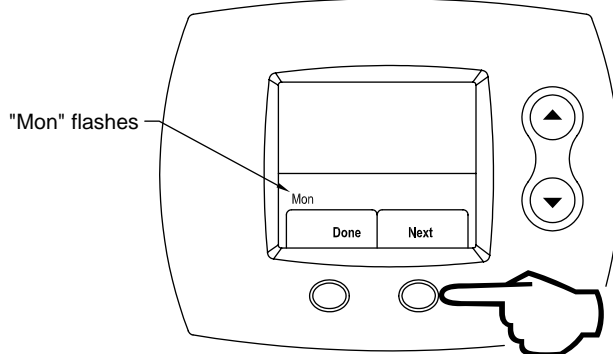

Figure 49

Select the Wake Period Start Time

Step 3: Press the **UP** (increase time) or **DOWN** (decrease time) buttons until the wanted time is shown. This is shown in Figure 50.

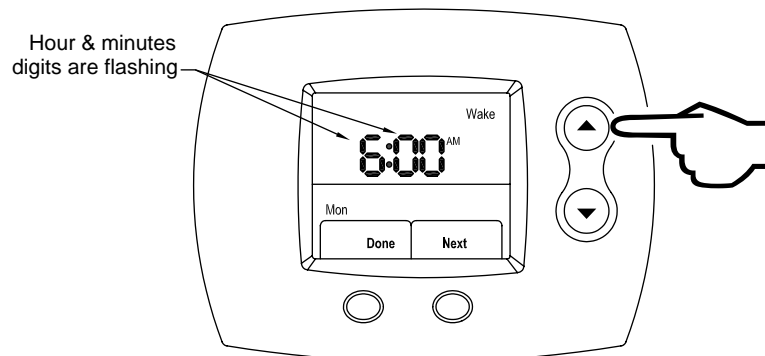

Figure 50

Setting the Setback Control Schedule – Initial Set-up

Lock in Wake Period Start Time

Step 4: Press the **RIGHT** (Next) button to lock in the Wake Period start time, as shown in Figure 51.

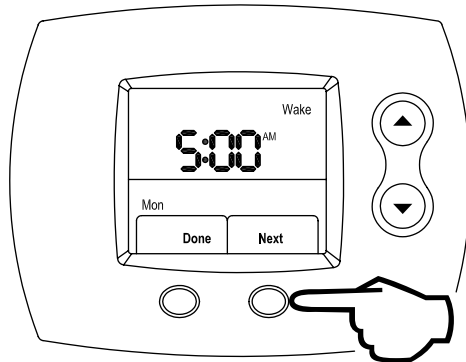

Figure 51

Select AM / PM

Step 5: Using the **UP** (index AM / PM) or **DOWN** (index AM / PM) buttons, select AM / PM, as shown in Figure 52.

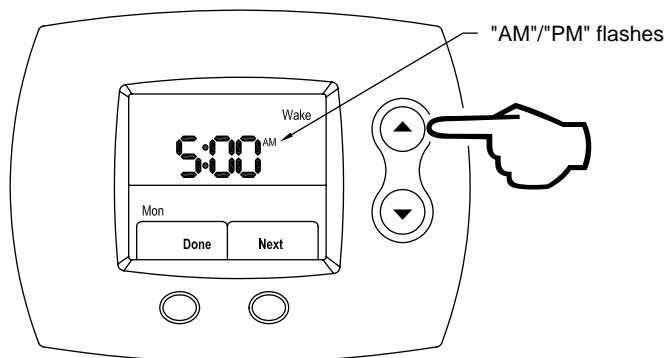

Figure 52

Lock in AM / PM

Step 6: Press the **RIGHT** (Next) button to lock in AM / PM. This is shown in Figure 53.

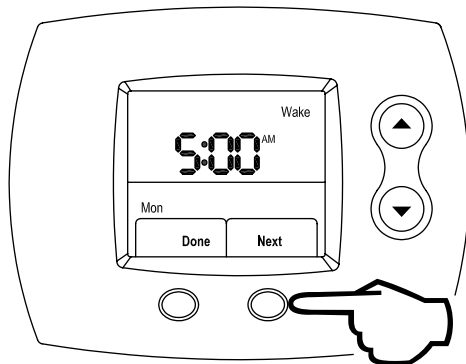

Figure 53

Setting the Setback Control Schedule – Initial Set-up

Select the Wake Period Water Temperature

Step 7: Using the **UP** (increase water temperature) or **DOWN** (decrease water temperature) buttons, select the desired water temperature. This is shown in Figure 54.

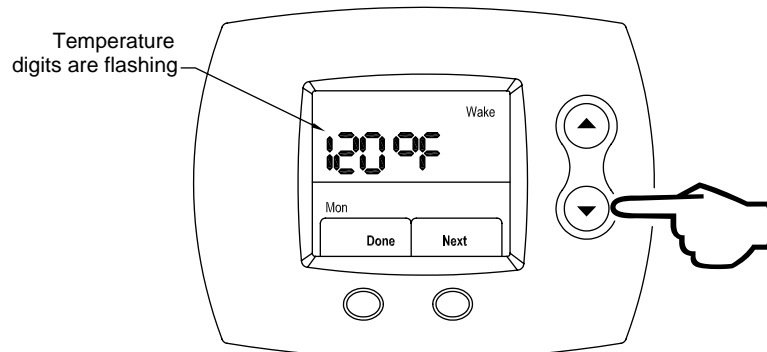

Figure 54

Lock in Wake Period Water Temperature

Step 8: Press the **RIGHT** (Next) button to lock in the Wake period water temperature, as shown in Figure 55.

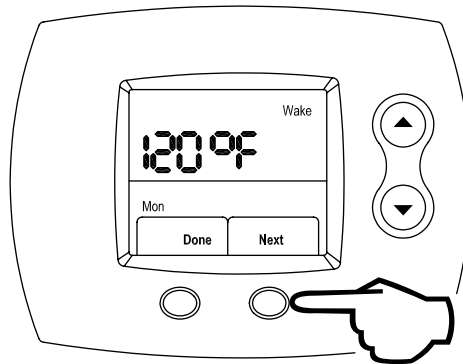

Figure 55

Select the Leave Period Start Time

Step 9: Press the **UP** (increase time by 15 minutes) or **DOWN** (decrease time by 15 minutes) buttons to select the Leave period start time. The time increments in 15-minute intervals just as it did for the Wake period. This is shown in Figure 56.

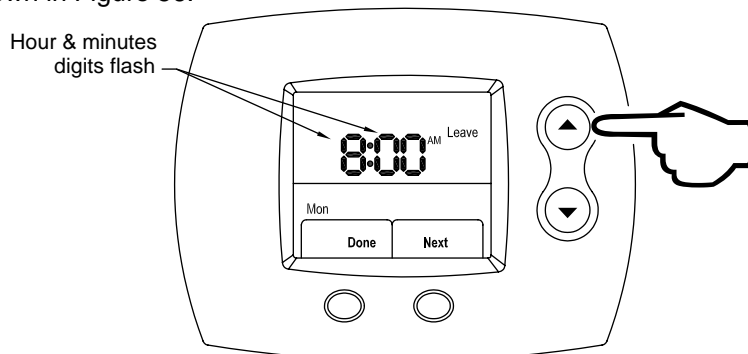

Figure 56

Setting the Setback Control Schedule – Initial Set-up

Lock in Leave Period Start Time

Step 10: Press the **RIGHT** (Next) button to set the Leave start time, which is shown in Figure 57.

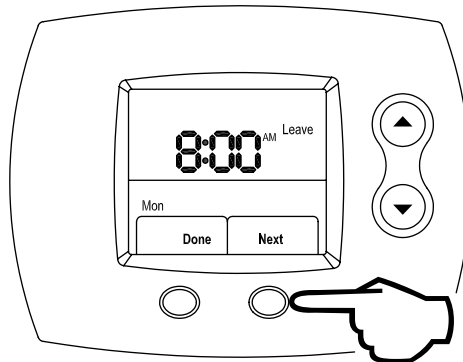

Figure 57

Select AM / PM

Step 11: Next, using the **UP** (index AM / PM) or **DOWN** (index AM / PM) buttons, select AM / PM, as shown in Figure 58.

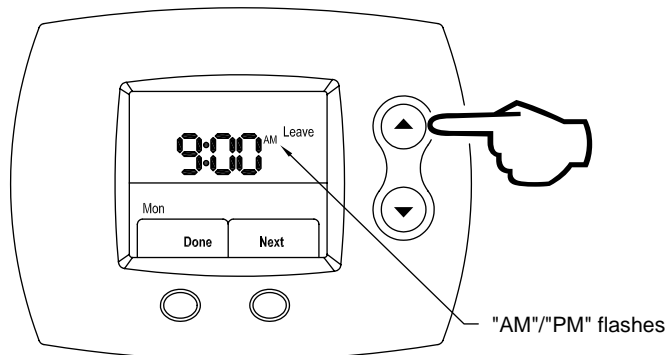

Figure 58

Lock in AM / PM

Step 12: Press the **RIGHT** (Next) button to lock in AM / PM. This is shown in Figure 59.

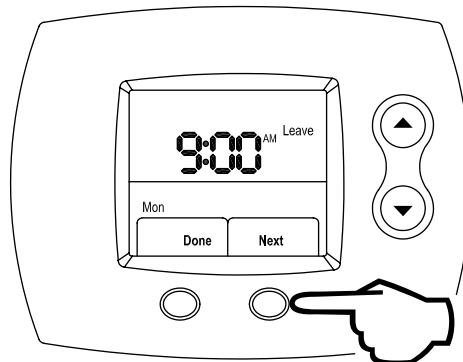

Figure 59

Select the Leave Period Water Temperature

Step 13: Using the **UP** (increase water temperature) or **DOWN** (decrease water temperature) buttons, select the desired water temperature for the Leave period. This is shown in Figure 60.

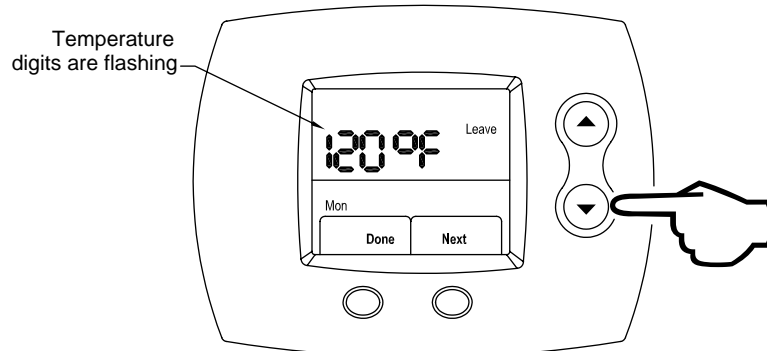

Figure 60

Lock in Leave Period Water Temperature

Step 14: Press the **RIGHT** (Next) button to lock in the Leave period water temperature, as shown in Figure 61.

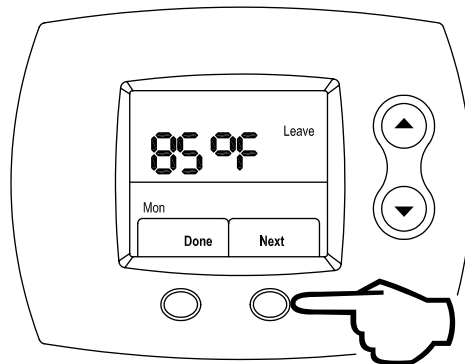

Figure 61

Select the Return Period Start Time

Step 15: Press the **UP** (increase time by 15 minutes) or **DOWN** (decrease time by 15 minutes) buttons to select the Return period start time. The time increments in 15-minute intervals just as it did for the other periods. This is shown in Figure 62.

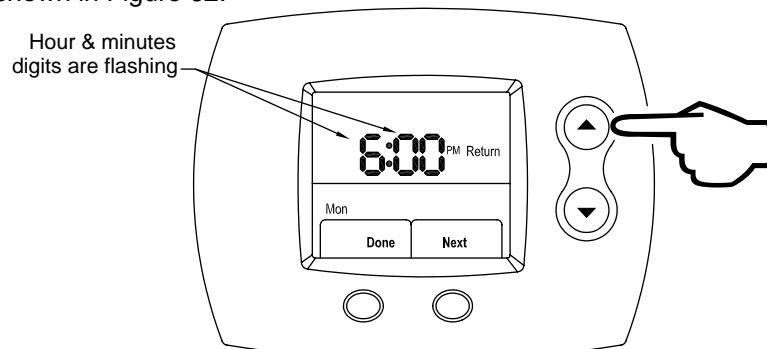

Figure 62

Setting the Setback Control Schedule – Initial Set-up

Lock in Return Period Start Time

Step 16: Press the **RIGHT** (Next) button to set the Return period start time, which is shown in Figure 63.

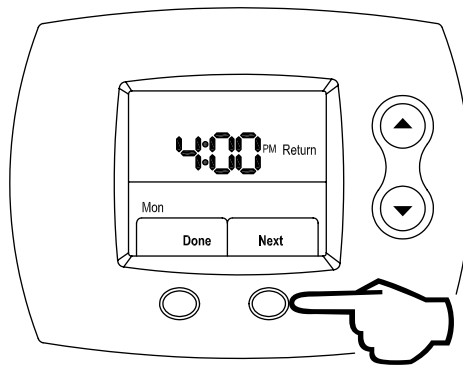

Figure 63

Select AM / PM

Step 17: Next, using the **UP** (index AM / PM) or **DOWN** (index AM / PM) buttons, select AM / PM, as shown in Figure 64.

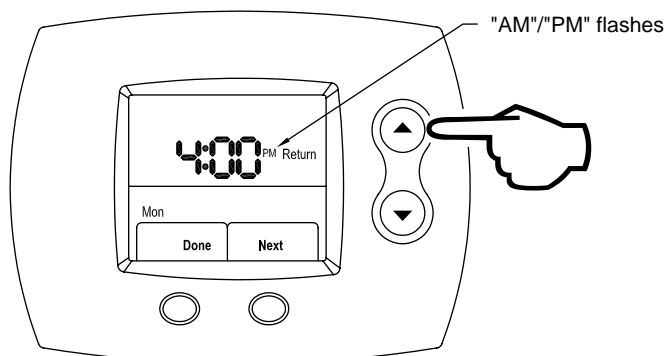

Figure 64

Lock in AM / PM

Step 18: Press the **RIGHT** (Next) button to lock in AM / PM. This is shown in Figure 65.

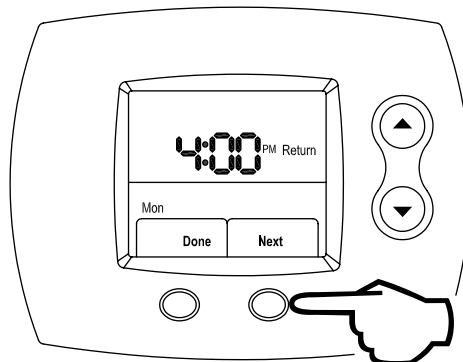

Figure 65

Select the Return Period Water Temperature

Step 19: Using the **UP** (increase water temperature) or **DOWN** (decrease water temperature) buttons, select the Return period water temperature. This is shown in Figure 66.

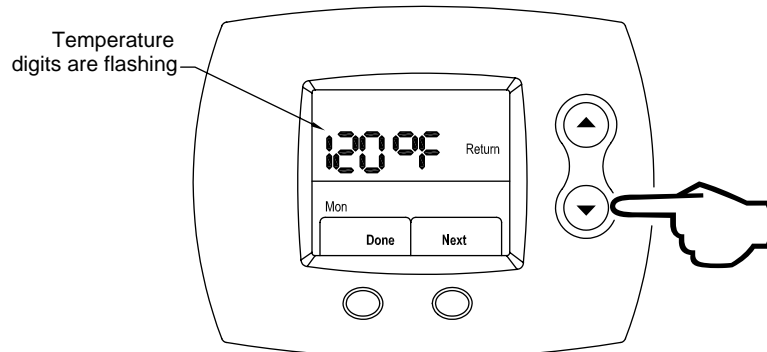

Figure 66

Lock the Return Period Water Temperature

Step 20: Press the **RIGHT** (Next) button to lock in the Return period water temperature, as shown in Figure 67.

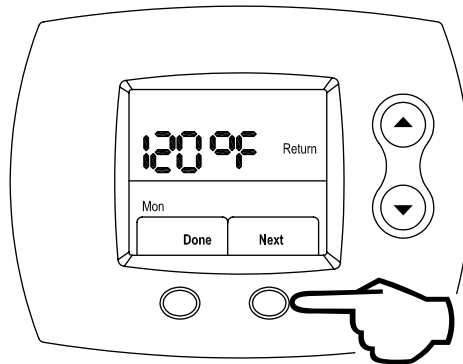

Figure 67

Select the Sleep Period Start Time

Step 21: Press the **UP** (increase time by 15 minutes) or **DOWN** (decrease time by 15 minutes) buttons to select the Sleep period start time. The time increments in 15-minute intervals just as it did for the previous periods. This is shown in Figure 68.

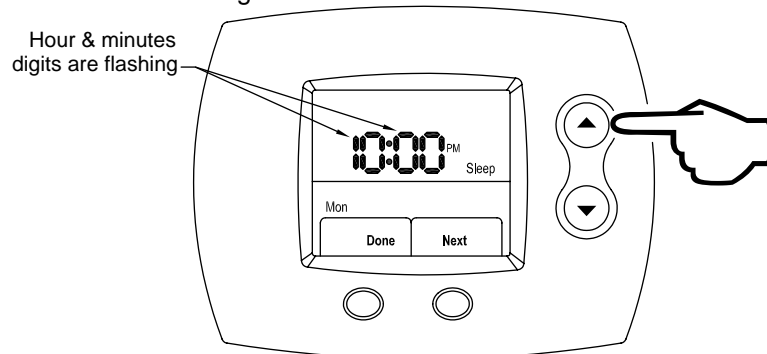

Figure 68

Setting the Setback Control Schedule – Initial Set-up

Lock the Sleep Period Start Time

Step 22: Press the **RIGHT** (Next) button to set the Sleep period start time, which is shown in Figure 69.

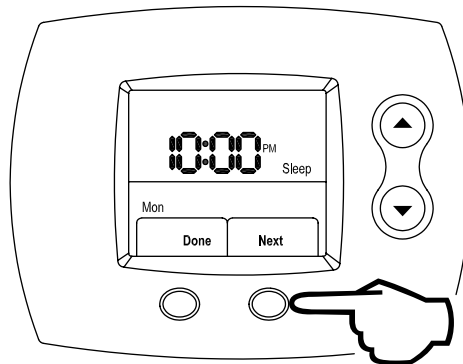

Figure 69

Select AM / PM

Step 23: Next, using the **UP** (index AM / PM) or **DOWN** (index AM / PM) buttons, select AM / PM, as shown in Figure 70.

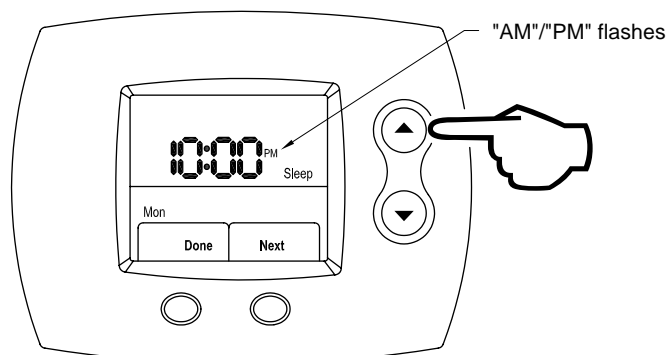

Figure 70

Lock in AM / PM

Step 24: Press the **RIGHT** (Next) button to lock in AM / PM. This is shown in Figure 71.

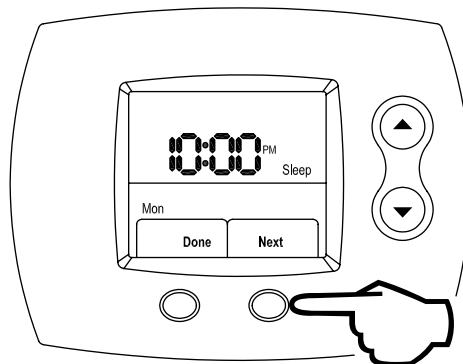

Figure 71

Setting the Setback Control Schedule – Initial Set-up

Select Sleep Period Water Temperature

Step 25: Using the **UP** (increase water temperature) or **DOWN** (decrease water temperature) buttons, select the desired Sleep period water temperature. This is shown in Figure 72.

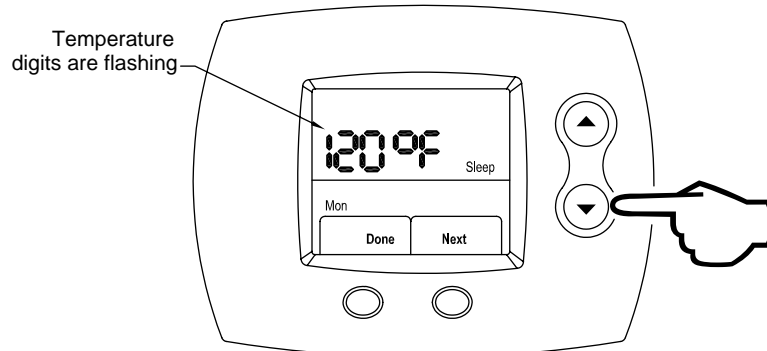

Figure 72

Lock in Sleep Period Water Temperature

Step 26: Press the **RIGHT** (Next) button, as shown in Figure 73. Now, the Sleep time period is set for Monday. This completes the one day of the Setback schedule. To set the schedule for the remaining days of the week, repeat the procedures beginning at Step 2 on page 31 for Tuesday through Sunday schedules. Otherwise, proceed to Step 27.

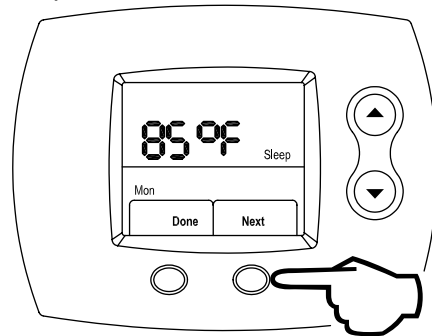

Figure 73

To set the schedule for the remaining days of the week, repeat the procedures beginning at Step 2 on page 31 for Tuesday through Sunday schedules. Otherwise, proceed to Step 27.

Finishing the Setback Schedule

Step 27: Press the **LEFT** (Done) button to finish the Setback schedule, as shown in Figure 74.

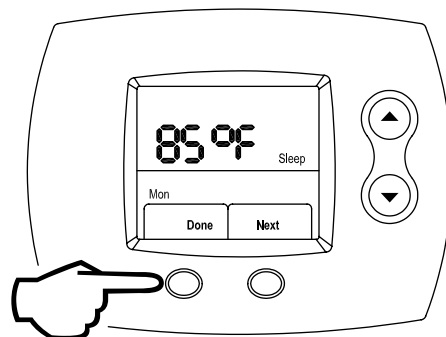

Figure 74

Editing the Setback Schedule

If the Setback schedule needs to be modified at any point, the instructions in this section can be followed to edit the previously entered water temperatures and times.

Enter Editing the Schedule Mode

Step 1: From the Home screen, press the **RIGHT** (Schedule) button, as shown in Figure 75.

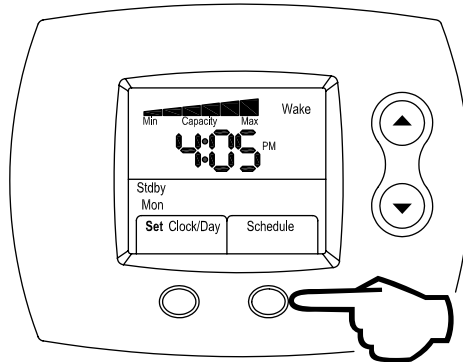

Figure 75

Select the Day to Edit

Step 2: Monday is flashing initially. Using the **UP** (increase day) or **DOWN** (decrease day) buttons, scroll until the day that needs to be edited is shown. This is shown in Figure 76.

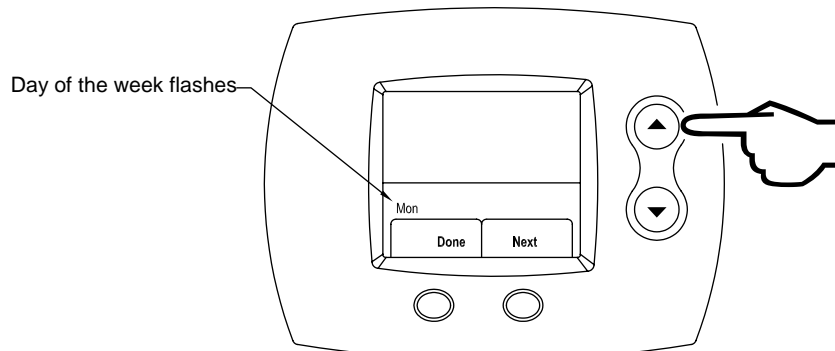

Figure 76

Lock in the Day to Edit

Step 3: Press the **RIGHT** (Next) button to edit a particular day water temperatures and times. This is shown in Figure 77.

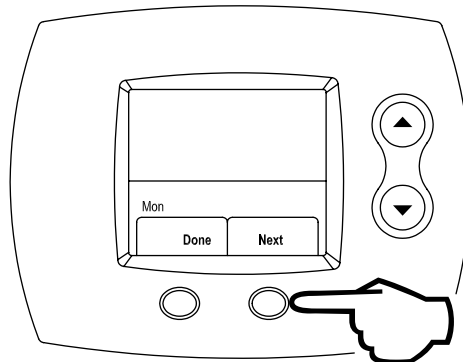

Figure 77

Edit the Wake Period Start Time

Step 4: Press the **UP** (increase time by 15 minutes) or **DOWN** (decrease time by 15 minutes) buttons until the wanted time is shown. This is shown in Figure 78.

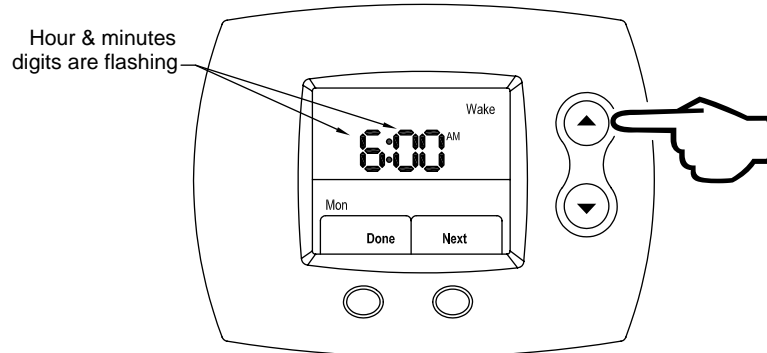

Figure 78

Lock in the Wake Period Start Time

Step 5: Press the **RIGHT** (Next) button to lock the Wake period start time for the day selected, as shown in Figure 79.

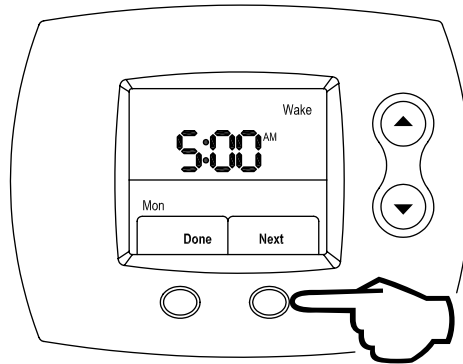

Figure 79

Edit AM / PM

Step 6: Next, using the **UP** (index AM / PM) or **DOWN** (index AM / PM) buttons, select AM / PM, as shown in Figure 80.

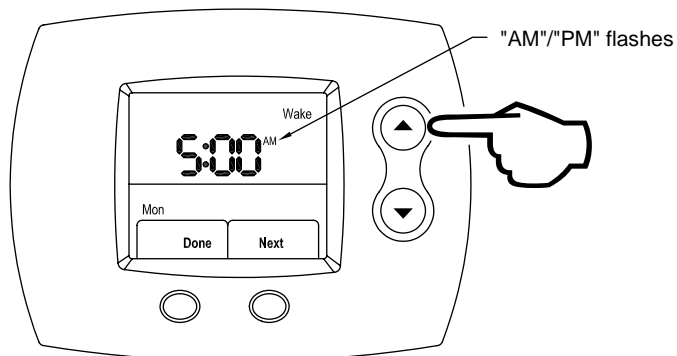

Figure 80

Editing the Setback Schedule

Lock in AM / PM

Step 7: Press the **RIGHT** (Next) button to select AM / PM. This is shown in Figure 81.

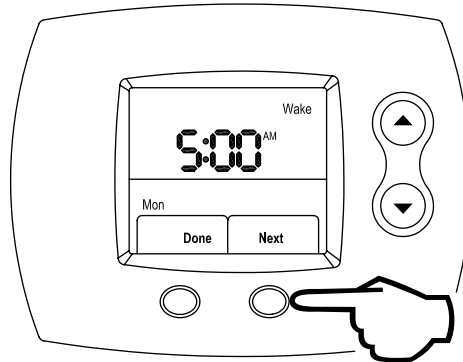

Figure 81

Edit the Wake Period Water Temperature

Step 8: Using the **UP** (increase water temperature) or **DOWN** (decrease water temperature) buttons, select the Wake period desired water temperature. This is shown in Figure 82.

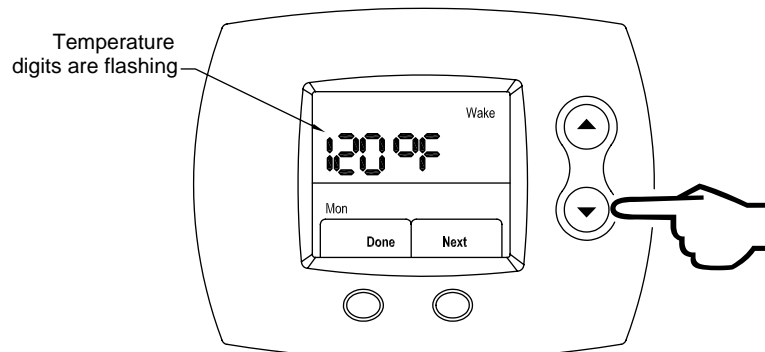

Figure 82

Lock in the Wake Period Water Temperature

Step 9: Press the **RIGHT** (Next) button to lock in the Wake period water temperature, as shown in Figure 83. Now, the Wake time period is set for the day being edited.

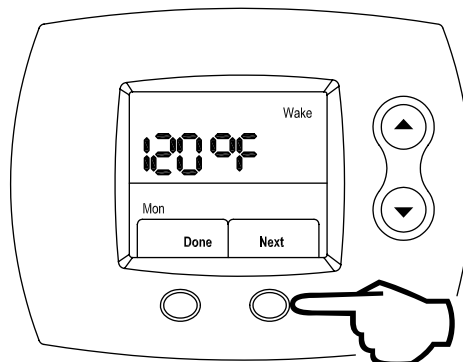

Figure 83

Edit the Leave Period Start Time

Step 10: Press the **UP** (increase time by 15 minutes) or **DOWN** (decrease time by 15 minutes) buttons to edit the Leave period start time. The time increments in 15-minute intervals just as it did for the Wake period. This is shown in Figure 84.

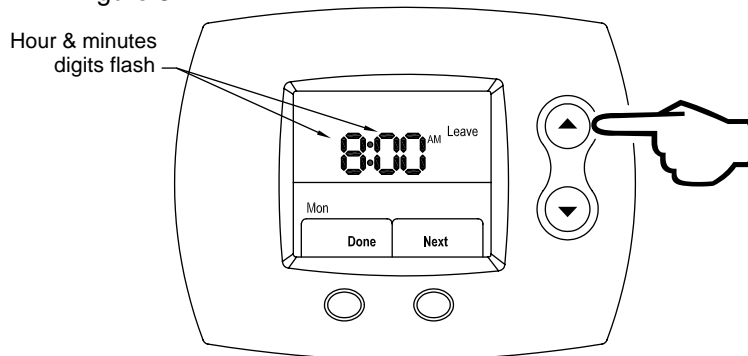

Figure 84

Lock in the Leave Period Start Time

Step 11: Press the **RIGHT** (Next) button to lock in the Leave period start time, which is shown in Figure 85.

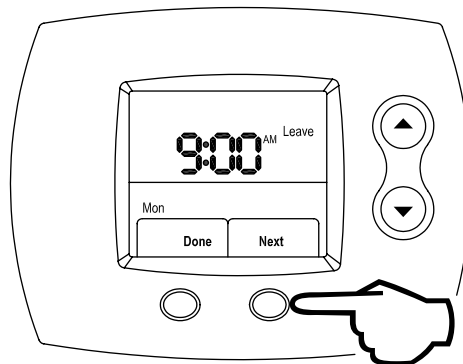

Figure 85

Edit AM / PM

Step 12: Next, using the **UP** (index AM / PM) or **DOWN** (index AM / PM) buttons, select AM / PM, as shown in Figure 86.

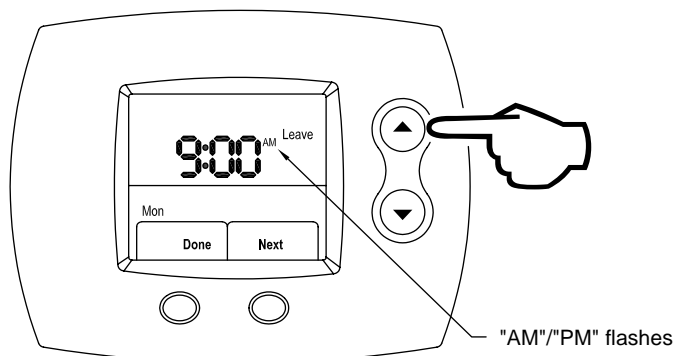

Figure 86

Editing the Setback Schedule

Lock in AM / PM

Step 13: Press the **RIGHT** (Next) button to lock in AM / PM. This is shown in Figure 87.

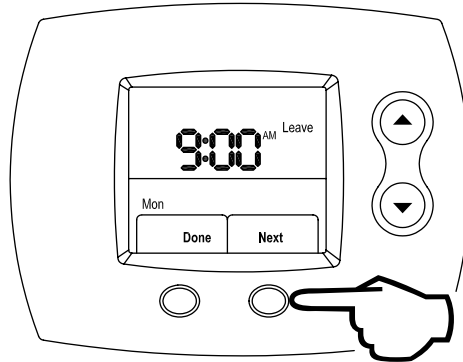

Figure 87

Edit the Leave Period Water Temperature

Step 14: Using the **UP** (increase water temperature) or **DOWN** (decrease water temperature) buttons, set the Leave period desired water temperature. This is shown in Figure 88.

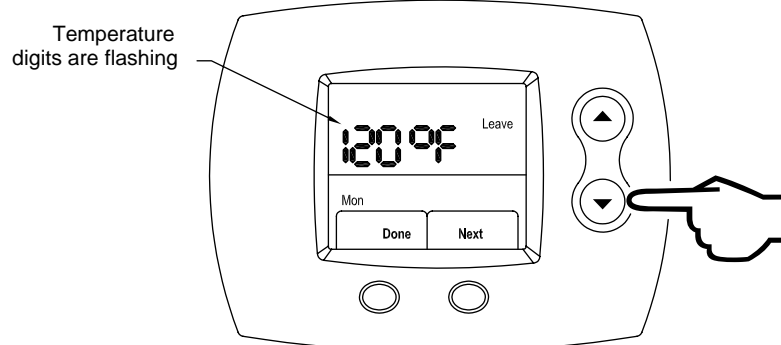

Figure 88

Lock in the Leave Period Water Temperature

Step 15: Press the **RIGHT** (Next) button to lock in the Leave period water temperature, as shown in Figure 89. Now, the Leave time period is set for the day being edited.

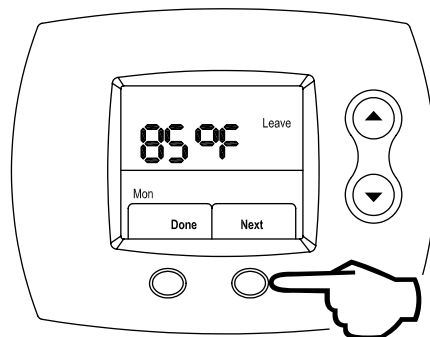

Figure 89

Edit the Return Period Start Time

Step 16: Press the **UP** (increase time by 15 minutes) or **DOWN** (decrease time by 15 minutes) buttons to edit the time that this period becomes active. The time increments in 15-minute intervals just as it did for the Wake period. This is shown in Figure 90.

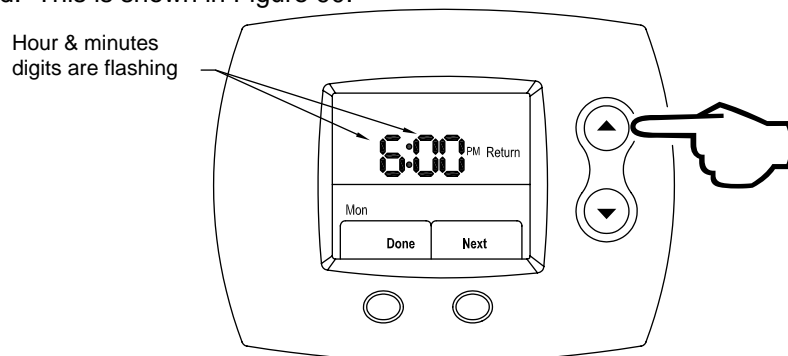

Figure 90

Lock in the Return Period Start Time

Step 17: Press the **RIGHT** (Next) button to lock in the Return period start time, which is shown in Figure 91.

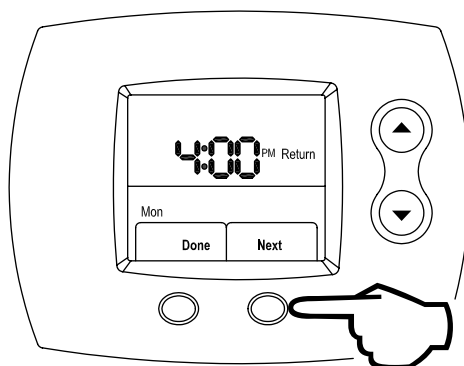

Figure 91

Edit AM / PM

Step 18: Next, using the **UP** (index AM / PM) or **DOWN** (index AM / PM) buttons, select AM / PM, as shown in Figure 92.

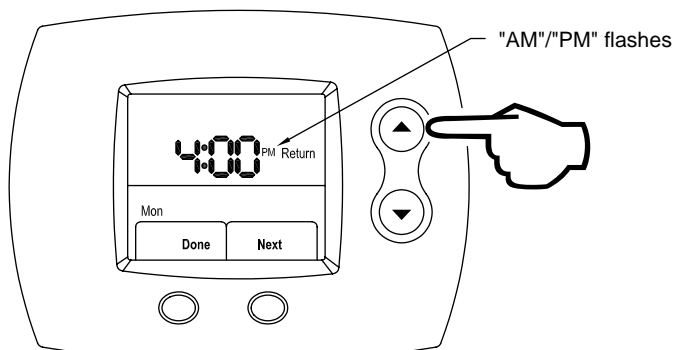

Figure 92

Editing the Setback Schedule

Lock in AM / PM

Step 19: Press the **RIGHT** (Next) button to lock in AM / PM. This is shown in Figure 93.

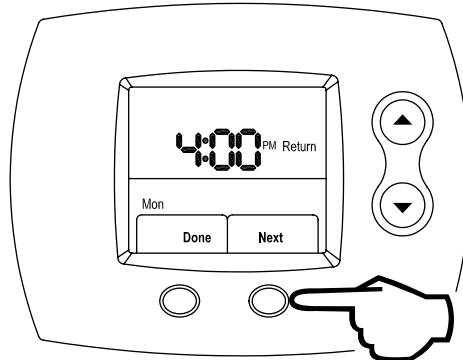

Figure 93

Edit the Return Period Water Temperature

Step 20: Using the **UP** (increase water temperature) or **DOWN** (decrease water temperature) buttons, select the Return period desired water temperature. This is shown in Figure 94.

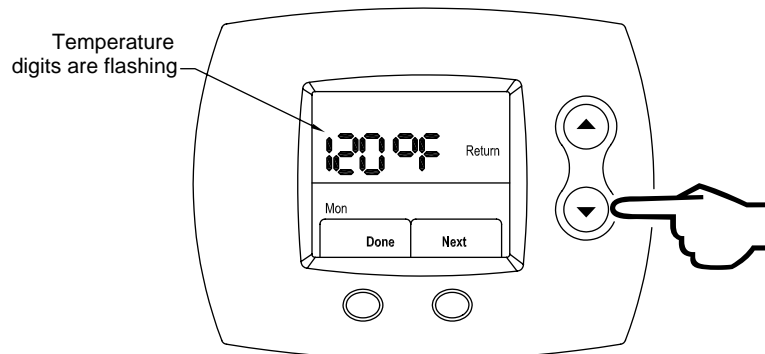

Figure 94

Lock in Return Period Water Temperature

Step 21: Press the **RIGHT** (Next) button to lock in the Return period water temperature, as shown in Figure 95. Now, the Return time period is set for day being edited.

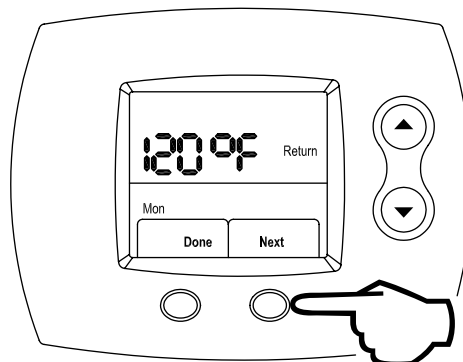

Figure 95

Edit the Sleep Period Start Time

Step 22: Press the **UP** (increase time by 15 minutes) or **DOWN** (decrease time by 15 minutes) buttons to edit the Sleep period start time. The time increments in 15-minute intervals just as it did for the previous periods. This is shown in Figure 96.

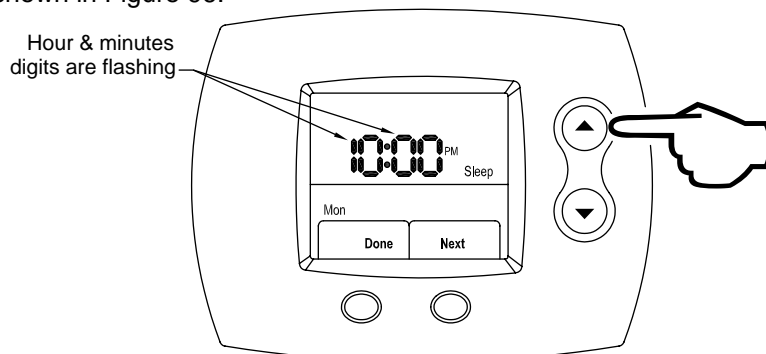

Figure 96

Lock in the Sleep Period Start Time

Step 23: Press the **RIGHT** (Next) button to lock in the Sleep period time, which is shown in Figure 97.

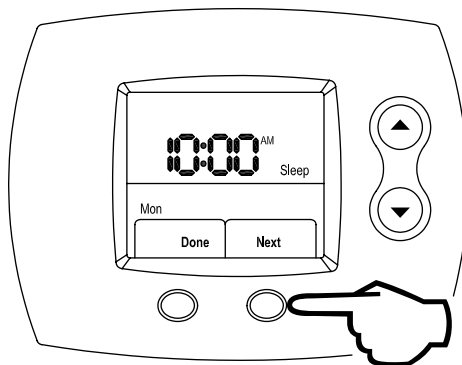

Figure 97

Edit AM / PM

Step 24: Next, using the **UP** (index AM / PM) or **DOWN** (index AM / PM) buttons, select AM / PM, as shown in Figure 98.

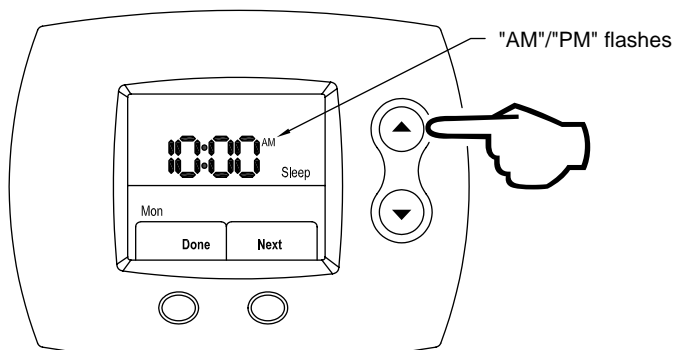

Figure 98

Editing the Setback Schedule

Lock in AM / PM

Step 25: Press the **RIGHT** (Next) button to lock in AM / PM. This is shown in Figure 99.

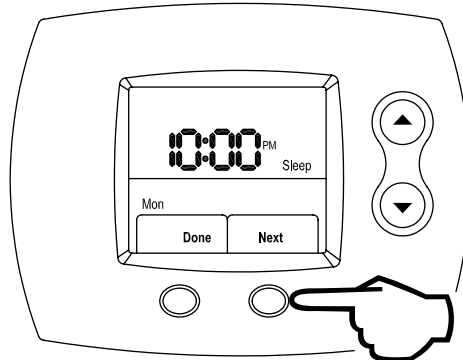

Figure 99

Edit the Sleep Period Water Temperature

Step 26: Using the **UP** (increase water temperature) or **DOWN** (decrease water temperature) buttons, select the Sleep period desired water temperature. This is shown in Figure 100.

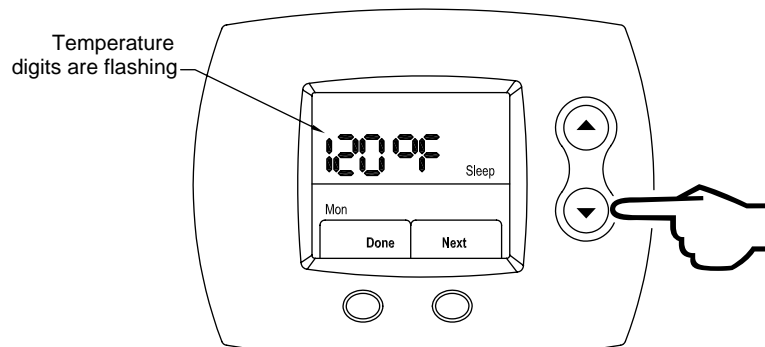

Figure 100

Lock in the Sleep Period Water Temperature

Step 27: Press the **RIGHT** (Next) button, as shown in Figure 101. Now, the Sleep time period is set for the day being edited. This completes the editing of one day of the Setback schedule. To change the schedule for the remaining days of the week, repeat the procedures beginning at Step 2 on page 40, for Tuesday through Sunday schedules. Otherwise, proceed to Step 28.

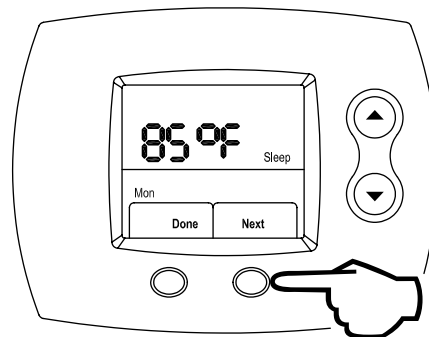

Figure 101

Exiting the Edit Schedule Mode

Step 28: When you are finished editing the Setback schedule, press the **LEFT** (Done) button to exit the Schedule editing mode, as shown in Figure 102. You will now return to the HOME screen.

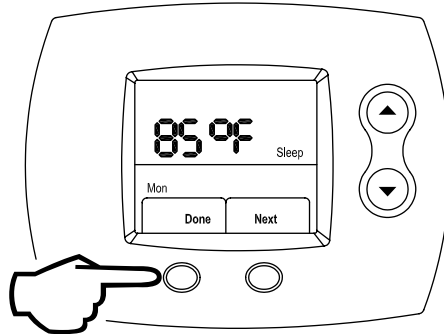

Figure 102

Setting a Temporary Temperature Hold

If an alternate water temperature is required for a short period of time, follow the instructions in this section to temporarily modify the Setback set water temperature.

Setting a New Water Temperature

Step 1: From the Home screen, press the **UP** (increase water temperature) or **DOWN** (decrease water temperature) buttons until the new desired water temperature is shown. This is shown in Figure 103.

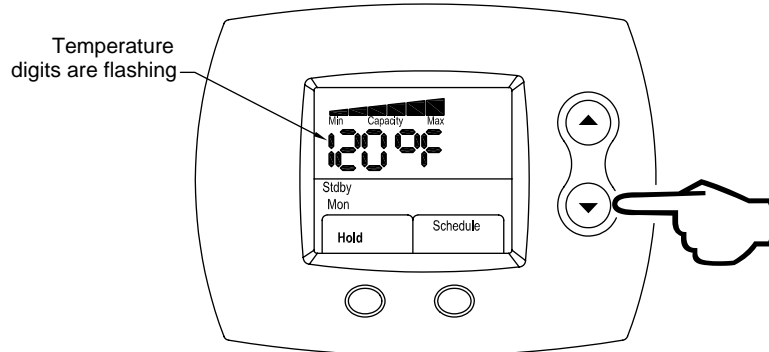

Figure 103

Display of Temporary Hold Water Temperature

Step 2: A temporary hold will maintain the water heater setpoint at the new setting for two hours. Then, the Setback Control will revert back to its programmed schedule. When the Setback Control is in a temporary hold, the "Hold," in the lower left corner of the display, will be flashing. This is shown in Figure 104.

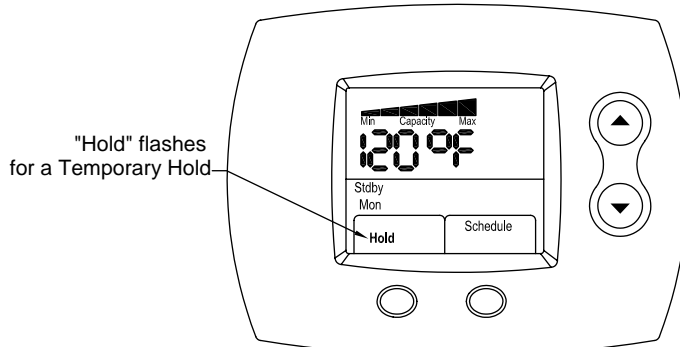

Figure 104

Exiting a Temporary Hold

Step 3: To manually exit a Temporary Hold, press the **RIGHT** (Schedule) button, as shown in Figure 105.

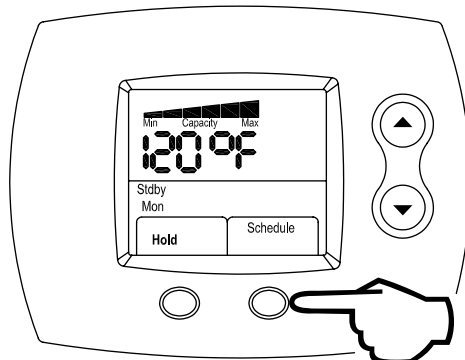

Figure 105

Setting a Permanent Temperature Hold

If an alternate water temperature is required for an indefinite amount of time, follow the instructions in this section to modify the Setback water temperature for an open ended amount of time.

Setting a New Water Temperature

Step 1: From the Home screen, press the **UP** (increase water temperature) or **DOWN** (decrease water temperature) buttons until the new desired water temperature is shown. This is shown in Figure 106.

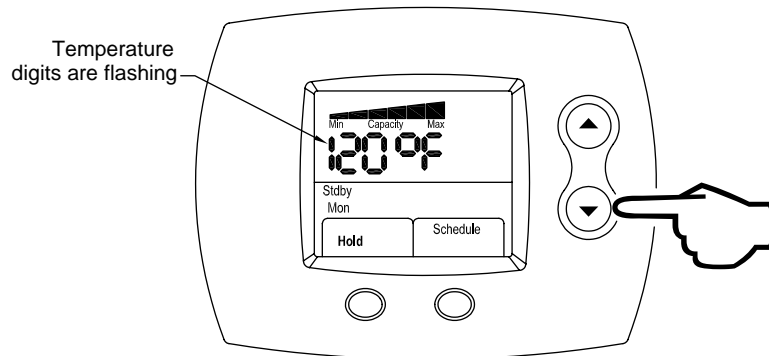

Figure 106

Display of Permanent Hold Water Temperature

Step 2: A permanent hold will maintain the water heater setpoint at the new setting indefinitely. Press the **LEFT** (Hold) button to establish a permanent hold. When the Setback Control is in a permanent hold, the "Hold," in the lower left corner of the display, will be shown continuously (not flashing). This is shown in Figure 107.

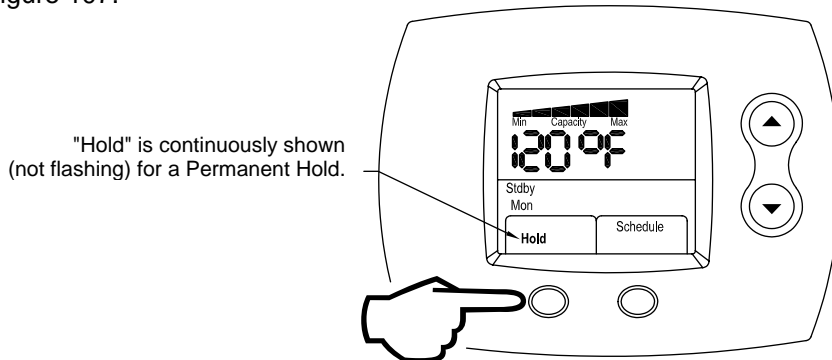

Figure 107

Exiting a Permanent Hold

Step 3: To exit a Permanent Hold, press the **RIGHT** (Schedule) button, as shown in Figure 108.

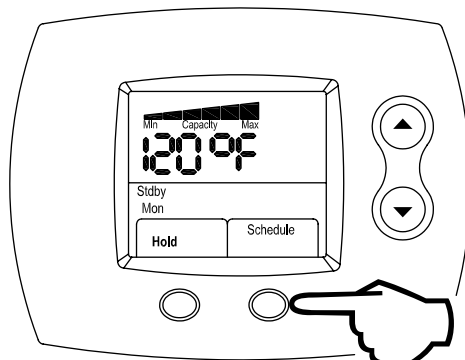

Figure 108

Editing the Clock / Day

This section covers how to change the Setback Control clock, as well as the day. This may become useful when time changes for daylight savings.

Enter Clock / Day Editing Mode

Step 1: From the Home screen, press the **LEFT** (Set Clock / Day) button, as shown in Figure 109.

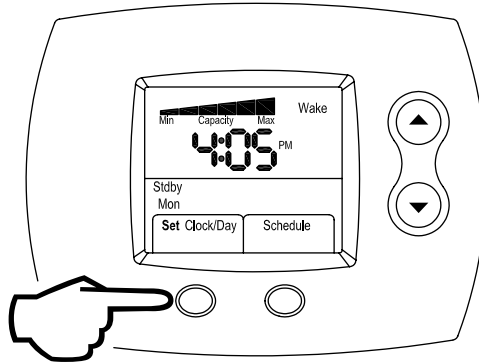

Figure 109

Select Correct Hour

Step 2: Using the **UP** (increase hour) or **DOWN** (decrease hour) buttons, select the correct hour. This is shown in Figure 110.

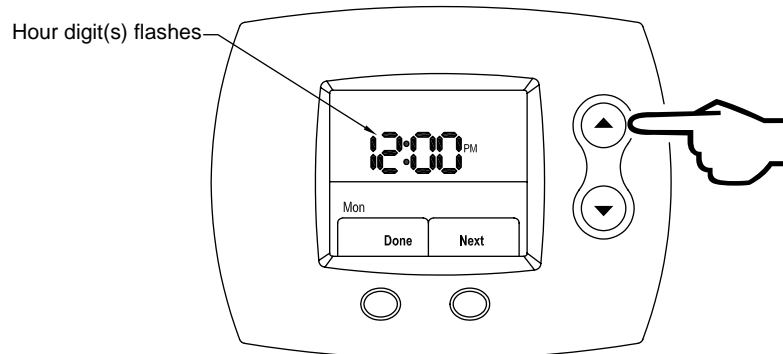

Figure 110

Lock in Correct Hour

Step 3: Press the **RIGHT** (Next) button to set the hour, which is shown in Figure 111.

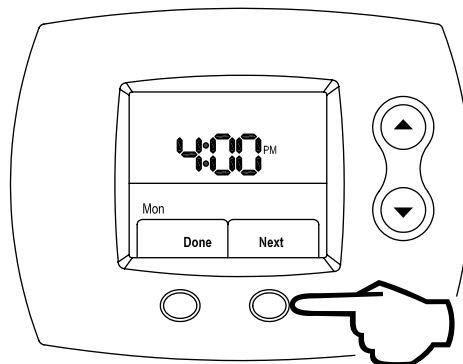

Figure 111

Select Correct Minute

Step 4: Using the **UP** (increase minute) or **DOWN** (decrease minute) buttons, adjust the minute until the correct one is shown. This process is shown in Figure 112.

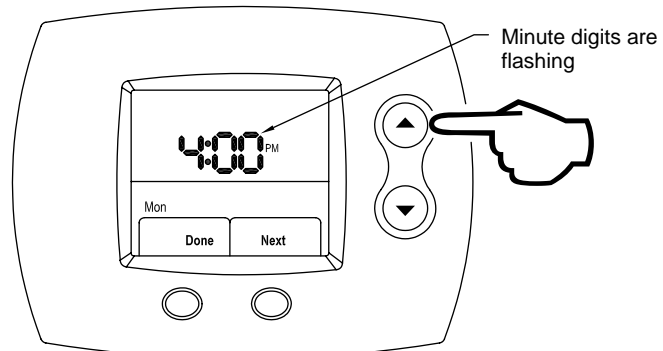

Figure 112

Lock in Correct Minute

Step 5: Press the **RIGHT** (Next) button to set the minute, which is shown in Figure 113.

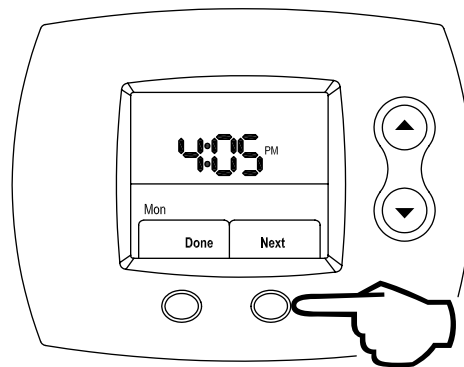

Figure 113

Select AM / PM

Step 6: Using the **UP** (index AM / PM) or **DOWN** (index AM / PM) buttons, select AM / PM, as shown in Figure 114.

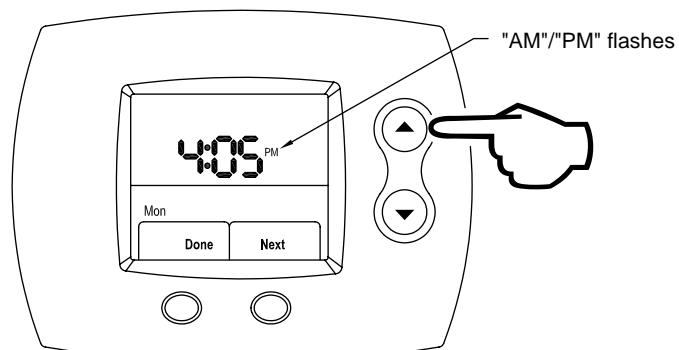

Figure 114

Editing the Clock / Day

Lock in AM / PM

Step 7: Press the **RIGHT** (Next) button to proceed, which is shown in Figure 115.

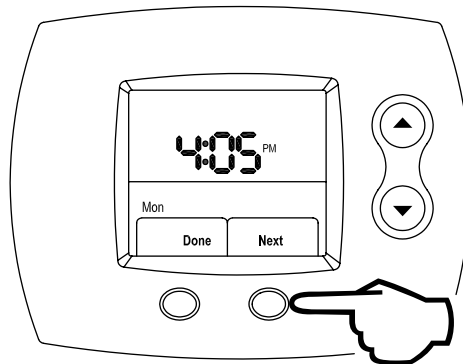

Figure 115

Select Correct Day

Step 8: Using the **UP** (increase day) or **DOWN** (decrease day) buttons, select the correct day. This process is shown in Figure 116.

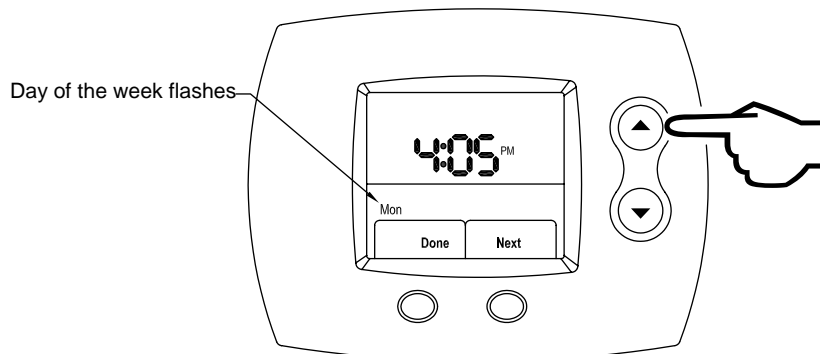

Figure 116

Lock in Correct Day & Complete Editing Clock / Day Mode

Step 9: Press the **LEFT** (Done) button, which is shown in Figure 117. This completes the procedure for editing the Setback clock and day.

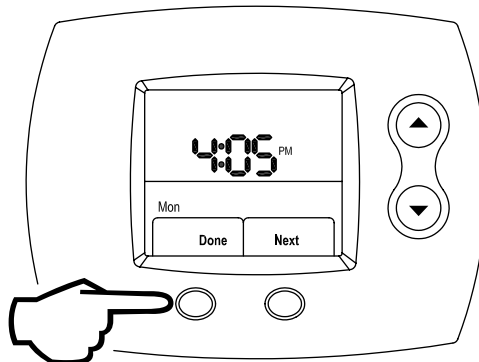

Figure 117

Sabbath Time Period Editing

In order to comply with the Sabbath, follow the instructions in this section to modify the Setback schedule. Please consult your local rabbi for recommended water temperatures and appropriate times for the Sabbath.

Enter Sabbath Time Period Editing

Step 1: From the Home screen, press the **RIGHT** (Schedule) button, as shown in Figure 118.

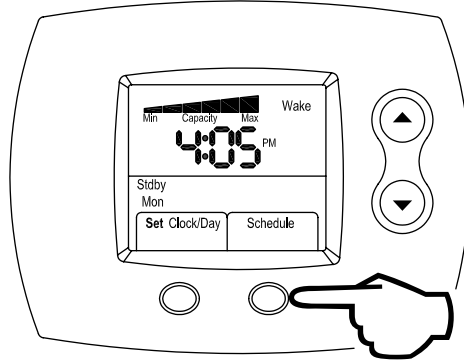

Figure 118

Select the Day to Edit

Step 2: Monday is the first day that is shown flashing initially. Using the **UP** (increase day) or **DOWN** (decrease day) buttons, scroll until Friday is shown. This is shown in Figure 119.

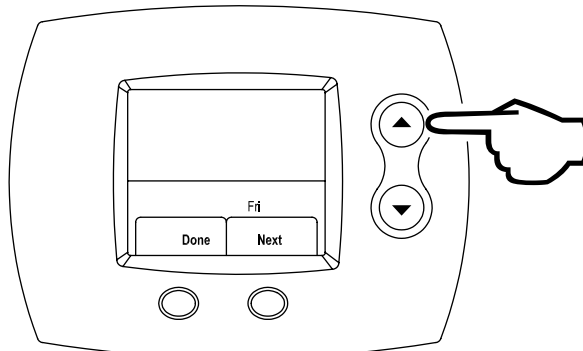

Figure 119

Start Editing Friday

Step 3: Press the **RIGHT** (Next) button to edit the schedule water temperatures and times. This is shown in Figure 120.

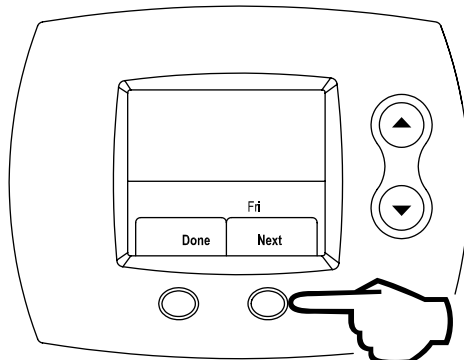

Figure 120

Sabbath Time Period Editing

Edit the Wake Period Start Time

Step 4: Press the **UP** (increase time by 15 minutes) or **DOWN** (decrease time by 15 minutes) buttons until the wanted time is shown. This is shown in Figure 121.

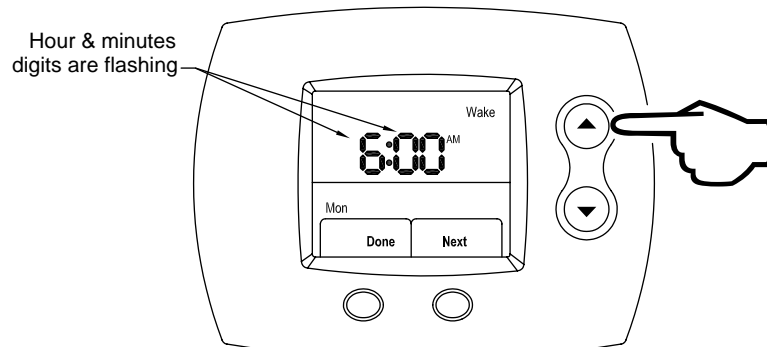

Figure 121

Lock in Wake Period Start Time

Step 5: Press the **RIGHT** (Next) button to lock in the Wake period start time, as shown in Figure 122.

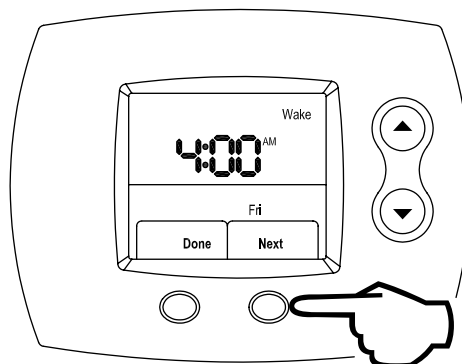

Figure 122

Edit AM / PM

Step 6: Next, using the **UP** (index AM / PM) or **DOWN** (index AM / PM) buttons, select AM / PM. This is shown in Figure 123.

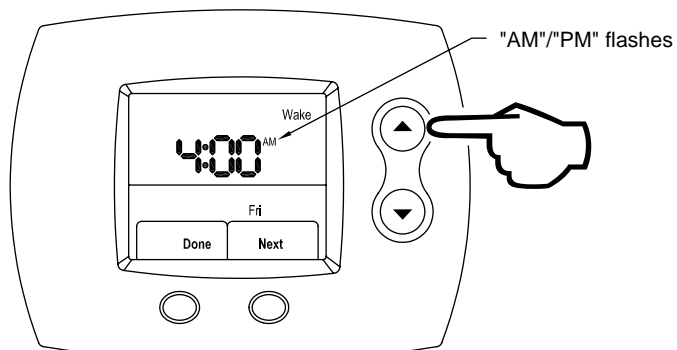

Figure 123

Lock in AM / PM

Step 7: Press the **RIGHT** (Next) button to lock in AM / PM. This is shown in Figure 124.

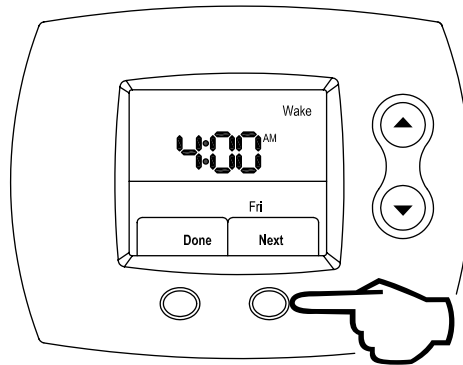

Figure 124

Edit the Wake Period Water Temperature

Step 8: Using the **UP** (increase water temperature) or **DOWN** (decrease water temperature) buttons, select the Wake period desired water temperature. This is shown in Figure 125.

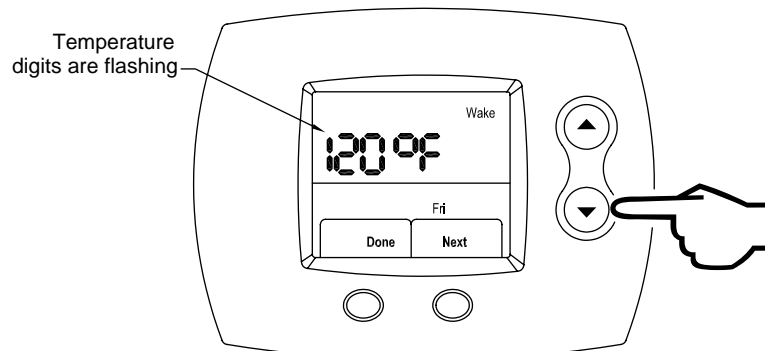

Figure 125

Lock in Wake Period Water Temperature

Step 9: Press the **RIGHT** (Next) button to lock in the Wake period water temperature, as shown in Figure 126. Now, the Wake time period is set for the day being edited.

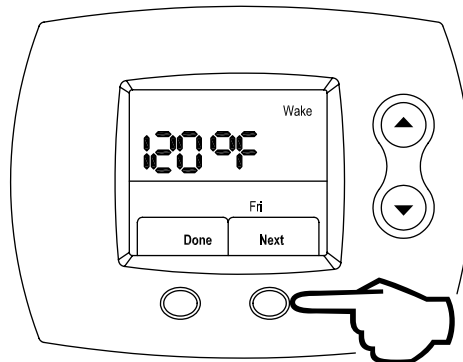

Figure 126

Sabbath Time Period Editing

Edit the Leave Period Start Time

Step 10: Press the **UP** (increase time by 15 minutes) or **DOWN** (decrease time by 15 minutes) buttons to edit the Leave period start time. The time increments in 15-minute intervals just as it did for the Wake period. This is shown in Figure 127.

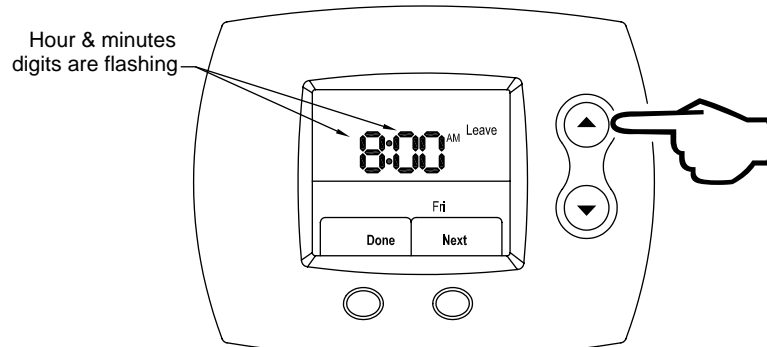

Figure 127

Lock in Leave Period Start Time

Step 11: Press the **RIGHT** (Next) button to lock in the Leave period start time, which is shown in Figure 128.

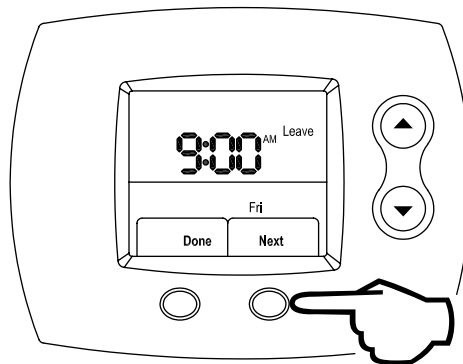

Figure 128

Edit AM / PM

Step 12: Next, using the **UP** (index AM / PM) or **DOWN** (index AM / PM) buttons, edit AM / PM, as shown in Figure 129.

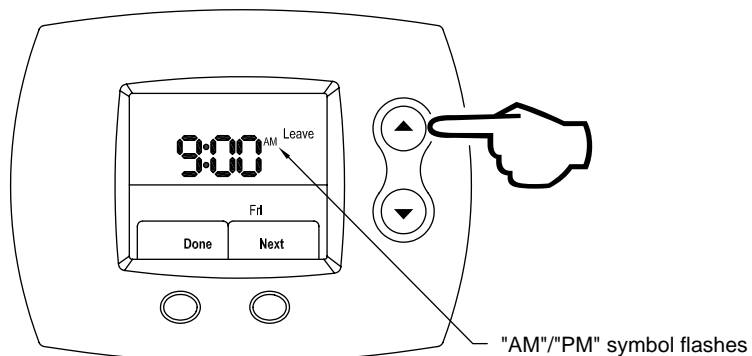

Figure 129

Lock in AM / PM

Step 13: Press the **RIGHT** (Next) button to lock in AM / PM. This is shown in Figure 130.

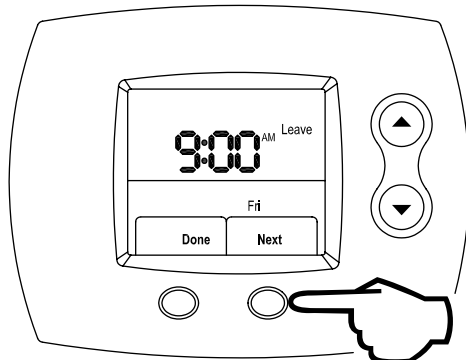

Figure 130

Edit Leave Period Water Temperature

Step 14: Using the **UP** (increase water temperature) or **DOWN** (decrease water temperature) buttons, select the Leave period desired water temperature. This is shown in Figure 131.

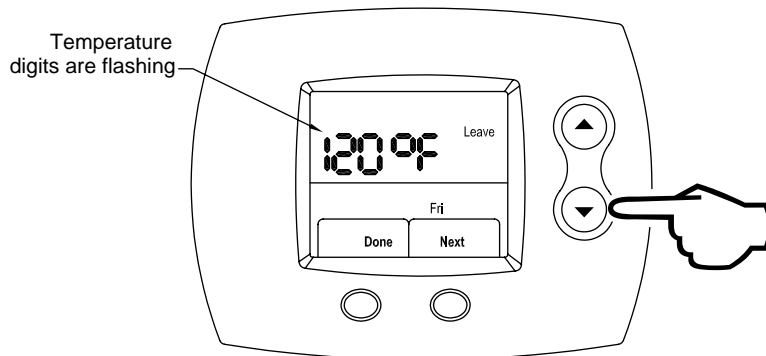

Figure 131

Lock in Leave Period Water Temperature

Step 15: Press the **RIGHT** (Next) button to lock in the Leave period water temperature, as shown in Figure 132. Now, the Leave time period is set for Friday.

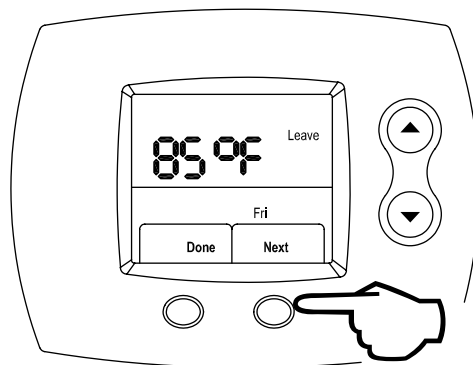

Figure 132

Sabbath Time Period Editing

Edit the Return Period Start Time

Step 16: Press the **UP** (increase time by 15 minutes) or **DOWN** (decrease time by 15 minutes) buttons to edit the time the Return period start time. The time increments in 15-minute intervals just as it did for the Wake period. This is shown in Figure 133.

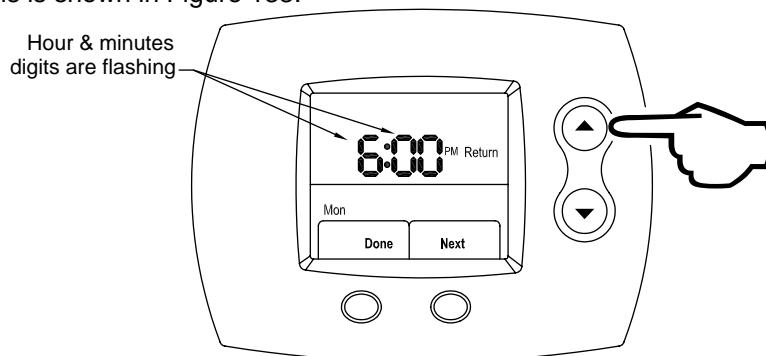

Figure 133

Lock in Return Period Start Time

Step 17: Press the **RIGHT** (Next) button to lock in the Return period start time, which is shown in Figure 134.

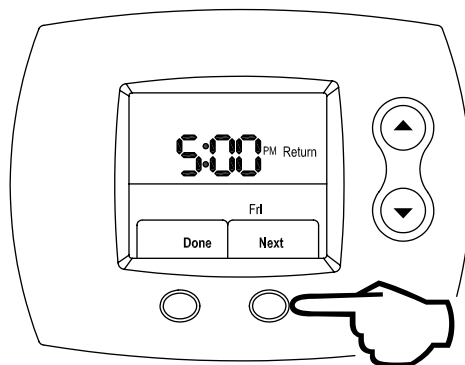

Figure 134

Edit AM / PM

Step 18: Next, using the **UP** (index AM / PM) or **DOWN** (index AM / PM) buttons, select AM / PM, as shown in Figure 135.

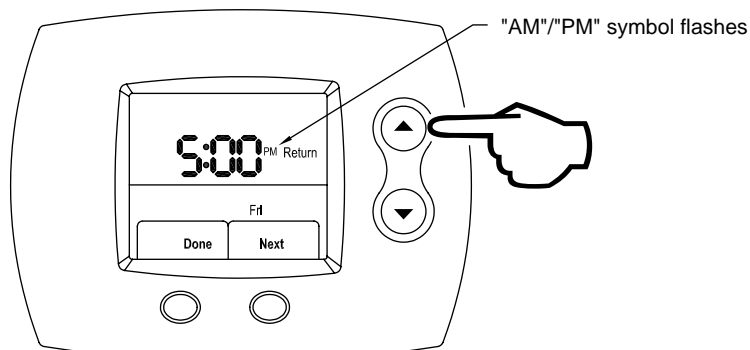

Figure 135

Lock in AM / PM

Step 19: Press the **RIGHT** (Next) button to lock in AM / PM. This is shown in Figure 136.

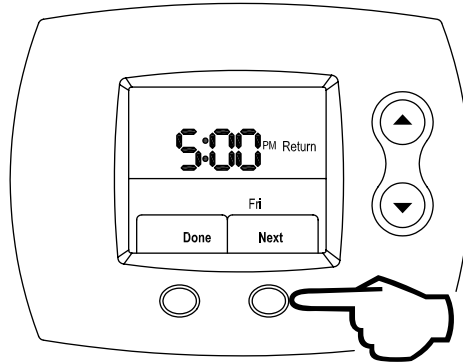

Figure 136

Edit Return Period Water Temperature

Step 20: Using the **UP** (increase water temperature) or **DOWN** (decrease water temperature) buttons, select the Return period desired water temperature. This is shown in Figure 137.

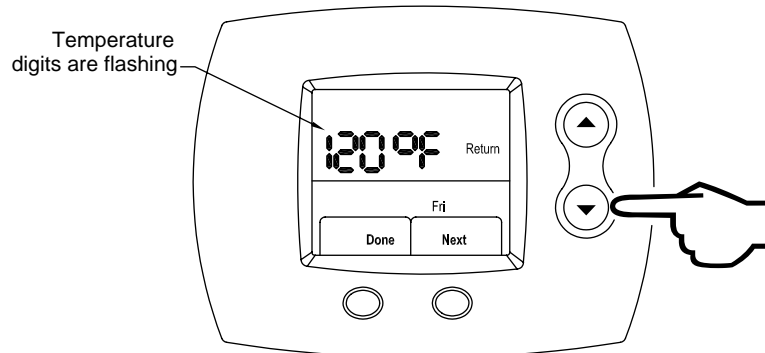

Figure 137

Lock in Return Period Water Temperature

Step 21: Once the water temperature for the Return time period is selected, press the **RIGHT** (Next) button to lock in the Return period water temperature, as shown in Figure 138. Now, the Return time period is set for day being edited.

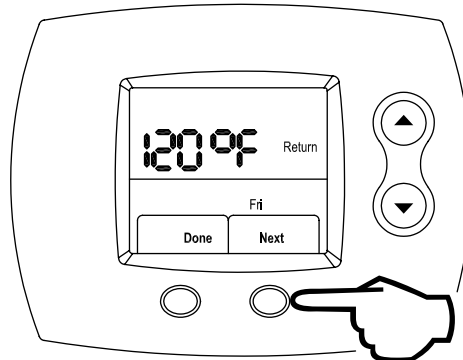

Figure 138

Sabbath Time Period Editing

Edit Sleep Period Start Time

Step 22: Press the **UP** (increase time by 15 minutes) or **DOWN** (decrease time by 15 minutes) buttons to edit the Sleep period start time. The time increments in 15-minute intervals just as it did for the previous periods. This is shown in Figure 139.

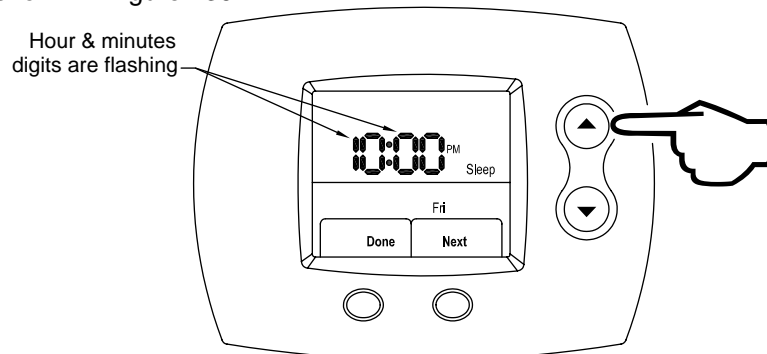

Figure 139

Lock in Sleep Period Start Time

Step 23: Press the **RIGHT** (Next) button to lock in the Sleep period start time, which is shown in Figure 140.

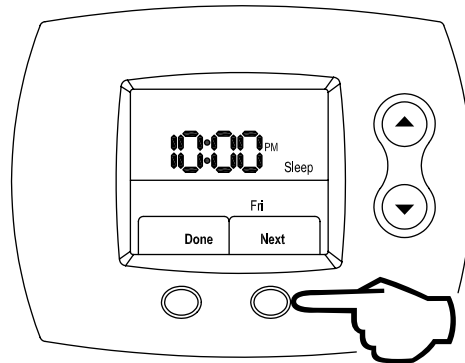

Figure 140

Edit AM / PM

Step 24: Next, using the **UP** (index AM / PM) or **DOWN** (index AM / PM) buttons, select AM / PM, as shown in Figure 141.

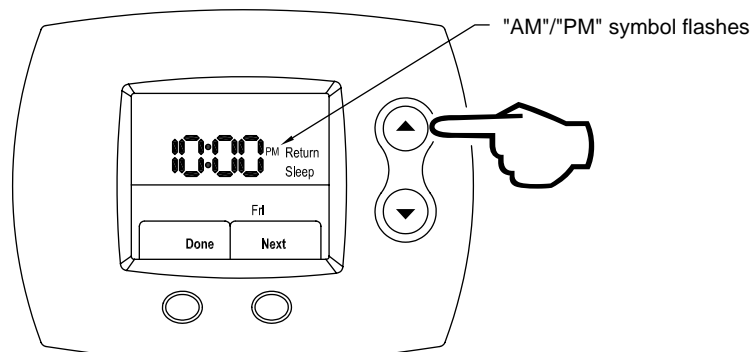

Figure 141

Lock in AM / PM

Step 25: Press the **RIGHT** (Next) button to lock in AM / PM. This is shown in Figure 142.

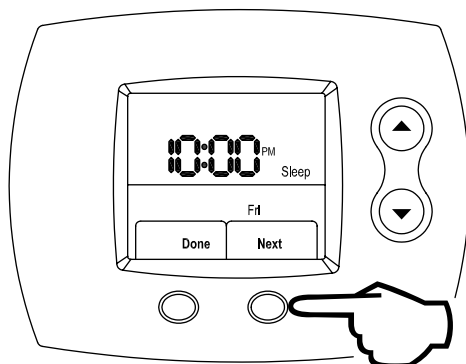

Figure 142

Edit the Sleep Period Water Temperature

Step 26: Using the **UP** (increase water temperature) or **DOWN** (decrease water temperature) buttons, select the Sleep period desired water temperature. This is shown in Figure 143.

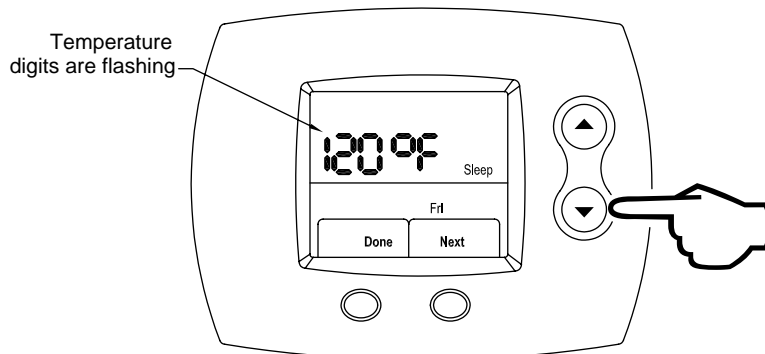

Figure 143

Lock the Sleep Period Water Temperature

Step 27: Press the **RIGHT** (Next) button to lock in the Sleep period water temperature, as shown in Figure 144. Now, the Sleep time period is set for Friday.

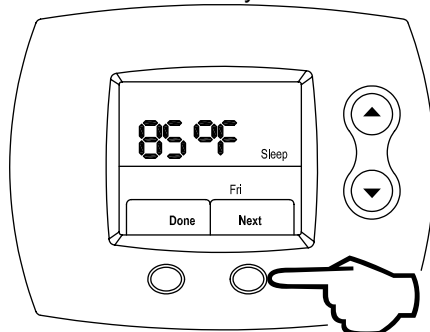

Figure 144

Sabbath Time Period Editing

Continuing with Sabbath Time Period Editing

To edit the schedule for Saturday, return to Step 2 on page 55 and follow the same procedure. When you are finished changing the Setback schedule, press the **LEFT** (Done) button, as shown in Figure 145.

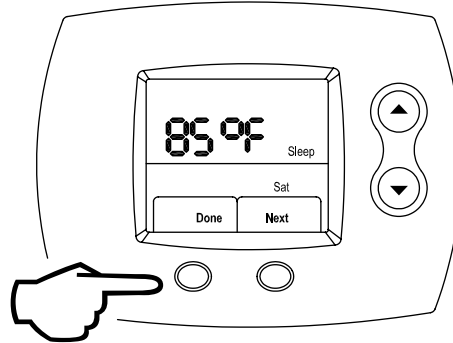

Figure 145

Diagnostic Codes

In this section, the table details what the diagnostic codes on the Setback Control mean. The diagnostic codes that can be displayed are different and depend on the gas valve / control that is connected to the Setback Control.

Diagnostic Code #	Description	Gas Valve / Control Model				
		S9360B	S9380B	Accessory Module	WV8840 (standing pilot gas control)	WV4460E (intermittent pilot gas control)
Conn	Setback Control not connected to gas valve / control or improperly wired together.	x	x	x	x	x
2	Pressure switch failed to open (stuck closed).	x	x			x
4	Weak pilot signal detected.	x	x			x
6	Pilot signal detected out of sequence.	x	x			x
18	Internal gas valve fault detected.	x	x	x	x	
20	Failed to light pilot.					x
23	Pilot signal detected out of sequence (before it should).	x	x			x
24	Pilot signal detected out of sequence (after it should).	x	x			x
29	Pressure switch failed to close (stuck open).	x	x			x
31	Upper tank sensor out of specification.	x	x			
32	Lower tank sensor out of specification.	x	x		x	x
55	Damper failed to close (stuck open).	x	x			
56	Damper failed to open (stuck closed).	x	x			
57	False ground in pilot assembly detected. Replace pilot assembly.	x	x			
58	Internal gas valve fault detected.	x	x			
59	Line voltage out of acceptable range.	x	x			
60	Wiring issue, transformer out of phase.	x	x			
61	Internal gas valve fault detected.	x	x			
62	Ignition failed, maximum number of tries. Soft lockout.	x	x			
63	Ignition successful, but flame lost during run cycle. Soft lockout.	x	x			x
64	Internal gas valve fault detected.	x	x			x
65	Excessive tank temperature.	x	x			
85	Soft Lockout due to maximum number of recycles exceeded, last recycle was from pressure switch open					x
87	A manual reset is required due to Rollout Limit					x
89	Equipment missing or improperly wired together.			x		
93	Internal gas valve fault detected.				x	x
95	Flammable vapor sensor fault detected, see warning label.					x
96	Flammable vapor sensor out of specification, possible short.					x
143	Water heater tank leak detected.			x		
145	Leak sensor improperly installed or leak sensor resistor missing.			x		

Notes



Ambler, PA

For U.S. and Canada field service,
contact your professional installer or
local Bradford White sales representative.

Sales/800-523-2931
Fax/215-641-1670
Parts Fax/215-641-2108

Technical Support/800-334-3393
Fax/269-795-1089

Warranty/800-531-2111
Fax/269-795-1089

International:
Telephone/215-641-9400
Telefax/215-641-9750



Mississauga, ON

Sales/866-690-0961
905-238-0100

Fax/905-238-0105

Technical Support/800-334-3393

Email:
parts@bradfordwhite.com
techserv@bradfordwhite.com

www.bradfordwhite.com

Free Manuals Download Website

<http://myh66.com>

<http://usermanuals.us>

<http://www.somanuals.com>

<http://www.4manuals.cc>

<http://www.manual-lib.com>

<http://www.404manual.com>

<http://www.luxmanual.com>

<http://aubethermostatmanual.com>

Golf course search by state

<http://golfingnear.com>

Email search by domain

<http://emailbydomain.com>

Auto manuals search

<http://auto.somanuals.com>

TV manuals search

<http://tv.somanuals.com>