

The Bradford White  
**DEFENDER**  
SAFETY SYSTEM®

**Flammable Vapor Ignition Resistant Water Heater**



# SERVICE MANUAL

## Troubleshooting Guide and Instruction for Service

(To be performed ONLY by qualified service providers)

### For the Bradford White Defender Safety System® Models:

MI30T*F(BN,CX)	M430T*F(BN,CX)
MI30S*F(BN, CX)	M440T*F(BN, CX)
MI303T*F(BN,CX)	M4403S*F(BN,CX)
MI40T*F(BN,CX)	M4403T*F(BN,CX)
MI403S*F(BN,CX)	M450S*F(BN,CX)
MI404T*F(BN,CX)	M4503*F(BN,CX)
MI503*F(BN,CX)	M460T*F(BN,CX)
MI50L*F(BN,CX)	M1XR403S*F(BN,CX)
MI504S*F(BN,CX)	M1XR504T*F(BN,CX)
MI60T*F(BN,CX)	M2XR504T*F(BN,CX)
	M2C504T*F(BN,CX)
	50T65F(BN,CX)

(\* Denotes Warranty Years.

**Save this manual for future reference**

## Table of Contents

	<u>Page</u>	<u>Service Procedure</u>
Introduction	3	---
Trouble shooting Chart	4	---
Inner Door Gasket Removal, Inspection, Replacement and Installation	5	RG-I
Thermocouple Testing and Replacement	8	RG-II
Pilot Assembly Inspection Cleaning and Replacement	10	RG-III
Piezo Igniter and Electrode Testing	11	RG-IV
Combination Thermostat/Gas Valve Testing and Replacement	12	RG-V
Burner Operation Inspection, Adjustment, Cleaning and Replacement	17	RG-VI
Resettable Thermal Switch Testing and Replacement	20	RG-VII
ScreenLok® Flame Arrestor Cleaning	22	RG-VIII
Dip Tube and Anode Inspection and Replacement	23	RG-IX
Generic Parts List	25	---

### **The Bradford White DEFENDER Safety System®**

The Bradford White DEFENDER Safety System® was designed to resist the ignition of flammable vapors that can occur outside of the water heater. Use and installation are nearly identical to previous versions of atmospherically fired and vented water heaters. A number of exclusive design features are incorporated in the system that will require additional knowledge on the part of the qualified service provider. The following information will instruct service professionals on the function, proper diagnosis and repair of water heaters employing the Bradford White DEFENDER Safety System®.

### **How the Safety System Works**

During normal operation, air for combustion is drawn into the water heater through the opening in the jacket. This air travels down and around the combustion chamber and enters through holes in the very bottom of the corrosion-resistant combustion chamber. The air then travels up through the oriented flame arrester plate louvers, where the velocity of the air is increased and its direction altered. The air then mixes in a normal manner with the supplied gas and is efficiently combusted, producing very low NOx emissions.

In the case where trace amounts of flammable vapors are present in the air flowing into the combustion chamber, the vapors are harmlessly ignited by the burner / pilot flame. If flammable vapors are in sufficient quantity to prevent normal combustion, the burner/pilot flame is shut down.

Should the flammable vapors continue to the burner, the flame arrester plate prevents the flames from traveling backwards and igniting vapors outside of the combustion chamber. The calibrated, multipurpose thermal switch recognizes this and shuts down the pilot and main burner. This switch also deactivates the burner and pilot in the unlikely event of restricted airflow caused by severe lint, dust or oil accumulation on the arrester plate.

**TROUBLESHOOTING CHART**  
Flammable Vapor Ignition Resistant Water Heaters

<b><u>SYMPTOM</u></b>	<b><u>PROBABLE CAUSE</u></b>	<b><u>CORRECTIVE ACTION</u></b>	<b><u>SERVICE PROCEDURE</u></b>
Pilot Will Not Light	<ol style="list-style-type: none"> <li>1. No incoming gas or too low gas pressure.</li> <li>2. Gas control knob set to wrong position.</li> <li>3. Pilot light button not being fully depressed when attempting to light pilot.</li> <li>4. Pilot orifice or pilot tube is obstructed or kinked.</li> <li>5. Pilot electrode not sparking to pilot.</li> <li>6. Piezo igniter not functioning.</li> </ol>	<ol style="list-style-type: none"> <li>1. Turn on gas supply and/or check line pressure.</li> <li>2. Review lighting instruction. Set combination/thermostat gas valve to correct position.</li> <li>3. Review lighting instruction. Fully depress pilot lighting button.</li> <li>4. Clean, repair or replace.</li> <li>5. Verify correct electrode position. Replace pilot assembly.</li> <li>6. Replace Piezo igniter.</li> </ol>	<ol style="list-style-type: none"> <li>1. See Service Procedure RG-V, Page 12.</li> <li>4. See Service Procedure RG-III, Page 10.</li> <li>5. See Service Procedure RG-III, Page 10.</li> <li>6. See Service Procedure RG-IV, Page 11.</li> </ol>
Pilot Will Not stay lit when button is released	<ol style="list-style-type: none"> <li>1. Poor thermocouple connection at combination thermostat/gas valve.</li> <li>2. Thermocouple not fully engaged in pilot assembly bracket.</li> <li>3. Pilot flame is not fully enveloping the thermocouple "hot" junction.</li> <li>4. Weak or defective thermocouple.</li> <li>5. Open ECO on combination thermostat/gas valve.</li> <li>6. Defective magnet in combination thermostat/gas valve.</li> <li>7. Resettable thermal switch has opened.</li> </ol>	<ol style="list-style-type: none"> <li>1. Check connection at combination thermostat/gas valve. Proper tightness should be finger tight plus ¼ turn.</li> <li>2. Inspect thermocouple to ensure that it is fully engaged into pilot bracket.</li> <li>3. Adjust tip of thermocouple to be fully engulfed by pilot flame.</li> <li>4. Check thermocouple and replace if necessary.</li> <li>5. Check ECO continuity and replace combination thermostat/gas valve if necessary.</li> <li>6. Check magnet operation and replace combination thermostat/gas valve if necessary.</li> <li>7. Determine cause of switch activation. To reset, depress button on resettable thermal switch located on inner door.</li> </ol>	<ol style="list-style-type: none"> <li>4. See Service Procedure RG-II, Page 8</li> <li>5. See Service Procedure RG-V, Page 14</li> <li>6. See Service Procedure RG-V, Page 13</li> </ol>
Pilot will light but the main burner will not come on	<ol style="list-style-type: none"> <li>1. Combination thermostat/gas valve set too low for desired water temperature.</li> <li>2. Combination thermostat/gas valve temperature is satisfied.</li> <li>3. Insufficient gas supply or low gas pressure.</li> <li>4. Combination thermostat/gas valve has wide differential or is out of calibration.</li> </ol>	<ol style="list-style-type: none"> <li>1. Adjust temperature dial on combination thermostat/gas valve.</li> <li>2. Check temperature dial setting on combination thermostat/gas valve.</li> <li>3. Check gas supply and line pressure.</li> <li>4. Check combination thermostat/gas valve for proper operation, replace if necessary.</li> </ol>	<ol style="list-style-type: none"> <li>2. See Installation &amp; operation manual.</li> <li>3. See Service Procedure RG-V, Page 12</li> <li>4. See Service Procedure RG-V, Page 12</li> </ol>
Pilot goes out periodically (after heating cycles, once a day, once a week etc.)	<ol style="list-style-type: none"> <li>1. Insufficient combustion air supply.</li> <li>2. Incorrect, clogged vent system/ vent terminal or location.</li> <li>3. Inconsistent gas supply or gas pressure.</li> </ol>	<ol style="list-style-type: none"> <li>1. Verify adequate combustion air is available to the unit. Check and clear Jacket slot openings of any dirt, dust, restrictions or other obstructions. Inspect flame arrestor plate and clean with stiff bristled brush and/or vacuum to remove any debris accumulation.</li> <li>2. Check venting for proper sizing and proper operation</li> <li>3. Check gas supply and line pressure.</li> </ol>	<ol style="list-style-type: none"> <li>1. See Service Procedure RG-VIII, Page 22</li> <li>3. See Service Procedure RG-V, Page 12</li> </ol>
Not enough hot water	<ol style="list-style-type: none"> <li>1. Combination thermostat/gas valve set too low for desired water temperature.</li> <li>2. Cold inlet water temperature is very cold.</li> <li>3. High demand periods.</li> <li>4. Incorrectly sized water heater for application.</li> <li>5. Combination thermostat/gas valve is out of calibration/not functioning.</li> <li>6. Out of spec dip tube is diluting hot water with cold water.</li> </ol>	<ol style="list-style-type: none"> <li>1. Check dial on combination thermostat/gas valve.</li> <li>2. Extremely cold water going into the heater will decrease the amount of hot water produced. It may be necessary to temper incoming water supply.</li> <li>3. Adjust high demand usage.</li> <li>4. Contact Plumbing professional.</li> <li>5. Check combination thermostat/gas valve for proper operation, replace if necessary.</li> <li>6. Inspect dip tube and replace if necessary.</li> </ol>	<ol style="list-style-type: none"> <li>5. See Service Procedure RG-V, Page 12</li> <li>6. See Service Procedure RG-IX, Page 23</li> </ol>

**Inner Door Removal Procedure**

- Step 1. Rotate knob of the combination thermostat/gas valve to the “OFF” position.
- Step 2. Remove outer jacket burner access door
- Step 3. Inner Door Removal.

For White Rodgers Control, depress knob slightly and rotate clockwise to the “OFF” position.

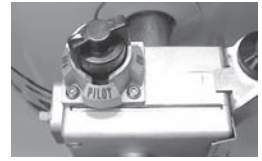

For Robertshaw Control, rotate knob clockwise to the “OFF” position.



- a) Disconnect resettable thermal switch wire leads (leading from combination thermostat/gas valve).
- b) Remove (2) 1/4" hex drive screws from right side inner door.
- c) Remove (2) 1/4" drive screws from flange section of inner door.
- d) Remove (2) 1/4" drive screws from left side inner door.
- e) Remove inner door and inspect per step 4.

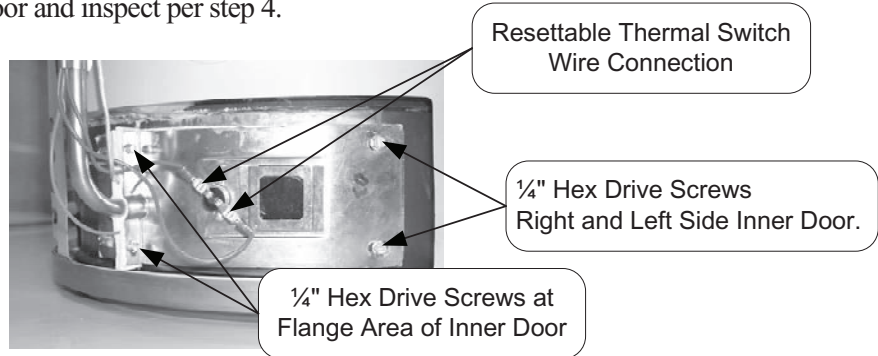

- Step 4. Fully inspect inner door gaskets for the following:
- >Tears
  - >Missing Material
  - >Cracks
  - >Dirt or debris
  - >Other imperfections that will inhibit proper seal
  - >Gasket adhesion to inner door
  - >Material left on combustion chamber (around opening)

If the gasket is not effected by any of the above, gasket replacement is not required. If replacement is required, proceed to **Inner Door Gasket Replacement Procedure.**

**Inner Door Gasket Replacement Procedure.**

**⚠ WARNING**  
**If the information in these instructions is not followed exactly, a fire or explosion may result causing property damage, personal injury or death.**

- Step 5. After inspection of inner door as noted in step 4, completely remove gasket and adhesive residue from right and left side inner doors as needed.
- Step 6. Use RTV sealant (recommended bead size 1/8") to secure the inner door gasket to the inner door sections (right & left). Refer to illustration on next page for proper application. Note the overlap configuration in the flange area of the inner door. Set the flange section first, this will help to achieve the proper over lap position.

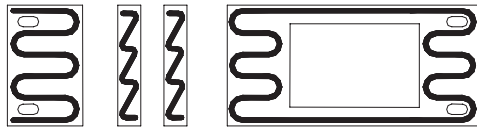

RECOMMENDED PATTERN  
FOR RTV SEALANT

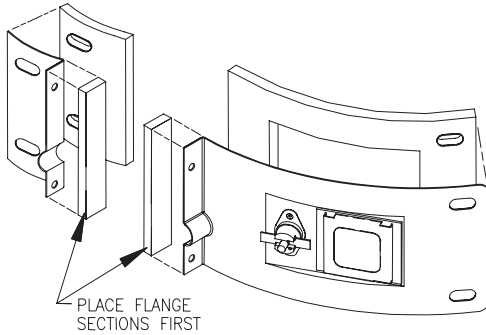

EXPANDED VIEW

GASKET OVERLAP  
MUST BE AS SHOWN  
 $\pm 1/32$

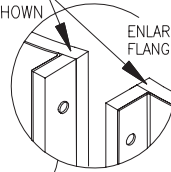

ENLARGED VIEW OF  
FLANGE AREA

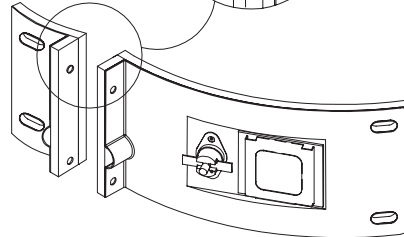

VIEW WITH GASKETS  
IN PLACE

**Installation of Inner Door With Gasket.**

- Step 7. Clean any residual gasket residue or other debris from combustion chamber surface before installing the inner door/gasket assembly.
- Step 8. Place the left side inner door into position first. Firmly position the radiused channel of the inner door around the feedline. Using the 1/4" hex drive screws from step 3d, secure left side inner door in place. **DO NOT OVER TIGHTEN SCREWS.**
- Step 9. Position thermocouple, pilot tube and Piezo wire against left side inner door flange gasket. **DO NOT ROUTE THROUGH RADIUSED CHANNEL WITH FEEDLINE.**

**⚠ WARNING**

**Stripped fastener connections may allow for seal breach of inner door. A seal breach may result in a fire or explosion causing property damage, personal injury or death. Do not over tighten screws in steps 8, 10 and 11.**

**If a fastener connection is stripped, contact the manufacturer listed on the water heater rating plate.**

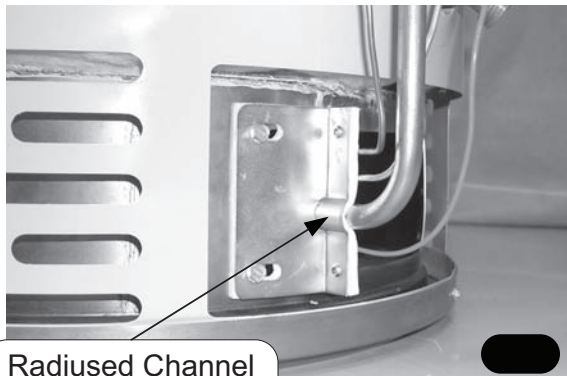

Radiused Channel  
for Feedline

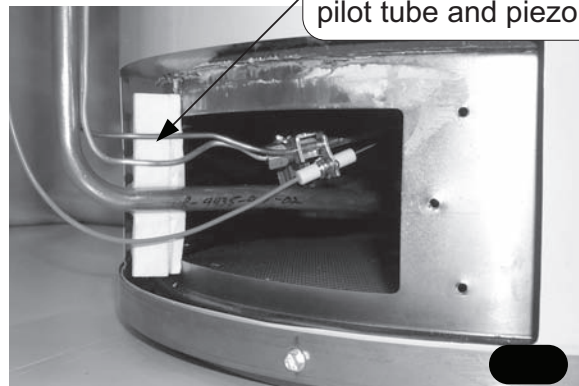

Position thermocouple,  
pilot tube and piezo wire.



- Step 10. Firmly place right side inner door flange against the left side inner door flange and secure with two 1/4" drive screws from step 3c. **DO NOT OVER TIGHTEN SCREWS.**
- Step 11. Align right side inner door to combustion chamber and verify the fastener holes of the combustion chamber are aligned with the right side inner door slotted opening. Verify seal integrity around combustion opening. Secure right side inner door using 1/4" hex drive screws from step 3b. **DO NOT OVER TIGHTEN SCREWS.** Verify both left and right sides of the inner door are properly positioned and sealed against the combustion chamber.

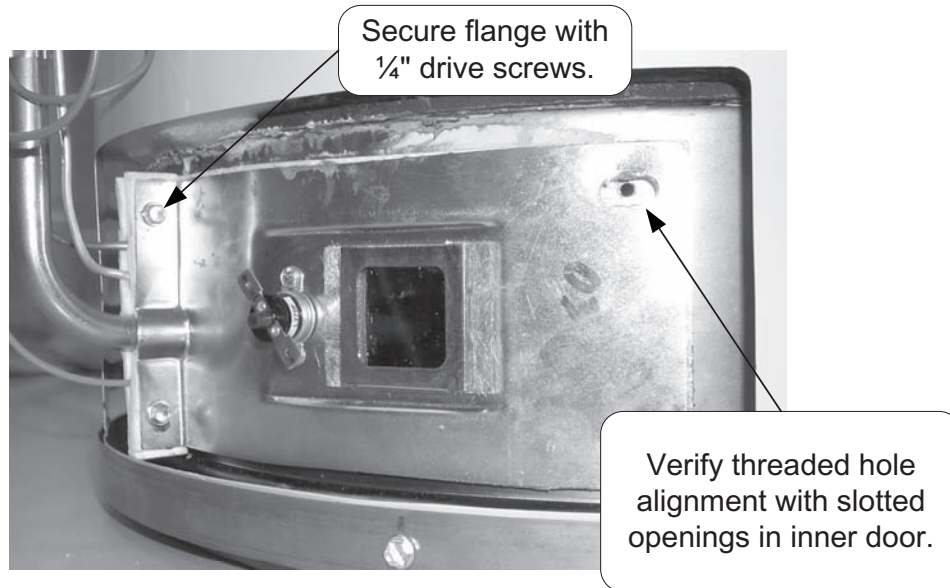

- Step 12. Reconnect lead wires from combination thermostat/gas valve to resettable thermal switch (See photo in step 3). Note, wire terminations are interchangeable with either resettable thermal switch connections.
- Step 13. Replace outer jacket burner access door.
- Step 14. To resume operation follow the instructions located on the lighting instruction label or the lighting instructions located in the installation and operation manual.

**CLOSED CIRCUIT THERMOCOUPLE TESTING (White Rodgers Control)**

- Step 1. Closed circuit testing is the preferred method for testing thermocouple. Following the lighting instruction label on the heater, proceed to light the pilot and allow to operate for three minutes. If the pilot will not stay lit, hold the pilot button (located on the combination thermostat/gas valve) down during this test
- Step 2. Using a multimeter capable of measuring millivolts, connect one lead using an alligator clip to the copper sheath of the thermocouple, use the second lead of the multi meter to probe the top terminal located at the back of the combination thermostat/gas valve.
- Step 3. If meter reads 10 millivolts or higher, the thermocouple is OK. If reading is below 10 millivolts, replace the thermocouple.

Probe top terminal on back of combination thermostat/gas valve

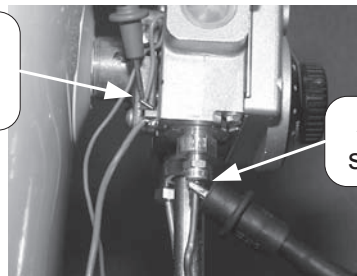

Alligator clip to copper sheath of thermocouple

**CLOSED CIRCUIT THERMOCOUPLE TESTING (Robertshaw Control)**

- Step 1. Disconnect thermocouple from combination thermostat/gas valve.
- Step 2. Connect a thermocouple adaptor (BWC P/N 239-44642-00, Robertshaw P/N 75036) at the thermocouple location in the combination thermostat/gas valve.



- Step 3. Reconnect thermocouple to adaptor. Make certain all connections are tight (finger tight plus ¼ turn)

- Step 4. Using a multimeter capable of measuring millivolts, connect one alligator clip to the set screw of the adaptor, and the other alligator clip to copper portion of the thermocouple.



- Step 5. Following the lighting instruction label on the heater, proceed to light the pilot and allow to operate for three minutes. If the pilot will not stay lit, hold the red reset button (located on the combination thermostat/gas valve) down during this test
- Step 6. If meter reads 13 millivolts or higher, the thermocouple is OK. If reading is below 13 millivolts replace the thermocouple.



### OPEN CIRCUIT THERMOCOUPLE TESTING

Step 1. Disconnect thermocouple from combination thermostat/gas valve.

Step 2. Using a multimeter capable of measuring millivolts, connect one alligator clip to the end ball or contact portion of the thermocouple, and the other alligator clip to copper portion of the thermocouple.



Step 3. Following the lighting instruction label on the heater, proceed to light the pilot and allow to operate for three minutes. **It will be necessary to hold the pilot button down continuously throughout this test.** A reading of 20 to 30 millivolts indicates good thermocouple output.

### THERMOCOUPLE REPLACEMENT

Step 1. Turn off gas supply to water heater. Rotate knob of combination thermostat/gas valve to "OFF" position.

For White Rodgers Control, depress knob slightly and rotate clockwise to the "OFF" position.



For Robertshaw Control, rotate knob clockwise to the "OFF" position.



Step 2. Remove outer jacket door.

Step 3. Remove right side of inner door per SERVICE PROCEDURE RG-I, steps 3a through 3c.

Step 4. Disconnect thermocouple from combination thermostat/gas valve (3/8" wrench). Locate other end of thermocouple inside of combustion chamber and remove from pilot bracket. Pull firmly pulling away from the pilot assembly.

Step 5. Install new thermocouple into pilot bracket making certain the thermocouple is fully engaged into the pilot bracket. Position thermocouple against left side inner door flange at its original position. Connect other end of thermocouple to combination thermostat/gas valve (finger tight + 1/4 turn).

Step 6. Inspect inner door gasket per SERVICE PROCEDURE RG-I, Step 4.

Step 7. Install right side inner door per SERVICE PROCEDURE RG-I, Step 10 through Step 13

Step 8. To resume operation follow the instructions located on the lighting instruction label or the lighting instructions located in the installation and operation manual.

Thermocouple position

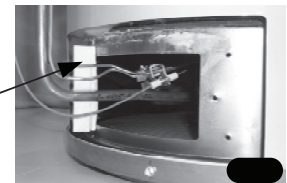

**PILOT/ELECTRODE ASSEMBLY INSPECTION,  
CLEANING AND REPLACEMENT**

Step 1. Turn off gas supply to water heater. Rotate knob of combination thermostat/gas valve to "OFF" position.

Step 2. Remove outer jacket door.

Step 3. Remove right side of inner door per SERVICE PROCEDURE RG-I, steps 3a through 3c.

Step 4. Disconnect thermocouple (3/8" wrench), pilot tube (7/16" wrench), and feedline (3/4" wench) from combination thermostat/gas valve.

NOTE: Feedline nut for natural gas control uses right hand threads, LP control uses left hand thread.

Step 5. Disconnect piezo ignition wire from piezo igniter.

Step 6. Remove burner assembly from combustion chamber.

Step 7. Remove pilot/electrode assembly from feedline (1/4" drive tool)

Step 8. Inspect pilot for the following:

- a) Primary air openings for blockage. Must be free from any debris (dirt, lint, etc).
- b) Kinks or cracks in the pilot tube. If found, the pilot must be replaced.

Step 9. Inspect pilot orifice:

- a) Remove 1/2" nut from bottom of pilot assembly.
- b) Remove pilot tube and pilot orifice.
- c) inspect pilot orifice for blockage, must be cleaned or replaced.

Step 10. Install pilot/electrode assembly to feedline, secure with screw from step 7.

Step 11. Re-Install burner assembly into combustion chamber, connect feedline, pilot tube and thermocouple to combination thermostat/gas valve.

Step 12. Install inner door per SERVICE PROCEDURE RG-I, step 4 through 13.

Step 13. To resume operation follow the instructions located on the lighting instruction label or the lighting instructions located in the installation and operation manual.

For White Rodgers Control, depress knob slightly and rotate clockwise to the "OFF" position.

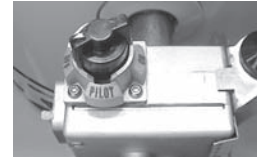

For Robertshaw Control, rotate knob clockwise to the "OFF" position.

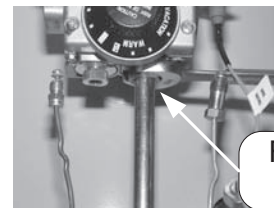

Feedline Nut

Primary Air Opening

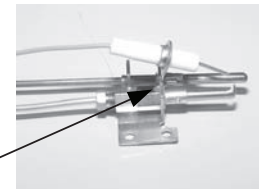

Pilot Orifice

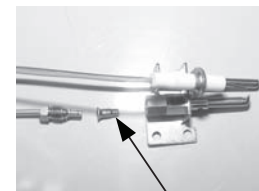

**PIEZO IGNITER, ELECTRODE TESTING AND REPLACEMENT**

With the pilot not in operation (no pilot flame) you can check the Piezo and electrode circuit by viewing pilot thru the sight glass located on the inner door and observing the spark action.

- Step 1. Remove outer jacket door.
- Step 2. Repeatedly depress the Piezo igniter while viewing the pilot thru the sight glass. If a spark is present, the circuit is OK. If there is no spark, proceed to step 3.



- Step 3 Remove orange wire from Piezo igniter and install a jumper wire in its place. Hold the other end of the jumper by the wire insulation or using an insulated tool, next to an unpainted surface such as the feedline or gas valve and depress the Piezo igniter. If there is a spark, the igniter is OK, the pilot is not functioning and must be replaced, see SERVICE PROCEDURE RG-III for pilot replacement. If no spark is present the igniter is not functioning and must be replaced.

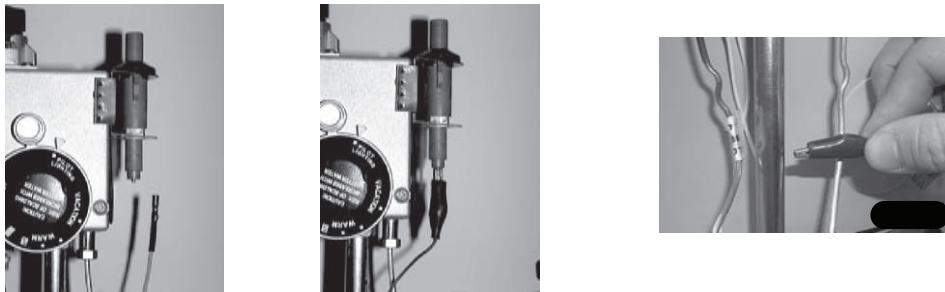

- Step 4 With orange wire disconnected from piezo igniter. Using a common screw driver, place blade of screw driver under piezo bracket and gently pry bracket from front of combination thermostat/gas valve and unhook bracket from rear of combination thermostat/gas valve.

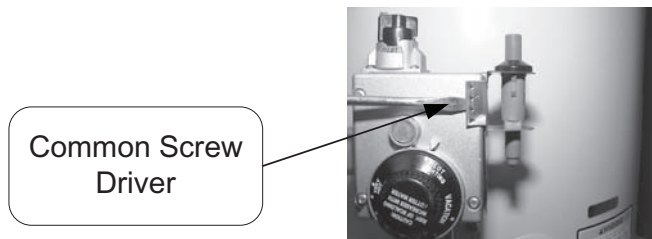

## Combination Thermostat/Gas Valve Testing and Replacement

The combination thermostat/gas valve is a non repairable device. If trouble shooting has determined a problem with the combination thermostat/gas valve, it must be replaced.

If the burner and/or pilot do not function, service checks for gas pressure, thermocouple output, magnet assembly and ECO are to be performed. If these check OK, the combination thermostat/gas valve may be faulty.

### LINE PRESSURE

The combination thermostat/gas valve is designed for a maximum line pressure of 14.0" w.c. and a minimum line pressure of 1.0"w.c. over the water heater rated manifold pressure. Line pressure must be checked with burner on and burner off to assure proper readings.

### MANIFOLD PRESSURE TESTING (this procedure assumes a maximum line pressure of 14.0" w.c.)

- Step 1. Set combination thermostat/gas valve to "OFF" position.
- Step 2. Remove pressure tap plug (3/16" Allen wrench) and install pressure tap (7/16 wrench)
- Step 3. Connect manometer to pressure tap.
- Step 4. Follow lighting instructions and proceed to light main burner and observe manometer reading.
- Step 5. Proper operating range for natural gas is 4.0 ±0.3" W.C.  
Proper operating range for L.P. gas is 10.0 ±0.5" W.C.
- Step 6. If pressure is OK, set combination thermostat/gas valve to "OFF" remove manometer and pressure tap and replace pressure tap plug. Check for gas leaks before placing water heater back in operation. If pressure is out of the specification noted in step 5, proceed to step 7 or 8 for proper service procedure.
- Step 7. For White Rodgers control, the manifold pressure is not adjustable. If manifold pressure is outside the range in step 5, the control must be replaced.
- Step 8. For Robertshaw control, the manifold pressure is adjustable, proceed to step 9 for adjustment procedure
- Step 9. While burner is in operation, remove regulator access cap to expose the regulator adjusting screw. With small screw driver, rotate adjusting screw clockwise to increase pressure and counter clockwise to decrease pressure.



Pressure Tap  
Shown Installed



- Step 10. Replace regulator access cap, set combination thermostat/gas valve to "OFF". Remove manometer and pressure tap and replace pressure tap plug. Check for gas leaks before placing water heater back in operation.

### THERMOCOUPLE TESTING

See SERVICE PROCEDURE RG-II

### MAGNET ASSEMBLY TESTING (White Rodgers Control)

- Step 1. Following the lighting instruction label on the heater, proceed to light the pilot and allow to operate for three minutes. If the pilot will not stay lit, hold the pilot button (located on the combination thermostat/gas valve) down during this test
- Step 2. Using a multimeter capable of measuring millivolts, connect one lead using an alligator clip to the copper sheath of the thermocouple, use the second lead of the multi meter to probe the top terminal located at the back of the combination thermostat/gas valve.

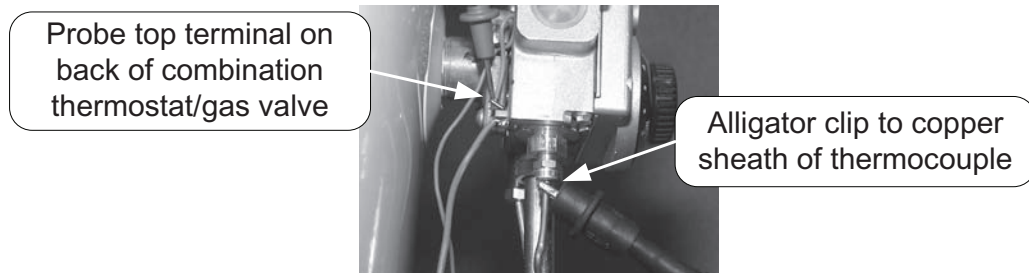

- Step 6. With a meter reading of 13 millivolts or greater, rotate knob of combination thermostat/gas valve to the “OFF” position.
- Step 7. The magnet should remain closed for a drop of at least 6 millivolts. You will here a “snap” or “click” sound when the magnet opens, if you hear this sound prior to a drop of 6 millivolts, the magnet is out of specification and the combination thermostat/gas valve should be replaced.

### MAGNET ASSEMBLY TESTING (Robertshaw Control)

- Step 1. Disconnect thermocouple from combination thermostat/gas valve.
- Step 2. Connect a thermocouple adaptor (BWC P/N 239-44642-00, Robertshaw P/N 75036) at the thermocouple location in the combination thermostat/gas valve.
- Step 3. Reconnect thermocouple to adaptor. Make certain all connections are tight (finger tight plus ¼ turn).
- Step 4. Using a multimeter capable of measuring millivolts, connect one alligator clip to the set screw of the adaptor and the other alligator clip to copper portion of the thermocouple.
- Step 5. Following the lighting instruction label on the heater, proceed to light the pilot and allow to operate for three minutes.
- Step 6. With a meter reading of 13 millivolts or greater, rotate knob of combination thermostat/gas valve to the “OFF” position.
- Step 7. The magnet should remain closed for a drop of at least 6 millivolts. You will here a “snap” or “click” sound when the magnet opens, if you hear this sound prior to a drop of 6 millivolts, the magnet is out of specification and the combination thermostat/gas valve should be replaced.

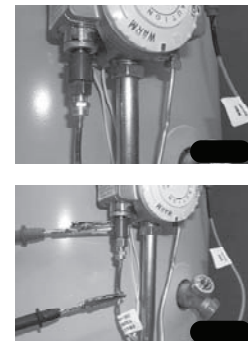



**ECO (Energy Cut Off) TESTING**

Step 1. Disconnect thermocouple from combination thermostat/gas valve.

Step 2. Using a multimeter capable of measuring Ohms (or continuity), attach one lead (alligator clip) to the pilot tube. Insert the other lead (probe) fully into the magnet opening. Be sure the probe makes contact only at the top center of the magnet opening. Do not allow the probe to make contact with the threaded sides of the opening.



Step 3. If continuity is indicated, the ECO is OK. If continuity is not indicated, the ECO has opened and the combination thermostat/gas valve must be replaced.

**COMBINATION THERMOSTAT/GAS VALVE REPLACEMENT**

Step 1. Rotate knob of the combination thermostat/gas valve to the "OFF" position.

For White Rodgers Control, depress knob slightly and rotate clockwise to the "OFF" position.



Step 2. Turn off gas supply to water heater.

Step 3. Disconnect gas supply line from combination thermostat/gas valve.

For Robertshaw Control, rotate knob clockwise to the "OFF" position.



Step 4. Turn off water supply and drain water heater completely.

Step 5. Remove outer jacket burner access door.

Step 6. Right side inner door removal.

a) Disconnect resettable thermal switch wire leads (leading from combination thermostat/gas valve) and remove wire tie from feedline.

b) Remove (2) 1/4" hex drive screws from right side inner door.

c) Remove (2) 1/4" drive screws from flange section of inner door.

d) Remove right side inner door and set aside. Be careful not to damage gasket material on inner door.

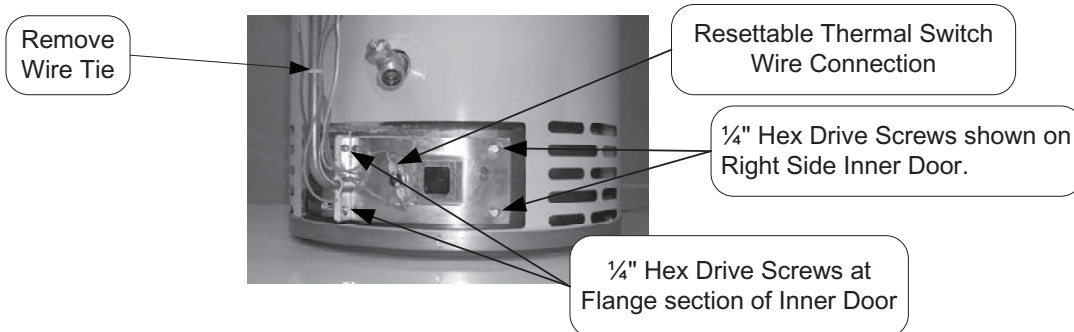



## Step 7. Removal of combination thermostat/gas valve.

- a) Disconnect main burner feedline (3/4" wrench), pilot tube (7/16" wrench) and thermocouple (3/8" wrench) from combination thermostat/gas valve & remove burner from combustion chamber.

NOTE: Feed line nut for natural gas control uses right hand threads,  
LP control uses left hand thread.

- b) Remove piezo bracket with piezo igniter (refer to SERVICE PROCEDURE RG-IV) from Combination Thermostat/Gas Valve.
- c) Remove Combination Thermostat/Gas Valve from heater, rotating counter clockwise using a control body wrench or a length of 1/2" NPT pipe threaded into inlet of control.

To remove or install control, insert only 1/2" NPT threaded pipe into inlet and use to loosen or tighten control.

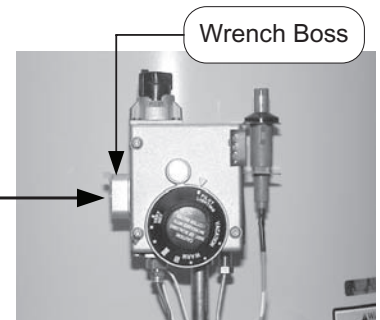

## Step 8. Installation of Combination Thermostat/Gas Valve.

- a) Install new combination thermostat/gas Valve using a control body wrench or a length of 1/2" NPT pipe threaded into inlet of control. **DO NOT OVER TIGHTEN.** Use caution not to damage cast aluminum body of combination thermostat/gas valve. Be certain not to damage the bundled wire leads. Note: Combination thermostat/gas Valve must be installed in proper upright position to assure the feedline will align properly at the inner door flange. **DO NOT OVER TIGHTEN.** If control is turned past proper alignment, do not reverse direction to align.
- b) Reattach Piezo bracket with Piezo igniter to combination thermostat/gas valve.
- c) Reattach main burner feedline, pilot tube and thermocouple to combination thermostat/gas valve.

NOTE: Feedline nut for natural gas control uses right hand threads,  
LP control uses left hand thread.

- d) Gather wire leads of combination thermostat/gas valve and Piezo igniter and secure along side of feedline using new wire tie provided.
- e) Connect gas supply piping to inlet of control. Use back up wrench on wrench boss of control, never use back up wrench on body of control.

## Step 9. Reinstallation of inner door assembly.

- a) Prior to reinstallation of inner door, fully inspect inner door gasket for the following:
- > Tears
  - > Missing Material
  - > Cracks
  - > Dirt or debris
  - > Gasket Adhesion to inner door
  - > Other imperfections that will inhibit proper seal
  - > Material left on combustion chamber

If the gasket is not effected by any of the above, gasket replacement will not be required. If replacement is required, replace using new gasket kit following the instructions provided with kit.

## Step 9. Reinstallation of inner door assembly. (cont.)

- b) Clean any gasket residue or other debris from combustion chamber surface before installing the inner door/gasket assembly.
- c) Position thermocouple, pilot tube and Piezo wire against left side inner door flange gasket. **DO NOT ROUTE THROUGH RADIUSED CHANNEL WITH FEEDLINE.** Be sure that thermocouple and pilot tube are not in position to interfere with outer jacket burner access door when reinstalled.

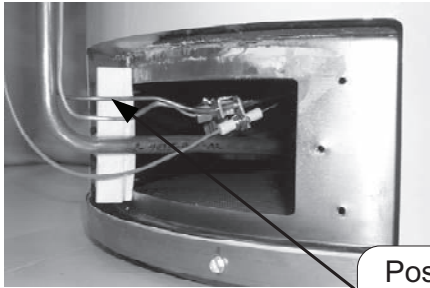

Position thermocouple,  
pilot tube and Piezo wire.

**⚠ WARNING**  
A seal breach may result in a fire or  
explosion causing property damage,  
personal injury or death.

- d) Firmly place right side inner door flange against the left side inner door flange and secure with two 1/4" hex drive screws from step 6c. **DO NOT OVER TIGHTEN SCREWS.**
- e) Align right side inner door to combustion chamber and verify the fastener holes of the combustion chamber are aligned with the right side inner door slotted openings. Verify seal integrity around combustion opening. Secure right side inner door using 1/4" hex drive screws from step 6b. **DO NOT OVER TIGHTEN SCREWS.** Verify both left and right sides of the inner door are properly positioned and sealed against the combustion chamber.

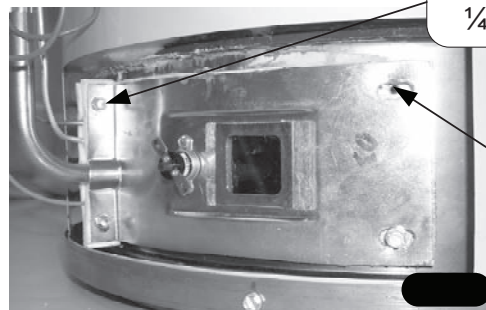

Secure flange with  
1/4" drive screws.

Verify threaded hole  
alignment with slotted  
openings in inner door.

- Step 10. Reconnect wire leads from combination thermostat/gas valve to resettable thermal switch (See photo in step 6). Note: wire terminations are interchangeable with either resettable thermal switch connection.
- Step 11. Replace outer jacket burner access door.
- Step 12. Reconnect gas supply to Combination Thermostat/Gas Valve.
- Step 13. Resume water supply to water heater. Be sure tank is full of water.
- Step 14. To resume operation follow the instructions located on the lighting instruction label or the lighting instructions located in the installation and operation manual.

## **MAIN BURNER: Inspection, Adjustment, Cleaning and Replacement**

At periodic intervals (not more than 6 months) a visual inspection should be made of the main burner for proper operation and to insure no debris accumulating.

Main burner should light smoothly from pilot and burn with a blue flame with a minimum of yellow tips.

Steel burner models have a self adjusting air mixture and do not have an adjustable air shutter. Cast iron burner can have the gas and air mixture properly proportioned by adjusting the air shutter on the mixer face of the main burner (see step 2 below).

Main burner must be free from any debris accumulation that may effect burner operation (see burner cleaning procedure on page 17).

## **CAST IRON BURNER ADJUSTMENT**

### **⚠ DANGER**

**Under no circumstances shall flammable materials be used or stored in the vicinity of the water heater. With the inner door removed the Bradford White Defender Safety System will be inactivated. If flammable vapors are present, a fire or explosion may result causing property damage, personal injury or death.**

**Upon completion of the cast iron burner adjustment procedure, the inner door must be replaced per SERVICE PROCEDURE RG-1, steps 4 through 14 to reactivate Bradford White Defender Safety System.**

### **⚠ WARNING**

**Inner door and burner components may be HOT when performing this operation. Take necessary precaution to prevent personal injury.**

- Step 1. With main burner in operation, remove right side inner door per service procedure I, steps 3b & 3c. Be sure to maintain wire connection to resettable thermal switch for this adjustment procedure.
- Step 2. To adjust for proper burning, loosen the air shutter nut, rotate the shutter to close the opening in the burner, then slowly rotate the shutter until the yellow tips disappear and the flame becomes blue. Tighten the air shutter nut. Too much air will cause the flame to lift off the burner ports and create noisy burner operation. Too little air (yellow tips) will result in soot formation.

Place right side inner door into proper position to confirm proper burner flame pattern and correct air shutter adjustment. It may be necessary to allow the burner to operate for several minutes for burner flame to stabilize.

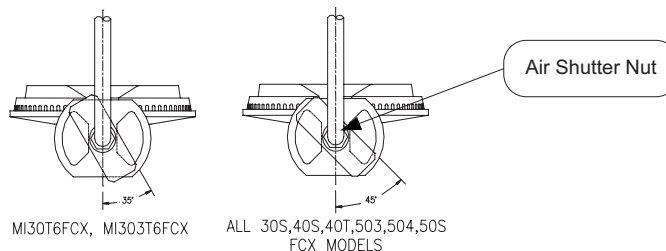

**MAIN BURNER: Inspection, Adjustment,  
Cleaning and Replacement (cont.)**

Step 3. Fully inspect inner gasket per SERVICE PROCEDURE RG-I, step 4. Replace gasket if required following SERVICE PROCEDURE I, steps 5 & 6.

Step 4. Be certain that thermocouple, pilot tube and piezo wire are routed by inner door flange as shown and Reinstall inner door per SERVICE PROCEDURE RG-I, step 10 and 11.

Position thermocouple,  
pilot tube and Piezo wire.

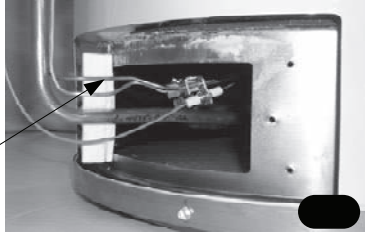

Step 5. Observe burner operation through sight glass of inner door. Burner should operate as adjusted in step 2, if not, repeat procedure compensating air shutter position for proper burner operation with inner door in place.

Step 6. It may be necessary to clean main burner or main burner orifice to achieve proper burner operation. If cleaning is required proceed to burner cleaning section in this procedure.

**BURNER CLEANING (Steel & Cast Iron)**

Step 1. Remove inner door assembly per SERVICE PROCEDURE RG-I, steps 1 through 3c.

Step 2. Disconnect main burner feed line (3/4 wrench), pilot tube (7/16 wrench) and thermocouple (3/8) wrench from combination thermostat gas valve and remove burner assembly from combustion chamber.

NOTE: Feedline nut for natural gas control uses right hand threads,  
LP control uses left hand thread.

Step 3. Thoroughly inspect burner surface area and burner ports and remove any loose debris accumulation.

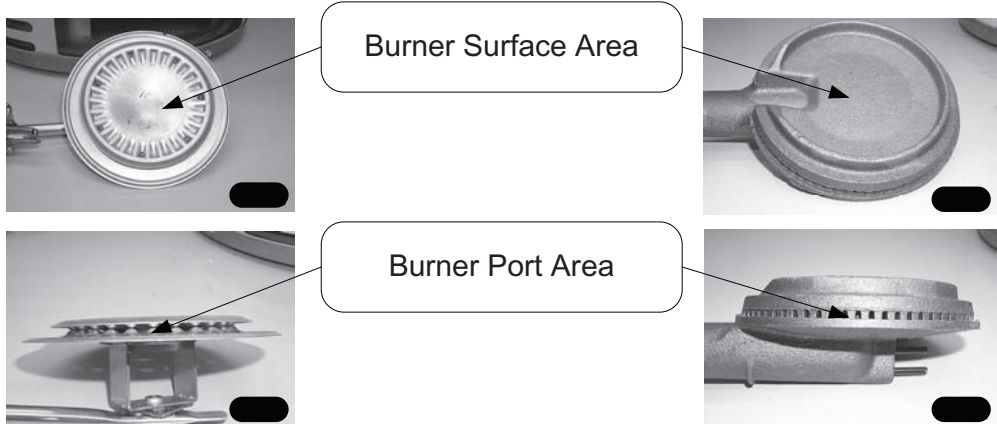

Step 4. On cast iron burners, inspect for any debris build up inside burner venturi. If found, disconnect feedline from burner and remove debris build up.

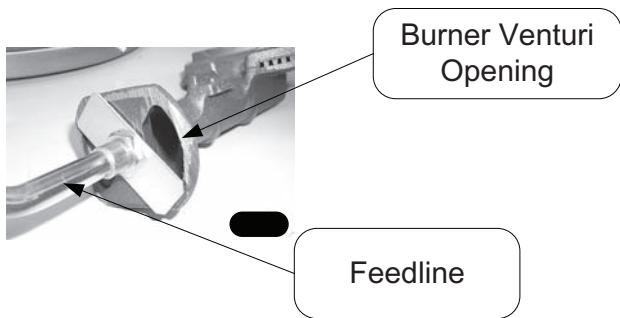

**BURNER CLEANING** (Cont.)

Step 5. Disconnect (unscrew) Main burner (stamped steel "B" burner) from main burner orifice or on cast iron burners ("C" burner), loosen air shutter & disconnect (unscrew) feedline from burner.



Step 6. Remove main burner orifice from feed line (1/2" wrench on steel burner, 3/8" wrench on cast iron). Inspect and clean if necessary.

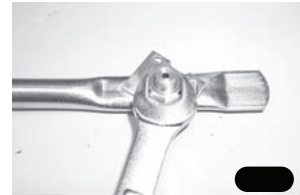

Step 7. Remove pilot assembly, refer to SERVICE PROCEDURE RG-III for cleaning and inspection.

Step 8. Reassemble burner.

Step 9. Inspect combustion chamber area of heater prior to reinstallation of burner assembly. If cleaning is required, refer to SERVICE PROCEDURE RG-VIII.

Step 10. Reinstall burner assembly into combustion chamber, reconnect feedline, thermocouple and pilot tube to the combination thermostat/gas valve.

Step 11. Reinstall inner door per SERVICE PROCEDURE RG-I, steps 4 through 13.

Step 12. To resume operation, follow the instructions located on the lighting instruction label or the lighting instructions located in the installation and operation manual.

**RESETTABLE THERMAL SWITCH CONTINUITY TESTING**

- Step 1. Remove outer jacket door.
- Step 2. Disconnect wire leads from resettable thermal switch.

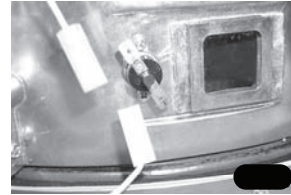

- Step 3. Using a multimeter capable of measuring continuity (Ohms), place one probe of meter on one of the brass connection tabs of the resettable thermal switch, and the remaining probe on the other connection tab.



- Step 4. If continuity is indicated, the switch is closed, allowing millivolt current to pass.
- Step 5. If continuity is not indicated, the switch is open, possibly due to an over heating condition. The switch is designed to open at predetermined temperatures depending on model. An open switch can be reset by depressing the red colored button located at the center of the switch. The overheating condition must be determined prior to putting the heater back in service.

<b><u>PROBABLE CAUSE FOR RESETTABLE THERMAL SWITCH ACTIVATION</u></b>	
<b><u>PROBABLE CAUSE</u></b>	<b><u>CORRECTIVE ACTION</u></b>
Insufficient combustion Air	<ol style="list-style-type: none"> <li>1. Verify adequate combustion air supply is available.</li> <li>2. Clear jacket slot openings of any dirt, dust, restrictions or other obstructions.</li> <li>3. inspect flame arrestor plate and clean with stiff brush and/or vacuum to remove scale deposits and debris.</li> </ol>
<ol style="list-style-type: none"> <li>1. Weak switch or switch out of calibration.</li> <li>2. Incorrect switch.</li> </ol>	<ol style="list-style-type: none"> <li>1. Replace resettable thermal switch</li> <li>2. Verify switch color code and approximate temperature.</li> </ol>
Flammable vapor incident	<ol style="list-style-type: none"> <li>1. Replace water heater.</li> </ol>

Resettable thermal switch color code reference.	
Color Code	Approximate switch activation temperature (open)
Blue	240°
Yellow	270°
Red	290°



**RESETTABLE THERMAL SWITCH REPLACEMENT**

Step 1. Rotate knob of combination thermostat gas valve to the off position.

For White Rodgers Control, depress knob slightly and rotate clockwise to the "OFF" position.



For Robertshaw Control, rotate knob clockwise to the "OFF" position.



Step 2. Remove outer jacket door.

Step 3. Disconnect wire leads from resettable thermal switch.

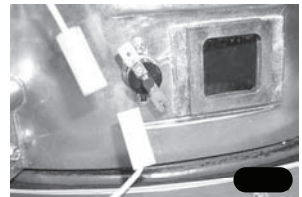

Step 4. Remove resettable thermal switch from inner door (Phillips screw driver)



Step 5. Place new resettable thermal switch in place. Be sure contact surface of resettable thermal switch and inner door are free of any debris. Secure resettable thermal switch into place using screws from step 4. **DO NOT OVER TIGHTEN SCREWS.**

Step 6. Reconnect wire leads from combination thermostat/gas valve to resettable thermal switch.

Note: Wire termination are interchangeable with either resettable thermal switch connection.

Step 7. Replace outer jacket door

Step 8. To resume operation follow the instructions located on the lighting instruction label or the lighting instruction located in the installation and operation manual.

**ScreenLok® Flame Arrestor Cleaning**

Step 1. Rotate knob of combination thermostat gas valve to the off position.

For White Rodgers Control, depress knob slightly and rotate clockwise to the "OFF" position.



For Robertshaw Control, rotate knob clockwise to the "OFF" position.



Step 2. Remove outer jacket door.

Step 3. Remove inner door per SERVICE PROCEDURE RG-I, step 3a through 3e.

Step 4. Disconnect main burner feed line (3/4 wrench), pilot tube (7/16 wrench) and thermocouple (3/8) wrench from combination thermostat gas valve and remove burner assembly from combustion chamber.

NOTE: Feedline nut for natural gas control uses right hand threads, LP control uses left hand thread.

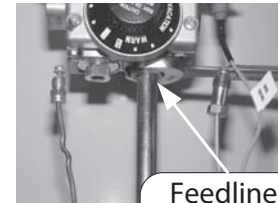

Feedline Nut

Step 5. Clean ScreenLok® Flame Arrestor using stiff brush, compressed air and/or shop vacuum to remove any scale or other debris accumulation. Using a soft brush, clear jacket openings of any dirt, dust, restrictions or other obstructions.

Step 6. Remove any debris from burner assembly per SERVICE PROCEDURE RG-V and reinstall burner assembly into combustion chamber.

Step 7. Reconnect feedline, thermocouple and pilot tube to the combination thermostat/gas valve.

Step 8. Reinstall inner door per SERVICE PROCEDURE RG-I, steps 4 through 13.

Step 9. To resume operation follow the instructions located on the lighting instruction label or the lighting instruction located in the installation and operation manual.

**DIP TUBE INSPECTION AND REPLACEMENT****⚠ WARNING**

Heater components and stored water may be **HOT** when performing the following steps in this procedure. Take necessary precaution to prevent personal injury.

Step 1. Rotate knob of combination thermostat/gas valve to “OFF” position.

For White Rodgers Control, depress knob slightly and rotate clockwise to the “OFF” position.



For Robertshaw Control, rotate knob clockwise to the “OFF” position.



Step 2. Turn off cold water supply to heater. Connect hose to drain spigot of water heater and route to an open drain. Open a nearby hot water faucet to vent heater for draining. Open drain spigot of hot water heater and allow heater to drain to a point below the inlet connection nipple.

Step 3. Disconnect inlet nipple from plumbing system.

Step 4. With an appropriate wrench, remove inlet nipple/dip tube from the water heater. Use caution not to damage pipe threads.

Step 5. Visually inspect inlet nipple/dip tube. Inlet nipple/dip tube should be free of cracks and any blockage. Hydro-jets located near the bottom of the dip tube should be open and free of any blockage. Anti-siphon hole located approximately 6" from the bottom of nipple, should be free of any blockage.

Any damage such as cracks, restriction due to deformation or unintentional holes are not field repairable and the inlet nipple/dip tube must be replaced.

Step 6. Upon completion of inspection or subsequent replacement, reinstall inlet nipple/dip tube into heater. Connect nipple to plumbing system, resume water supply and refill heater with water.

Step 7. To resume operation follow the instructions located on the lighting instruction label or the lighting instructions located in the installation and operation manual.

**ANODE INSPECTION AND REPLACEMENT****⚠ WARNING**

Heater components and stored water may be HOT when performing the following steps in this procedure. Take necessary precaution to prevent personal injury.

Step 1. Turn off water supply to water heater. Rotate knob of combination thermostat/gas valve to “OFF” position.

For White Rodgers Control, depress knob slightly and rotate clockwise to the “OFF” position.



For Robertshaw Control, rotate knob clockwise to the “OFF” position.



Step 2. Turn off cold water supply to heater. Connect hose to drain spigot of water heater and route to an open drain. Open a nearby hot water faucet to vent heater for draining. Open drain spigot of hot water heater and allow heater to drain to a point below the outlet connection nipple.

Step 3. Disconnect outlet nipple from plumbing system.

Step 4. With an appropriate wrench, remove outlet nipple/anode from the water heater. Use caution not to damage pipe threads.

Step 5. Visually Inspect outlet nipple/anode. Outlet nipple/anode should show signs of depletion, this is normal. If depletion is  $\frac{1}{2}$  of the original anode diameter (approximately  $\frac{3}{4}$ ” diameter), replacement is recommended. If any of the steel core of the anode is exposed, replacement is recommended.

Step 6. Upon completion of inspection or subsequent replacement, reinstall outlet nipple/anode into heater. Connect nipple to plumbing system, resume water supply and refill heater with water.

Step 7. To resume operation, follow the instructions located on the lighting instruction label or the lighting instructions located in the installation and operation manual.

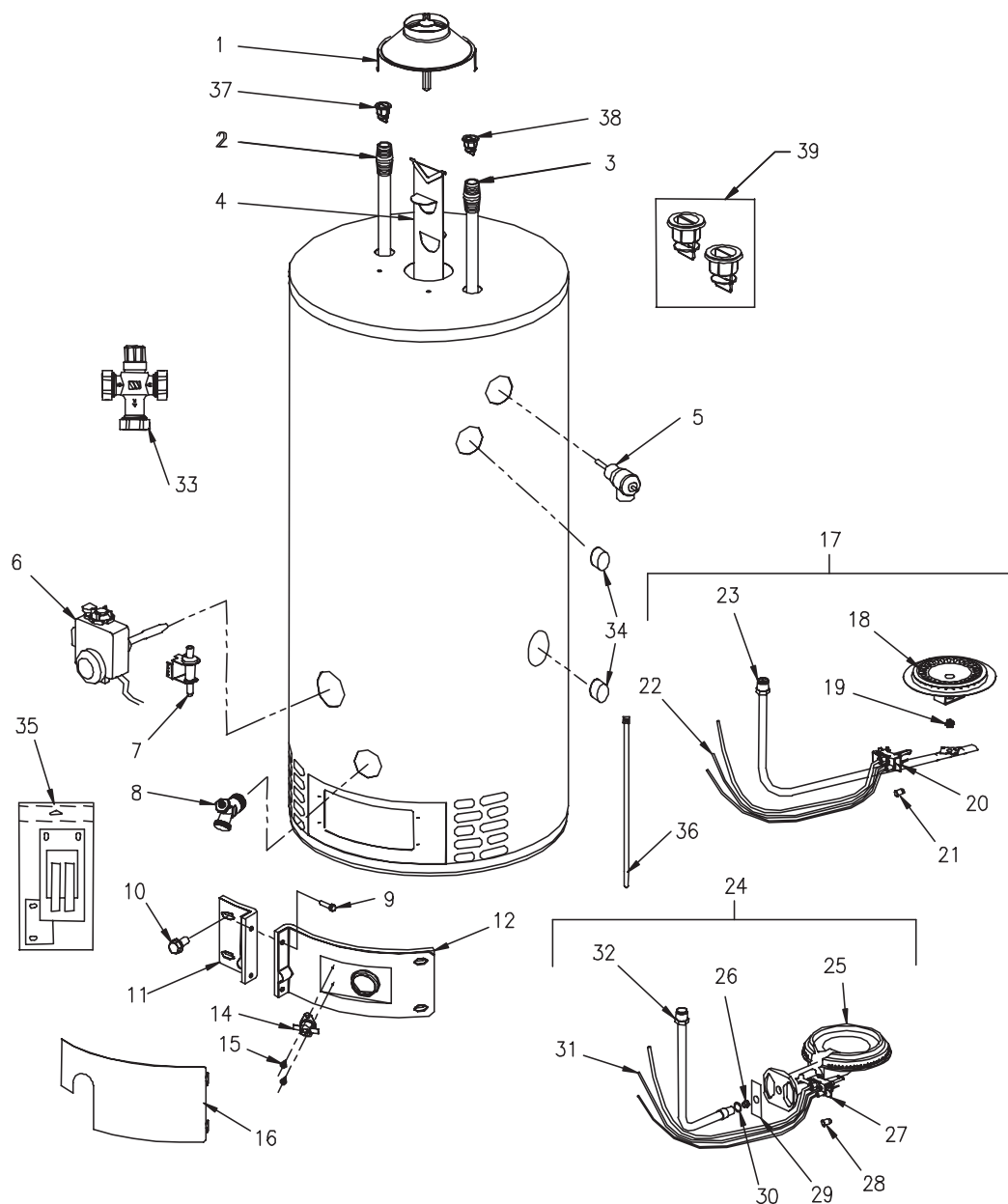

- |    |                                    |    |                                       |
|----|------------------------------------|----|---------------------------------------|
| 1  | Draft Hood                         | 20 | Pilot Assembly                        |
| 2  | Hot Water Outlet/Anode             | 21 | Pilot Orifice                         |
| 3  | Cold Water Inlet Tube              | 22 | Thermocouple                          |
| 4  | Flue Baffle                        | 23 | Feed Line                             |
| 5  | T&P Relief Valve                   | 24 | Complete Cast Iron Burner Assembly    |
| 6  | Thermostat                         | 25 | Cast Iron Burner Only                 |
| 7  | Piezo Igniter                      | 26 | Main Burner Orifice                   |
| 8  | Brass Drain Valve                  | 27 | Pilot Assembly                        |
| 9  | Screw-#8-18 x 3/4 Hex Washer Head  | 28 | Pilot Orifice                         |
| 10 | Screw-#10-12 x 3/4 Hex Washer Head | 29 | Air Shutter                           |
| 11 | Left Side Inner Door with Gasket   | 30 | Air Shutter Nut                       |
| 12 | Complete Right Side Inner Door     | 31 | Thermocouple                          |
| 14 | Resettable Thermal Switch          | 32 | Feed Line                             |
| 15 | Screw #6-20 x 3/8 PHCR             | 33 | ASSE Approved Mixing Valve (Optional) |
| 16 | Outer Door                         | 34 | 3/4 NPT Tank Plug (XR models)         |
| 17 | Complete BN Burner Assembly        | 35 | Inner Door Gasket Kit                 |
| 18 | BN Burner Only                     | 36 | Wire Tie                              |
| 19 | Main Burner Orifice                |    |                                       |









**BRADFORD WHITE<sup>®</sup>**  
C O R P O R A T I O N  
Ambler, PA

For U.S. and Canada field service,  
contact your professional installer or  
local Bradford White sales representative.

**Sales/800-523-2931**  
***Fax/215-641-1670***

**Application & Sizing/800-523-2931**  
***Fax/215-641-1612***

**Technical Support/800-334-3393**  
***Fax/269-795-1089***

**Warranty/800-531-2111**  
***Fax/269-795-1089***

**International:**  
**Telephone/215-641-9400**  
***Telefax/215-641-9750***



**BRADFORD WHITE-CANADA<sup>®</sup> INC.**  
Mississauga, ON

**Sales/Technical Support**  
**866-690-0961**  
**905-238-0100**  
***Fax/905-238-0105***

**Email**  
**parts@bradfordwhite.com**  
**techserv@bradfordwhite.com**

**www.bradfordwhite.com**  
**www.bradfordwhitecanada.com**

## Free Manuals Download Website

<http://myh66.com>

<http://usermanuals.us>

<http://www.somanuals.com>

<http://www.4manuals.cc>

<http://www.manual-lib.com>

<http://www.404manual.com>

<http://www.luxmanual.com>

<http://aubethermostatmanual.com>

Golf course search by state

<http://golfingnear.com>

Email search by domain

<http://emailbydomain.com>

Auto manuals search

<http://auto.somanuals.com>

TV manuals search

<http://tv.somanuals.com>