



**BRADFORD WHITE**<sup>®</sup>  
W A T E R H E A T E R S

**Residential Flue Damper**  
Gas Water Heaters



# SERVICE MANUAL

Troubleshooting Guide  
and Instructions for Service

(To be performed ONLY by  
qualified service providers)

## Models Covered by This Manual:

D4403S\*F(BN,SX)

D4504S\*F(BN,SX)

(\* Denotes Warranty Years)

---

## Table of Contents

<b><u>Section</u></b>	<b><u>Page</u></b>
Introduction _____	5
How to Use this Manual _____	6
Tools Required for Service _____	6
Specifications _____	7
Sequence of Operation _____	9
Power Up Sequence	
Normal Heating Sequence	
Abnormal Operation	
Troubleshooting _____	13
Burner Maintenance _____	15
Burner Inspection	
Burner Cleaning Procedure	
Pilot Maintenance _____	17
Pilot Inspection, Testing and Replacement	
Damper Replacement _____	19
Thermal Well Testing _____	21
Determine Water Temperature Inside Tank _____	22
Component Disassembly _____	23
Gas Control Removal _____	24
Gas Control Assembly _____	25
Flammable Vapor Sensor Testing _____	27
120 VAC Circuit Trace _____	27
Diptube Inspection _____	28
Anode Inspection _____	29
Damper Removal _____	31
Inner Door Removal _____	32
Inner Door Gasket Replacement _____	33
Inner Door Installation _____	34
Arrestor Cleaning _____	35
Damper Relay Installation _____	35
Common Terms _____	38
Notes _____	38
Parts List _____	39



## WARNING

If the information in these instructions is not followed exactly, a fire or explosion may result causing property damage, personal injury, or death.

What to do if you smell gas:

- Do not try to light any appliance
- Do not touch any electrical switch; do not use any phone in your building
- Immediately call your gas supplier from a neighbor's phone. Follow the gas supplier's instructions.
- If you cannot reach your gas supplier, call the fire department.

Installation and service must be performed by a qualified installer, service agency, or the gas supplier.



## DANGER

Do not store or use gasoline or other flammable, combustible, or corrosive vapors and liquids in the vicinity of this or any other appliance.



## CAUTION

Incorrect operation of this water heater may create a hazard to life and property and will nullify the warranty.

If sweat fittings are to be used, DO NOT apply heat to the nipples on top of the water heater. Sweat the tubing to the adapter before fitting the adapter to the water connections. It is imperative that heat is not applied to the nipples containing a plastic liner.

Turn off or disconnect the electrical power supply to the water heater before servicing. Label all wires prior to disconnection when servicing controls. Wiring errors can cause improper and dangerous operation. Verify proper operation after servicing.

## NOTICE

Before proceeding, please inspect the water heater and its components for possible damage. DO NOT install any water heater with damaged components. If damage is evident, then please contact the supplier where the water heater was purchased or the manufac-

## **WARNING**

Water heaters are heat producing appliances. To avoid damage or injury, do not store materials against the water heater or any of its components. Use proper care to avoid unnecessary contact, especially by children, with the water heater and its components. Under no circumstances must flammable materials, such as gasoline or paint thinner be used or stored in the vicinity of this water heater or in any location in which the fumes could reach the water heater.

Hydrogen gas can be produced in an operating water heater that has not had water drawn from the tank for a long period of time (generally two weeks or more). Hydrogen gas is extremely flammable. To prevent the possibility of injury under these conditions, we recommend a hot water faucet to be open for several minutes at the kitchen sink before you use any electrical appliance which is connected to the hot water system. If hydrogen is present, there will be an unusual sound such as air escaping through the pipes as hot water begins to flow. Do not smoke or have open flame near the faucet at the time it is open.

**DO NOT ATTEMPT TO LIGHT ANY GAS APPLIANCE IF YOU ARE NOT CERTAIN OF THE FOLLOWING:**

Liquefied petroleum gases/propane gas and natural gas have an odorant added by the gas supplier that aids in the detection of the gas. Most people recognize this odor as a "sulfur" or "rotten egg" smell. Other conditions, such as "odorant fade" can cause the odorant to diminish in intensity, or "fade," and not be as readily detectable. If you have a diminished sense of smell, or are in any way unsure of the presence of gas, immediately contact your gas supplier from a neighbor's telephone. Gas detectors are available. Contact your gas supplier, or plumbing professional for more information.

**FAILURE TO INSTALL AND MAINTAIN A NEW, LISTED 3/4" X 3/4" TEMPERATURE AND PRESSURE RELIEF VALVE WILL RELEASE THE MANUFACTURER FROM ANY CLAIM THAT MIGHT RESULT FROM EXCESSIVE TEMPERATURE AND PRESSURES.**

## The Bradford White DEFENDER Safety System<sup>®</sup>

The Bradford White DEFENDER Safety System was designed to resist the ignition of flammable vapors that can occur outside of the water heater. Use and installation are nearly identical to previous versions of atmospherically fired and vented water heaters. A number of exclusive design features are incorporated in the system that will require additional knowledge on the part of the qualified service provider. The following information will instruct service professionals on the function, proper diagnosis, and repair of water heaters employing the Bradford White DEFENDER Safety System.

### Introduction

The new Bradford White Residential Flue Damper water heaters are designed to provide reliable performance with enhanced standard features. New design features include reliable spark-to-pilot ignition system, enhanced diagnostics, simplified servicing, significantly quiet operation, and the Bradford White Defender Safety System.

**Spark-to-Pilot Ignition System** - employing the spark-to-pilot ignition system promotes reliable and consistent pilot and main burner ignitions to provide hot water on demand.

**Integrated Immersion Thermal Well/Gas Control with LED** - was developed for ease of troubleshooting by providing simple diagnostic codes to pinpoint an installation or component performance issue.

**Rugged Wiring Connections** - receptacle type connections promote error free wiring.

The gas control maintains water temperature, ignition sequence, and regulates gas flow. If a situation outside of normal operating parameters exists, the gas control diagnostic LED will flash a code to positively identify an operational issue.

This service manual is designed to facilitate problem diagnosis and enhance service efficiency. To further promote quicker service times, the gas control can be removed and replaced without draining the water heater. A special tool is required and will be provided with each gas control kit shipped from your Bradford White wholesale distributor.

Please read the service manual completely before attempting service on this new series of damper models.

### How the Safety System Works

During normal operation, air for combustion is drawn into the water heater through the openings in the jacket. This air travels down and around the combustion chamber and enters through holes in the very bottom of the corrosion resistant combustion chamber. The air then travels up through the flame arrestor louvers, where the velocity of the air is increased and its direction altered. The air then mixes in a normal manner with supplied gas and is efficiently combusted, producing very low NO<sub>x</sub> emissions.

In the unlikely event trace amounts of flammable vapors are present in the air flowing into the

## How to Use this Manual

combustion chamber, the vapors are harmlessly ignited by the burner. If flammable vapors are in sufficient quantity to prevent normal combustion, the flammable vapor sensor recognizes this and shuts down the pilot and main burner. Should the flammable vapors continue to burn, the flame arrestor prevents the flames from traveling backwards and igniting vapors outside of the combustion chamber. And, the resettable thermal switch will open and shut down the pilot and main burner.

### How to Use this Manual

It is intended for this manual to be used by qualified service personnel for the primary purpose of troubleshooting and repair of the Bradford White Residential Flue Damper water heaters. Understanding the sequence of operation section of this manual will contribute greatly to troubleshooting the water heater.

The Honeywell WV4460E Electronic Gas Control will display error codes in the event of abnormal operation. Error codes are listed in the troubleshooting chart beginning on page 13 of this service manual. The troubleshooting chart will also indicate the probable cause for the error code and direct the service professional to a service procedure to properly diagnose the abnormal operation.

Contact the Bradford White technical support group immediately if diagnosis cannot be made using the methods described in this service manual.

### Tools Required for Service

**Manometer:** A liquid "U" tube type or a digital (magna-helic) type can be used. This device is used to measure gas and/or air pressure and vacuum.

**Multi-Meter:** A digital type is strongly recommended. This device is used to measure electrical values. The meter you select must have the capability to measure volts AC, volts DC, amps, micro-amps and ohms.

**Electronic Probes:** In some cases, standard multi-meter probes will damage or simply not be effective to obtain certain voltage and ohm reading. It will be necessary to have special electronic "pin" type multi-meter probes. These probes are available at most electronic wholesale outlets.

**Thermometer:** Used to measure water temperature. An accurate thermometer is recommended.

**Water Pressure Gage:** Used to measure water supply pressure. Also used to determine tank pressure by adapting to the drain valve of the heater.

**Gas Control Service Tool:** BWC part number 239-45991-00. A specialized tool designed to remove the gas control from gas control thermal well. Available from your Bradford White parts supplier.

**Various Hand Tools:** Pipe wrench, channel locks, open end wrenches (3/8", 7/16", 1/2"), 12" crescent wrench, Allen wrench set, screw drivers (common & Phillips), 1/4" nut driver, pliers (common & needle nose), socket set, side cutters, wire cutters, wire strippers, wire crimpers, torpedo level, small shop vac, step ladder, flashlight, and 5 gallon pail.

<b>Power Supply</b>	Dedicated 120VAC, 60 Hz, 15A
<b>Gas Supply Pipe</b>	Minimum 1/2" NPT (Schedule 40 black iron pipe recommended)
<b>Approved Gas Type</b>	Natural or Propane; unit must match gas type supplied
<b>Gas Pressure</b>	5" w.c. minimum for Natural Gas; 11" w.c. for Propane; 14" w.c. maximum for Natural Gas / Propane
<b>Approved Vent Materials</b>	Single or Double Wall Metal Vent Pipe
<b>Minimum Clearance for Servicing</b>	18" from top; 24" from front; 4" from sides and rear
<b>Water Supply Pressure</b>	150 psi maximum allowable working pressure; check local codes for supply pressure
<b>ECO Limit</b>	188°F (87°C)
<b>Temperature Setpoint Range</b>	60°F (16°C) to 160°F (71°C); approximate temperatures

# Specifications

## Control Timings

Ignition State	Timing
Adjust Damper Position and Verify (Open Position)	15 seconds
Trial for Ignition	90 seconds
Flame Stabilization Period	3 seconds
Re-adjust Damper Position and Verify	15 seconds
Flame Failure Response Time	1.5 seconds (2 second maximum; 1 second minimum)
Adjust Damper Position and Verify (Closed Position)	15 seconds
Damper Blade Position Fault (failed open/close)	Retry after 2 minutes
Soft Lockout	Retry after 5 minutes
ECO Limit Lockout	Indefinite (See page 11 to reset)
Verify Resistive Delay	Retry after 2 minutes (repeats 5 times)
Simulated Resistive Load Lockout	Indefinite (cycle power to reset)
Hardware Error Lockout	Indefinite (self clears if fault clears for at least 15 seconds)

## Wiring Diagram

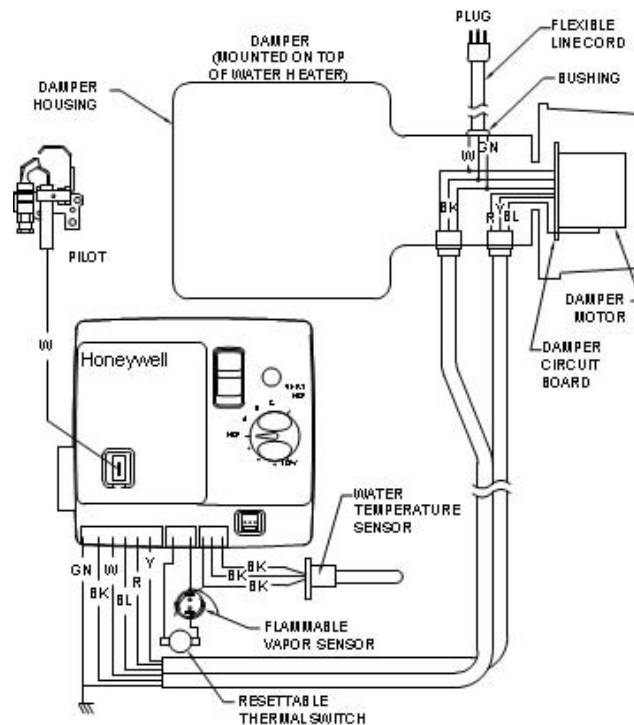



### Power Up Sequence

1. **Start-up:** Upon power up, the gas control runs a safe start check with a typical delay of 5 seconds.
2. **Flammable Vapor Verification:** The gas control verifies that the Flammable Vapor Sensor is in the proper operating range prior to energizing any components. If the sensor is within the proper range, the gas control resumes normal operation. If the Flammable Vapor Sensor is out of range, the gas control LED immediately flashes 7 times with a 3 second pause.

### Normal Heating Sequence

When the phrase “Damper Open” is used, this means that the damper blade is in the vertical position (open). Alternatively, “Damper Closed” means that the damper blade is in the horizontal position (closed). This must not be confused with the phrase “Damper Circuit Open,” as this means that the damper blade is in the horizontal position. “Damper Circuit Closed” means that the damper blade is in the vertical position, and the water heater can proceed to an ignition trial.

1. **Thermostat Calls for Heat:** Prior to energizing the damper, the gas control verifies the damper safety circuit to see if it is in the correct state. If the safety circuit is closed, the gas control LED flashes 2 times with a 3 second pause. The gas control waits 2 minutes. Then, the damper is powered closed. This cycle repeats until the safety circuit opens.
2. **Damper Powered Open**
3. **Damper Safety Circuit Check:** If the damper safety circuit does not close within 30 seconds, the gas control LED flashes 3 times with a 3 second pause. The damper is powered open for a maximum of 30 seconds every 2 minutes trying to close the damper safety circuit. This cycle repeats as long as there is a call for heat.
4. **Damper Hold Period** (15 seconds)
5. **Trial for Pilot Ignition** (90 seconds): The gas control lights the pilot by activating the spark igniter and gas flow to the pilot burner. If flame is not sensed within 90 seconds, the spark igniter and gas flow are deactivated. The damper will remain open, and the gas control LED flashes 6 times with a 3 second pause.
6. **Main Burner Ignition:** After pilot flame is sensed, the gas control activates the main valve for main burner ignition. The gas control will ignore flame signals for 3 seconds to allow for the main burner to stabilize.

## Sequence of Operation

### Normal Heating Sequence (cont'd)

7. **Steady State Operation:** During steady state operation, the gas control monitors:

Thermostat Temperature Sensor: When the setpoint temperature is satisfied, the gas control is shutdown, and the damper is powered closed. The gas control LED flashes a short flash once every 4 seconds (Idle status code).

Damper Position: If the damper position is altered during a call for heat, the pilot and main valves are shutdown. The damper is powered open attempting to close the damper safety circuit. The gas control LED flashes 3 times with a 3 second pause.

Flame Sensor: If flame is lost, the pilot and main valves are shutdown. The damper is powered open. The gas control attempts to re-light the pilot 4 times. If unsuccessful, the damper is closed, and the gas control proceeds to a 5 minute lockout. The gas control re-attempts to light the pilot starting at Normal Heating Sequence #2.

8. **Thermostat Satisfies:** Gas control LED flashes once every 4 seconds.
9. **Burner Off**
10. **Damper Powered Closed** (15 seconds)

### Abnormal Operation

1. **Flammable Vapor Sensor Fault:**

A) If the resistance is greater than 70,000 ohms: The gas control immediately turns off all outputs. The gas control waits and monitors resistance for 30 seconds. If the resistance is greater than 65,000 ohms after 30 seconds, the gas control proceeds to verify resistive delay for 2 minutes and flashes 7 times then 1 time with a three second pause. This process is repeated 5 times until the control either returns to normal operation or proceeds to flammable vapor lockout.

B) If the resistance is below 3000 ohms: The gas control immediately turns off all outputs and proceeds to flash 8 times then 1 time with a three second pause. The error self clears if the resistance returns to normal range for at least 15 seconds.

---

**Abnormal Operation (cont'd)****2. Temperature Sensor Fault:**

A) Temperature Sensor Open Circuit: The gas control immediately turns off all outputs and proceeds to flash 8 times then 3 times with a three second pause. The error self clears if the fault clears for at least 15 seconds.

B) Thermal well sensors not reading the same temperature within  $\pm 5.5^{\circ}\text{F}$ : The gas control immediately turns off all outputs and proceeds to flash 8 times then 3 times with three second pause. The error self clears if the fault clears for at least 15 seconds.

C) Water Temperature in excess of ECO (Energy Cut Off) Limit: The gas control immediately turns off the pilot and main valves. The gas control LED proceeds to flash 4 times with a 3 second pause.

To reset the gas control, rotate the setpoint knob to the minimum setting for at least 6 seconds before returning to desired temperature setting.

**3. Damper Safety Circuit Fault:**

A) Damper Failed to Open: The gas control proceeds to flash 3 times with a three second pause. The gas control waits 5 minutes, and then tries to open the damper again.

B) Damper Failed to Close: The gas control proceeds to flash 2 times with a three second pause. The gas control waits 5 minutes, and then tries to open the damper again.

**4. Trial for Ignition Fault:**

A) Damper Jostled During Trial: The gas control stops the trial for ignition. The gas control proceeds to flash 3 times with a three second pause. The gas control waits 5 minutes, and then tries to open the damper again.

B) Flame Not Sensed: The gas control energizes the spark igniter attempting to light the pilot and prove flame. If flame is not sensed within 90 seconds, the spark igniter turns off, the pilot valve is closed. The gas control LED flashes 6 times then 1 time with 3 second pause. The control waits 5 minutes before repeating the ignition sequence.

## Sequence of Operation

---

### Abnormal Operation (cont'd)

#### 5. Flame Sensing Fault:

A) Flame Lost During Run: The gas control turns off pilot and main valves. The gas control increments the recycle count, if the recycle count has not reached its limit (4), another trial for ignition begins. If the recycle count has been reached, the gas control LED flashes 6 times then 3 times with a 3 second pause. The gas control waits 5 minutes before repeating the ignition sequence.

B) Flame Sensed Out of Sequence: The gas control only looks for pilot flame when the damper is in the open position. If flame is present when the pilot valve is not open, the gas control proceeds to wait for flame loss and flashes 5 times with 3 second pause. This continues until flame is lost. Once the flame signal is lost, the control flashes 6 times then 4 times with a 3 second pause. The control waits 5 minutes before repeating the ignition sequence.

## Troubleshooting

Observe the green LED on the water heater gas control. Error codes are displayed with a 3 second pause before repeating. Once the error code is known, check and repair the water heater, as recommended in the table below.

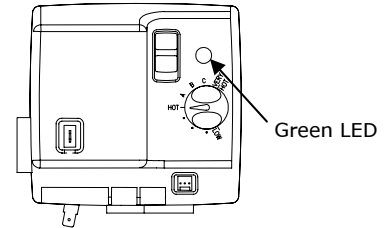

LED Status	Control Status	Probable Cause	Service Procedure
None (LED not on or flashing)	Electrical power not present	Control power switch in "OFF" position. Supply voltage interrupted.	Turn Power On
One short flash every four seconds	Stand-by mode, Thermostat is satisfied (no faults)	Temperature demand is satisfied (no call for heat)	Normal operation
Alternates bright and dim (heartbeat)	Thermostat calling for heat (no fault)	Tank temperature below setpoint of thermostat	Normal operation
Short flash once every second	Weak pilot signal on last call for heat	1. Unstable pilot 2. Pilot tube blocked or restricted 3. Oxidation build-up on pilot electrode 4. Wire damage to pilot assembly or bad connection at gas control	1. See Burner Inspection on page 15 2-4. See Pilot Inspection, Testing and Replacement on page 17
Two flashes, three second pause	Damper test circuit not working	1. Damper not in proper position or malfunctioning - stuck in open position 2. Obstructed venting 3. Faulty damper	1. Verify cord sets are fully plugged in 2. Verify switch on damper is in "Automatic" position 3. Verify that damper and venting is not obstructed
Three flashes, three second pause	Damper test circuit not working	1. Damper not in proper position or malfunctioning - not reaching full open position 2. Obstructed venting 3. Faulty damper	1. Verify cord sets are fully plugged in 2. Verify switch on damper is in "Automatic" position 3. Verify that damper and venting is not obstructed
Four flashes, three second pause	Excessive tank temperature, system must be reset	1. Thermal well sensor out of calibration 2. Faulty gas control	1. Test Gas Control & Thermal Well 2. Replace gas control if necessary
Five flashes, three second pause	False pilot flame present	Pilot valve stuck in open position	Replace gas control
Six flashes, one flash, three second pause (Soft Lockout)	Failed to light pilot, system resets after (5) minutes	1. Unstable pilot 2. Pilot tube block or restricted 3. Oxidation build-up on pilot electrode 4. Wire damage to pilot assembly or bad connection at gas valve	1. See Burner Inspection on page 15 2-4. See Pilot Inspection, Testing and Replacement on page 17

## Troubleshooting

LED Status	Control Status	Probable Cause	Service Procedure
Six flashes, two flashes, three second pause (Soft Lockout)	Damper test circuit not working properly during burner operation, system auto resets after (5) minutes	<ol style="list-style-type: none"> <li>1. Damper not in proper position or malfunctioning - damper moved from full open position during run cycle</li> <li>2. Obstructed venting</li> <li>3. Faulty damper</li> <li>4. Damper jostled during run cycle</li> </ol>	<ol style="list-style-type: none"> <li>1. See Burner Inspection on page 15</li> <li>2-4. See Pilot Inspection, Testing and Replacement on page 17</li> </ol>
Six flashes, three flashes, three second pause (Soft Lockout)	Pilot flame extinguished, system auto resets after (5) minutes	<ol style="list-style-type: none"> <li>1. Unstable pilot</li> <li>2. Pilot tube block or restricted</li> <li>3. Oxidation build-up on pilot electrode</li> <li>4. Wire damage to pilot assembly or bad connection at gas control</li> <li>5. Insufficient combustion air</li> <li>6. Insufficient gas pressure</li> </ol>	<ol style="list-style-type: none"> <li>1. See Burner Inspection on page 15</li> <li>2-4. See Pilot Inspection, Testing and Replacement on page 17</li> <li>5. Refer to Installation &amp; Operation Manual</li> </ol>
Six flashes, four flashes, three second pause	Undesired false pilot flame sensed, system auto resets	Pilot valve stuck in open position	Replace gas control
Seven flashes, three second pause	Flammable vapor sensor or resettable thermal switch fault detected, see warning label	<ol style="list-style-type: none"> <li>1. Flammable vapor present</li> <li>2. Flammable vapor sensor exposed to excessive moisture</li> <li>3. Flammable vapor sensor exposed to extreme ambient temperature</li> <li>4. Resettable thermal switch open</li> </ol>	See Flammable Vapor Sensor Testing on page 27
Eight flashes, one flash, three second pause	Flammable vapor sensor out of specification, possible short	<ol style="list-style-type: none"> <li>1. Flammable vapor sensor out of specification; verify Flammable Vapor Sensor (FVS) resistance is not below 25 kΩ.</li> <li>2. Possible short in flammable vapor sensor or resettable thermal switch wiring</li> </ol>	See Flammable Vapor Sensor Testing on page 27
Eight flashes, three flashes, three second pause	Thermal well sensor damaged or unplugged or gas control electronics fault detected	<ol style="list-style-type: none"> <li>1. Damage to thermal well wires</li> <li>2. Thermal well sensor resistance out of range</li> <li>3. Replace thermal well</li> <li>4. Verify control is not wet or physically damaged</li> <li>5. Reset control on/off switch</li> <li>6. Replace gas control if 8-3 error persists</li> </ol>	See Thermal Well Testing on page 21
Eight flashes, four flashes, three second pause	Gas control fault detected	<ol style="list-style-type: none"> <li>1. Verify control is not wet or physically damaged</li> <li>2. Reset control on/off switch</li> <li>3. Replace gas control if 8-4 error persists</li> </ol>	<ol style="list-style-type: none"> <li>1. Replace gas control if wet or physically damaged</li> <li>2. Cycle power</li> <li>3. Replace gas control</li> </ol>

## Burner Inspection

At periodic intervals (every 6 months), a visual inspection should be made of the pilot and main burner for proper operation and to assure no debris is accumulating. The pilot flame should be stable. Some causes for an unstable pilot flame are:

- a) Gas pressure is out of specification.
- b) Pilot flame not fully engulfing spark/flame sensor.

The main burner should light smoothly from the pilot and burn with a blue flame with a minimum of yellow tips.

Steel burner models self adjust air to gas ratio mixture and do not have an adjustable air shutter. The main burner must be free from any debris accumulation that may effect burner operation (See Burner Cleaning Procedure on page 15).

## Burner Cleaning Procedure

Step 1. Move the gas control power switch to the "OFF" position.

Gas control power switch



Step 2. Unplug the water heater from the wall outlet.

Damper (water heater) power cord

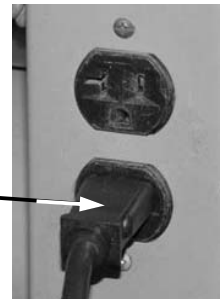

Step 3. Turn off the gas supply to the water heater.

Step 4. Remove the outer door.

Outer door

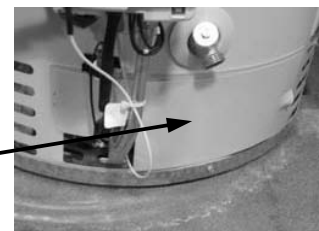

## Burner Maintenance

### Burner Cleaning Procedure (cont'd)

Step 5. Remove the (4) 1/4" hex drive screws holding the right side inner door in place.

(4) 1/4" hex drive screws

Right side inner door

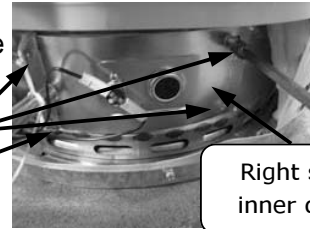

Step 6. Disconnect the pilot tube using a 7/16" wrench and the main burner feedline with a 3/4" wrench from the gas control.

Pilot and main feedlines



Step 7. Disconnect the spark igniter/flame sensor wire from gas control.

Gas control

Spark igniter/flame sensor wire



Step 8. Remove the burner assembly from the combustion chamber.

Burner assembly

Burner surface area and burner ports

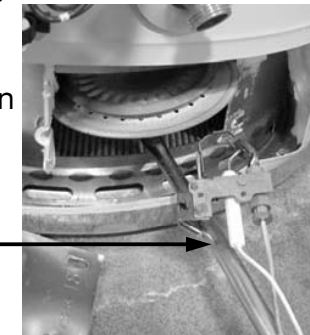

Step 9. Thoroughly inspect the burner surface area and burner port area and remove any loose debris.

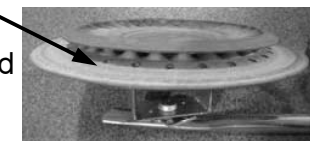

Step 10. Unscrew the burner from the main burner orifice.

Main feedline

Main burner orifice

1/2" wrench

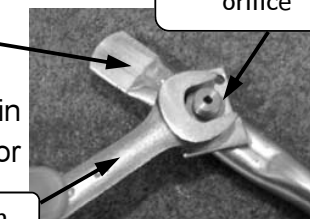



## Burner Cleaning Procedure (cont'd)

Step 12. Reassemble the burner assembly and reinstall into the water heater. Restore gas supply and check for gas leaks.

Step 13. To resume operation, follow the instructions located on the water heater lighting instruction label. Or, use the lighting instructions located in the water heater installation and operating manual.

## Pilot Inspection, Testing and Replacement

Step 1. Move the gas control power switch to the "OFF" position

Gas control power switch



Step 2. Unplug the water heater from the wall outlet.

Damper (water heater) power cord

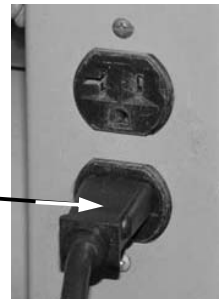

Step 3. Turn off the gas supply to the water heater.

Step 4. Remove the outer door.

Outer door

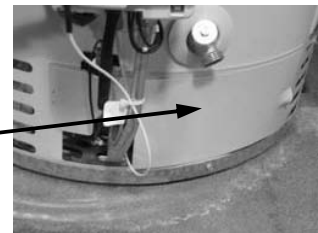

Step 5. Remove the (4) 1/4" hex drive screws holding the right side inner door in place.

(4) 1/4" hex drive screws

Right side inner door

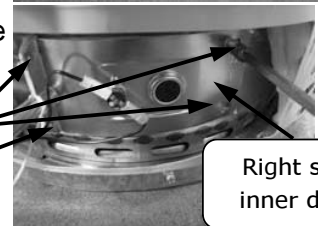

Step 6. Disconnect the pilot tube using a 7/16" wrench and the main burner feedline with a 3/4" wrench from the gas control.

Pilot and main feedlines



## Pilot Maintenance

### Pilot Inspection, Testing and Replacement (cont'd)

Step 7. Disconnect the spark igniter/flame sensor wire from gas control.

Gas control

Spark igniter/flame sensor wire



Step 8. Remove the burner assembly from the combustion chamber.

Burner assembly

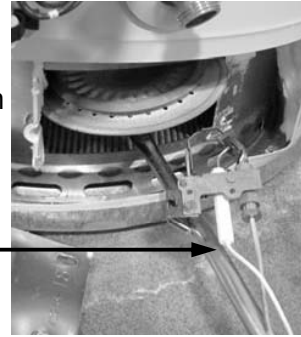

Step 9. Remove the pilot assembly from the main feedline using a 1/4" nut driver.

Pilot assembly

1/4" nut driver

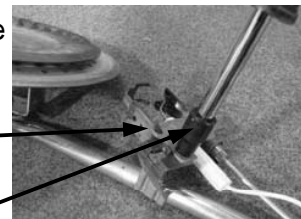

Step 10. Visually inspect the spark igniter/flame sense wire for damage. Replace the pilot assembly, if damage is found.

Step 11. With a multi-meter set to the ohms setting, check continuity through the spark igniter/flame sense wire. Replace the pilot, if there is no continuity.

Multi-meter

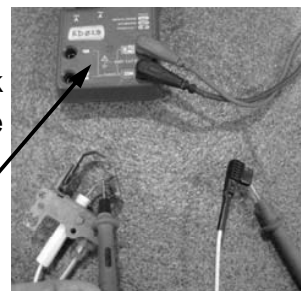

Step 12. Visually inspect the spark igniter/flame sense electrode for deterioration. Replace the pilot assembly, if necessary. The electrode should not be in contact with pilot hood. If it is in contact with the pilot hood, carefully adjust electrode to a gap distance of 3/32" from the pilot hood.

Step 13. Visually inspect the spark igniter/flame sense electrode for oxidation build up. Carefully clean any oxidation using very fine emery cloth.

## Pilot Inspection, Testing and Replacement (cont'd)

Step 14. Visually inspect the pilot tubing for kinks or cracks. If damage is found, replace the pilot assembly.

Step 15. Inspect the pilot tubing and pilot orifice for blockages:

- a) Remove ferrule nut from the bottom of the pilot assembly using a 7/16" wrench.
- b) Remove the pilot tube and pilot orifice.
- c) Inspect the pilot tubing and pilot orifice for blockages. Clean or replace, as necessary.

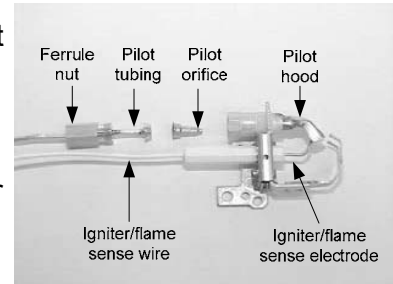

Step 16. Reassemble the pilot assembly and install it on the main feedline. Reinstall the burner assembly into the combustion chamber. Restore the gas supply and check for gas leaks.

Step 17. To resume operation, follow the instructions located on the water heater lighting instruction label. Or, use the lighting instructions located in the water heater installation and operating manual.

## Damper Removal & Installation

Step 1. Move the gas control power switch to the "OFF" position.

Gas control power switch



Step 2. Unplug the water heater from the wall outlet.

Damper (water heater) power cord

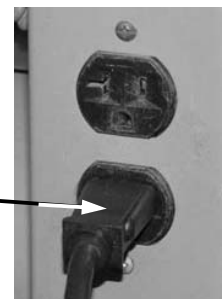

## Damper Replacement

### Damper Removal & Installation (cont'd)

Step 3. Disconnect the vent system from the draft hood that is mounted on top of the damper.

Vent system

Step 4. Remove the draft hood from the damper and retain it for use on the new damper.

Draft hood

Damper

Step 5. Unplug the cord sets from the damper.

Cord sets

Step 6. Remove the two damper mounting screws using a 1/4" nut driver and retain for later use.

1/4" nut driver

Step 7. Remove the damper from the top of the water heater.

Damper

Top of water heater

Water heater tank flue

Step 8. Clean any debris from the jacket head of the water heater.

Step 9. Set the new damper with in place using the water heater tank flue and the screw holes in the jacket head.

Step 10. Secure the damper in place using the screws from Step 6.

Step 11. Re-install the draft hood from Step 4.

Step 12. Reconnect the vent system to the draft hood.

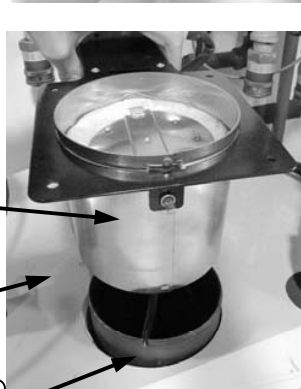
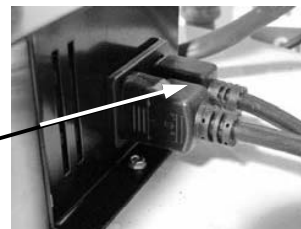
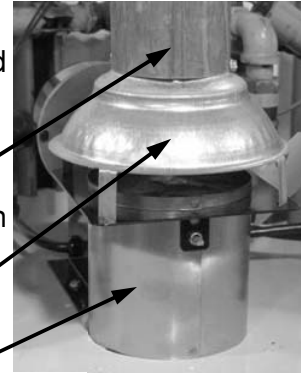

### Damper Removal & Installation (cont'd)

- Step 13. Reconnect the cord sets from Step 5.
- Step 14. Plug the water heater into the wall outlet.
- Step 15. Move the gas control power switch to the "ON" position.
- Step 16. Verify proper damper operation.

### Thermal Well Testing



## CAUTION

Do not use standard multi-meter probes for this testing. Doing so will damage the connector. Use special pin type electronic probes or small diameter wire pins inserted into connector.

Follow the procedure, below, if the water heater gas control has gone into a ECO lockout (4 flash, 3 second pause). Reset the gas control by rotating the setpoint knob to the minimum setting for at least 6 seconds before returning to the desired water temperature setting.

- Step 1. Unplug the thermal well connector from the gas control.

Thermal well connector

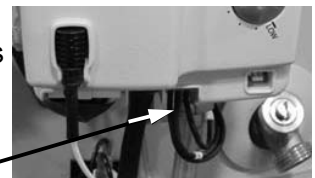

- Step 2. With a multi-meter set to the ohms setting, measure the resistance between the middle and right side wires.

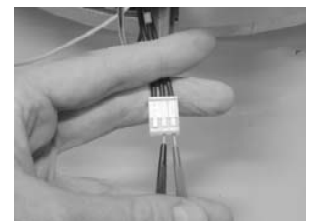

- Step 3. With a multi-meter set to the ohms setting, measure the resistance between the middle and left side wires.

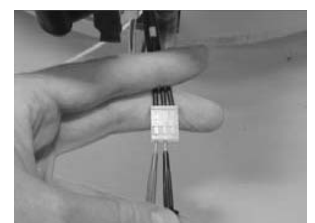

## Determine Tank Temperature

### Thermal Well Testing (cont'd)

Determine the correct resistance values using the Determine the Water Temperature Inside the Tank procedure on page 23. If the values are correct, replace the gas control, otherwise replace the thermal well.

### Determine Water Temperature Inside Tank

#### **WARNING**

Stored water may be HOT when performing the following steps in this procedure. Take necessary precaution to prevent personal injury.

Note: It is important to understand once the resistance for the thermal well is determined using the Thermal Well Testing Procedure on page 21, water flow through the water heater should not occur. Prior to performing the steps below, turn off the cold water supply to the water heater. This will prevent cold water flow into the tank affecting the resistance value of thermal well.

Step 1. Move the gas control power switch to the "OFF" position.

Gas control power switch



Step 2. Draw approximately 4 gallons of water from the drain valve into a container and discard. Draw an additional gallon and immediately measure the water temperature using an accurate thermometer. It may be necessary to open a hot water faucet to allow heater to drain.

Step 3. Using the chart on page 23, determine the correct resistance value for the water temperature from Step 2.

Example: If temperature of water is 84°F, then the resistance through the sensor would be 8449 (see shaded area). NOTE: Sensor resistance increases as the temperature falls.

## Sensor Resistance at Various Temperatures

In Degrees F										
°F	0	1	2	3	4	5	6	7	8	9
40	26109	25400	24712	24045	23399	22771	22163	21573	21000	20445
50	19906	19383	18876	18383	17905	17440	16990	16553	16128	15715
60	15314	14925	14548	14180	13823	13477	13140	12812	12494	12185
70	11884	11592	11308	11032	10763	10502	10248	10000	9760	9526
80	9299	9078	8862	8653	8449	8250	8057	7869	7685	7507
90	7333	7165	7000	6839	6683	6531	6383	6238	6098	5961
100	5827	5697	5570	5446	5326	5208	5094	4982	4873	4767
110	4663	4562	4464	4368	4274	4183	4094	4006	3922	3839
120	3758	3679	3602	3527	3453	3382	3312	3244	3177	3112
130	3048	2986	2925	2866	2808	2752	2697	2643	2590	2538
140	2488	2439	2391	2344	2298	2253	2209	2166	2124	2083
150	2043	2004	1966	1928	1891	1856	1820	1786	1753	1720
160	1688	1656	1625	1595	1566	1537	1509	1481	1454	1427
170	1402	1376	1351	1327	1303	1280	1257	1235	1213	1191
180	1170	1150	1129	1110	1090	1071	1053	1035	1017	999
190	982	965	949	933	917	901	886	871	857	842
200	828	814	801	788	775	762	749	737	725	713

### Gas Control & Thermal Well Removal From Water Heater

Step 1. Move the gas control power switch to the "OFF" position.

Gas control power switch



Step 2. Unplug the water heater from the wall outlet.

Damper (water heater) power cord

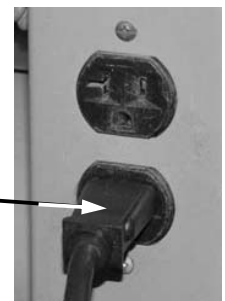

Step 3. Drain the water heater to a point below the gas control level.

Step 4. Turn off the gas supply to the water heater and disconnect the gas piping from the gas control.



## Gas Control Removal

### Gas Control & Thermal Well Removal From Water Heater (cont'd)

Step 4. Disconnect the pilot tube using a 7/16" wrench and the main burner feedline with a 3/4" wrench from the gas control.



Pilot and main feedlines

Step 5. Disconnect the wire harnesses and spark igniter/flame sense wire from the gas control.

Gas control

Spark igniter/flame sensor wire



Step 6. Remove the gas control & thermal well by rotating the flats of the Thermal Well counter clockwise using a 1-5/16" wrench.

Flats of thermal well



### Gas Control Removal From Thermal Well

Following the steps below allows for the removal of the gas control from the thermal well without removing the thermal well from the tank.

Step 1. Move the gas control power switch to the "OFF" position.

Gas control power switch



Step 2. Unplug the water heater from the wall outlet.

Damper (water heater) power cord

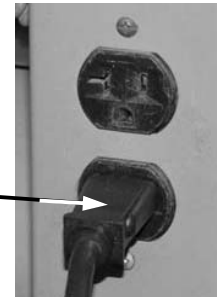



## Gas Control Removal From Thermal Well (cont'd)

Step 3. Turn off the gas supply to the water heater and disconnect the gas piping from the gas control.

Step 4. Disconnect the pilot tube using a 7/16" wrench and the main burner feedline with a 3/4" wrench from the gas control.



Pilot and main feedlines

Step 5. Disconnect the wire harnesses and spark igniter/flame sense wire from the gas control.

Gas control

Spark igniter/flame sensor wire



Step 6. Using the gas control service tool, p/n 239-45991-00, available from your BWC parts supplier, insert the tool into the back of the gas control.

Gas control service tool



Step 7. Pivot the tool towards the water heater, as far as possible. Lift straight up on the gas control. The gas control should move about 1/8". Hold the gas control in position and remove the tool. Lift straight up on the gas control to remove it completely from the thermal well.

## Gas Control Assembly to the Thermal Well

Step 1. Install the threaded end of the thermal well into the tank. Be sure the thermal well flange is positioned properly to allow for proper gas control installation. Tighten the thermal well using a 1-5/16" wrench.

## Gas Control Assembly

### Gas Control Assembly to the Thermal Well (cont'd)

Step 2. Route the wire leads back into relief opening.

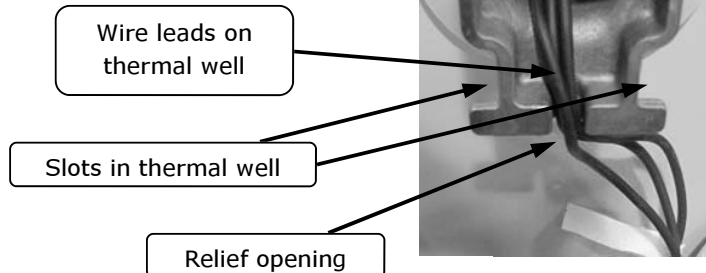

Step 3. Align the slots located on the thermal well flange with the tabs located on the back of the gas control.

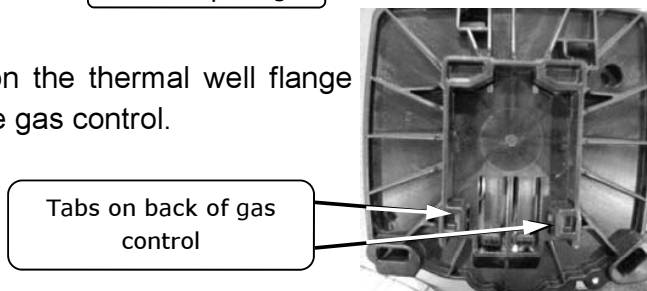

Step 4. Carefully push the gas control back onto the thermal well flange as far as possible towards the water heater. Then, slide the gas control down to lock into position.

Step 5. Install the burner assembly and connect the pilot and main feedlines to the gas control using a 7/16" and 3/4" wrench, respectively.

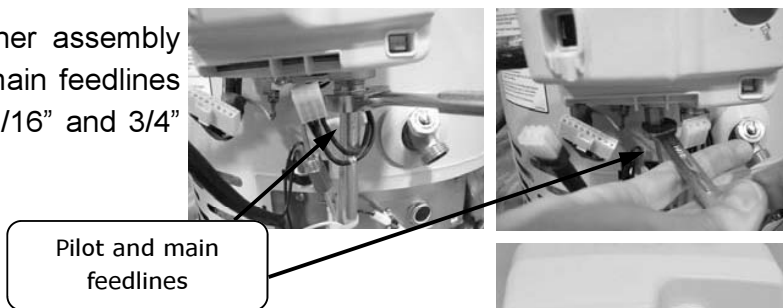

Step 6. Reconnect the wire harnesses to the gas control.



Step 7. Reconnect the gas piping to the gas control. Restore the gas supply and check for gas leaks.

## Flammable Vapor Sensor Testing

### Gas Control Assembly to the Thermal Well (cont'd)

Step 8. To resume operation, follow the instructions located on the water heater lighting instruction label. Or, use the lighting instructions located in the water heater installation and operating manual.

### Flammable Vapor Sensor Testing



## CAUTION

Do not use standard multi-meter probes for this testing. Doing so will damage the connector. Use special pin type electronic probes or small diameter wire pins inserted into connector.

Step 1. Move the gas control power switch to the "OFF" position.

Gas control power switch



Step 2. Disconnect the flammable vapor sensor harness from the gas control.

Step 3. Using a multi-meter set to the ohms setting, measure the resistance of the flammable vapor sensor and resettable thermal switch. The resistance must be between 3,000 and 48,000 ohms. If the resistance is out of this range, verify that the resettable thermal switch has not been tripped. If it hasn't, replace the thermal switch.

Flammable vapor sensor harness

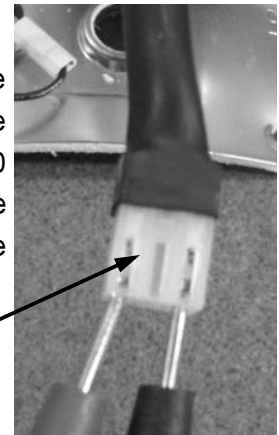

### 120 VAC Circuit Trace

Step 1. Verify 120VAC and proper polarity are at the wall outlet.

Step 2. With the water heater plugged in and the gas control power switch in the "ON" position verify LED status.

## Dip Tube Inspection

### Dip Tube Inspection and Replacement



Water heater components and stored water may be HOT when performing the following steps in this procedure. Take necessary precaution to prevent personal injury.

- Step 1. Move the gas control power switch to the “OFF” position
- Step 2. Unplug the water heater from the wall outlet.
- Step 3. Turn off the cold water supply to the water heater. Connect a hose to the drain valve of the water heater and route to an open drain. Open a nearby hot water faucet to vent the water heater for draining. Open the drain valve of water heater and allow the water heater to drain to a point below the inlet connection nipple.
- Step 4. Disconnect the inlet nipple from the plumbing system.
- Step 5. With an appropriate tool, such as a pipe wrench, remove the inlet nipple/diptube from the water heater. Use caution not to damage pipe threads.
- Step 6. Visually inspect the inlet nipple/diptube. The inlet nipple/diptube should be free of cracks and any blockage. Hydro-jet slots should be open and free of any blockage. Any damage, such as cracks, restriction due to deformation, or unintentional holes are not field repairable and the inlet nipple/diptube must be replaced.
- Step 7. Upon completion of the inspection or subsequent replacement, reinstall the inlet nipple/diptube into the water heater. Connect the nipple to the plumbing system, resume water supply to the water heater, and refill the water heater.
- Step 8. To resume operation, follow the instructions located on the water heater lighting instruction label. Or, use the lighting instructions located in the water heater installation and operating manual.

### Anode Inspection and Replacement



## WARNING

Water heater components and stored water may be HOT when performing the following steps in this procedure. Take necessary precaution to prevent personal injury.

- Step 1. Move the gas control power switch to the "OFF" position
- Step 2. Unplug the water heater from the wall outlet.
- Step 3. Turn off the cold water supply to the water heater. Connect a hose to the drain valve of the water heater and route to an open drain. Open a nearby hot water faucet to vent the water heater for draining. Open the drain valve of water heater and allow the water heater to drain to a point below the outlet connection nipple.
- Step 4. Disconnect the outlet nipple from the plumbing system.
- Step 5. With an appropriate tool, such as a pipe wrench, remove the outlet nipple/anode from the water heater. Use caution not to damage the pipe threads.
- Step 6. Visually inspect the outlet nipple/anode. The outlet nipple/anode should show signs of depletion, which is normal. If depletion is one-half the original anode diameter (approximately 3/4" diameter), replacement is recommended. If any of the steel core of the anode is exposed, replacement is recommended.
- Step 7. Upon completion of the inspection or subsequent replacement, reinstall the outlet nipple/anode into the water heater. Connect the nipple to the plumbing system, resume water supply to the water heater, and refill the water heater.
- Step 8. To resume operation, follow the instructions located on the water heater lighting instruction label. Or, use the lighting instructions located in the water heater installation and operating manual.

# Damper Removal

## Remove the Damper to Gain Access to the Flue Baffle

Step 1. Move the gas control power switch to the "OFF" position.

Gas control power switch



Step 2. Unplug the water heater from the wall outlet.

Damper (water heater) power cord

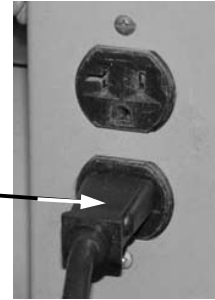

Step 3. Disconnect the vent system from the draft hood that is mounted on top of the damper.

Vent system

Draft hood

Damper

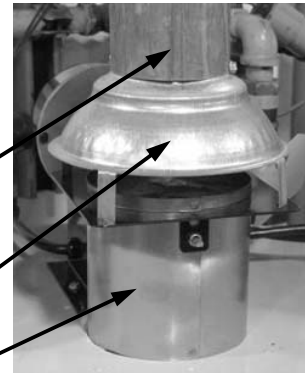

Step 4. Unplug the cord sets from the damper.

Cord sets

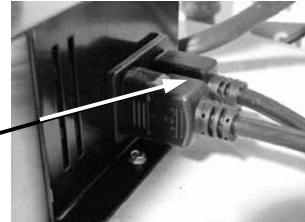

Step 5. Remove the two damper mounting screws using a 1/4" nut driver and retain for later use.

1/4" nut driver

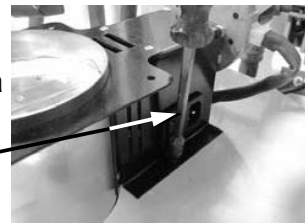

### Remove the Damper to Gain Access to the Flue Baffle (cont'd)

Step 6. Remove the damper from the top of the water heater.

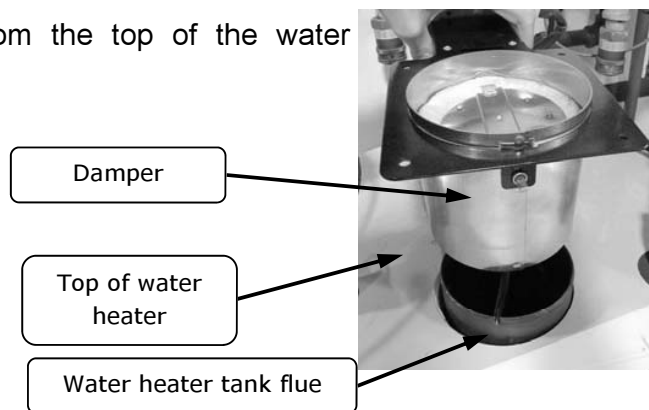

Step 7. Remove the flue baffle from the water heater.

Step 8. Inspect the baffle for deterioration and missing restrictors. Clean any scale or debris build-up. Replace with a new baffle, as necessary.

Step 9. Reinstall the baffle into the flue. Be sure the baffle hanger tab is inserted into the notch locations at the top of the flue.

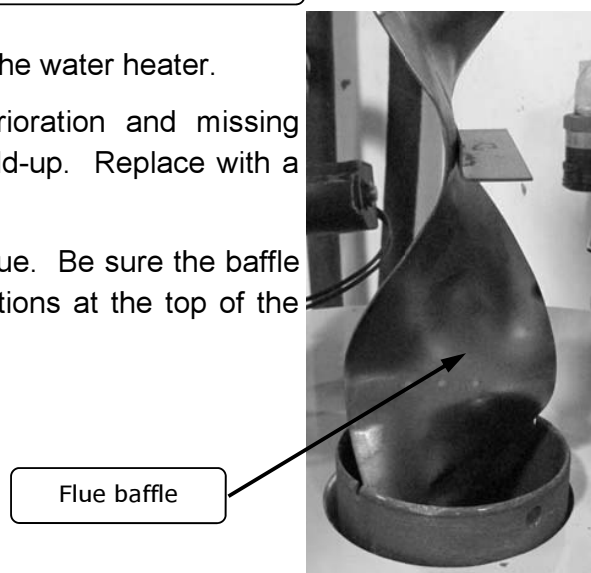

Step 10. Check the burner to ensure no scale has accumulated during operation. See the Burner Cleaning Procedure on page 15, if accumulation has occurred.

Step 11. Secure the damper in place using the screws from Step 5.

Step 12. Reconnect the vent system to the draft hood.

Step 13. Reconnect the cord sets from Step 4.

Step 14. Plug the water heater into the wall outlet.

Step 15. To resume operation, follow the instructions located on the water heater lighting instruction label. Or, use the lighting instructions located in the water heater installation and operating manual.

## Inner Door Removal

### Inner Door Removal Procedure

Step 1. Move the gas control power switch to the "OFF" position.

Gas control power switch



Step 2. Unplug the water heater from the wall outlet.

Damper (water heater) power cord

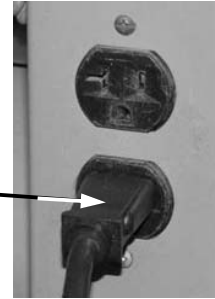

Step 3. Remove the outer door.

Outer door

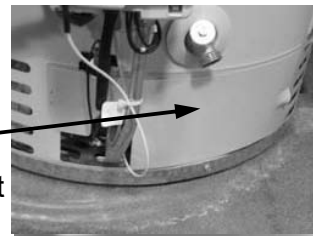

Step 4. Remove (4) 1/4" hex drive screws from the right side inner door.

(4) 1/4" hex drive screws

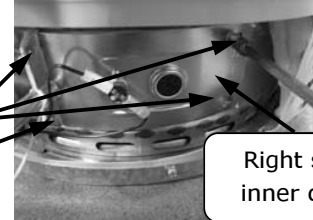

Right side inner door

Step 5. Remove (2) 1/4" drive screws from the left side inner door.

Step 6. Remove the connectors attached to the resettable thermal switch on the right side inner door.

Connectors attached to resettable thermal switch

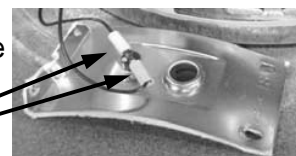



## Inner Door Gasket Replacement

### Inner Door Removal Procedure (cont'd)

Step 7. Inspect both inner doors for any of the following imperfections: tears, missing material, cracks, dirt or debris, lack of adhesion to the inner door, material left on combustion chamber, or any other imperfections that will inhibit a proper seal.

If any of the imperfections above are present, replace the inner door gasket following the Inner Door Gasket Replacement Procedure. If not, replacement of the inner door gaskets is not necessary.

### Inner Door Gasket Replacement Procedure



## WARNING

If the information in these instructions is not followed exactly, a fire or explosion may result causing property damage, personal injury, or death.

Step 1. Completely remove all gasket and adhesive residue from the right and left side inner doors, as needed.

Step 2. Using RTV sealant, apply a 1/8" bead to secure the inner door gasket to the inner door sections. Refer to the illustration for proper application. Note the overlap configuration in the flange area of the inner door. Set the flange section first, and this will help to achieve the proper overlap position.

Recommended pattern for RTV sealant



Gasket Overlap must be as shown  $\pm 1/32$

Enlarged view of flange area

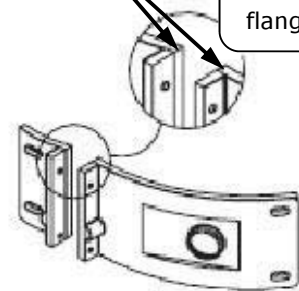

Gasket Overlap must be as shown  $\pm 1/32$

Expanded view

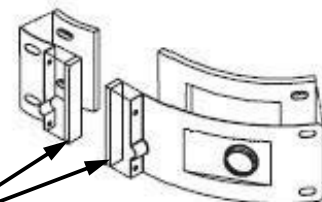

## Inner Door Installation

### Inner Door Installation with Gasket

#### **WARNING**

Stripped fastener connections may allow for an inner door seal breach. A seal breach may result in a fire or explosion, causing property damage, personal injury, or death. Do not over tighten screws. If a fastener connection is stripped, contact the manufacturer listed

Step 1. Clean any residual gasket residue or other debris from the combustion chamber surface before installing the inner door/gasket assembly.

Step 2. Place the left side inner door into position first, being sure to firmly position the concave channel of the inner door around the feedline.

Step 3. Using the 1/4" hex drive screws removed in Step 5 of the Inner Door Removal Procedure on page 32, secure the left side inner door in place. Do not over-tighten the screws.

Step 3. Position the pilot tube and spark igniter wire against the left side inner door flange gasket. Do not route these through the concave channel with the feedline.

Step 4. Firmly place the right side inner door flange against the left side inner door flange.

Step 5. Using the 1/4" hex drive screws removed in Step 4 of the Inner Door Removal Procedure on page 32, secure the two flanges together. Do not over-tighten the screws.

Step 6. Align the right side inner door to the combustion chamber and verify the fastener holes of the combustion chamber are aligned with the right side inner door slotted openings. Verify seal integrity around the combustion chamber opening.

Step 7. Using the 1/4" hex drive screws removed in Step 3 of the Inner Door Removal Procedure on page 32, secure the right side inner door. Do not over-tighten the screws. Verify that both the left and right side inner doors are properly positioned and sealed against the combustion chamber.

Step 8. Re-install the outer door.

Step 9. To resume operation, follow the instructions located on the water heater lighting instruction label. Or, use the lighting instructions located in the water heater installation and operating manual.

### ScreenLok® Flame Arrestor Cleaning Procedure

- Step 1. Move the gas control power switch to the "OFF" position and unplug the water heater from the wall outlet.
- Step 2. Remove the outer door.
- Step 3. Remove the right side inner door per the Inner Door Removal Procedure on page 32.
- Step 4. Disconnect the pilot tube using a 7/16" wrench and the main burner feedline with a 3/4" wrench from the gas control.
- Step 5. Disconnect the spark igniter/flame sensor wire from gas control.
- Step 6. Remove the burner assembly from the combustion chamber.
- Step 7. Clean the ScreenLok® flame arrestor using a stiff brush, compressed air, and/or a shop vacuum to remove any scale or other debris accumulation. Using a soft brush, clear jacket openings from any dirt, dust, restrictions, or other obstructions.
- Step 8. Remove any debris from the burner assembly following the Burner Cleaning Procedure on page 15.
- Step 9. Re-install the burner assembly.
- Step 10. Reconnect the main and pilot tubing and spark igniter wire to the gas control.
- Step 11. Re-install the inner door per the Inner Door Installation with Gasket Procedure on page 34.
- Step 12. To resume operation, follow the instructions located on the water heater lighting instruction label. Or, use the lighting instructions located in the water heater installation and operating manual.

### Damper Relay Installation

If the damper fails and water heater operation is necessary temporarily, a relay, p/n 233-47642-00, and harness, p/n 239-48471-00, can be ordered from the Bradford White Service Parts Department.

- Step 1. Move the gas control power switch to the "OFF" position.

Gas control power switch



# Damper Relay Installation

## Damper Relay Installation (cont'd)

Step 2. Unplug the water heater from the wall outlet.

Damper (water heater) power cord

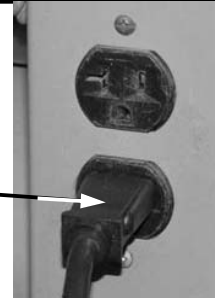

Step 3. Disconnect the vent system from the draft hood that is mounted on top of the damper.

Vent system

Draft hood

Damper

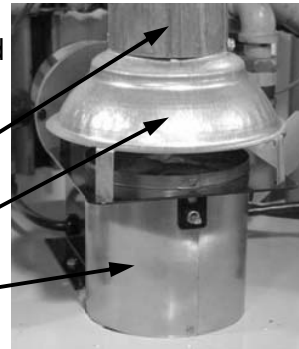

Step 4. Remove the draft hood from the damper and retain it for use on the new damper.

Step 5. Unplug the cord sets from the damper.

Cord sets

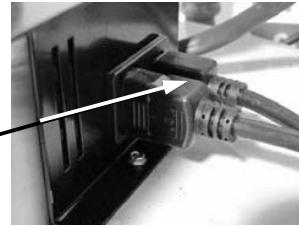

Step 6. Remove the two damper mounting screws using a 1/4" nut driver and retain for later use.

1/4" nut driver

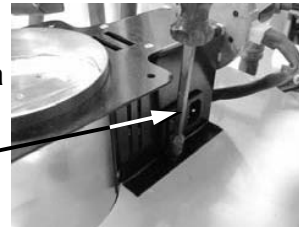

Step 7. Move the damper blade to the vertical position.

Damper Blade



Step 8. Move the switch on the back to the damper to the "Service" position (towards the front of the water heater).

Service Switch

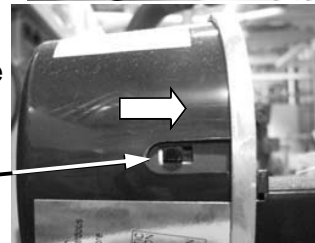

## Damper Relay Installation

### Damper Relay Installation (cont'd)

Step 9. Turn the damper on its side and lay it on top of the water heater.

Step 10. Remove the Red wire in the damper housing from its location. Connect the 1/4" Red female connector on the relay harness in its place.

Step 11. Remove the Yellow wire in the damper housing from its location. Connect the 1/4" Yellow female connector on the relay harness in its place.



Step 12. Remove the Blue wire in the damper housing from its location. Connect the 1/4" Blue female connector on the relay harness in its place.

Step 13. Remove the White wire in the damper housing from its location. Connect the 1/4" White female connector on the relay harness in its place.

Step 14. Using the White wire that was removed in Step 13, connect it to the piggyback spade connector that was installed in Step 13.

Step 15. Connect the other ends of the relay harness, as shown.

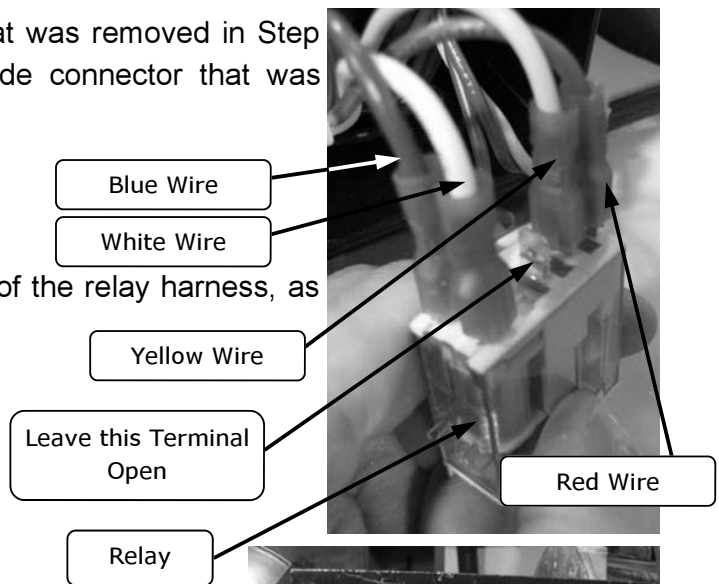

Step 16. Place the relay and its harness fully inside the damper housing.

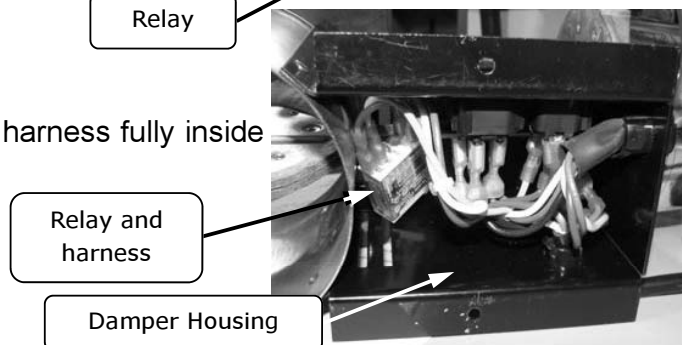

## Common Terms

### Common Terms

BTU	British Thermal Units
ECO	Energy Cut Off
GPM	Gallons per Minute
Hz	Hertz
KWh	Kilowatts per hour
LED	Light Emitting Diode
NPT	National Pipe Thread
Ohms	Ohms of resistance
PSI	Pounds per Square Inch
RPM	Revolutions per Minute
VAC	Volts Alternating Current
W.C.	Inches of Water Column
°C	Degrees Centigrade
°F	Degrees Fahrenheit

### NOTES

---

---

---

---

---

---

---

---

---

---

---

---

---

---

---

---

---

---

---

---

---

---

---

---

---

# Parts List

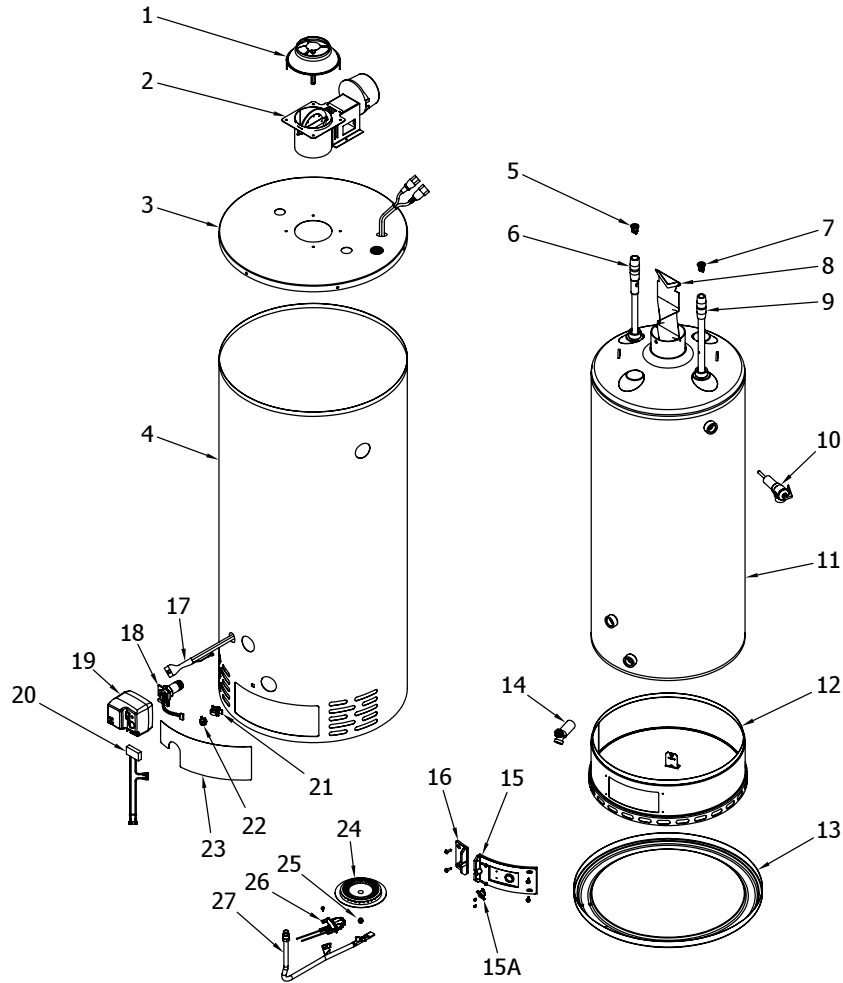

PART NAME AND DESCRIPTION	
1. Draft Hood	15. Inner Door (Right)
2. Damper	15A. Resettable Thermal Switch
3. Jacket Head Pan	16. Inner Door (Left)
4. Jacket	17. Damper Wire Harness
5. Heat Trap—Cold Water Inlet	18. Thermal Well
6. Magnesium Anode—Hot Water Outlet	19. Gas Control Valve
7. Heat Trap—Cold Water	20. Wire Harness (FVS / RTS)
8. Flue Baffle Assembly	21. FVS Sensor Clip
9. Dip Tube—Cold Water Inlet	22. Flammable Vapor Sensor (FVS)
10. Temperature and Pressure Relief Valve	23. Outer Door
11. Glass Lined Tank	24. Steel Burner
12. Combustion Chamber Assembly	25. Orifice
13. Jacket Base Pan	26. Pilot Assembly
14. Drain Valve	27. Feedline



# **BRADFORD WHITE®**

W A T E R H E A T E R S

Ambler, PA

For U.S. and Canada field service,  
contact your professional installer or  
local Bradford White sales representative.

**Sales/800-523-2931**  
**Fax/215-641-1670**  
**Parts Fax/215-641-2180**

**Technical Support/800-334-3393**  
**Fax/269-795-1089**

**Warranty/800-531-2111**  
**Fax/269-795-1089**

**International:**  
**Telephone/215-641-9400**  
**Telefax/215-641-9750**



# **BRADFORD WHITE-CANADA® INC.**

Mississauga, ON

**Sales/866-690-0961**  
**905-238-0100**

**Fax/905-238-0105**

**Technical Support/800-334-3393**

**Email**

**parts@bradfordwhite.com**  
**techserv@bradfordwhite.com**

**www.bradfordwhite.com**



## Free Manuals Download Website

<http://myh66.com>

<http://usermanuals.us>

<http://www.somanuals.com>

<http://www.4manuals.cc>

<http://www.manual-lib.com>

<http://www.404manual.com>

<http://www.luxmanual.com>

<http://aubethermostatmanual.com>

Golf course search by state

<http://golfingnear.com>

Email search by domain

<http://emailbydomain.com>

Auto manuals search

<http://auto.somanuals.com>

TV manuals search

<http://tv.somanuals.com>