



BRADFORD WHITE[®]
W A T E R H E A T E R S

**PDV(S,T) MODEL SERIES AND INDUCED DRAFT (D80T725,
D65T625) MODEL SERIES WATER HEATERS WITH
HONEYWELL INTEGRATED CONTROL SYSTEM**

SERVICE **MANUAL**

**Troubleshooting Guide
and Instructions for Service**
(To be performed **ONLY** by qualified service providers)



(PDV80S Shown)

PDV80S150
PDV802200
PDV80S250
PDV100S150
PDV100S200
PDV100S250
PDV80T300
PDV100T360
D80T725
D65T625

Table of Contents

	<u>Page</u>	<u>PDV Service Procedure</u>
Introduction	4	---
Tool required for service	4	---
Sequence of Operation	6	---
Troubleshooting	7	---
Thermostat Circuit Testing	24	PDV24-I
Pressure Switch Testing	27	PDV24-II
Pilot Operation Testing	30	PDV24-III
Main Burner Operation Testing	33	PDV24-IV
Main Burner & Pilot Removal & Inspection	35	PDV24-V
Control Board Replacement	40	PDV24-VI
Flue Baffle Removal & Inspection	41	PDV24-VII
Anode Removal & Inspection	42	PDV24-VIII
Generic Parts List - PDV-S	43	---
Generic Parts List - PDV-T	46	---
Generic Parts List - Induced Draft Models	49	---
Glossary of Terms	52	---

FEATURES OF PDV-S MODEL SERIES

- Power vented direct vent design, uses a blower to vent the flue products to the outside and pull combustion air in from outside the building
- Independent Venting - Exhausts flue products and supplies combustion air through two separate 3" or 4" PVC, CPVC or ABS pipes. Maximum venting distance of 40 ft. with one 90 degree elbow for each pipe in 3". The 250,000 Btu/hr. model vents with 4" PVC, CPVC, or ABS only. Maximum vent length is 55 feet with one 90 degree elbow in 4" pipe (each pipe) for all models.
- Electronic ignition - Pilot is automatically lit and monitored by the Honeywell Integrated Ignition Control system. Main burners light from the pilot. Pilot and main burners shut off at the end of each water heating cycle.
- Electronic thermostat and LCD Display - Accurately monitors the tank temperature and the setpoint is easily adjusted by using the temperature UP and DOWN buttons on the display on the control box cover.

FEATURES OF PDV-T MODEL SERIES

- Power vented direct vent design, uses a blower to vent the flue products to the outside and pull combustion air in from outside the building
- Co-axial Venting (pipe inside a pipe) - Combustion air enters from outside the building through an outer pipe and exhausts flue products through the inside pipe. May be vertically or horizontally vented with a maximum venting distance of 19'-6" (19 feet, 6 inches) with one 90 degree elbow.
- Electronic ignition - Pilot is automatically lit and monitored by the Honeywell Integrated Ignition Control system. Main burners light from the pilot. Pilot and main burners shut off at the end of each water heating cycle.
- Electronic thermostat and LCD Display - Accurately monitors the tank temperature and the setpoint is easily adjusted by using the temperature UP and DOWN buttons on the display on the control box cover.

FEATURES OF INDUCED DRAFT MODELS

- High Capacity power vented design, uses a blower to pull the flue products out the water heater. Designed to vent vertically through 8 inch diameter type B venting system. Uses room air for combustion.
- Electronic ignition - Pilot is automatically lit and monitored by the Honeywell Integrated Ignition Control System. Main burners light from the pilot. Pilot and main burners shut off at the end of each water heating cycle.
- Electronic thermostat and LCD Water Heater Control Display - Accurately monitors the tank temperature and the setpoint and is easily adjusted by using the temperature UP and DOWN buttons on the display on the control box cover.

FEATURES OF HONEYWELL INTEGRATED CONTROLS SYSTEM

- Attractive digital water heater display on control panel for setting and displaying the temperature setpoint. Pressing temperature up and down buttons changes the temperature setpoint. Same water heater display used on all models. Temperature format may be displayed in degrees F or degrees C.
- Single control board with plug in wiring controls temperature, ignition, and blower operation.
- Reduced number of parts for servicing and wiring.
- Plug in wiring reduces chance of miswiring.
- Water heater display will show diagnostic codes in the event the water heater needs servicing. Aids in diagnosing and servicing the water heater.
- Water heater display can show previous error code history to further aid in servicing the water heater.

It is intended for this manual to be used by qualified service personal for the primary purpose of troubleshooting analysis and repair of the Bradford White PDV & Induced Draft Series Water Heaters. Understanding the sequence of operation section of this manual will contribute greatly to troubleshooting this product.

Troubleshooting begins by noting the error code, if any, on the water heater control display and finding the section in this service manual for diagnosing the problem for this error code. This step by step procedure beginning on page 5 will direct the service provider to a series of test procedures to determine root cause of failure.

Contact Technical support immediately if diagnosis is not determined using the methods described in this service manual.

Tools Required for Service

Manometer:	Two types available, a liquid "U" tube type or a digital (magna-helic) type. This device is used to measure gas and/or air pressures and vacuum.
Multi-Meter:	A digital type is strongly recommended. This device is used to measure electrical values. The meter you select must have the capability to measure volts AC, volts DC, Amps, micro-amps and ohms.
Thermometer:	Used to measure water temperature. An accurate thermometer is recommended.
Water Pressure Gage:	Used to measure water supply pressure. Also used to determine tank pressure by adapting to the drain valve of the heater.
Jumper Leads:	A length of wire (12" min.) with alligator clip at both ends.
Various Hand Tools:	Pipe wrench, channel locks, open end wrench set, 12" crescent wrench, Allen wrench set, torx bit set, screw drivers (common & phillips), long reach (12") magnetic tip phillips head screw driver #2 tip, ¼" nut driver, pliers (common & needle nose), socket set including a 1-1/16 deep well socket, wire cutters, wire strippers, wire crimpers, torpedo level, small shop vac, step ladder, and flashlight.

Specifications

Power Supply	Dedicated 120 VAC, 60 Hz., 15 A
Current Draw	Less than 5 Amps
Gas Supply Connection	PDV-S & PDV-T MODELS: 3/4" NPT Minimum connection to gas valve. INDUCED DRAFT MODELS: 1" NPT Minimum connection to gas valve. Schedule 40 black iron pipe recommended for all models.
Approved Gas Type	Natural or Propane. Gas supply must match the gas type listed on the water heater rating label.
Gas Pressure (Nat. & L.P.)	Manifold Pressure: 4.5" w.c. natural gas, 10.0" w.c. L.P. Gas Supply Pressure: At least 1" above manifold pressure with water heater operating, 14" w.c. maximum
Venting System	PDV-S MODELS: Power vented through either 3" or 4" diameter PVC, CPVC, or ABS pipe for 150,000 or 199,999 Btu/hr. models, 4" only for 250,000 Btu/hr. models. Refer to the installation instruction manual for further information on venting lengths and installation requirements. PDV-T MODELS: Power vented through Co-axial Venting (pipe inside a pipe) - Combustion air enters from the outside the building through an outer pipe (200mm diam.) and exhausts flue products through the inside pipe (130mm diam.). Refer to the installation instruction manual for further information on venting lengths and installation requirements. INDUCED DRAFT MODELS: Connect 8" vent to blower vent collar for venting through a chimney or type B vent only. Vertical venting only.
Minimum Clearance for Servicing	30" Front Clearance, 16" Top, 2" Sides and Rear
Maximum Water Supply Pressure	150 PSI
Thermostat Sensor(s)	Redundant thermister with 11,900 + or - 0.5% ohms resistance at 70 deg. F. Sensor inside well for lower sensor. PDV-T model series and Induced Draft models also use an upper sensor (dual sensors for these models).
Control Board	Honeywell Integrated Control Board for Temperature Control, Induced Draft Blower, and Ignition Control Functions. Operates on 24 volts AC current from transformer. Single sensor boards for PDV-S models and dual sensor boards for PDV-T models and Induced Draft models.
Control Display	Honeywell LCD Control Display with Temperature Setpoint, Format, and Error Code Display in User Mode, Diagnostic Functions in Service Mode. Communicates with Control Board. 24 volts AC. Same control display used on all models.
Transformer	120 VAC Primary, 24 VAC Secondary, 40 VA
Pilot	Intermittent Pilot with Spark Electrode and Flame Sensor monitored by Control Board
Induced Draft Blower	PDV-S MODELS: 115 VAC, 60 Hz., 4.3 Amps. PDV-T MODELS AND D80T725, D65T625: 115 VAC, 60 Hz., 3.6 Amps.

1 Thermostat calls for heat:

The relay closes on the control board, sending line voltage (115-120 volts) from “inducer” terminals #5 and 3 on the control board to the induced draft blower.

2 The blower starts and when sufficient vacuum is achieved, the pressure switch closes and completes the 24 volt circuit between terminals 1 and 3 on the Control Plug to the the board, allowing the ignition sequence to proceed. The blower “purges” any remaining combustion products from the previous cycle for 15 seconds before allowing the pilot to light. This is the pre-purge period of the ignition cycle.

3 Trial for ignition (three 90 second ignition trials, with 75 second pauses between trials).

Control Board simultaneously sends:

1. 24 volts from control pin terminal #8, to “MV/PV” terminal of gas valve (common terminal).
2. 24 volts from control pin terminal #2, to “PV” terminal of gas valve to establish gas flow at pilot.
3. Low current high voltage from “spark” terminal, to generate spark at the pilot and ignite pilot gas flow.
4. Pilot flame proving signal (measured in micro-amps). from the “sense” terminal, to prove pilot flame.

4 Once pilot flame is proven, sparking will stop.

5 Once sparking stops, 24 volts is sent from control pin terminal #5 on control board, to “MV” terminal on gas valve to establish main burner gas flow. Main burners ignite from the pilot flame.

The control board constantly monitors pilot flame through the flame sensor rod. If pilot flame is lost, pilot and main burners are shut down. After a 75 second inter-purge period, the control will attempt to re-light the pilot beginning at sequence 3 above.

7 Main burner fires until the thermostat is satisfied. The control board interrupts 24 volts through the gas valve circuit. Pilot and main burners are turned off.

8 The induced draft blower shuts off 5 seconds after the gas valve closes. This is the post-purge period.

LOCKOUT CONDITION

Control board will go into “Soft Lockout” if the pilot cannot be lit after 3 ignition trials. The water heater display indicates a lockout condition by showing an error code number (62 or 63) with “Service Needed” in the display window. Refer to error codes in the diagnostic section of this Service Manual. In a “Soft Lockout” condition, the control will wait for 60 minutes and then make 2 more attempts to light the pilot and establish the main burners.

Soft lockout reset is accomplished by depressing the lower right button under “Reset” for 3 seconds.

If the water heater should reach 200 degrees F, then the high limit control will shut off the burners and the water heater will go into a “Hard Lockout”. Error code 65 will be shown in the water heater display. The control can only be reset in the “service mode”, which is detailed in the next section of this Service Manual.

If the exhaust or intake terminals become blocked during operation or if the blower motor fails, the pressure switch will open and error code 29 will appear in the display. When the condition is corrected, the error code will disappear and the water heater will resume normal operation. No resetting of the control display is needed for the pressure switch error code.

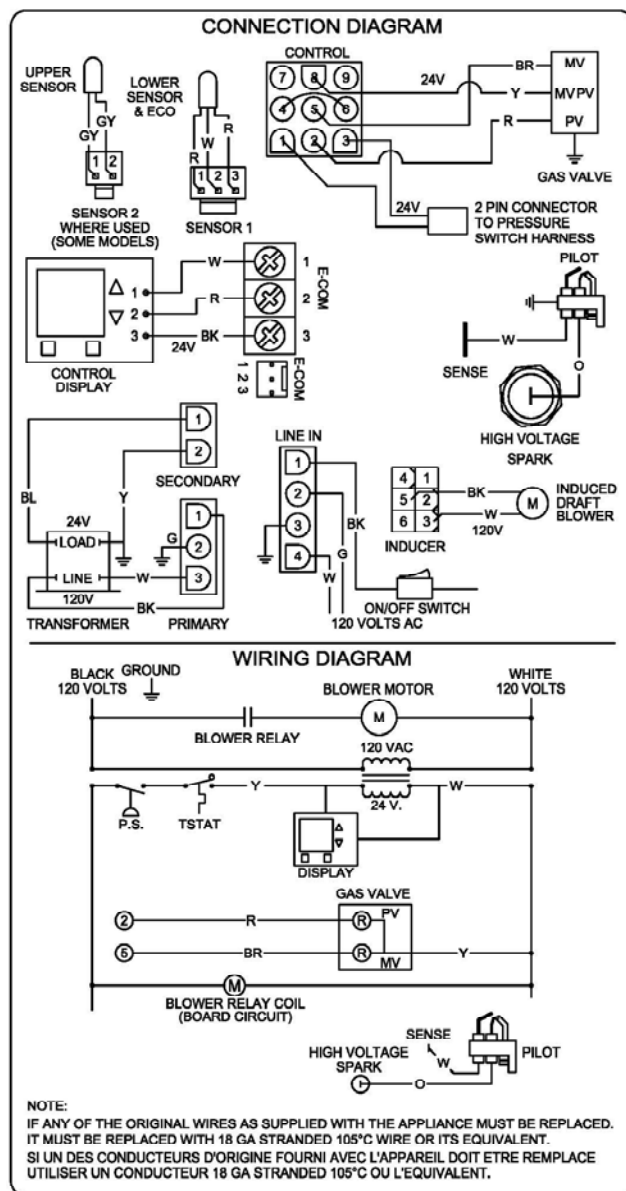

WIRING DIAGRAM

TROUBLESHOOTING

CAUTION

Use Caution Not to Damage Connectors when making Voltage Measurements or Jumping Terminals

Water Heater Fault: Water heater does not operate

Display Error Code: Water heater display does not operate - blank display

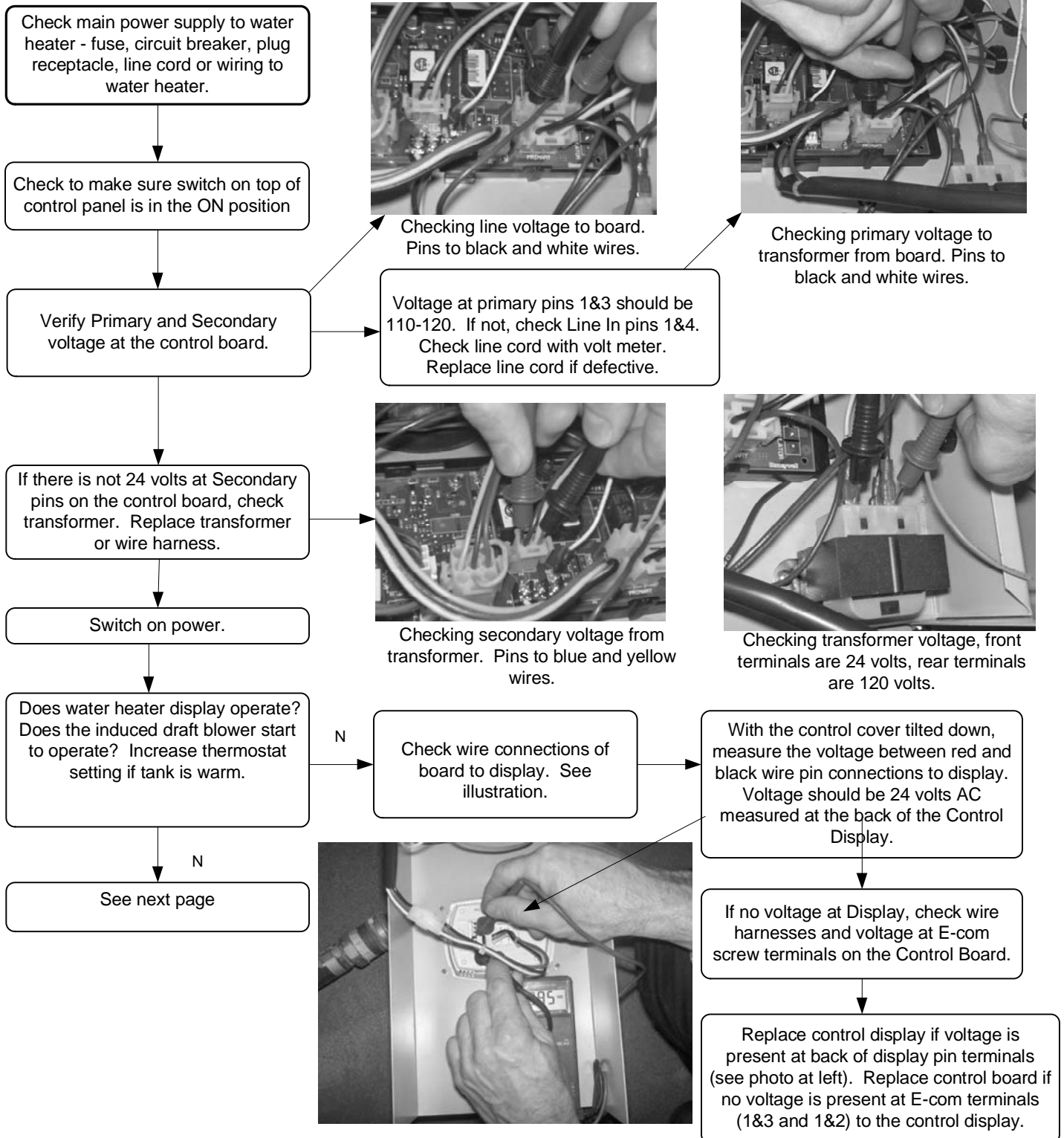

TROUBLESHOOTING

CAUTION
Use Caution Not to Damage Connectors when making Voltage Measurements or Jumping Terminals

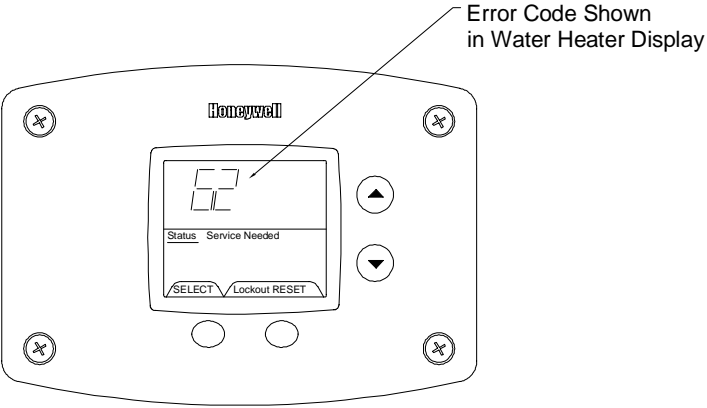
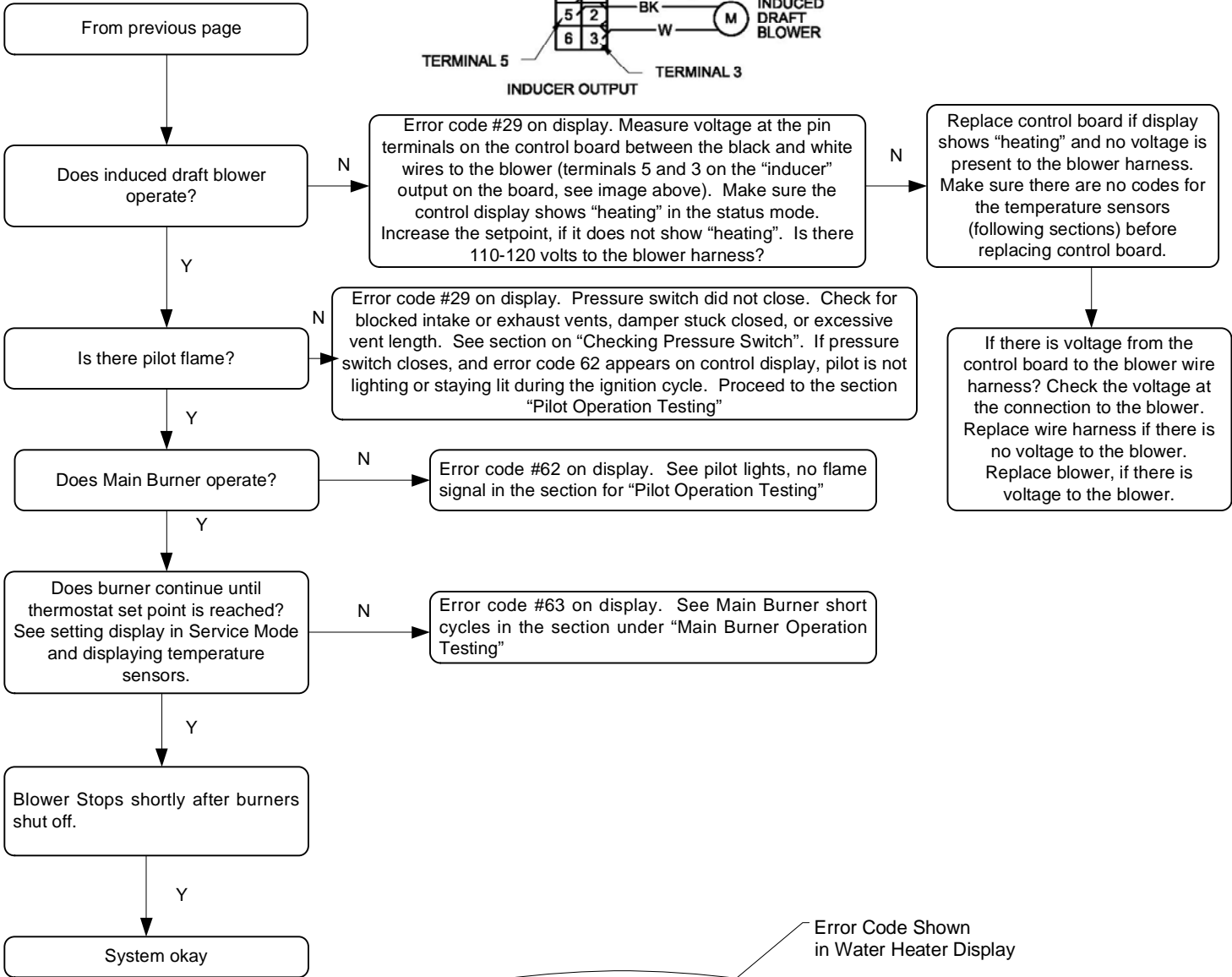
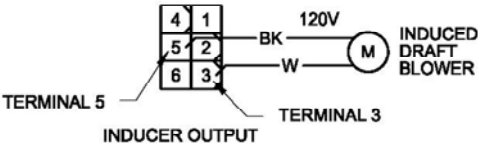

Example of error code shown on control display.

ACCESSING SERVICE MODE ON THE WATER HEATER DISPLAY (FOR SERVICE PERSONNEL ONLY)

The display has a "service mode" for changing the maximum setpoint and accessing information in aiding servicing of the water heater. This procedure is for service and installation personnel only. To enter the Service Mode, follow the steps illustrated below:

Step 1: Press "Select" and "Temperature Up" buttons together and hold for 3 seconds until "Max Setpoint" is shown in the display.

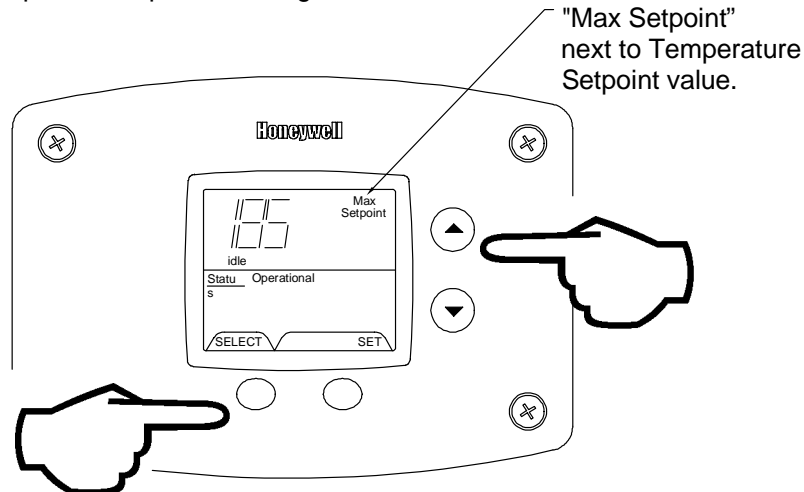

Step 2: Pressing "Select" button will change display to next mode

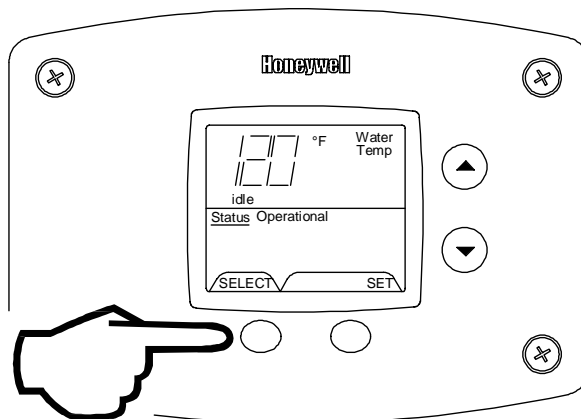

The following is the sequence of modes available in "Service Mode" by pressing the "Select" button:

Error Code Number (Display/Reset). This is only shown if there is an operating error in the "User Mode".

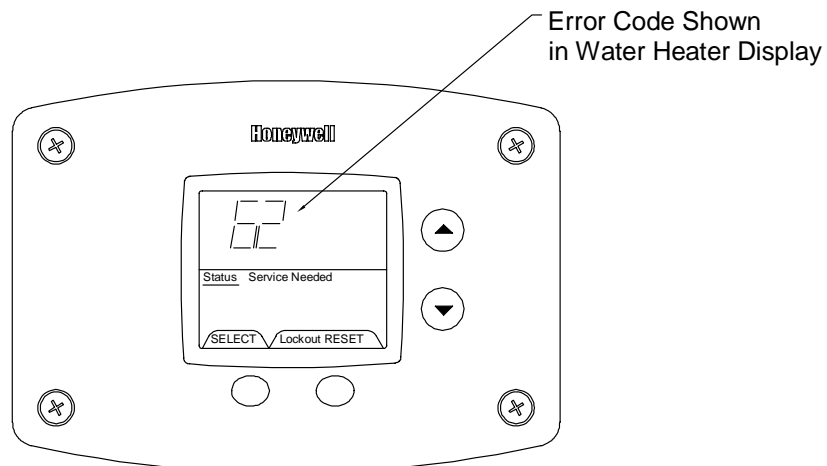

1. Max Setpoint (Display/Change)

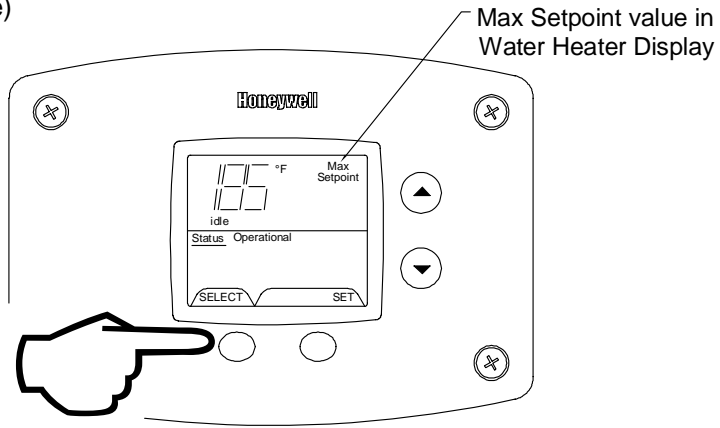

2a. Water Temperature Average (Displays average if there are two sensors - sensor temperature displayed if single sensor is used).

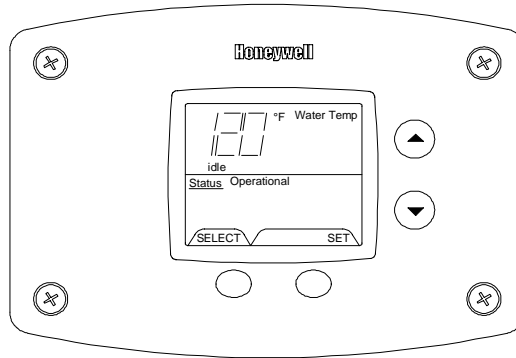

2b. Water Temperature - Upper Sensor (Displays if there is an upper sensor - some models)

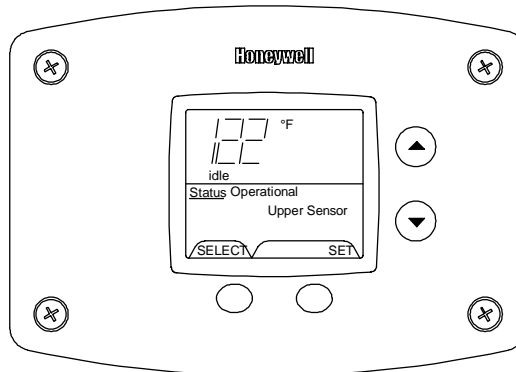

2c. Water Temperature - Lower Sensor (Displays if there are two sensors)

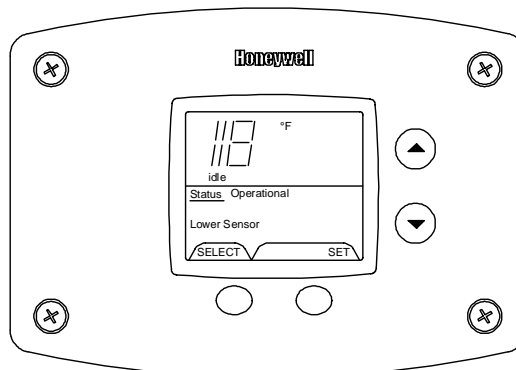

3. Flame Current of Pilot Flame Sensor (Displays only in the Heating Cycle)

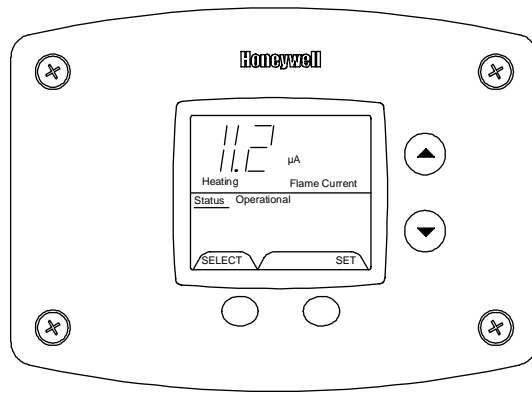

4. Setpoint (Display/Change)

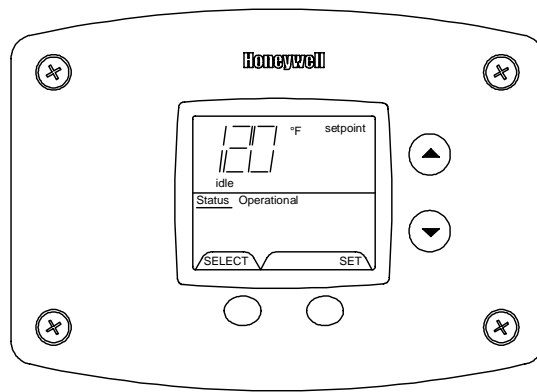

5. $^{\circ}$ F/ $^{\circ}$ C (Display/Change)

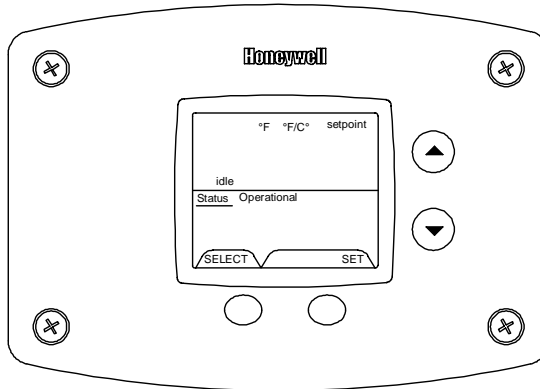

6. Differential (Display only - shows the differential of the thermostat)

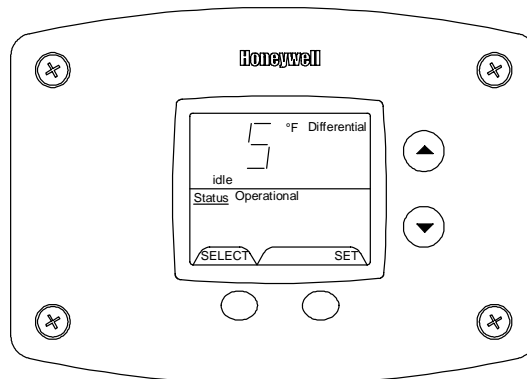

7. Software Version (Display only)

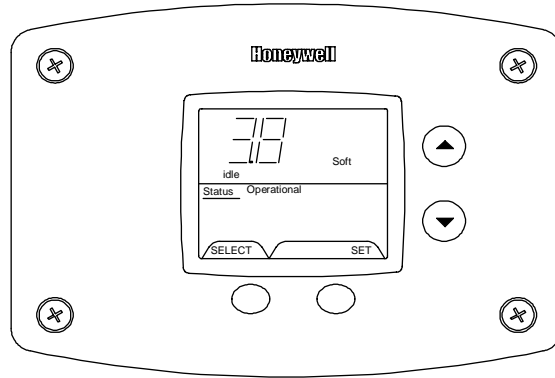

8. Error Code History (Displays if there are present error codes or up to 10 previous error codes). Water Heater Display will show a "--" if there are no error codes.

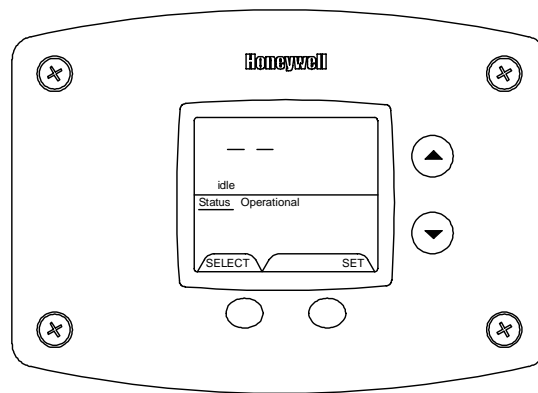

To change the Maximum Setpoint Limit (Max Setpoint) for the temperature setpoint:

Step 1: In service mode press the "Select" button until "Max Setpoint" is displayed.

WARNING

Setting the water temperature to the maximum set point can result in scalding hot water delivered to the faucets. It is highly recommended that the maximum setpoint be adjusted to the lowest temperature possible for the needs of the installation. Make sure the water heater control display is not in a public area that can result in the temperature settings being improperly adjusted.

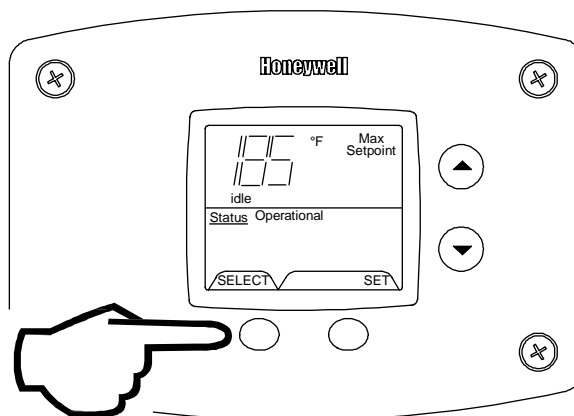

Step 2: Press "Set" button to enter setting mode. "Max Setpoint" will flash to indicate setting mode.

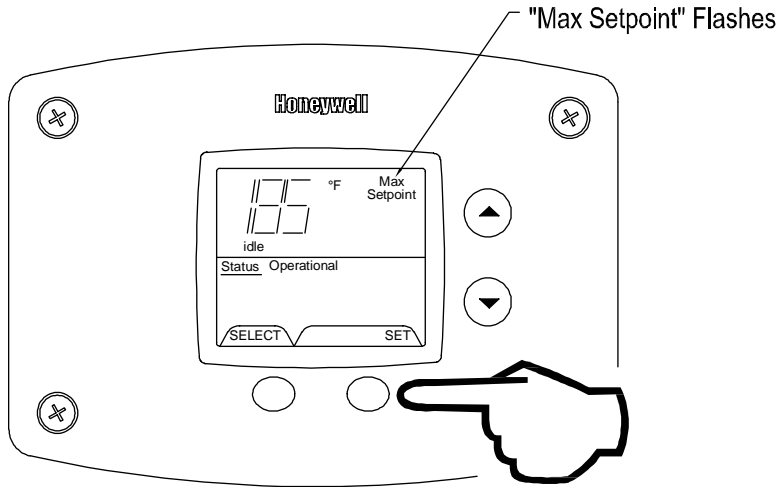

Step 3: Press the "UP" or "DOWN" buttons to change the maximum setpoint value. This will limit the maximum setpoint the user can select. Note: The maximum setpoint is approximately 180°F.

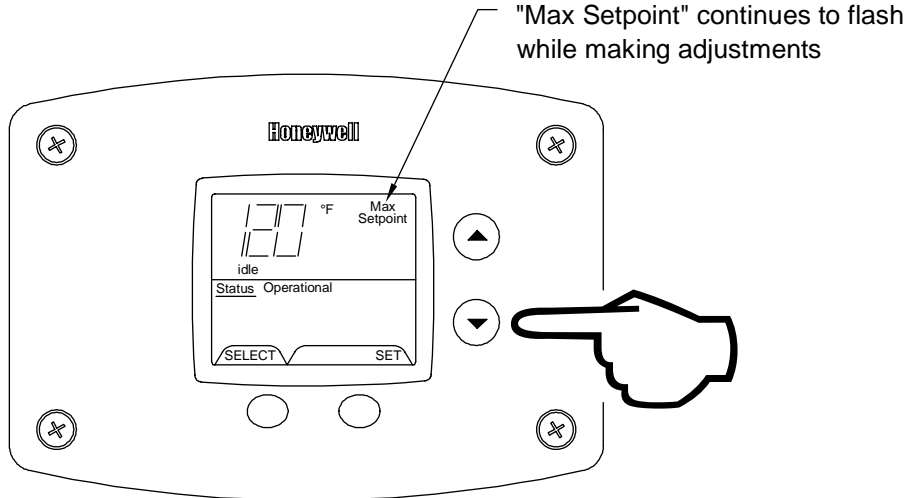

Step 4: Press "Set" button to confirm new "Max Setpoint" value and stop setting mode.

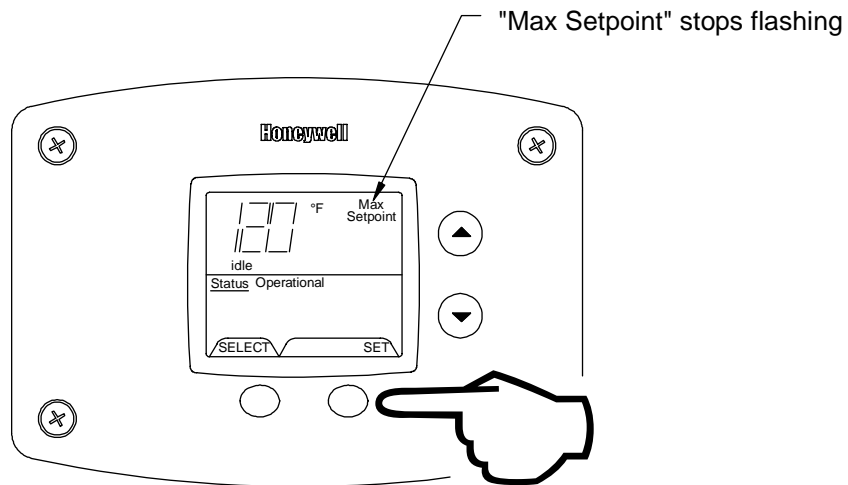

Step 5: 30 Seconds after the last button press, the Water Heater Display will go back to "User Mode". It will read "Max Setpoint" without showing a temperature value if the temperature setpoint is at the maximum setting. The Water Heater Display can be set back to the "User Mode" immediately by pressing both the "Temperature Up" and "Select" buttons together for 3 seconds.

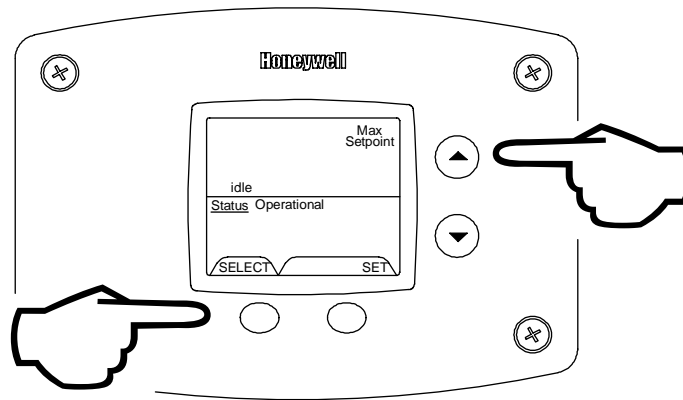

Exiting Service Mode

Display of Water Temperature:

Step 1: In Service Mode, Press the "Select" button until "Water Temp" is displayed in the upper right section of the water heater display. For water heaters using two temperature sensors in the tank, this will be the average reading between the two sensors. For water heaters using a single sensor, this is the reading for the sensor.

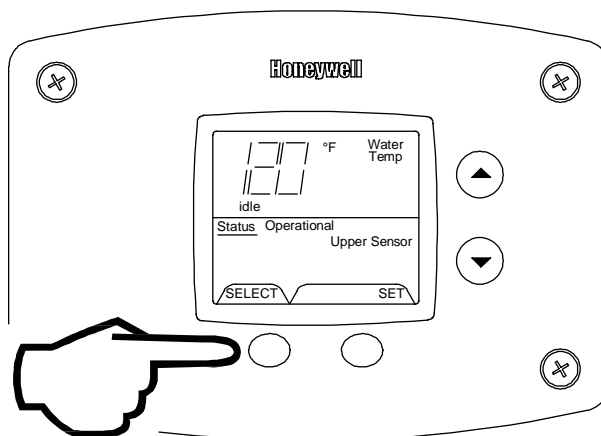

Step 2: For water heaters using two temperature sensors, pressing the "Select" button again displays the Upper Sensor temperature reading. "Upper Sensor" will be displayed in the lower right side of the status window of the water heater display.

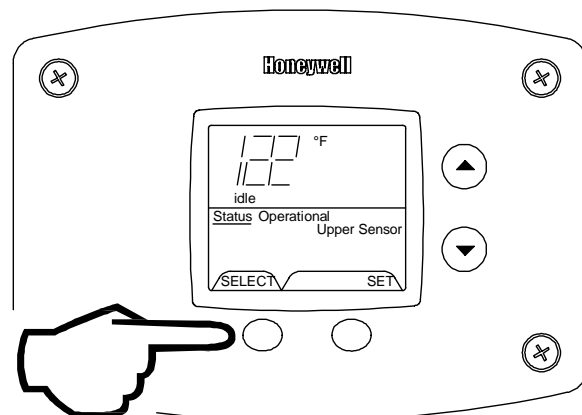

Step 3: For water heaters using two temperature sensors, pressing the “Select” button again displays the Lower Sensor temperature reading. “Lower Sensor” will be displayed in the lower left side of the status window of the water heater display.

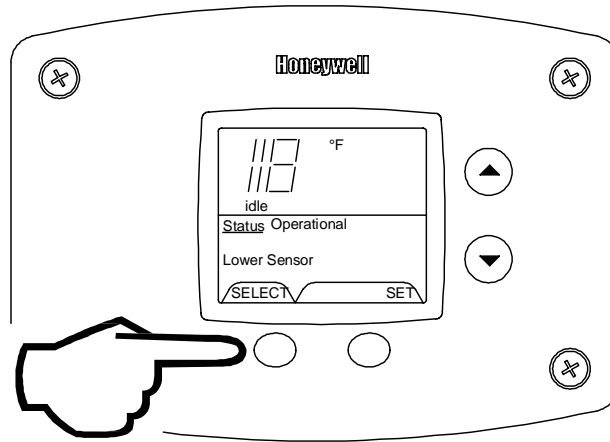

To Display Flame Sense Current of the Pilot Flame Sensor:

The pilot flame sense current is available only when the burners are in operation. Step 1: Make sure the status displays “Heating” or draw enough hot water to start the burners. Step 2: Enter the “Service Mode” described previously. Step 3: Press the “Select” button until a number value is displayed with “Flame Current” to the right of the number. The value displayed is in microamps (μA).

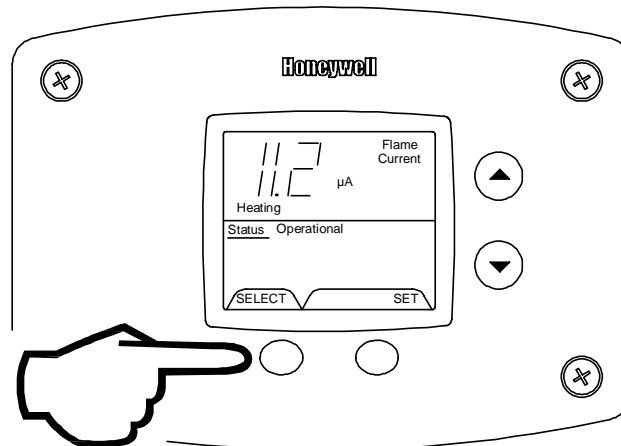

To Display and Change Temperature Setpoint:

Step 1: In “Service Mode” press the “Select” button until “Setpoint” is shown in the water heater display

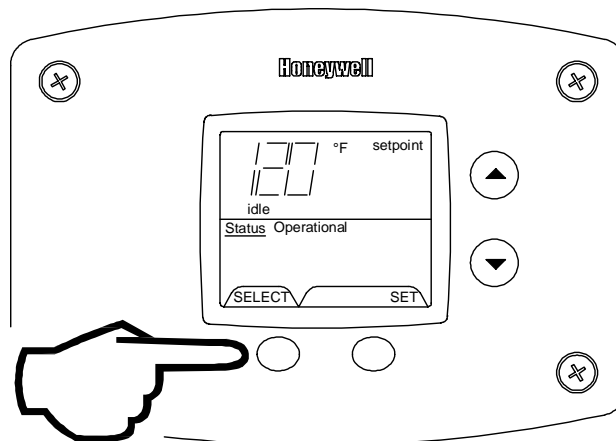

Step 2: Press the "Set" button to enter the setting mode. "Setpoint" will flash in the water heater display.

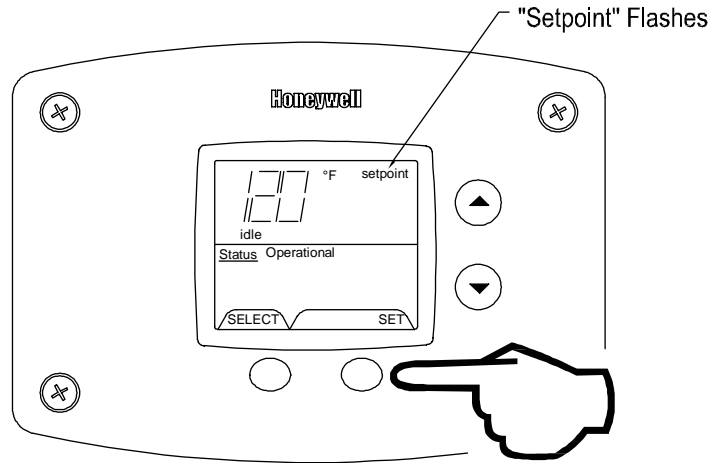

Step 3: To raise the temperature setpoint, press the "Temperature Up" button until the desired temperature is shown on the water heater display.

NOTICE

The maximum temperature that can be set in the Water Heater Display is limited to the "Max Setpoint" described previously. To change the "Max Setpoint", refer to the procedure "To Change the Maximum Setpoint Limit..." described previously under "Accessing the Service Mode on the Water Heater Display".

WARNING

Setting the water temperature to the maximum set point can result in scalding hot water delivered to the faucets. It is highly recommended that the maximum setpoint be adjusted to the lowest temperature possible for the needs of the installation. Make sure the water heater control display is not in a public area that can result in the temperature settings being improperly adjusted.

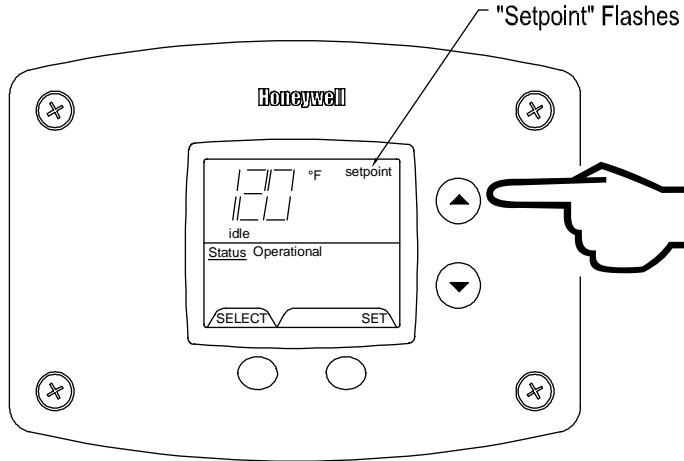

Step 4: To lower the temperature setpoint, press the "Temperature Down" button until the desired temperature is shown on the water heater display.

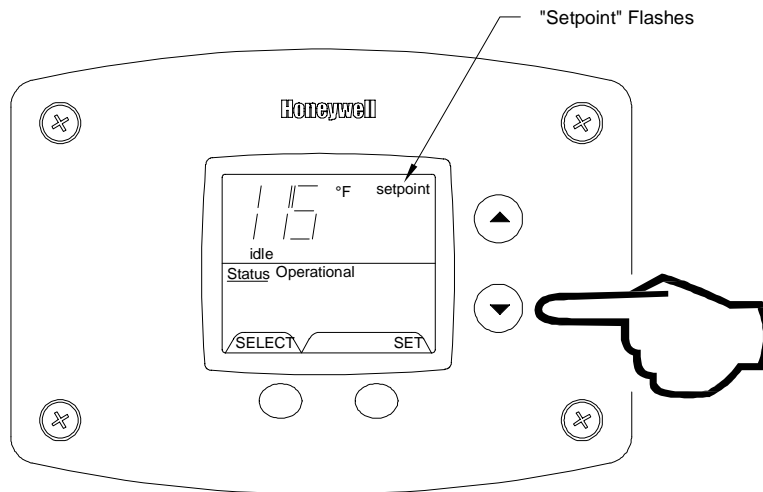

Step 5: When the desired setpoint is reached on the water heater display, press the "Set" button to confirm the new setpoint. "Setpoint" stops flashing in the water heater display.

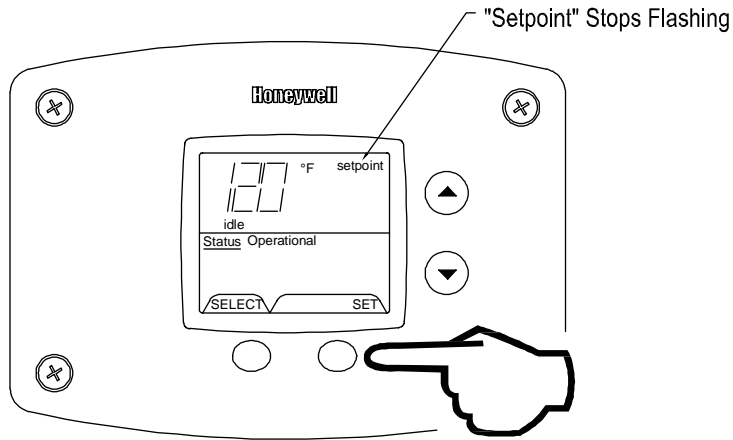

To Display and Change Temperature Format (°F/°C):

To Change Temperature Format in Display from °F to °C or °C to °F:

Step 1: While in "Service Mode", press "Select" button until "°F/°C" is shown in the upper right portion of the water heater display.

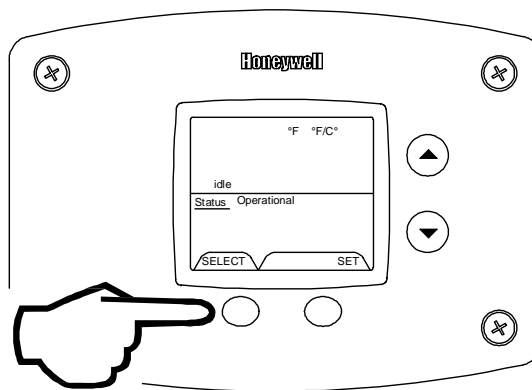

Step 2: Press "Set" button to change temperature format. "°F/°C" symbol will flash in the water heater display.

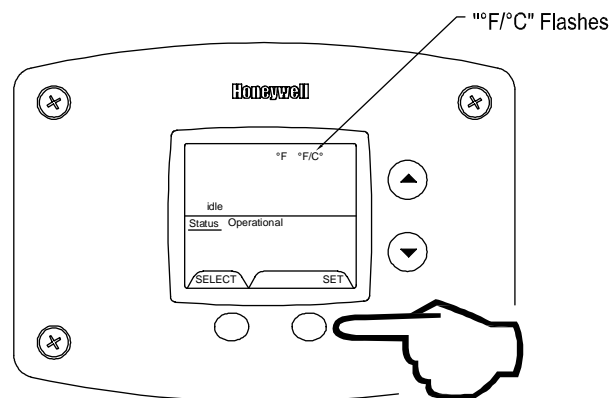

Step 3a: Press "Temperature Up" button to change temperature format to °C

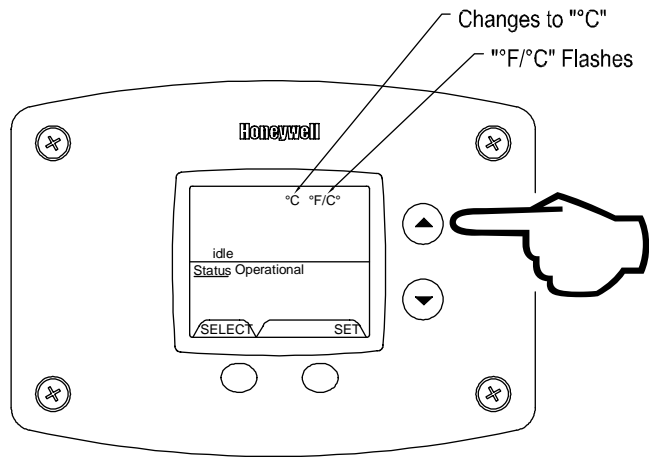

Step 3b: Press "Temperature Down" button to change temperature format to °F

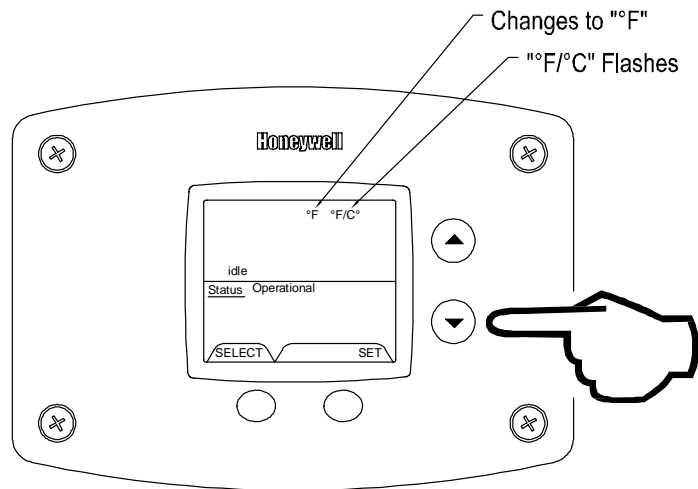

Step 4: Press "Set" button to confirm °F or °C format. °F/°C will stop flashing

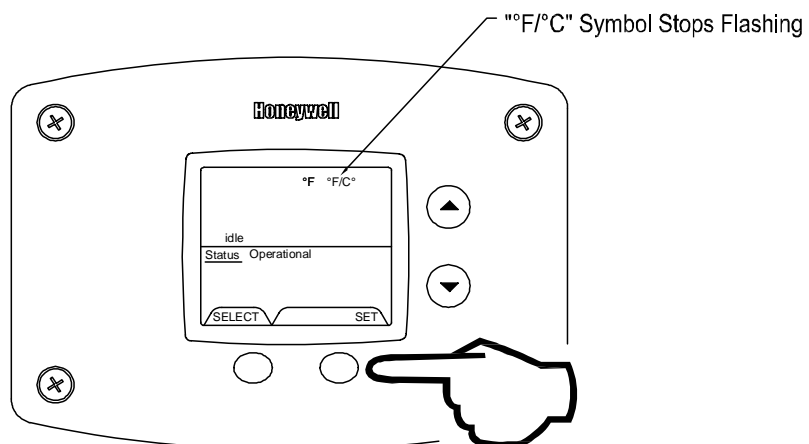

Step 5: Pressing "Select" button will return display to setpoint in format selected (°F or °C) immediately

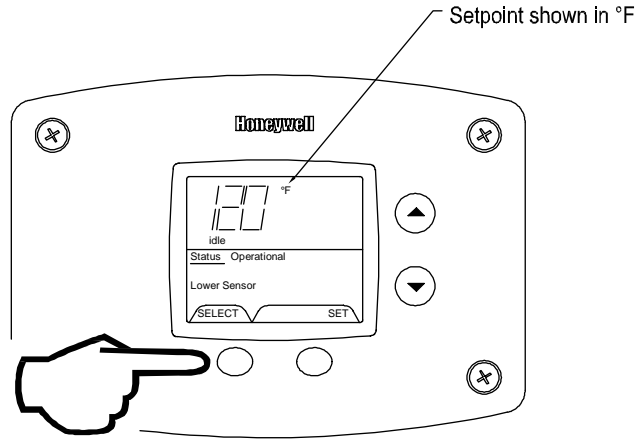

Error Codes and Error History Display:

If there is an operating problem with the water heater, an error code number will appear on the water heater display with "Service Needed" to the right of the "Status" indicator. The error code label is located under the Water Heater Display and the following section in this Service Manual explains the error codes with corrective actions to repair the water heater.

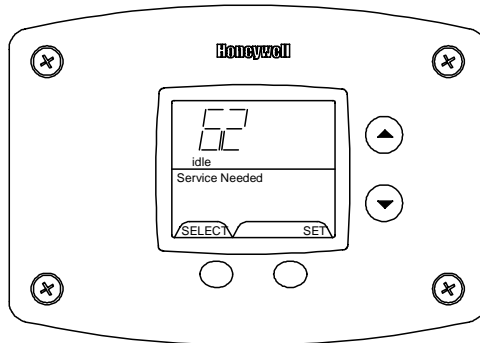

Example of Error Code in the Display

Error Code History:

In "Service Mode" pressing the "Select" button after the "Software Version" (item 8 in the previously described sequence of service modes) will show an error code history, if there have been any previous operating problems with the water heater. If the display shows --, there is not a current error code.

The Water Heater Display will provide up to 10 previous error codes. The oldest error code will be stored in code index #1 and the most recent in code index #10.

To view previous error codes:

Step 1:

In "Service Mode press the "Select" button until the next display after the "Software Version". If there are no current error codes, the display will show -- .

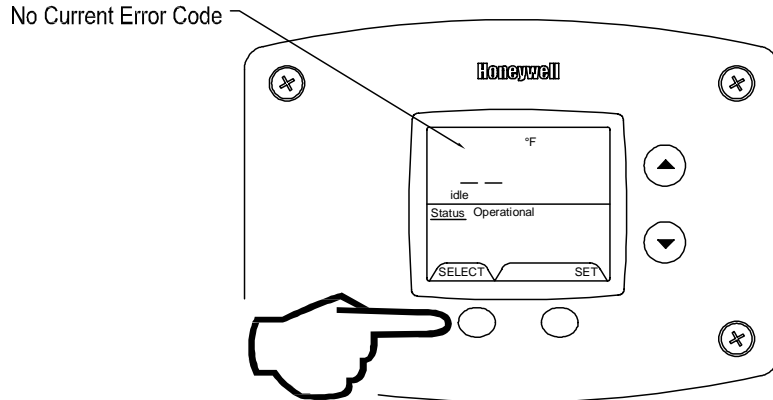

Step 2:

Press the "Temperature Down" button to select the error code index, starting with the most recent error code "10".

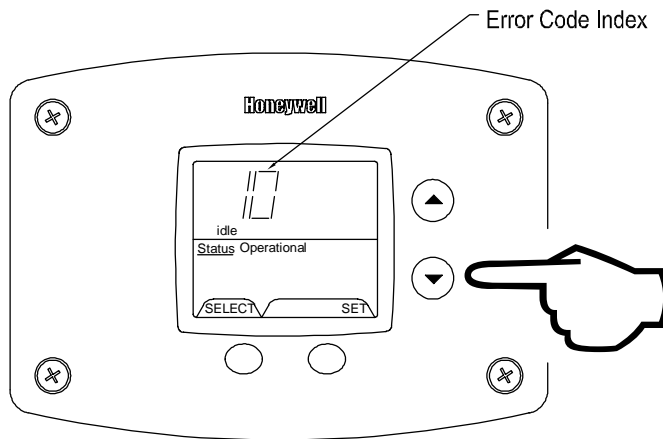

Step 3:

Press the "Select" button to view the error code for "code 10". If there is a number displayed, note what the number is. The label next to the water heater display will identify the code number. If no number is displayed with only a "--" in the water heater display, then there has not been an error code for error code index 10.

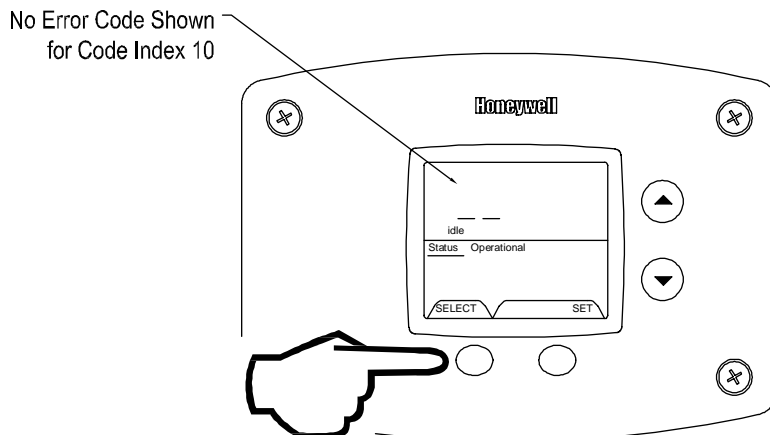

Step 4:
Press the "Temperature Down" button to change to the previous code index, code #9.

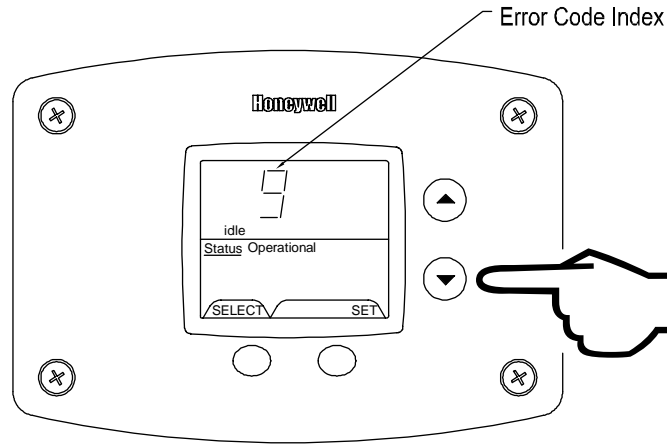

Step 5:
Press the "Select" button for code index #9 to view if there are any code numbers.

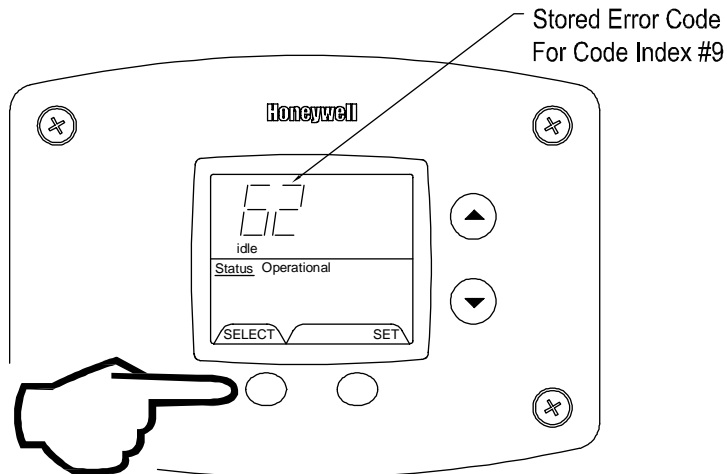

Step 6:
Continue pressing the "Temperature Down" button to change to the next error code index and press "Select" to view the error code number, if any, for that index number. Continue on to index #1, the oldest error code index. The water heater display will store up to 10 error codes with the oldest code starting in code index #1 with the most recent code in code index #10.

Step 7: 10 seconds after the last button press, the Water Heater Display will revert back to the current error code display. To exit Service Mode, either wait 30 seconds or press Temperature Up button and Select Button for 3 seconds.

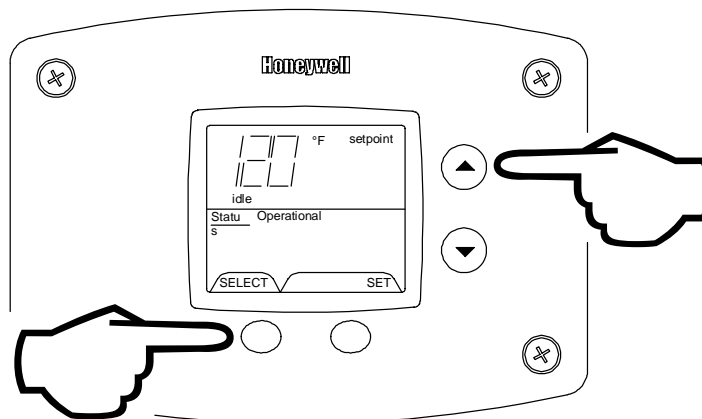

Exiting Service Mode

ERROR CODE DEFINITIONS

If the water heater has an operating problem, there will be a number in the water heater display with "Service Needed" shown below the error code number. Note the error code and the definition in the chart below. This label appears on the control box under the water heater display. The following sections will provide instructions for servicing each error code.

HONEYWELL INTEGRATED CONTROL ERROR CODE DISPLAY FOR PDV AND INDUCED DRAFT MODELS	
ERROR CODE	DEFINITION
4	LOW FLAME SENSE CURRENT
2	PRESSURE SWITCH FAILED TO OPEN (STUCK CLOSED)
29	PRESSURE SWITCH FAILED TO CLOSE (STUCK OPEN)
6	FLAME SENSED OUT OF NORMAL SEQUENCE (BEFORE OPENING GAS VALVE OR AFTER CLOSING GAS VALVE)
23	FLAME DETECTED BEFORE IGNITION
24	FLAME DETECTED AFTER A HEATING CYCLE COMPLETES
31	UPPER SENSOR READINGS FAULTY
32	LOWER SENSOR READINGS FAULTY
57	FLAME ROD SHORTED TO GROUND
58	AC LINE FREQUENCY ERROR – SIGNAL TOO NOISY OR FREQUENCY INCORRECT
59	LINE VOLTAGE TOO LOW OR HIGH
61	DC OUTPUT VOLTAGE UNSTABLE
62	MAXIMUM NUMBER OF RETRIES DETECTED
63	MAXIMUM NUMBER OF IGNITION RECYCLES DETECTED
64	ELECTRONICS FAILURE
65	HIGH WATER TEMPERATURE (OVER 200°F)

IF ANY OF THE ABOVE CODES APPEAR ON THE CONTROL DISPLAY, CONTACT YOUR PLUMBER OR QUALIFIED SERVICE AGENT FOR SERVICE OF THIS WATER HEATER.

▲ WARNING

The following procedure is for service and installation personnel only. Resetting lockout conditions without correcting the malfunction can result in a hazardous condition.

If an error code is displayed (except for #4, low flame sense current), the water heater will be in a “lockout condition” with the water heater display showing the error code number and “Service Needed” in the status section of the display window. Error codes 62 (maximum number of retries detected) and 63 (maximum number if ignition recycles detected) are “Soft Lockouts” in which the control can be reset in the “User Mode” by pressing the lower right button under “Lockout Reset” shown in the lower right portion of the display. The control will also go through 3 attempts to relight the burners every hour in the soft lockout condition.

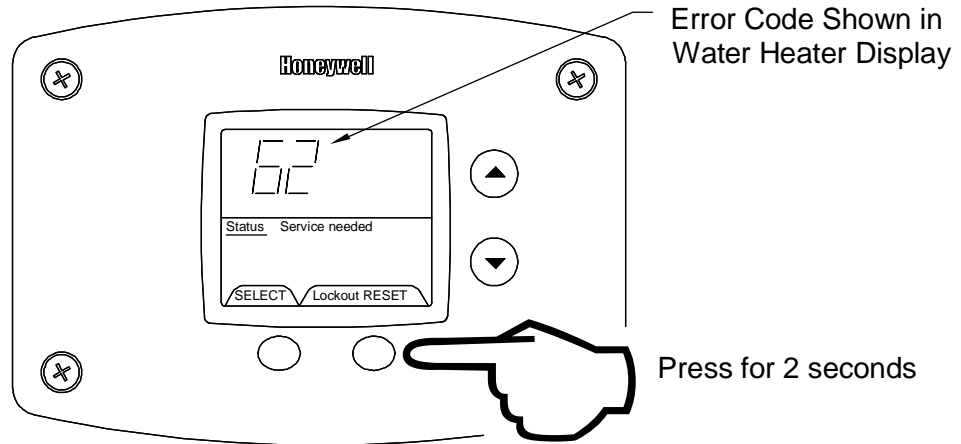

All other error codes will put the water heater into a “Hard Lockout” condition, in which the water heater will not operate and cannot be reset in the “User Mode”. To reset a hard lockout, first enter the “Service Mode” described earlier by pressing both the “Temperature Up” and “Select Buttons” at the same time for 3 seconds. Then press the lower right button under “Lockout Reset” in the water heater display and hold for 3 seconds.

Resetting Error Codes in Hard Lockout Condition

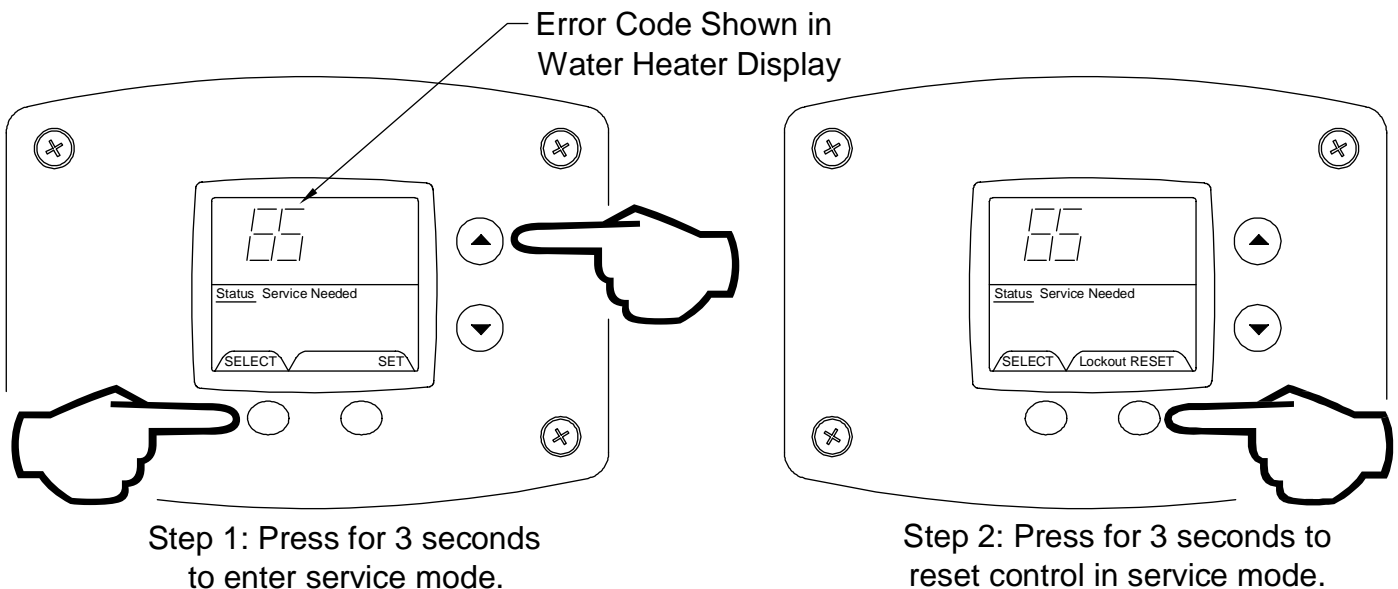

▲ DANGER

120 volt exposure. To avoid personal injury, use caution while performing this procedure.

▲ CAUTION

Be Careful When Making Voltage Measurements or Jumping Terminals Not to Damage or Deform Connectors or Connector Pins.

Condition: Water Heater Not Operating
Display shows error code "31" (Upper Sensor Readings Faulty) or error code "32" (Lower Sensor Readings Faulty)

Unplug or disconnect electrical power to the water heater

Check continuity of wire harness to affected sensor. Measurement of ohmmeter should be close to 0 ohms. Replace wire harness if high resistance is measured (over 0.5 ohms) Check wires for intermittent connections, shorts, frayed insulation. Replace if necessary

If wire harness checks out O.K., check sensor resistance detailed in the section for testing sensor resistance. Replace the upper or lower sensor as indicated by error code number.

Turn power on to water heater. Run water heater through heating cycle and verify proper operation. Sensor temperature can be viewed when burner shuts off (see section on viewing the display in "Service Mode".

Condition: Water Heater Not Operating
Display shows error code "65"
High Water Temperature (over 200 deg. F)

WARNING
Do not reset the display from the hard lockout state without correcting the cause of the overheating condition

Turn power "OFF".
Draw water to cool tank below 120 deg. F

Check lower sensor. Is the sensor fully inserted into the well? Sensor is held in place with a clip fastened to the well (see photo) Check lower sensor wire making sure it is not damaged or has breaks in the wire insulation. Check upper harness wires to upper sensor, if used (some models).



Measuring upper sensor resistance through wire harness (disconnected at control board).



Checking continuity of upper sensor wire harness.



Removing lower sensor from well. Held in place by a clip fastened to well shoulder.

N

If sensor clip is damaged replace clip. Replace lower sensor if damaged.

See next page

Y

Check Sensor Resistance (See Sensor Resistance Testing, following section)

WARNING!

Do not operate water heater without verifying that the overheating condition has been corrected.

Condition: Water Heater Not Operating
Display shows error code "65"
High Water Temperature (over 200 deg. F)
Continued

Once cause of overheating condition has been diagnosed and corrected, the control may be reset

- Reconnect and switch on power to the water heater.
- Enter service mode on the water heater display (see illustration)
- Press button under "Lockout Reset" and hold for 3 seconds.
- Set thermostat to the desired setting.
- Water heater should start.
- Monitor temperatures for one complete heating cycle making sure the maximum tank temperature remains well below 200 deg. F

This water heater is equipped with a manual reset type gas shutoff device designed to shut off the gas to the burners if excessive water temperature occurs. To reset the control, first press the "temperature up" and "select" buttons on the water heater display for 3 seconds to enter service mode. Then press the lower right button under "RESET" in the display for 3 seconds.

Error code 65 indicates high limit lockout condition

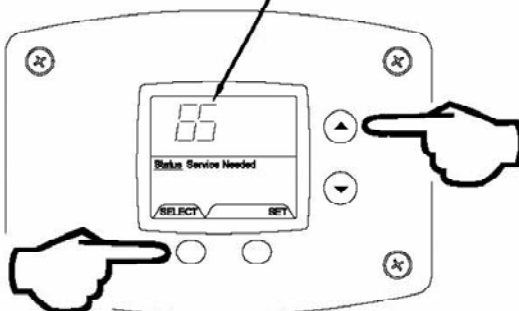

Step 1: Press for 3 seconds to enter service mode.

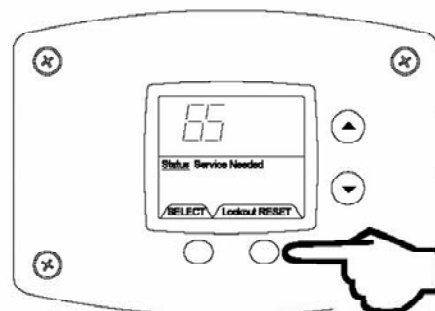

Step 2: Press for 3 seconds to reset control.

Conditions: Upper or Lower Sensor Reading Faulty, High Water Temperature, or suspect thermostat is not accurate.

SERVICE PROCEDURE PDV24-I Thermostat Circuit Testing

Sensor Resistance Testing

Upper Sensor

1. Determine resistance value of upper sensor using an ohmmeter. Test across grey wires.
2. Draw quart of water off **T&P valve**. Using a thermometer, determine water temperature.
3. Use table below to verify correct resistance per water temperature measured.

Lower Sensor:

1. Determine resistance value of lower sensor. Test across center wire (common) to each outside wire. Resistance of both thermistors in the lower sensor should be close to each other. If the resistance values for both thermistors are not close to each other, replace the lower sensor. The dual thermistors are used to provide high limit protection in case the thermostat circuit fails to shut off the water heater.
2. Draw quart of water off **Drain Valve**. Using a thermometer, determine water temperature.
3. Use table below to verify correct resistance per water temperature measured.

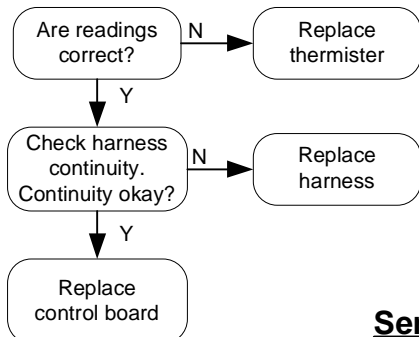

Upper thermister location (applicable models)



Checking resistance of upper sensor

Lower thermister access located inside control box.



Checking resistance of lower sensor (center and outside pins)

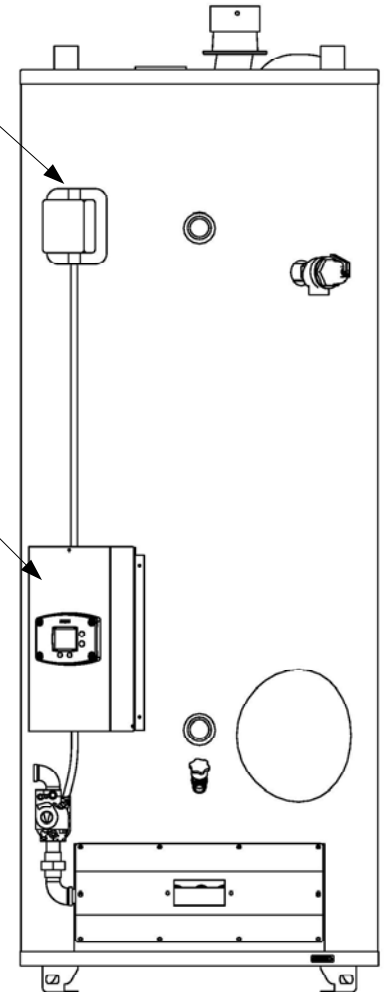

CAUTION
Be Careful When Making Resistance Measurements Not to Damage or Deform Connectors or Connector Pins.

Sensor Resistance at Various Temperatures

Example: If water temperature is 84°F, then the resistance through the sensor would be 8449 (see shaded area).

NOTE: Sensor resistance increases as the temperature falls.

In Degrees F										
°F	0	1	2	3	4	5	6	7	8	9
40	26109	25400	24712	24045	23399	22771	22163	21573	21000	20445
50	19906	19383	18876	18383	17905	17440	16990	16553	16128	15715
60	15314	14925	14548	14180	13823	13477	13140	12812	12494	12185
70	11884	11592	11308	11032	10763	10502	10248	10000	9760	9526
80	9299	9078	8862	8653	8449	8250	8057	7869	7685	7507
90	7333	7165	7000	6839	6683	6531	6383	6238	6098	5961
100	5827	5697	5570	5446	5326	5208	5094	4982	4873	4767
110	4663	4562	4464	4368	4274	4183	4094	4006	3922	3839
120	3758	3679	3602	3527	3453	3382	3312	3244	3177	3112
130	3048	2986	2925	2866	2808	2752	2697	2643	2590	2538
140	2488	2439	2391	2344	2298	2253	2209	2166	2124	2083
150	2043	2004	1966	1928	1891	1856	1820	1786	1753	1720
160	1688	1656	1625	1595	1566	1537	1509	1481	1454	1427
170	1402	1376	1351	1327	1303	1280	1257	1235	1213	1191
180	1170	1150	1129	1110	1090	1071	1053	1035	1017	999
190	982	965	949	933	917	901	886	871	857	842
200	828	814	801	788	775	762	749	737	725	713

DANGER
120 volt exposure. To avoid personal injury, use caution while performing this procedure.

CAUTION
Be Careful When Making Voltage Measurements or Jumping Terminals Not to Damage or Deform Connectors or Connector Pins.

Condition: Blower operates, burners not lit. Display shows error code "29" (Pressure Switch Failed to Close).

Minimum Differential Dual Tap Pressure Switch Settings:
(Contacts open)

PDV80S,100S-150 models:	-2.00" w.c.
PDV80S,100S-200 models:	-1.20" w.c.
PDV80S,100S-250 models:	-2.00" w.c.
PDV80T300 models:	-1.20" w.c.
PDV100T360 models:	-0.60" w.c.

Connect a digital manometer to the tubing for the pressure switches and determine the average reading. See table at right for pressure switch settings and minimum readings required. Is the pressure switch reading at least 0.20" above the switch reading for the model tested (see chart at right)?

Note: During normal hot running conditions, the pressure switch readings should be at least 0.20" higher than the above readings where the pressure switch will open.

Check intake and exhaust vent terminals outside the building. Is there any blockage from debris (leaves, ice, snow, paper, etc.). If so, clear intake or exhaust vent terminals. Pressure switch should close and the burners should fire.

PDV80,100S-150,200 Models with 3" PVC vent: Maximum Distance of 40 feet with one 90 deg. elbow for intake or exhaust (subtract 5 feet for each additional elbow).
For venting with 4" PVC vent: Maximum distance of 55 feet with one 90 deg. elbow for intake or exhaust (subtract 5 feet for each additional elbow).

Check the total equivalent vent length by adding up the total number of elbows and the straight lengths of vent pipe for the intake and exhaust pipe (or coaxial vent pipe for PDV-T model series). See table at right for maximum distances. If the venting distance is excessive, reduce the number of elbows or route the vent terminals to a shorter distance outside the building.

PDV80S,100S-250 Models with 4" PVC vent: Maximum distance of 55 feet with one 90 deg. elbow for intake or exhaust (subtract 5 feet for each additional elbow).

If the venting system and vent terminals are O.K., but the pressure switch reading is still low, check the pressure switch tubing to make sure there are no small holes or kinks. Make sure there are no drops of condensate in the tubing. Check the pressure switch tubing connection fitting and pressure tap to make sure it is not clogged with dirt. Blow through tubing to verify that the pressure taps and tubing are clear and not leaking.

PDV80T300, PDV100T360 Models with coaxial venting system: Maximum venting distance of 19 feet 6 inches with one 90 deg. elbow. Each additional elbow reduces the venting distance by 39".

See installation instruction manuals supplied with the water heater for further details on proper venting installations.

PDV-S MODELS: Check the vent safety thermal switch near the outlet of the blower (see photo at right). Press the red reset button. (See photo on next page). If you feel a slight click, the temperature was excessive and the switch opened. Check to be sure the burner access screws are tight and the gasket is in good condition (see section on servicing the burners)

If the pressure switch readings are at least 0.20" w.c. above the above pressure switch settings for the installed model and the switch does not close, then replace the pressure switch with the same setpoint.



Checking pressure switch contacts. Contacts are open if blower is operating and there is 22-26 volts measured between the two contacts (as in photos)

DANGER
120 volt exposure. To avoid personal injury, use caution while performing this procedure.

CAUTION
Be Careful When Making Voltage Measurements or Jumping Terminals Not to Damage or Deform Connectors or Connector Pins.

PDV(S & T) Models



Check pressure switch tubing to the pressure switch. Make sure tubing does not have kinks, holes, condensate, or dirt blocking air pressure to the switch. The tubing to the blower tap attaches to the - (minus) tap on the pressure switch.

Vent Safety Switch (PDV-S Models Only)

Red reset button



Vent safety thermal switch on PDV-S blower. Depress red reset button in center of switch. If a slight click is felt, switch opened. Check for loose or leaking burner access panel (see section on servicing burners)

Induced Draft Models (D80T725 & D65T625):



Induced Draft Models use a single tap pressure switch to measure vacuum in the flue collector. The pressure switch is located inside the control box (see photo to left). Connect a digital manometer to a tee in the pressure switch tubing and measure the vacuum with the blower operating. The vacuum should be in the range of -1.70" to -2.10" w.c. The pressure switch **contacts will open at -1.25"** and **close by -1.40" w.c.** If the vacuum is below -1.50", check to make sure the flue damper is fully open when the blower is operating. Make sure the damper and rod are not binding. Make sure there are no restrictions in the venting system and that is at least 8" in diameter. Venting is for vertical gravity venting only. Insure that there is sufficient combustion air to the utility room.

DANGER
120 volt exposure. To avoid personal injury, use caution while performing this procedure.

CAUTION
Be Careful When Making Voltage Measurements or Jumping Terminals Not to Damage or Deform Connectors or Connector Pins.

Condition: Blower does not operate, burners not lit. Display shows error code "29" (Pressure Switch Failed to Close).

With a voltmeter, check to make sure the "line in" connection to the control board has 110-120 volts. Make sure the secondary plug from the transformer to the board has 24 volts at the yellow and blue wire pin terminals (see photos to right).

Make sure the water heater control display shows "Heating" in the status window. Raise the setpoint if needed. If there is no call for heat and the setpoint is well above the tank temperature, refer to the thermostat troubleshooting and replacement section.

If the water heater control display shows "Heating" and the blower is off, Error code 29, then check the voltage output at the blower plug on the board. Should read 110-120 volts between the black and white wires to the blower (terminals 5 and 3 on the inducer output on the control board, see illustration to the right).

If there is voltage between the black and white wires to the blower plug on the board, then check the voltage at the blower connection on the blower (see photo at right). If no voltage is present, replace the wire harness. If there is 110-120 volts, replace the blower.

Condition: Blower does not operate, burners not lit. Display shows error code "2" (Pressure Switch Failed to Open - Stuck Closed).

Disconnect power and remove the pressure switch cover (previous photo-PDV models). Disconnect wires on the pressure switch. Measure continuity on the pressure switch terminals with an ohmmeter. If there is continuity, the pressure switch is stuck closed. Make sure pressure switch has not been bypassed (jumpered). The control will not operate with a jumpered pressure switch.

If pressure switch contacts are stuck closed, check the pressure switch tubing for condensate, dirt, or kinks. If the tubing is O.K., replace the pressure switch with the same setting.

Reconnect power. Verify proper operation.

If there is no voltage on the control board to the blower plug and the control display shows "Heating", then replace the control board.

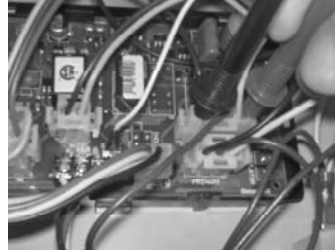

Checking line voltage to board. Pins to black and white wires.

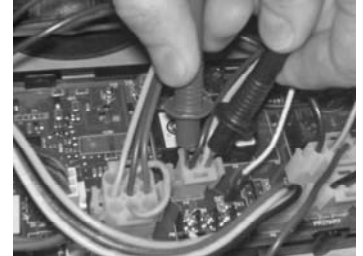

Checking secondary voltage from transformer. Pins to blue and yellow wires.

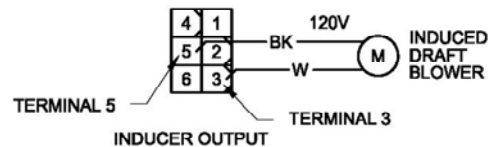

Checking line voltage at the blower wire harness connection on blower.

⚠ DANGER
120 volt exposure. To avoid personal injury, use caution while performing this procedure.

⚠ CAUTION
Be Careful When Making Voltage Measurements or Jumping Terminals Not to Damage or Deform Connectors or Connector Pins.

Condition:
Pilot will not light or stay lit, Error codes 62, or 63 shown on Water Heater Display

Reset control by pressing the lower right button under "reset" on the display for 3 seconds. Does control board start ignition sequence and start sparking (sparking noise at pilot or at board)

N → Replace control board

Y → Is there spark at the pilot?

N → Check for:
Loose or damaged ignition wire
Grounded pilot electrode
Damaged pilot.

Y → Is there 22-27 volts AC output across terminal pins 8 & 2 on "Control" plug of Control Board? Carefully insert meter probe in wire plug to check pin terminals. Make sure control is in the trial for ignition sequence (see sequence of operation). (see photo at top of page)

N → Replace control board.

Y → Is there 22-27 volts AC input across **wire leads** "MV/PV" & "PV" at **Gas Valve**? (see photo to the right)

Y → Loosen pilot tubing connection at the gas valve and soap test. Is there pilot gas flow out of the gas valve? See pilot illustration for pilot inspection.

Y → Check for clogged or kinked pilot tube, clogged pilot orifice. Clean or replace as needed. (see photo below)

N → Check wire harness for damage or loose connections. Repair or replace as needed.

N → Tighten pilot tube connection at the gas valve. Check incoming gas pressure to water heater. if okay, replace gas valve

Turn on power to the water heater and verify proper operation

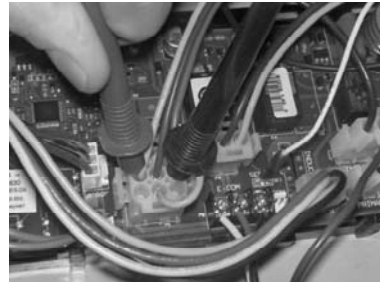

Checking for 24 volts output to pilot valve (yellow and red wire pin terminals on control board "control" plug).

Check across "MV/PV" & "PV" Wire leads to gas valve

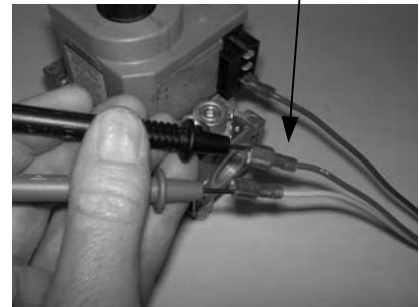

Checking MV pin terminal to gas valve wire harness for 24 volts output to gas valve during heating cycle (pilot must be lit with no sparking).

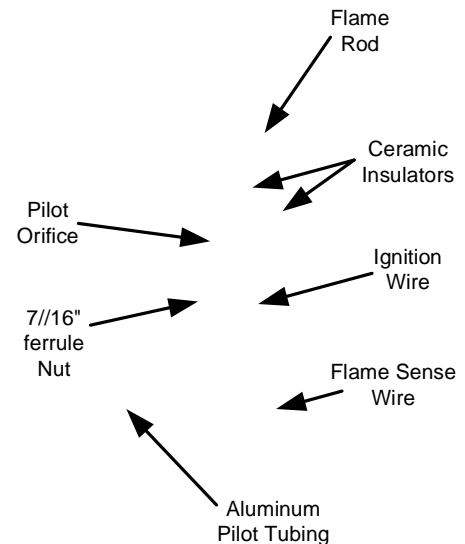

SERVICE PROCEDURE PDV24-III
Pilot Operation Testing

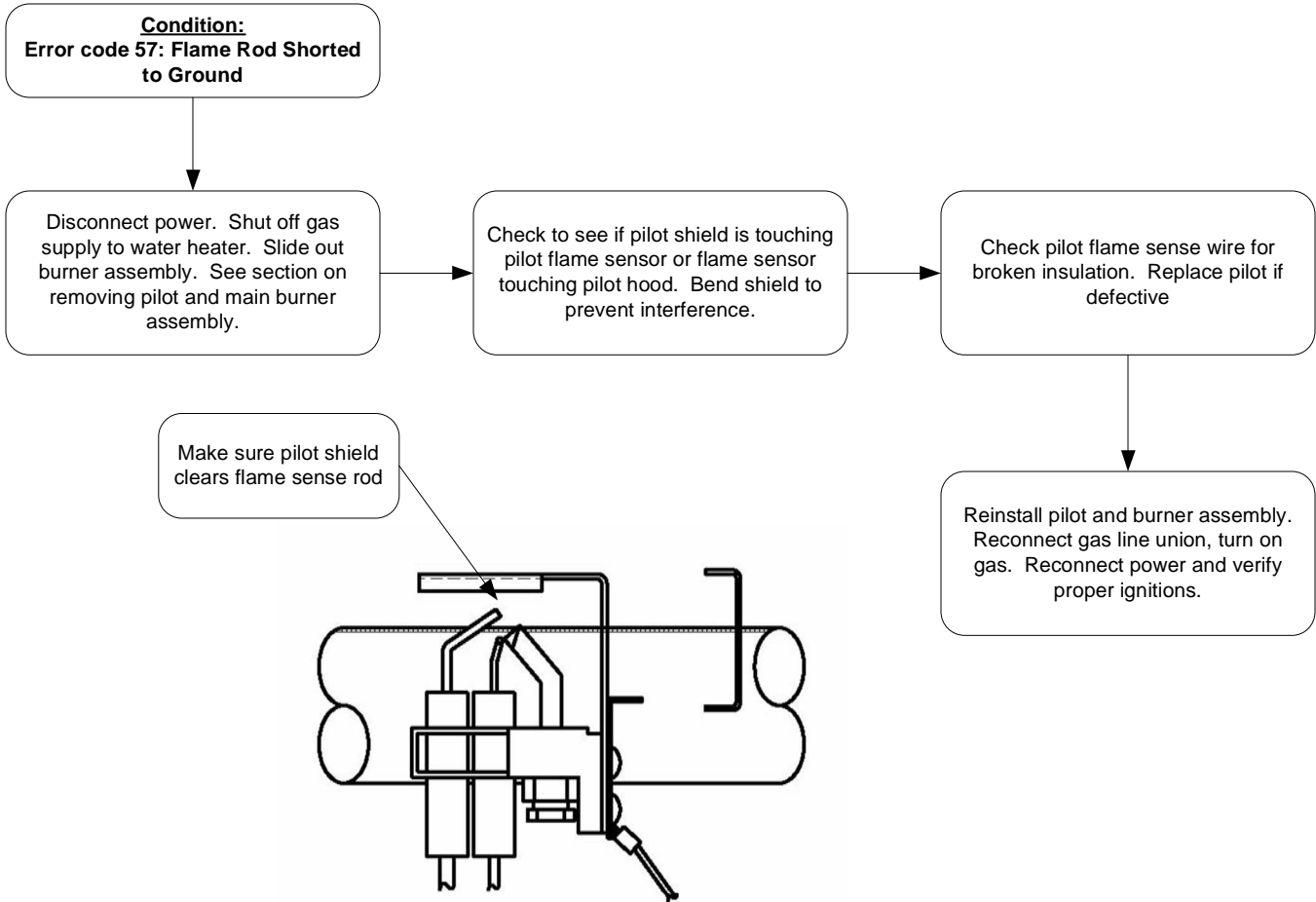

⚠ DANGER
120 volt exposure. To avoid personal injury, use caution while performing this procedure.

⚠ CAUTION
Be Careful When Making Voltage Measurements or Jumping Terminals Not to Damage or Deform Connectors or Connector Pins.

Condition:
Pilot lights, no or low flame signal. Control Display shows "4" or "62" for Error Codes (Service Needed). Control continues to spark until system "Lock Out". Main burner will not light.

Check for loose or damaged flame sense lead from pilot to module. (see illustration to the right). Is flame sense lead okay?
N → Repair wire lead or replace pilot.

Check for loose or damaged ground wire(s) from gas valve to control board. Check continuity of wires with ohmmeter. Are ground wires okay?
N → Repair ground wire(s) or replace as needed.

Check venting conditions (vent length & number of elbows) Is vent system okay?
N → Correct improper venting condition.

Is heater condensing causing pilot interruption?
Y → Make sure pilot shield is in place and not bent or damaged (refer to section on main burner and pilot assembly) . Determine cause for condensing and correct. Under sized water heater or high demand periods

The microamp output of the pilot may be checked by entering "Service Mode" on the water heater display and pressing "Select" until the flame current is shown. The control must be in the heating mode with the pilot lit to display a reading. See section on accessing service mode on the water heater display.
NOTE: Check continuity of flame sense lead to flame rod. If no continuity, clean pilot flame rod or replace pilot. Check pilot flame appearance - if weak check for clogged pilot orifice, bent pilot tubing, or low inlet gas pressure. (see above illustration)

Micro-amp readings
0.000 Micro Amp = Replace control board or pilot if wire is damaged.
1.0 micro amp or less = Clean pilot flame rod or replace pilot.

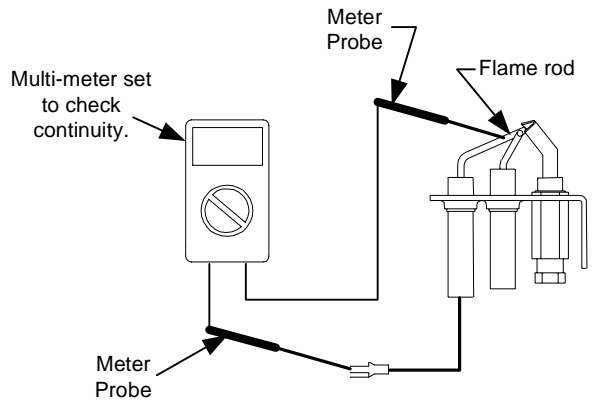

Checking pilot flame sensor wire and flame rod for continuity.

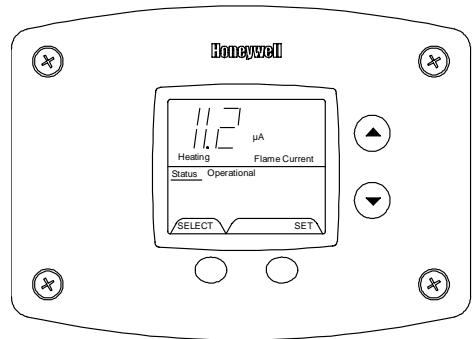

Pilot flame sensor microamp output shown in display using service mode. Pilot must be lit to get reading.

⚠ DANGER
120 volt exposure. To avoid personal injury, use caution while performing this procedure.

⚠ CAUTION
Be Careful When Making Voltage Measurements or Jumping Terminals Not to Damage or Deform Connectors or Connector Pins.

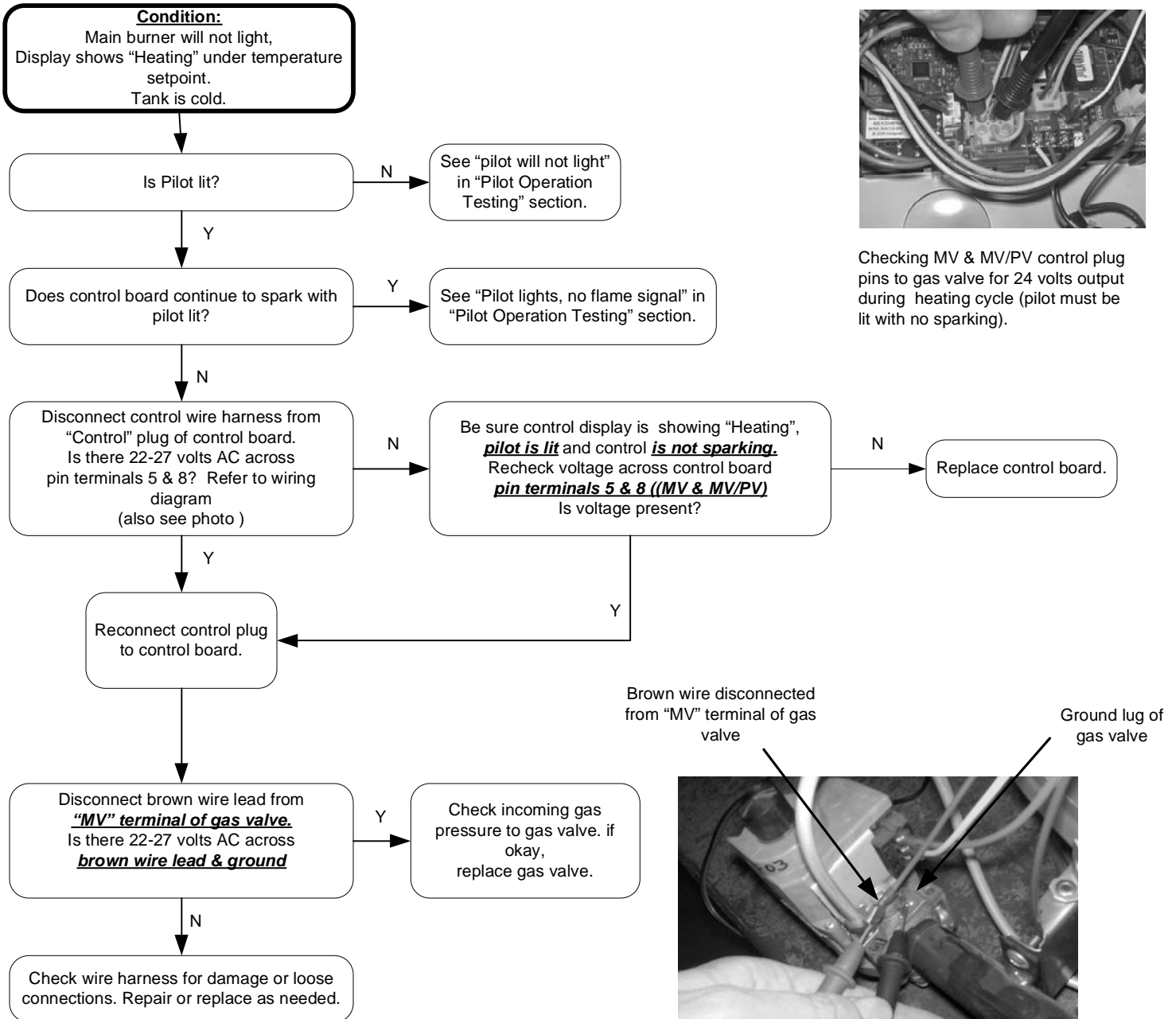

⚠ DANGER
120 volt exposure. To avoid personal injury, use caution while performing this procedure.

⚠ CAUTION
Be Careful When Making Voltage Measurements or Jumping Terminals Not to Damage or Deform Connectors or Connector Pins.

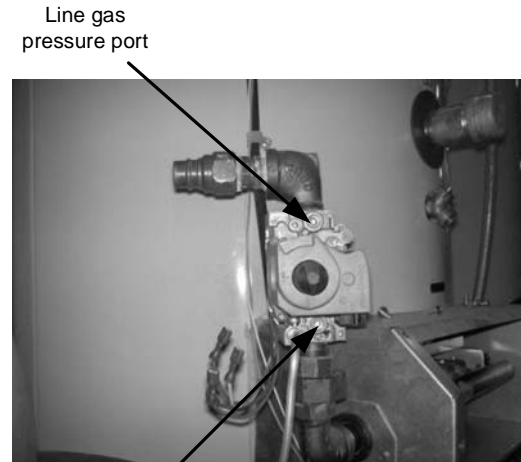
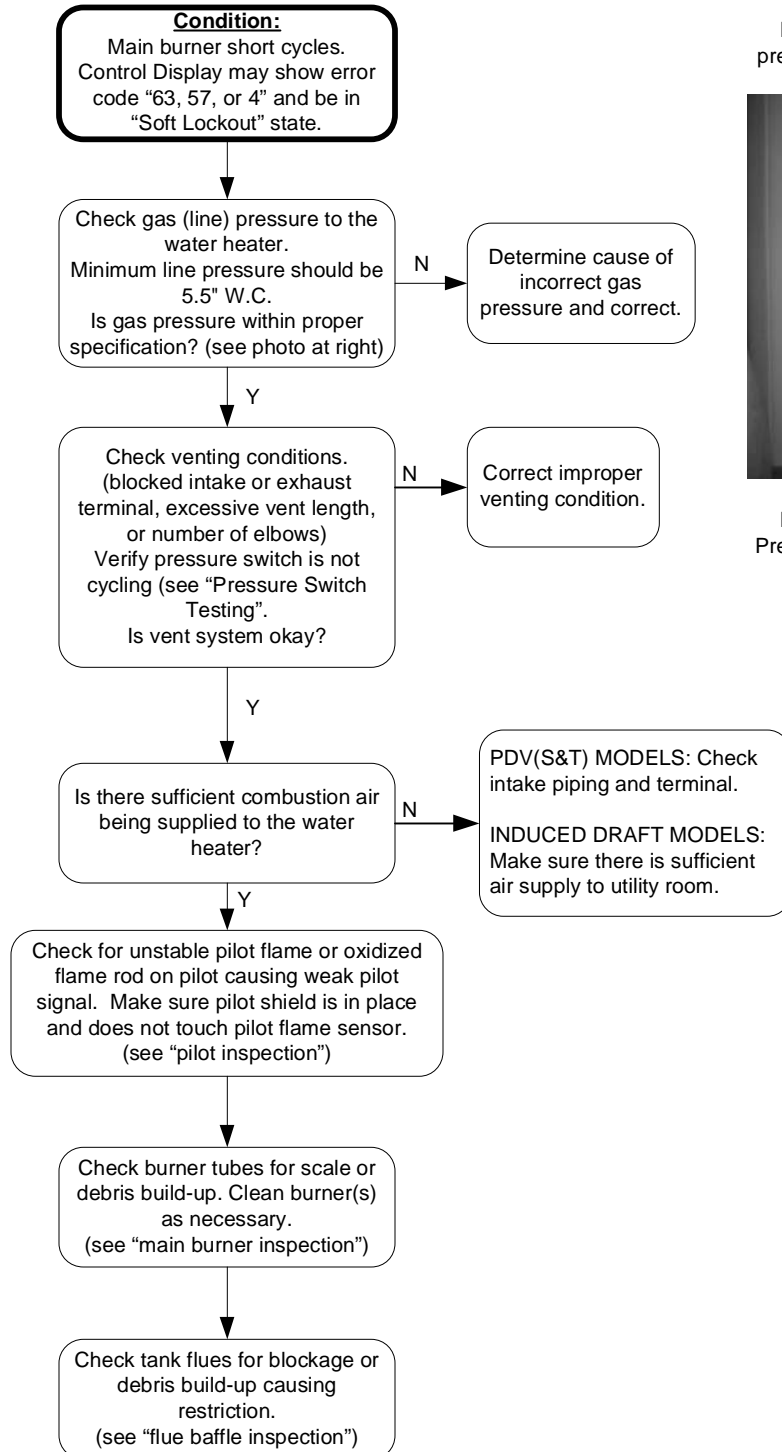

Manifold Pressure Port

Connect hose barb to manifold pressure port, then connect monometer to measure gas manifold pressure.

⚠ WARNING

Water Heater components may be HOT when performing the following steps in this procedure. Take necessary precaution to prevent personal injury.

PDV (S&T) MODELS

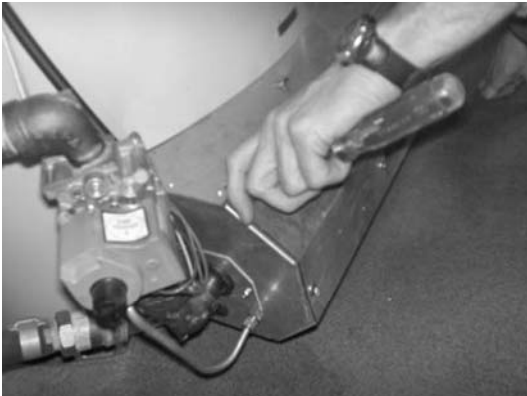

Step 1: Remove burner box cover screws

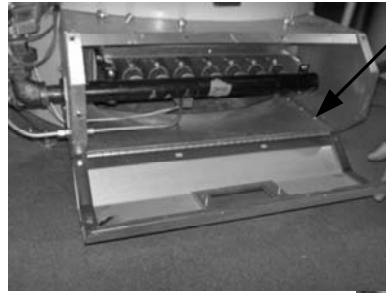

PDV-S MODELS
(Hinged Door)

PDV-T MODELS
(Removable Door)



Step 2: Open Burner Box Cover



Step 3: Disconnect Pilot Fitting from Burner Box



Step 4: Disconnect gas valve wires and pilot tube



Step 5: Disconnect and Remove Gas Valve



Step 6: Remove pipe flange plate from Burner Box

⚠ WARNING
Water Heater components may be HOT when performing the following steps in this procedure. Take necessary precaution to prevent personal injury.

PDV (S&T) MODELS



Step 7: Remove manifold bracket screws

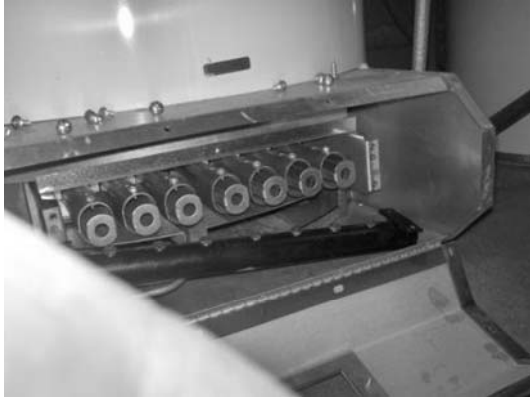

Step 8: Remove manifold from Burners



Step 9: Slide manifold out through side flange opening in Burner Box



Step 10: Disconnect Pilot Tube Fitting from inside Burner Box

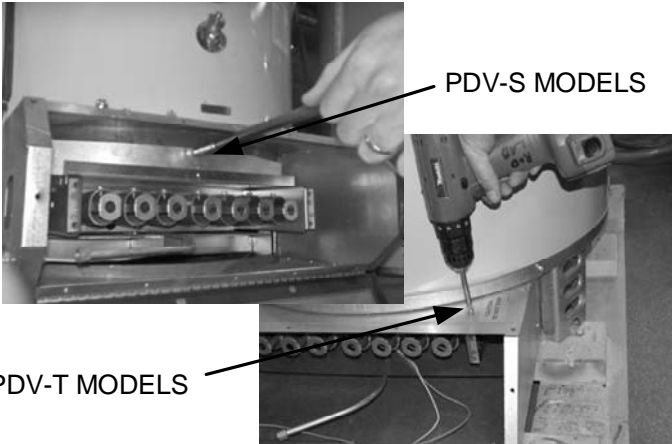

Step 11: Remove screw fastening burner to burner box/burner shroud.



Step 12: Disconnect Pilot wires from control board and remove from Control Box

⚠ WARNING

Water Heater components may be HOT when performing the following steps in this procedure. Take necessary precaution to prevent personal injury.

PDV (S&T) MODELS

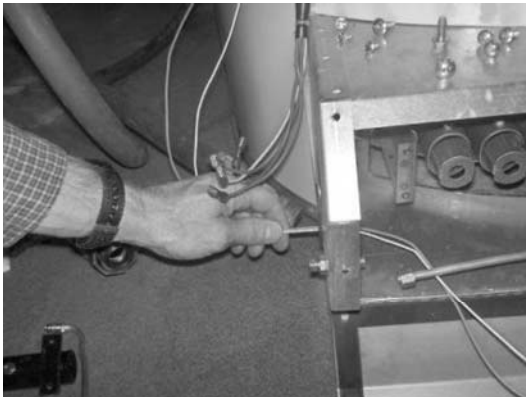

Step 13: Pull pilot wires through burner box



Step 14: Slide out burner assembly

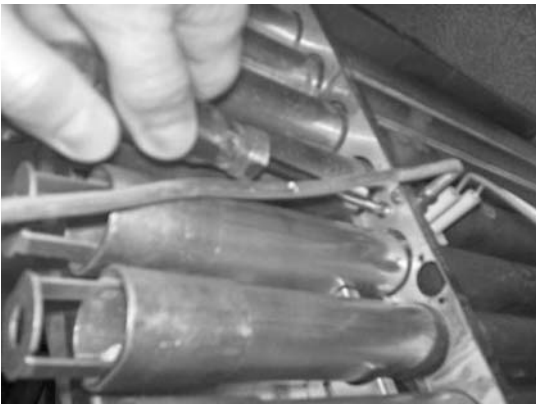

Step 15: To remove pilot, remove pilot bracket screws



Step 16: Slide pilot assembly to back of burner rack



Step 17: Pilot removal for servicing.

⚠ WARNING

Water Heater components may be **HOT** when performing the following steps in this procedure. Take necessary precaution to prevent personal injury.

INDUCED DRAFT MODELS

Main Burner Removal

- Step 1. Disconnect (un-plug) water heater from electrical supply.
- Step 2. Turn "OFF" gas supply to water heater.
- Step 3. Rotate gas valve control knob to the "OFF" position (see photos at right).
- Step 4. Disconnect Gas supply line from the gas valve.
- Step 5. Disconnect wire leads from gas valve (see photos at right).
- Step 6. Disconnect white flame sense wire & orange ignition wire from Control Board (see photos at right).
- Step 7. Remove the two burner rack mounting screws (see photos).
- Step 8. Slide complete burner rack out from water heater (see photos below).
- Step 9. To install burner, reverse above procedure.
- Step 10. Check for gas leaks and verify proper operation.

Gas Valve
Control Knob

Gas Valve
Wire Leads

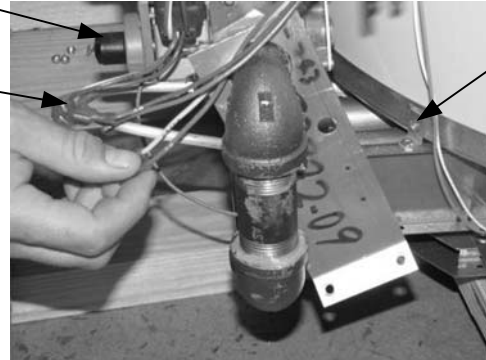

Burner Rack
Mounting
Screw

Pilot Flame Sense
Wire (White)

Pilot spark wire
(Orange)

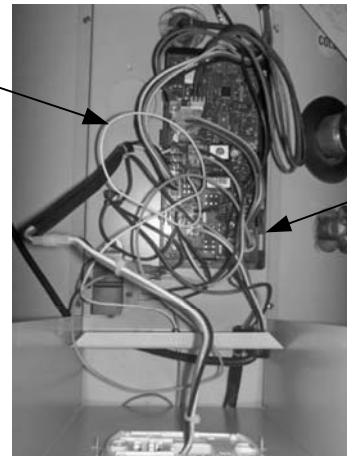

Burner Rack
Mounting
Screw



Pilot Draft
Shield



PDV (S&T) AND INDUCED DRAFT MODELS

Pilot Burner Removal

- Step 1. With burner rack removed from heater, disconnect pilot tube connection from gas valve
- Step 2. Remove the two pilot burner mounting screws securing the pilot and pilot shield in place.
- Step 3. Remove pilot shield and pilot from burner rack.
- Step 4. To install pilot burner and pilot shield, reverse above procedure. Be sure to reconnect green ground wire.

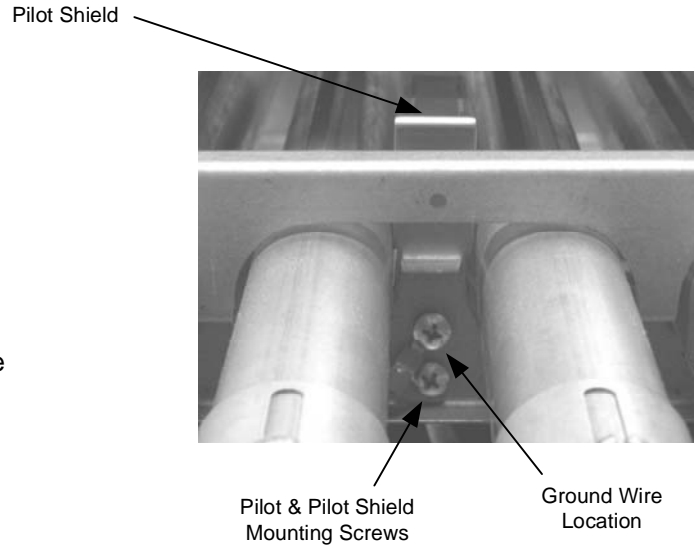

Pilot Burner Inspection

- Step 1. Inspect pilot for the following:
 - a) Broken or cracked ceramic insulators. If found, pilot must be replaced.
 - b) Damaged electrode or flame sense wire. If found, pilot must be replaced.
 - c) Oxidation build-up on flame rod. Clean flame rod or replace pilot as necessary.
- Step 2. Inspect pilot orifice:
 - a) Remove 7/16" ferrule nut from bottom of pilot.
 - b) Remove pilot tube and orifice from pilot.
 - c) Inspect pilot tube for blockage. Clean or replace as necessary.
 - d) Inspect pilot orifice for blockage. Clean or replace as necessary.

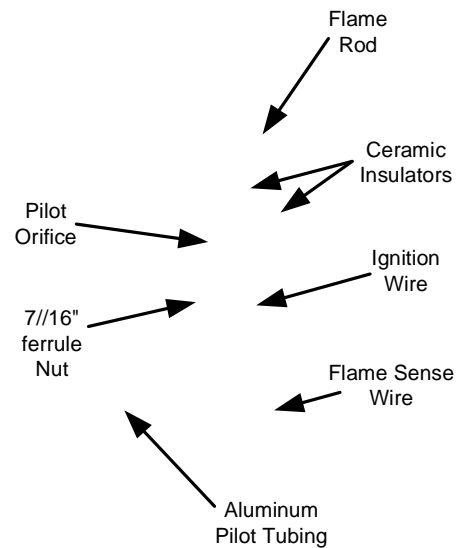

⚠ DANGER
120 volt exposure. To avoid personal injury, unplug while performing this procedure.

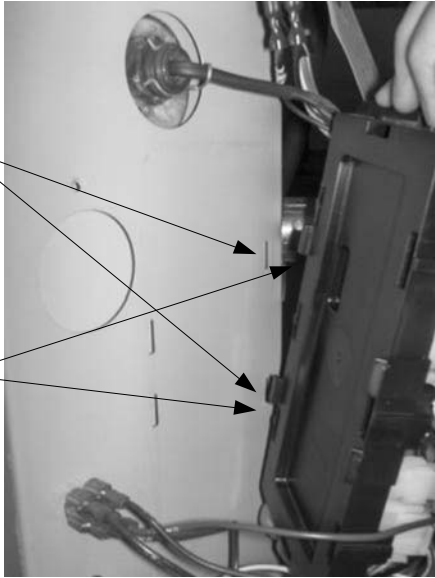
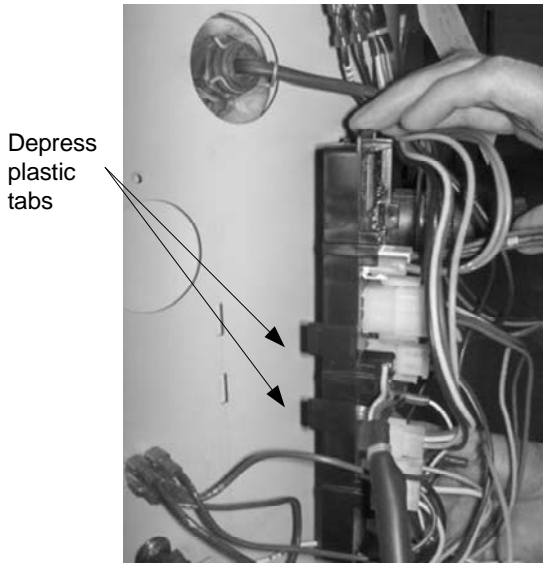

Control board replacement

Step 1. Depress left plastic tabs and pull out from slots in control panel

Step 2. Tilt control panel to the right and slide control hook tabs from slots in control panel.

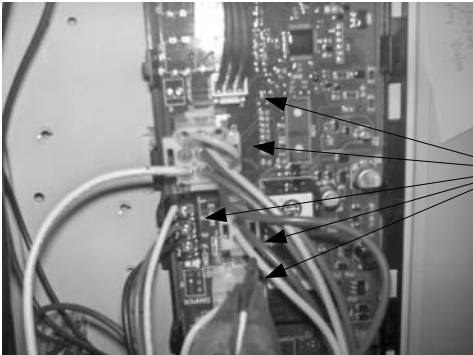

Step 3. Unplug wire connections from board and replace.



Remove lower sensor

Remove clip, pull sensor out.

⚠ WARNING

Heater components may be HOT when performing the following steps in this procedure. Take necessary precaution to prevent personal injury.

- Step 1. Disconnect (unplug) water heater from electrical supply.
- Step 2. Turn "OFF" water supply to water heater.
- Step 3. Open a near by hot water faucet to relieve tank pressure.
- Step 4. Connect hose to drain valve of water heater and route to an open drain. Open drain valve and drain a minimum of 5 gallons of water from the water heater. Close drain valve and disconnect drain hose from water heater.
- Step 5. If required, disconnect top plumbing connection from top of water heater.
- Step 6. Remove screws holding jacket head to top of water heater and remove jacket head from top of water heater. Note, it may be necessary to use a screw driver to pry underneath jacket head.
- Step 7. If required, remove insulation from top of water heater to expose collector cover.
- Step 8. Remove screws from top (or side) of collector cover. Note, it may be necessary to chisel away some foam to access screws.
- Step 9. Remove collector cover from water heater.
- Step 10. Remove flue baffles from water heater. Note, it may be necessary to use pliers to loosen and remove baffles from flue tubes.
- Step 11. Visually inspect flue baffles. Flue baffles may show signs of oxidation; this is normal. If the oxidation has deteriorated any portion of the flue baffle, replacement is recommended. If any restrictors are missing, replacement is recommended.
- Step 12. Upon completion of inspection or subsequent replacement, reinstall flue baffles into heater.
- Step 13. Reinstall collector cover and insulation (if applicable) over collector cover.
- Step 14. Reinstall jacket head.
- Step 15. Reconnect plumbing connection to top of water heater & turn on water supply if required.
- Step 16. Check for leaks and verify proper operation.

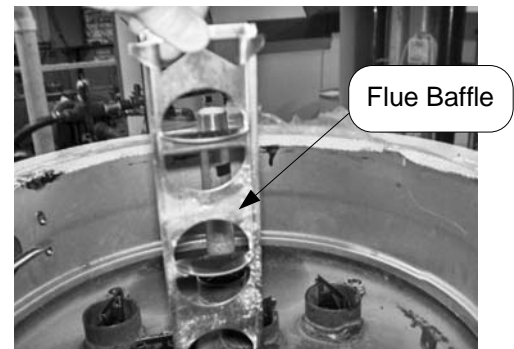

PDV Models

⚠ WARNING
Water Heater components may be HOT when performing the following steps in this procedure. Take necessary precaution to prevent personal injury.

- Step 1. Disconnect (unplug) water heater from electrical supply.
- Step 2. Turn "OFF" water supply to water heater.
- Step 3. Open a near by hot water faucet to relieve tank pressure.
- Step 4. Connect hose to drain valve of water heater and route to an open drain. Open drain valve and drain a minimum of 5 gallons of water from the water heater. Close drain valve and disconnect drain hose from water heater.
- Step 5. If required, disconnect top plumbing connection from top of water heater.
- Step 6. Remove screws holding jacket head to top of water heater and remove jacket head from top of water heater. Note, it may be necessary to use a screw driver to pry underneath jacket head (see photos at right).
- Step 7. Remove insulation from top of water heater to expose collector cover, if necessary. (see bottom of page for approx. anode locations)
- Step 8. Remove screws from top (or sides) of collector cover. Note, it may be necessary to chisel away some foam to access screws.
- Step 9. Locate and remove anode rods from top of water heater (1-1/16 hex socket).
- Step 10. Visually inspect anode rod. Anode rod may show signs of depletion; this is normal. If the anode shows signs of depletion (approximately 5/8", see photo at right), replacement is recommended. If any of the steel core of the anode is exposed, replacement is recommended.
- Step 11. Upon completion of inspection or subsequent replacement, reinstall anode rods into water heater.
- Step 12. Check for leaks.
- Step 13. Reinstall collector cover & insulation over collector cover, if applicable.
- Step 14. Reinstall jacket head.
- Step 15. Reconnect plumbing connection to top of water heater if required.
- Step 16. Restore water supply and power to water heater.
- Step 17. Verify proper operation.



Replace Anode

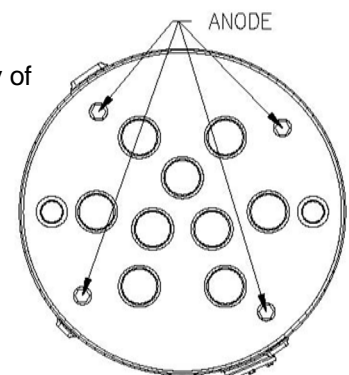
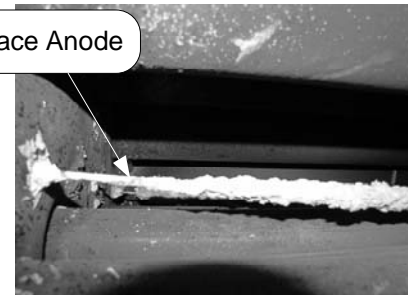

FRONT OF WATER HEATER
PDV S&T MODELS

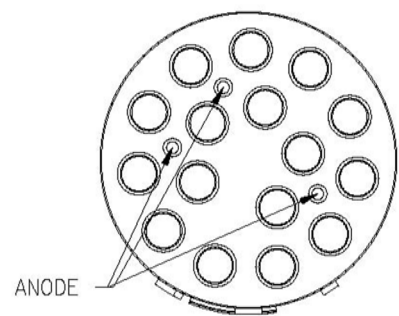

FRONT OF WATER HEATER
INDUCED DRAFT MODELS (D80T725, D65T625)

Generic Parts List
PDV-S

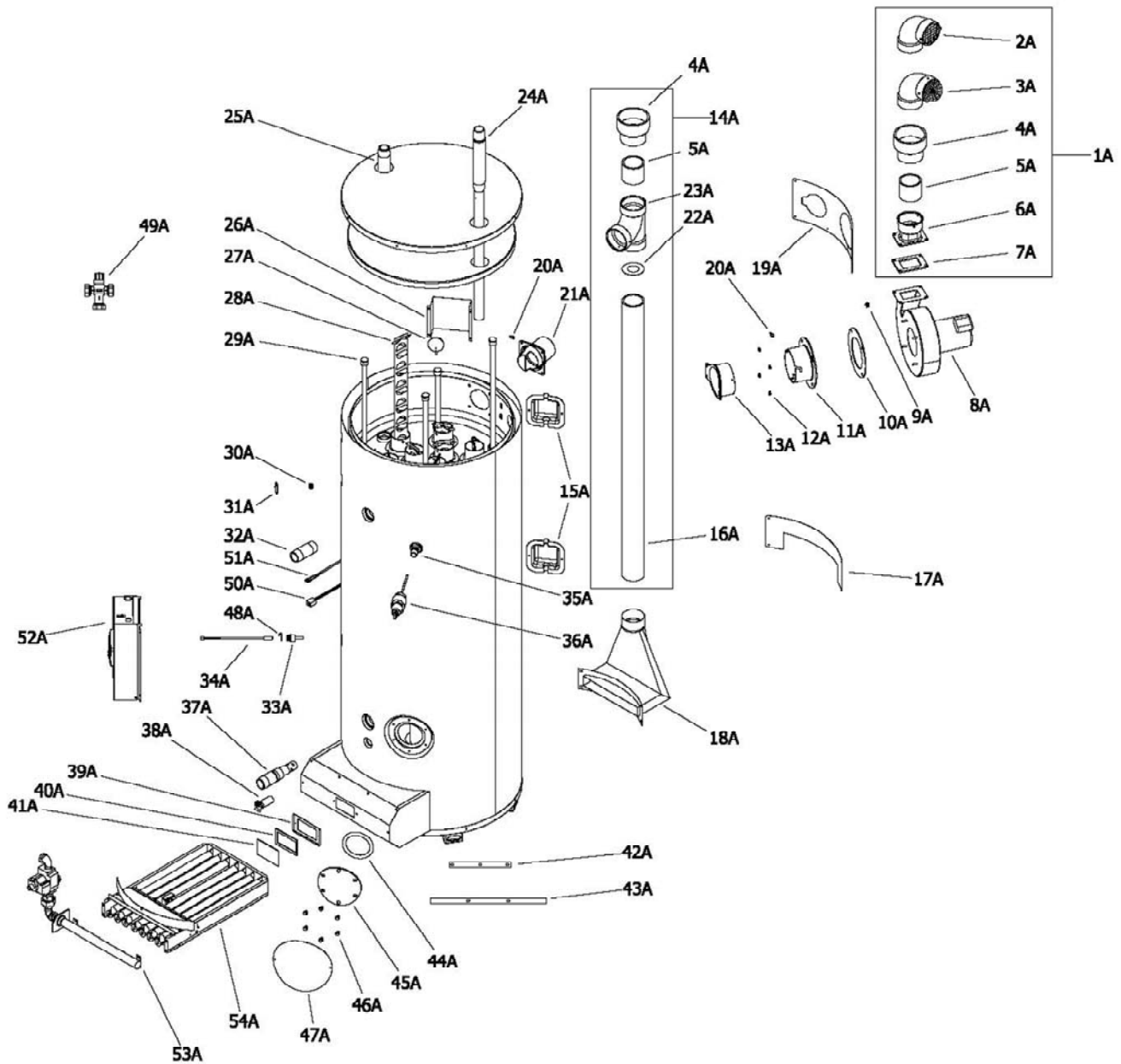

- | | | |
|-------------------------------------|--------------------------------|-----------------------------------|
| 1A. Vent Kit | 18A. Combustion Box Boot | 35A. T & P Nipple |
| 2A. Vent Elbow | 19A. Blower Escutcheon | 36A. T & P Valve |
| 3A. Intake Terminal | 20A. Blower Hose Barb | 37A. Cold Water Inlet Nipple |
| 4A. Vent Reducer | 21A. Air Inlet | 38A. Drain Valve |
| 5A. PVC Pipe | 22A. Vent Orifice | 39A. Sight Glass Holder |
| 6A. Blower Vent Adaptor | 23A. Air Intake Tee | 40A. Sight Glass Gasket |
| 7A. Blower Receptacle Gasket | 24A. Cold Water Inlet Dip Tube | 41A. Sight Glass |
| 8A. Blower | 25A. Hot Water Outlet Nipple | 42A. Combustion Box Gasket |
| 9A. Temperature Switch | 26A. Pressure Switch Cover | 43A. Combustion Box Gasket |
| 10A. Blower Intake Gasket | 27A. Pressure Switch | 44A. Cleanout Gasket |
| 11A. Blower Mounting Flange | 28A. Flue Baffle | 45A. Cleanout Cover (Tank) |
| 12A. 1/4-20 Hex Nut | 29A. Hex Head Anode | 46A. 5/16-18 Hex Screw |
| 13A. Collector to Blower Transition | 30A. Pipe Plug | 47A. Cleanout Cover (Jacket) |
| 14A. Air Intake Assembly | 31A. Hole Closure | 48A. Lower Thermostat Sensor Clip |
| 15A. Utility Cover | 32A. Hot Water Outlet Nipple | 49A. ASSE Approved Mixing Valve |
| 16A. Air Intake Pipe | 33A. Lower Thermostat Well | 50A. Blower Harness |
| 17A. Cover Rear Boot | 34A. Wire Harness Lower Sensor | 51A. Pressure Switch Harness |

Generic Parts List
PDV S

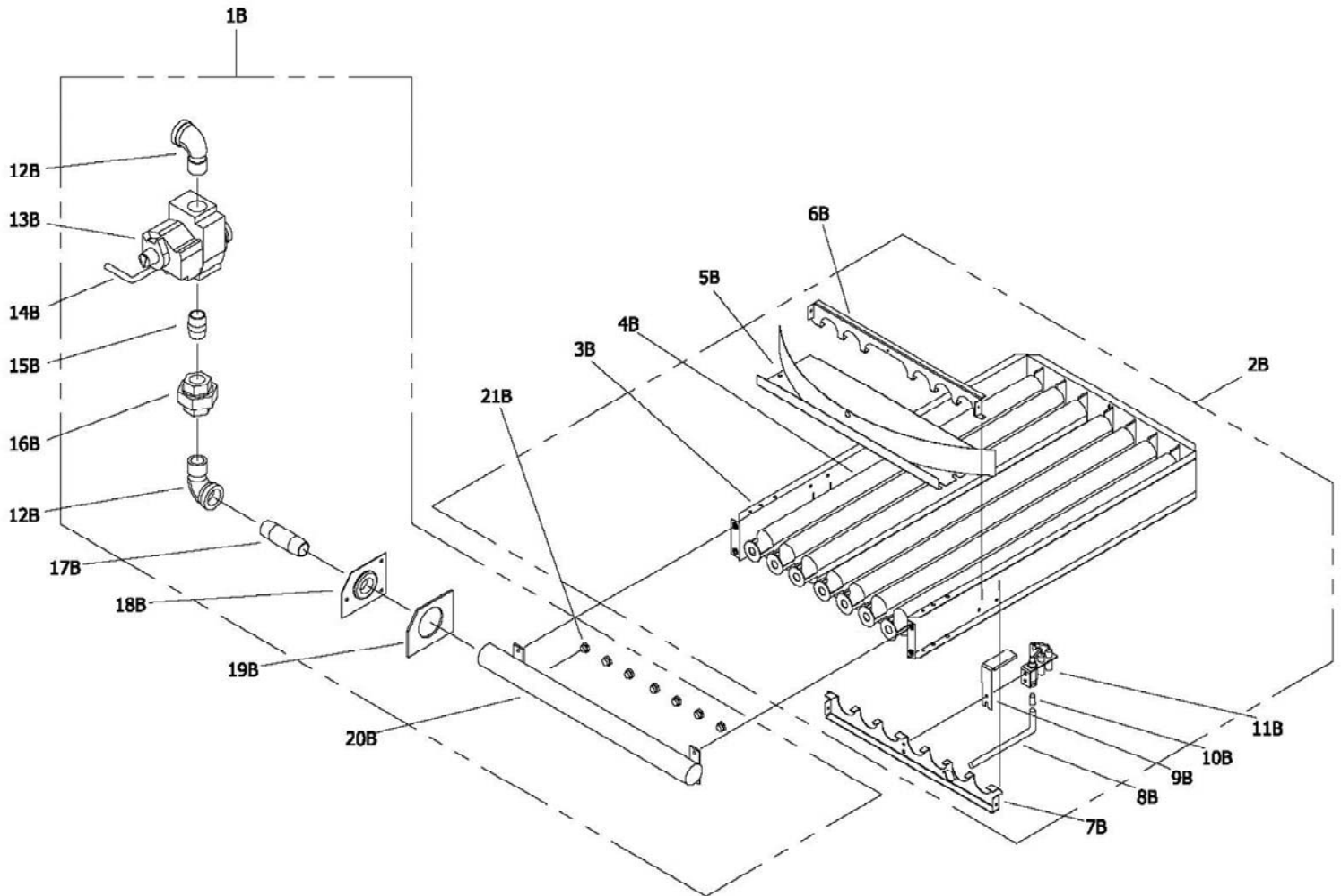

- | | |
|------------------------|----------------------------|
| 1B. Gas Valve Assembly | 12B. Street Elbow |
| 2B. Burner Assembly | 13B. Gas Valve |
| 3B. Burner Rack | 14B. Aluminum Tubing |
| 4B. Burner Tube | 15B. Nipple Close |
| 5B. Burner Shroud | 16B. Union |
| 6B. Burner Draft Panel | 17B. Nipple |
| 7B. Burner Support | 18B. Combustion Box Flange |
| 8B. Aluminum Tubing | 19B. Flange Gasket |
| 9B. Pilot Shield | 20B. Manifold |
| 10B. Pilot Orifice | 21B. Main Burner Orifice |
| 11B. Pilot Assembly | |

Generic Parts List
PDV-S

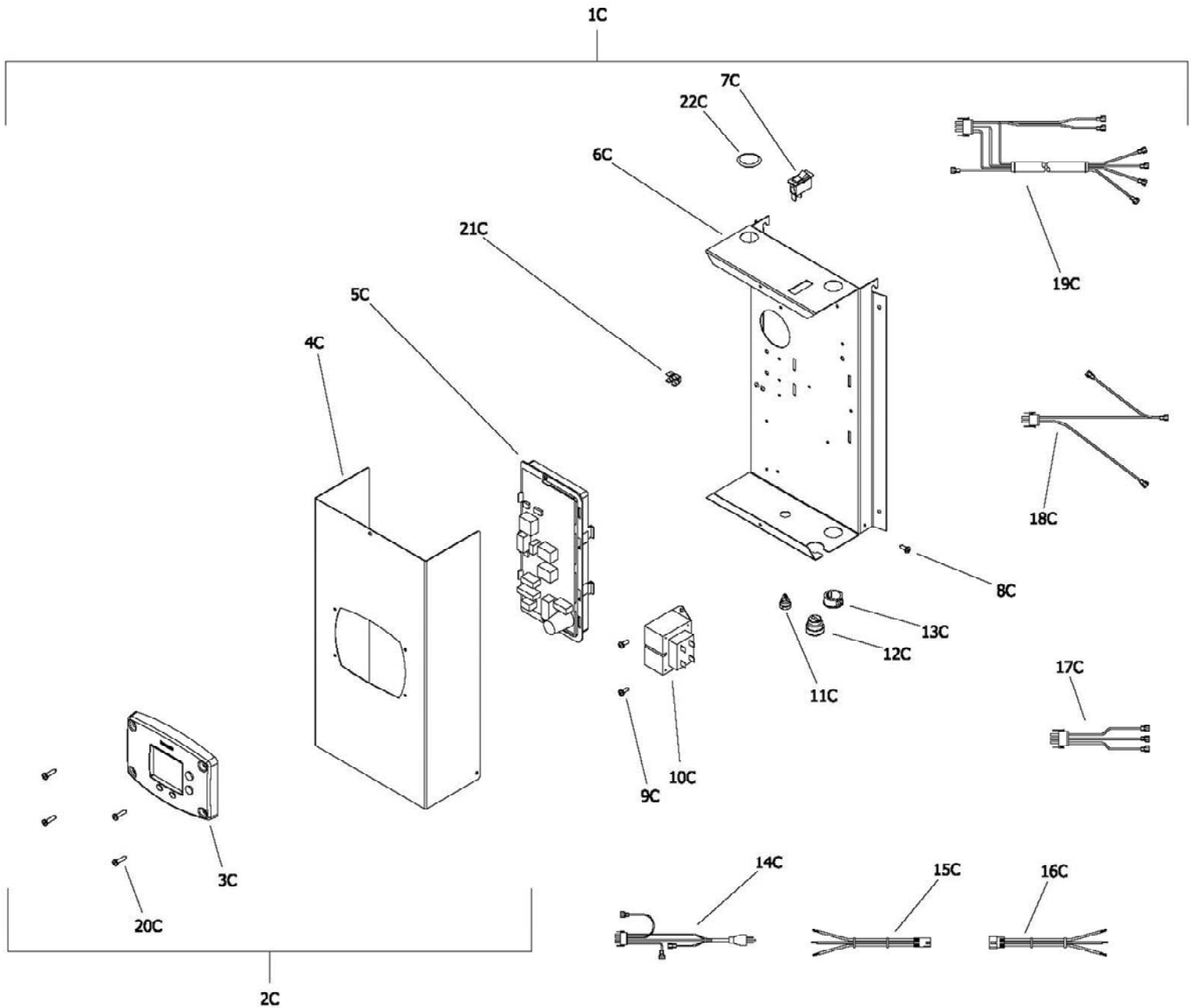

- 1C. Control Box Assembly
- 2C. Control Box Cover Assembly
- 3C. Honeywell Display
- 4C. Control Box Cover
- 5C. Integrated Control Board
- 6C. Control Box Panel
- 7C. Power On/Off Switch
- 8C. Pan Head Screw w/adh.
- 9C. Pan Head Screw #8-18
- 10C. Transformer
- 11C. Strain Relief Bushing 1/2"

- 12C. Strain Relief Bushing 7/8"
- 13C. Snap-In-Bushing 7/8"
- 14C. Power Cord Wiring Harness
- 15C. Display Control Wiring Harness
- 16C. Display Cover Wiring Harness
- 17C. Primary Transformer Wiring Harness
- 18C. Secondary Transformer Wiring Harness
- 19C. Gas Valve Control Wiring Harness
- 20C. Pan Head Screw #8-18.
- 21C. Ground Lug
- 22C. Snap-In-Plug 7/8"

Generic Parts List PDV-T

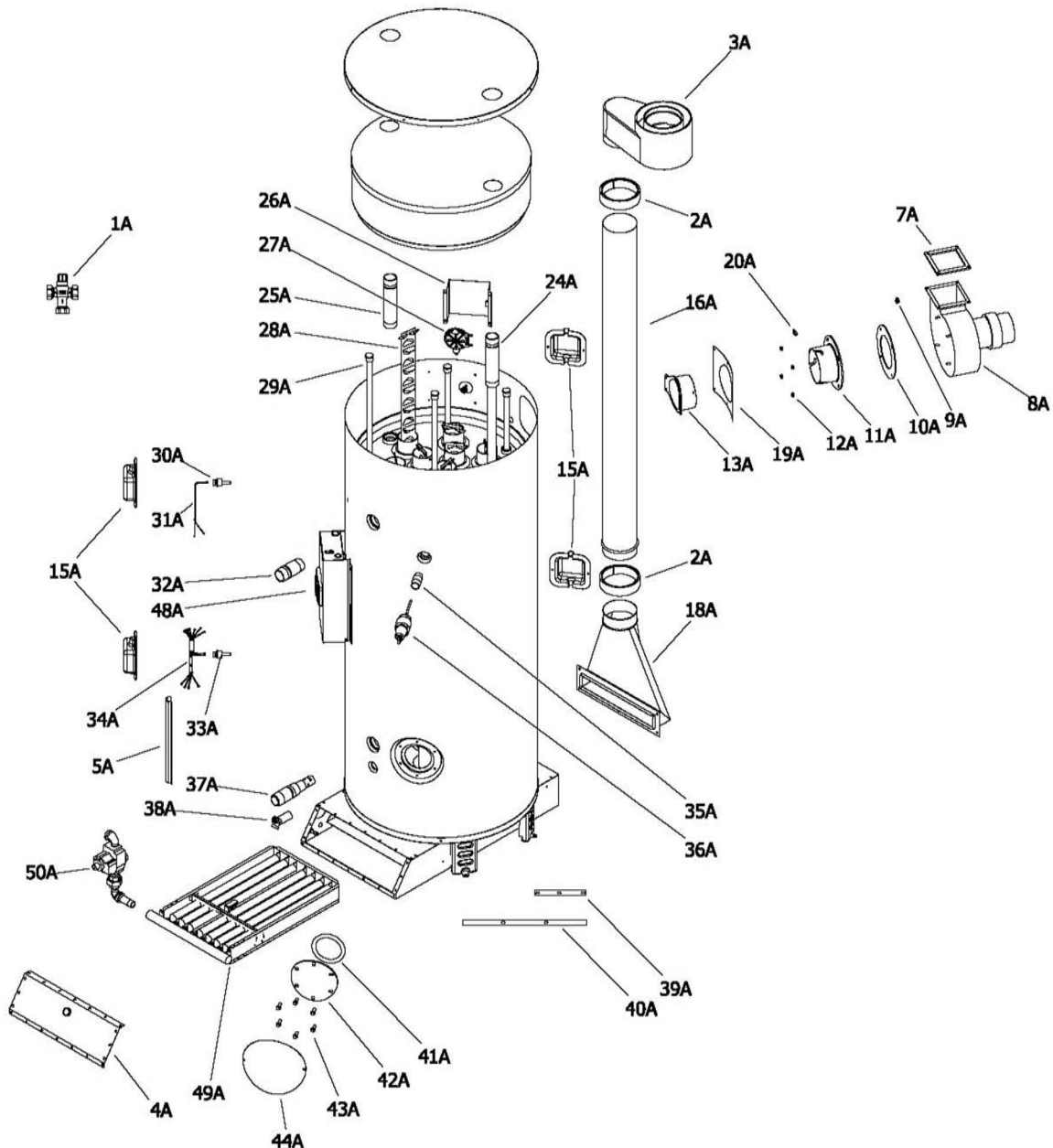

- | | | |
|-------------------------------------|--------------------------------|--------------------------------|
| 1A. ASSE Approved Mixing Valve | 18A. Combustion Box Boot | 35A. T & P Nipple |
| 2A. Vent Clamp | 19A. Blower Escutcheon | 36A. T & P Valve |
| 3A. Blower Vent Adapter | 20A. Blower Hose Barb | 37A. Cold Water Inlet Dip Tube |
| 4A. Combustion Box Cover | 24A. Cold Water Inlet Dip Tube | 38A. Drain Valve |
| 5A. Wire Raceway | 25A. Hot Water Outlet Nipple | 39A. Combustion Box Gasket |
| 7A. Blower Receptacle Gasket | 26A. Pressure Switch Cover | 40A. Combustion Box Gasket |
| 8A. Blower | 27A. Pressure Switch | 41A. Cleanout Gasket |
| 9A. Temperature Switch | 28A. Flue Baffle | 42A. Cleanout Cover (Tank) |
| 10A. Blower Intake Gasket | 29A. Hex Head Anode | 43A. 5/16-18 Hex Screw |
| 11A. Blower Mounting Flange | 30A. Upper Thermostat Sensor | 44A. Cleanout Cover (Jacket) |
| 12A. 1/4-20 Hex Nut | 31A. Upper Sensor Wire Harness | |
| 13A. Collector to Blower Transition | 32A. Hot Water Outlet Nipple | |
| 15A. Utility Cover | 33A. Lower Thermostat Sensor | |
| 16A. Air Intake Pipe | 34A. Lower Sensor Wire Harness | |

Generic Parts List
PDV T

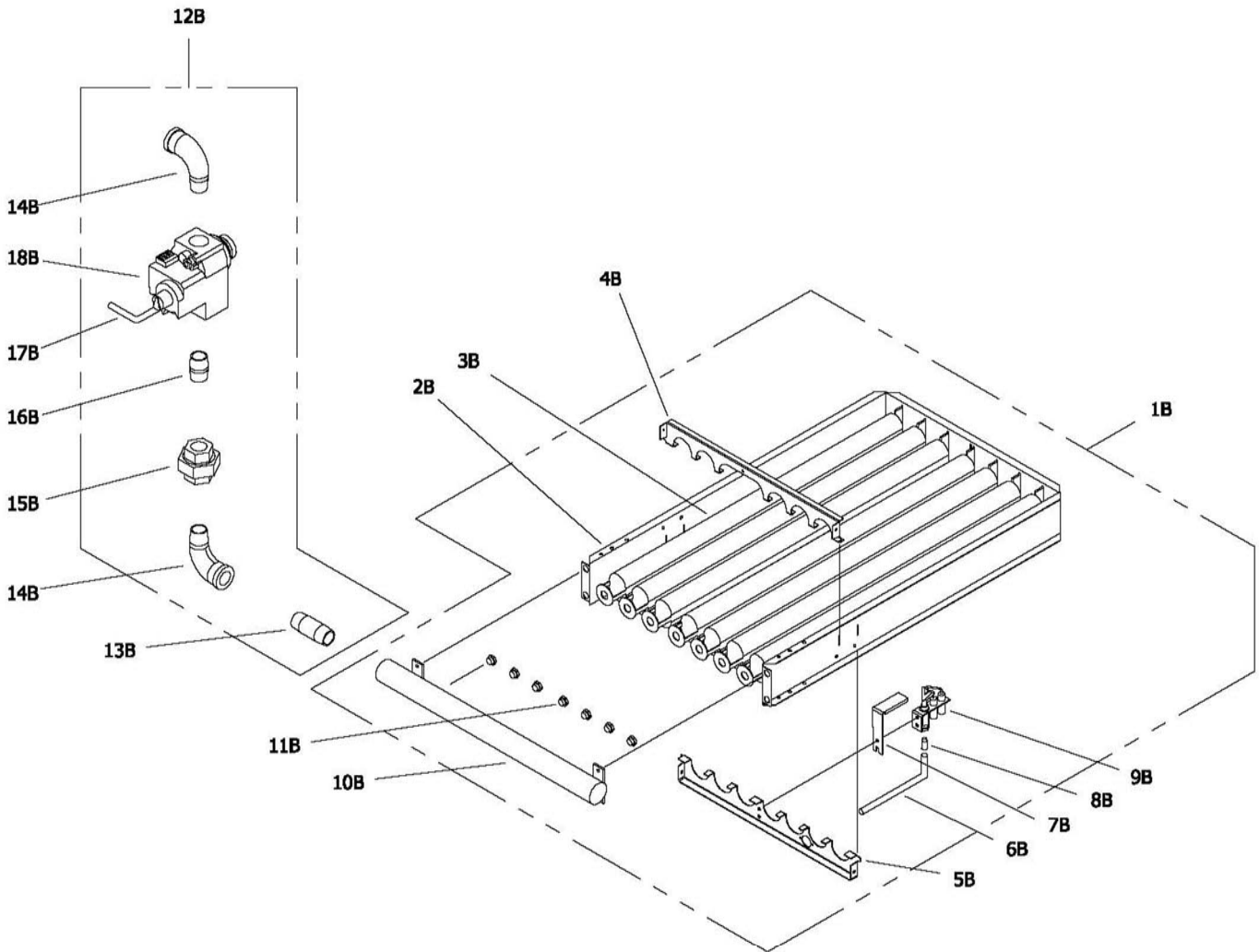

- | | |
|--------------------------|-------------------------|
| 1B. Burner Assembly | 12B. Gas Valve Assembly |
| 2B. Burner Rack | 13B. Nipple |
| 3B. Burner Tube | 14B. Street Elbow |
| 4B. Burner Draft Panel | 15B. Union |
| 5B. Burner Support | 16B. Nipple Close |
| 6B. Aluminum Tubing | 17B. Aluminum Tubing |
| 7B. Pilot Shield | 18B. Gas Valve |
| 8B. Pilot Orifice | |
| 9B. Pilot Assembly | |
| 10B. Manifold | |
| 11B. Main Burner Orifice | |

Generic Parts List
PDV-T

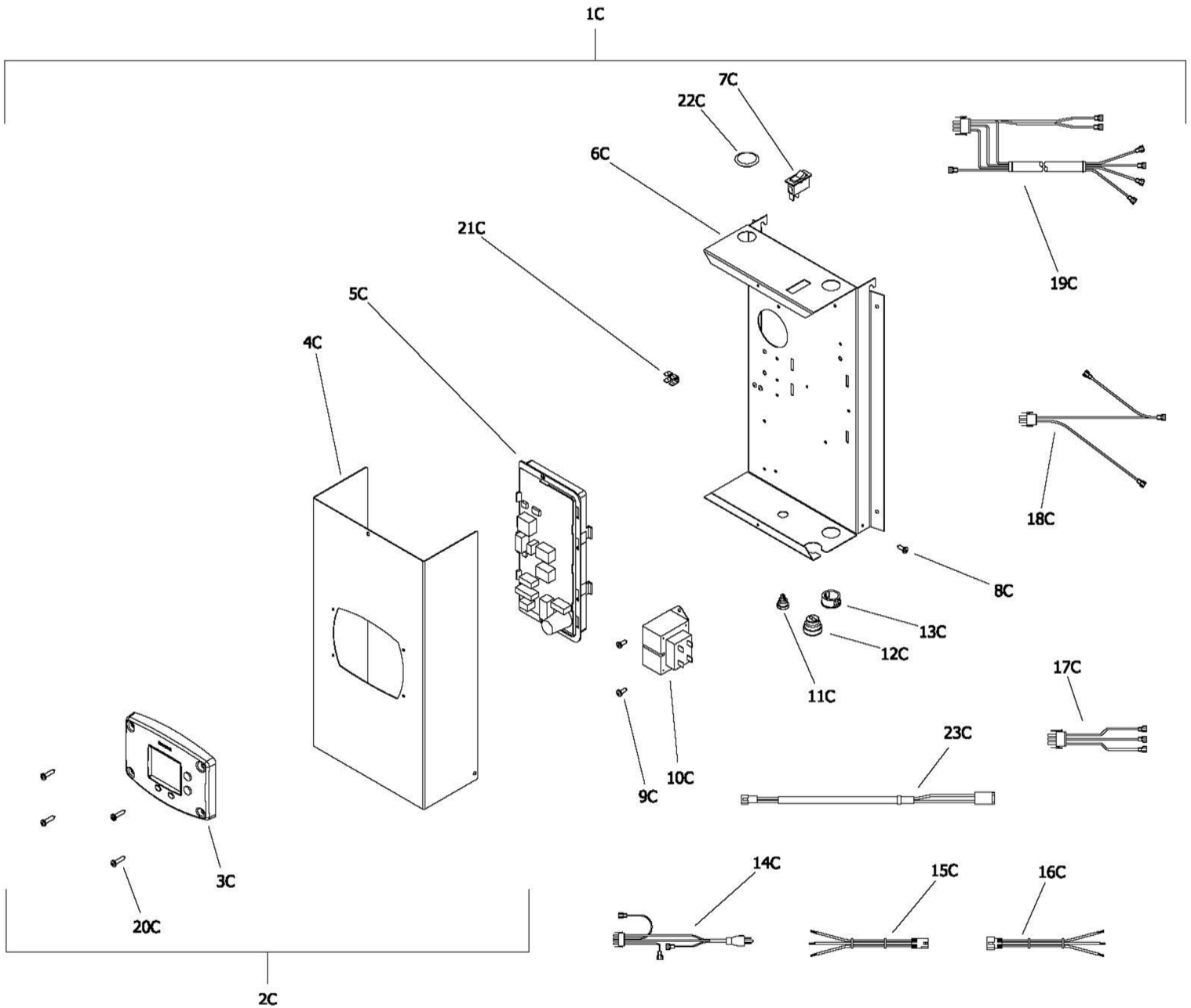

- 1C. Control Box Assembly
- 2C. Control Box Cover Assembly
- 3C. Honeywell Display
- 4C. Control Box Cover
- 5C. Integrated Control Board
- 6C. Control Box Panel
- 7C. Power On/Off Switch
- 8C. Pan Head Screw w/adh.
- 9C. Pan Head Screw #8-18
- 10C. Transformer
- 11C. Strain Relief Bushing 1/2"

- 12C. Strain Relief Bushing 7/8"
- 13C. Snap-In-Bushing 7/8"
- 14C. Power Cord Wiring Harness
- 15C. Display Control Wiring Harness
- 16C. Display Cover Wiring Harness
- 17C. Primary Transformer Wiring Harness
- 18C. Secondary Transformer Wiring Harness
- 19C. Gas Valve Control Wiring Harness
- 20C. Pan Head Screw #8-18.
- 21C. Ground Lug
- 22C. Snap-In-Plug 7/8"
- 23C. Upper Sensor Harness

Generic Parts List
INDUCED DRAFT MODELS

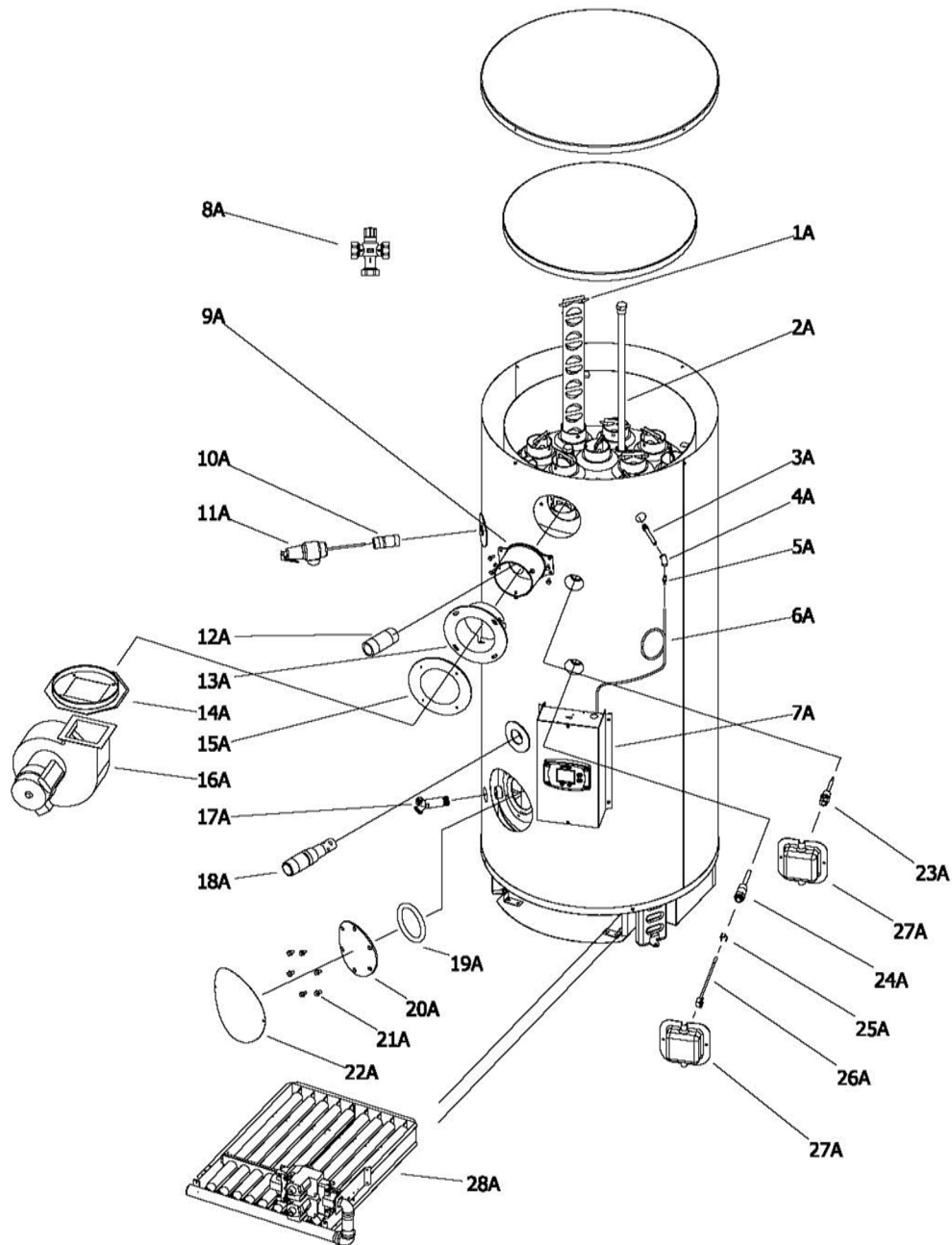

- | | |
|--------------------------------|--------------------------------|
| 1A. Flue Baffle | 15A. Flange Gasket |
| 2A. Hex Head Anode | 16A. Blower |
| 3A. Pressure Tap Fitting | 17A. Drain Valve |
| 4A. 1/8" NPT Elbow | 18A. Cold Water Inlet Dip Tube |
| 5A. Hose Barb | 19A. Cleanout Gasket |
| 6A. Silicone Hose | 20A. Cleanout Cover (Tank) |
| 7A. Control Box Assembly | 21A. 5/16-18 Hex Screw |
| 8A. ASSE Approved Mixing Valve | 22A. Cleanout Cover (Jacket) |
| 9A. Blower Transistion | 23A. Upper Thermostat |
| 10A. T & P Nipple | 24A. Lower Thermostat Well |
| 11A. T & P Valve | 25A. Lower Thermostat Clip |
| 12A. Hot Water Outlet Nipple | 26A. Lower Thermostat Sensor |
| 13A. Blower Flange Mount | 27A. Utility Cover |
| 14A. Vent Adapter | 28A. Burner Assembly |

Generic Parts List
INDUCED DRAFT MODELS

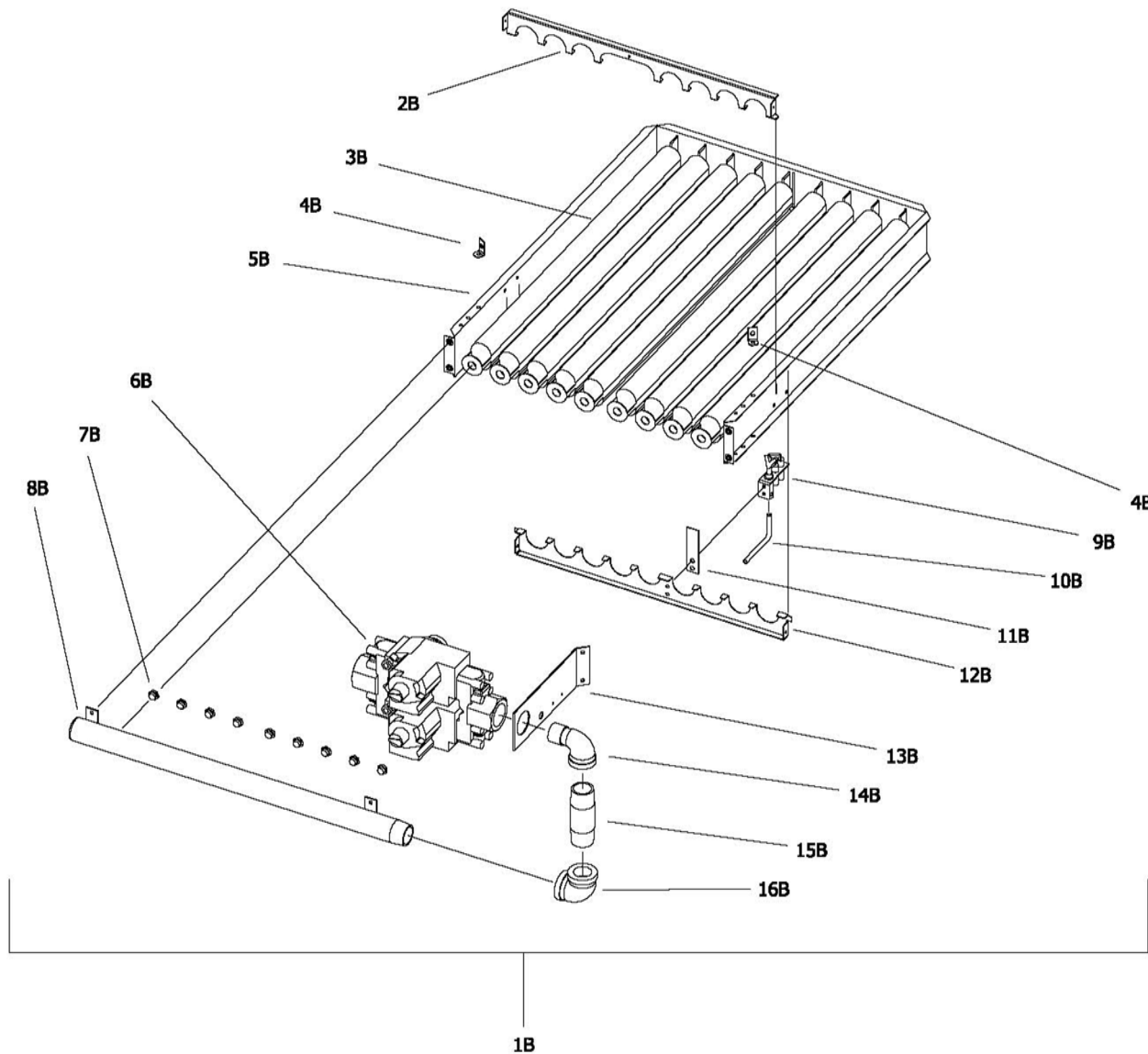

- | | |
|-----------------------------|-----------------------------|
| 1B. Burner Assembly | 9B. Pilot Assembly |
| 2B. Burner Panel | 10B. Aluminum Tubing |
| 3B. Burner Tube | 11B. Pilot Draft Shield |
| 4B. Burner Mounting Bracket | 12B. Burner Support |
| 5B. Burner Rack | 13B. Valve Support Bracket |
| 6B. Dual Gas Valve Assembly | 14B. 1" NPT Street Elbow |
| 7B. Main Burner Orifice | 15B. 1" NPT X 3-1/2" Nipple |
| 8B. Manifold | 16B. 1" NPT Elbow |

Generic Parts List
INDUCED DRAFT MODELS

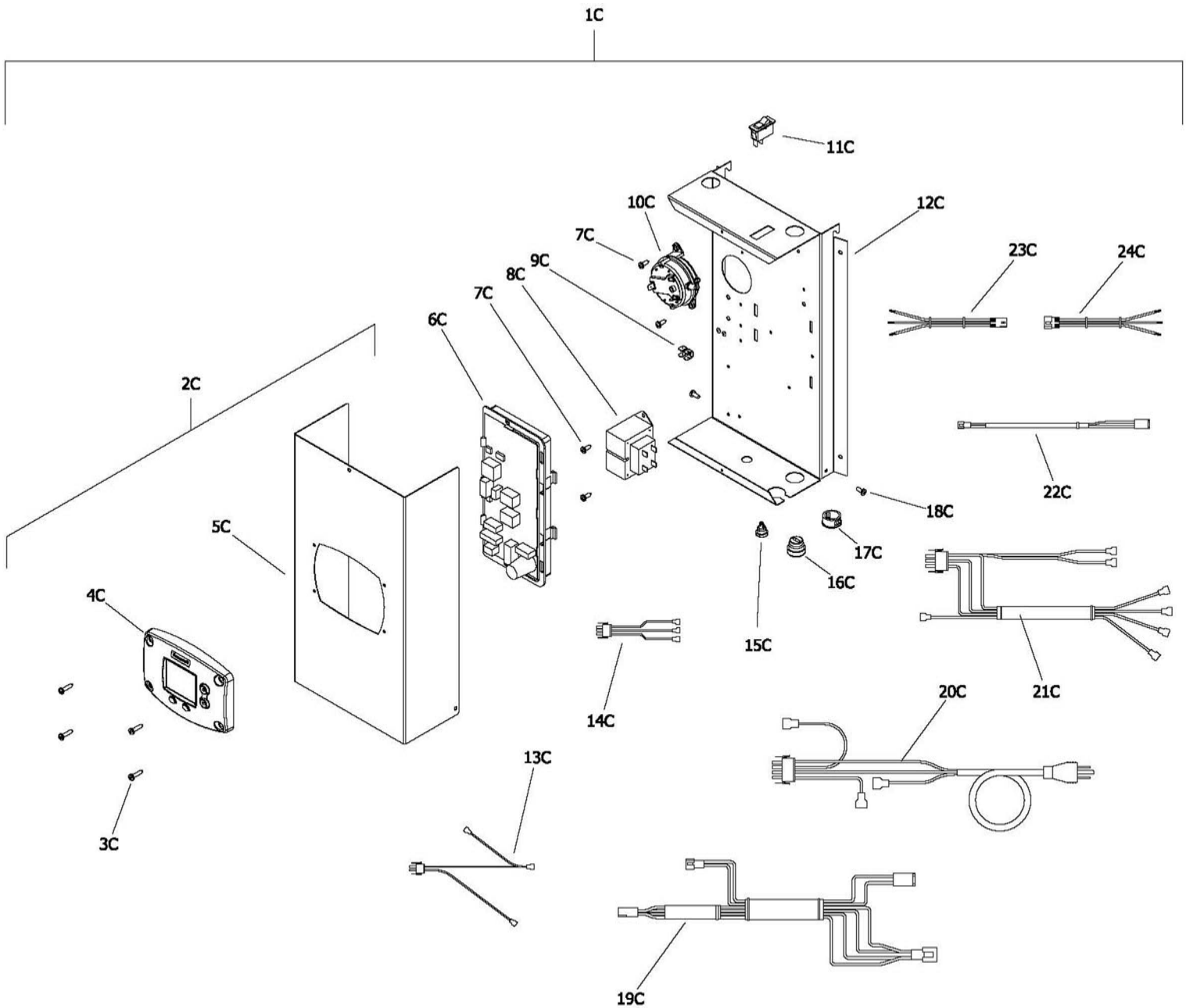

- 1C. Control Box Assembly
- 2C. Control Box Cover Assembly
- 3C. Pan Head Screw #8-18
- 4C. Honeywell Display
- 5C. Control Box Cover
- 6C. Integrated Control Board
- 7C. Pan Head Screw #8-18
- 8C. Transformer
- 9C. Ground Lug
- 10C. Pressure Switch
- 11C. Power On/Off Switch
- 12C. Control Box Panel

- 13C. Secondary Transformer Wiring Harness
- 14C. Primary Transformer Wiring Harness
- 15C. Strain Relief Bushing 1/2"
- 16C. Strain Relief Bushing 7/8"
- 17C. Snap-In-Plug 7/8"
- 18C. Pan Head Screw w/adh.
- 19C. Blower Wiring Harness
- 20C. Power Cord Wiring Harness
- 21C. Gas Valve Control Wiring Harness
- 22C. Upper Sensor Harness
- 23C. Display Control Wiring Harness
- 24C. Display Cover Wiring Harness

AC	Alternating Current
BTU/H	British Thermal Units
CO	Carbon Monoxide
CO2	Carbon Dioxide
DC	Direct Current
ECO	Energy Cut Off
GFI	Ground fault interrupt
GPM	Gallons per Minute
Hz	Hertz
LED	Light Emitting Diode
NOx	Oxides of Nitrogen
NPT	National Pipe Thread
PSI	Pounds per Square Inch
VA	Volt Amps
VAC	Volts Alternating Current
W.C.	Inches of Water Column
°C	Degrees Centigrade
°F	Degrees Fahrenheit
μA	Micro Amp

NOTES

Free Manuals Download Website

<http://myh66.com>

<http://usermanuals.us>

<http://www.somanuals.com>

<http://www.4manuals.cc>

<http://www.manual-lib.com>

<http://www.404manual.com>

<http://www.luxmanual.com>

<http://aubethermostatmanual.com>

Golf course search by state

<http://golfingnear.com>

Email search by domain

<http://emailbydomain.com>

Auto manuals search

<http://auto.somanuals.com>

TV manuals search

<http://tv.somanuals.com>