



Electric Instantaneous Water Heaters



The KwickShot® Electric Instantaneous Water Heaters Models Feature:

- **On Demand Hot Water**—No delay.
- **Reduced Energy Waste**—Flow switch activates heater only on demand (no stand-by heat loss). 99% efficient.
- **Continuous Hot Water**—No storage capacity to run out.
- **No Need for a T&P Relief Valve**—Check local codes.
- **Integral Flow Restrictor**—Built-in to ensure proper temperature rise.
- **Prevention Of Bacteria Growth.**
- **Easy Installation**—Mounts on wall – no sweat connections.
- **Ni Chrome Heating Element**—A unique, patented flow path ensures optimum heat transfer and extended element life.
- **Durable Design**—Reduces calcification and sedimentation.
- **Space Saving Installation**—Compact size.
- **High Temperature Limit Switch**—Protects against element burn out, with reset button.
- **Warranty**—Heaters are designed for durability and guaranteed against failure due to leaks of Heater Body/Element Assembly for a period of 10 years. Field serviceable element with replaceable cartridge element (1 year warranty).
- **Single Phase and Three Phase models.**

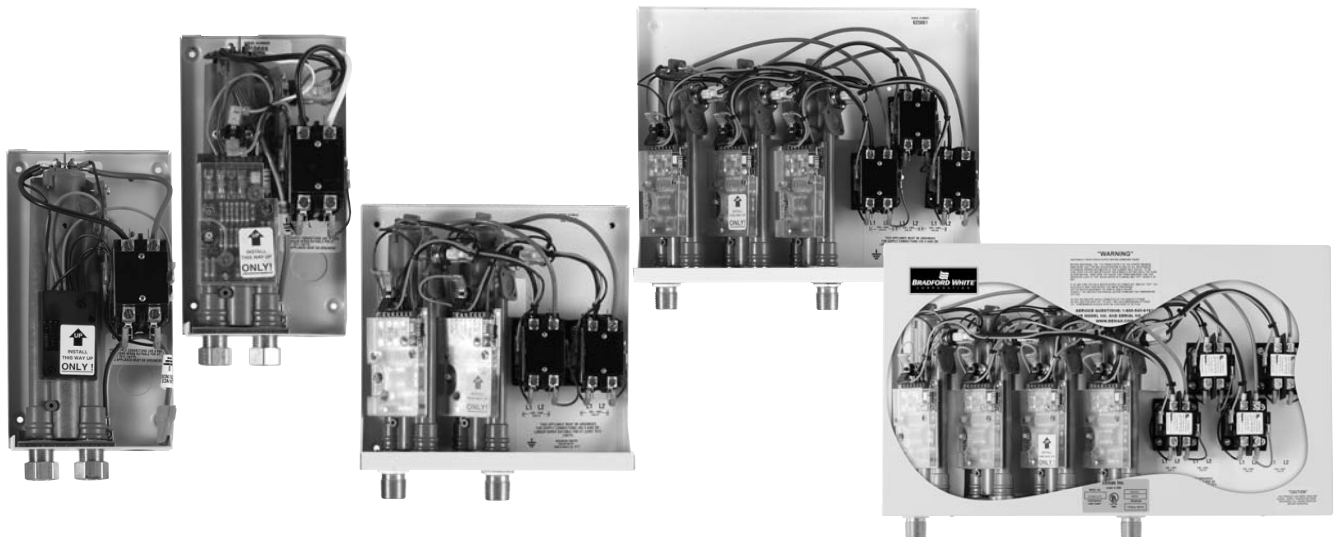

For more information on warranty, please visit www.bradfordwhite.com

For products installed in USA, Canada and Puerto Rico. Some states do not allow limitations on warranties. See complete copy of the warranty included with the heater.

Bradford White received the highest numerical score among water heater/boiler manufacturers in the proprietary J.D. Power and Associates/ McGraw-Hill Construction 2006 HVAC and Water Heater/Boiler Subcontractor Satisfaction Study™. Study based on 882 responses measuring 3 water heater/boiler manufacturers and measures opinions of subcontractors. Proprietary study results are based on experiences and perceptions of subcontractors surveyed in May through July 2006. Your experiences may vary. Visit jdpower.com

MANUFACTURED UNDER ONE OR MORE OF THE FOLLOWING U.S. PATENTS: 7,063,133 B2; 5,954,492; 5,954,492; 5,761,379; 5,943,984; 5,081,696; 5,988,117; 6,142,216; 5,199,385; 5,574,822; 5,372,185; 5,485,879; 5,277,171; (B1)5,341,770; 5,660,165; 5,596,952; 5,682,666; 4,904,428; 5,023,031; 5,000,893; 4,669,448; 4,829,983; 4,808,356; 5,115,767; 5,092,519; 5,052,346; 4,416,222; 4,628,184; 4,861,968; 4,672,919; Re. 34,534. OTHER U.S. AND FOREIGN PATENT APPLICATIONS PENDING. CURRENT CANADIAN PATENTS: 1,272,914; 1,280,043; 1,289,832; 2,045,862; 2,112,515; 2,108,186; 2,107,012; 2,092,105.

KwickShot® is a registered trademark of Bradford White® Corporation.

Electric Instantaneous Water Heaters



Single Point (Single Phase)

Integral 0.5 GPM flow control and faucet aerator provided.

Model Number	kW Rating	Voltage	AMPS	Temperature Rise °F 0.5 GPM	Recommended Wire Size
ES-3000-1-S-10	3.0	120	25.0	41	10 AWG
ES-3500-1-S-10	3.5	120	29.0	48	10 AWG
ES-3500-4-S-10	3.5	240	14.6	48	14 AWG
ES-4100-2-S-10	4.1	208	19.7	56	12 AWG
ES-4100-5-S-10	4.1	277	14.8	56	14 AWG
ES-5500-4-S-10	5.5	240	22.9	75	10 AWG

Note: Designed to comply with 0.5GPM handwashing code target outlet temperature 105°F - 110°F. Please consult local codes for electrical requirements. Additional voltages and wattages are available. For more information please consult factory.

Applications: Single Phase Only.
Shopping Malls, Schools, Stadiums, Public Hand Washing.

Refer to Voltage Identification Code Chart on page 5.

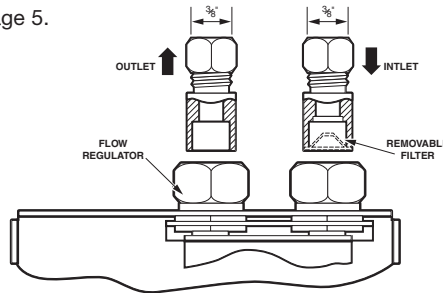

Specifications:
Dimensions: 10³/₄" x 5¹/₄" x 2¹/₈"
Weight: 3 lbs.
Materials:
 Cover: ABS UL rated 94Vo.
 Glass reinforced "UDELT"
 Heater Body and Ni Chrome Element
 Color: White
Element: Replaceable cartridge insert
Pipe-Fittings: 3/8" compression at top of unit.
Operating Pressure: Min 25 PSI,
 Max 150 PSI.

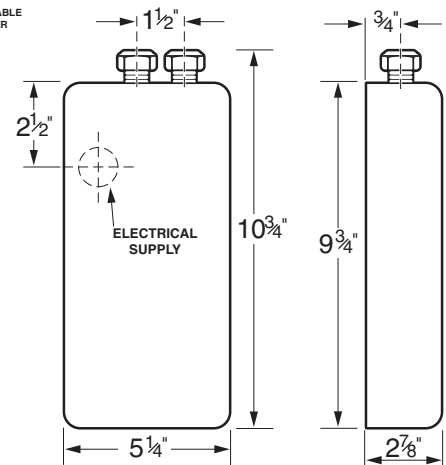

Thermostatic (Single Phase)

Turn on 0.5 GPM (up to 6.5kW)
 Turn on 0.7 GPM (7.5 kW and up)
 Max Flow 2.0 GPM

Model Number	kW Rating	Voltage	AMPS	Temperature Rise °F					Recommended Wire Size
				0.5 GPM	0.75 GPM	1.0 GPM	1.5 GPM	2.0 GPM	
EFT-7500-4-S-10	7.5	240	32.0	—	68	51	34	25	8 AWG
EFT-9500-4-S-10	9.5	240	40.0	—	86	65	43	32	8 AWG

Note: Designed to comply with 0.5GPM handwashing code target outlet temperature 105°F - 110°F. Please consult local codes for electrical requirements. Additional voltages and wattages are available. For more information please consult factory.

Refer to Voltage Identification Code Chart on page 5.

Applications: Single Phase Only.
 Dishwashers, Boosters (to 180°F). Schools, Hospitals, Nursing Homes, Laboratories. Emergency Eye Wash Fountains. Single and Multiple Handwash Stations.

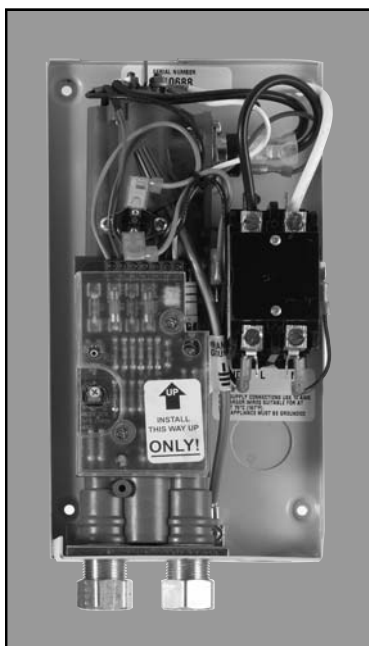

Please specify your application when you place your order.
 Example: EFT-9500-4-S-10-S (Dishwasher 180°F)

SPEC OPTIONS:
EE - Emergency Eyewash
S - Sanitation Setting 180°F
FS - Factory Set Temperature (Ambient to 180°F)
ML - Multiple Lavs (5.5 to 10kW)
 Factory Set Temp 105°F.
 .5 GPM Turn On

Specifications:
Dimensions: 10³/₄" x 5¹/₄" x 2¹/₈"
Weight: 3 lbs.
Materials:
 Cover: ABS UL rated 94Vo.
 Glass reinforced "UDELT" Heater Body and Ni Chrome Element
 Color: White
 Standard temperature range 100°F-140°F.
 Maintains accurate temperature control +/- 1°F
Element: Replaceable cartridge insert
Pipe-Fittings: 1/2" compression at bottom of unit.
Operating Pressure: Min 25 PSI, Max 150 PSI.

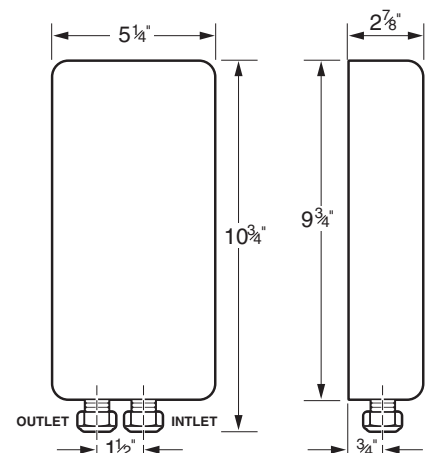

Electric Instantaneous Water Heaters



Flow Controlled (Single Phase)

Turn on 0.5 GPM (up to 6.5kW)
Turn on 0.7 GPM (7.5 kW and up)
Max Flow 2.0 GPM

Model Number	kW Rating	Voltage	AMPS	Temperature Rise °F					Recommended Wire Size
				0.5 GPM	0.75 GPM	1.0 GPM	1.5 GPM	2.0 GPM	
EFC-5500-4-S-10	5.5	240	23.0	75	50	38	25	18	10 AWG
EFC-6500-4-S-10	6.5	240	27.0	88	59	44	30	22	10 AWG
EFC-7500-4-S-10	7.5	240	32.0	—	68	51	34	25	8 AWG
EFC-9500-4-S-10	9.5	240	40.0	—	86	65	43	32	8 AWG
EFC-8300-2-S-10	8.3	208	39.0	—	76	57	38	29	8 AWG

Please consult local codes for electrical requirements. Additional voltages and wattages are available. For more information please consult factory.

Refer to Voltage Identification Code Chart on page 5.

Applications: Single Phase Only.
Kitchen Sinks, Bar Sinks, Dual Lav, Utility Sinks, Manufacturing Facilities, and Modular Buildings.



Please specify your application when you place your order.
Example: EFC-9500-4-S-10-DL (Dual Lav)

SPEC OPTIONS:

SL = Single Lav
DL = Double Lav

Specifications:

Dimensions: 10 $\frac{3}{4}$ " x 5 $\frac{1}{4}$ " x 2 $\frac{7}{8}$ "

Weight: 3 lbs.

Materials:

Cover: ABS UL rated 94Vo.
Glass reinforced "UDELT+" Heater Body and Ni Chrome Element

Color: White
Standard temperature range 100°F-140°F.

Element: Replaceable cartridge insert

Pipe-Fittings: 1/2" compression at bottom of unit.

Operating Pressure: Min 25 PSI, Max 150 PSI.

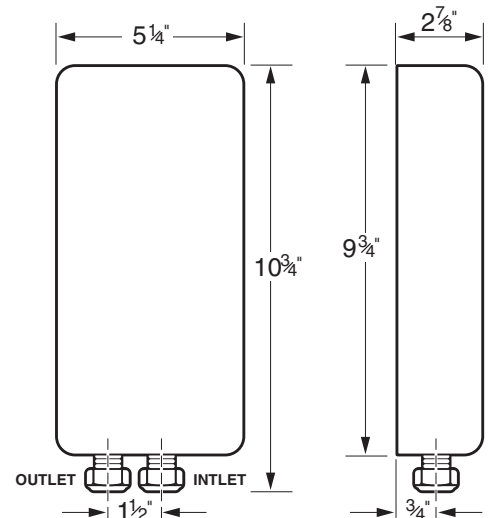

Series Two - Twin Heating Module (Single Phase)

(Twin Module) With Single Thermostatic Control

Activated in stages based on demand
Min. flow 0.7 GPM Max Flow 3.0 GPM

Model Number	kW Rating	Voltage	AMPS	Temperature Rise °F				Recommended Wire Size
				1.5 GPM	2.0 GPM	2.5 GPM	3.0 GPM	
EFT-19000-4-D-10	19.0	240	2 x 40 Amps	87	65	52	43	8 AWG per module

Please consult local codes for electrical requirements. Additional voltages and wattages are available. For more information please consult factory.

Refer to Voltage Identification Code Chart on page 5.

Applications: Single Phase Only.
Residential-Single Shower (Cabin or Condo), Multi Lav.

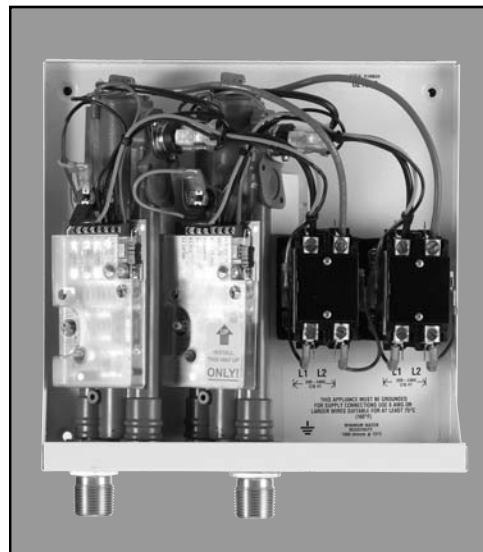

Please specify your application when you place your order.
Example: EFT-19000-4-D-10- T

SPEC OPTIONS:

Multi Lavs = ML 0.5 turn on set temp.
Set Temp = 105°F.

TC = Hot or Cold Water Feed

Specifications:

Dimensions: 10" x 9" x 3"

Weight: 8 lbs.

Materials:

Cover: Enameled Steel.
Glass reinforced "UDELT+" Heater Body and Ni Chrome Element

Color: White
Element: Dual replaceable cartridge inserts

Pipe-Fittings: 3/4" NPT pipe fittings at the bottom of the unit.

Operating Pressure: Min 25 PSI, Max 150 PSI.

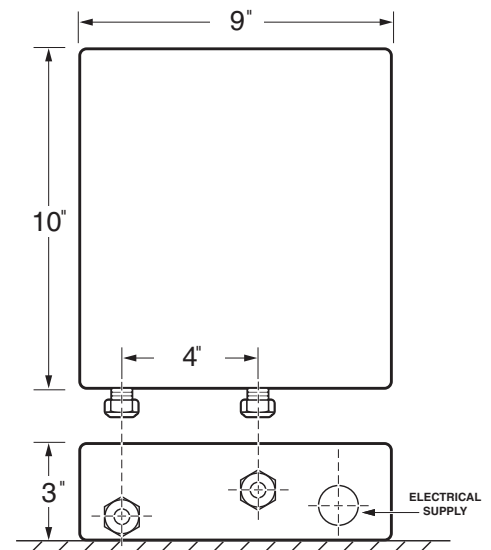

Electric Instantaneous Water Heaters



Series Three (Single Phase)

Min Flow 0.7 GPM
Max Flow 4.5 GPM

Model Number	kW Rating	Voltage	Current Per Phase	Temperature Rise °F					Recommended Wire Size
				1.5 GPM	2.0 GPM	2.5 GPM	3.0 GPM	4.0 GPM	
EFT-28000-4-T-10	28.0	240	3x40 Amps	—	—	—	65	50	8 AWG

This unit can only be ordered with 240V, but can be used on 208V with 25% reduced output (no model number change required).



Please specify your application when you place your order.
Example: EFT-28000-4-T-10-T2T (Hot or Cold Water Feed)

SPEC OPTIONS:
T2T = Hot or Cold Water Feed

Specifications:
Dimensions: 15¼" x 12¼" x 4¼"
Weight: 12 lbs.

Materials:
Cover: Enameled Steel.
Glass reinforced "UDEL†" Heater Body and Ni Chrome Element
Color: White
Element: Triple replaceable cartridge inserts
Pipe-Fittings: 3/4" NPT pipe fittings at the bottom of the unit.
Operating Pressure: Min 45 PSI, Max 150 PSI.

Please consult local codes for electrical requirements. Additional voltages and wattages are available. For more information please consult factory.

Refer to Voltage Identification Code Chart on page 5.

Applications: Single Phase Only.
Whole House Residential up to 4.5 GPM (Apartment, Condo, Cabin).

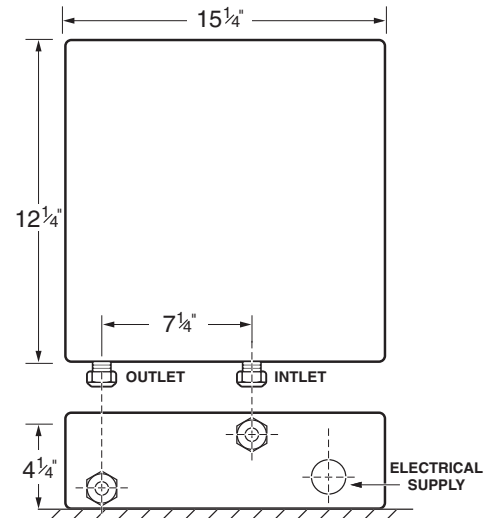

Series Four (Single Phase)

Min Flow 0.7 GPM
Max Flow 6.0 GPM

Model Number	kW Rating	Voltage	AMPS	Temperature Rise °F								Recommended Wire Size
				1.0 GPM	2.0 GPM	2.5 GPM	3.0 GPM	4.0 GPM	5.0 GPM	6.0 GPM		
EFT-38000-4-F-10	38.0	240	160 (4x40 Amps)	129.8	129.8	103.8	86.5	64.9	51.9	43.3	8 AWG	

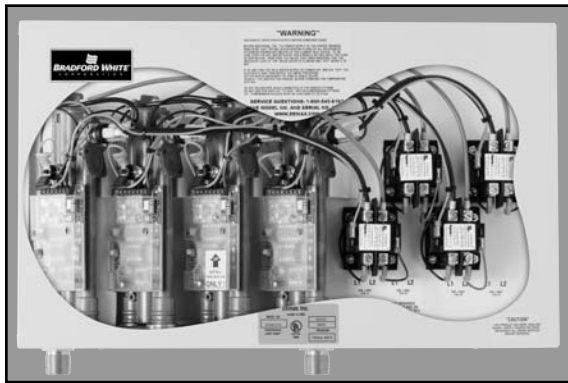

Please specify your application when you place your order.
Example: EFT-38000-4-F-10-T2T2 (Hot or Cold Water Feed)

SERIES FOUR SPEC OPTIONS:
T2T2 = Hot or Cold feed staged turn-on, min 0.7GPM max 6.0GPM

Please consult local codes for electrical requirements. Additional voltages and wattages are available. For more information please consult factory.

Refer to Voltage Identification Code Chart on page 5.

Applications: Single Phase Only.
Whole House Residential.
Multi Fixture up to 6GPM.

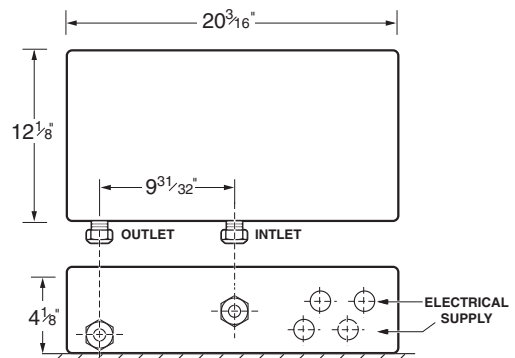

This unit can only be ordered with 240V, but can be used on 208V with 25% reduced output (no model number change required).

Specifications:
Dimensions: 20³/₁₆" x 12¹/₈" x 4¹/₈"
Weight: 23 lbs.
Materials:
Cover: Enameled Steel.
Glass reinforced "UDEL†" Heater Body and Ni Chrome Element

Color: White
Element: Four replaceable cartridge inserts
Pipe-Fittings: 3/4" NPT pipe fittings at the bottom of the unit.
Operating Pressure: Min 45 PSI, Max 150 PSI.

Electric Instantaneous Water Heaters



Thermostatic Triple Module Models (Three Phase)

Min Flow 0.7 GPM
Max Flow 4.0 GPM

Model Number	kW Rating	Voltage	AMPS	Temperature Rise °F						Recommended Wire Size
				1.5 GPM	2.0 GPM	2.5 GPM	3.0 GPM	3.5 GPM	4.0 GPM	
EFT-18000-2-T-10	18.0	208y/120v	50.0	82	61	49	41	35	32	10 AWG
EFT-24000-2-T-10	24.0	208y/120v	67.0	—	82	65	54	47	41	10 AWG
EFT-18000-6-T-10	18.0	480y/277v	21.7	82	61	49	41	35	32	10 AWG
EFT-24000-6-T-10	24.0	480y/277v	28.9	—	82	65	54	47	41	10 AWG
EFT-32000-6-T-10	32.0	480y/277v	38.5	—	—	87	73	62	55	8 AWG

Please consult local codes for electrical requirements. Additional voltages and wattages are available. For more information please consult factory.

Refer to Voltage Identification Code Chart and wiring diagram on page 5.

Multi-Outlet Three Phase Applications: Modular Hand Washing, Multi-Shower, Restaurants, Beauty Salons.

Please specify your application when you place your order.
Example: EFT-32000-6-T-10-S (Sanitation 180°F).



Please specify your application when you place your order.
Example:

EFT-24000-2-T-10-T2T
(Hot or Cold Water Feed)

SPEC OPTIONS:

- S = Sanitation 180°F
- ML = Multi-Lav temp setting 105 to 110 - 0.5 turn on up to 8 lavs
- T2T = Hot or Cold feed staged turn-on, max 4.0GPM
- FS = Factory Set (ambient to 180°F)

Specifications:

- Dimensions: 15 1/4" x 12 1/4" x 4 1/4"
- Weight: 15 lbs.
- Materials: Cover: Enameled Steel. Glass reinforced "UDELT" Heater Body and Ni Chrome Element
- Color: White
- Element: Triple replaceable cartridge inserts
- Pipe-Fittings: 1/2" compression at bottom of unit.
- Operating Pressure: Min 25 PSI, Max 150 PSI.

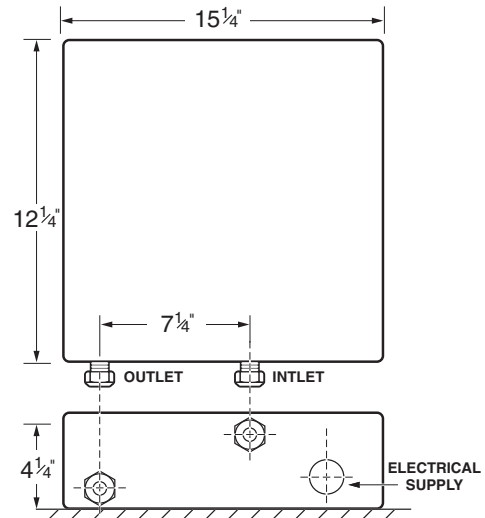

Voltage Identification Code For All Models

Voltage Code	1	2	3	4	5	6	7	8
Voltage	120	208	220	240	277	480	380	415

Example: ES-5500-4-S-10-S

The 4 in the model number indicates 240 volt.

Please be advised that the voltages listed in the Voltage Identification Code may not be available for all models.

Additional voltages and wattages are available. For more information please consult factory.

Electrical Configurations and Requirements for Bradford White Three Phase Tankless Water Heaters.

All Bradford White three-phase units are custom made to order and as such are, non-returnable and non-refundable. We urge you therefore to check your electrical supply, making sure all criteria for operating your Bradford White water heaters are met, especially that a neutral line is available for all 480/277 volt units.

Bradford White 208/120 Three Phase Units

Delta Configuration
Requires: 3 Lives, 1 Ground (earth)

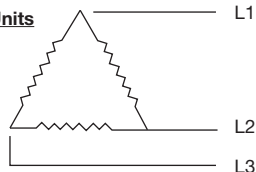

Three-Phase delta; Three-wire

Bradford White 480/277 Three Phase Units

Star Configuration
Requires: 3 Lives, 1 Neutral and 1 Ground

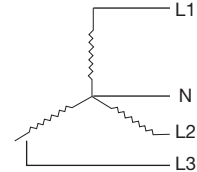

Three-Phase star; Four-wire; non-earthed neutral

Electric Instantaneous Water Heaters



Suggested Specification:

Instantaneous Water Heater shall be a Bradford White Model _____ with _____ kW, _____ vac _____ to heat _____ GPM @ a temperature rise of _____ degrees F. Unit shall have ABS UL 94 Vo rated cover. Heater body and element shall be glass reinforced UDEL. † Element shall be replaceable cartridge insert. Unit shall have a replaceable filter in the inlet connector. Element shall be iron free, nickel-chrome material. Heater shall be fitted with 1/2" compression nuts and sleeves to eliminate need for soldering. Maximum operating pressure of 150 psi. Hot water storage tanks prohibited. Unit shall be Bradford White or approved equal.

Note: All models are Single Phase except the Thermostatic Three Phase (3 Module) Models.
Kwickshot models are not recommended for Space Heating Applications.
No chemicals shall be added to the Kwickshot models: Potable Water Only.

U.S. Patent No.'s: 4,762,980 and 4,960,976
UL Patent #'s 4,762,980 and 4,960,976.
UL Listed: E197168



Typical Flow Rates in Gallons per Minute (gpm)							
Fixture Type	Lavatory	Bathtub	Shower	Kitchen Sink	Pantry Sink	Laundry Sink	Dishwasher
Flow Rates	0.5	2.0-4.0	1.5-4.0	1.0-1.5	1.5-2.5	2.5-3.0	1.0-3.0

FLOW CHART

POWER REQUIRED-KW

GPM	10	29.34kW	44kW	58.6kW	73.2kW						
	9	26.4kW	39.5kW	52.7kW	65.9kW	82kW					
	8	23.4kW	35.1kW	49.9kW	58.6kW	70.3kW	82kW				
	7	20.5kW	30.7kW	41kW	51.2kW	61.5kW	71.5kW	79kW			
	6	17.6kW	26.4kW	35.1kW	44kW	52.7kW	61.5kW	70.3kW	79kW		
	5	14.6kW	22kW	29kW	37kW	44kW	51.2kW	58.6kW	65.9kW	73.2kW	
	4	11.7kW	17.6kW	23.4kW	29kW	35.1kW	41kW	46.9kW	52.7kW	58.6kW	64.4kW
	3	8.8kW	13.0kW	17.6kW	22kW	26.4kW	30.7kW	35.1kW	39.5kW	44kW	48.3kW
	2	5.8kW	8.8kW	11.7kW	14.6kW	17.6kW	20.5kW	23.4kW	26.4kW	29.3kW	32.2kW
	1	3.0kW	4.4kW	5.8kW	7.3kW	8.8kW	10.2kW	11.7kW	13.0kW	14.6kW	16.1kW
	1/2	—	—	3.0kW	3.6kW	4.4kW	5.1kW	5.8kW	6.5kW	7.3kW	8kW

Temperature Rise - °F

FORMULAS

$$\text{Flow Rate, (GPM)} = \frac{\text{kW rating} \times 6.83}{\text{rise in temp. (°F)}}$$

$$\text{Rise in Temp. (°F)} = \frac{\text{kW rating} \times 6.83}{\text{rise in temp. (°F)}}$$

$$\text{kW Rating} = \frac{\text{GPM} \times \text{rise in temp.}}{6.83}$$



For U.S. and Canada field service, contact your professional installer or local Bradford White sales representative.

Sales 800-523-2931 • Fax 215-641-1670 / Technical Support 800-334-3393 • Fax 269-795-1089 • Warranty 800-531-2111 • Fax 269-795-1089
International: Telephone 215-641-9400 • Telefax 215-641-9750 / www.bradfordwhite.com

BRADFORD WHITE-CANADA INC. Sales / Technical Support 866-690-0961 / 905-238-0100 • Fax 905-238-0105 / www.bradfordwhite.com

Built to be the Best™

©2008, Bradford White Corporation. All rights reserved.

Free Manuals Download Website

<http://myh66.com>

<http://usermanuals.us>

<http://www.somanuals.com>

<http://www.4manuals.cc>

<http://www.manual-lib.com>

<http://www.404manual.com>

<http://www.luxmanual.com>

<http://aubethermostatmanual.com>

Golf course search by state

<http://golfingnear.com>

Email search by domain

<http://emailbydomain.com>

Auto manuals search

<http://auto.somanuals.com>

TV manuals search

<http://tv.somanuals.com>