

Brady

Bradyprinter Models 2461, 3481, and 6441

Operator's Manual

(TEMP COVER)
(DO NOT PRINT)

(DO NOT print this page)

(DO NOT print this page)

Copyright Information:

CG Triumvirate is a trademark of Agfa Corporation.

CG Times based upon Times New Roman under license from the Monotype Corporation.

Firmware (Software) Agreement

The enclosed Firmware (Software) resident in the Printer is owned by Licensor or its suppliers and is licensed for used only on a single printer in the user's Trade or Business. **The User agrees not to, and not to authorize or permit any other person or party to duplicate, or copy the Firmware or the information contained in the non-volatile or programmable memory.** The firmware (Software) is protected by applicable copyright laws and Licensor retains all rights not expressly granted. In no event will Licensor or its suppliers be liable for any damages or loss, including direct, incidental, economic, special, or consequential damages, arising out of the use or inability to use the Firmware (Software).

Information in this document is subject to change without notice and does not represent a commitment on the part of Brady Worldwide, Inc. No part of this manual may be reproduced or transmitted in any form or by any means, for any purpose other than the purchaser's personal use, without the expressed written permission Brady Worldwide Inc.

All rights reserved. Printed in the United States of America.

© Copyright 2000 by Brady Worldwide, Inc.

Part Number: 88-2241-21

Revision: C

Agency Compliance and Approvals:



UL1950 Information Technology Equipment
C22.2 No. 950-M93



EN60950

For 230 Volt Operation (Europe): Use a cord set, marked “HAR,” consisting of a min H05VV-F cord which has a minimum 0.75 square mm diameter conductors, provided with an IEC 320 receptacle and a male plug for the country of installation rated 6A, 250V

Für 230 Volt (Europa): Benützen Sie ein Kabel, das mit “HAR” markiert ist, bestehend mindestens aus einem H05VV-F Kabel, das mindestens 0,75 Quadratmillimeter Drahtdurchmesser hat; sowie eine IEC320 Steckdose und einen für das Land geeigneten Stecker, 6A, 250 Volt.



As an Energy Star Partner, the manufacturer has determined that this product meets the Energy Star guidelines for energy efficiency.



The manufacturer declares under sole responsibility that this product conforms to the following standards or other normative documents:

EMC: EN 55022 (1993) Class B
EN 50024 (1998)

Safety: This product complies with the requirements of
EN 60950/All:1997



Gost-R



Resolution S.I.C. & M., No. 799/99

FCC: This device complies with FCC CFR 47 Part 15 Class A.

Note: This equipment has been tested and found to comply with the limits for a Class A digital device, pursuant to Part 15 of the FCC Rules. These limits are designed to provide reasonable protection against harmful interference when the equipment is operated in a commercial environment. This equipment generates, uses, and can radiate radio frequency energy, and if not installed and used in accordance with the instructions in this manual, it may cause harmful interference to radio communications. Operation of this equipment in a residential area is likely to cause harmful interference in which case the user will be required to correct the interference at his own expense.

Important Safety Instructions:



The exclamation point within an equilateral triangle is intended to alert the user to the presence of important operating and maintenance instructions in the literature accompanying this unit.

This unit has been carefully designed to provide years of safe, reliable performance. However, as with all electrical equipment, there are some basic precautions that you follow to avoid personal injury or damage to the printer:

- Before using the printer, carefully read all the installation and operating instructions.
- Observe all warning instruction labels on the printer.
- Install the printer on a flat, firm surface.
- Do not place the printer on or near a heat source.
- To protect your printer from overheating, make sure no openings on the printer are blocked.
- Never insert anything into the ventilation slots and openings of the printer.
- Do not use the printer near water or spill liquid into it.
- Ensure that the AC power source matches the ratings listed for the printer. (If unsure, check with your dealer or local utility provider.)
- Do not place the AC power cord where it can be stepped on. If the AC power cord becomes damaged or frayed, replace it immediately.
- If the printer ever needs repair, consult only qualified, trained service personnel. No user-serviceable parts are inside; do not remove the cover.

Contents

Printer Overview

1.0	About the Printer	1
1.0.1	Standard Features	2
1.0.2	Optional Features	2
1.1	Option Installation	5
1.2	Hardware Components	6

Getting Started

2.0	Unpacking the Printer	7
2.0.1	Inspection	8
2.0.2	Additional Requirements	8
2.1	Media and Ribbon Selection	9
2.1.1	Print Quality Controls.....	9

Setting Up the Printer

3.0	Installation.....	11
3.0.1	Communications.....	12
3.1	Loading Media	14
3.1.1	Roll Media	15
3.1.2	Fan-Fold Media	16
3.2	Media Sensor Adjustment.....	17
3.3	Loading Ribbon.....	18
3.4	Quick Media Calibration.....	20
3.5	Outputting Labels.....	21
3.5.1	Rewinding.....	21
3.5.2	On-Demand Dispensing	23
3.5.3	Cutting	25

Using the Front Panel

4.0	Operation	27
4.0.1	Ready Mode: Normal Operation	27
4.0.2	Menu Mode: Configuration	28
4.0.3	Quick Test Mode: Print Test Labels.....	29
4.0.4	Indicator Lights	30
4.0.5	LCD	30
4.0.6	Resetting the Printer	31
4.0.6.1	Soft Reset	31
4.0.6.2	Level One Reset	31
4.0.6.3	Level Two Reset	31
4.1	The Menu System.....	32
4.1.1	Entrance and Exit Prompts	33
4.1.2	Media Settings.....	34
4.1.3	Print Control	35
4.1.4	Printer Options.....	37
4.1.5	System Settings.....	39
4.1.6	Communications.....	47
4.1.7	Diagnostics	53
4.2	Display Messages.....	54
4.2.1	User Prompts and Condition Messages	54
4.3	Quick Test Mode.....	56
4.3.1	Print Quality Label	56
4.3.2	Configuration Label	57
4.3.3	Quick Ribbon Test Label	58
4.3.4	Dot Test Pattern Label.....	59
4.3.5	Validation Label	60
4.3.6	User Defined Label.....	60

Maintenance and Adjustments

5.0	Media Sensor Calibration.....	61
5.0.1	Standard Calibration.....	61
5.0.2	Advanced Entry Calibration	65
5.1	Printhead Adjustments	71
5.1.1	Leveling Cam Adjustment.....	71
5.1.2	Burn Line Adjustment	72

- 5.2 Printhead Replacement73
- 5.3 Maintenance Schedule74
 - 5.3.1 Cleaning the Printhead75
 - 5.3.2 Cleaning the Platen Roller76
 - 5.3.3 Cleaning Interior and Exterior Surfaces77
- 5.4 Application Version Updates77
 - 5.4.1 Updating from Ready Mode78
 - 5.4.2 Updating from Download Mode79
 - 5.4.3 Possible Problems during an Update80
- 5.5 Boot Loader Program Updates81

Troubleshooting

- 6.0 Problem Resolution.....83
- 6.1 Fault and Warning Messages87
- 6.2 Hex Dump Mode93

Specifications

- 7.0 General Specifications95
- 7.1 Media and Ribbon Requirements.....97

Appendix A

- ASCII Control Code Chart.....99

Appendix B

- Available Fonts and Bar Codes.....101

Appendix C

- Module Assignments.....109
- Print Resolutions and Maximum Label Widths.....109
- Available Speeds and Default Settings110

Appendix D

GPIO Port Description111

Appendix E

Menu System Multi-Language Support.....113
Advance File Handling Information116

Appendix F

Saving a Configuration File119

Warranty Information121

Glossary125

Index129



Printer Overview

Section 1

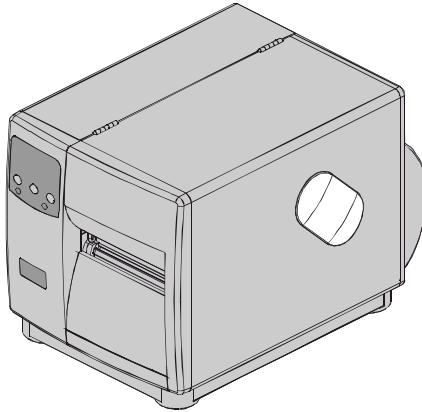

1.0 About the Printer

Congratulations on your purchase of a Bradyprinter Model 2461, 3481, and 6441 hereafter referred to as 'the printer', blends the rugged durability of die-cast construction with state-of-the-art electronics and user-friendly features to redefine the standard in industrial thermal printers.

This manual provides all the information necessary for everyday printer operation. To begin printing labels, refer to the instructions provided with the label-creation software you have chosen. If you wish to write custom label programs, a copy of the *Programmer's Manual* is included on the enclosed Accessories CD.

To grow with all of your printing needs, the design of the printer allows most upgrades to be performed easily by an operator; see Section 1.1. The following subsections detail the standard features, available options and a hardware overview.

1.0.1 Standard Features

This printer offers the following standard features:

Bradyprinter Standard Features Listing			
Feature	Model		
	2461	3481	6441
Printhead Density (Dots Per Inch)	203	300	600
Direct Thermal Printing	X	X	X
On-Demand and Batch Printing	X	X	X
Rotating Media Hub	X	X	X
Media Tear Bar	X	X	X
Fan-fold media capability	X	X	X
Flash memory	1MB	2MB	2MB
SDRAM	8MB	16MB	16MB
RS-232 interface port	X	X	X
IEEE 1284 Compliant parallel interface port	X	X	X
Liquid Crystal Display	X	X	X
EFIGS (multi-language display and configuration label support)	X	X	X
AGFA Scalable font engine	X	X	X

1.0.2 Optional Features (available except as noted)

The printer offers the following optional features:

Light-Duty (Backing-Only) Cutter

A rotary-type mechanism to automatically cut material with a maximum thickness of .005" (.127mm) into minimum lengths of 1.25 inches (31.8 mm).

Standard Cutter

A rotary-type mechanism to automatically cut material with a maximum thickness of .010" (.254mm) into minimum lengths of 1.25 inches (31.8 mm).

Cutter Tray

An adjustable tray that will collect and hold up to 200 cut labels or tags.

External Keyboard Support

An interface for the connection of the Passport™ keyboard.

External Media Rewinder

Separate device with an 8” roll capacity to rewind labels and backing material.

Font Expansion Card *(cannot be used with the I/O Expansion card)*

A slide-in circuit card assembly with 8MB Flash memory expansion for International Language Printing Capability (ILPC) and/or additional fonts and graphics. ILPC consists of one of the following:

- CG-Times™ (Western European) Scalable font
- Kanji Gothic B Scalable font
- Simplified Chinese GB Scalable font
- Korean Hangul Scalable font

Internal Media Rewinder

An internal hub with a six-inch outer diameter capacity to wind printed labels, or only backing material when a Peel and Present Mechanism is attached.

ILPC – CG Times™ Firmware

The printer’s firmware can be upgraded to include the ILPC CG Times™ font. This supports the Enhanced Language Code Pages.

I/O Expansion Card *(specify features at time of order)*

Standard features* of this slide-in circuit card assembly include:

- General purpose (GPIO) interface for external printer and device control.
- Time and date calendar (Real Time Clock) function for label time stamping.

Optional feature:

- 8 MB Flash memory expansion for graphics and/or additional fonts including International Language Printing Capability (ILPC).

LAN Interface

A slide-in circuit card assembly that provides for network connectivity, allowing multiple users on various platforms to share the same printer.

*Item unavailable for the 2461 model

Peel and Present Mechanism (requires the Internal Rewind option)

An output control device that automatically separates printed labels from the backing material and allows subsequent printing to occur only after the removal of a previously printed label. Minimum label length for peeling is 1.5 inches (38 mm).

Present Sensor

An output control device that allows subsequent printing to occur only after the removal of a previously printed label.

RS-422 Serial Interface*

Single-drop interface hardware to support greater distances from the host at communication rates of up to 38,400 baud.

Thermal Transfer (specify configuration at time of order)

A printing method that uses ribbon to produce exceptional image clarity, as compared to most direct thermal media types. This option must be specified for use with either 'coated side in' ribbon or 'coated side out' ribbon.

Twinax/Coax Interface

A slide-in circuit card assembly that provides connectivity to AS/400 and System/3X Twinax host system or 3270-type host system. Cable included.

*Item unavailable for the 2461 model.

1.1 Option Installation

The following table lists the available options and the recommended qualification level of the installer. For detailed information concerning a specific option, contact your dealer or Technical Support.

Suggested Experience Level for Option Installation	
Option	Qualified Installer
Cutter Tray	Operator
Cutters: Light and Standard Duty	Operator
Passport External Keyboard	Operator
Font Expansion Card	Certified Technician
Internal Rewind	Operator
I/O Expansion Card	Certified Technician
LAN Interface	Certified Technician
Peel and Present Mechanism	Operator
Present Sensor	Operator
RS-422 Serial Interface	Certified Technician
Thermal Transfer Assembly	Operator
Twinax/Coax Interface	Certified Technician

1.2 Hardware Components

The following drawing highlights the user-assessable components of the printer. Items denoted with an asterisk (*) are optional equipment.

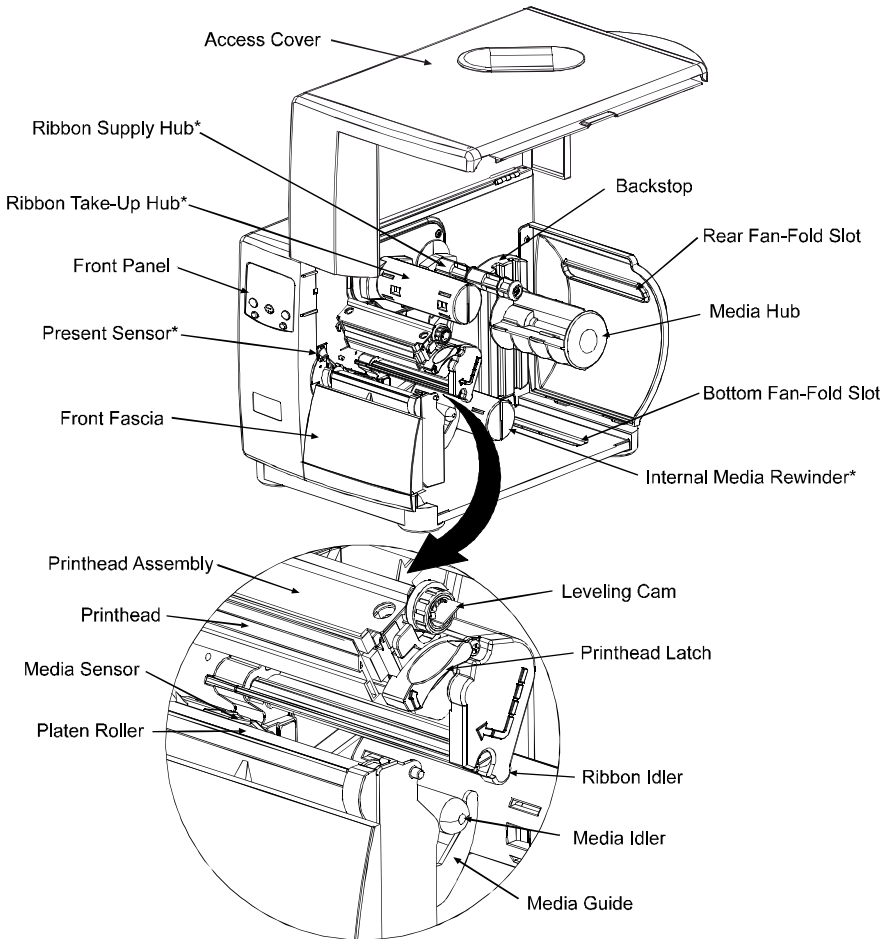



Getting Started

Section 2

2.0 Unpacking the Printer

Inspect the shipping container(s) for damage; if evident, immediately notify the shipping company to report the nature and extent of the damage.

The printer has been carefully packaged to avoid damage during transit. In order to operate the printer, you will need to remove the tape and foam placed there for shipment. Complete the following steps prior to connecting power or attempting to load media.

- 1 With the arrow on the box pointing up, open the box.

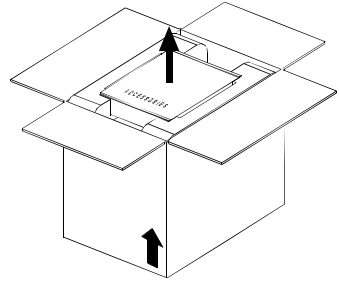

- 2 Remove Accessories Box.

- 3 Tilt the printer on its side and slide the printer out of its box.

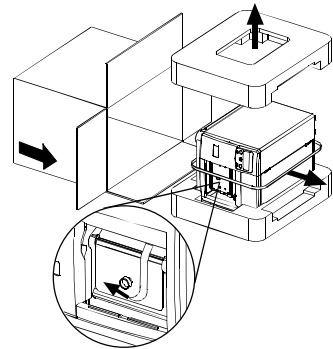

- 4 Place the printer in an upright position and remove the packing foam, plastic bag, and tape.

Note: It is a good idea to save the carton and packaging materials in the event that future shipment is required.

2.0.1 Inspection

After removing the printer from the packaging material, check the contents of the package. In addition to this manual, the following items should be included:

- Printer
- Power Cord
- Accessories CD
- Any special or additionally purchased items.

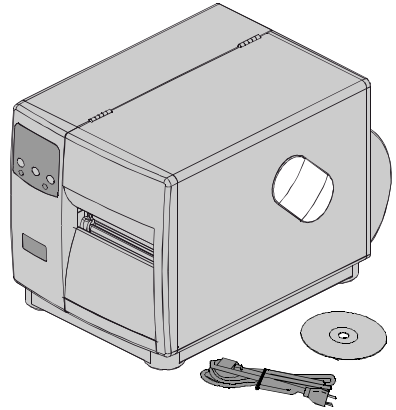

2.0.2 Additional Requirements

The following items are necessary to produce labels. Contact your dealer or a customer support representative for advice on which media and software may best suit your needs.

- A serial or parallel interface cable; see Section 3.0.1
- Applicable media; see Section 2.1 for suggestions and Section 7.1 for requirements.
- Applicable software

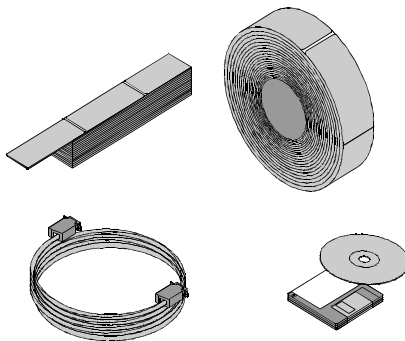

2.1 Media and Ribbon Selection

The following is a limited overview of media characteristics. For complete information and advice regarding your specific application needs, always consult a qualified media specialist or a Media Representative.

Media Selection – Direct Thermal

Consider three important factors when selecting direct thermal stock:

- The abrasive qualities of the material that covers the thermal reactive layer of the paper.
- The ability of that layer to control the chemical reaction that occurs when the image is “burned”.
- The amount of heat required to create an image on the paper.

Media Selection – Thermal Transfer

Consider three important factors when selecting thermal transfer media combinations:

- The label top coating and ribbon combinations affect image quality.
- Ribbon backcoating is highly recommended. It provides protection for the printhead, and may also provide an anti-static coating.
- For additional printhead protection, use ribbon with a slightly greater width than the overall width of the label and backing material.

2.1.1 Print Quality Controls

The printer provides flexibility with a comprehensive set of print controls. Of these, the amount of heat applied by the printhead and the rate of media movement will have the most effect on the barcodes, text, and graphics being printed. Low cost direct thermal stocks, for example, have raised reaction temperatures and therefore require higher heat values and slower print speeds to make a clear image on the media. In general, there are four methods of controlling print quality:

- The first is the ‘Media Type’ menu setting, which should be set to match the media being used. For example, when printing with ribbon use the thermal transfer setting.

- The second method would be to change the ‘Print Control / Heat’ menu setting (selectable as ‘Heat Setting’ in most software programs). Increasing this value causes more energy to be transferred to the media, resulting in a darker image. If the image is too dark, reduce this value or increase the print speed.
- The next method would be to change the ‘Print Control / Print Speed’ menu setting (also selectable as ‘Print Speed’ in most software programs). Changing the print speed changes the amount of time the media is under the printhead. Slowing the speed allows more time and control for energy to be transferred. Increasing the speed will increase throughput, but may require a higher heat setting.
- The final method, providing only subtle contrast changes, would be to change the ‘Custom Adjustments / Darkness’ menu setting.

You will find that printing barcodes and detailed images on less expensive direct thermal and thermal transfer media at higher speeds can be tricky. At one heat setting, the images will fade and at the next higher heat setting, the images will bleed. This is because the reaction temperature of the media is so high that at higher rates of speed, it cannot react fast enough. To print fine images at higher speed, media with lower reaction or release temperatures are required. On the slower end of the print rate settings, crisper images are possible because the media is not being stretched beyond its limits.

The following table is intended for reference only (for specific application information, consult your media specialist or a Media Representative).

Direct Thermal Media Type		Print Speed*	Print Energy		
Fasson 300 HD™ Direct Thermal Facesheet Fasson 300 MD™ Direct Thermal Facesheet		10-12**	Medium		
Thermal Transfer Media Type	Ribbon Type	Print Speed*	Print Energy	Image Durability	
Great Label TTL™	GPR Plus™ MaxWax™ IIMAK Versamark™	10-12**	Medium	Medium	
Coated Paper, Uncoated Paper, Tag Stock, Some Films, Some Synthetics	Wax	2 - 10	Low	Low	
Coated Paper, Glossy Paper, Tag Stock, Some Synthetics, Films	Wax/Resin	2 - 8	Medium	High	
Synthetics, Films	Resin	4 - 6	High	High	

*Values given in inches per second (IPS)

**Highly recommended for optimum print quality at speeds above 10 IPS.

3.0 Installation

This section explains how to connect the printer, and load it with media and ribbon.

Note: When connecting the AC Power Cord or interface cables to the printer, ensure the Power On/Off Switch is in the 'Off' position.

- ❶ Place the printer on a firm, level surface.
- ❷ Turn 'Off' the Host Computer and ensure that the Power Switch on the Printer is in the 'Off' position.
- ❸ Depending upon your interfacing requirements, connect the appropriate interface cable between Host Computer and Printer; see Section 3.0.1.
- ❹ Connect the AC Power Cord to the receptacle on the back of the Printer, and then plug the AC Power Cord into a properly grounded outlet. (The power supply in the printer automatically detects, then adjusts to the applied line voltage; see Section 7.0 for the acceptable voltage ranges.)

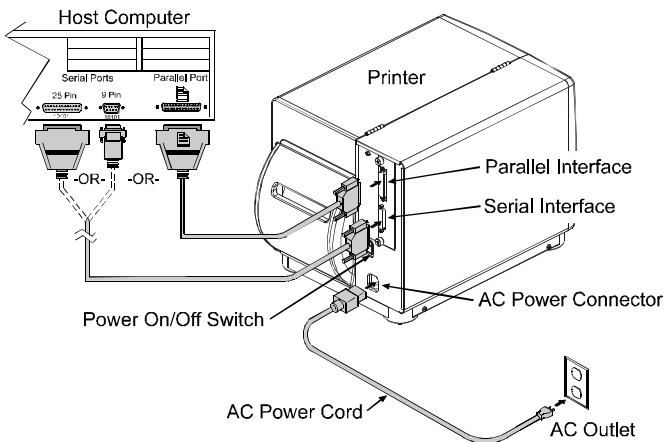

 If connecting the printer to a network, refer to the additional documentation supplied with the network option.

3.0.1 Communications

Using a data detection process, the interface selection occurs automatically in the printer. At power-up, the printer begins monitoring the interface ports for activity. When the host transmits data, the printer port detecting this data is set 'active' and remains active as long as data flow continues. Once the incoming (received) data flow stops and the Host Timeout Value (see Section 4.1.6) is exceeded, the detection process will be repeated. In addition, should the data flow stop before a complete label format is received, the format will be ignored and must be sent to the printer again.

☑ Note: To change an active port immediately, cycle the printer power 'Off' and 'On'.

Parallel Port:

The parallel interface has two menu-selectable modes of operation: uni-directional or bi-directional. Uni-directional mode is forward channel communication and requires a Centronics® cable with a 36 pin male connector. Bi-directional mode is IEEE 1284 Compliant, using forward and reverse channel communications. In this mode, data can be sent to the host provided it is also IEEE 1284 Compliant and has supporting software. This mode requires an IEEE 1284 cable with a Centronics® 36 pin male connector.

NIC Adapter (optional):

The NIC Adapter has several menu-selectable modes; see Section 4.1.6 for details. Refer to the information provided with the option for connection requirements. The following items are accessible from the back of the printer:

- The LED Indicators provide operational information: A green LINK LED indicates a good network connection. A green 100 LED indicates a 100BASE-T network connection. The ACT LED (activity) flashes green or red when the server is ready for use.
- The Test Button will cause a NIC Configuration label to print.
- The Ethernet Reset button will reset the NIC Adapter.

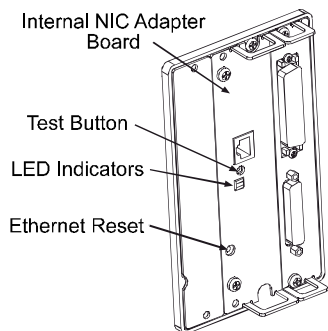

☑ Note: Following initialization, the printer will indicate 'Ready'; however, the NIC Adapter will not be ready to receive data until its 'boot-up' process is completed. Depending upon the NIC Adapter configuration, this process may take up to two minutes to complete.

Serial Port:

The serial interface supports RS-232C and, if equipped, RS-422 communications. The following list of serial port settings is menu-selectable and must match the host computer's serial port settings; see Section 4.1.6.

- Baud Rate (serial communication speed)
- Word Length
- Word Parity
- Number of Stop Bits
- Handshaking Protocol

In addition to the port settings, the serial interface cable wiring must have specific connections (pin-outs) for proper data exchange between the host and printer. The different serial cable pin-outs, suggested applications, and part numbers are shown below (contact your reseller for ordering information).

Serial Interface Cable Listing (all models, except as noted)	
<p style="text-align: center;">Null Modem (MXM)</p> <p style="text-align: center;">Part Number 556000</p> <p>For connection to other DCE equipment. Flow control is only Xon/Xoff.</p>	<p style="text-align: center;">“PC” (DB9P) to Printer</p> <p style="text-align: center;">Part Number 556001</p> <p>For connection to a PC compatible with DB9P communication ports. Flow control can be either Xon/Xoff or CTS/DTR.</p>
<p style="text-align: center;">“PC” (DB25P) to Printer</p> <p style="text-align: center;">Part Number 556002</p> <p>For connection to a PC compatible with DB25 communication ports. Flow control can be either Xon/Xoff or CTS/DTR.</p>	<p style="text-align: center;">RS-422 Connection*</p> <p style="text-align: center;">Part Number N/A</p> <p>Diagram provided only as a reference.</p> <p>*This optional interface is not available for the 2461 model.</p>

3.1 Loading Media

Begin loading as follows:

- ➊ Raise the Access Cover.
- ➋ Rotate the Printhead Latch forward and raise the Printhead Assembly.
- ➌ Slide the Media Guide out away from the frame and then lower it to the down position.
- ➍ If using roll media, the Media Hub can accept 3.0-inch (76mm) and 1.5-inch (38mm) cores. To use 1.5-inch cores, first slide off the 3 Inch Hub by grasping and then pulling it firmly outward.
- ➎ Proceed according to the type of media you are using: either go to Section 3.1.1 for Roll Media or go to Section 3.1.2 for Fan-Fold Media.

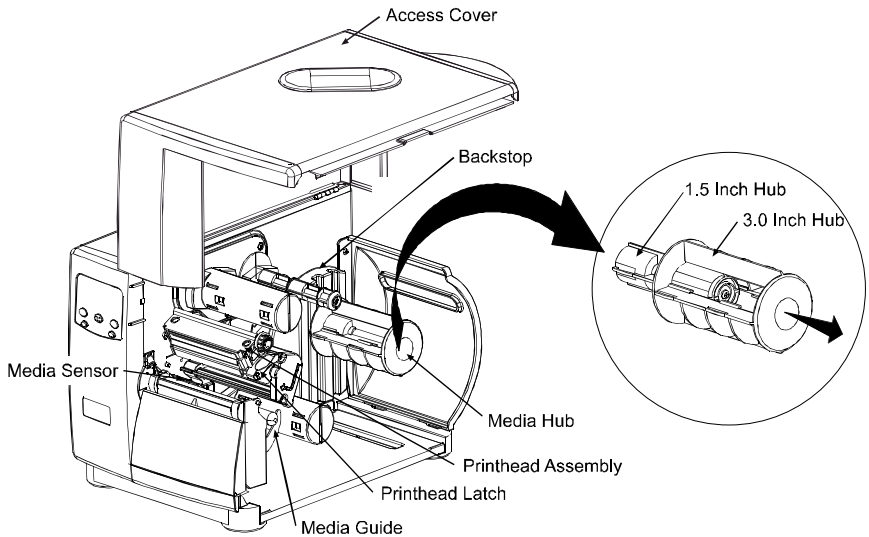

3.1.1 Roll Media

This loading method is roll type media applications. To load:

- ❶ Slide the Roll Media onto the Media Hub until it rests against the Backstop.
- ❷ Route the media as shown: under the Media Idler, through the Media Sensor, then out the front of the printer.
- ❸ Raise and slide the Media Guide over until it rests lightly against the edge of the media.
- ❹ Position the Media Sensor; see Section 3.2.
- ❺ If your application uses thermal transfer media, load ribbon (see Section 3.3); otherwise continue.
- ❻ Lower the Printhead Assembly and rotate the Printhead Latch completely back into the locked position. Close the Access Cover.

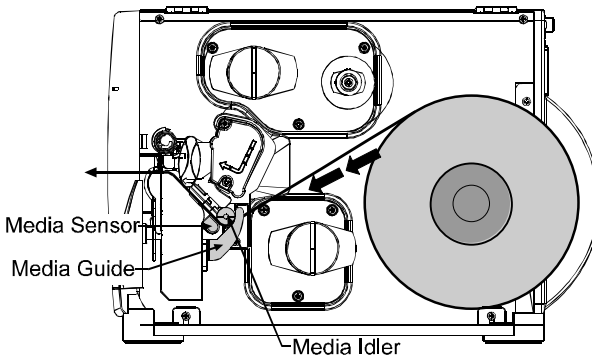
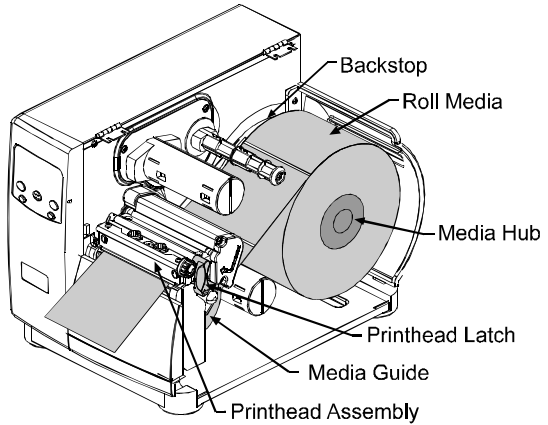

- ❼ Turn 'On' the printer. After 'Ready' is displayed, press and hold the FEED key until at least one label gap or mark is advanced; see Section 3.4.



If using less than full width media, adjust the Leveling Cam; see Section 5.1.1.

3.1.2 Fan-Fold Media

This loading method is for tag and fan-fold type media applications. To load:

- 1 Bring the media in through the Bottom or the Rear Media Slot. (If using reflective stock, ensure that the mark is facedown.)
- 2 Depending upon the entry point, route the media as shown: if through the Rear Media Slot, route the media over the Media Hub; or, if through the Bottom Media Slot, route the media over the Media Rewind Hub.
- 3 Continue routing the media under the Media Idler, through the Media Sensor and out the front of the printer.
- 4 Raise and slide the Media Guide over until it rests lightly against the edge of the media.
- 5 Position the Media Sensor; see Section 3.2.
- 6 If your application uses thermal transfer media, load ribbon (see Section 3.3); otherwise continue.
- 7 Lower the Printhead Assembly and rotate the Printhead Latch completely back into the locked position. Close the Access Cover.

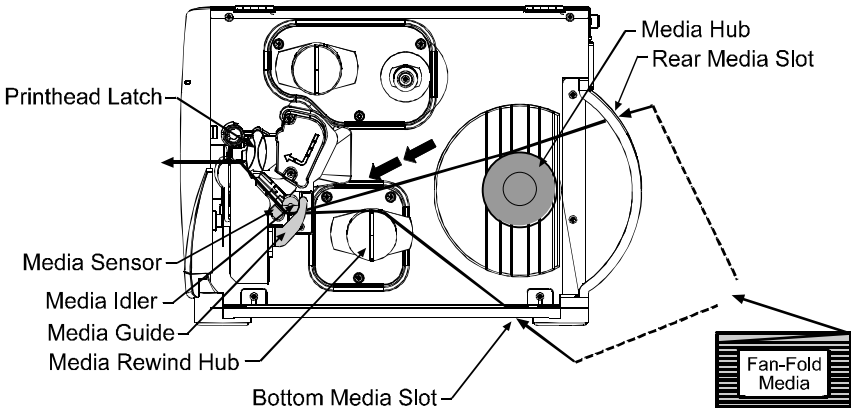

- 8 Turn 'On' the printer. After 'Ready' is displayed, press and hold the FEED key until at least one label gap or mark is advanced; see Section 3.4.



If using less than full width media, adjust the Leveling Cam; see Section 5.1.1.

3.2 Media Sensor Adjustment

The Media Sensor needs to be positioned so that the printer can detect the presence of media and the top-of-form (except for continuous stock, where the TOF is set through programming; see Label Length, Section 4.1.2). To adjust:

- 1 With media loaded, as described in Section 3.1.1 or 3.1.2, grasp the Slide Tab and move the Sensor Eye Mark into position over media according to the table below.
- 2 If loading media, return to the media loading instructions.

Media Sensor Selection and Adjustment		
Media Type	Sensor Eye Mark Position	Sensing Required*
Die-cut	Near the middle of the label	Gap
Notched	Centered over the notch	Gap
Reflective	Centered over the black mark	Reflective
Continuous	Near the middle of the media	Continuous

*See Section 4.1.2 for Sensor Type selection.

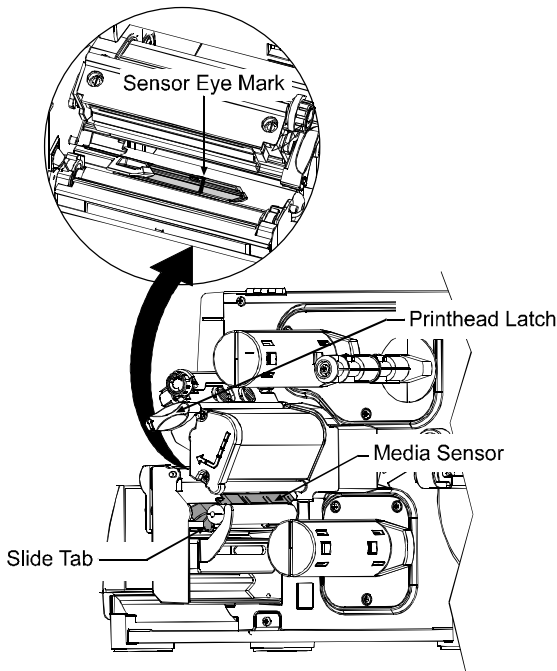

Note: Changes to the start of print position can be made using the Print Control/Row Adjust or Row Offset (see Section 4.1.3).

3.3 Loading Ribbon

Ribbon is required with thermal transfer media. Depending upon the type of Ribbon Supply Hub (see the next page for examples), the printer must use either ribbons with the 'coating side in' or ribbons with the 'coating side out'. To load:

Note: Using a ribbon that is slightly wider than your media (and liner, if any) will help protect against printhead wear.

- ❶ With the access cover raised and the printhead assembly up, position the ribbon to be dispensed in the direction appropriate for the Ribbon Supply Hub.
- ❷ Slide the ribbon onto the Ribbon Supply Hub until it rests against the hub's flange.
- ❸ Route the ribbon under the Ribbon Idler, out the front of the printer and then up around to the Ribbon Take-Up Hub, winding it several times in a clockwise direction to secure it in place.
- ❹ If loading media, return to the media loading instructions. Otherwise, lower the Printhead Assembly and rotate the Printhead Latch completely back into the locked position. Close the Access Cover.

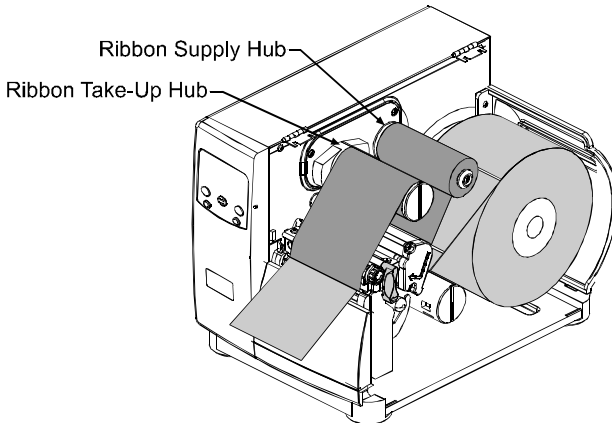

Removal:

When the supply is exhausted, pull the empty core from the Ribbon Supply Hub and discard it. To remove used ribbon: grasp the Ribbon Take-Up Hub, pull outward, then squeeze to collapse the hub and take off the ribbon.

☑ **Note:** Directional Arrows near the Ribbon Supply Hub indicate the correct ribbon route. Ribbon is available with the ink (coating) layer wound 'in' or 'out'. These types are not interchangeable for use with the printer.

Ribbon Routing Diagrams

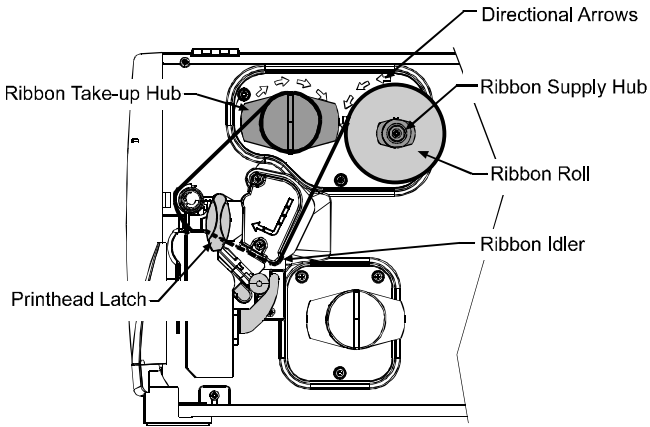

'Coating Side In' Ribbon Supply Hub

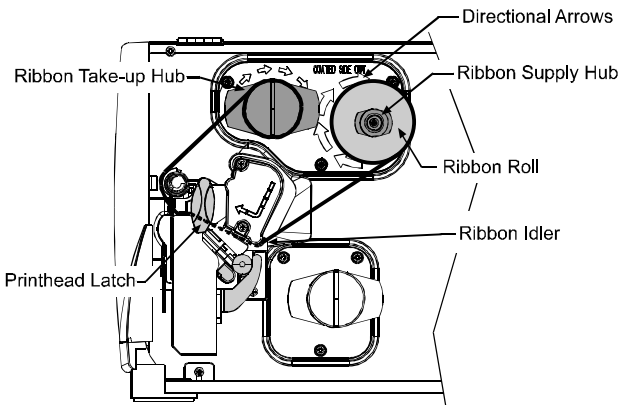

'Coating Side Out' Ribbon Supply Hub

3.4 Quick Media Calibration



When 'Uncalibrated' is displayed, follow the Media Sensor Calibration procedure in Section 5.0.

At the factory, the printer is calibrated to sense a wide range of media types. Quick Media Calibration fine-tunes the media sensor for your gap, notch or reflective media application (this is not required for continuous media). Perform this calibration during initial set-up or after changing your media type. To calibrate:

- 1 Ensure that media is loaded (see Section 3.1), that the Media Sensor is adjusted (see Section 3.2), and that the printer is idle.
- 2 Press and hold the FEED key. **The printer will begin advancing media; allow at least one label gap or mark to advance under the sensor during this process.**

Upon successful completion, the 'Calibration Completed' message will flash; the printer will feed to the next label TOF and 'Ready' will be displayed. (A 'Warning Low Backing' message may appear if using notched media or media on a transparent liner; however, the calibration was successful).

Note: Media containing large gaps may require a change in the 'Paper Out Distance' setting; see Section 4.1.2.

Calibration Hints:

In certain cases, the printer may have trouble differentiating between the label and liner. If the printer stops feeding in the middle of a label or if 'Cannot Calibrate' is displayed, try calibrating over a longer distance:

- Press and hold the FEED key to allow two gaps or marks to advance under the sensor.

If the printer continues to stop in the middle of a label, or if 'Cannot Calibrate' is displayed again:

- Press and hold the FEED key to allow three or more gaps or marks to advance under the sensor.

If this method also fails, see Media Sensor Calibration, Section 5.0.

3.5 Outputting Labels

In addition to directly outputting labels from the printer, there are several optional output configurations available.

3.5.1 Rewinding

With the Internal Media Rewinder option, the printer can wind the printed labels and backing material. To rewind labels:

Note: When winding labels, do not allow the outer diameter of the roll to exceed 6 inches (154 mm) on the Media Rewind Hub.

- 1 Remove the Front Fascia.

- 2 Remove the Tear Plate by first removing the Thumbscrew.

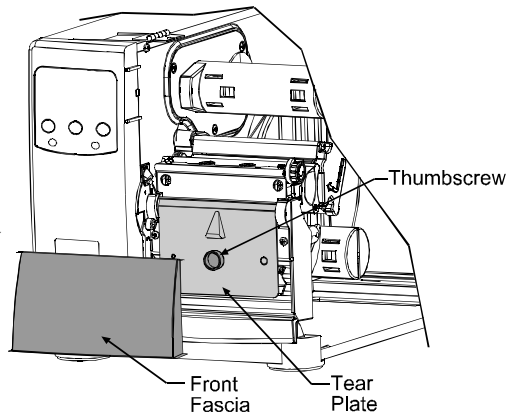

- 3 Position the Rewind Plate on the printer and install and tighten the Thumbscrew.

- 4 If installed, remove the Rewind Retainer and Media Clip from the Media Rewind Hub (see drawing next page).

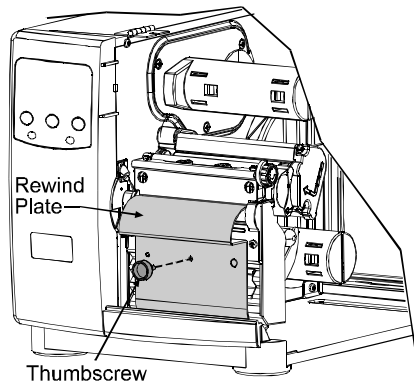

- 5 Load media as described in Section 3.1, press the FEED key and advance approximately 20 inches (51 cm) of media.

- ⑥ Route the media back to the Media Rewind Hub, as shown below.
- ⑦ Insert the leading edge into a Slot on the Media Rewind Hub then insert the Media Clip into a Slot to secure it in place.
- ⑧ Position the Rewind Retainer lightly against the edge of the media on the Media Rewind Hub. Tighten the Thumbscrew to secure the retainer in place.
- ⑨ Manually rotate the Media Rewind Hub to remove any slack in the media. Close the Access Cover.

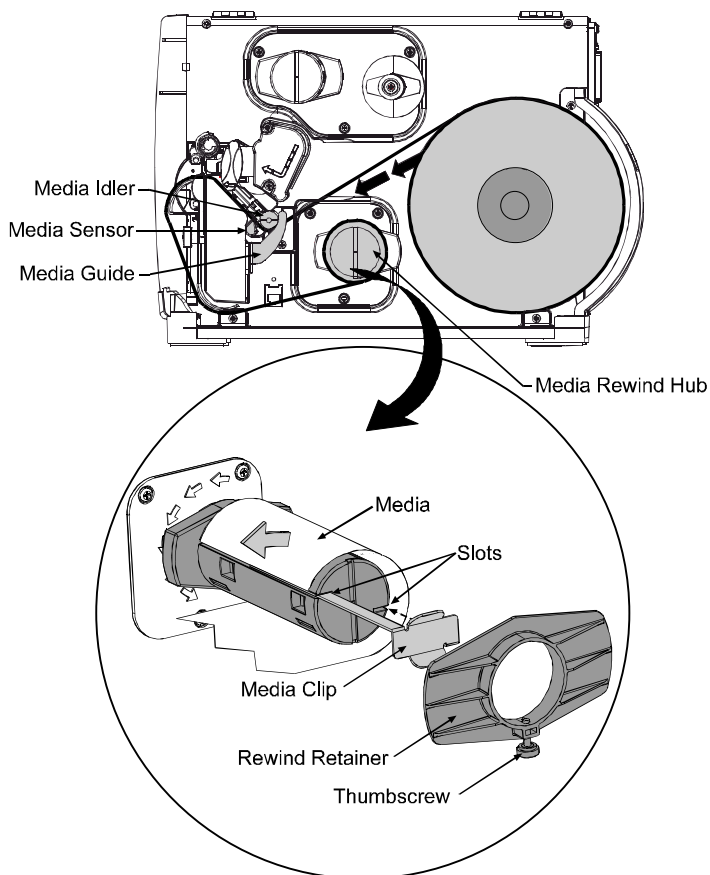

Removal:

Remove the Rewind Retainer and Media Clip. Grasp the end of the hub. While pulling outwardly, squeeze the hub together to collapse it and then slide off the labels.

3.5.2 On-Demand Dispensing

When equipped with the Peel and Present option, labels are dispensed from the printer one at a time, separated automatically from the liner for immediate application.

❶ With the Peel and Present Mechanism installed on the printer, pull outward on the Latch and allow the Roller Bracket to swing forward.

❷ With media loaded as described in Section 3.1, press the FEED key to advance approximately 20 inches (51 cm) of media. Remove all of the labels from the backing material.

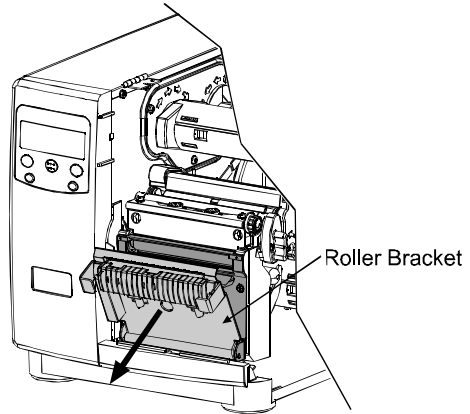

❸ Route the backing material through the Roller Bracket as shown (the backing should go under the top black roller, then out).

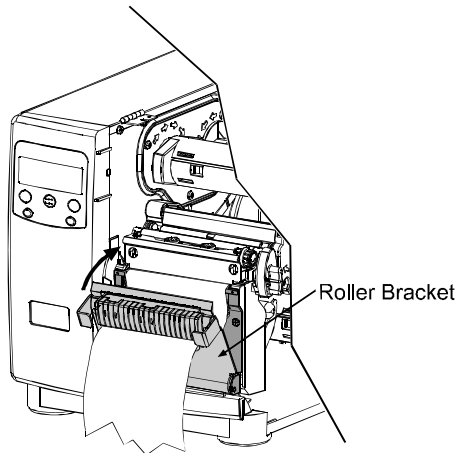

❹ Raise the Roller Bracket up to its latched position.

- 5 If installed, remove the Media Clip and the Rewind Retainer from the Media Rewind Hub. Route the Backing Material around the Media Rewind Hub, as shown.
- 6 Insert the leading edge into a Slot on the Media Rewind Hub then insert the Media Clip into a Slot to secure it in place.
- 7 Position the Rewind Retainer lightly against the edge of the backing on the Media Rewind Hub. Tighten the Thumbscrew to secure the retainer in place.
- 8 Manually rotate the Media Rewind Hub to remove any slack in the media. Close the Access Cover.

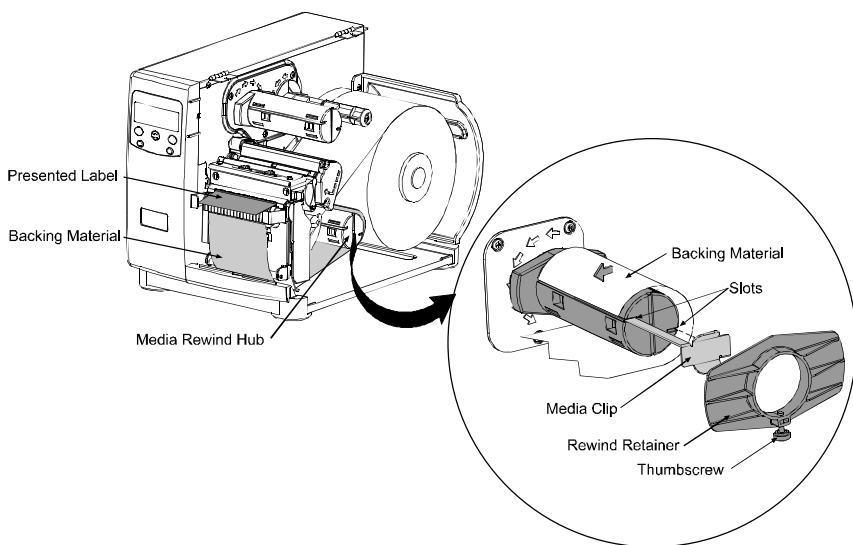

For on-demand printing, ensure that the Present Sensor has been enabled; see Section 4.1.4.

Removal:

Remove the Rewind Retainer and Media Clip. Grasp the hub. Pull the hub outward then squeeze to collapse it and slide off the backing material.

3.5.3 Cutting

When equipped with one of the cutter options, cut labels are dispensed from the printer.

- ❶ Ensure the leading edge of media is clean, straight and firmly attached to the liner.
- ❷ Load media according to Section 3.1, except route the media out through the Opening of the Cutter Assembly.

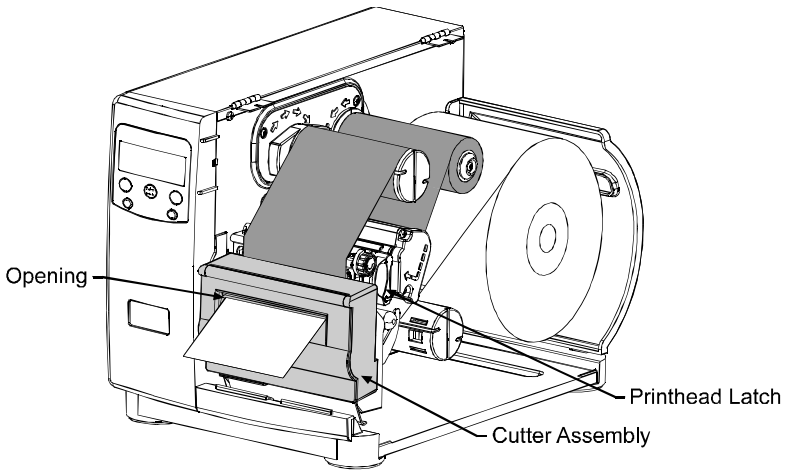

Ensure the Cutter has been enabled; see Section 4.1.4.



Using the Front Panel

Section 4

4.0 Operation

The front panel is comprised of three indicator lights, a Liquid Crystal Display and five mode-dependant keys. The selectable modes (Ready, Menu and Quick Test) and the related functions of the printer keys are detailed below.

4.0.1 Ready Mode: Normal Operation (Ready Light 'On')

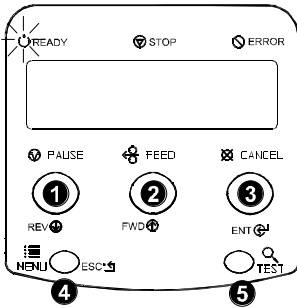

1 PAUSE

The PAUSE key temporarily suspends printing. Pressing again will return the printer to normal operation.

2 FEED

The FEED key advances one label, and clears any corrected faults.

Pressing and holding cause the printer to perform a Quick Media Calibration; see Section 3.4.

3 CANCEL

The CANCEL key 'pauses' the printer and then prompts you for confirmation. If yes, the current job is cancelled. The printer remains paused.

Pressing and holding four seconds will reset the printer and clear temporary host settings (soft reset).



4 MENU

The MENU key toggles between the Ready and Menu Modes. In the Ready Mode, pressing and holding four seconds will change the display contrast.

5 TEST

The TEST key enters (or exits) the Quick Test Menu.

4.0.2 Menu Mode: Configuration (Ready Light 'Flashing')

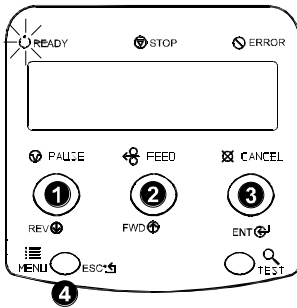

❶ REV ⬇️

The DOWN ARROW key scrolls to the previous menu item on the same menu level. It also decrements numerical values in most menu selections.

❷ FWD ⬆️

The UP ARROW key scrolls to the next menu item. It also increments numerical values in most menu selections.

❸ ENT ↵

The ENTER key selects the function, item or displayed value. It also moves between selections within multiple parameter fields.

❹ ESC ⬅️

The ESCAPE key moves to the previous menu level, and finally back to the Ready Mode.

4.0.3 Quick Test Mode: Print Test Labels

Note: The Quick Test Mode functions are disabled while processing data from communications interfaces until the Host Timeout value expires.

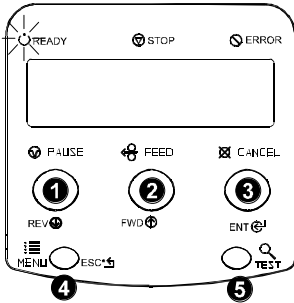

1 REV ⬇️

The DOWN ARROW key scrolls to the previous test function.

2 FWD ⬆️

The UP ARROW key scrolls to the next test function.

3 ENT ↶️

The ENTER key will change the selected test label quantity of 2, 100, 1000, or 9999 (except the 'Configuration Label', quantity of one). Holding down the key scrolls quantities.

4 ESC ⬅️

The ESCAPE key will exit the Quick Test Mode without printing.

5 🔍 TEST

The TEST key will print the selected test label at the selected quantity. During test label printing, this key also functions as a cancel key (the printer will prompt you for confirmation before cancellation occurs).



You can program a time delay between the printing of test labels using the 'Print Test Rate' feature; see Section 4.1.7.

4.0.4 Indicator Lights

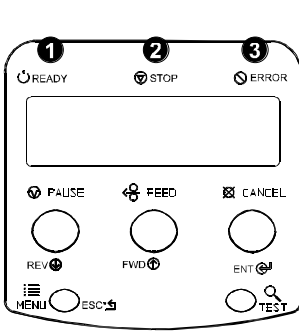

1 READY

'On' indicates that the printer is powered 'On' and, after initialization, it indicates the Ready Mode.

'Slow Flashing' indicates the Menu Mode.

'Fast Flashing' indicates data is being received and processed.

2 STOP

'On' indicates a 'Paused' condition.

3 ERROR

'Slow Flashing' indicates a *Warning*.

'Fast Flashing' indicates a *Fault*.

(For a list of these messages, see Section 6.1.)

4.0.5 LCD

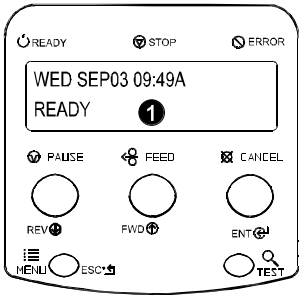

1 **Liquid Crystal Display**

The display provides several types of information:

- Following a brief power-up sequence (initialization), the 'Ready' message.
- The time and date, if the printer has received it from one of the following: the host, the front panel setting, or the Time and Date option.
- A label counter during a batch print job.
- The Menu System when in the Menu Mode.
- Any prompt, condition, downloading, warning, or fault message.

4.0.6 Resetting the Printer

Depending upon the method used, there are three reset levels possible:

4.0.6.1 Soft Reset

To reset the printer and clear any temporary host settings:

With the printer 'On', press and hold the CANCEL key for approximately four seconds.

4.0.6.2 Level One Reset

To return the printer to the factory default settings or, if saved, to restore the Factory Setting File:

- 1 Turn 'Off' the printer.
- 2 Press and hold the PAUSE and CANCEL keys while turning 'On' the printer; continue to depress the keys until the 'SYSTEM RESET' message flashes.

Note: This reset has the same effect as the System Settings/Set Factory Defaults selection in the menu system. (See Section 4.1 for a listing of the factory default settings and Section 4.1.5 for information about the Factory Setting File.)

4.0.6.3 Level Two Reset

To return the printer to the factory default settings, and clear all the calibration and adjustment parameters:

- 1 Turn 'Off' the printer.
- 2 Press and hold the PAUSE, FEED, and CANCEL keys while turning 'On' the printer; continue to depress the keys until the 'SYSTEM RESET' message flashes.

Note: After executing a Level 2 Reset, the media calibration must be performed; see Section 5.0. A listing of the factory default settings can be found in Section 4.1.

4.1 The Menu System

Printer operation can be controlled through the user interface, allowing the operator access to these six menu system branches:

- Media Settings
- Print Control
- Printer Options
- System Settings
- Communications
- Diagnostics

While in the menu system, the current selection will be indicated with the ‘*’ symbol next to the displayed item on the LCD, and selections designated with the ‘§’ symbol will require a printer reset before becoming effective. Changes made can be saved so that, in the event that power is lost or removed, the new settings will be retained. A reset will be automatically invoked when exiting the menu system and answering ‘Yes’ to the ‘Save Changes’ prompt.

The same functional commands from the host computer may, in some cases, override the printer’s menu settings. In addition, as a security feature for the prevention of accidental or unauthorized changes, the menu system has a password protection feature.

Note: In the following subsections, the factory default settings are denoted with the ‘✧’ symbol. Selections denoted with the ‘◆’ symbol can only be changed through the menu system - all other selections can be overridden by host software commands. Consult the *Programmer’s Manual* for specific information.

4.1.1 Entrance and Exit Prompts



With 'Ready' displayed on the LCD, press the MENU key to enter the Menu Mode.

Note: While in the Menu Mode, the printer will stop processing new DPL (or bitmapped) data.

MENU MODE	<i>Depending upon the configuration of the printer, the following Entrance and Exit Prompts may be displayed when accessing or leaving the Menu System.</i>
ENTER PASSWORD 0 0 0 0	<i>You are attempting to enter the Menu Mode. Security has been enabled and now the correct user-definable password is required for access the Menu Mode functions.</i>
KEEP HOST CHANGES? ENTER = YES	<i>You are now entering the Menu Mode. Existing Host commands have affected the configuration of the printer. Pressing ENTER will save these changes; otherwise, the printer will revert to previously saved settings.</i>
SAVE CHANGES? ENTER = YES	<p><i>You are now exiting the Menu Mode, but have made changes to the printer's settings. Pressing ENTER will reconfigure your printer according to these changes; otherwise, the printer will revert to previously saved settings.</i></p> <div style="border: 1px solid black; padding: 5px; margin-top: 10px;"> <p><input checked="" type="checkbox"/> Note: If changes have been made that require a reset, the printer will automatically invoke that reset.</p> </div>

4.1.2 Media Settings

MEDIA TYPE	<i>Selects the printing method.</i>
DIRECT THERMAL	<i>For use with heat sensitive media.</i>
◇THERMAL TRANSFER	<i>For use with media requiring a ribbon to create an image.</i>
SENSOR TYPE	<i>Selects the top-of-form (TOF) sensing method for the media.</i>
◇GAP	<i>The printer recognizes the TOF by sensing gaps in the media.</i>
CONTINUOUS	<i>No TOF sensing. The LABEL LENGTH setting determines the length.</i>
REFLECTIVE	<i>The printer recognizes the TOF by sensing reflective (black) marks on the media.</i>
LABEL LENGTH ◇04.00in (0-99.99)	<i>When the Sensor Type is set to Continuous, this value is used to determine the TOF.</i>
MAXIMUM LABEL LENGTH ◇16.00in (0-99.99)	<i>Sets the maximum length between TOF marks (gap or reflective). If this limit is exceeded, a top of form fault is declared.</i>
PAPER OUT DISTANCE ◇00.25in (0-99.99)	<i>Sets the length of travel before an Out of Stock condition is declared.</i>
LABEL WIDTH	<i>Sets the maximum limit for the printable surface width. Objects extending beyond this limit will not print; see Appendix C for the default values.</i>
SENSOR CALIBRATION ◆	<i>Adjusts the printer to sense your media.</i>
PERFORM CALIBRATION	<i>The user follows steps to allow the printer to calculate the empty, gap (or mark), and paper values to set the media sensor.</i>
ADVANCED ENTRY	<i>The user directly inputs the best values to adjust the media sensor.</i>
SENSOR LEVELS	<i>Sets threshold values for the media sensor parameters. Manual entry for paper, gap (or mark), and empty thresholds.</i>
SENSOR GAIN	<i>Observe A/D reading and set SENSOR GAIN. Adjusts the sensitivity of the sensor for custom label stock.</i>

4.1.3 Print Control



Refer to Section 2.1.1 for detailed information on print quality controls.

HEAT ◇10 (0-30)	<i>Controls the 'burn-time' of the printhead. This is the equivalent of Heat Setting on most label software programs.</i>
PRINT SPEED	<i>Controls the rate of label movement during the printing process; see Appendix C.</i>
FEED SPEED	<i>Controls the rate of label movement between printing areas; see Appendix C.</i>
REVERSE SPEED	<i>Controls the rate of label movement during backup positioning for start of print, cutting or present distance; see Appendix C.</i>
ROW OFFSET ◇00.00in (0-99.99)	<i>Shifts the vertical start of print position. This is the user setting for row adjustment.</i>
COLUMN OFFSET ◇00.00 in (0-99.99)	<i>Shifts the horizontal, left-justified start of print position to the right <u>without</u> shifting the Label Width termination point to the right. This is the user setting for Column Adjust.</i>
PRESENT DISTANCE ◇0.00 in (0-4.00)	<i>Sets the label stop position past the start of print. When the next label format is received, the printer will automatically backfeed to the start position. If a quantity of more than one label is printed without a present sensor enabled, or if the present distance is set to zero, the printer will operate without reversing.</i>

Print Control (continued)

CUSTOM ADJUSTMENTS ♦	<i>These factory adjustments independently change the listed parameters to finely tune the printer and compensate for slight mechanical differences sometimes evident when multiple printers share label formats. In addition, each of the following adjustments has no factory default setting and restoring factory defaults will NOT affect these settings.</i>
DARKNESS XX (1-64)	<i>Controls the printhead strobe time to fine-tune the HEAT setting.</i>
ROW ADJUST XXX DOTS (0-128)	<i>Shifts the vertical start of print position upward in dots to fine-tune the ROW OFFSET setting; see Appendix C.</i>
COLUMN ADJUST XXX DOTS (0-128)	<i>Shifts both the horizontal start of print position and the LABEL WIDTH termination point to the right in dots to fine-tune the COLUMN OFFSET setting; see Appendix C.</i>
PRESENT ADJUST XXX DOTS (0-128)	<i>Adjusts the label stopping position in dots to fine-tune the PRESENT DISTANCE setting; see Appendix C.</i>

4.1.4 Printer Options

MODULES	<i>Memory available for user storage of graphics, fonts and label formats. (The physical presence of the respective memory module must be detected to show the function selections for that module in the menu system.) See Appendix C for a listing of all possible modules.</i>
PRINT DIRECTORY	<i>Prints a label directory of selected, or of all available modules, the available space on these modules, the files present, and the type of module and files.</i>
PRINT FILE	<i>The user may select from a list of available files for sample printing.</i>
FORMAT MODULE	<i>The user may select from a list of available modules for formatting – all data will be erased.</i>
DELETE FILE	<i>The user may select from a list of available files for deleting (protected modules will not appear). Bytes will NOT be retrieved until the module that contained the deleted file is packed.</i>
PACK MODULE	<i>Packing the module removes files marked as deleted and defragments existing file structures to recover space.</i>
PRESENT SENSOR	<i>Used for on-demand label dispensing, where a printed label blocking the sensor will inhibit further printing until removed. (The physical presence of the Present Sensor must be detected to show the ENABLE/DISABLE selections.)</i>
ENABLED	<i>Enables the sensor for on-demand printing.</i>
◇DISABLED	<i>Disables the sensor.</i>
NOT INSTALLED	<i>No sensor is detected.</i>

Printer Options (continued)

CUTTER	<i>Used to cut media into separate labels. (The physical presence of a cutter must be detected to show the ENABLE/DISABLE selections.)</i>	
ENABLED	<i>Enables label cutting.</i>	
✧DISABLED	<i>Disables the cutter.</i>	
NOT INSTALLED	<i>No cutter is detected.</i>	
GPIO PORT	<i>Model dependant option used to interface the printer to an external controlling device (see Appendix D).</i>	
GPIO	<i>Input control signal is required to print a label.</i>	
ENABLED	<i>Enables external signal control.</i>	
✧DISABLED	<i>Disables the GPIO.</i>	
END OF PRINT	<i>Programmable signal output.</i>	
ACTIVE LOW		
ACTIVE HIGH		
LOW PULSE		
HIGH PULSE		

4.1.5 System Settings

CONFIGURATION FILE	<i>Options for storage and recall of printer configuration files. See Appendix F for details.</i>
RESTORE AS CURRENT	<i>Provides a list of available configuration files. Selecting a file from the list causes a printer reset; afterward, the printer is configured according to the activated file.</i>
SAVE SETTING AS	<i>Saves the entire effective configuration of the printer to a file. Unique names with up to nineteen characters are possible.</i>
DELETE FILE	<p><i>Provides a list of available configuration files. Files selected are immediately removed, freeing the module.</i></p> <div style="border: 1px solid black; padding: 5px;"> <input checked="" type="checkbox"/> Note: A currently activated file cannot be deleted. </div>
FACTORY SETTING FILE	<i>Provides a list of available configuration files. The selected file will be restored whenever a Level 1 reset is performed; see Section 4.0.6.2.</i>
INTERNAL MODULE ◇1024 KB	<i>Sets the number of 1K blocks allocated for the internal RAM 'D' module. Available memory dependent upon model; see Appendix C.</i>
DEFAULT MODULE ◇D	<i>Sets the default module used to store files when no other module is specified; see Appendix C.</i>
SCALEABLE FONT CACHE ◇312 KB	<i>Sets the number of 1K blocks allocated for the scaleable font engine. Available memory dependent upon model; see Appendix C.</i>
SINGLE BYTE SYMBOLS	<i>Selects the code page used to print single byte fonts unless otherwise specified in DPL.</i>
◇PC_850 MULTILINGUAL	<i>61 selectable sets are standard; see the Programmer's Manual for details.</i>

System Settings (continued)

DOUBLE BYTE SYMBOLS	<i>When equipped with the ILPC option, this selects the code page used to print double byte fonts unless otherwise specified in DPL; see the Programmer's Manual for details.</i>
JIS	<i>Japanese Industry Standard</i>
SHIFT JIS	<i>Shift Japanese Industry Standard</i>
EUC	<i>Extended UNIX Code</i>
◇UNICODE	<i>Unicode (including Korean)</i>
GB	<i>Government Bureau Industry Standard; Chinese (PRC)</i>
BIG 5	<i>Taiwan encoded</i>
TIME AND DATE	<i>Allows the user to set Time and Date.</i>
MEDIA COUNTERS	<i>Internal record of inches printed and time of use.</i>
ABSOLUTE COUNTER	<i>Shows the number of inches printed since being set at the factory. Not resettable by the user.</i>
RESETTABLE COUNTER	<i>The number of inches printed since the last reset. User may reset.</i>
RESET COUNTER	<i>Resets the resettable counters to zero.</i>
PRINT CONFIGURATION	<i>Prints the effective configuration of the system. In addition, if settings were changed that require a reset to become effective, this will be indicated with the '\$' symbol. A '•' symbol next to the printed item indicates that it was changed via the host but not saved in non-volatile memory.</i>

System Settings (continued)

CONFIGURATION LEVEL	<p>To upgrade the application program (resident software) version of the printer, the hardware and software compatibility levels must match for the update to be accepted. This information is displayed here; it is also printed on a configuration label.</p>
PRINTER KEY	<p>Each printer has a unique KEY number in the following form:</p> <p style="text-align: center;">vvvv-wwxx-yyyyyy-zzz</p> <p>Where:</p> <p>vvvv – represents the model number of the application loaded</p> <p>wwxx – represents the hardware / software feature level, where:</p> <p style="padding-left: 40px;">ww – represents the hardware feature level of the main board:</p> <p style="padding-left: 80px;">PA = PCB 51-2178-xx TB = PCB 51-2301-xx</p> <p style="padding-left: 40px;">xx – represents the software feature level:</p> <p style="padding-left: 80px;">10 = Standard DPL 11 = 2461 20 = Internal CG Times Font</p> <p>The printer will accept software feature levels up to the 'xx' value. (This feature level requires authorization to upgrade.)</p> <p>yyyyyy – is a manufacturing date code</p> <p style="padding-left: 40px;">zzz – is a unique time stamp</p>
UPGRADE PRINTER CODE	<p>This function is used to upgrade the software feature level of the printer, authorization is required.</p>

System Settings (continued)

SET FACTORY DEFAULTS	<i>Parameters in this menu listing with the '✧' symbol are the designated defaults.</i>
SET FACTORY DEFAULTS	<p><i>Overwrite the current settings with the factory default settings or, if selected, will restore the Factory Setting File.</i></p> <p><input checked="" type="checkbox"/> Note: <i>The reset will be automatic. If no Factory Setting File is used, all menu settings will be restored except CUSTOM ADJUSTMENTS, and the media and ribbon sensor calibrations.</i></p>
FORMAT ATTRIBUTES	<i>Affects the manner in which overlapping text and graphics are treated as the label is printed. Consult the Programmer's Manual for details.</i>
TRANSPARENT	<i>Intersecting text strings, images, and bar codes will not be printed. (An odd number of overlapping objects will print.)</i>
✧XOR	<i>Intersecting text strings, images, and bar codes print on top of one another.</i>
OPAQUE	<i>Intersecting text strings, images, and bar codes are obliterated by those formatted last. Each character cell is treated as opaque.</i>
IMAGING MODE ◆	<p><i>Instructs the printer whether to pre-image the label format.</i></p> <p><input checked="" type="checkbox"/> Note: <i>This selection can affect the accuracy of time-stamped labels and label throughput.</i></p>
✧MULTIPLE LABEL	<i>The printer images multiple labels as memory permits, achieving the fastest throughput; however, if time-stamping, the time will reflect the moment the label is imaged rather than when actually printed.</i>
SINGLE LABEL	<i>The printer images the next label only after the previous label has been successfully printed. Single processing provides time-stamps that are more accurate, but it slows label throughput time.</i>

System Settings (continued)

PAUSE MODE	<i>When enabled, Pause Mode suspends printing between each label until the PAUSE key is pressed.</i>
ENABLED	<i>Printer requires operator to press the PAUSE key after each label.</i>
◇DISABLED	<i>Printer completes label batch without pausing between labels.</i>
SECURITY ◆	<i>Provides the user with the ability to password protect all printer settings made through the operator panel.</i>
SELECT SECURITY	<i>Enable or disable the menu system's security feature.</i>
ENABLED	<i>Password protected.</i>
◇DISABLED	<i>No protection.</i>
MODIFY PASSWORD	<i>Modify the password required to access the menu system when security is enabled.</i>
UNITS OF MEASURE	<i>Selects the measurement system in which the system's settings are represented in the menu system and on configuration labels.</i>
METRIC	<i>Metric standard: Lengths in millimeters and Counters in centimeters.</i>
◇IMPERIAL	<i>Inch standard: Lengths and Counters given in inches.</i>

System Settings (continued)

Note: As indicated, the following menu selections will only appear according to the model of your printer.

PLUS EMULATION		<i>This instructs the firmware to process specific DPL data as would the Prodigy Plus® printer without all of the variations.</i>	2461 Model
ENABLED	<p><i>This list of exceptions will be updated with new firmware releases:</i></p> <ul style="list-style-type: none"> • <i>Data Terminator – I 2 of 5 Barcodes (IDs D, J, and L), the first non-numeric character processed will terminate the barcode data field.</i> • <i>Bar Size – I 2 of 5 Barcode (ID L), when the bar size is specified greater than P (25), the size is automatically decreased to 10.</i> • <i>Human Readable Fonts – The EAN and UPC barcodes (IDs B, C, F, G, M, and N) print a fixed font size.</i> • <i>The column position, bar code height, line width, and column offset commands are interpreted as 200 DPI calculations.</i> 		
◇DISABLED	<i>The above exceptions are disabled.</i>		
ALLEGRO EMULATION		<i>This instructs the firmware to process specific DPL data as would the Allegro® printer without all of the variations.</i>	
ENABLED	<i>The row position is calculated based on 194 DPI.</i>		
◇DISABLED	<i>The above exception is disabled.</i>		

System Settings (continued)

Note: As indicated, the following menu selections will only appear according to the model of your printer.

DPI EMULATION	<i>For users who want to print DPL files intended for a 203 or 300 DPI printer.</i>	<i>6441 Model</i>
◇DISABLED	<i>Label formats interpreted as intended for 600 DPI.</i>	
300 DOTS PER INCH	<i>Label formats interpreted as intended for 300 DPI.</i>	
203 DOTS PER INCH	<i>Label formats interpreted as intended for 203 DPI.</i>	

System Settings (continued)

SOP EMULATION	<i>Enables the <STX>O and <STX>f print positioning commands to allow backward compatibility with label formats designed for other printers. (When changing these values, the printer will automatically feed two labels to setup the new print position.)</i>
110 (PRODPLUS)	<i>Emulates the Prodigy Plus[®] printer.</i>
220 (ALLEGRO)	<i>Emulates the Allegro[®] printer.</i>
250 (PRODIGY)	<i>Emulates the Prodigy[™] printer.</i>
◇DISABLED	<i>No emulation, natural start of print position.</i>

BACK AFTER PRINT	<i>When the present distance is set with the cutter, present sensor or GPIO option enabled, this setting determines the timing of the label back up.</i>
ENABLED	<i>Commands the printer to immediately back up the label after the cut operation, the GPIO start of print signal is received, or the present sensor is clear. It provides the advantage of faster throughput.</i>
◇DISABLED	<i>The printer will not initiate repositioning until the next label is ready to print. May help prevent the curling of the label edge.</i>

MENU LANGUAGE ◆	<i>Selects the language in which the menu system messages and configuration label are shown. Only languages that are resident will be available.</i>
◇ENGLISH	<i>English</i>
FRENCH	<i>French</i>
ITALIAN	<i>Italian</i>
GERMAN	<i>German</i>
SPANISH	<i>Spanish</i>
USER DEFINED	<i>User defined, downloaded language(s).</i>

4.1.6 Communications

SERIAL PORT A♦	<i>Controls the communications settings for Serial Port A.</i>
BAUD RATE	<i>Determines the serial communication rate.</i>
38400	<i>38400 bits per second</i>
28800	<i>28800 bits per second</i>
19200	<i>19200 bits per second</i>
♦9600	<i>9600 bits per second</i>
4800	<i>4800 bits per second</i>
2400	<i>2400 bits per second</i>
1200	<i>1200 bits per second</i>
PROTOCOL	<i>Sets the data flow control (handshaking) method.</i>
♦BOTH	<i>Uses both handshaking methods.</i>
SOFTWARE	<i>XON/XOFF</i>
HARDWARE	<i>CTS/DTR</i>
NONE	<i>No flow control is used.</i>
PARITY	<i>Sets Word parity</i>
♦NONE	<i>No parity</i>
ODD	<i>Odd parity</i>
EVEN	<i>Even parity</i>
DATA BITS	<i>Sets Word length</i>
7	<i>Seven bit Word length</i>
♦8	<i>Eight bit Word length</i>
STOP BITS	<i>Sets the number of stop bits</i>
♦1	<i>One stop bit</i>
2	<i>Two stop bits</i>
SERIAL PORT B♦	<i>Same as Serial Port A, for an optional connection. If not present, this displays 'NOT INSTALLED' when accessed.</i>
PARALLEL PORT A♦	<i>Controls the communications settings for Parallel Port A.</i>
PORT DIRECTION	<i>Determines if messages are sent from the printer to the host via the parallel port.</i>
♦UNI-DIRECTIONAL	<i>One-way printer communication.</i>
BI-DIRECTIONAL	<i>Enables IEEE 1284 back-channel operation.</i>

Communications (continued)

PARALLEL PORT B ♦	<i>Same as Parallel Port A, for an optional Ethernet connection. If not present, this displays 'NOT INSTALLED' when accessed.</i>
--------------------------	---

Note: If the 'LOCKED' message appears when attempting to access the NIC ADAPTER menu, the printer may have active print requests or multiple users may be trying to access these parameters (for example, during simultaneous telenet sessions).

NIC ADAPTER ♦	<p><i>Network Interface Card Adapter (optional). If not present, this displays 'NOT INSTALLED' when accessed.</i></p> <p><i>NIC Adapter firmware version V3.6/5(010212) DM or later is required to support the described functionality.</i></p> <p><i>After making changes to these parameters, save the changes, exit the menu system, and cycle the printer's power 'Off' and 'On' for the changes to take effect.</i></p> <div style="border: 1px solid black; padding: 5px;"> <p><input checked="" type="checkbox"/> Note: With the NIC Adapter installed, a boot process (taking up to two minutes, depending upon the configuration) must be completed before the printer recognizes the option as 'installed'. During this time, the NIC Adapter will not be accessible or configurable; "NOT INSTALLED" will be indicated when in the menu system or on a Configuration Label. After the process, you will be able to configure the options provided using the menu system.</p> </div>
----------------------	---

IP ADDRESS	<i>The static IP address of the NIC Adapter. This is in standard dotted-decimal format.</i>
SUBNET MASK	<i>The static subnet assigned to the NIC Adapter.</i>
DEFALUT GATEWAY	<i>The network gateway address the NIC Adapter should use.</i>

Communications (continued)

PROTOCOL	<i>The network protocols recognized by the NIC Adapter.</i>	
IP	<i>This protocol is always supported.</i>	
LAT	<i>Local Area Transport is a DEC VMS network protocol that requires a LAT license number.</i>	
	✧ENABLED	<i>Protocol is enabled by default.</i>
	DISABLED	<i>Ignore LAT protocol. Select this option if LAT is not needed.</i>
MOP		
	✧ENABLED	<i>Enables the DEC MOP protocol.</i>
	DISABLED	<i>Ignore the MOP protocol. Select this option if MOP is not needed.</i>
APPLETALK		
	✧ENABLED	<i>The AppleTalk protocol is enabled by default.</i>
	DISABLED	<i>Ignore the AppleTalk protocol. Select this option if AppleTalk is not needed.</i>
NETWARE	<i>Allow the printer to be driven from an NDS Novell Print Queue.</i>	
	✧ENABLED	<i>Netware is enabled by default.</i>
	DISABLED	<i>Ignore the Netware protocol. Select this option if Netware is not needed.</i>
LAN MANAGER		
	✧ENABLED	<i>Enable DLC/LAN Manager protocol.</i>
	DISABLED	<i>Ignore LAN Manager protocol.</i>

Communications (continued)

DISCOVERY	<p><i>This is the address discovery method used by the NIC Adapter if a static address is not utilized. If no server for any of the discovery methods is found, the static value specified above is used.</i></p> <p><input checked="" type="checkbox"/> Note: For faster NIC Adapter boot times, disable any discovery methods not used.</p>
DHCP	<p><i>Dynamic Host Control Protocol. Automatically assign IP address from a DHCP Server.</i></p>
<p>◇ENABLED</p>	<p><i>DHCP is enabled by default.</i></p> <p>WARNING! An IP Address assigned by a DHCP has precedence over any static IP Address stored in the NIC Adapter.</p>
DISABLED	<p><i>Disable DHCP.</i></p> <p><input checked="" type="checkbox"/> Note: Select this option to insure any static IP stored is used by the NIC Adapter.</p>
BOOTP	<p><i>A UNIX based automatic IP address assignment controlled by a BOOTP server.</i></p>
◇ENABLED	<p><i>BOOTP is enabled by default.</i></p>
DISABLED	<p><i>Disable BOOTP.</i></p>
RARP	<p><i>Reverse Address Resolution Protocol.</i></p>
◇ENABLED	<p><i>RARP is enabled by default.</i></p>
DISABLED	<p><i>Disable RARP. This should be selected if RARP is not needed.</i></p>

Communications (continued)

HOST SETTINGS	<i>Settings which affect all communications with a host.</i>
HOST TIMEOUT \diamond 10 SEC (1-60)	<i>The number of seconds a communications port must be idle before the printer may process data from a different port. This value is also used to “timeout” an image / label format download.</i>
CONTROL CODES \blacklozenge	<i>Allows the operator to change the prefix of the software commands interpreted by the printer.</i>
\diamond STANDARD CODES	<i>Hex 01 = SOH command; Hex 02 = STX command; count-by = ^; Hex 1B = ESC; Hex 0x0D = Carriage Return</i>
ALTERNATE CODES	<i>Hex 5E = SOH command; Hex 7E = STX command; count-by = @; Hex 1B = ESC; Hex 0x0D = Carriage Return</i>
ALTERNATE CODES 2	<i>Hex 5E = SOH command; Hex 7E = STX command; count-by = @; Hex 1B = ESC; Hex 0x7C = Carriage Return</i>
ALTERNATE CODES 3	<i>Hex 5E = SOH command; Hex 23 = STX command; count-by = @; Hex 1B = ESC; Hex 0x0D = Carriage Return</i>
FEEDBACK CHARACTERS	<i>Returns a Hex 1E, [RS], after each label successfully prints, and a Hex 1F, [US], after each batch of labels is printed.</i>
ENABLED	<i>Feedback characters are sent to the host.</i>
\diamond DISABLED	<i>No feedback characters are sent.</i>
ESC SEQUENCES	<i>Allows data containing invalid ESC control code sequences to be processed.</i>
\diamond ENABLED	<i>Normal printer operating mode.</i>
DISABLED	<i>ESC sequences are ignored and the data is processed. Bitmapped font downloads are disabled in this mode.</i>

Communications (continued)

HEAT COMMAND	<i>Allows the user to disable the DPL Heat Command, providing compatibility with other printers.</i>
✧ENABLED	<i>Normal printer operating mode.</i>
DISABLED	<i>DPL Heat Commands are ignored. The heat value is controlled via the menu setting; see Print Control, Section 4.1.3.</i>
SPEED COMMANDS	<i>Allows the user to disable the DPL speed commands (Print, Feed, and Reverse).</i>
✧ENABLED	<i>Normal printer operating mode.</i>
DISABLED	<i>DPL speed commands are ignored. The print, feed and reverse speeds are controlled via the menu setting; see Print Control, Section 4.1.3.</i>

4.1.7 Diagnostics

HEX DUMP MODE	<i>Most commonly used for troubleshooting. Prints data and instructions received from the host rather than interpreting them as label formats; see Section 6.2.</i>
ENABLE	<i>Prints raw ASCII data received from the host rather than executing the commands.</i>
◇DISABLE	<i>Executes and prints label formats (normal operating mode).</i>
OPTIONS TESTING	<i>Tests currently installed options</i>
TEST PRESENT SENSOR	<i>Performs a functional test of the Present Sensor circuitry.</i>
TEST CUTTER	<i>Performs a functional test of the optional cutter mechanism and circuitry.</i>
PERFORM TEST 1 TIME	<i>The cutter will cycle 1, 10 or 100 times (selectable). The results of each attempt will be displayed.</i>
MONITOR GPIO INPUT	
TEST GPIO OUTPUTS	
PRINT TEST RATE (MIN) ◇0 (0-120)	<i>The number of minutes to delay between the printing of batches of labels in Quick Test Mode.</i>
SENSOR READINGS	<i>Analog Sensor readings are displayed.</i>
THR TRAN RIBM 24V → 255 255 255 255	<i>Live sensor values are displayed. View can be toggled with forward and reverse keys. Maximum values are shown in this example: thermistor sensor, transmissive (gap) media sensor (TRAN is replaced with REFL when the SENSOR TYPE is set to 'reflective'), ribbon sensor, 24 volt power supply sensor.</i>
← PS HD RANK 255 255 255	<i>Present sensor, head down sensor, printhead ranking resistor.</i>
RIBBON SENSOR LIMITS	<i>Displays ribbon sensor ADC low and high values used for motion detection.</i>
RIBBON ADC LOW HIGH 070 164	<i>Approximate default values are shown here (actual values will vary).</i>





4.2 Display Messages

The printer displays several different types of information (if not in the menu system or Quick Test Mode):





- User Prompts and Condition Messages (also see Section 4.1.1 for a listing of the Enter/Exit Prompts)
- Application and Boot Loader Updating Messages (see Section 5.4 and 5.5)
- Fault and Warning Messages (see Section 6.1)

4.2.1 User Prompts and Condition Messages

User Prompts alert the operator to a required action. Condition Messages are used to indicate an operational state.



User Prompts and Condition Messages		
Displayed Message	Description	Condition(s)
	The printer is trying to clear a fault condition.	Occurs when the FEED key is pressed after the correction of a fault.
	A media calibration is being performed.	The FEED key was pressed and held.
	The CANCEL or TEST key was pressed during a batch job.	The current print batch will be cancelled if ENTER is pressed; the remaining labels will not be printed.
	The printer is paused or offline.	The printer is in a paused condition.
	A label is awaiting removal.	The Present Sensor option is enabled and a label blocks the sensor. Remove the label to continue printing.

User Prompts and Condition Messages *(continued)*

Displayed Message	Description	Condition(s)
	Normal power-up and soft reset condition.	Follows the 'SYSTEM RESET IN PROGRESS' message after a reset or power-up.
	Normal power-up and soft reset condition.	Occurs when the user resets the printer via the host or Front Panel.
	The media calibration is not set.	Perform calibration; see Section 5.0.
	The print job is being processed.	Batch status indication, updated with each label printed.





4.3 Quick Test Mode

This section explains the functions of the resident Quick Tests, accessible by pressing the  **TEST** key on the Front Panel.

- ☑ **Notes:** (1) With the exception of the Configuration Label, all Quick Test labels require 4-inch (102mm) wide media to print the entire format. If using narrower media, change the Label Width setting (Section 4.1.2) to match your media's width to avoid printing on the platen.
- (2) During any Quick Test, press the **ESC**  key or the  **TEST** key to stop printing.
- (3) Using the 'Print Test Rate' feature (Section 4.1.7), a time delay can be set for printing labels in Quick Test Mode.

4.3.1 Print Quality Label

The Print Quality Label provides an indication of overall print quality at a pre-selected heat and speed setting. This format consists of compliant bar codes in fence and ladder orientations, assorted font sizes, and graphic fill patterns. These can be used to ensure conformance, as well as aesthetics. To print a Print Quality Label:

- 1 Press the  **TEST** key.
- 2 Use the **FWD**  key to scroll to 'Print Quality Label'.
- 3 Use the **ENT**  key to select a quantity; see Section 4.0.3.
- 4 Press the  **TEST** key to start printing.





4.3.2 Configuration Label

The Configuration Label provides valuable printer database information, as detailed in Section 4.1.

Note: The Configuration Label content can vary with the application version and printer model. To print all information, the media cannot be less than 2 inches wide (51mm) and the Label Width setting must match the width of the media being used (see Section 4.1.2).





To print a Configuration Label:

- 1 Press the  **TEST** key.
- 2 Use the **FWD**  key to scroll to 'Print Configuration'.
- 3 Press the  **TEST** key to start printing.

<p>CONFIGURATION WED 07:09 AM 12MAR2001 PRINTER KEY: 4306-TB10-000219-977 APPLICATION VERSION: 63-2294-06A 05.01 03/15/2001 BOOT LOADER: 63-2265-02J 02.00 02/09/2000</p> <p>SYSTEM INFORMATION PRINT BUFFER SIZE: 278 in. FLASH SIZE: 2 MB RAM TEST: PASS OPTIONAL LANGUAGES: FRANCAIS ITALIANO DEUTSCH ESPANOL CONFIGURATION FILE: NONE</p> <p>MEDIA SETTINGS MEDIA TYPE THERMAL TRANSFER SENSOR TYPE GAP SENSOR TYPE GAP LABEL LENGTH 04.00 in. MAXIMUM LABEL LENGTH 16.00 in. PAPER OUT DISTANCE 00.25 in. LABEL WIDTH 4.16 in. SENSOR CALIBRATION PAPER SENSOR LEVEL 172 GAP SENSOR LEVEL 44 EMPTY SENSOR LEVEL 12 SENSOR GAIN 13</p> <p>PRINT CONTROL HEAT 10 PRINT SPEED 6.0 in/sec FEED SPEED 6.0 in/sec REVERSE SPEED 4.0 in/sec ROW OFFSET 00.00 in. COLUMN OFFSET 00.00 in. PRESENT DISTANCE 0.40 in. CUSTOM ADJUSTMENTS: DARKNESS 32 ROW ADJUST 64 DOTS COLUMN ADJUST 0 DOTS PRESENT ADJUST 64 DOTS</p> <p>PRINTER OPTIONS MODULES A: NOT INSTALLED B: NOT INSTALLED D: FORMATTED F: NOT INSTALLED G: NOT INSTALLED X: NOT INSTALLED Y: FORMATTED Z: NOT INSTALLED PRESENT SENSOR NOT INSTALLED CUTTER NOT INSTALLED GPIO NOT INSTALLED</p>	<p>SYSTEM SETTINGS FACTORY SETTING FILE NONE INTERNAL MODULE 1024 KB DEFAULT MODULE D SCALABEL FONT CACHE 312 KB SINGLE BYTE SYMBOLS PC-850 MULTILINGUAL DOUBLE BYTE SYMBOLS UNICODE ABSOLUTE COUNTER 100035 in. 01JUL2000 RESETTABLE COUNTER 536 in. 01SEP12000 FORMAT ATTRIBUTES XOR IMAGING MODE MULTIPLE LABEL PAUSE MODE DISABLED SELECT SECURITY DISABLED UNITS OF MEASURE IMPERIAL SOP EMULATION DISABLED BACK AFTER PRINT DISABLED MENU LANGUAGE ENGLISH</p> <p>COMMUNICATIONS SERIAL PORT A: BAUD RATE 9600 BPS PROTOCOL BOTH PARITY NONE DATA BITS 8 STOP BITS 1 SERIAL PORT B: NOT INSTALLED PARALLEL PORT A: PORT DIRECTION UNIDIRECTIONAL PARALLEL PORT B: NOT INSTALLED NIC ADAPTER NOT INSTALLED HOST SETTINGS: HOST TIMEOUT 10 SEC CONTROL CODES STANDARD CODES FEEDBACK CHARACTERS DISABLED ESC SEQUENCES ENABLED HEAT COMMAND ENABLED SPEED COMMANDS ENABLED</p> <p>DIAGNOSTICS HEX DUMP MODE DISABLED PRINT TEST RATE (min) 0 SENSOR READINGS THR TRAN RISE 24/ 138 183 070 172 PS HD RANK 007 192 178 RIBBON SENSOR LIMITS RIBBON ADC LOW 070 RIBBON ADC HIGH 104</p>
---	---

4.3.3 Quick Ribbon Test Label



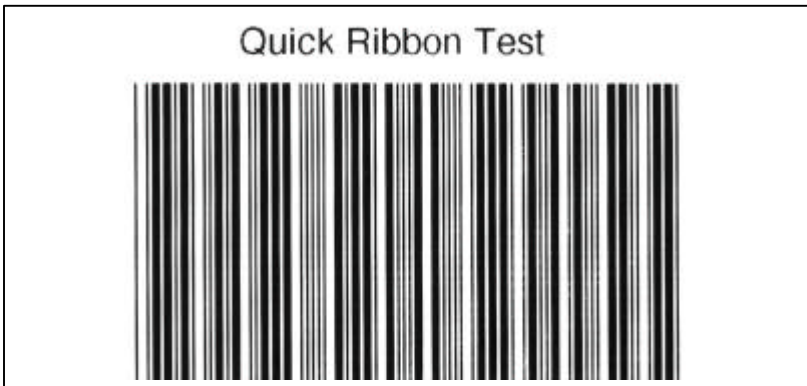

The Quick Ribbon Test Label features a compliant picket-fence bar code that can be used to verify thermal transfer and print quality functions. To print a Quick Ribbon Test Label:

- 1 Press the  **TEST** key.
- 2 Use the **FWD**  key to scroll to 'Ribbon Test Label'.
- 3 Use the **ENT**  key to select a quantity; see Section 4.0.3.
- 4 Press the  **TEST** key to start printing.



4.3.4 Dot Test Pattern Label

The Dot Test Pattern Label features patterns that exercise all of the thermal elements (dots) of the printhead. The resulting label (see examples below) can be an indication of the printhead's condition. To print a Dot Test Pattern Label:

- 1 Press the  **TEST** key.
- 2 Use the **FWD**  key to scroll to 'Dot Test Pattern'.
- 3 Use the **ENT**  key to select a quantity; see Section 4.0.3.
- 4 Press the  **TEST** key to start printing.

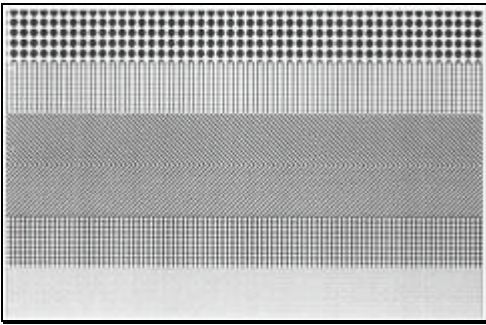

Good Test Pattern Label:

Even pattern consistency indicates correct printhead is operation.

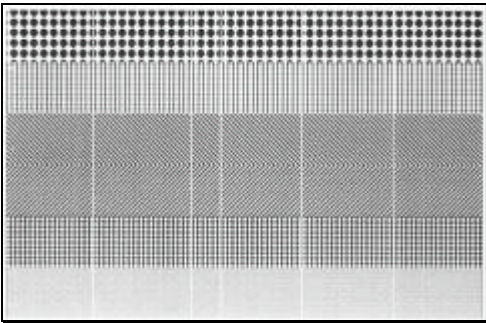





Faulty Test Pattern Label:

Streaks indicate a dirty or faulty printhead. See Section 5.3.1 for cleaning instructions.

4.3.5 Validation Label

The Validation Label is another useful tool for evaluating overall print quality. To generate a Validation Label:

- 1 Press the  TEST key.
- 2 Use the FWD  key to scroll to 'Validation Label'.
- 3 Use the ENT  key to select a quantity; see Section 4.0.3.
- 4 Press the  TEST key to start printing.

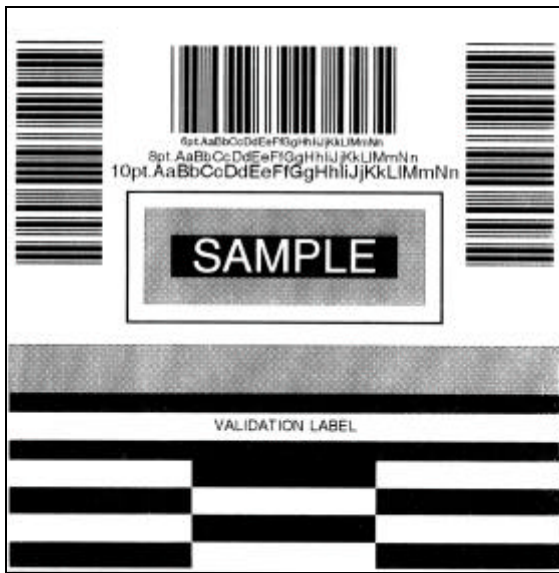

4.3.6 User Defined Label

The User Defined Label will reprint the last label printed (unless the printer was powered-off between the printing of the last label and the request to print a user defined label). This label is recalled from the print buffer and can be any of the Quick Test labels, a label format from the host, or a label format recalled from a memory module.



Maintenance and Adjustments

Section 5

5.0 Media Sensor Calibration

In addition to the Sensor Type selection, Media Sensor calibration ensures that each label is detected correctly and reliably. Perform calibration when the 'Uncalibrated' message is displayed. Two different methods are available to calibrate the printer: Standard and Advanced Entry.

5.0.1 Standard Calibration









Standard Calibration is appropriate for most media types. During the process, the printhead assembly can be raised for visual access to the media and media sensor. In addition, displayed sensor readings can be used to indicate the best position over the media, which is helpful when using small, position-critical TOF notches or marks. Three readings are required:

- Empty: No media in the sensor.
- Gap (or Mark): Only the backing, notch, or reflective mark in the sensor.
- Paper: The label (with the liner attached) in the sensor.

To perform a Standard Calibration:

Step	Operator Action	Displayed Message	Comment
1	(Media should be loaded and the appropriate Sensor Type selected.) Turn 'On' the printer.		Wait until the printer initializes (about six seconds).
2	 Press the MENU key. Raise the printhead assembly.		You are entering Menu Mode.

Standard Calibration (continued)

Step	Operator Action	Displayed Message	Comment
3	Press the ENT  key to enter the Media Settings menu.		See Section 4.1.2 for menu layout.
4	Press the FWD  key and scroll to 'Sensor Calibration'.		Press the ESC  key to abort this procedure.
5	Press the ENT  key.		You are beginning the standard calibration procedure.
6	Press the ENT  key. Remove the media from the Media Sensor then press any key.		This sets the parameter for the 'empty' value. Where 'yyy' is a numerical value representing the current sensor reading.

Standard Calibration (continued)

Step	Operator Action	Displayed Message	Comment
7	<p>Proceed according to your media type:</p> <p>Die-cut stock: strip the media from the backing and then reinsert it into the sensor; adjust the Sensor Eye Mark over the center of the backing.</p> <p>Notched stock: adjust the Sensor Eye Mark over the center of the notch.</p> <p>Reflective stock: Adjust the Sensor Eye Mark over the center of the facedown black mark.</p> <p>Continuous stock: go to Step 8.</p> <p>Press any key to continue.</p>	<div style="border: 1px solid black; width: 100%; height: 20px; margin-bottom: 5px;"></div> <p style="text-align: center;"><i>Or, for reflective media:</i></p> <div style="border: 1px solid black; width: 100%; height: 20px; margin-bottom: 5px;"></div>	<p>This sets the parameter for the 'gap' or 'mark' value.</p> <p>Where 'yyy' is a numerical value representing the current sensor reading; useful in locating the best sensor position.</p> <div style="border: 1px solid black; padding: 5px; margin-top: 10px;"> <p><input checked="" type="checkbox"/> Note: Never position the sensor over a perforation when recording a sensor reading.</p> </div>
<p><input checked="" type="checkbox"/> Note: Do not move the position of the Media Sensor after it has been adjusted.</p>			
8	<p>Position the label (and backing, if any) under the Sensor Eye Mark.</p> <div style="border: 1px solid black; padding: 5px; margin-top: 10px;"> <p><input checked="" type="checkbox"/> Note: If using preprinted media, ensure the label area under the sensor is free of preprinted text, graphics or borders.</p> </div> <p>Press any key to continue.</p>	<div style="border: 1px solid black; width: 100%; height: 20px; margin-bottom: 5px;"></div>	<p>This sets the parameter for the 'paper' value.</p> <p>Where 'yyy' is a numerical value representing the current sensor reading.</p>

Standard Calibration (continued)

Step	Operator Action	Displayed Message	Comment
9	Observe the display.	<div style="border: 1px solid black; height: 20px; width: 100%;"></div> <p style="text-align: center;"><i>Or, for reflective media:</i></p> <div style="border: 1px solid black; height: 20px; width: 100%;"></div> <p style="text-align: center;"><i>Or, for continuous media:</i></p> <div style="border: 1px solid black; height: 20px; width: 100%;"></div>	<p>The calibration was successful.</p> <p>See note below if another message was displayed.</p>
10	<p>Exit upon successful calibration: Back out of the menu tree by repeatedly pressing the ESC  key.</p> <p>If using gap or reflective media, press and hold the FEED key. The printer will begin advancing media; allow at least one label gap (or mark) to advance under the sensor.</p>	<div style="border: 1px solid black; height: 20px; width: 100%;"></div>	<p>The printer is now ready to begin printing.</p> <p>If this calibration was not successful, go to Section 5.0.2.</p>

Note: A 'Warning Low Backing' message indicates that the calibration was successful with notched media or media on a transparent liner; see Section 6.1 for details on this and other possible messages.











5.0.2 Advanced Entry Calibration

Advanced Entry Calibration is the alternate method for special-case media types. The procedure has two parts:













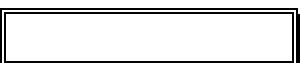

- 1) Using different sampling algorithms, displayed sensor readings have to be listed for each label and TOF value.
- 2) From this data, the best algorithm is chosen; then those values are manually entered for the 'Paper', 'Gap' (or 'Mark'), and 'Empty' variables.

 Advanced Entry Calibration will override all previous calibration settings; this method should be used only when Standard Calibration has failed.

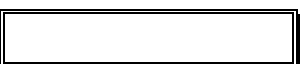

To perform an Advanced Entry Calibration:

Step	Operator Action	Displayed Message	Comment
1	(Media should be loaded and the appropriate Sensor Type selected.) Turn 'On' the printer.		Wait until the printer initializes (about six seconds).
2	 Press the MENU key. Raise the printhead assembly.		You are entering Menu Mode.
3	Press the ENT  key to enter the Media Settings menu.		See Section 4.1.2 for menu layout.
4	Press the FWD  key and scroll to 'Sensor Calibration'.		Press the ESC  key to abort this procedure.
5	Press the ENT  key.		You are entering the calibration submenu.

Advanced Entry Calibration (continued)

Step	Operator Action	Displayed Message	Comment
6	Press the FWD  key to scroll to 'Advanced Entry'.		You are entering Advanced Entry Calibration.
7	Press the ENT  key.		Press the ESC  key to abort this procedure.
8	Press the FWD  key.		You are beginning the Advanced Entry Calibration.
9	Press the ENT  key. Place the label under the Sensor Eye Mark and lower the printhead assembly.	 <i>-OR-</i> 	If using preprinted media, ensure the label area under the sensor is free of preprinted text, graphics or borders.
10	Press the ENT  key to select the setting (denoted by an '*') and then record the sensor reading (the 'yyy' value) in a table similar to the one shown after Step 12, as a Label Value . Next, press the FWD  key to increment the Gain Number. Repeat this step for each of the Gain Numbers (00-32).	 <i>-OR-</i> 	Where 'yyy' is a numerical value representing the current sensor reading: useful in locating the best sensor position. <div style="border: 1px solid black; padding: 5px;"><input checked="" type="checkbox"/> Note: Never position the sensor over a perforation when recording a sensor reading.</div>

Advanced Entry Calibration (continued)

Step	Operator Action	Displayed Message	Comment
11	<p>Proceed according to your media type:</p> <p>Die-cut stock: strip the media from the backing and then reinsert it into the sensor; adjust the Sensor Eye Mark over the center of the backing.</p> <p>Notched stock: adjust the Sensor Eye Mark over the center of the notch.</p> <p>Reflective stock: Adjust the Sensor Eye Mark over the center of the facedown black mark.</p> <p>Press the ENT  key to select the setting and then record the sensor reading in a table similar to the one shown after Step 12, as a TOF Value.</p> <p>Next, press the FWD  key to increment the Gain Number.</p> <p>Repeat for each of the Gain Numbers (00-32).</p>	<div style="border: 1px solid black; width: 100%; height: 20px; margin-bottom: 5px;"></div> <p style="text-align: center;"><i>Or, for reflective media:</i></p> <div style="border: 1px solid black; width: 100%; height: 20px; margin-bottom: 5px;"></div>	<p>Where 'yyy' is a numerical value representing the current sensor reading: useful in locating the best sensor position.</p> <div style="border: 1px solid black; padding: 5px; margin-top: 10px;"> <p><input checked="" type="checkbox"/> Note: Never position the sensor over a perforation when recording a sensor reading.</p> </div>

Note: Do not move the position of the Media Sensor after it has been adjusted.





Advanced Entry Calibration (continued)

Step	Operator Action	Displayed Message	Comment
12	<p>From the data collected in Steps 10 and 11, where both the sensor readings are above 20, subtract each Label Value from the corresponding TOF Value. These are the Difference Values.</p> <p>From the resulting list, find the largest Difference Value (see example below). Its associated Gain Number will provide the best algorithm for your media.</p>	<div style="border: 1px solid black; width: 150px; height: 25px; margin-bottom: 10px;"></div> <p style="text-align: center;"><i>Or, for reflective media:</i></p> <div style="border: 1px solid black; width: 150px; height: 25px; margin-bottom: 10px;"></div>	Both sensor readings must be above 20.













For example, if your compiled data had the values shown in this table, Gain Number 8 would be chosen because it has the highest Difference Value (146) where both the Label Value and the TOF Value are above 20.

Gain Number	Label Value	TOF Value	Difference Value
00	255	254	1
01	251	240	11
02	241	213	28
03	231	182	49
04	219	150	69
05	212	119	93
06	200	88	112
07	189	58	131
08	178	32	146
09	167	19	N/A
10	156	17	N/A
11	146	16	N/A
12	136	15	N/A
...
31	116	14	N/A
32	112	14	N/A

Advanced Entry Calibration (continued)

Step	Operator Action	Displayed Message	Comment
13	Using the FWD  key, select the Gain Number determined in Step 12. Press the ENT  key to select the setting.	<div data-bbox="473 207 780 266" style="border: 1px solid black; width: 100%; height: 100%;"></div> <p style="text-align: center;"><i>Or, for reflective media:</i></p> <div data-bbox="473 342 780 401" style="border: 1px solid black; width: 100%; height: 100%;"></div>	Selection is denoted with an '*'.
14	<p>❶ Place the media in the Media Sensor. Record the sensor reading and label it 'P' (paper).</p> <p>❷ Place the backing, mark, or notch in the Media Sensor. Record the sensor reading and label it 'G' or 'M' (Gap or Mark).</p> <p>❸ Remove all media. Record the sensor reading and label it 'E' (Empty).</p>	<div data-bbox="473 456 780 514" style="border: 1px solid black; width: 100%; height: 100%;"></div> <p style="text-align: center;"><i>Or, for reflective media:</i></p> <div data-bbox="473 591 780 649" style="border: 1px solid black; width: 100%; height: 100%;"></div>	Where 'yyy' is a numerical value representing the current sensor reading.
15	Press the ESC  key. Then press the FWD  key.	<div data-bbox="473 951 780 1010" style="border: 1px solid black; width: 100%; height: 100%;"></div>	The sensor readings must be manually entered into the printer now.

Advanced Entry Calibration (continued)

Step	Operator Action	Displayed Message	Comment
16	<p>Press the ENT  key.</p> <p>Using the FWD  or the REV  key, set the 'Paper' level to the value determined in the previous step. Press the ENT  key to set the entry (indicated by the '*') and advance the menu.</p> <p>Repeat for the 'Gap' (or 'Mark') and 'Empty' levels.</p>	 <p style="text-align: center;">↓</p>  <p style="text-align: center;">↓</p>  <p style="text-align: center;"><i>Or, for reflective media:</i></p>  <p style="text-align: center;">↓</p>  <p style="text-align: center;">↓</p> 	<p>The selection will flash and the display heading will change to indicate the item for entry.</p>
17	<p>After all entries have been made, press the ESC  key to back out of the menu and then press the ENT  key to save the settings and return to the Ready Mode.</p>		<p>From 'Ready', press the FEED key to advance to the next label TOF.</p>

Note: If the Advanced Entry Calibration fails, try the following procedure.

Re-enter Media Settings / Calibration / Advanced Entry / Sensor Gain and lower the selected Gain Setting number by one (to make the sensor less sensitive). Select the new Gain Setting, save the changes, exit the menu, and then test your media. Repeat the procedure until a usable media setting is obtained.

5.1 Printhead Adjustments

To ensure consistent print quality over a wide range of media types and dimensions, the printer is equipped with a Leveling Cam adjustment and a Burn Line adjustment.

5.1.1 Leveling Cam Adjustment

When printing on less than full width media, use the Leveling Cam to adjust the right side of the Printhead Assembly for even pressure distribution. To adjust the Leveling Cam:

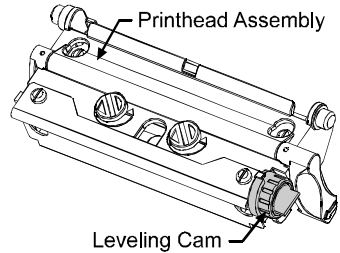

- 1 With media loaded in the printer, download your label format (or use a Quick Test format) and begin batch printing.
- 2 While observing the printed labels, rotate the Leveling Cam counter-clockwise to an over-adjusted position (see Example 1, below).
- 3 Next, rotate the Leveling Cam clockwise, one click at a time, until the printed labels contain a complete, even image (see Example 2).

 Whenever labels of a different width are used, readjust the Leveling Cam.

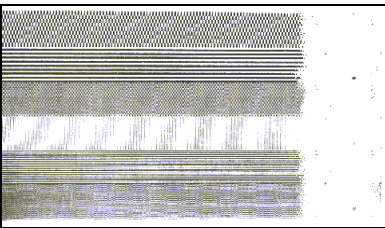

Example 1 – Over adjustment:

Too much adjustment produces an image that fades across the label. To correct this, decrease the setting of the Printhead Leveling Cam.

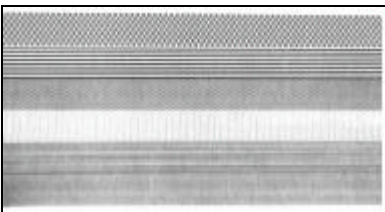

Example 2 – Correct adjustment:

The proper adjustment produces a complete image with even print contrast across the label (see note below).

Note: Under-adjustment of the Leveling Cam: Problems can include ribbon wrinkling, label tracking, and platen roller and printhead wear.

5.1.2 Burn Line Adjustment

The Burn Line has been adjusted at the factory for strict compliance using 6.5-mil (.0065 inch) media, ensuring print quality across a majority of media types. In extreme cases, however, if media of a different thickness or rigidity is used (for example, heavy tag stock), print quality can change. Try the suggestions in Section 2.1.1 and 5.3.1. If print quality remains unacceptable, an adjustment may be required. Typically, thicker media requires a slight forward adjustment, while thinner media requires a slight backward adjustment.



If you have questions, contact a qualified technician or Technical Support before proceeding.

To adjust the Burn Line:

- 1 Load the printer with your media (and ribbon, if required), lower the printhead assembly and rotate the printhead latch back into the locked position.
- 2 Loosen the two Locking Screws approximately $\frac{1}{4}$ turn counter-clockwise.
- 3 Turn the Adjustment Screws counter-clockwise until the burn line is past the platen roller vertex. Print a Validation Label from the Quick Test menu; see Section 4.3.5. The label should look light and uneven.
- 4 Tighten the Locking Screws just until they are 'snug' (tight enough to remove any play in the printhead assembly, yet loose enough to allow the Adjustment Screws to move the printhead).
- 5 Turn each Adjustment Screw clockwise about a $\frac{1}{4}$ turn (or an $\frac{1}{8}$ turn for finer adjustments, see note below). Print another Validation Label and examine the print quality. Repeat this step until the labels are produced with even print contrast (darkness) and acceptable print quality are produced.

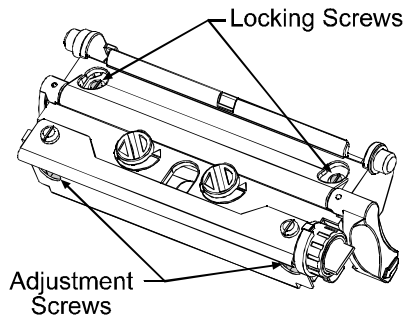

Note: When the Locking Screws are 'snug', turning the Adjustment Screws counter-clockwise will not move the printhead outward; if you have adjusted the printhead too far inward, restart the entire procedure.

- 6 Tighten the Locking Screws. Print a final Quick Test label to verify the adjustment.

5.2 Printhead Replacement

☑ **Note:** The printhead is fragile; use extreme care when handling and never use a sharp object on the surface. If you have any questions or concerns regarding this procedure, contact a qualified technician or Technical Support before proceeding.

If the printhead must be replaced, Locating Pins eliminate the need for printhead alignment after the installation. To replace the printhead:

- 1 Touch a bare metal part of the printer's frame to discharge any static electricity that may be present.
- 2 Turn 'Off' and unplug the printer. Open the access cover, if ribbon is installed, remove it.
- 3 With the printhead locked in the down position, loosen the Printhead Mounting Screw (it will remain captivated in the assembly).

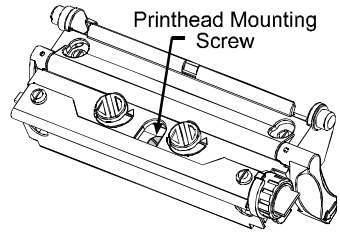

- 4 Rotate the printhead latch forward. While holding the Printhead, raise the assembly. Disconnect the two Cables and then remove the old Printhead.
- 5 While carefully holding the new Printhead, connect both Cables.

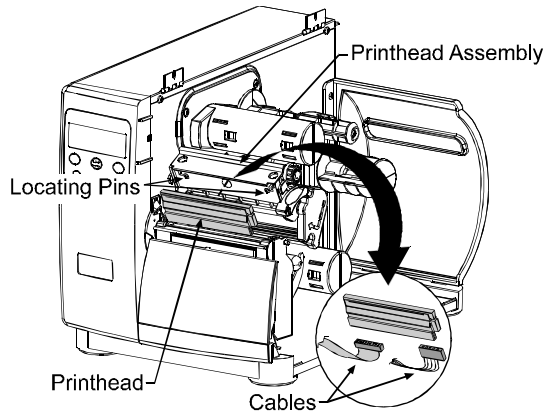

- 6 Position the Printhead onto the Locating Pins in the Printhead Assembly and secure in place with the Printhead Mounting Screw. (Do not over-tighten this screw.)
- 7 Clean the Printhead; see Section 5.3.1.
- 8 Reload ribbon (if removed), lower the printhead assembly, and rotate the printhead latch back, into the locked position. Plug in and turn 'On' the printer. Print a Validation Label from the Quick Test menu; see Section 4.3.5. If necessary, adjust the print darkness to match that of the previous printhead using the Print Control/Custom Adjustments/Darkness setting in the menu; see Section 4.1.3.

5.3 Maintenance Schedule

The following list and table detail the recommended items, techniques and schedules to help you safely and effectively clean the printer.

- Isopropyl alcohol
- Cotton swabs
- A clean, lint-free cloth
- Soft-bristle brush
- Soapy water/mild detergent
- Compressed air



For your safety and to avoid damaging the printer, turn 'Off' and unplug the printer before cleaning; and take proper precautions when using isopropyl alcohol, a flammable liquid.

Recommended Cleaning Schedule		
Area	Method	Interval
Printhead	Using a cotton swab dampened with isopropyl alcohol, clean the printhead from end to end, removing all build-up. See Section 5.3.1. WARNING! Before cleaning, allow time for the printhead to cool.	Clean after each roll or box of labels, or after each roll of ribbon.
Platen Roller	Using a cotton swab dampened with isopropyl alcohol, rotate the platen and remove all build-up. See Section 5.3.2.	Clean after each roll or box of labels, or after each roll of ribbon.
Media Path / Tear Plate	Compressed air / soft-bristle brush and isopropyl alcohol. Remove all build-up along the path that the ribbon and paper follow through the printer.	As needed, based on a weekly visual inspection.
Media Sensor	Compressed air. If needed, a swab dampened with isopropyl alcohol. Remove all build-up.	Monthly or as needed.
Interior	Soft-brush or compressed air. Remove all build-up. See Section 5.3.3.	As needed.
Exterior	Mild detergent. Remove all build-up. See Section 5.3.3.	As needed.
Cutter	Refer to the documentation supplied with the option.	As directed.

5.3.1 Cleaning the Printhead

If print quality declines (symptoms include non-compliant bar codes, print dropouts, streaks; see Section 4.3.4), the typical cause is debris build-up on the printhead. Furthermore, when the build-up is not removed it may lead to element failure, greatly reducing the life of the printhead. To clean the printhead:

- 1 Turn 'Off' and unplug the printer.
- 2 Open the access cover. Unlock the Printhead Latch and raise the Printhead Assembly. Move media and ribbon away from the printhead as necessary.
- 3 Using a cotton swab moistened, not soaked, with isopropyl alcohol gently wipe away any build-up on the Printhead surface, paying close attention to the Burn Line. Allow the printhead to dry.
- 4 Replace the ribbon and media. Lower the Printhead Assembly and rotate the Printhead Latch completely back, to the locked position.
- 5 Close the cover. Plug in and turn 'On' the printer. Feed several labels to normalize tracking.

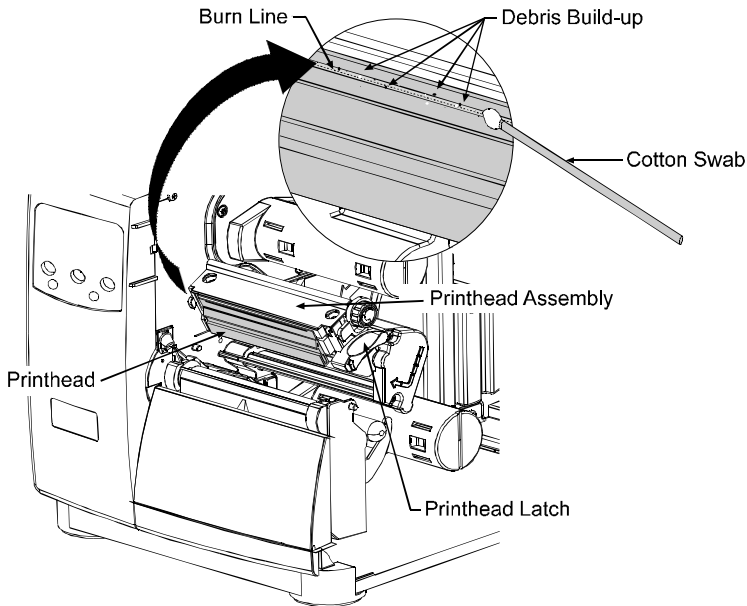

NEVER use a sharp object to clean the Printhead.

5.3.2 Cleaning the Platen Roller

A platen roller contaminated with grit, label adhesive, or ink can cause a decline in print quality and, in extreme cases, cause labels to stick and wrap around the roller. To clean the platen roller:

- ❶ Turn 'Off' and unplug the printer.
- ❷ Open the access cover. Unlock the Printhead Latch and raise the Printhead Assembly. Remove media and ribbon.
- ❸ Using a Cotton Swab dampened with isopropyl alcohol, clean the Platen Roller; manually rotate the roller and repeat, cleaning the entire surface. Allow the Platen Roller to dry.
- ❹ Replace ribbon and media.
- ❺ Lower the Printhead Assembly and rotate the Printhead Latch completely back, to the locked position.
- ❻ Close the access cover. Plug in and turn 'On' the printer. Feed several labels to normalize tracking.

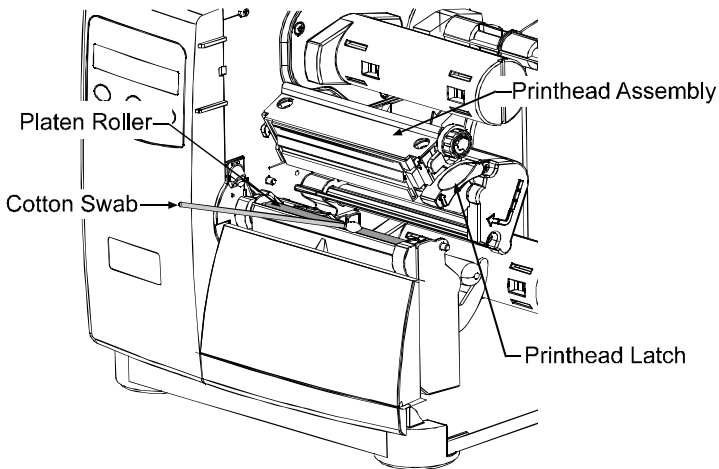

CAUTION

NEVER use a sharp object to clean the Platen Roller.

5.3.3 Cleaning Interior and Exterior Surfaces

Interior Surfaces: During operation, dust particles from the media build-up inside the printer. Then, as the media is pulled through the printer, the particles can become attached and cause voids on the printed labels. To prevent this, turn 'Off' and unplug the printer. Remove all media. Using a soft bristle brush or compressed air, clean out the interior of the printer.

Exterior Surfaces: The outer surfaces of the printer should be cleaned using a general-purpose cleanser. Never use abrasive cleansers or solvents. To clean, turn 'Off' and unplug the printer. Using a soft cloth or sponge dampened with the cleanser, wipe the exterior surfaces until clean.

5.4 Application Version Updates

The printer stores its application program in Flash memory on the Main PCB. A feature is included that allows updates to this program through any printer interface port. Updates can be found at our web site.

There are two modes in which the firmware of the printer can be updated: (1) the Ready Mode, or (2) the Download Mode. Before beginning an update, identify the current version of the printer's application program by printing a Configuration Label (see Section 4.3.2). Compare that version string to those filenames available from our web site and then download the desired file onto your computer's hard drive.

Proceed with the printer update accordingly:





- If the current application version is 2.091 or greater, refer to Section 5.4.1 or Section 5.4.2.
- If the current application version is 2.08 or earlier, refer to Section 5.4.2.





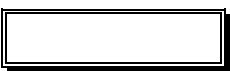

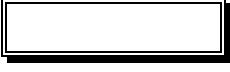
Should an error occur during the download (see Section 5.4.3), the update is aborted. If this process did not reach 'Erasing Flash' or 'Updating Software', the previous program is left intact; otherwise, a successful download must be completed before the printer is operable.

Note: Users desiring a foreign language menu: After updating from 2.xx to 3.xx firmware for the first time, you must also download the EFIGS menu language file. Go to the EFIGS ftp directory and copy 832296.01C (or most current version) to lpt1: /b (the DOS Copy command requires the /b parameter because this file contains binary code).

5.4.1 Updating from Ready Mode

Update Procedure for Application Version 2.091 or greater			
Step	Displayed Message	Operator Action	Comment(s)
1		Using the DOS copy command (where 'filename' is the program to be loaded and 'lpt1' is the selected interface port), enter the following: copy filename lpt1:	As an example, this would be entered as: copy 4212tb~1.zs lpt1 (Where 'lpt1' is the host computer's port; however, this selection can differ to include a serial or other port, as the printer is equipped.) The Ready Indicator will flash as data is received.
2		No action required.	The new application program is being stored and verified.
3		No action required.	The printer has reset automatically and is now displaying the new firmware version.
4		No action required.	The new application is now running. <input checked="" type="checkbox"/> Note: If 'Uncalibrated' is displayed, the printer must be calibrated (see Section 5.0).

5.4.2 Updating from Download Mode

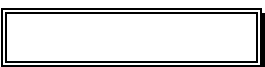
Required Update Procedure for Application Version 2.08 or earlier*			
Step	Displayed Message	Operator Action	Comment(s)
1		Press and hold the PAUSE and TEST keys while turning 'On' the printer to enter the Download Mode.	The Boot Loader version is displayed. <input checked="" type="checkbox"/> Note: This information will vary with the printer model and Boot Loader version.
2		Using the DOS copy command, copy the filename to the printer (see Step 2 in Section 5.4.1).	The printer is ready to accept the new application version. <input checked="" type="checkbox"/> Note: The parallel port (LPT1) must be used to write to the printer.
3		No action required.	The printer is receiving the new image (program).
4		No action required.	The program has been received and verified; now memory is being cleared of the previous application.
5		No action required.	The new program is being written into Flash memory. Upon completion, the printer will automatically reset and start the new application. <input checked="" type="checkbox"/> Note: If 'Uncalibrated' is displayed, the printer must be calibrated (see Section 5.0).

*This can also be used as an alternate download method for all other version levels.

5.4.3 Possible Problems during an Update

The following is list of possible error messages when downloading:

- Note:** If experiencing trouble when attempting to download the file to the printer, try the following alternate methods:
- 1) Use Download Mode (see Section 5.4.2).
 - 2) Windows® users – try restarting the computer in MS-DOS mode.
 - 3) Use the Windows Driver by Seagull Scientific™ – Device Setting / Send File to Printer function.

Application Update Error Messages	
Displayed Message	Descriptions / Causes / Solutions
	The printer detected an error during the decompression and transfer of file data from cache storage into the Flash memory. Confirm the version and retry in Download Mode; however, if the problem continues call for service.
	The printer could not successfully erase Flash memory. The possible cause is defective Flash memory. Try the download again; however, if the problem continues call for service.
	The printer could not successfully write the program into Flash memory. A possible cause is defective Flash memory. Try the download again; however, if the problem continues call for service.
	Application Firmware downloaded was not compatible with the printer's Main PCB. The firmware used was for a different model and not supported by this boot loader version. See Configuration Level, Section 4.1.5.
	The printer detected an error in the download. The possible causes include: <ul style="list-style-type: none"> • An invalid or corrupted file was downloading. Try saving the file to the host and then download again. • A communications error. Recheck cabling and port setting.
	Software level not authorized for this printer (See Section 4.1.5, Configuration Level/Printer Key.)

5.5 Boot Loader Program Updates

The printer stores the Boot Loader Program in Flash memory on the Main PCB. A feature allows updates to this program via the printer's interface port. Updates can be found at our web site.



If power is lost while 'Upgrading Software' is displayed, the printer will become non-functional and must be returned to the factory for programming or the main logic board must be replaced.

- Note:** Only printers with an Application Version of 2.09 or greater can update the Boot Loader Program.

Before beginning the Boot Loader update, identify the printer's current version. Print a Configuration Label (see Section 4.3.2) and compare that version string to those available from our web site. Download the desired version onto your computer's hard drive. To update the Boot Loader Program:

Boot Loader Update Procedure			
Step	Displayed Message	Operator Action	Comment(s)
1		Using the DOS copy command (where 'filename' is the program to be loaded and 'lpt1' is the selected interface port), enter the following: copy filename lpt1:	As an example, this would be entered as: copy bootb~1.bs lpt1 (Where 'lpt1' is the host computer's output port; however, your selection can differ to include a serial or other port, as the printer is equipped.) The Ready Indicator will flash as data is received.
2		No action required.	The new program is being stored and verified.
3		No action required.	The printer has reset automatically.
4		No action required.	The new application is now running. <input checked="" type="checkbox"/> Note: If 'Uncalibrated' is displayed, the printer must be calibrated (see Section 5.0).



Troubleshooting

Section 6

6.0 Problem Resolution

Should a problem arise, the information in this section will help you resolve it. The following table lists problems that will not necessarily generate an error message. (For information on messages, see Section 6.1.)



If you have questions, or if problems persist, contact a qualified technician or Technical Support.

If experiencing this problem...	Try this solution...
Cannot communicate through the parallel port:	Observe the Ready Indicator as the format is sent to the printer. If it does not flash, check the parallel cable type. Also check the protocol and port settings of the printer and host.
Cannot load media through the optional cutter:	Turn 'Off' the printer. Ensure that the cutter and cutter cable are properly installed. Turn the printer 'On'. If the problem continues, call for service.
The LCD is blank, but the Ready Indicator is 'On':	The display contrast may set too low. Press and hold the MENU key for 10 seconds or until the display reappears.
Erratic feeding:	The printer may require a Quick Media Calibration; see Section 3.4.
Erratic printing (instead of the label format, strange characters are printed):	<ul style="list-style-type: none">• The printer may be in Hex Dump Mode; see Section 6.2.• If using the serial port for communicating, check both the host and printer port settings; the printer may be set to eight data bits while the host is set to 7 (or vice versa).

If experiencing this problem...	Try this solution...
Intellifont™ will not print:	Intellifont™ format is Little/Big Endian specific. The printer uses Big Endian. Refer to your font supplier for information.
Light print on the right side (facing the printer) of the label:	<ul style="list-style-type: none"> • The Printhead Leveling Cam may be incorrectly adjusted; see Section 5.1.1. • The Platen Roller may be dirty or worn; see Section 5.3.2.
Missing information in the printed label:	<ul style="list-style-type: none"> • Check the label format for character placement outside the dimensions of the label; all row/column values must allow enough space for the height/length of the characters and bar codes to be printed within the format size. • The available memory may have been exceeded by the memory requirement of the label format. Try reducing the memory allocated to either the internal module or scaleable font caches; see System Settings / Memory Settings, Section 4.1.5. • If using serial communications, ensure that the interface cable meets the requirements found in Section 3.0.1.
Missing print on left or right side of the label:	Information may be formatted outside the label dimensions. Check your software program label size or check the values in the menu for Print Control / Column Offset and Print Control / Custom Adjustments / Column Offset; see Section 4.1.3.

If experiencing this problem...	Try this solution...
<p>No power (all indicator lights are 'Off'):</p>	<ul style="list-style-type: none"> • Verify that the AC power cord connection has been made at both the outlet and the printer; also, ensure the power switch is 'On'. • Verify that the AC outlet is functioning, or try moving the printer to another AC circuit. • The AC cord may be damaged; replace it. • The line fuse may be blown; call for service.
<p>Nothing is printing (labels advance normally, but no image is printed):</p>	<p>Examine the used ribbon for an image:</p> <p>If there is an image on the used ribbon:</p> <ul style="list-style-type: none"> • Verify that the ribbon was properly loaded per Section 3.3. • If properly loaded, the wrong coating configuration was used. (To verify the inked side, press the adhesive backing of a label against the ribbon surface. Ink will only lift from the coated side of the ribbon.) Clean the printhead (see Section 5.3.1); then replace the ribbon with the correct type for the printer, Section 3.3. <p>If there is no image on the used ribbon:</p> <ul style="list-style-type: none"> • Run any Quick Test Label; see Section 4.3. If an image printed, then check the protocol and port settings for both the printer and host. These must match. • The heat setting may be too low. Make an adjustment in the software program or through the Front Panel. (The same functional commands from the host computer override the menu settings.) • The media/ribbon combination may be incorrect. Contact a Media Representative. • The printhead or printhead cable(s) may be loose; power 'Off' the printer then reconnect; see Section 5.2 for locations.

If experiencing this problem...	Try this solution...
Nothing happens when trying to print using a software program:	<ul style="list-style-type: none"> • Ensure that the printer is at READY. • Observe the Front Panel, if the READY light does not flash as you send the format check the protocol and port settings between the printer and host. • Ensure the interface cable meets the requirements found in Section 3.0.1.
Poor print quality:	<ul style="list-style-type: none"> • The printhead may need cleaning; see Section 5.3.1. • Adjust the Heat and Print Speed settings through the Front Panel or by host commands; see Section 4.1.3. (The same functional commands from the host computer override the menu settings.) • The media/ribbon combination may not be compatible; see Section 2.1. • The Printhead Leveling Cam may be incorrectly adjusted; see Section 5.1.1. • The Platen Roller may be dirty or worn; see Section 5.3.2. • The Printhead Burn Line may need adjusting; see Section 5.1.2.
Skips labels when printing:	<ul style="list-style-type: none"> • Quick Media Calibration may be needed; see Section 3.4. • The Media Sensor may be out of position; readjust the position; see Section 3.2. • The format may be within 1/8 inch of the label's edge. Try reducing or moving the format slightly.
Unable to print rotated text:	<p>The characters may be formatted outside the label dimensions. Ensure the row/column values provide enough room for the height of the characters or bar code to be printed. See the <i>Programmer's Manual</i> for details.</p>

6.1 Fault and Warning Messages

All printer functions are internally monitored. If a problem (Fault) or a potential problem (Warning) is detected, the Error Indicator (see Section 4.0.4) will be illuminated. A corresponding message will be displayed (if not within a branch of the menu system or in Quick Test Mode). These messages, along with possible solutions, are described below.





Fault Messages:

Fault Messages receive the highest display priority. If more than one fault is detected the display will cycle between messages.

Note: To return to normal operation after the printer enters a fault condition, the fault must be corrected and then the FEED key must be pressed to clear the condition.

Printer Fault Messages		
Displayed Message	Description	Possible Solution(s)
	The printer has detected a drop in the 24-volt power supply.	Try cycling the printer power 'Off' and 'On'. If the fault does not clear, call for service.
	The printer has detected an analog to digital circuit converter failure.	Try cycling the printer power 'Off' and 'On'. If the fault does not clear, call for service.
	The printer has detected a cutter mechanism fault.	<div style="border: 1px solid black; padding: 5px; margin-bottom: 10px;"> <p>WARNING! Use extreme care: Turn 'Off' the printer and unplug the power cord before examining the cutter and cable.</p> </div> <p>Make sure the cutter option is properly installed.</p> <p>Carefully examine the cutter for obstructions.</p>



Printer Fault Messages (continued)

Displayed Message	Description	Possible Solution(s)
	The printer has detected a Direct Memory Access failure.	Try cycling the printer power 'Off' and 'On'. If the fault does not clear, call for service.
	Consistently low sensor readings were detected.	Press any key to continue. Ensure that media was inserted in the media sensor during the appropriate calibration step; also ensure that the sensor is free of debris. Retry the calibration. If the problem persists, try the 'Advanced Entry Calibration'; see Section 5.0.2.
	Consistently high sensor readings were detected.	Press any key to continue. Ensure that media was removed from the media sensor during the appropriate calibration steps; also ensure that no labels are stuck in the media sensor. Retry the calibration. If the problem persists, call for service.
	The printer cannot detect media.	Try the following: <ol style="list-style-type: none">1) Load media.2) Ensure that the labels are passing through the Media Sensor.3) Readjust the Media Sensor over the TOF mark; see Section 3.2.4) If using media with large gaps, adjust the Paper Out Distance; see Section 4.1.2.5) Calibrate the printer; see Section 5.0.

Printer Fault Messages (continued)

Displayed Message	Description	Possible Solution(s)
	The printer was unable to complete the Media Calibration; or, the printer was powered off or reset during a ribbon, out of stock or TOF fault.	Press the FEED key in an attempt to clear the message. If necessary, perform a media calibration or correct the related fault condition.
	The printer has detected a problem within the print logic.	Try cycling the printer power 'Off' and 'On'. If the fault does not clear, call for service.
	The system has detected a RAM failure.	Try cycling the printer power 'Off' and 'On'. If the fault does not clear, call for service.
	Consistently low sensor readings were detected.	Press any key to continue. Ensure that the reflective mark was inserted facedown in the media sensor during the appropriate calibration step; also, ensure that the reflective mark is made of carbon based ink, and that the sensor is free of debris. Retry calibration. If the problem persists, try an 'Advanced Entry Calibration'; see Section 5.0.2.

Printer Fault Messages (continued)

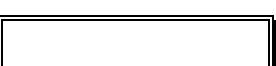





Displayed Message	Description	Possible Solution(s)
	Consistently high sensor readings were detected.	Press any key to continue. Ensure that media was removed from the media sensor during the appropriate calibration steps; also ensure that no labels are stuck in the media sensor. Retry the calibration. If the problem persists, call for service.
	The ribbon sensor values have changed, or the printer detects no or only sporadic ribbon supply hub movement.	Try the following: <ol style="list-style-type: none">1) Ensure that ribbon is correctly loaded and that the printhead assembly is latched.2) Check the ribbon supply and ribbon take up hubs for obstructions that may be stopping movement.3) Ensure that the ribbon core fits snugly on the ribbon supply hub.4) Ensure that the media and paper combination is not slipping (usually caused by an incorrect match).
	The printer has shutdown to allow the printhead temperature to cool.	Turn 'Off' the printer until cool to prevent permanent damage due to an excessive printhead temperature.

Printer Fault Messages *(continued)*

Displayed Message	Description	Possible Solution(s)
<div data-bbox="98 201 378 261" style="border: 1px solid black; height: 37px; width: 263px;"></div>	<p data-bbox="397 196 600 407">The printer could not find the TOF mark within the maximum label length setting or it found a TOF in an unexpected place.</p> <div data-bbox="391 440 618 613" style="border: 1px solid black; padding: 5px;"> <p data-bbox="397 448 600 605"><input checked="" type="checkbox"/> Note: When the printer is set for reflective media, this indication is given for an out of stock condition.</p> </div>	<p data-bbox="636 196 855 224">If media is moving:</p> <ol data-bbox="636 240 966 1078" style="list-style-type: none"> <li data-bbox="636 240 966 331">1) Press the FEED key. It may be necessary to re-calibrate the printer; see Section 5.0. <li data-bbox="636 347 966 438">2) The Media Sensor may be out of position. Readjust it; see Section 3.2. <li data-bbox="636 454 966 610">3) The media may not be properly loaded. Reload media, also ensure that the Media Guide is positioned properly; see Section 3.1. <li data-bbox="636 626 966 717">4) The Leveling Cam may be improperly adjusted; see Section 5.1.1. <li data-bbox="636 734 966 915">5) The label may be longer than the default value for maximum length. Check the Media Settings / Maximum Label Length; see Section 4.1.2. <li data-bbox="636 932 966 1078">6) The Media Sensor may be obstructed. Check and carefully remove any obstruction (labels, paper dust, adhesive, etc). <p data-bbox="636 1110 902 1138">If media is not moving:</p> <p data-bbox="636 1154 955 1245">The printhead assembly may not be latched; close and lock.</p>

Warning Messages:

Warning Messages are displayed for a period of five seconds. If multiple Warnings are detected, the display will reflect the highest priority message.

Printer Warning Messages		
Displayed Message	Description	Action(s)
	The printer has detected defective printhead elements.	Replace the printhead if the print quality becomes unacceptable.
	The printer measured only a small difference between the 'empty' and 'gap' sensor readings.	Transparent backing or notched media typically gives this indication. In this case, there may be a slight delay in the 'Out of Stock' indication, after the media supply is emptied; no action is required.
	Power has been removed and shutdown is in progress.	The printer power switch was turned 'Off', the line fuse has blown, or AC line voltage has been lost.
	The host has pending configuration changes that will not take effect until a 'host reset command' is issued.	To save changes, send a host reset command (in DPL), or to discard changes perform a soft reset; see Section 4.0.6.1.
	The printer has detected a low operating voltage.	Possible low or fluctuating line voltage level. Try moving the printer to another outlet. If the condition persists, call for service.
	The printer was unable to save settings in permanent memory.	Possible faulty Main PCB. If the condition persists, call for service.
	A high printhead temperature has been detected.	No action required.

6.2 Hex Dump Mode

The Hex Dump Mode is a useful tool for diagnosing problems, including communication and DPL™ syntax errors, allowing a comparison of input strings (sent by host) to output data (received by printer). To decode this information, the *Programmer's Manual* is an essential reference. This output can be used for debugging the label format. In addition, by repeatedly sending a format, this mode can uncover handshaking problems (if they exist). Handshaking problems are identified by sections of missing data in the character string.

To begin, go to the Diagnostics menu and enable Hex Dump Mode; see Section 4.1.7. Exit the menu and save the changes. Now, 'HEX DUMP MODE' will be indicated by the display and all data sent to the printer will now be output in hexadecimal code, along with the printable ASCII equivalents.

The figure below is a sample Hex Dump Label. After sending a label format to the printer, the hex code output will be immediate. As a final note, many software programs use bit mapping to construct the label, making diagnosis difficult. Contact Technical Support with any questions.

```
0000 02 4C 00 44 31 31 00 31 ^L.D11.1
0008 36 31 31 30 30 30 30 33 61100003
0010 32 30 30 30 31 30 46 4F 200010FO
0018 4E 54 20 36 3A 20 41 4C NT 5: AL
0020 4C 20 56 41 4C 49 44 20 L VALID
0028 20 20 20 20 20 20 20 20
0030 20 20 20 00 31 36 31 31          1611
0038 30 30 30 30 32 38 30 30 00002800
0040 30 31 30 20 20 20 20 20 010
0048 20 20 20 43 48 41 52 41          CHARA
0050 43 54 45 52 53 3A 00 31 CTERS: 1
0058 36 31 31 30 30 30 30 32 61100002
0060 34 30 30 30 31 30 23 24 400010#$
0068 25 26 28 29 2A 2B 2E 2D %&()*+,-
```

Note: To return to Ready Mode, re-enter the Diagnostics Menu and disable the Hex Dump Mode, exit the menu, then save the changes.



Specifications

Section 

7.0 General Specifications

Bar Codes

(See the *Programmer's Manual* for details. See Appendix B for samples.)

Code 39, Interleaved 2 of 5, Code 128 (subsets A, B and C), Codabar, LOGMARS, UPC-A, UPC-E, UPC 2 & 5 digit addendums, EAN-8, EAN-13, EAN 2 & 5 digit addendums, UPC Random Weight, Code 93, Plessey, Universal Shipping Container Symbology, Code 128 MOD 43, Postnet, USS/EAN-128 Random Weight, Telepen, USD-8 (Code 11), UPS MaxiCode (modes 2 & 3), PDF417, Data Matrix, QR Code, Aztec*, and MicroPDF417*.

Fonts

9 Bit-Mapped Fonts, rotatable 0, 90, 180, 270 degrees

CG Triumvirate™ Scalable Font

CG Triumvirate™ Condensed Bold Scalable Font

Communications

Interfaces:	EIA RS-232/DB-25 Serial, and IEEE 1284 Compliant Parallel
Serial Data Rates:	1200, 2400, 4800, 9600, 19.2K, and 38.4K baud.
Handshaking:	Xon/Xoff; CTS/DTR
Parity:	Even, Odd, or None
Stop Bits:	1 or 2
Data Bits:	7 or 8

Electrical

Input Voltage:	90 – 132 or 180 – 264 VAC @ 47–63 Hz, auto-ranging.
Power Consumption:	Typical Operating: 90 Watts / Standby: 10 Watts
Grounding:	Unit must be connected to a properly grounded receptacle.

Environmental Requirements

Operating Temperature:	32° F – 100° F (0° C to 38° C)
Storage Temperature:	0° F –140° F (-17° C to 60° C)
Humidity:	10% – 95% non-condensing
Dust:	Non-conducting, non-corrosive
Electromagnetic Radiation:	Moderate RF fields can be tolerated

Mechanical

Height:	12.70" (322.6 mm)
Width:	12.62" (320.6 mm)
Depth:	18.60" (472.5 mm)
Weight:	45 lbs. (20.5 kg)

Printing Specifications

Printing Type:	Direct Thermal or optional Thermal Transfer
Print Speed:	2 – 8 IPS (51 – 203 mmps) <i>2461</i> 2 – 8 IPS (51 – 203 mmps) <i>3481</i> 2 – 4 IPS (51 – 102 mmps) <i>6441</i>
Printhead Resolution:	203 DPI (8.0 dots/mm) <i>2461</i> 300 DPI (11.8 dots/mm) <i>3481</i> 600 DPI (23.6 dots/mm) <i>6441</i>
Nominal Dot Size:	.0043" X .0052" (.11 mm x .13 mm) <i>2461</i> .0027" X .0043" (.07 mm X .11 mm) <i>3481</i> .0008" X .0015" (.03 mm X .06 mm) <i>6441</i>
Printhead Protection Type:	Thermistor Sensor. Temporary shutdown of printing occurs upon over-temperature detection; printing resumes automatically after cool-down.
Maximum Print Width:	4.10" (104.0 mm) <i>2461</i> 4.16" (105.7 mm) <i>3481</i> 4.16" (105.7 mm) <i>6441</i>

(Continued next page)

Printing Specifications (continued)

Print Length Range:	.25" – 99" (6.4 mm – 2514.6 mm) 2461&3481 .25" – 55" (6.4 mm – 1397 mm) 6441
with an optional cutter:	1.25" – 99" (31.8 mm – 2514.6 mm) 2461&3481 1.25" – 55" (31.8 mm – 1397 mm) 6441
with an optional peel & present mechanism:	1.50" – 99" (38 mm – 2514.6 mm) 2461&3481 1.50" – 55" (38 mm – 1397 mm) 6441
Print Justification:	Left
Flash Memory:	1 MB 2461 2 MB 3481&6441
SDRAM Memory:	8 MB 2461 16 MB 3481&6441

7.1 Media and Ribbon Requirements

Media Types:	Roll-Fed, Die-Cut, Continuous, and Fan-Fold. Flat on the printable side with no more than .0007" (.018 mm) protrusions on the opposite side.
Media Roll Capacity*:	8" (203 mm) outer diameter
Media Core:	1.5" or 3.0" (38 mm or 76.2 mm) inner diameter
Ribbon Core:	1.010" ± .006" (25.6 mm ± .2 mm) inner diameter. Core not to protrude beyond ribbon edge.
Ribbon Width Range**:	1.0" – 4.5" (25.4 mm – 114.3 mm)
Ribbon Length**:	1968' (600 meters) maximum

* Wound out labels only.

** Coated side 'in' or 'out' not interchangeable, dependent upon the Ribbon Supply Hub type; the ribbon width to slightly exceed label width (including backing material).

Media and Ribbon Requirements (continued)

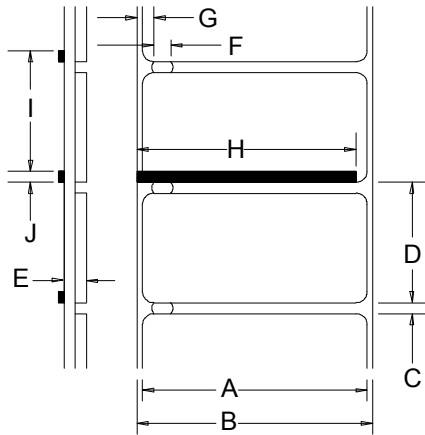

Media Dimensions			
Designator	Description	Maximum ^[1]	Minimum ^[1]
A	label width	4.65	1.00
B	liner width	4.65	1.00
C	gap (or notch) between labels ^[4]	–	.100
D	label length ^[4]	–	.250
E	media thickness ^[2]	.0100	.0025
F	notch opening width	.500	.200
G	distance from the media's edge to the media sensor aperture (left justified)	2.250	.200
H	reflective (black) mark width ^[3]	4.65	.500
I	distance between reflective marks ^[4]	–	.500
J	reflective mark length ^[4]	–	.100

^[1]Units of measure given in inches.

^[2]If the optional Light-Duty Cutter is attached, it must be aligned to only cut liner, where the thickness can be no greater than .005" (.127mm).

^[3]The reflective (black) mark must be carbon based, placed on the backside of the stock, and the reflectance shall be less than 10% at wavelengths of 950 and 640 nm.

^[4]The maximum allowable length of the combined label and gap (or mark) measurement cannot exceed 99.99 inches.

Approved Media

To achieve optimum print quality and maximum printhead life, we recommend the use of *our* media and ribbons. These supplies are specially formulated for use in our printers; use of other supplies may affect the print quality, performance, and life of the printer or its components. For a current list of approved media and ribbons for use in direct thermal and thermal transfer applications consult Section 2.1.1 or contact a Media Representative.



Appendix A

ASCII Control Code Chart

	Char	Dec	Hex	Char	Dec	Hex	Char	Dec	Hex	Char	Dec	Hex
Ctrl @	NUL	0	00		32	20	@	64	40	`	96	60
Ctrl A	SOH	1	01	!	33	21	A	65	41	a	97	61
Ctrl B	STX	2	02	"	34	22	B	66	42	b	98	62
Ctrl C	EXT	3	03	#	35	23	C	67	43	c	99	63
Ctrl D	EOT	4	04	\$	36	24	D	68	44	d	100	64
Ctrl E	ENQ	5	05	%	37	25	E	69	45	e	101	65
Ctrl F	ACK	6	06	&	38	26	F	70	46	f	102	66
Ctrl G	BEL	7	07	'	39	27	G	71	47	g	103	67
Ctrl H	BS	8	08	(40	28	H	72	48	h	104	68
Ctrl I	HT	9	09)	41	29	I	73	49	i	105	69
Ctrl J	LF	10	0A	*	42	2A	J	74	4A	j	106	6A
Ctrl K	VT	11	0B	+	43	2B	K	75	4B	k	107	6B
Ctrl L	FF	12	0C	,	44	2C	L	76	4C	l	108	6C
Ctrl M	CR	13	0D	-	45	2D	M	77	4D	m	109	6D
Ctrl N	SO	14	0E	.	46	2E	N	78	4E	n	110	6E
Ctrl O	SI	15	0F	/	47	2F	O	79	4F	o	111	6F
Ctrl P	DLE	16	10	0	48	30	P	80	50	p	112	70
Ctrl Q	DC1	17	11	1	49	31	Q	81	51	q	113	71
Ctrl R	DC2	18	12	2	50	32	R	82	52	r	114	72
Ctrl S	DC3	19	13	3	51	33	S	83	53	s	115	73
Ctrl T	DC4	20	14	4	52	34	T	84	54	t	116	74
Ctrl U	NAK	21	15	5	53	35	U	85	55	u	117	75
Ctrl V	SYN	22	16	6	54	36	V	86	56	v	118	76
Ctrl W	ETB	23	17	7	55	37	W	87	57	w	119	77
Ctrl X	CAN	24	18	8	56	38	X	88	58	x	120	78
Ctrl Y	EM	25	19	9	57	39	Y	89	59	y	121	79
Ctrl Z	SUB	26	1A	:	58	3A	Z	90	5A	z	122	7A
Ctrl [Esc	27	1B	;	59	3B	[91	5B	{	123	7B
Ctrl \	FS	28	1C	<	60	3C	\	92	5C		124	7C
Ctrl]	GS	29	1D	=	61	3D]	93	5D	}	125	7D
Ctrl ^	RS	30	1E	>	62	3E	^	94	5E	~	126	7E
Ctrl _	US	31	1F	?	63	3F	_	95	5F		127	7F

ASCII Control Code Chart (continued)

Char	Dec	Hex	Char	Dec	Hex	Char	Dec	Hex	Char	Dec	Hex
Ç	128	80	á	160	A0		192	C0	Ó	224	E0
ü	129	81	í	161	A1		193	C1	ß	225	E1
é	130	82	ó	162	A2		194	C2	Ô	226	E2
â	131	83	ú	163	A3		195	C3	Õ	227	E3
ä	132	84	ñ	164	A4		196	C4	ö	228	E4
à	133	85	Ñ	165	A5		197	C5	Ö	229	E5
ã	134	86	a	166	A6	ā	198	C6	μ	230	E6
ç	135	87	°	167	A7	Ă	199	C7	ρ	231	E7
ê	136	88	ć	168	A8		200	C8	ρ	232	E8
è	137	89	®	169	A9		201	C9	Ū	233	E9
ë	138	8A		170	AA		202	CA	Ū	234	EA
ï	139	8B	1/2	171	AB		203	CB	Ū	235	EB
î	140	8C	1/4	172	AC		204	CC	ý	236	EC
ì	141	8D	ı	173	AD		205	CD	Ÿ	237	ED
Ä	142	8E		174	AE		206	CE		238	EE
Å	143	8F	–	175	AF		207	CF		239	EF
É	144	90		176	B0	Ö	208	D0		240	F0
Æ	145	91		177	B1	D	209	D1	±	241	F1
Æ	146	92	2	178	B2	È	210	D2		242	F2
ô	147	93	3	179	B3	Ë	211	D3	3/4	243	F3
ö	148	94	´	180	B4	Ë	212	D4		244	F4
ò	149	95	Á	181	B5		213	D5		245	F5
û	150	96	Â	182	B6	Í	214	D6	÷	246	F6
ù	151	97	Ã	183	B7	Î	215	D7	˘	247	F7
ÿ	152	98	©	184	B8	Ï	216	D8	°	248	F8
Û	153	99	l	185	B9		217	D9	¨	249	F9
Ü	154	9A		186	BA		218	DA	·	250	FA
Ø	155	9B	»	187	BB		219	DB		251	FB
£	156	9C		188	BC		220	DC		252	FC
Ø	157	9D	¢	189	BD		221	DD		253	FD
x	158	9E	¥	190	BE	İ	222	DE		254	FE
f	159	9F		191	BF		223	DF	€	255	FF



Appendix B

Available Fonts and Bar Codes

All character fonts and bar codes available with the printer are described in this section. Each font and bar code has a name associated with it for use in programming. Human-readable fonts have numeric names, while bar code fonts have alpha names. Consult the *Programmer's Manual* for detailed information.

Fonts

Fonts 0 through 8 use the slash zero (Ø) convention for distinguishing between the number zero and the letter O. The slash can be removed with the 'Z' label-formatting command. These fonts are non-proportional (monospaced): each character takes the same amount of space for printing.

The Triumvirate font number 9 is a proportional font: each character will take up a different amount of space when printed.

Font	Valid ASCII Characters
0	32-127
1	32-168, 171, 172, 225
2	32-168, 171, 172, 225
3	32, 35-38, 40-58, 65-90, 128, 142-144, 146, 153, 154, 156, 157, 165, 168, 225
4	32, 35-38, 40-58, 65-90, 128, 142-144, 146, 153, 154, 156, 157, 165, 168, 225
5	32, 35-38, 40-58, 65-90, 128, 142-144, 146, 153, 154, 156, 157, 165, 168, 225
6	32, 35-38, 40-58, 65-90, 128, 142-144, 146, 153, 154, 156, 157, 165, 168, 225
7	32-126
8	32, 48-57, 60, 62, 67, 69, 78, 83, 84, 88, 90
9	32-126, 128-169, 171-173, 181-184, 189, 190, 198, 199, 208-216, 222, 224 - 237, 241, 243, 246-250

The table below lists the font sizes; the numbers indicate the number of dots.

Font	Height	Width	Spacing
0	7	5	1
1	13	7	2
2	18	10	2
3	27	14	2
4	36	18	3
5	52	18	3
6	64	32	4
7	32	15	5
8	28	15	5

Font 0: 96-character alphanumeric, upper and lower case.

```
Font 0:
!"#$%&'()*+,-./0123456789:;<=>?@
ABCDEFGHIJKLMNOPQRSTUVWXYZ[\]^_`
abcdefghijklmnopqrstuvwxyz{|}~
CueaaaaaceeeeiiiIAAEæffooo
ouyOÜe£Ø×fa iouñÑ®®¿¼½¾
```

Font 1: 145-character upper and lower case alphanumeric with descenders and ascenders.

```
Font 1:
!"#$%&'()*+,-./0123456789:;<=>?@
ABCDEFGHIJKLMNOPQRSTUVWXYZ[\]^_`
abcdefghijklmnopqrstuvwxyz{|}~
CueaaaaaceeeeiiiIAAEæffooo
ouyOÜe£Ø×fa iouñÑ®®¿¼½¾
```

Font 2: 138-character alphanumeric, upper and lower case.

```
Font 2:
!"#$%&'()*+,-./0123456789:;<=>?@
ABCDEFGHIJKLMNOPQRSTUVWXYZ[\]^_`
abcdefghijklmnopqrstuvwxyz{|}~
CueaaaaaceeeeiiiIAAEæffooo
ouyOÜe£Ø×fa iouñÑ®®¿¼½¾
```

Font 3: 62-character alphanumeric, uppercase.

```
Font 3:
!"#$%&'()*+,-./0123456789:;<=>?@
ABCDEFGHIJKLMNOPQRSTUVWXYZ[\]^_`
CueaaaaaceeeeiiiIAAEæffooo
ouyOÜe£Ø×fa iouñÑ®®¿¼½¾
```

Font 4: 62-character alphanumeric, uppercase.

FONT 4:
\$ % & () * + . - / 0 1 2 3 4 5 6 7 8 9 :
A B C D E F G H I J K L M N O P Q R S T U V W X Y Z
Ç Å Ä Ö Ù £ Ø Ñ ¿ ß

Font 5: 62-character alphanumeric, uppercase.

FONT 5:
\$ % & () * + . - / 0 1 2 3 4 5 6 7 6 9 :
A B C D E F G H I J K L M N O P Q R S T U V W X Y Z
Ç Å Ä Ö Ù £ Ø Ñ ¿ ß

Font 6: 62-character alphanumeric, uppercase.

FONT 6:
\$ % & () * + . - . /
0 1 2 3 4 5 6 7 8 9 :
A B C D E F G H I J K L
M N O P Q R S T U V W X Y Z
Ç Å Ä Ö Ù £ Ø Ñ ¿ ß

Font 7: OCR-A, size I.

Font 8: OCR-B, size III.

Font 7:
 ! " # \$ % & ' () * + , - . /
 0 1 2 3 4 5 6 7 8 9 : ; < = > ? @
 A B C D E F G H I J K L M N O
 P Q R S T U V W X Y Z [\] ^ _ `
 a b c d e f g h i j k l m n o
 p q r s t u v w x y z { | } ~

Font 8:
 0 1 2 3 4 5 6 7 8 9
 < > C E N S T X Z I

Font 9: Internal Triumvirate font. The number in the bar code height field sets the point sizes. Larger point sizes can be obtained by increasing the height and width multipliers.

4 pt ABCDEFGHIJKLMNOPQRSTUVWXYZabcdefghijklmnopqrstuvwxyz0123456789
 5 pt ABCDEFGHIJKLMNOPQRSTUVWXYZabcdefghijklmnopqrstuvwxyz0123456789
 6 pt ABCDEFGHIJKLMNOPQRSTUVWXYZabcdefghijklmnopqrstuvwxyz0123456789
 8 pt ABCDEFGHIJKLMNOPQRSTUVWXYZabcdefghijklmnopqrstuvwxyz0123456789
 10 pt ABCDEFGHIJKLMNOPQRSTUVWXYZabcdefghijklmnopqrstuvwxyz0123456789
 12 pt ABCDEFGHIJKLMNOPQRSTUVWXYZabcdefghijklmnopqrstuvwxyz0123456789
 14 pt ABCDEFGHIJKLMNOPQRSTUVWXYZabcdefghijklmnopqrstuvwxyz0123456789
 18 pt ABCDEFGHIJKLMNOPQRSTUVWXYZabcdefghijklmnopqrstuvwxyz0123456789
 24 pt ABCDEFGHIJKLMNOPQRSTUVWXYZabcdefghijklmnopqrstuvwxyz0123456789
 30 pt ABCDEFGHIJKLMNOPQRSTUVWXYZabcdefghijklmnopqrstuvwxyz0123456789
 36 pt ABCDEFGHIJKLMNOPQRSTUVWXYZabcdefghijklmnopqrstuvwxyz0123456789
 48 pt ABCDEFGHIJKLMNOPQRSTUVWXYZabcdefghijklmnopqrstuvwxyz0123456789
 72 pt AB

Bar Code Summary Data

Bar Code fonts have alpha names (left column in the table below). Uppercase alpha names will print barcodes with human-readable interpretations. Lowercase alpha names will print barcodes only. The table is followed by visual samples.

Bar Code ID	Type	Length	Checksum	Valid ASCII Characters, decimal value representation
A	Code 3 of 9	Varies	No	32, 36, 37, 42, 43, 45-57, 65-90
B	UPC-A	11	Yes	48-57 Numeric only. Option V used in the 6th & 7th position
C	UPC-E	6	Yes	48-57 Numeric only
D	Interleaved 2 of 5 (I 2 of 5)	Varies	No	48-57 Numeric only
E	Code 128	Varies	M-103	32-127
F	EAN-13	12	Yes	48-57 Numeric only. Option V used in the 7th & 8th position
G	EAN-8	7	Yes	48-57 Numeric only
H	HBIC	Varies	M-43	32, 36-39, 42, 43, 45-57, 65-90
I	Codabar	Varies	No	36, 43, 45-58, 65-68
J	Interleaved 2 of 5 with a modulo 10 checksum	Varies	M-10	48-57 Numeric only
K	Plessey	Up to 14	M-10	48-57 Numeric only. Option + is Last Character for Second M-11 Checksum
L	Interleaved 2 of 5 with a modulo 10 checksum & shipping bearer bars	13	M-10	48-57 Numeric only
M	2 digit UPC addendum	2	Yes	48-57 Numeric only
N	5 digit UPC addendum	5	Yes	48-57 Numeric only
O	Code 93	Varies	No	35-38, 42-58, 65-90, 97-122
p	Postnet	Varies	Yes	48-57 Numeric only
Q	UCC/EAN Code 128	19	Yes	48-57 Numeric only
R	UCC/EAN Code 128 K-Mart NON EDI barcode	18	Yes	48-57 Numeric only
S	UCC/EAN Code 128 Random Weight	34 +	Yes	48-57 Numeric only
T	Telepen	Varies	Yes	Alphanumeric
U	UPS MaxiCode	84	Yes	Alphanumeric
v	FIM	1	No	A, B, C, D
z	PDF-417	Varies	Yes	All
WG	USD-8 (Code 11)	Varies	Yes	45, 48-57
W1c	DataMatrix	Varies	Yes	All 8-bit values
W1d	QR Code – Auto format	Varies	Yes	Alphanumeric
W1D	QR Code – Manual format	Varies	Yes	Single byte or Kanji double byte
W1f	Aztec	Varies	Yes	All
W1z	MicroPDF417	Varies	Yes	All



0123456789

Bar Code A: Code 3 of 9



0 12345 67890 5

Bar Code B: UPC-A



0 012345 7

Bar Code C: UPC-E



0123456790

Bar Code D: Interleaved 2 of 5



01234567890

Bar Code E: Code 128



0 123456 7890 12

Bar Code F: EAN-13



0123 4565

Bar Code G: EAN-8



*012345678900

Bar Code H: Health Industry Bar Code (HBIC)



0012345678900

Bar Code I: Codabar



012345678905

Bar Code J: Interleaved 2 of 5 w/modulo 10 checksum



0 1234567890

Bar Code K: Plessey

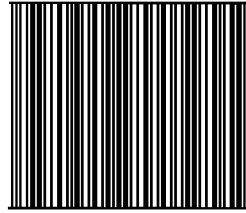

0 12 34567 89012 8

Bar Code L: Interleaved 2 of 5
w/modulo 10 checksum and
shipping bearer bars



42

Bar Code M: 2 Digit UPC addendum

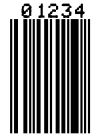

0 1234

Bar Code N: 5 Digit UPC addendum



Bar Code O: Code 93



Bar Code p: Postnet



(01) 2 3456789 012345678 9

Bar Code Q: UCC/EAN Code 128

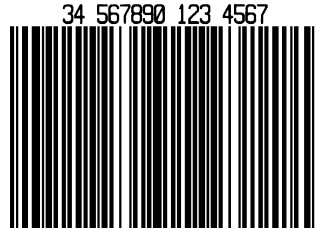

34 567890 123 4567

Bar Code R: UCC/EAN Code 128
KMART NON EDI



Bar Code S: UCC/EAN Code 128
Random Weight



Bar Code T: Telepen

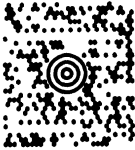

Bar Code u: UPS MaxiCode



Bar Code v: FIM



Bar Code z: PDF-417



Bar Code WG: USD-8



Bar Code W1c: DataMatrix



Bar Code W1d: QR Code



Bar Code W1f: Aztec



Bar Code W1z: MicroPDF417



Appendix C

Module Assignments

Memory Module			
Designator	Module Size	Volatile*	Location / Use
A	Future Option	N/A	N/A
B	Future Option	N/A	N/A
D	1024 KB (default size)	Yes	Main PCB SDRAM – user addressable for graphics, fonts, and label formats
F	4 MB	No	Optional Flash Card – user addressable for graphics, fonts, and label formats
G	256 KB	No	Main PCB Flash – user addressable for graphics, fonts, and label formats (unavailable on the 2461 model).
Y	64 KB	No	Main PCB Flash – reserved for EFIGS
Z	4 MB	No	Optional Flash Card – reserved for ILPC

*When power is removed from the printer, stored data will be lost.

Print Resolutions and Maximum Label Widths

Resolutions and Widths				
Model	Printhead Resolution	Maximum Print Width		Factory Default Setting
		Inches	Millimeters	
2461	203 dots/inch (8 dots/mm)	4.10	104	4.10
3481	300 dots/inch (11.8 dots/mm)	4.16	105.7	4.16
6441	600 dots/inch (23.6 dots/mm)	4.16	108.2	4.16

Available Speeds and Default Settings

Model		Printer Speed Ranges and Defaults*			
		Speed Range		Default Setting	
		IPS	MMPS	IPS	MMPS
2461	Print	2-8	51 – 203	8.0	203
	Feed	2-8	51 – 203	8.0	203
	Reverse	2-4	51 – 102	4.0	102
3481	Print	2-8	51 – 203	6.0	152
	Feed	2-10	51 – 254	6.0	152
	Reverse	2-4	51 – 102	4.0	102
6441	Print	2-4	51 – 102	3.0	76
	Feed	2-4	51 – 102	4.0	102
	Reverse	2-4	51 – 102	4.0	102

*Consult the *Programmer's Manual* for detailed information.



Appendix D

GPIO Port Description

With the optional GPIO PCB, the printer can easily be programmed to interface with most applicator devices. The GPIO functions are enabled and configured using the menu system of the printer (see Section 4.1.4). These parameters are stored in non-volatile memory and saved for subsequent power-ups.

When the GPIO is enabled, the printer will not print a label unless the Start of Print signal is active. When a label is ready to print and the printer is waiting for the Start of Print signal the printer will display “WAITING FOR SIGNAL”.

GPIO Port Connections

The external connection (see next page) is a 9-pin Mini-DIN Female connector (for example, KYCON KMDG-9S-BS). Each pin function is detailed in the table below:

GPIO Pin Functions				
Pin #	Signal Name	Signal State	Signal Direction*	Description
1	Vcc	+5 VDC	Output	Printer +5 VDC
2	Ribbon Fault	Low	Output	Goes low when the printer detects a ribbon fault.
3	Paper Fault	Low	Output	Goes low when the printer detects a label movement fault.
4	Printer Fault	Low	Output	Goes low when any printer fault is detected.
5	Spare	Reserved	Output	N/A
6	End of Print	Programmable	Output	Programmable
7	Spare	Reserved	Input	N/A
8	Start of Print Signal	Low	Input	When ready to print a label, the Applicator should set this signal low for at least 50ms or until the End of Print signal goes not active.
9	Signal Ground	Ground	N/A	N/A

*Signal direction is given relative to the printer.

GPIO Pin Configuration

(as viewed from the rear of the printer)

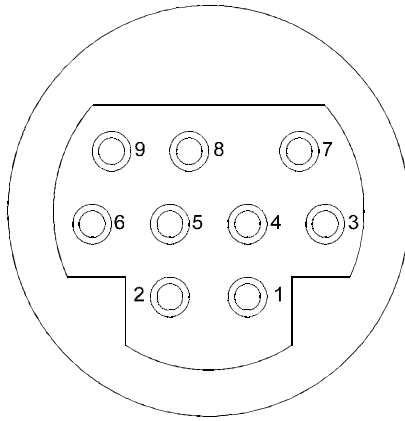

External Start of Print Control

Connections for an external Start of Print control can be made (1) directly to Pin 8 using a TTL-level input or (2) with an interface circuit similar to the one shown right. For additional interfacing requirements, see the table below.

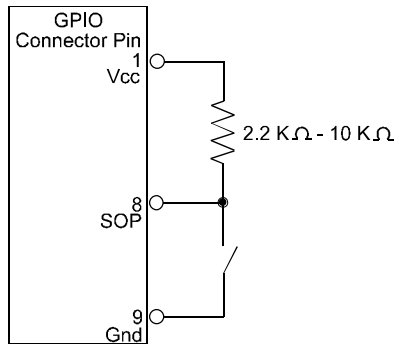

GPIO Port Specifications*

$V_{in\ max}$	5.5 VDC maximum input into any pin
V_{IH}	3.8 VDC minimum (high level input voltage)
V_{IL}	1.65 VDC maximum (low level input voltage)
I_{OH}	-8 mA typical, - 25 mA maximum (high level output current)
I_{OL}	8 mA typical 25 mA maximum (low level output current)
V_{OH}	$I_{OH} = -8\ mA$, minimum 3.8 VDC
V_{OL}	$I_{OL} = 8\ mA$, maximum .44 VDC

*See the SN74AHC244 data sheet for more information.



Appendix E

Menu System Multi-Language Support

This printer provides the user with the ability to download new menu system languages and/or replace the provided translations. A Microsoft® Excel Spreadsheet defines the menu dictionary – the user adds a new language column or modifies an existing column in the spreadsheet, clicks on the ‘Generate DPL file(s)’ radio button and sends the generated DPL file(s) to the printer.

Here are the highlights and restrictions of the feature:

- The printer can register up to 10 different display languages, including EFIGS.
- The EFIGS languages and any additional languages are stored on Module Y: a 64KB Flash Module located on the Main PCB.
- It is okay to download menu files generated for a lesser firmware revision to new firmware – any messages that are not defined are displayed in English.
- For the procedures below, the printer will accept the menu downloads from any available port.
- The language creation programs support Windows® 95, Windows® 98, Windows® NT, and Windows® 2000.

Required Software	Comment
Application Version 3.0 or greater*	Must reside in the target printer. (See Section 5.4 for details.)
Microsoft® Excel 97	Must be purchased by user.
Img2dl.exe**	Program used during the process to create DPL file.
Gemmsgxls.xls**	Menu Dictionary

* Available from our web site

**Recommended that the Img2dl.exe and Gemmsgxls.xls files reside in the same directory.

Creating a Menu Language:

- 1 Invoke Excel and open the gemmsglst.xls file. Excel opens the file and the following screen appears.

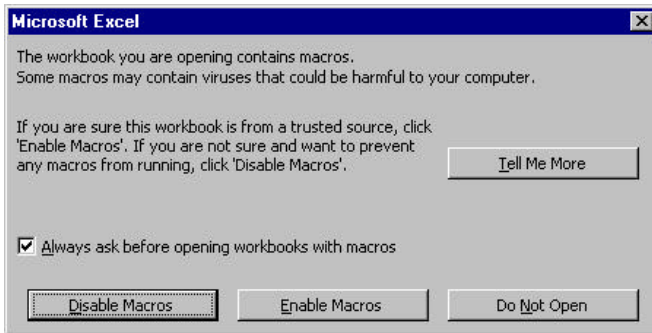

- 2 Click the “Enable Macro” box and the following appears:

	MAX	MESSAGE ID	ENGLISH	FRANCAIS	ITALIANO
3	0003	System Messages			
4	0001	20 MID_READY	READY	PRÊT	PRONTO
5	0002	20 MID_PRINTING	PRINTING		
6	0003	20 MID_PAUSED	PAUSED	PAUSE	IN PAUSA
7	0004	20 MID_CANCEL_PRINT_JOB	CANCEL PRINT JOB?		
8	0005	20 MID_CLEARING_FAULTS	CLEARING FAULTS		CANCELLA ERRORI
9	0006	20 MID_OF	OF	DE	DI
10	0007	20 MID_DOTCHECK_IN_PROGRESS	DOTCHECK IN PROGRESS		
11	0008	20 MID_SYSTEM_FAULT	SYSTEM FAULT	DEFAILLANCE SYSTEME	ANOMALIA SISTEMA
12	0009	20 MID_ADC_FAULT	ADC FAULT	DEFAILLANCE ADC	ANOMALIA ADC
13	0010	20 MID_HEAD_UP_FAULT	HEAD UP FAULT	TETE NON VERTICALEE	ASOM TESTINA ALTA
14	0011	20 MID_RIBBON_FAULT	RIBBON FAULT	DEFAILLANCE RIBBON	ANOMALIA NASTRO
15	0012	20 MID_TOP_OF_FORM_FAULT	TOP OF FORM FAULT	DEFILEE IDENT D'IMP	ANOMALIA BORDO SUP
16	0013	20 MID_OUT_OF_STOCK	OUT OF STOCK	RIPITURE PAPIERE	ESAUITO
17	0014	20 MID_CUTTER_FAULT	CUTTER FAULT	DEFAILLANCE COUPEAU	ANOMALIA TAGLIERINA
18	0015	20 MID_VERIFIER_FAULT	VERIFIER FAULT	DEFAILLANCE VERIFICATE	ANOMALIA VERIFICAT
19	0016	20 MID_RIBBONSAVER_FAULT	RIBBONSAVER FAULT	DEFAIL ECONOM ROBASSON	SALVA-NASTRO
20	0017	20 MID_POSITION_FAULT	POSITION FAULT	DEFAILLANCE POSITION	ASOM POSIZIONANEN
21	0018	20 MID_TEMPERATURE_FAULT	TEMPERATURE FAULT	DEFAILLANCE DMS	ANOMALIA DMS
22	0019	20 MID_DNA_FAULT	DNA FAULT	DEFAILLANCE MOTEUR	
23	0020	20 MID_PRINT_ENGINE_FAULT	PRINT ENGINE FAULT	DEFAILLANCE TOLLEBAN	24V OUT OF TOLERANCE
24	0021	20 MID_STROKE_TYING_FAULT	STROKE TYING FAULT	DEFAIL BURGE D'IMPRISSION	FAUAT STROE
25	0022	Warning		AVERTISSEMENT RESOLU	AVVERTENZA RISOLTA
26	0023	20 MID_RIBBON_LOW	RIBBON LOW	RIBBON FAIBLE	NASTRO BASSO
27	0024	20 MID_GAP_MISSED	GAP MISSED	INTERVALLE MANQUANT	INTERVALLO SALTATO
28	0025	20 MID_DOT_FAILURE	DOT FAILURE	DEFAUT IMPRESSION	ANOMALIA PUNTO
29	0026	20 MID_BAD_SENSOR_DELTA	BAD SENSOR DELTA		
30	0027	20 MID_HOST_CHANGES_PENDING	HOST CHANGES PENDING		MOD. HOST IN ATTES
31	0028	20 MID_LOW_VOLTAGE	LOW VOLTAGE		
32	0029	20 MID_GOODBYE	GOODBYE		
33	0030	Conditions			
34	0031	20 MID_REMOVE_LABEL	REMOVE LABEL	ENLEVER ETIQUETTE	REMOVI ETICHETTA
35	0032	20 MID_TRANSMISSION FAULT	TRANSMISSION FAULT		

- 3 Click On Column J and enter your new language, or modify an existing one.

Tips:

- A) Message Size – When entering new messages, reference the ‘MAX’ column: this is the maximum number of characters allowed for this field. Warnings are displayed when the number of characters is exceeded or when trying to modify the MAX value. Beware that “cutting” and “pasting” fields could defeat this warning system.
- B) Two Line Messages – Some of the message are displayed as two lines. These are indicated in the comment fields.
- C) Comments – This field can be modified with no effect.

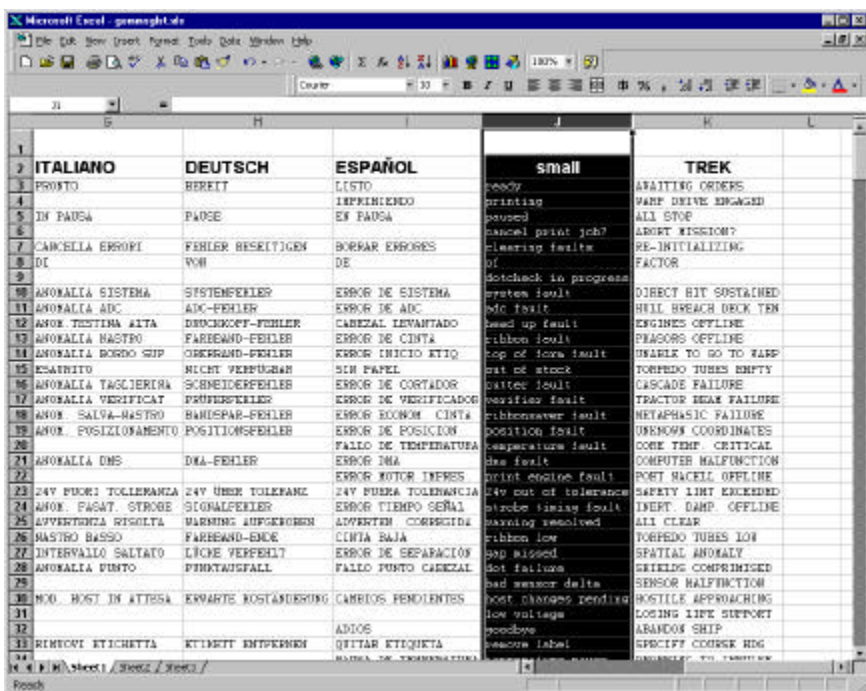

- 4 When editing has been completed, highlight all of the columns you desire to create (more than one language may be selected) by pressing the letter above the column.

- 5 Press the Generate DPL File(s) radio button. A file will be generated for each of the selected columns and Excel will provide confirmation. (Example: small.ls)

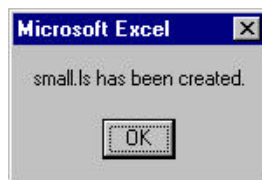

- ⑥ Download the generated files to the printer – one method is the DOS copy command:

```
copy small.ls lpt1: /b
```

- ⑦ Reset the printer by pressing and holding the CANCEL key for approximately four seconds.
- ⑧ Verify the operation by printing a Configuration Label (see Section 4.3.2). The new font selection will be printed on the label under SYSTEM INFORMATION / OPTIONAL LANGUAGES or select the new language in the SYSTEM SETTINGS / MENU LANGUAGE in the printer’s menu.

This is the only method to determine whether the download was successful. If the menu system displays the new language selection, but all displayed messages remain in English an error has occurred. Re-check the process. Contact Technical Support if problems continue (be prepared to provide the Gemmsglst.xls and the DPL download file that you have created). Other possible error messages are as follows:

Menu Language Error Message	Description
Please select the entire column(s) or the desired language(s), by clicking on the column letter(s)	After pressing the Generate DPL File(s) radio button, the languages to convert were not correctly selected.
Message text may not exceed MAX = xx designated characters for this MID	The entered message exceeds the number of characters specified in column C. You may not modify this number.

Advance File Handling Information

- The Standard Printer leaves the factory with EFIGS loaded into module Y. At this point, Module Y is LOCKED and will only accept additional Language Downloads.
- After downloading a language update, Module Y is left UNLOCKED until the printer is reset or power is cycled. In this state, Module Y will accept font, image and label format downloads. The module will also honor the Clear Module request. Therefore, following an update it is recommended that a reset be performed to lock the module; otherwise, a software package may ‘Clear All Modules’ thus destroying the new menu language(s).
- Module Y can be UNLOCKED by sending this DPL string: <STX>KpY0.

- To restore the factory generated EFIGS image, download the file *832296.01A to the printer. This file is located on our web site. The letter at the end of the file name (e.g., A) specifies the revision.
- Downloading the same language twice will automatically delete the first occurrence, but will not free the memory space. Use the Pack Module feature (see Section 4.1.4) or reload the FIGS file to free the space.
- Deletion of the selected language will set the printer to English.
- The total number of languages that the printer can now accept is limited to 10, but this number is dependent upon the size of each language translation. The translation size will vary with the number of messages that are translated for that particular language. Current complete language files are about 7,000 bytes each but with product growth, the total number of languages is expected to drop to seven.



Appendix F

Saving a Configuration File

With application version 5.01, the printer can save and restore complete printer settings, including media calibration parameters, as internal Configuration Files. Here are the highlights and restrictions of this feature:

- Configuration files eliminate the need to repeat the manual steps of a special printer setup, making future changeovers faster and easier.
- Configuration files can be setup, saved, and restored either from the host or via the front panel as 'C-type' files on Module Y under unique filenames that can be up to nineteen characters in length.
- Configuration files enable the host, via special DPL commands, to control parameters previously accessible only from the front panel (consult the *Programmers Manual* for details).
- Regular host settings can not be saved using the front panel menu.

Note: Configuration files will typically correspond to a particular printer and media application. If a file will be shared among printers, do not include unique parameters (such as calibrations and adjustments) because those settings will vary from one unit to another.

When using the front panel to save a configuration file (see Section 4.1.5), the keypad functions within the 'Save Setting As' submenu are as follows:

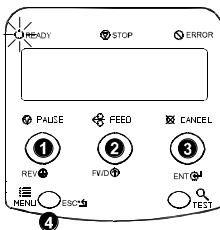

1 REV

The DOWN ARROW key scrolls down through the alphanumeric, underscore, and delete character.

2 FWD

The UP ARROW key scrolls up through the alphanumeric and underscore characters, and the delete function.























3 ENT

The ENTER key accepts the displayed character and advances the cursor.

4 ESC

Saves the displayed file.

To save a manually entered setup (for example, an application that required an Advanced Entry Calibration before beginning) as a configuration file using the front panel:

Step	Displayed Message	Operator Action	Comment(s)
1		 Press the MENU key.	You are entering 'Menu Mode'.
2		Use the FWD  key to scroll to 'System Settings'.	The REV  key can also be used.
3		Press the ENT  key to select 'System Settings'.	You are entering the 'System Settings' menu.
4		Press the ENT  key to select 'Configuration File'.	You are entering the 'Configuration File' submenu.
5		Press the FWD  key to scroll to 'Save Setting As'.	The REV  key can also be used.
6		Press the ENT  key.	Press the ESC  key to exit this selection.
7		Enter a file name using the REV  key to scroll through the characters.	The FWD  key can also be used.
		<input checked="" type="checkbox"/> Note: To change an accepted character, select the delete function (solid flashing block) and press the ENTER key.	
8		Use the ENT  key to accept the character.	Continue entering the file name in this manner ("SPECIAL STOCK" has been used as an example).
		<input checked="" type="checkbox"/> Note: To abort the "save setting" function, delete all entered characters in the file name and press the ESCAPE key.	
9		Press the ESC  key repeatedly to save the file name and return to 'Ready'.	Save complete. (To restore a saved file using the front panel see Section 4.1.5.)



Warranty Information

Brady Products Limited Warranty Statement

Bradyprinter Models 2461 and 3481

Printer

Brady warrants to Purchaser that under normal use and service, the 2461, 3481 and 6441 Printers, (with the exception of the thermal printhead) purchased hereunder shall be free from defects in material and workmanship for a period of (365) days from the date of shipment by Brady.

Expendable and/or consumable items or parts such as lamps, fuses, labels and ribbons are not covered under this warranty. This warranty does not cover equipment or parts which have been misused, altered, neglected, handled carelessly, or used for purposes other than those for which they were manufactured. This warranty also does not cover loss, damages resulting from accident, or damages resulting from unauthorized service.

*When returned to the factory for service.

Thermal Printhead, Platen Roller, and Belts

This warranty* is limited to a period of one year, (365 days), or one million (1,000,000) linear inches of use, whichever comes first, for the 2461, 3481 or 6441 thermal printhead, platen roller, and belts. This one year (365 days) warranty is valid only if a Brady - approved thermal label media is used, as defined in the then current list of approved thermal/thermal transfer media, a copy of which is available from Brady. Failure to use Brady -approved media is justification for invalidation of this warranty. This warranty does not cover printheads or platen rollers which have been misused, altered, neglected, handled carelessly, or damaged due to improper cleaning or unauthorized repairs.

*When returned to the factory for service

Warranty Service Procedures

If a defect should occur during the warranty period, the defective unit shall be returned, freight and insurance prepaid, in the original shipping containers, to Brady at: 6555 W. Good Hope Road, Milwaukee, Wisconsin, 53223. A Return Material Authorization (RMA) number must be issued before the product can be returned. To open an RMA please call the Brady Customer Service Department at 1-800-537-8791. Please include your RMA number on the outside of the box and on the shipping document. Include a contact name, action desired, a detailed description of the problem(s), and examples when possible with the defective unit. Brady shall not be responsible for any loss or damages incurred in shipping. Any warranty work to be performed by Brady shall be subject to Brady's confirmation that such product meets Brady warranty. In the event of a defect covered by its warranty, Brady will return the repaired or replaced product to the Purchaser at Brady's cost.

With respect to a defect in hardware covered by the warranty, the warranty shall continue in effect until the end of the original warranty period, or for sixty (60) days after the repair or replacement, whichever is later.

General Warranty Provisions

Brady makes no warranty as to the design, capability, capacity or suitability of any of its hardware, supplies, or software.

Software is licensed on an “as is” basis without warranty. Except and to the extent expressly provided in this warranty and in lieu of all other warranties, there are no warranties, expressed or implied, including, but not limited to, any warranties of merchantability or fitness for a particular purpose.

Purchaser shall be solely responsible for the selection, use, efficiency and suitability of Brady’s products.

Limitation of Liability

In no event shall Brady be liable to the purchaser for any indirect, special or consequential damages or lost profits arising out of or relating to Brady’s products, or the performance or a breach thereof, even if Brady has been advised of the possibility thereof. Brady’s liability, if any, to the purchaser or to the customer of the purchaser hereunder shall in no event exceed the total amounts paid to Brady hereunder by the purchaser for a defective product.

In no event shall Brady be liable to the purchaser for any damages resulting from or related to any failure or delay of Brady in the delivery or installation of the computer hardware, supplies or software or in the performance of any services.

Some states do not permit the exclusion of incidental or consequential damages, and in those states the foregoing limitations may not apply. The warranties here give you specific legal rights, and you may have other legal rights which vary from state to state.



Glossary

alphanumeric Consisting of alphabetic, numeric, punctuation and other symbols.

backing material The silicon-coated paper carrier material to which labels with adhesive backing are affixed. Also referred to as “liner”.

bar code A representation of alphanumeric information in a pattern of machine-readable marks. The basic categories are divided into one-dimensional (UPC, Code 39, Postnet, etc.) and two-dimensional barcodes (Data Matrix, MaxiCode, PDF417, etc.).

boot loader The resident program that loads the application from Flash memory, decompresses it into the SRAM, and starts operations.

burn line The row of thermal elements in the printhead that create the images on the media.

calibration The process through which sensor readings are entered into the printer for correct sensor function (for example, detection of a given media type) and TOF positioning.

character set The entire complement of alphanumeric symbols contained in a given font.

checksum An alphanumeric error detection method used in many bar code symbologies for informational security.

continuous media An uninterrupted roll or box of label or tag stock media that contains no gap, notch, or mark to separate individual labels or tags.

core diameter The inside diameter measurement of the cardboard core at the center of a ribbon or media roll.

cutter A mechanical device with a rotary or guillotine type blade used to cut labels or tags following printing.

- defaults** The functional setting values returned following a factory reset of the printer.
- diagnostics** Programs used to locate and diagnose hardware problems.
- die-cut media** Media that has been cut into a pattern using a press, where the excess paper is removed leaving individual labels, with gaps between them, attached to a backing material.
- direct thermal** The printing method that uses a heat sensitive media and only the heat of the thermal printhead to create an image on the label.
- direct thermal media** Media coated with special chemicals that react and darken with the application of heat.
- DPI (dots per inch)** A measurement of print resolution, rated in the number of thermal elements contained in one inch of the printhead. Also referred to as “resolution”.
- DPL** programming commands used specifically for control of and label production. A complete listing of commands can be found in the *Programmer’s Manual*.
- EFIGS** English, French, Italian, German, Spanish, and other multi-language support as programmed for the printer’s menu system and configuration label.
- fan-fold** Media that is folded and stacked.
- feed speed** The speed at which the media moves under the printhead in non-printed areas and between labels.
- Flash memory** Non-volatile memory (does not require printer power to maintain data) that can be erased and reprogrammed, used to hold the printer’s operating program.
- font** A set of alphanumeric characters that share a particular typeface.
- gap** A space between die-cut or notched labels used to sense the top-of-form.
- IPS (inches per second)** Imperial measurement of printer speeds.

- label** A paper or synthetic printing material, typically with a pressure sensitive adhesive backing.
- label length** The distance from the top of the label to the bottom of the label as it exits the printer.
- label repeat** The distance from the top of one label to the top of the next label.
- label tracking** Excessive lateral (side to side) movement of the media as it travels under the printhead.
- label width** The left to right measurement of the label as it exits the printer.
- media** Generalized term for all types of printing stocks, including: roll fed, continuous, die-cut, reflective, and fanfold.
- media hub** Device in the printer used to support roll media.
- media sensor** An electronic device equipped with photosensors to detect media and the top-of-form on die-cut, notched or reflective media.
- MMPS (millimeters per second)** Metric measurement of printer speeds.
- notched stock** Media, typically tag stock, with holes or notches in the material that is used to signal the top-of-form. The printer must be set to 'gap' to use this media type.
- preprinted media** Label stock that contains borders, text, or graphics, floodcoating, etc.
- perforation** Small cuts extending through the backing and/or label material to facilitate their separation. Also referred to as "perf".
- print speed** The speed at which the media moves under the printhead during the printing process.
- reflective media** Media imprinted with carbon-based black marks on the underside of the material, which is used to signal the top-of-form when the 'reflective' sensor is enabled.
- registration** Repeatable top to bottom alignment of printed labels.

reverse speed The backward rate of media motion into the printer during tear-off, peel and present and cutting operations for positioning the label at the start of print position.

ribbon An extruded polyester tape with several layers of material, one of which is ink-like, used to produce an image on the label. Also referred to as “foil”.

ribbon wrinkle An undesirable overlapping of the ribbon during the printing process that leads to voids on the printed label, typically caused by an improper printhead leveling cam adjustment.

roll media A form of media that is wound upon a cardboard core.

start of print The position on the label where the printing actually begins.

tag stock A heavy paper or synthetic printing material, typically featuring a notch or black mark for TOF and no adhesive backing.

thermal transfer The printing method that creates an image by transferring ink from a ribbon onto the media using the heat from the thermal printhead.

TOF (top-of-form) The start of a new label as indicated by a label gap, notch, mark or programming.

void An undesirable blank space in a printed image.



Index

A

alphanumeric, *125*
application program, *77*
ASCII, *93, 99 - 101, 105*

B

bar code, *84, 86, 95, 105 - 108, 125*
boot loader, *79 - 81, 125*
burn line, *72, 75, 86, 125*

C

cable listings, *12, 13*
calibration
 advanced entry, *34, 65 - 70*
 defined, *125*
 problems, *55, 83, 86, 88 - 90*
 quick media, *20, 27, 54*
 standard, *31, 34, 61 - 64*
checksum, *105 - 107, 125*
cleaning, *59, 74 - 77, 86*
communications
 menu settings, *47 - 52*
 methods, *12, 13, 95*
 problems, *80, 83, 84, 86*
condition messages, *54, 55*
configuration file, *39, 119, 120*
configuration label, *29, 43, 46, 48, 57, 126*
configuration level, *41, 80*
core diameter, *14, 90, 97, 125*
custom adjustments, *10, 36, 42, 73, 84*
cutter, *2, 5, 25, 38, 46, 53, 74, 83, 87, 97, 98, 125*

D

diagnostics, *53, 126*
direct thermal printing, *9, 34, 96, 126*
display, *30, 83, 87, 92*
dot test pattern label, *59*
double byte symbols, *40, 105*

download mode, *77, 79, 80*
DPI, *44, 45, 96, 109, 126*
DPL, *33, 41, 44, 45, 52, 93, 126*

E

EFIGS, *2, 46, 77, 109, 113 - 117, 126*
emulation, *44 - 46*

F

factory default settings, *31, 32, 34 - 53, 91, 109, 110, 126*
fault messages, *87 - 91*
feed speed, *35, 110, 126*
flash memory, *97, 109, 126*
font, *2, 3, 37, 39 - 41, 51, 95, 101 - 109, 126*

G

gap, *17, 20, 34, 53, 63 - 65, 88, 92, 98, 125 - 128*
GPIO port, *38, 46, 53, 111, 112*

H

hex dump mode, *53, 83, 93*

I

indicators, *12, 30, 85, 87*
IPS, *10, 96, 110, 126*

L

liner. *See Media Backing Material*
label, *1, 8, 9, 21, 42 - 46, 51, 53 - 61, 84, 86, 91, 93, 97, 98, 109, 125 - 128*
language. *See EFIGS*
LCD. *See Display*
leveling cam, *15, 16, 71, 84, 86, 91, 128*

M

media

continuous, 17, 20, 34, 97, 125
backing material, 18, 20, 21, 23 - 25,
61, 64, 97, 98, 125, 126
black mark, 17, 61, 63, 67, 89, 98,
127, 128
die-cut, 17, 97, 126
direct thermal, 9, 10, 34, 126
fan-fold, 16, 97, 126
preprinted, 63, 66, 127
notched, 17, 20, 64, 127, 128
roll, 14, 15, 97, 128
tag, 10, 72, 125, 127, 128
thermal transfer, 9, 10, 18, 34, 58,
96, 128

media sensor, 17, 20, 34, 74, 86, 88 -
91, 98, 127

media settings, 34

menu mode, 27, 28, 30, 33

menu system, 32, 33

MMPS, 96, 110, 127

module, 37, 39, 60, 84, 109

N

NIC Adapter, 12, 48 - 50

P

parallel port, 12, 47, 48, 79, 83, 95

peel and present, 3, 4, 23, 97

perforation, 63, 66, 67, 127

present sensor, 4, 24, 35, 37, 46, 53, 54

print control, 9, 10, 35, 36, 73, 84, 112

print quality, 56, 58, 60, 72, 75, 76, 86,
92, 98

print resolutions. *See* DPI

print speed, 9, 10, 35, 86, 96, 110, 127

printer key, 41, 80

printer options, 37, 38

printhead, 2, 9, 10, 18, 35, 36, 53, 59,
71 - 75, 84, 86, 90, 92, 96, 98, 109

Q

quick test mode, 29, 53, 54, 56 - 60, 87

R

ready mode, 27, 28, 30, 77, 78, 93

reflective mark. *See* Media Black Mark
registration, 127

resetting, 12, 27, 31, 32, 39, 40, 55, 89,
92

reverse speed, 35, 52, 110, 128

ribbon, 9, 10, 18, 19, 34, 85, 86, 89, 97,
98, 128

ribbon sensor, 42, 53, 90

ribbon test label, 58

ribbon wrinkling, 71, 128

rotation, 86, 95

S

serial port, 13, 47, 83

single byte symbols, 39

skipping labels, 86

specifications, 95 - 97, 112

speed settings, 110

start of print, 17, 35, 36, 46, 111, 112,
128

system settings, 31, 39, 40 - 46, 84

T

top of form, 20, 34, 61, 65, 70, 88, 89,
91, 125, 128

troubleshooting, 83 - 93

U

user defined label, 60

user prompts, 54, 55

V

validation label, 60

voids, 77, 128

W

warning messages, 87, 92

Free Manuals Download Website

<http://myh66.com>

<http://usermanuals.us>

<http://www.somanuals.com>

<http://www.4manuals.cc>

<http://www.manual-lib.com>

<http://www.404manual.com>

<http://www.luxmanual.com>

<http://aubethermostatmanual.com>

Golf course search by state

<http://golfingnear.com>

Email search by domain

<http://emailbydomain.com>

Auto manuals search

<http://auto.somanuals.com>

TV manuals search

<http://tv.somanuals.com>