

Owner's Manual for:

UVL® Series

Under Vehicle Wheelchair Lifts

Including Models:

- **UVL603A**
- **UVL603B**
- **UVL603E**
- **UVL604XA**
- **UVL604XB**
- **UVL604XC**
- **UVL604XD**
- **UVL855R**
- **UVL855RH**

**and Special Order
UVL® Series Lift Models**



THE BRAUN CORPORATION®

"Providing Access to the World"

International Corporate Hdqrs: P.O. Box 310 Winamac, IN 46996 USA
1-800-THE LIFT (219) 946-6153 FAX: (219) 946-4670



Note to Dealer:
Provide this manual
to the consumer.

See inside cover for
warranty/registration
information.

⚠ WARNING

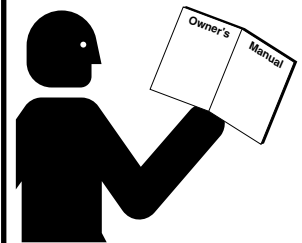

**Read manual
before operating
lift. Failure to do
so may result in
serious bodily
injury and/or
property damage.
Keep manual in
lift vehicle.**

Congratulations

We at The Braun Corporation wish to express our fullest appreciation on your new purchase. With you in mind, our skilled craftsmen have designed and assembled the finest lift available.

This manual includes safety precautions, lift operating instructions, manual operating instructions, and instructions for maintenance and lubrication procedures.

Your lift is built for dependability, and will bring you years of pleasure and independence, as long as maintenance is performed regularly and the lift is operated by an instructed person.

Sincerely,

THE BRAUN CORPORATION



Ralph W. Braun
Chief Executive Officer

Warranty/Registration Instructions

Immediately upon receiving:

Examine the unit for any damage. Notify the carrier at once with any claims.

Two warranty/registration cards (shown right) are protected in a clear envelope and attached to the lift protective shipping wrap. The sales representative must process one of the cards. The consumer must fill out the other card and mail it to The Braun Corporation. The warranty is provided on the back cover of this manual.

OWNER'S WARRANTY REGISTRATION	
PURCHASED FROM _____	
OWNER	
NAME _____	DATE INSTALLED _____
ADDRESS _____	
CITY _____	
TELEPHONE _____	STATE _____ ZIP _____
TO VALIDATE WARRANTY REGISTRATION CARDS MUST BE RETURNED TO THE BRAUN CORPORATION.	

Sample Warranty/Registration Card

The Braun Serial No./Series No. identification tag (shown below) is located on the left platform side plate (outboard end). This I.D. tag contains the product identification information provided on the Warranty/Registration card. Record the information in the space provided. This information **must** be provided when filing a warranty claim or ordering parts.

Lift Model No.

Lift Serial No.

THE BRAUN CORPORATION P.O. BOX 310 WINAMAC IN 46996 219-946-6153	
MODEL UVL603A	DOM 0597
SERIAL NUMBER OD 2632	PATENT 4,958,979

Lift Series No.

Date of Manufacture

Sample Serial No./Series No. Identification Tag

Model No. _____

Series No. _____

Serial No. _____

Date of Manufacture _____

RETAIN THIS INFORMATION FOR FUTURE USE. YOU MUST HAVE THIS INFORMATION WHEN FILING A WARRANTY CLAIM OR ORDERING PARTS!

Table of Contents

<div style="border: 1px solid black; padding: 2px; margin-bottom: 10px;">Lift Terminology</div> <p>UVL® 600 Series Lift Terminology Illustration 2</p> <p>UVL® 600X Series Lift Terminology Illustration 2</p> <p>UVL® 850 Series Lift Terminology Illustration 3</p> <p>Lift Terminology Description</p> <p style="padding-left: 20px;">General 3</p> <p style="padding-left: 20px;">Direction 3</p> <p style="padding-left: 20px;">Lift Components 4</p> <p style="padding-left: 20px;">Lift Actions and Functions 4</p> <div style="border: 1px solid black; padding: 2px; margin-top: 20px;">Lift Operation Safety</div> <p>Safety Symbols 5</p> <p>Lift Operation Safety Precautions 5-7</p> <div style="border: 1px solid black; padding: 2px; margin-top: 20px;">Pre-Lift Operation Notes</div> <p>General Safety 7</p> <p>Outboard Roll Stop 7, 8</p> <p>Bridge Plate (Inboard Roll Stop) 8, 9</p> <p>Handrails 9</p> <p>Passenger Orientation 9</p> <p>Vehicle (Floor Level) Loading/Unloading 9</p> <p>Wheelchair-equipped Occupant Seat Belts 9</p> <p>Operation Procedure Review 10</p> <p>Preventive Maintenance 10</p> <p>Cold Climate Recommendations 10</p> <div style="border: 1px solid black; padding: 2px; margin-top: 20px;">Lift Operating Instructions</div> <p>Before Lift Operation 10</p> <p>Vehicle Lift Door(s) 10</p> <p>Lift Control Switches 11</p> <p>Control Switch Functions 11</p>	<div style="border: 1px solid black; padding: 2px; margin-bottom: 10px;">Manual Bridge Plate Operating Instructions12</div> <div style="border: 1px solid black; padding: 2px; margin-bottom: 10px;">Dual Stationary Handrail Instructions13</div> <div style="border: 1px solid black; padding: 2px; margin-bottom: 10px;">Dual Manual Fold “P” Handrail Instructions13</div> <div style="border: 1px solid black; padding: 2px; margin-bottom: 10px;">Dual Manual Fold “U” Handrail (with Shield) Instructions14</div> <div style="border: 1px solid black; padding: 2px; margin-bottom: 10px;">Manual Operating Instructions</div> <p>Cable-Activated Platform Manual Release System Introduction 15, 16</p> <p>Platform Carriage Assembly Drive Chain Re-engagement Procedure 16</p> <p style="padding-left: 20px;">To Manually Move Platform Out (Extend) From Stow Position 16</p> <p style="padding-left: 20px;">To Manually Raise Platform To Floor Level 17</p> <p style="padding-left: 20px;">To Manually Lower Platform To Ground Level 18</p> <p style="padding-left: 20px;">To Manually Move Platform In (Retract) To Stow Position 19</p> <p>Outboard Roll Stop Manual Operation</p> <p style="padding-left: 20px;">Introduction 19</p> <p style="padding-left: 20px;">To Manually Lower Outboard Roll Stop 20</p> <p style="padding-left: 20px;">To Reengage Outboard Roll Stop 20</p> <div style="border: 1px solid black; padding: 2px; margin-top: 20px;">Maintenance and Lubrication 21</div> <div style="border: 1px solid black; padding: 2px; margin-top: 20px;">Decals 22</div> <div style="border: 1px solid black; padding: 2px; margin-top: 20px;">Warranty/Registration Policy23</div> <div style="border: 1px solid black; padding: 2px; margin-top: 20px;">Return Authorization Procedure 23</div>
---	--

Lift Terminology

UVL®600 Series Lift Terminology Illustration

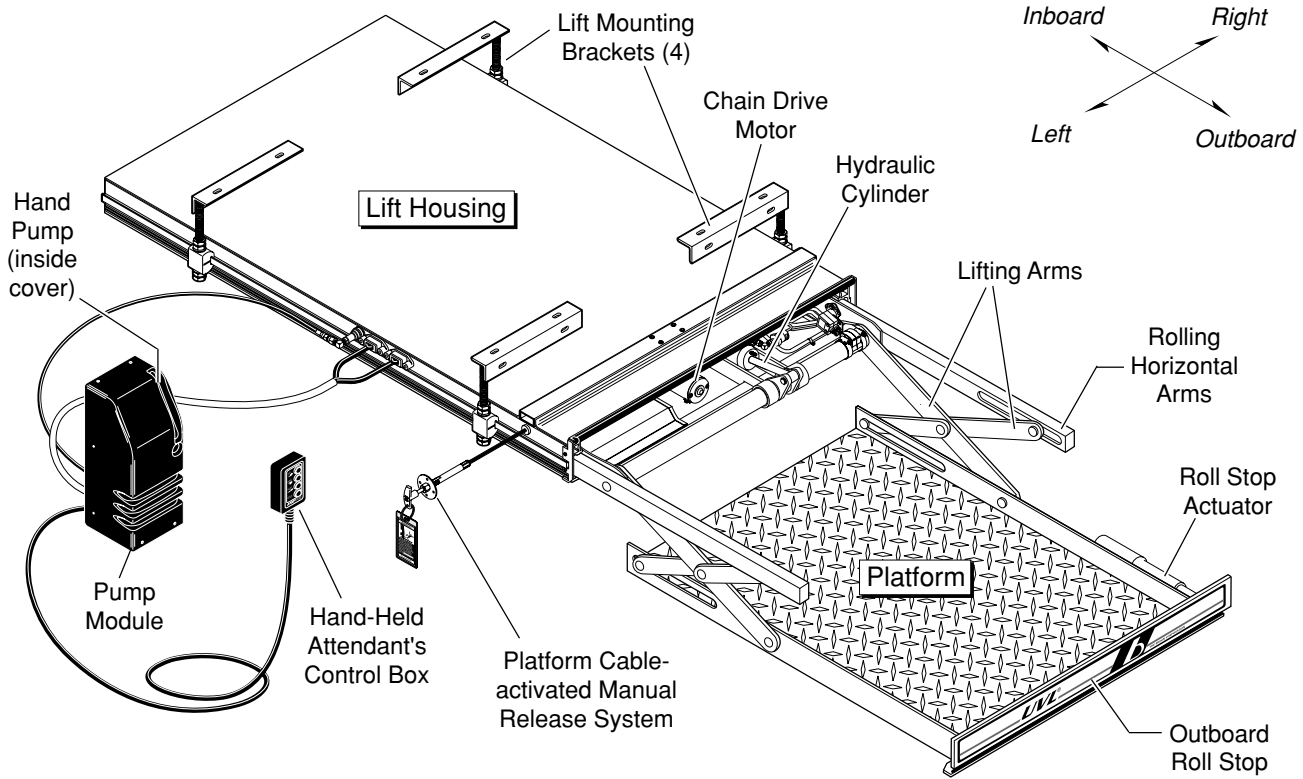

UVL®600X Series Lift Terminology Illustration

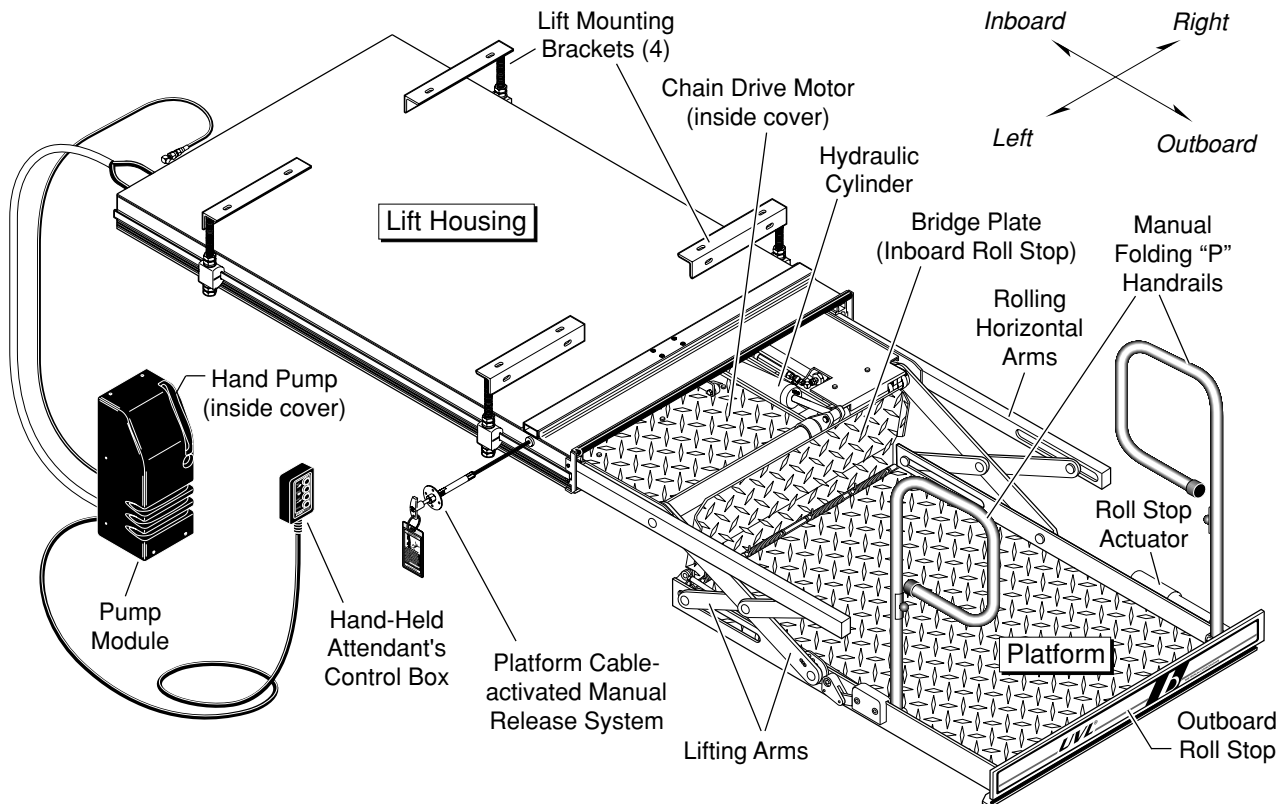

Lift Terminology

UVL®850 Series Lift Terminology Illustration

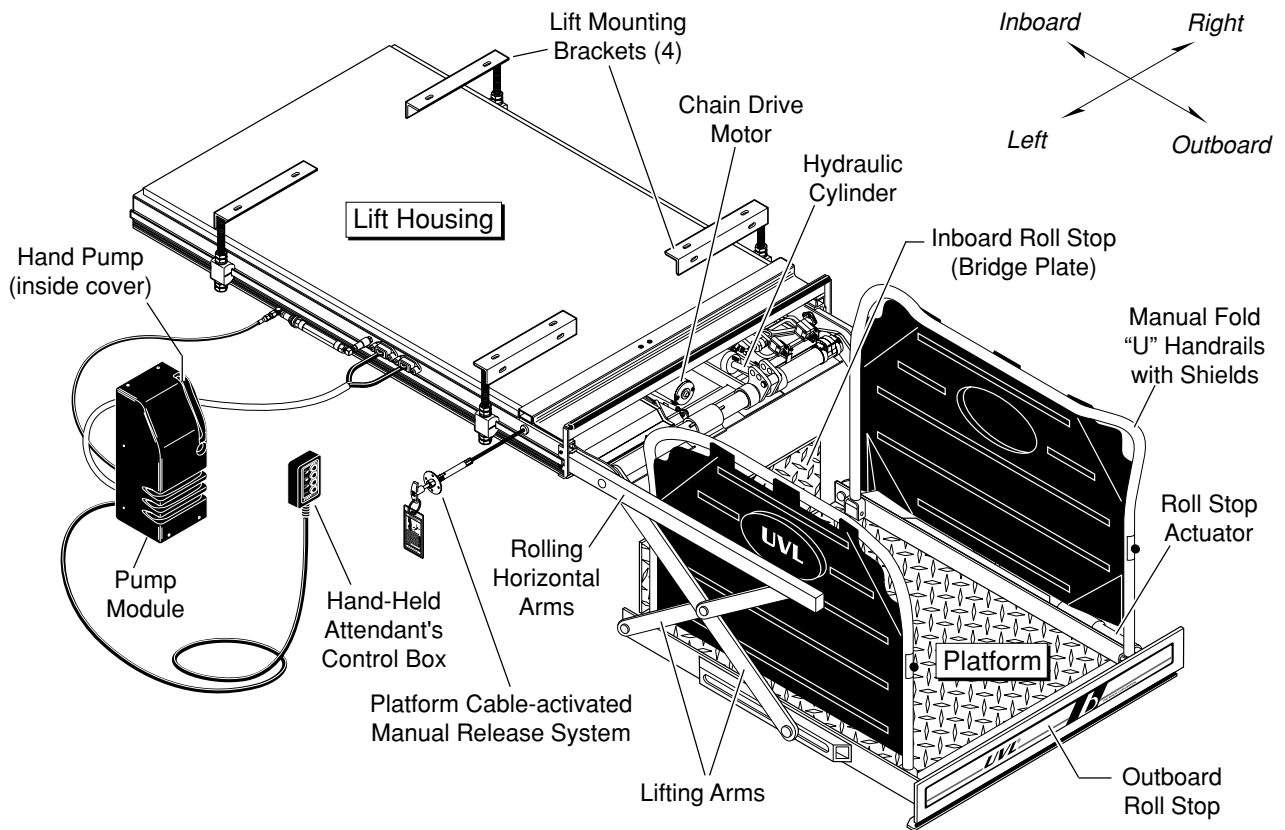

Lift Terminology Description

The UVL Lift Series includes three classifications of lifts (UVL600 Series, UVL600X Series and UVL850 Series). Refer to the illustrations on pages 2 and 3 for the visual differences in lift configurations and identification of lift components.

UVL600 Series lift models are consumer oriented (intended for operation by the wheelchair passenger). UVL600X lift models are commercial oriented and ADA compliant (intended for operation by an attendant). UVL600 Series and UVL600X lift platforms raise and lower with an "arcing" motion. UVL600 Series lifts offer a variety of **options** including bridge plates (inboard roll stops) and handrails.

UVL850 Series lifts are commer-

cial oriented, ADA compliant and designed for use in vehicles with increased floor-to-ground requirements such as buses, trailers and motor homes. UVL850 lift platforms travel vertically straight up and down (no "arcing" motion).

UVL lift models provide fully automatic operation of all lift functions as well as **optional** automatic door operators (if so equipped). Basic lift operation procedures are identical for all UVL Series lift models. The operating instructions contained in this manual address the lift control switches and the corresponding lift functions. Separate instructions are provided for operation of manual bridge plates (inboard roll stops) and handrails (stationary and folding) that may

be present on your particular lift model. Instructions are provided for manual operation of the lift in event of power or equipment failure.

Terminology: Become familiar with the terminology that will be used throughout this manual. Become familiar with the identification of lift components and their functions.

Direction:

The terms "left," "right," "inboard," and "outboard" will be used throughout this manual to indicate direction (as viewed from outside the vehicle looking directly at the lift outboard roll stop). Refer to the Lift Terminology Illustrations for clarification of direction terms.

Lift Terminology

Lift Components:

Refer to the Lift Terminology Illustrations on pages 2 and 3.

Pump Module: The remote mounted pump module consists of the main hydraulic pump, the manual hand pump, the logic control board and other electrical components that power the lift electric/hydraulic systems.

Hand-held Switch Control Box: The standard hand-held control switchbox is connected to the pump module. The control box is equipped with four push-button switches, (UP, DOWN, STOW, and DOOR CLOSE). The switches activate the fully automatic lift functions as well as **optional** automatic door operators (if so equipped). Details regarding the control switches and their functions are provided in the Lift Operation section (page 11).

Lift Housing: The lift housing is the metal structure (casing) mounted under the vehicle which contains and protects the platform carriage assembly. The housing contains all lift components

except the power (pump) module when the lift is in the stowed position.

Platform Carriage Assembly: The platform carriage assembly includes the platform assembly, the lifting arms, the rolling horizontal arms that carry the platform assembly in and out of the housing and the electrical/hydraulic drive components that power the lift.

Platform Assembly: The lift platform assembly consists of the flat aluminum plate with raised diamond embossing upon which the wheelchair is positioned, the outboard roll stop, the inboard roll stop (if so equipped) and optional handrails (if so equipped).

Outboard Roll Stop: The outboard roll stop is the automatic electric actuator-activated outer barrier that provides a ramp for wheelchair loading and unloading at ground level. Photos and further details regarding the outboard roll stop operation are provided in the Pre-Lift Operation Notes section (pages 7 and 8).

Bridge Plate (Inboard Roll Stop): UVL lift models are equipped with an automatic or manually operated bridge plate (except model UVL603A). The bridge plate bridges the gap between the lift platform and the vehicle floor. Bridge plates also serve as inboard roll stops.

Automatic bridge plates are fully-automatic in operation and are activated by the lift control switches (no attendant required). Manual bridge plates must be operated by an attendant. Further details and instructions for operation of manual bridge plates are provided on page 12 of this manual.

Platform Cable-activated Manual Release System: A cable-activated manual release system releases the platform carriage assembly drive chain to allow the platform carriage assembly to be manually moved out (extended) or moved in (retracted), should it be necessary. Complete details and operating procedures are provided on pages 15-19.

Lift Actions and Functions:

Extend: Extend is the action of the platform carriage assembly moving (rolling) out of the lift housing.

Retract: Retract is the action of the platform carriage assembly moving (rolling) into the lift housing.

Deploy: Lift deployment is the action of the lift platform carriage assembly extending (moving outward) from the housing and lowering to ground level when the

DOWN switch is activated or raising to floor level when the UP switch is activated.

Stow: Stow is the action of the lift platform carriage assembly retracting (moving inward) into the carriage assembly housing. During the stow function, the platform will automatically raise or lower to stow level before retracting into the housing.

Stow Level: Stow level is the height that the platform carriage

assembly moves in and moves out of the lift housing.

Floor Level: Floor level is the height that the platform carriage assembly raises to in order for the wheelchair passenger to enter and exit the vehicle.

Note: Further details regarding lift control switches and the corresponding lift functions are provided in the Lift Operating Instructions on pages 10 and 11.

Lift Operation Safety

Safety Symbols

SAFETY FIRST! Know That....

A All information contained in this manual and supplements (if included), is provided for your safety. Familiarity with proper operation instructions as well as proper installation and maintenance procedures are necessary to ensure safe, troublefree operation. Safety precautions are provided to identify potentially hazardous situations and provide instruction on how to avoid them.

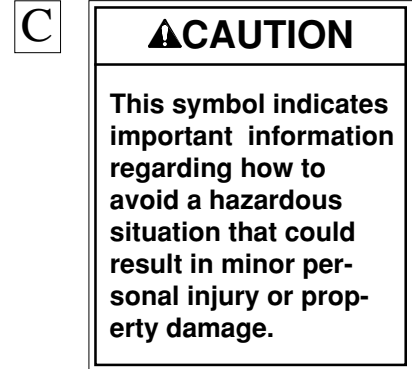
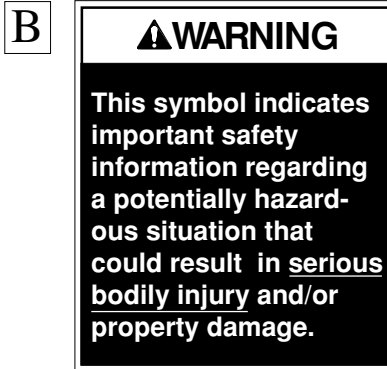

D **Note:** Additional information provided to help clarify or detail a specific subject.

These symbols will appear throughout this manual as well as on the labels posted on your lift. **Recognize the seriousness of this information.**

Lift Operation Safety Precautions

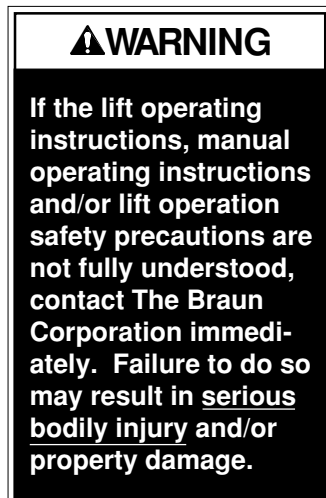

- ▲WARNING** Read manual and supplement(s) before operating lift. Read and become familiar with all safety precautions, pre-lift operation notes, operating instructions and manual operating instructions before operating the lift.
- ▲WARNING** Load and unload on level surface only.
- ▲WARNING** Engage vehicle parking brake before operating lift.
- ▲WARNING** Provide adequate clearance outside the vehicle to accommodate the lift before opening lift door(s) or operating lift.
- ▲WARNING** Inspect lift before operation. Do not operate lift if you suspect lift damage, wear or any abnormal condition.
- ▲WARNING** Keep operator and bystanders clear of area in which the lift operates.

▲WARNING Stand clear of doors, stepwell and platform during lift operation.

▲WARNING Do not jack the vehicle by the bumper or frame, this could cause damage to the drive shaft and/or wheelchair lift.

▲WARNING Whenever a wheelchair passenger (or standee) is on the platform, the:

- Passenger must be positioned in center of platform
- Wheelchair brakes must be locked
- Roll stop must be up (vertical)
- Passenger should grip both handrails if able (if so equipped).

Lift Operation Safety

Lift Operation Safety Precautions (continued)

- ▲WARNING** Load and unload clear of vehicular traffic.
- ▲WARNING** Do not overload or abuse. The load rating applies to both the raising and lowering functions - continuous lifting capacity is 750 lbs.
- ▲WARNING** Do not operate or board the lift if you or your lift operator are intoxicated.
- ▲WARNING** Do not raise front wheelchair wheels (pull wheelie) when loading (boarding) the platform.
- ▲WARNING** Open lift door(s) fully and secure before operating lift.
- ▲WARNING** Position and secure (buckle, engage, fasten, etc.) the wheelchair-equipped occupant seat belt (torso restraint) before loading onto the wheelchair lift platform.
- ▲WARNING** Fold manual-fold handrails down before stowing lift.
- ▲WARNING** Lift occupant must keep hands, arms and all other body parts within the lift occupant area and clear of moving parts.
- ▲WARNING** Platform must be positioned at floor level when loading or unloading in and out of vehicle.
- ▲WARNING** Do not use the outboard roll stop as a barrier (brake). Stop and brake wheelchair when fully loaded on the platform (manually stop and brake manual wheelchairs — stop powered wheelchairs with the wheelchair controls).
- ▲WARNING** Turn powered (electric) wheelchairs off when on lift platform.
- ▲WARNING** Press the DOWN switch until the entire platform rests on ground level (lowered fully) and the outboard roll stop is fully unfolded (ramp position) before loading or unloading a passenger at ground level.
- ▲WARNING** Outboard platform roll stop must be fully unfolded (ramp position) before front and rear wheelchair wheels cross roll stop when loading or unloading at ground level.
- ▲WARNING** Accidental activation of control switch(es) may cause unintended operation(s).
- ▲WARNING** After manually releasing platform, stow platform and push manual release T-handle in fully and move platform in and out to engage platform lock before driving vehicle. Failure to lock platform may result in unintended platform deployment.
- ▲WARNING** Insert manual release T-handle fully before manually lowering or raising platform and manually move platform in and out to engage platform lock.
- ▲WARNING** Maintenance and lubrication procedures must be performed by authorized (certified) service personnel.
- ▲WARNING** Replace missing, worn or illegible decals.
- ▲WARNING** Keep owner's manual in lift vehicle at all times.
- ▲WARNING** Never modify (alter) a Braun Corporation lift.
- ▲WARNING** Do not use accessory devices not authorized by The Braun Corporation.
- ▲WARNING** Do not remove any guards or covers.

Lift Operation Safety

Lift Operation Safety Precautions (continued)

⚠WARNING Keep clear of any hydraulic leak.

⚠WARNING Failure to follow these safety precautions may result in serious bodily injury and/or property damage.

Pre-Lift Operation Notes

⚠WARNING

Read and become familiar with all lift operation safety precautions, pre-lift operation notes, operating instructions and manual operating instructions prior to operating the lift. If this information is not fully understood, contact The Braun Corporation immediately. Failure to do so may result in serious bodily injury and/or property damage.

UVL® series lift models provide fully automatic operation of all lift functions as well as **optional** automatic door operators (if so equipped). **It is the responsibility of the lift operator to properly activate all lift functions.**

Read and become familiar with all Lift Operation Safety Precautions, Pre-Lift Operation Notes, Lift Operating Instructions and Manual Operating Instructions before attempting lift operating procedures. Contact The Braun Corporation immediately if any of

this information is not understood. Call 1-800-THE LIFT. The lift owner's **manual must be stored in the lift vehicle at all times.**

General Safety: The lift operator (attendant) and bystanders must keep clear of the area in which the lift operates and clear of all moving parts. Stand clear of doors, stepwell and platform during lift operation. The lift occupant must keep hands, arms and all other body parts within the lift occupant area and clear of moving parts.



! DANGER

KEEP CLEAR OF MOVING PARTS



81819

⚠WARNING

Discontinue lift use immediately if any lift component does not operate properly. Failure to do so may result in serious bodily injury and/or property damage.

Become familiar with all platform features and the proper operation of the platform components **before** attempting lift operation. Refer to Lift Terminology on pages 2-4 for identification of and description of specific lift components if not clearly depicted in this section. Contact The Braun Corporation at 1-800-THE LIFT immediately if any of this information is not understood.

Outboard Roll Stop: The outboard roll stop is the automatic electric actuator-activated outer barrier that provides a ramp for wheelchair loading and unloading at ground level.

From ground level, the LIFT UP function switch automatically raises (rotates) the actuator-activated roll stop to the upright (vertical) position before the

Pre-Lift Operation Notes

platform raises. **Note:** The lift platform will not raise if the roll stop is not in the UP position. This is a built-in safety feature.

The LIFT DOWN function lowers the platform to ground level. The outboard roll stop automatically unfolds to ramp (horizontal) position when the platform contacts the ground to allow the wheelchair passenger on or off of the lift. The roll stop **must be**

fully unfolded before the front and rear wheelchair wheels (or standee) have crossed the roll stop.

Although the outboard roll stop is lift-powered and fully-automatic in operation, mechanical failures are possible. **Discontinue lift operation immediately if the roll stop does not operate properly.**

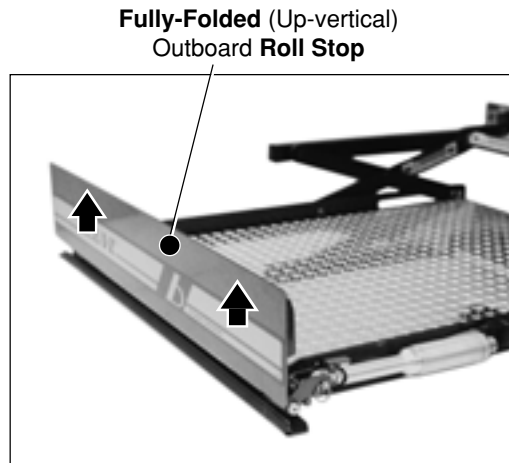
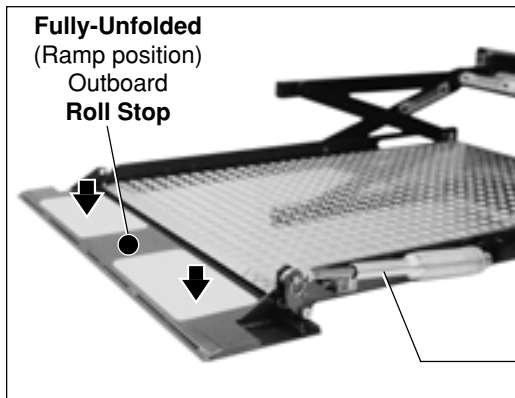

Bridge Plate (Inboard Roll Stop): UVL lift models may be equipped with an automatic or manually operated bridge plate (**except** model UVL603A). The bridge plate bridges the gap between the lift platform and the vehicle floor as well as serving as an inboard roll stop.

Automatic Bridge Plate: Automatic bridge plates are spring-

loaded to raise to vertical position when the platform extends from the stow position. The automatic bridge plate folds down onto the vehicle floor as the platform raises to floor level. The bridge plate automatically folds down to the platform surface during the lift stow function. **Discontinue lift operation immediately if the automatic bridge plate does not operate properly.**

Manual Bridge Plates: Manual bridge plates are attendant operated. The bridge plate rests on the platform surface when the lift is in the stowed position. When the platform is fully-extended, the bridge plate is manually raised to the vertical position. When the platform is raised to floor level, the bridge plate is manually lowered to the vehicle floor (bridging position).

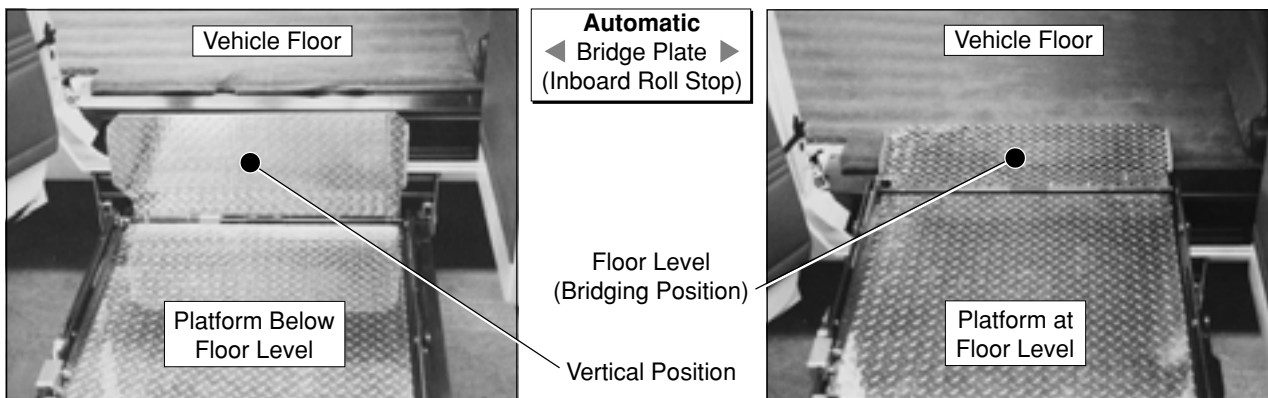

Pre-Lift Operation Notes

Further details and instructions for operation of manual bridge plates are provided in the Manual Bridge Plate Operating Instructions (see page 12).

Handrails: UVL lift models may be equipped with one of three types of handrails - Stationary Handrails, Manual Fold "P" Handrails or Manual Fold "U"

Handrails with Safety Side Shields. Handrails are standard equipment on most lift models and optional equipment on others. Passengers should grip both handrails when on the lift platform **if possible**.

Become familiar with the proper operation of the style of handrail your lift is equipped with (if so

equipped). Stationary handrails remain in the upright (vertical position) at all times and require no operation procedures (see page 13 for details). Refer to the applicable handrail instructions for details and operation procedures for folding handrails on pages 13 and 14. **Discontinue lift operation if the handrails do not operate properly.**



Lift Passengers: Do not attempt to load or unload a passenger in a wheelchair or other apparatus that does not fit on the platform area. Do not exceed the 750 pound rated load capacity of the lift.

Passenger Orientation (Boarding Direction): Inboard facing of wheelchair passengers is not prohibited, but **outboard facing of passengers is recommended** by The Braun Corporation. Passengers loading from ground level should back onto the platform. Passengers loading from floor level should proceed onto the platform facing outward (outward from the vehicle).

The passenger **must** be positioned in the **center of the platform** to prevent side-to-side load off-balance. The lift attendant (operator) should **not** ride on the platform with the passenger. **Wheelchair brakes must be locked** whenever the passenger is on the platform. Turn powered (electric) wheelchairs off when on platform.

If you are an attendant operating

the lift, it is your responsibility to practice safe loading and unloading procedures. Observe your passenger at all times during lift operation.

Vehicle (Floor Level) Loading/Unloading: The platform **must be fully raised** (at floor level) and the bridge plate must be properly positioned (if equipped) when loading or unloading passengers in or out of the vehicle. **Floor level positioning of the UVL platform is a fully automatic function, but it is the responsibility of the lift operator to ensure the platform and the bridge plate (if equipped) are properly positioned.**

If the lift does not position the platform properly, **discontinue lift use immediately** and contact an authorized Braun Corporation dealer in your area or call The Braun Corporation at 1-800-THE LIFT. One of our national service representatives will direct you to an authorized service repairman who will inspect your lift.

Wheelchair-equipped Occupant Seat Belts: The Braun Corpora-

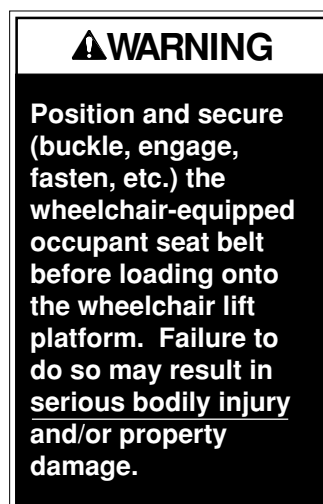

tion recommends wheelchair passengers position and buckle their wheelchair-equipped seat belt (torso restraint) as specified by the manufacturer, **before** loading onto a wheelchair lift.

Different types of disabilities require different types of wheelchairs and different types of wheelchair-equipped occupant restraint belt systems (torso restraints). It is the responsibility of the wheelchair passenger to have his or her wheelchair equipped with an occupant restraint (seat belt) under the direction of their health care professional. Wheelchair lift attendants should be instructed on any special needs and/or procedures required for safe transport of wheelchair passengers.

Pre-Lift Operation Notes

Operation Procedure Review:

The wheelchair lift user and/or attendant should review the safety precautions and operation procedures appearing in this manual with your wheelchair lift sales representative (dealer), **before** attempting lift operation. Become familiar with the proper operation of your lift **before** operating the lift by yourself.

Operate the lift through all functions with your sales representative on hand to ensure the proper use and operation of the wheelchair lift is understood. The

sales representative should also instruct and demonstrate manual operation procedures. **Be certain** your sales representative instructs and demonstrates the proper reengagement procedure of the manual cable release system (see pages 15-19). Any questions or concerns can be answered by the sales representative at that time.

Do not operate your lift if you suspect lift damage, wear or any abnormal condition. **Discontinue lift use immediately** and contact an authorized Braun Corporation dealer in your area or call The Braun Corporation at 1-800-THE LIFT. One of our national service representatives will direct you to an authorized service repairman who will inspect your lift.

Preventive Maintenance: Maintenance is necessary to ensure safe and trouble-free lift operation. General preventive maintenance consisting of **careful** inspections of your lift

system and cleaning the lift should be a part of your routine. Simple inspections can detect potential lift operational problems.

Regular preventive maintenance will reduce potential lift operation downtime and increase the service life of the lift, as well as possibly detecting potential hazards. Exposure to harsh weather elements or environmental conditions may require more frequent maintenance and lubrication procedures. See the Maintenance and Lubrication section for further details.

Cold Climate Recommendations: The vehicle in which the lift is installed should be stored in a garage or other sheltered place if possible, especially during inclement weather conditions. When the lift is not in use, the lift should be in the stowed position to keep foreign objects, rain, ice, snow, etc., from entering through the lift opening or building up on the platform surface.

WARNING

Discontinue lift use immediately if any lift component does not operate properly. Failure to do so may result in serious bodily injury and/or property damage.

WARNING

Read and become familiar with all lift operation safety precautions, pre-lift operation notes, operating instructions and manual operating instructions prior to operating the lift. If this information is not fully understood, contact The Braun Corporation immediately. Failure to do so may result in serious bodily injury and/or property damage.

Lift Operating Instructions

Lift Operating Instructions address the lift control switches and the corresponding lift functions. Separate instructions are provided for operation of manual bridge plates (inboard roll stops) and handrails that may be present on your particular lift model. **Fold handrails down before stowing lift.**

In event of power or equipment failure, refer to the Manual Operating Instructions section.

Before lift operation, park the vehicle on a level area, away

from vehicle traffic. Place the vehicle transmission in "Park" and engage the parking brake.

Vehicle Lift Door(s): Open manual doors fully, being certain the doors are secured in the fully open position before operating the lift. If your vehicle is equipped with optional automatic door operators, the doors will open when the UP or DOWN switch is pressed. The automatic door operators will close when DOOR CLOSE switch is pressed (only if the lift platform is in the fully stowed position).

Lift Operating Instructions

Lift Control Switches:

The UVL[®] logic control system provides fully automatic operation of all lift functions as well as **optional** automatic door operators (if so equipped). Lift functions can be performed from any position the platform happens to be in at the time the switch button is pushed.

There are two types of hand controls available for the UVL - the standard hand-held control switchbox, or the **optional** remote control. Both types of controls are equipped with four push-button switches. The functions activated by both types of controls are the same. The switch functions are labeled. The function of each switch is described below.

Remote Control Note: The effective range of the remote control is 20 feet. A range further than 20 feet does not allow an attendant to observe and assist the lift passenger.

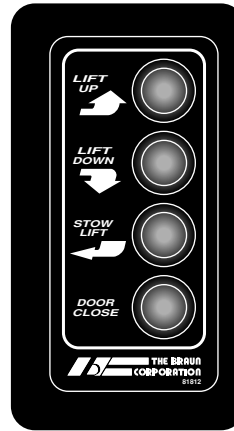

Hand-held Switchbox
(Standard Equipment)



Optional Remote
Control Transmitter

Control Switch Functions:

UP: From the stowed position, the LIFT UP function deploys (extends) the platform fully. The platform then raises to floor level height and moves inward to the vehicle floor level position (if applicable). **Note:** When the lift is in the stowed position, power doors automatically open when the UP switch is pressed (if so equipped).

From ground level, the LIFT UP function will first automatically raise (rotate) the outboard roll stop to the upright (vertical) position. **Note:** The lift will not raise if the roll stop is not in the UP position (built-in safety feature). The platform then raises to floor level height and moves inward to the vehicle floor level position. **Note:** UVL600 and UVL600X lift models move inward to floor level position with an "arcing" motion. UVL850 Series lift models do not.

DOWN: The LIFT DOWN function lowers the platform to ground level (regardless of the position of the platform) and then unfolds the outboard roll stop to the ramp (horizontal) position. From the stowed position, the lift will extend and then lower. **Note:** When the lift is in the stowed position, power doors automatically open when the DOWN switch is pressed (if so equipped).

STOW: The STOW LIFT function raises or lowers the platform to stow level and then moves the platform inward (retracts) to the stow position.

Note: The lift will not stow with weight on the platform (built-in safety feature).

Fold handrails down before stowing lift. Failure to do so may result in serious bodily injury and/or property damage.

DOOR CLOSE: When the vehicle is equipped with automatic door openers (optional), the DOOR CLOSE switch closes the doors. This function operates only when the platform is stowed or fully extended and below stow level.

Note: If any of these functions do not occur as described, discontinue lift use immediately and contact your sales representative or call The Braun Corporation at 1-800-THE LIFT. One of our national service representatives will direct you to an authorized service repairman who will inspect your lift.

In event of power or equipment failure, refer to Manual Operating Instructions to manually operate (stow) the lift, then contact your sales representative for further instructions.

⚠ WARNING

Fold handrails down before stowing lift. Failure to do so may result in serious bodily injury and/or property damage.

Manual Bridge Plate Operating Instructions

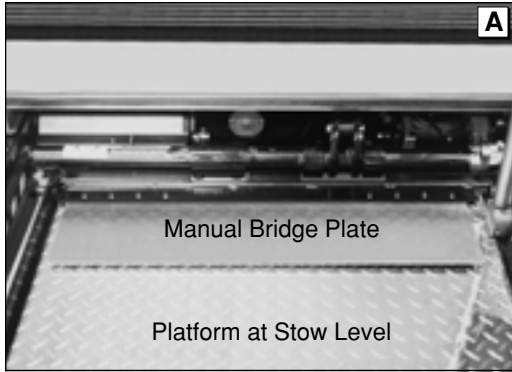

The bridge plate bridges the gap between the lift platform and the vehicle floor when the lift platform is raised fully (positioned at floor level), as well as serving as an inboard roll stop.

Manual bridge plates are attendant operated. The bridge plate rests on the platform surface when the lift is in the stowed position (see Photo A). When the platform is fully extended and raised or lowered to the desired height, the bridge plate is manually positioned as needed.

When raised to the vertical position, the rear (left) end of the plate engages a notch in the angled engagement bracket located at the inboard end of the platform side plate. See Photos B and C. The spring located on the opposite end of the bridge plate hinge places rearward pressure on the bridge plate to retain the plate in the vertical position (engaged in bracket notch).

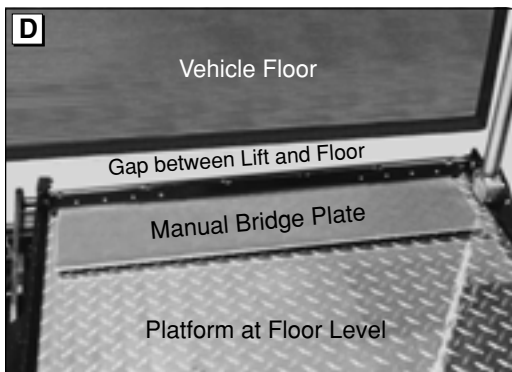
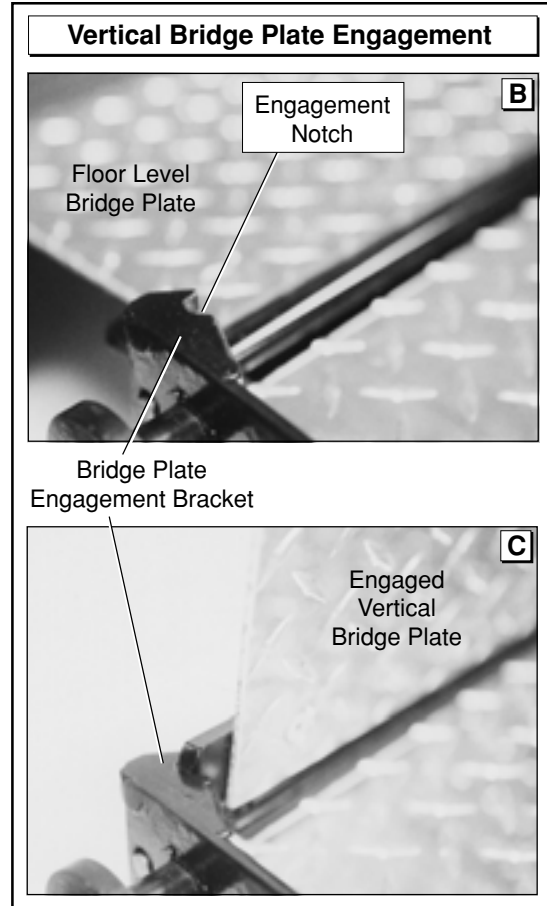

Move vertical bridge plate to right to disengage it, and then lower it to the floor.

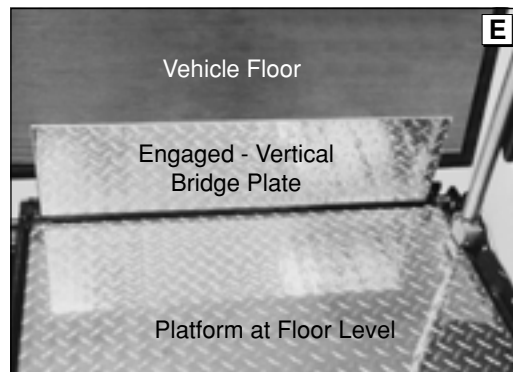

When the platform is raised to floor level, the bridge plate is manually lowered to the vehicle floor (bridging position) by moving the bridge plate to the right to disengage it, and then lowering it to the floor. From the floor level bridging position, the bridge plate is manually raised to the vertical position (see Photos D, E and F).

The bridge plate can be folded down to the platform surface by the attendant before stowing the lift platform, or the stowing (retracting) movement of the platform will push the bridge plate down as it contacts the lift carriage.

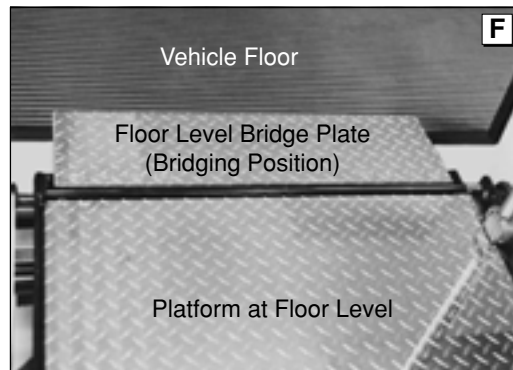

Dual Stationary Handrail Instructions

Stationary handrails remain in the upright (vertical position) at all times. Handrail access slots are provided in the lift housing cover. Access slots are incorporated in the vehicle floor or stairwell during lift installation procedures. The handrails travel in and out of

the access slots as the platform carriage assembly retracts and extends. **Keep clear of the handrail access slots** during lift operation.

⚠ WARNING

Stay clear of handrail access slots during lift operation. Failure to do so may result in serious bodily injury.

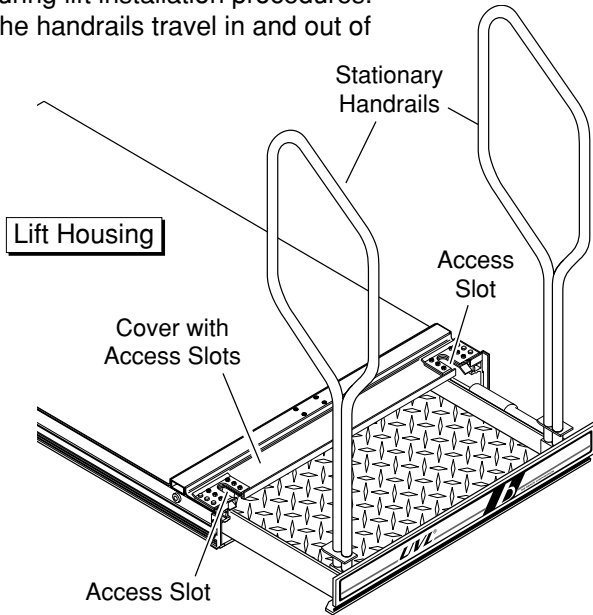

Keep clear of handrail access slots during lift operation.

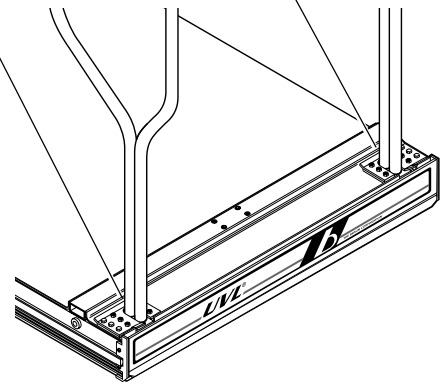

Dual Manual Fold "P" Handrail Instructions

Folding "P" handrails are manually operated. The handrails rest on the platform when the lift is not in use. The handrails **must** be folded down to the platform (horizontal position) **before** stowing the lift. The handrails are

lifted to the vertical position and locked in position with a latch that automatically engages the platform bracket when fully raised. Lifting the round knob located on the vertical handrail tube disengages the latch.

⚠ WARNING

Fold handrails down before stowing lift. Failure to do so may result in serious bodily injury and/or property damage.

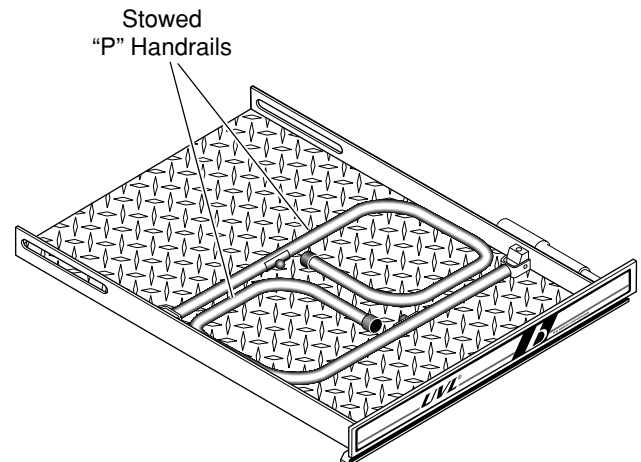
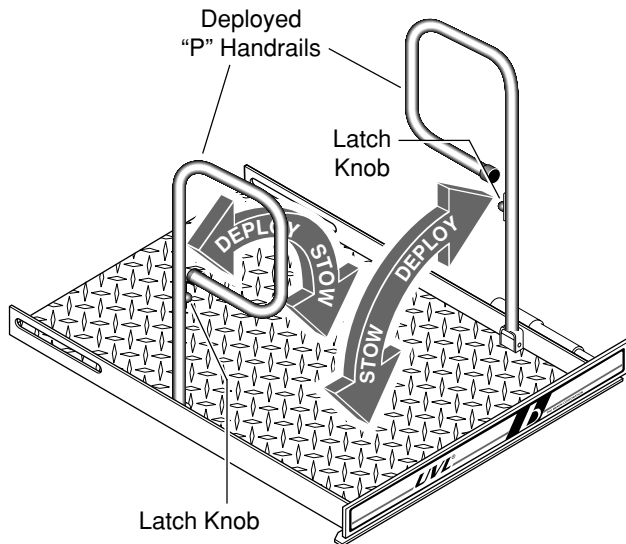

Dual Manual Fold "U" Handrail (with Shield) Instructions

Folding "U" handrails (with safety shield) are manually operated. The handrails rest on the platform when the lift is not in use. The handrails **must** be folded down to the platform (horizontal position) **before** stowing the lift.

Note: The bridge plate (inboard roll stop) **must be folded down** to the platform (horizontal position) **before** the handrails are folded down.

The handrails are lifted to the

vertical position and locked in position with a latch that automatically engages the platform bracket when fully raised. Lifting the round knob located on the vertical handrail tube disengages the latch.

To Deploy Handrails:

1. Lift front (right) handrail to vertical latched position. Be certain latch is engaged.

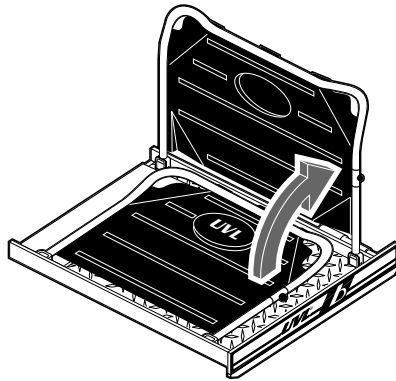

2. Lift rear (left) handrail to vertical latched position. Be certain latch is engaged.

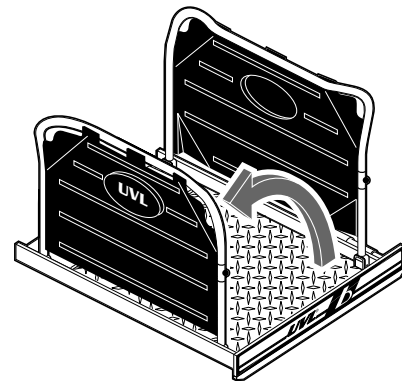

To Stow Handrails:

Before stowing lift:

Inboard Roll Stop

1. Fold down inboard roll stop (bridge plate).

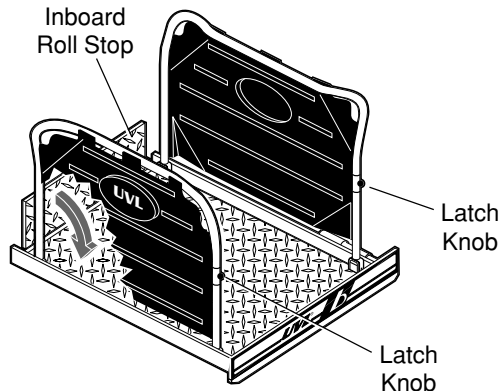

2. Lift round latching knob to disengage latch and fold rear (left) handrail down to platform (horizontal position).

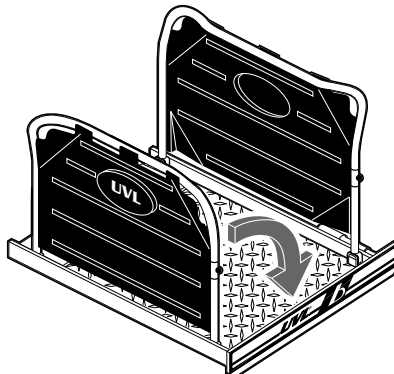

3. Lift round latching knob to disengage latch and fold front (right) handrail down to platform (horizontal position).

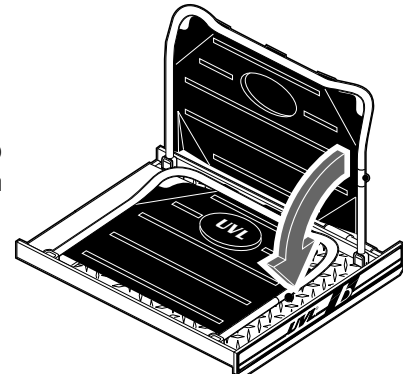

WARNING

Fold handrails down before stowing lift. Failure to do so may result in serious bodily injury and/or property damage.

Manual Operating Instructions

The UVL has the capability of being manually operated. If you experience power or equipment failure, refer to the Manual Operating Instructions to manually operate the lift. Refer to the Lift Operating Instructions for all normal lift operation procedures (such as loading and unloading passengers). **Follow all Lift Operation Safety Precautions at all times!**

Familiarize yourself with the components necessary to operate the Manual Back-Up System (see illustration at right and photos on pages 17 and 18). The location of the power pack and release cable varies from vehicle to vehicle (depending on your particular installation).

The T-handle release cable releases and engages the lift platform to allow the platform to

be manually extended and retracted. The manual back-up pump (hand pump) is used to manually lower and raise the extended platform.

Step-by-step instructions for manually moving the platform in and out, manually raising and lowering the platform and manually lowering (unfolding) the outboard roll stop are provided on the following pages. Refer to the applicable Manual Operation instructions for detailed procedures.

Always exercise extreme caution when operating the lift manually. **Read the warning and the safety information below and on the following page! Read all Manual Operating Instructions before attempting to perform manual operation procedures.**

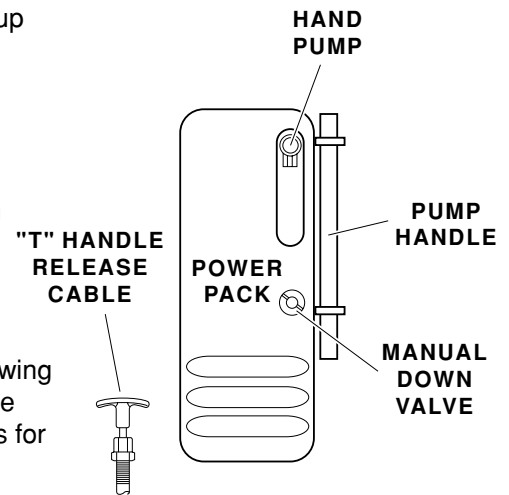

Note: Location of power pack and T-handle varies.

Note: Photos of the power pack and T-handle appear on pages 17 and 18.

Cable-Activated Platform Manual Release System



Platform Manual Release System: A cable-activated manual release system releases and engages the platform carriage assembly drive chain to allow the platform carriage assembly to be manually moved out (extended) or moved in (retracted) as needed. A T-handle is provided on the release cable for activation of the manual release system (details follow).

After manually moving the platform in or out, it is extremely important that the cable-activated manual release is positively re-engaged to secure (lock) the platform carriage assembly before loading a passenger on the platform or before driving the vehicle (reengagement procedure outlined on following page).

Failure to manually lock the platform carriage assembly (re-engage the carriage assembly drive chain) after manual deployment, will allow the platform to roll in or out of housing unhindered during vehicle movement. Failure to lock the platform will also allow the platform to roll in or out of housing unhindered during hand pump raising and lowering procedures.

After manually releasing platform, push manual release T-handle in fully and ensure platform is locked before driving lift vehicle. Uncontrolled and unintentional platform deployment (inadvertent platform ejection) may result in serious bodily injury and/or property damage.

Manual Operating Instructions

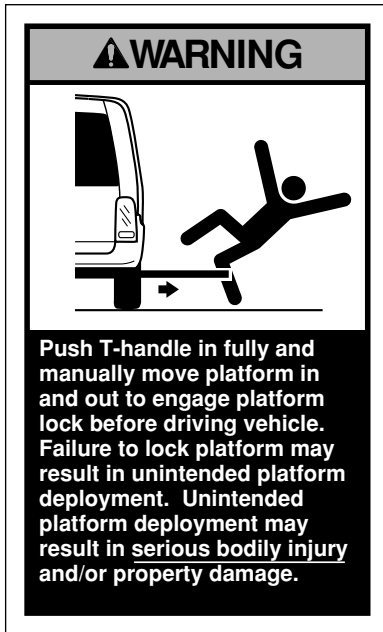

Note: The lift platform must be pushed back into its carriage compartment at least half-way before reverting back to normal (powered) operation. When the lift is fully extended manually, it does not activate the proper switches for normal operation. Returning (moving) the lift at least half-way in allows for proper switch activation.

Note: Before manually raising or lowering platform, be sure to reengage the release cable mechanism by loosening (turning) the “T” handle and pushing inward. Failure to place “T” handle in the original IN position will allow the platform to move in

and out when trying to raise or lower the platform with the hand pump.

Sales Representative: Instruct and demonstrate the proper re-engagement procedure of the manual release for all new UVL owners at the point of sale or delivery. Remind the consumer of proper engagement procedures when giving telephone instructions.

Step-by-step instructions for manually moving the platform in and out, manually raising and lowering the platform and manually lowering (unfolding) the outboard roll stop are provided on the following pages.

Platform Carriage Assembly Drive Chain Reengagement Procedure:

After manually moving the platform in or out:

1. Turn (loosen) the manual release “T” handle.
2. Push the “T” handle in **fully** (until handle bottoms out against its mounting bracket).

Read warning posted above!

3. Grasp the outer roll stop and move the platform in and out until the **platform locks** (chain release assembly engages), securing the platform carriage assembly within the housing. You will feel the release mechanism engage.

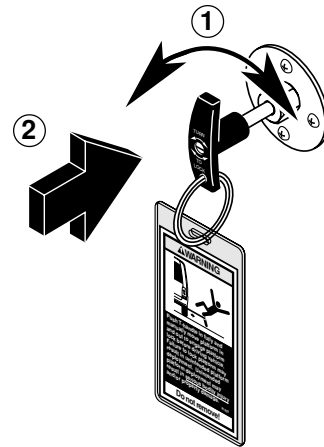

To Manually Move Platform Out (Extend) From Stow Position:

1. Pull the “T” handle release cable outward.
2. Turn the “T” handle to lock platform into the released position.
3. **Carefully** pull the platform out to desired position.

Read warning posted above!

Before raising or lowering the platform, be sure to lock the platform. Reengage the release cable mechanism by loosening (turning) the “T” handle and pushing inward. Failure to place “T” handle in the original IN position (lock platform) will cause the platform to move in and out when trying to raise or lower the platform with the hand pump.

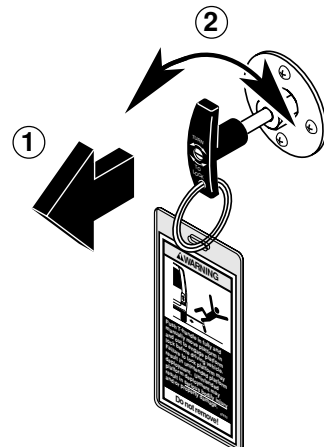

Manual Operating Instructions

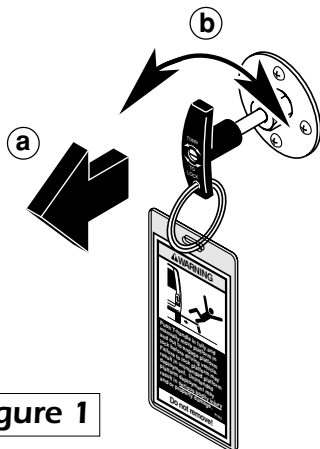
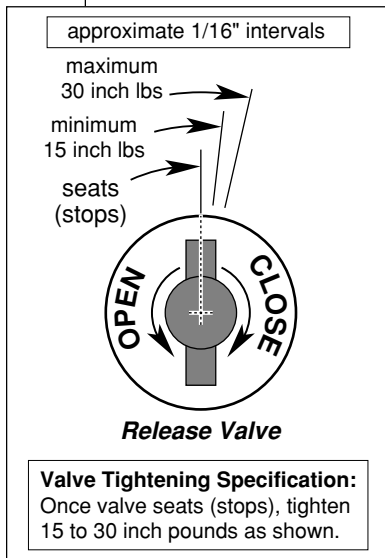
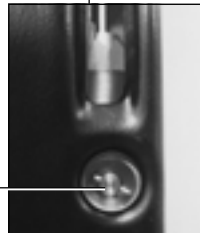
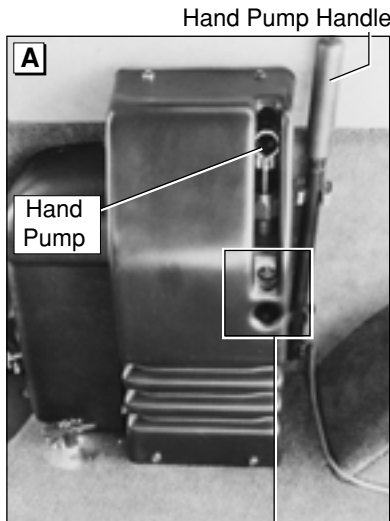

Figure 1

To Manually Raise Platform To Floor Level:

Note: Disregard procedures for manually moving the platform in or out if not applicable.

1. Remove pump handle from clips on side of power pack (or other storage location).
2. Place handle through pump cover access slot and into hand pump. Stroke hand pump until platform reaches floor height (see Photo C).
3. **a.** Pull "T" handle release cable outward and **b.** turn "T" handle to lock platform into the released position (see Figure 1).
4. Push platform in until it meets floor of vehicle (if applicable).
5. Reengage the release cable mechanism by **a.** turning the "T" handle and **b.** pushing the "T" handle in fully (see Figure 2).

Note: Grasp the outer roll stop and move the platform in and out until the **platform locks**. You will feel the release mechanism engage. Read **Platform Carriage Assembly Drive Chain Reengagement Procedure** section on opposite page!

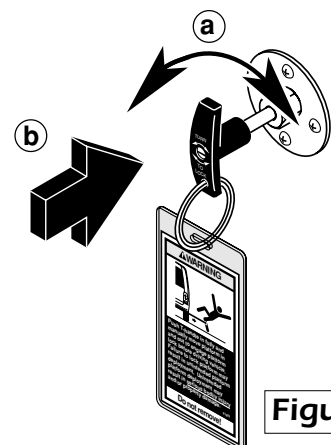
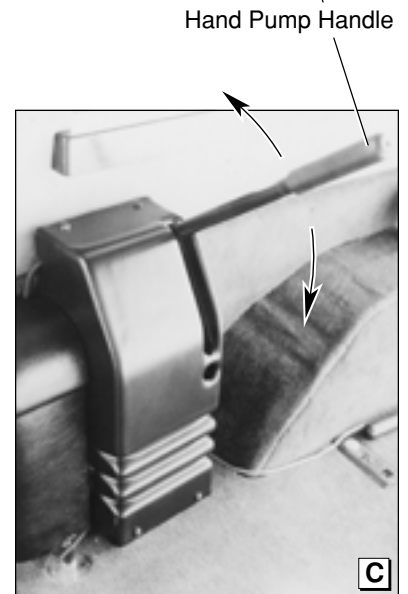
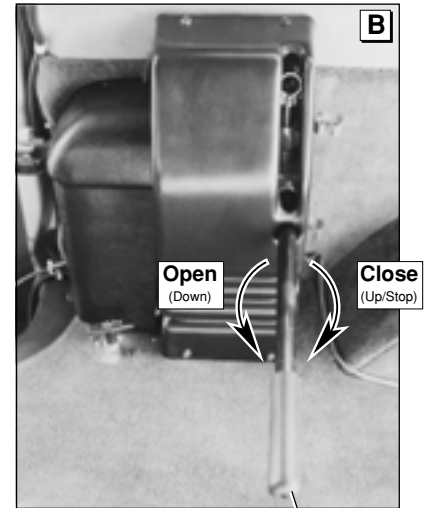

Figure 2

Manual Operating Instructions

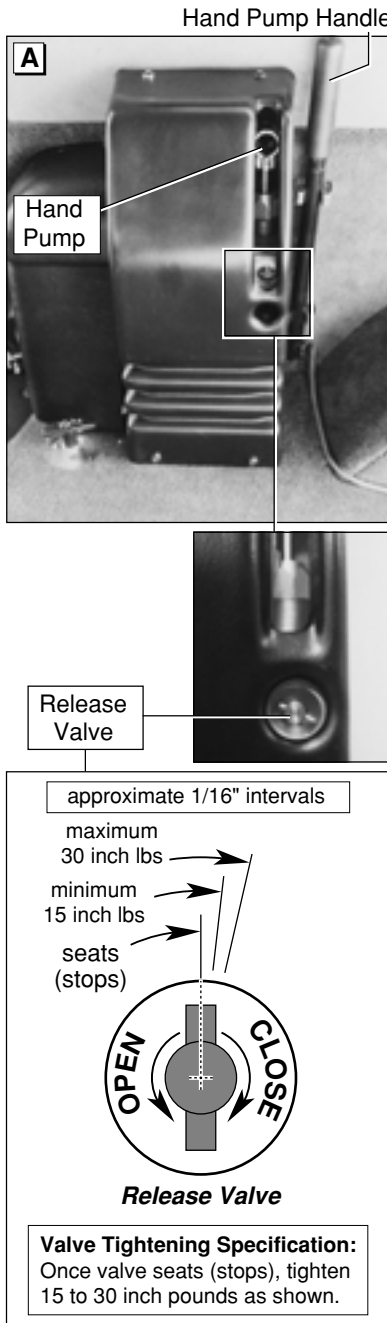

Figure 1

To Manually Lower Platform To Ground Level:

Note: Disregard procedures for manually moving the platform in or out if not applicable.

When lowering platform from floor level:

1. **a.** Pull "T" handle release cable outward and **b.** turn "T" handle to lock platform into the released position (see Figure 1).
2. Pull platform out fully (until it stops), if applicable.
3. Reengage the release cable mechanism by **a.** turning the "T" handle and **b.** pushing the "T" handle in fully (see Figure 2).

Note: Grasp the outer roll stop and move the platform in and out until the **platform locks**. You will feel the release mechanism engage. Read **Platform Carriage Assembly Drive Chain Reengagement Procedure** section on page 16!

4. Place slotted end of pump handle onto hand pump down (release) valve and turn **counterclockwise** (open 1/2 turn only) to lower platform. See Photo B.
5. Turn hand pump down (release) valve **clockwise** (close) before performing any other lift functions. See Photo B.

Note: Close hand pump release valve securely **before** operating lift. The lift will not operate properly if the valve is not in its fully clockwise position.

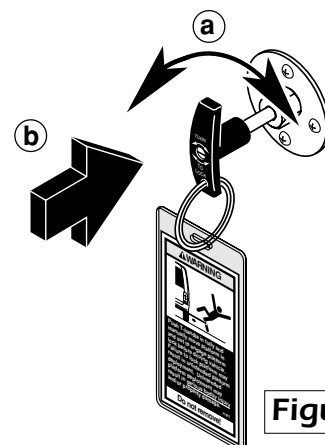
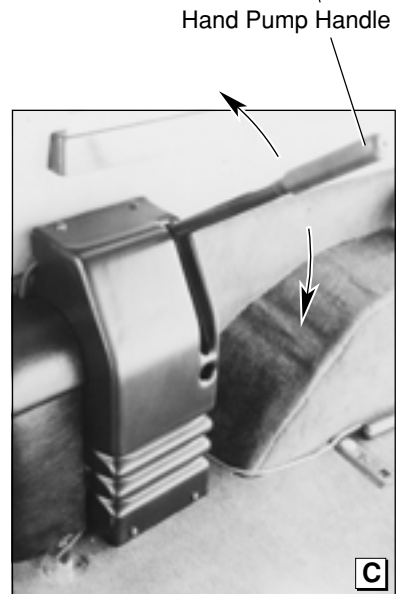
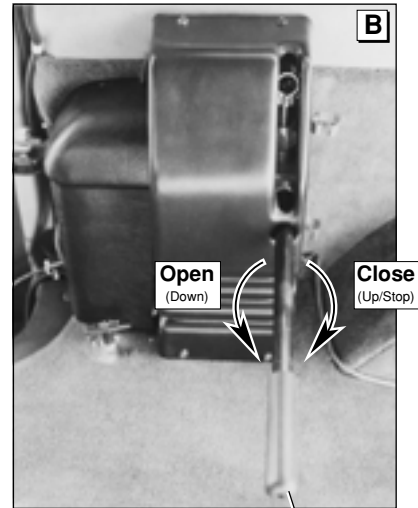

Figure 2

Manual Operating Instructions

To Manually Move Platform Inward (Retract) To Stow Position:

Read **Platform Carriage Assembly Drive Chain Reengagement Procedure** section on page 16!

1. Position (raise or lower) platform to stow level (height) using procedures outlined on pages 17 and 18.
2. Pull "T" handle release cable. See Figure 1.
3. Turn "T" handle to lock platform in the released position. See Figure 1.
4. **Carefully** push platform inward to stow position.
5. Reengage the release cable mechanism by **a.** turning the "T" handle and **b.** pushing the the "T" handle in fully (see Figure 2). Grasp the outer roll stop and move the platform in and out until the **platform locks**. You will feel the release mechanism engage.

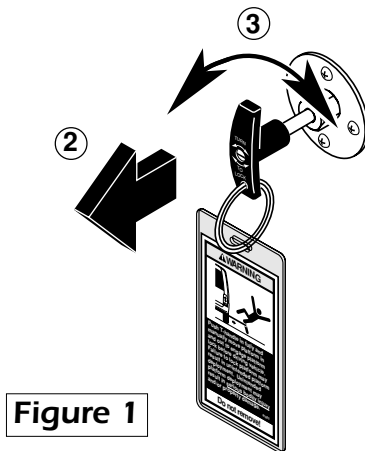

Figure 1

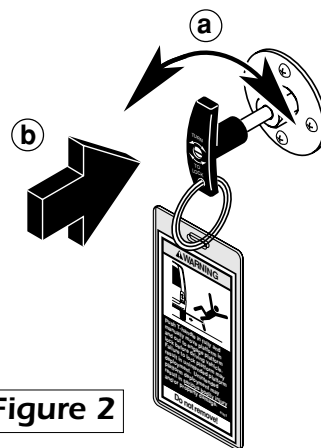

Figure 2



Outboard Roll Stop Manual Operation

The automatic outboard roll stop is powered by an electric actuator. In the event of power or equipment failure, refer to the following instructions to manually operate the roll stop.

Note: The lift will not raise from ground level if the roll stop actuator detent pin has not been reinstalled. The detent pin fully engages and activates the roll stop down switch.

CAUTION
Push roll stop down switch inward when inserting detent pin. Failure to do so will result in switch breakage.

Caution: Push the roll stop down switch inward (toward vehicle) before inserting the detent pin. Details on following page. Failure to do so will result in switch damage.

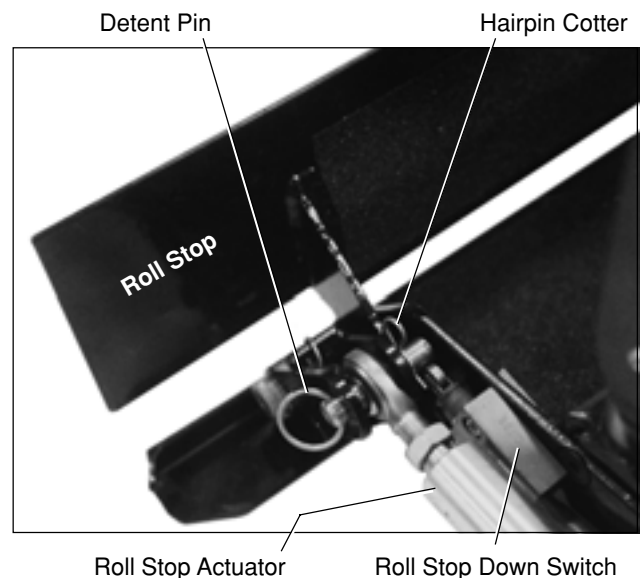

Manual Operating Instructions

To Manually Lower Outboard Roll Stop:

Note: Actuator shown exploded from lift for clarity.

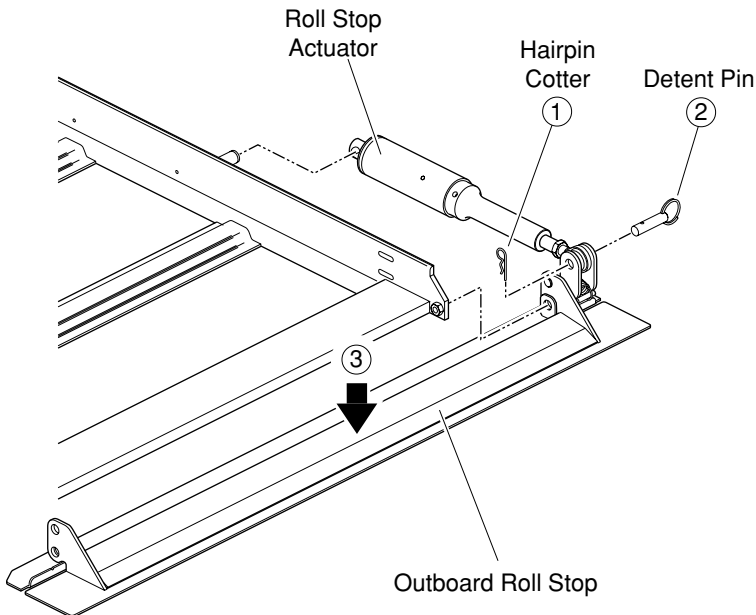

1. Remove hairpin cotter from detent pin.
2. Remove detent pin to detach roll stop actuator from roll stop.
3. Push roll stop to the down (ramp - horizontal) position.

Note: The lift will not raise from ground level without the roll stop release pin reinstalled, which fully engages and activates the roll stop down switch (details below).

To Reengage Outboard Roll Stop:

1. Position shaft end of roll stop actuator between roll stop mounting tabs (ears). Align mounting holes. **Note:** Rotate roll stop to vertical position or position needed to align mounting holes.

Note: The lift will not raise from ground level without the roll stop release pin reinstalled, which fully engages and activates the roll stop down switch.

⚠ CAUTION

Push roll stop down switch inward when inserting detent pin. Failure to do so will result in switch breakage.

2. **Read caution!** Push the roll stop down switch inward (toward vehicle) and insert detent pin. **Failure to do so will result in switch breakage!**

3. Insert hairpin cotter in detent pin to secure roll stop actuator to roll stop.

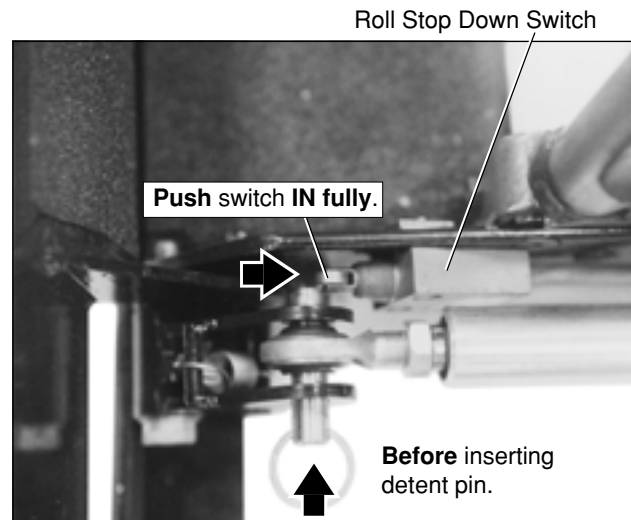

Maintenance and Lubrication

Maintenance is necessary to ensure safe and trouble-free lift operation. General preventive maintenance consisting of inspections of your lift system and cleaning the lift should be a part of your routine. When cleaning the lift, pay special attention to the roll stop opening, platform surface and bottom of platform. If mud, ice and/or snow build-up is apparent on platform surface, clean the area prior to use. Do not spray water inside of lift housing.

The lift-equipped vehicle should be stored in a garage or other sheltered place if possible, especially during inclement weather conditions. When the lift is not in use, the lift should be in the stowed position to keep foreign objects, rain, ice, snow, etc., from entering through the lift

opening or building up on the platform surface.

The UVL has been designed with many self-lubricating components. Lubricate the pivot points specified below approximately every four weeks (or 100 cycles) with a light penetrating type oil (30 weight or equivalent). Severe conditions (weather, environment, heavy usage, etc.) may require more frequent lubrication.

Complete maintenance checks and lubrication procedures **must** be performed annually by an authorized Braun Corporation sale representative who has attended and been **certified by the Braun UVL Sales and Service School**. If the annual maintenance and lubrication procedures cannot be performed, or if there is any sign of lift

damage, wear, abnormal condition or improper operation, **discontinue lift use immediately**. Contact your dealer or call The Braun Corporation at 1-800-THE LIFT. One of our national service representatives will direct you to an authorized service repairman who will inspect your lift.

⚠ WARNING

Annual maintenance and lubrication procedures must be performed by authorized service personnel. Failure to do so may result in serious bodily injury and/or property damage.

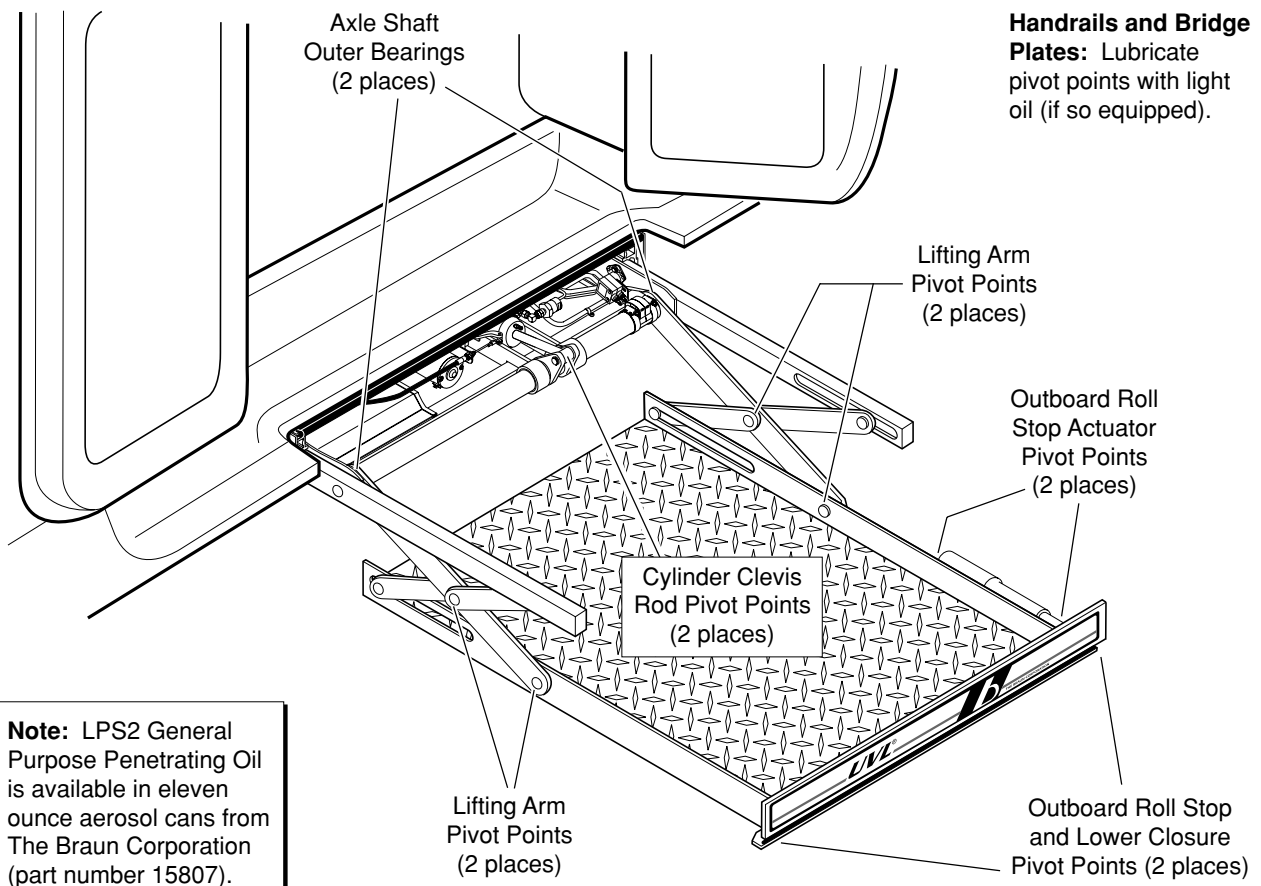

Note: LPS2 General Purpose Penetrating Oil is available in eleven ounce aerosol cans from The Braun Corporation (part number 15807).

Decals

Remember — the lift is only as safe as the operator!

⚠ WARNING

Replace missing, worn or illegible decals. Failure to do so may result in serious bodily injury and/or property damage.

Lift-posted decals are shown at right. Part numbers are provided for all decals. Inspect your lift for any missing, worn or illegible decals. Call 1-800-THE LIFT for replacements.

#81813  **⚠ WARNING**
Keep clear of stepwell when operating lift. #81813

#81814   **⚠ WARNING**
Face outward and lock wheelchair brakes before operating lift. #81814

#81819  **⚠ DANGER**
KEEP CLEAR OF MOVING PARTS  #81819

#81822

⚠ WARNING

Fold handrails down before stowing lift. Failure to do so may result in serious bodily injury and/or property damage.

HANDRAIL INSTRUCTIONS

Before stowing lift:

1. Fold down inboard roll stop.
2. Fold down rear (left) handrail.
3. Fold down front (right) handrail.

#86478



#81823

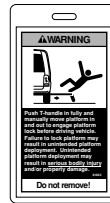

#81821



#81809-1

Warranty/Registration Instructions

Immediately upon receiving your lift, examine the unit for any damage. Notify the carrier at once with any claims.

Two warranty/registration cards (shown right) are protected in a clear envelope and attached to the lift protective shipping wrap. The sales representative must process one of the cards. The consumer must fill out the other card and mail it to The Braun Corporation. The warranty is provided on the back

cover of this manual. The Braun Serial No./Series No. identification tag (shown below) is located on the left platform side plate (outboard end). This I.D. tag contains the product identification information provided on the Warranty/Registration card. Record the information in the space provided below. This information **must** be provided when filing a warranty claim or ordering parts.

Sample Warranty/Registration Card

Lift Model No.	Lift Serial No.
Lift Series No.	Date of Manufacture

Sample Serial No./Series No. Identification Tag

Model No. _____

Series No. _____

Serial No. _____

Date of Manufacture _____

Note: Retain this information for future use. You must have this information when filing a warranty claim or ordering parts.

Return Authorization Procedure

All parts under warranty must have a Return Authorization Tag (red tag) attached before returning the part for credit. A red tag must be attached to every item and returned, freight prepaid, to The Braun Corporation. Red tags will be sent along with the new replacement part. The authorization of red tags allows us to expediently give you proper credit for warranty.

series number and serial number. The identification tag containing this information (shown above) is located on the left platform side plate (outboard end). When filling out the red tag, please describe the problem briefly. This will allow us to monitor the performance of our assembled parts, as well as purchased parts.

Sample Return Authorization Tag

The red tag must be filled out with the appropriate lift model number,

"Providing Access to the World"®



**Over 300 Braun Dealers
and Distributors Worldwide**

 **THE BRAUN
CORPORATION**
"Providing Access to the World"



International Corporate Hdqrs: P.O. Box 310 Winamac, IN 46996 USA
1-800-THE LIFT (574) 946-6153 FAX: (574) 946-4670

Braun "Worry-Free" Three-Year Limited Warranty

The Braun Corporation of Winamac, Indiana, warrants its wheelchair lift against defects in material and workmanship for three years, providing the lift is operated and maintained properly and in conformity with this manual. This warranty is limited to the original purchaser and does not cover defects in the motor vehicle on which it is installed, or defects in the lift caused by a defect in any part of the motor vehicle.

This warranty commences on the date the lift is put in service, providing the warranty registration card is completed and received by The Braun Corporation within 20 days of purchase.

This warranty also covers the cost of labor for the repair or replacement of most parts for one year when performed by an authorized Braun Representative. (A Braun labor schedule determines cost allowance for repairs.)

This warranty does not cover normal maintenance, service, or periodic adjustments necessitated by use or wear. The Braun Corporation will not, under any circumstances, pay for loss of use of lift or vehicle in which it is installed or loss of time.

This warranty will become null and void if the lift has been damaged through accident, misuse, or neglect, or if the lift has been altered in any respect.

Return Authorization Procedure

All parts under warranty must have a red tag attached before returning the part for credit. A red tag must be attached to every item and returned, freight prepaid, to The Braun Corporation. Red tags will be sent along with the new replacement part. The authorization of red tags allows us to expediently give you proper credit for warranty.

The red tag must be filled out with the appropriate lift model number, series number and serial number. The identification tag containing this information is located on the left platform side plate (outboard end). When filling out the red tag, please describe the problem briefly. This will allow us to monitor the performance of our assembled parts, as well as purchased parts.

RETURN AUTHORIZATION TAG
Items below MUST be completed before credit will be issued.

Returnee Name _____
 Account No. _____ Original Invoice No. _____
 Lift Model No. _____ Serial No. _____
 Serial No. _____
 Other Products _____
 Describe Problem Briefly _____

Sample: Return Authorization Tag

THE BRAUN CORPORATION
 P.O. BOX 310 WINAMAC IN 46996
 219-946-6153

○ MODEL UVL603A ○
 SERIAL NUMBER OD. 2632. DOM 0597
 PATENT 4,958,979

Sample:
Serial No./Series No.
Identification Tag

Note: See inside front cover for further warranty/registration information.

Date Received _____
 Authorized By _____

The Braun Corporation
 1014 S. Monticello
 P.O. Box 310
 Winamac, IN 46996
 Altis: _____
 (219) 946-6153



631 West 11th St., P.O. Box 310, Winamac, IN 46996
 1-800-THE LIFT In Indiana Call: (219) 946-6153 FAX: (219) 946-4670

All illustrations, descriptions and specifications in this manual are based on the latest product information available at the time of publication. The Braun Corporation reserves the right to make changes at any time without notice.

Free Manuals Download Website

<http://myh66.com>

<http://usermanuals.us>

<http://www.somanuals.com>

<http://www.4manuals.cc>

<http://www.manual-lib.com>

<http://www.404manual.com>

<http://www.luxmanual.com>

<http://aubethermostatmanual.com>

Golf course search by state

<http://golfingnear.com>

Email search by domain

<http://emailbydomain.com>

Auto manuals search

<http://auto.somanuals.com>

TV manuals search

<http://tv.somanuals.com>