



30651 Rev. B
October 2006

Operator's Manual for: *NL Series*

Public Use Wheelchair Lifts

DOT — Public Use Lift

"DOT — Public Use Lift" verifies that this platform lift meets the "public use lift" requirements of FMVSS No. 403. This lift may be installed on all vehicles appropriate for the size and weight of the lift, but must be installed on buses, school buses, and multi-purpose passenger vehicles other than motor homes with a gross vehicle weight rating (GVWR) that exceeds 4,536 kg (10,000 lb).

 **THE BRAUN CORPORATION**
"Providing Access to the World"®

International Corporate Hdqrs: P.O. Box 310 Winamac, IN 46996 USA
1-800-THE LIFT (574) 946-6153 FAX: (574) 946-4670



Patent #5,261,779

Patent #6,065,924

Patent #6,238,169

Patent #6,464,447

Patent #6,599,079

Patent #6,692,217

Patent #6,739,824

Patents Pending

Download from www.Somanuals.com. All Manuals Search And Download.

WARNING

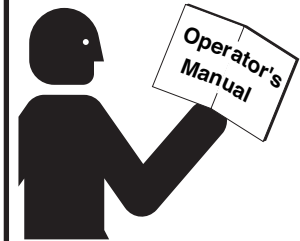

Read manual before operating lift. Failure to do so may result in serious bodily injury and/or property damage. Keep manual in lift storage pouch.

Congratulations

We at The Braun Corporation wish to express our fullest appreciation on your new purchase. With you in mind, our skilled craftsmen have designed and assembled the finest lift available.

This manual includes safety precautions, lift operating instructions, manual operating instructions, and instructions for maintenance and lubrication procedures.

Your lift is built for dependability, and will bring you years of pleasure and independence, as long as maintenance is performed regularly and the lift is operated by an instructed person.

Sincerely,

THE BRAUN CORPORATION

A handwritten signature in black ink that reads "Ralph W. Braun". The signature is written in a cursive style with a large, prominent "R" and "B".

Ralph W. Braun
Chief Executive Officer

Contents

| | | | |
|---|--------|--|--------|
| Warranty/Registration Instructions | 2, 3 | Outer Barrier Latch | 20, 21 |
| Lift Terminology | | Outer Barrier and Latch Operation | 21 |
| Lift Terminology Illustration | 4 | Bridging | 21 |
| Introduction | 5 | Handrails | 21 |
| Direction | 5 | Lift Passengers | |
| Lift Components | 6, 7 | Passenger Orientation (Boarding Direction) | 22 |
| Vehicle and Lift Interlocks | 7 | Standees | 22 |
| Lift Actions and Functions | 8 | Yellow Boundaries | 22, 23 |
| Lift Operation Safety | | Vehicle (Floor Level) Loading and Unloading | 23, 24 |
| Safety Symbols | 9 | Wheelchair-Equipped Occupant Seat Belts | 25 |
| Lift Operation Safety Precautions | 10-13 | Operation Procedure Review | 25, 26 |
| Operation Notes and Details | | Preventive Maintenance | 26 |
| Introduction/Lift Access Doors and Interlocks | 14 | Lift Operating Instructions | 27-31 |
| General Safety | 15 | NHTSA Operations Checklist | 32 |
| Control Switches | 15 | Manual Operating Instructions | 33-37 |
| Lift Features | | Decals and Antiskid | 38-40 |
| Lift-Tite Latches™ | 16, 17 | Maintenance and Lubrication | 41-49 |
| Inner Roll Stop | 18, 19 | | |
| Outer Barrier | 19, 20 | | |

Warranty and Registration Instructions

Immediately upon receiving your lift, examine the unit for any damage. Notify the carrier at once with any claims.

Two warranty/registration cards (shown below) are located in the pump cover owner's manual storage pouch. The sales representative must process one of the cards. The consumer must fill out

the other card and mail it to The Braun Corporation. The warranty is provided on the back cover of this manual. The **warranty cards must be processed to activate the warranty.**

Two Braun Serial No./Series No. identification tags are posted on the lift. One I.D. tag (shown below) is posted on the opposite pump side

vertical arm. A second I.D. tag is located on the opposite pump side tower. Both I.D. tags provide the product identification information appearing on the Warranty/Registration card. Record the information in the space provided on the next page.

This information must be provided when filing a warranty claim or ordering parts.

Series No. Pump Code
Model No. Serial No. Cylinder Code

| OWNER WARRANTY REGISTRATION | |
|---|-----------------------|
| NL9171B-04-02730-56-14CG | |
| PURCHASED FROM _____ | |
| OWNER _____ | |
| NAME _____ | DATE INSTALLED _____ |
| ADDRESS _____ | |
| CITY _____ | |
| TELEPHONE _____ | STATE _____ ZIP _____ |
| TO VALIDATE WARRANTY REGISTRATION CARDS MUST BE RETURNED TO THE BRAUN CORPORATION. | |

Sample
Warranty/Registration
Card

Sample
Serial No./Series No.
Identification Tag

| The Braun Corporation 1-800-THE LIFT™ BRAUNLIFT.COM™ | |
|--|----------|
| DOT Public Use Lift MODEL# | |
| NL9171B | |
| Max. Lifting Capacity - 800 lbs. | |
| SERIAL NUMBER | |
| 04-02730 | |
| PUMP CODE | CYLINDER |
| 56 | 14CG |
| MFG DATE | |
| 5/8/06 | |
| e5*72/245*95/54*0110*00 | |
| PATENT | |
| PENDING- 5,261,779-6,085,924-6,238,169-6,46 | |
| 4,447-6,599,079-6,692,217-6,739,824 | |

Warranty and Registration Instructions

Model No. _____ Pump Code _____

Series No. _____ Cylinder Code _____

Serial No. _____ Date of Manufacture _____

Note: This information **must be provided** when filing a warranty claim or ordering parts. Keep for future use.

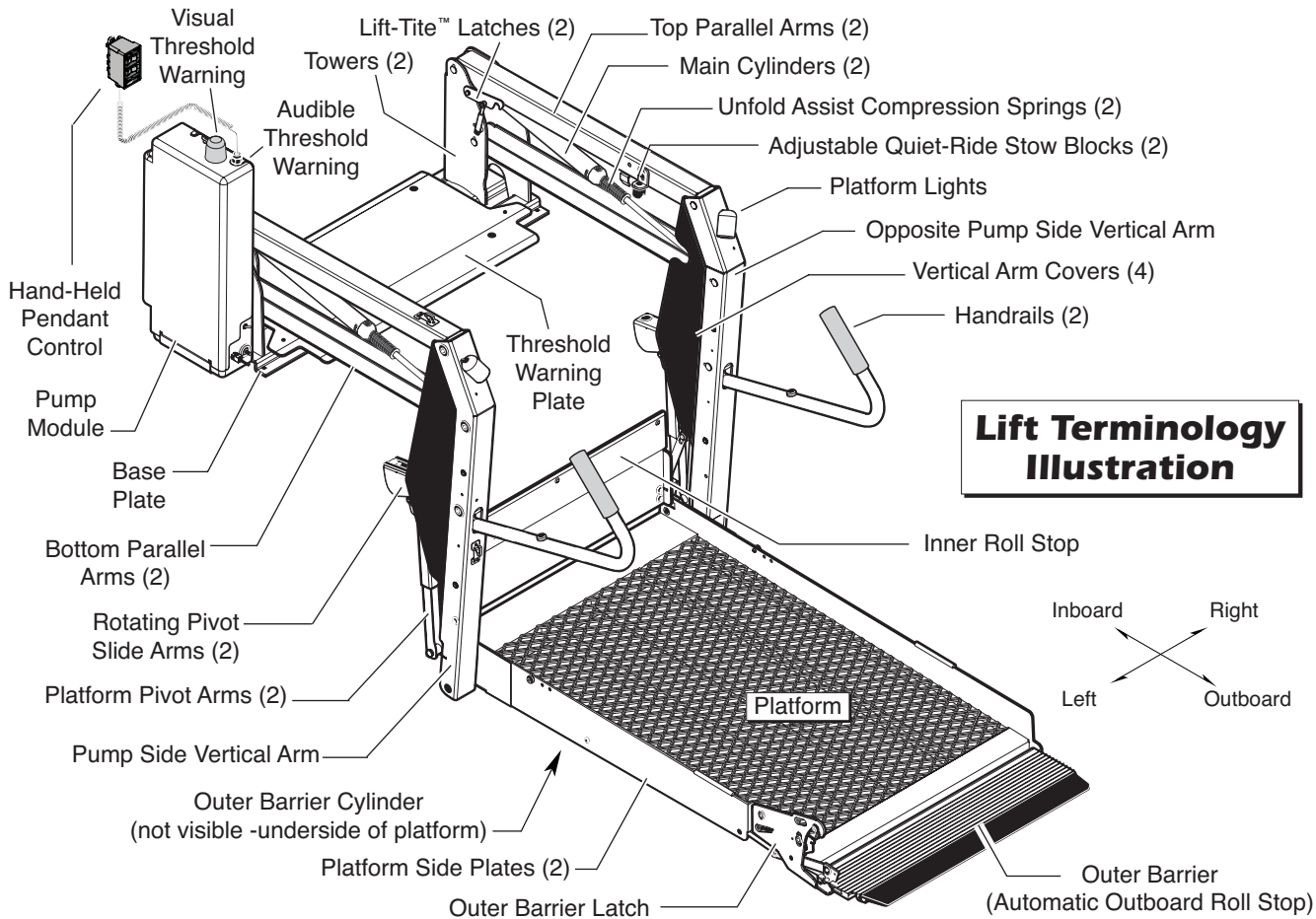

Lift Terminology

Introduction:

Braun NL Millennium Series lifts are ADA compliant and comply fully with National Highway Traffic Safety Administration (NHTSA) specifications. The NL is commercial oriented (intended for operation by an attendant).

Lift models vary per size (lift model numbers indicate lift dimensions). NL Series lift models can be equipped with left or right side pump modules as needed. A left side pump-equipped lift model is depicted in the Lift Terminology Illustration (NL917IB). Right side pump lift models are a mirrored image of rear pump models

(pump module located on opposite end of base plate).

Refer to the Lift Terminology Illustration for identification of lift components.

Lift operation procedures are identical for all NL Series lift models. The operating instructions contained in this manual and appearing on lift-posted operating instructions decals address the lift control switches and the corresponding lift functions. Instructions are provided for manual operation of the lift in event of power or equipment failure.

Terminology: Become familiar with the terminology that will be used throughout this manual. Become familiar with the identification of lift components and their functions. Contact your lift sales representative or call The Braun Corporation at 1-800-THE LIFT® if any of this information is not fully understood.

Direction: The terms "left," "right," "inboard," and "outboard" will be used throughout this manual to indicate direction (as viewed from outside the vehicle looking directly at the lift). Refer to the Lift Terminology Illustrations for clarification of direction terms.

Lift Terminology

Lift Components

Refer to the Lift Terminology Illustration on page 4.

Pump Module: The lift-mounted pump module consists of the hydraulic pump, the manual hand pump, the electronic control board and electrical components that power the lift electric/hydraulic systems.

Hand-held Pendant Control: The hand-held attendant's pendant control is connected to the pump module. The hand-held pendant is equipped with two rocker switches, (UNFOLD, FOLD, DOWN, and UP). The momentary switches activate the automatic lift functions.

Lift Frame: The lift frame consists of the base plate, threshold warning plate, towers, parallel arms, vertical arms, platform pivot arms and handrails. Two main hydraulic cylinders are housed in the parallel arms. The electrical/hydraulic powered lift frame components mechanically unfold, lower, raise and fold the lift platform assembly.

Platform Assembly: The platform assembly consists of the steel tubing frame with grating surface upon which the wheelchair is positioned, the outer barrier, outer barrier latch, the inner roll stop, and the hydraulic cylinder assembly that powers the outer barrier.

Lift-Tite™ Latches: The spring-loaded latches prevent the platform from unfolding from the stowed position in the event of platform drift. Further details regarding Lift-Tite™ latches are provided on pages 16 and 17.

Outer Barrier: The cylinder-powered automatic outer barrier provides a ramp for wheelchair loading and unloading at ground level. Photos and further details regarding the outer barrier are provided in the Operation Notes section (pages 19-21).

Outer Barrier Latch: The spring-loaded latch locks the outer barrier in the vertical position when the platform raises above ground level.

Lift Terminology

Inner Roll Stop: NL Series lift models are equipped with an automatic inboard roll stop that also serves as the bridge plate. The roll stop bridges the gap between the lift platform and the vehicle floor. The inner roll stop automatically rotates from the horizontal position to the vertical position as the lift lowers and raises. Further details regarding the automatic mechanical inboard roll stop are provided on pages 18 and 19.

Vehicle and Lift Interlocks

Braun Corporation NL9171B Series lifts comply fully with all NHTSA vehicle and lift interlock specifications. Vehicle movement is prohibited unless the lift is fully stowed and the lift will not function unless the vehicle is parked and secured.

The NL features a visible and audible threshold warning system that will activate if the threshold area is occupied when the platform is one inch or more below floor level.

The inner roll stop and outer barrier sense weight to prohibit lift operation. The lift will not function if the inner roll stop or

the outer barrier are occupied. The lift platform cannot be folded (stowed) if occupied.

The inner roll stop features a locking mechanism that prohibits the platform from lowering if the lock does not engage. The lift platform cannot be raised more than 3" above ground level unless the outer barrier is in the vertical position and the outer barrier latch is positively engaged.

Lift Terminology

Lift Actions and Functions

DEPLOY (A-C)

A. UNFOLD (Out) - Platform

Unfold: Unfold is the action of the platform rotating out and down from the fully-stowed (vertical) position to floor level (horizontal) position when the UNFOLD switch is pressed.

B. DOWN - Platform Lower:

Down is the action of the platform lowering from floor level position to fully-lowered (ground level) position when the DOWN switch is pressed.

C. DOWN - Outer Barrier

Unfold (Deploy) - When the platform reaches the fully-low-

ered (ground) position and the DOWN switch is continued to be pressed, the outer barrier rotates downward from vertical position to ramp position.

STOW (D-F)

D. UP - Outer Barrier Fold

(Raise): When the lift is fully lowered and the outer barrier is in the ramp position, pressing the UP switch first rotates the outer barrier upward from ramp position to vertical position.

E. UP - Platform Raise: Up is the action of the platform raising from ground level to floor level (fully-raised) position when the UP switch is pressed.

F. FOLD (In) - Platform Fold:

Fold is the action of the platform rotating up and in from the floor level (horizontal) position to fully-stowed (vertical) position when the FOLD switch is pressed.

Stowed Position: The lift is stowed when the lift platform has been fully raised and folded fully (vertical position).

Floor Level: Floor level is the position (height) the platform assembly reaches in order for the wheelchair passenger to enter and exit the vehicle (fully raised). The platform automatically stops at floor level when unfolding from the stowed position and when raising from ground level.

Lift Operation Safety

Safety Symbols

SAFETY FIRST! Know That....

A All information contained in this manual and supplements (if included), is provided for your safety. Familiarity with proper operation instructions as well as proper maintenance procedures are necessary to ensure safe, troublefree operation. Safety precautions are provided to identify potentially hazardous situations and provide instruction on how to avoid them.

B



C

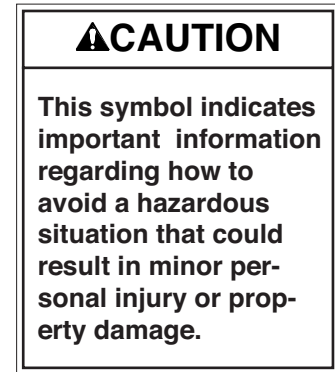

D **Note:** Additional information provided to help clarify or detail a specific subject.

These symbols will appear throughout this manual as well as on the labels posted on your lift. **Recognize the seriousness of this information.**

Lift Operation Safety

Lift Operation Safety Precautions

WARNING

If the lift operating instructions, manual operating instructions and/or lift operation safety precautions are not fully understood, contact The Braun Corporation immediately. Failure to do so may result in serious bodily injury and/or property damage.

 **WARNING** Read manual and supplement(s) before operating lift. Read and become familiar with all safety precautions, operation notes and details, operating instructions and manual operating instructions before operating the lift. **Note:** Wheelchair passengers and all transit agency personnel (drivers and wheelchair lift attendants) must read and become familiar with the contents of this manual and supplement(s) before operation.

 **WARNING** Load and unload on level surface only.

 **WARNING** Engage vehicle parking brake before operating lift.

 **WARNING** Provide adequate clearance outside the vehicle to accommodate the lift before opening lift door(s) or operating lift.

 **WARNING** Inspect lift before operation. Do not operate lift if you suspect lift damage, wear or any abnormal condition.

 **WARNING** Keep operator and bystanders clear of area in which the lift operates.

Lift Operation Safety

⚠️WARNING

Whenever a wheelchair passenger (or standee) is on the platform, the:

- Passenger must be positioned fully inside yellow boundaries
- Wheelchair brakes must be locked
- Inner roll stop and outer barrier must be up (vertical)
- Outer barrier latch must be fully engaged
- Passenger should grip both handrails (if able).

⚠️WARNING

Load and unload clear of vehicular traffic.

⚠️WARNING

Do not overload or abuse. The load rating applies to both the raising and lowering functions - continuous lifting capacity is 800 lbs.

⚠️WARNING

Discontinue lift use immediately if any lift or vehicle interlock does not operate properly.

⚠️WARNING

Do not operate or board the lift if you or your lift operator are intoxicated.

⚠️WARNING

Do not raise front wheelchair wheels (pull wheelie) when loading (boarding) the platform.

⚠️WARNING

Open lift door(s) fully and secure before operating lift.

⚠️WARNING







Position and secure (buckle, engage, fasten, etc.) the wheelchair-equipped occupant seat belt (torso restraint) before loading onto the wheelchair lift platform.

Lift Operation Safety

Lift Operation Safety Precautions (continued)

WARNING

If the lift operating instructions, manual operating instructions and/or lift operation safety precautions are not fully understood, contact The Braun Corporation immediately. Failure to do so may result in serious bodily injury and/or property damage.

-  WARNING** Lift attendants must ensure that lift occupants keep hands, arms and all other body parts within the lift occupant area and clear of moving parts.
 -  WARNING** Platform must be positioned at floor level (roll stop height) when loading or unloading in and out of vehicle.
 -  WARNING** Do not use platform inner roll stop or outer barrier as a brake. Stop and brake wheelchair when loading onto the platform (manually stop and brake manual wheelchairs — stop powered wheelchairs with the wheelchair controls).
 -  WARNING** Turn powered (electric) wheelchairs off when on lift platform.
 -  WARNING** Press the DOWN switch until the entire platform rests on ground level (lowered fully) and the outer barrier is fully unfolded (ramp position) before loading or unloading a passenger at ground level.
-  WARNING** Outer barrier must be fully unfolded (ramp position) until front and rear wheelchair wheels cross the barrier when loading or unloading at ground level.

Lift Operation Safety

- ⚠WARNING** Accidental activation of control switch(es) may cause unintended operation(s).
- ⚠WARNING** Maintenance and lubrication procedures must be performed as specified in this manual by authorized (certified) service personnel.
- ⚠WARNING** Replace missing, worn or illegible decals.
- ⚠WARNING** Keep owner's (operator's) manual in lift-mounted manual storage pouch at all times.
- ⚠WARNING** Never modify (alter) a Braun Corporation lift.
- ⚠WARNING** Do not use accessory devices not authorized by The Braun Corporation.
- ⚠WARNING** Do not remove any guards or covers.
- ⚠WARNING** Keep clear of any hydraulic leak.
- ⚠WARNING** Failure to follow these safety precautions may result in serious bodily injury and/or property damage.

Operation Notes and Details

WARNING

Read and become familiar with all lift operation safety precautions, operation notes and details, operating instructions and manual operating instructions prior to operating the lift. If this information is not fully understood, contact The Braun Corporation immediately. Failure to do so may result in serious bodily injury and/or property damage.

NL Series “Public Use” lift models are specifically designed to be operated by an attendant. The Lift Operating Instructions contained in this manual and posted on the lift provide instructions for operation of the lift **only**. Read and become familiar with all lift operation safety precautions, operation notes and details, operating instructions and manual operating instructions before attempting lift operation procedures.

Lift Access Doors and Interlocks: Attendants **must** become familiar with the vehicle lift access door system and vehicle interlock system(s). Transit vehicles and lift access door configurations vary. Door securement devices (latches, hooks, cables, etc.) and procedures to operate them vary.

Instructions for operation of vehicle interlocks and door securement systems are not addressed in this manual or on lift-posted operating instructions decals due to the variety of procedures required for operating them. Braun Corporation NL Series lifts comply fully with all NHTSA vehicle and lift interlock specifications (detailed on pages 7 and 32). Infringement of any lift interlock will prohibit lift operation.

It is the responsibility of the lift operator (attendant) to properly open, secure and close the vehicle lift door(s), to activate the vehicle interlock(s), to load and unload the wheelchair passenger (or standee) on and off the lift platform, and to properly activate all lift functions.

Operation Notes and Details

General Safety: The lift operator (attendant) and bystanders must keep clear of the area in which the lift operates and clear of all moving parts. Lift attendants

must ensure that lift occupants (passengers) keep hands, arms and all other body parts within the lift occupant area and clear of moving parts.

Control Switches

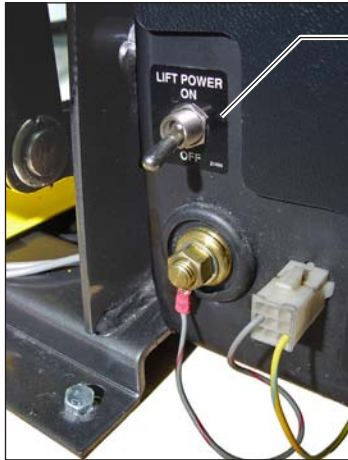

Lift Power ON/OFF Switch:

This switch must be in the ON position in order to activate the lift. The green Power Indicator Light mounted on top of the pump module illuminates to signal power to the lift.

Hand-held Pendant Control:

The hand-held attendant's pendant control is equipped with two rocker switches, (UNFOLD, FOLD, DOWN, and UP). The momentary switches activate the automatic lift functions.

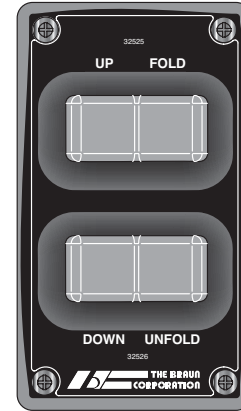

Hand-held Pendant

Simply press the switch labeled for the intended function.

Operation Notes and Details

Lift Features

Become familiar with all lift features and the proper operation of the lift components **before** attempting lift operation. Refer to the Lift Terminology Illustrations

for identification of specific lift components if not clearly depicted in this section. Contact The Braun Corporation at 1-800-THE LIFT® immediately if any of this

information is not understood.

Lift-Tite™ Latches: NL Series lifts are equipped with Lift-Tite™ Latches. Lift-Tite™ Latches pre-

⚠ WARNING

Discontinue lift use immediately if any lift component does not operate properly. Failure to do so may result in serious bodily injury and/or property damage.

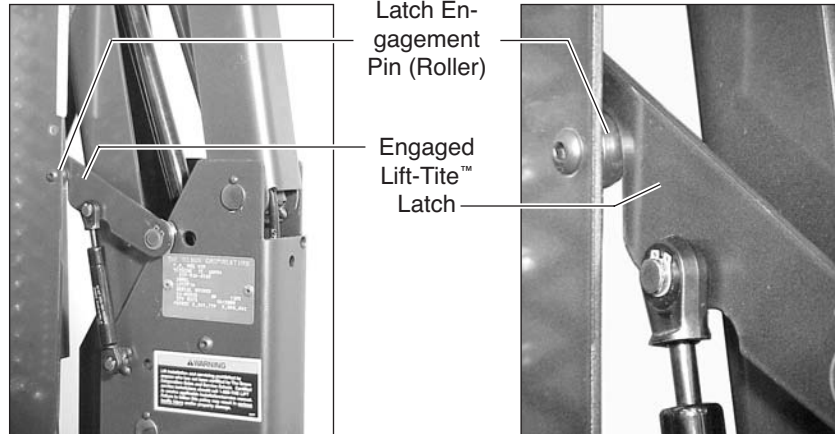

Operation Notes and Details

vent the platform from unfolding from the stowed position in the event of platform drift. Due to the “all-hydraulic” operation of the dual-cylinder NL, hydraulic fluid expansion, contraction or seepage may occur. Any of these conditions may result in platform drift (failure to hold the platform in the folded or raised position). Platform drift may occur during lift shipment and/or between extended periods of non-lift use.

In the event that the platform does not unfold when the UNFOLD switch is pressed, press the FOLD switch momentarily to disengage the Lift-Tite™ latches (platform drift has occurred). Then, press the UNFOLD switch to unfold the

platform to floor level (standard operation).

When manually operating a lift equipped with Lift-Tite™ latches, insert the pump handle in the pump and stroke until the platform folds fully (stops). Then,

open the hand pump valve (turn counterclockwise) to unfold the platform. Folding the platform fully first will ensure that the Lift-Tite™ latches will disengage properly when the release valve is opened. Manual Operating Instructions are provided on pages 33-37.

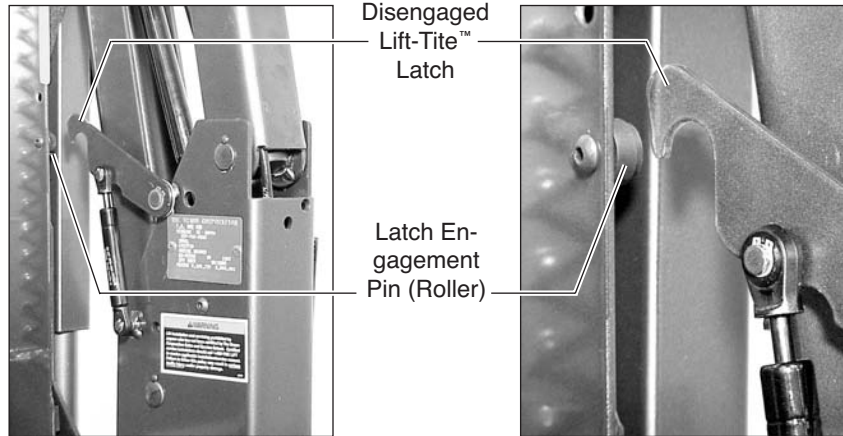

Operation Notes and Details

Lift Features (continued)

Inner Roll Stop: NL Series lift models are equipped with an automatic inner roll stop that also serves as the bridge plate (inner roll stop photos below).

When the UNFOLD switch is

pressed and the platform unfolds from stow position to floor level, this mechanical roll stop is automatically deployed to the bridging (horizontal) position to provide a bridge plate between the platform and the lift base plate (vehicle floor). The inboard edge of the bridge plate rests on the threshold warning plate (base plate).

The roll stop automatically folds (rotates) to the vertical (roll stop) position when the platform lowers to the ground (DOWN switch is pressed).

As the UP switch is pressed and the platform raises from ground level, the inner roll stop automatically unfolds (rotates) to the



Fully-Deployed (vertical)
Inner Roll Stop

Fully-Unfolded (horizontal)
Inner Roll Stop (bridging position)

Inner Roll Stop

The inner roll stop **must overlap** the base plate a **minimum 1/2"**.



Operation Notes and Details



horizontal (bridging) position when it reaches vehicle floor level. The roll stop must overlap the lift base plate a minimum 1/2".

When the FOLD switch is pressed and the platform folds from floor level to the stow (vertical) position, the roll stop auto-

matically travels inboard to the stowed position.

Interlock Features: The inner roll stop features a locking mechanism that prohibits the platform from lowering if the lock is not engaged. The inner roll stop also senses weight to prohibit lift operation. The lift will not function if inner roll stop is occupied.

Discontinue lift operation immediately if the inner roll stop does not operate properly.

Outer Barrier: This cylinder-powered barrier provides a ramp for wheelchair loading and unloading at ground level (see photos on following page). When the platform lowers fully to ground level, the cylinder compression spring

automatically unfolds (rotates) the barrier to the ramp position (fully unfolded).

Although the outer barrier is lift-powered, the activation of the barrier is controlled by the lift operator (attendant). Pressing the DOWN switch unfolds the barrier. The outer barrier is cylinder-powered to automatically fold (rotate) to the vertical position as shown when the UP switch is pressed (barrier raises before platform raises).

Interlock: The outer barrier senses weight to prohibit lift operation. The lift will not function if the outer barrier is occupied.

Operation Notes and Details

Lift Features (continued)

Discontinue lift operation immediately if the outer barrier does not operate properly.

Outer Barrier Latch: A spring-loaded latch engages the outer

barrier when the barrier rotates upward from ramp position to the vertical position (UP switch is pressed to raise the platform above ground level). **Note:** The platform must raise approximately three inches **before** the latch engages **fully** (see photos on

previous page).

Interlock: Lift platform movement shall be interrupted unless the outer barrier is raised (vertical position) and the outer barrier latch is positively engaged.

Fully-Engaged Outboard Barrier Latch

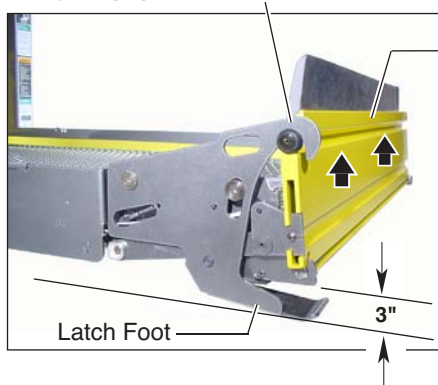

Fully-Folded Outer Barrier (Up-vertical)

Disengaged Outer Barrier Latch

Outer Barrier

Note: Platform must raise **approximately** three inches **before** latch engages **fully**.

Fully-Unfolded Barrier (Ramp position)

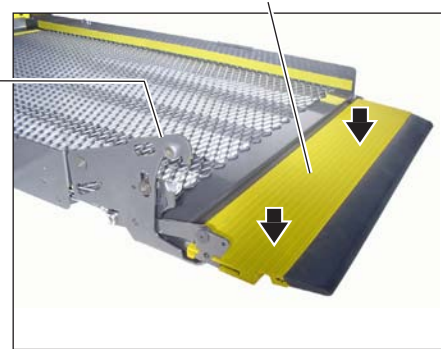

Operation Notes and Details

The latch disengages the barrier when the platform lowers fully (reaches ground level) and the latch foot contacts the ground (latch raises above the barrier).

Outer Barrier and Latch Operation: The lift attendant must press the DOWN switch to lower the platform fully to the ground. The attendant **must view** the platform as it lowers to **be certain** the **entire platform** reaches and rests safely on the ground. Stop pressing the DOWN switch if any portion of the platform is obstructed while descending or the entire platform does not reach ground level **for any reason** (contact with an obstruction, mechanical failure, exceeding the lift “floor-to-ground” capacity, etc.).

After the platform is fully lowered, the attendant should continue to press the DOWN switch to unfold the outer barrier **fully** (ramp position). **Note:** The barrier **must be fully unfolded** until the entire wheelchair (or standee) has crossed the barrier when loading or unloading at ground level. **Discontinue lift operation immediately if the outer barrier or latch do not operate properly.**

Bridging: The NL incorporates a bridging feature. This feature stops the down travel of the platform if the outboard end of the platform contacts a raised surface (such as a curb), preventing the operator from lowering the inboard end of the platform.

Handrails: Dual handrails are provided for wheelchair passenger (or standee) use. The handrails unfold automatically to the deployed (horizontal) position when the lift unfolds and automatically fold to the stowed (vertical) position when the platform folds.

If able, passengers should grip both handrails when on the lift platform. **Discontinue lift operation immediately if the handrails do not operate properly.**

Operation Notes and Details

Lift Passengers

If you are an attendant operating the lift, it is your responsibility to perform safe loading and unloading procedures. Wheelchair lift attendants should be instructed on any special needs and/or procedures required for safe transport of wheelchair passengers.

The lift operator and bystanders must keep clear of the area in which the lift operates. Observe your passenger at all times during lift operation.

Do not attempt to load or unload a passenger in a wheelchair or other apparatus that does not fit on the platform area. Do not exceed the 800 pound load capacity

of the lift. The lift attendant should not ride on the platform with the passenger.

Passenger Orientation (Boarding Direction): Braun NL Series wheelchair lifts accommodate **both** inboard and outboard facing wheelchair passengers **or** standees. Inboard facing of wheelchair lift passengers is **not prohibited**, but outboard facing of passengers is **recommended** by The Braun Corporation.

Braun NL Series lifts permit both inboard and outboard facing of wheelchair and mobility aid users **and** accommodate persons using walkers, crutches, canes or braces or who otherwise have difficulty using steps.

Standees: Lift Operating Instructions apply to wheelchair passengers and standees. Standees should stand in the center of the platform (**fully inside the yellow boundaries**) and grip both handrails (if able) when on platform.

Yellow Boundaries: The passenger **must** be positioned in the **center of the platform** to prevent side-to-side load imbalance. The lift attendant (operator) should **not** ride on the platform with the passenger.

Yellow platform loading boundaries are identified in the following manner. The yellow powder-coated inner roll stop and outer barrier identify the inboard and outboard ends of the platform. A yellow powder-coated guard is lo-

Operation Notes and Details

cated on the pump-side platform side plate. A yellow boundary strip decal is affixed to the opposite platform side plate. Yellow plastic caps are placed on the dual handrails.

The threshold warning plate is powder-coated yellow to identify the platform threshold area.

Interlock: A visible and audible threshold warning system will activate if the threshold area is occupied when the platform is one inch or more below floor level.

The attendant must always be certain the wheelchair passenger or standee is properly positioned on the platform (**fully inside yellow boundaries**) and the wheelchair brakes are locked when a passenger is on the lift platform.

The lift passenger must keep hands, arms and all other body parts within the lift occupant area and clear of all moving parts.

Vehicle (Floor Level) Loading and Unloading: The platform must be fully raised (at floor level) and the bridge plate must be properly positioned when loading or unloading passengers in or out of the vehicle. **It is the responsibility of the lift attendant to ensure the platform and the bridge plate are properly positioned at floor level when loading and unloading passengers.**

WARNING

Whenever a passenger is on the platform, the:

- Passenger must be positioned fully inside yellow boundaries
- Wheelchair brakes must be locked
- Inner roll stop and outer barrier must be UP

Failure to follow these rules may result in serious bodily injury and/or property damage.

Operation Notes and Details

Lift Passengers (continued)

The wheelchair **brakes must be locked**, the outer barrier must be in the **fully-up** (vertical) position and the outer barrier latch must be **fully engaged whenever a passenger is on the platform**.

Do not use the outer barrier as a brake. Stop and brake the wheelchair when fully loaded on the platform. Manually stop and brake manual wheelchairs. Stop powered wheelchairs with the wheelchair controls. Turn powered (electric) wheelchairs off when on the platform.

If the outer barrier, inner roll stop, handrails or any other lift component does not operate as

outlined in this manual, **discontinue lift use immediately** and contact The Braun Corporation sales representative in your area or call The Braun Corporation at 1-800-THE LIFT®. One of our national Product Support representatives will direct you to an authorized service technician who will inspect your lift.

WARNING

Discontinue lift use immediately if any lift component does not operate properly. Failure to do so may result in serious bodily injury and/or property damage.

Operation Notes and Details

Wheelchair-Equipped Occupant Seat Belts

The Braun Corporation recommends wheelchair passengers position and buckle their wheel-

WARNING

Position and secure (buckle, engage, fasten, etc.) the wheelchair-equipped occupant seat belt before loading onto the wheelchair lift platform. Failure to do so may result in serious bodily injury and/or property damage.

chair-equipped seat belt (torso restraint) **before** loading onto a wheelchair lift.

Different types of disabilities require different types of wheelchairs and different types of wheelchair-equipped occupant restraint belt systems (torso restraints). It is the responsibility of the wheelchair passenger to have his or her wheelchair equipped with an occupant restraint (seat belt) under the direction of their health care professional.

Wheelchair lift attendants should be instructed on any special needs and/or procedures required for safe transport of wheelchair passengers.

Operation Procedure Review

The Braun Corporation recommends that transit agency supervisors and wheelchair lift attendants review the safety precautions and operation procedures appearing in this manual and on lift-posted decals with your wheelchair lift sales representative (dealer), **before** attempting lift operation.

Any questions or concerns can be answered by the sales representative at that time. Operate the lift through all functions with your sales representative on hand to ensure the proper use and operation of the wheelchair lift is understood.

Operation Notes and Details

Transit agency supervisors should train and educate their lift attendants on the proper use and operation of the wheelchair lift if it is not possible for the attendants to review the safety precautions and operation procedures with the wheelchair lift sales representative.

The lift operator's **manual must be stored in the lift-mounted manual storage pouch at all times.**

Preventive Maintenance:

Maintenance is necessary to ensure safe and troublefree lift operation. General preventive lift maintenance consisting of **careful** inspections of the lift system and cleaning the lift should be

a part of your transit agency's daily lift service program. Simple inspections can detect potential lift operational problems.

Regular preventive maintenance will reduce potential lift operation downtime and increase the service life of the lift, as well as possibly detecting potential hazards.

Exposure to harsh weather elements, environmental conditions, or heavy usage may require more frequent maintenance and lubrication procedures.

Preventive maintenance visual inspections **do not** take the place of the procedures specified in the Maintenance and Lubrication Schedule provided on pages

41-49 of this manual. Refer to the Maintenance and Lubrication section for further details.

WARNING

Maintenance and lubrication procedures must be performed by authorized service personnel as specified in this manual. Failure to do so may result in serious bodily injury and/or property damage.

Lift Operating Instructions

⚠️ WARNING

Read and become familiar with all lift operation safety precautions, operation notes and details, operating instructions and manual operating instructions prior to operating the lift. If this information is not fully understood, contact The Braun Corporation immediately. Failure to do so may result in serious bodily injury and/or property damage.

⚠️ WARNING

Whenever a passenger is on the platform, the:

- Passenger must be positioned fully inside yellow boundaries
- Wheelchair brakes must be locked
- Inner roll stop and outer barrier must be UP

Failure to follow these rules may result in serious bodily injury and/or property damage.

Before lift operation, park the vehicle on a level surface, away from vehicular traffic. Place the vehicle transmission in "Park" and engage the parking brake.

Lift Operating Instructions photos depict lift model NL9171B. Instructions and procedures are applicable for all NL Series lift models. Lift-posted Warnings and Lift Operating Instructions decal 30695 provides lift operating instructions. Replace any missing, worn or illegible decals.

If your lift does not function as intended or an audible warning signal is activated, review the NHTSA Operations Checklist on page 32. Follow the Manual Operating Instructions on pages 33-37 in the event of a power or equipment failure.

Lift Operating Instructions



Open Door(s) and Secure

To Unfold Platform:

Stand clear and press the UN-FOLD switch until the platform stops (reaches **floor level** - unfolds **fully**). Release switch.

Note: In event platform does not unfold, press FOLD switch to release Lift-Tite™ latches.

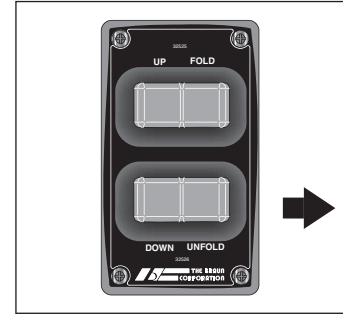

To Unload Passenger:

1. Read Note below! Load passenger onto platform and **lock** wheelchair brakes.

Note: Passenger **must** be positioned **fully inside yellow boundaries**, outer barrier **must** be UP and outer barrier latch **must** be engaged.



Lift Operating Instructions

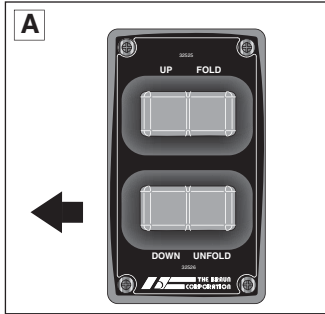

To Unload Passenger (continued):

2. Press DOWN switch until the **entire** platform reaches ground level (see Photo B) and the outer barrier **unfolds fully** (ramp position). See Photo C. Release switch.



3. Unlock wheelchair brakes and unload passenger from platform.

Note: Outer barrier **must** be **fully unfolded** (ramp position) until the entire wheelchair (or standee) has crossed the outer barrier. See Photos E and F on page 30 also.



Lift Operating Instructions

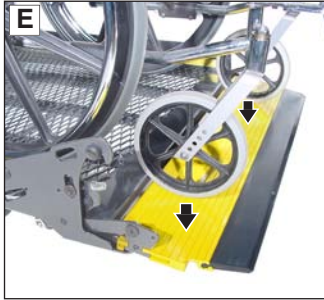

To Load Passenger:

1. **Read Notes below!** Load passenger onto platform and **lock** wheelchair brakes. See Photo G.

◀ **Note:** Outer barrier **must** be **fully unfolded** (ramp position) until the entire wheelchair (or standee) has crossed the outer barrier. See Photos E and F. ▶

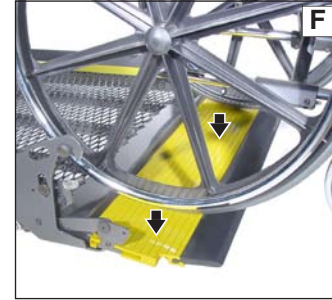

◀ **Note:** Passenger **must** be positioned **fully inside yellow boundaries**. ▶

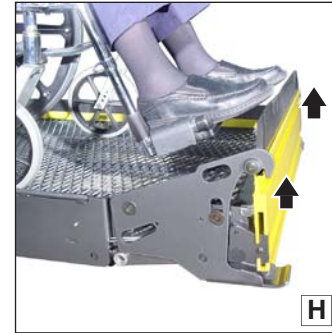

Lift Operating Instructions

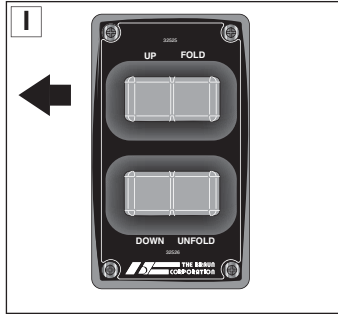

To Load Passenger (continued):

2. Press UP switch (Photo I) to fold outer barrier UP **fully** (vertical - see Photo H), and raise the platform to **floor level**. See Photo J. Release switch.
3. Unlock wheelchair brakes and unload passenger from platform.

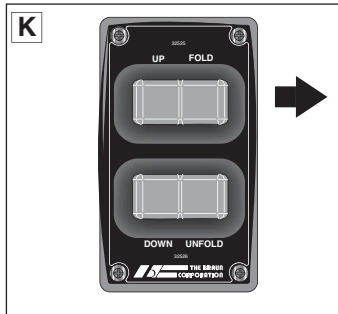

To Fold Platform:

- Press FOLD switch until platform stops (**fully** folded). See Photos K and L. Release switch.

Close Door(s)



NHTSA Operations Checklist

The following operations have been verified upon installation. This operational checklist can be used at any time to verify the lift is fully functional.

Verified:

- Vehicle movement is prevented unless the lift door is closed, ensuring the lift is stowed.
 - Lift operation shall be prevented unless the vehicle is stopped and vehicle movement is prevented.
 - The platform will not fold/stow if occupied.
 - The inner roll stop will not raise if occupied.
 - The outer barrier will not raise if occupied.
 - Verify platform lighting* when lift is deployed and pendant illumination when it is powered.
 - An audio warning (and visual warning for public lifts) will activate if the threshold area is occupied when the platform is at least one inch below floor level.
- Lowering the platform beyond the inner roll stop locking position is allowed only when the inner roll stop is locked in position.
 - Lift platform movement shall be interrupted unless the outer barrier is raised and the outer barrier latch is positively engaged.

WARNING

Discontinue lift use immediately if any lift or vehicle interlock does not operate properly. Failure to do so may result in serious bodily injury and/or property damage.

*Public use vehicle manufacturers are responsible for complying with the lift lighting requirements in Federal Motor Vehicle Safety Standard No. 404, Platform Lift Installations in Motor Vehicles (49 CFR 571.404).

Manual Operating Instructions

If you experience power or equipment failure, refer to the Manual Operating Instructions to operate the lift. Instructions and photos are provided for

all steps that differ from standard lift operation procedures. The Manual Instructions decal (posted inside pump cover) provides manual operating

instructions also. **Note:** A right side pump lift model is depicted in the photos. Left side pump applications are a mirrored image. Refer to the Lift Operat-

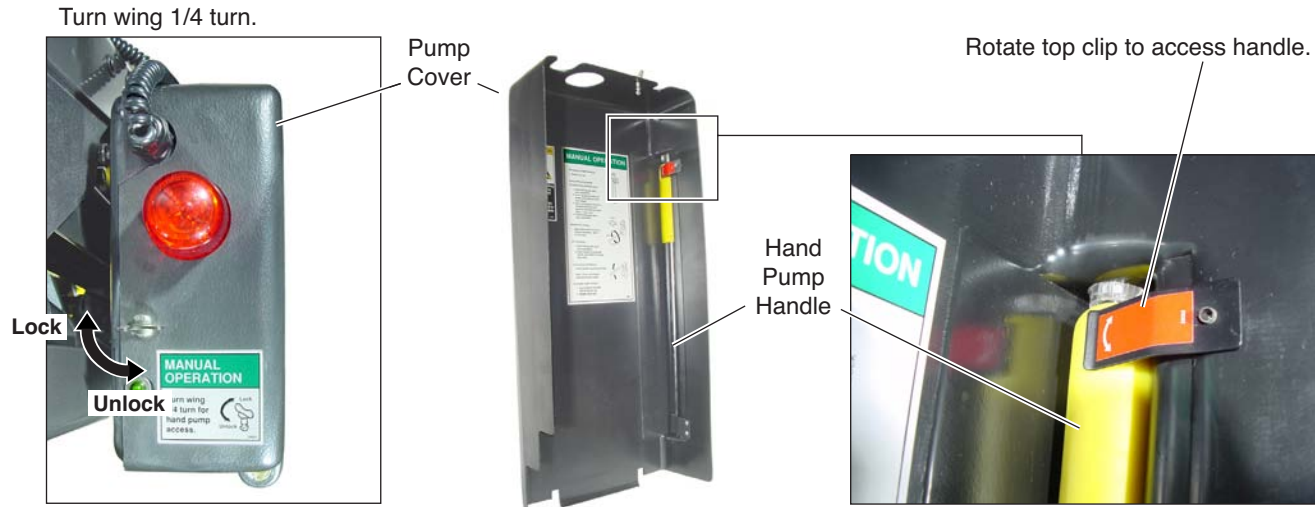

Manual Operating Instructions

ing Instructions for all normal lift operation procedures (such as loading and unloading passengers). **Follow all Lift Operation Safety Precautions!**

Remove the pump cover to gain access to the pump handle and the hand pump. See photos on page 33. To remove the pump cover, turn the wing nut located

on top 1/4 turn and lift the pump cover off. The pump handle is inside this cover secured by two clips. Rotate the top clip to remove the pump handle.

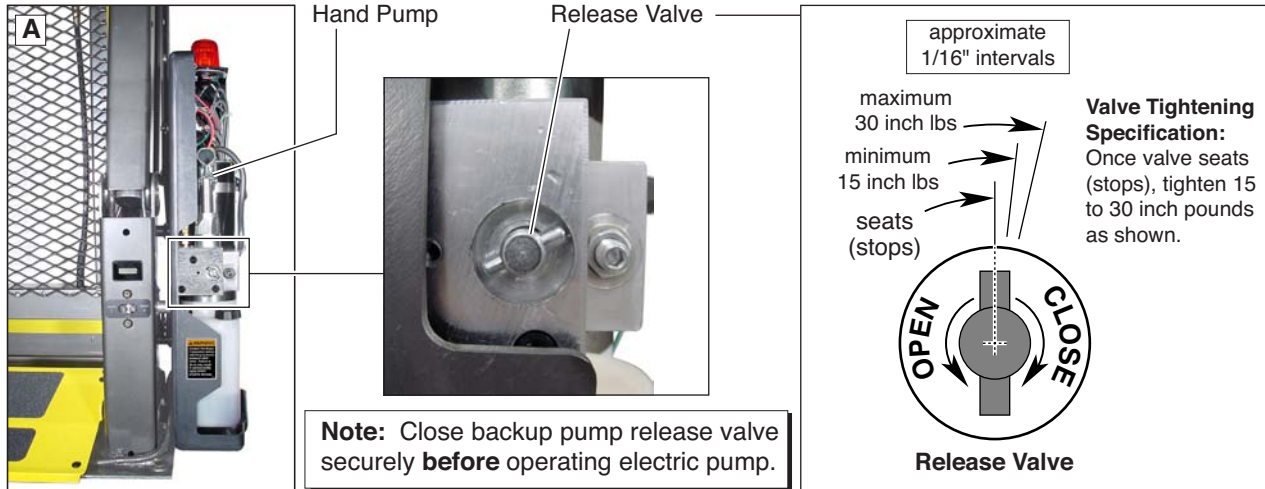

Manual Operating Instructions

Remove pump cover to access hand pump and pump handle as outlined on page 33. Refer to release valve photos and illustration on page 34.



To Unfold Platform (Out):

Using hand pump handle (Photo B):

1. Close hand pump valve (place slotted end of pump handle onto backup pump release valve and turn **clockwise**).
2. Insert handle in pump and stroke until platform folds fully (stops).
3. Open hand pump valve (turn **counterclockwise**) until platform reaches floor level. **Open 1/2 turn only.**
4. Close hand pump valve (turn **clockwise**).

Note: Valve must be tight, but **do not** overtighten.

Down (To Lower):

Place slotted end of pump handle onto backup pump release valve and turn **counterclockwise** (open **1/2 turn only**) until the platform reaches ground level and roll stop unfolds.

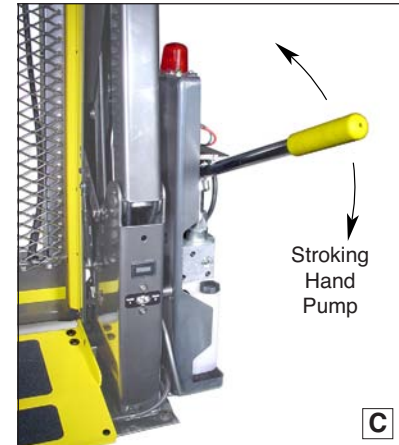

Manual Operating Instructions

Remove pump cover to access hand pump and pump handle as outlined on page 33. Refer to release valve photos and illustration on page 34.



Up (To Raise):

Using hand pump handle:

1. Place slotted end of pump handle onto backup pump release valve and turn **clockwise** to close securely. See Photo D.

Note: Valve must be tight, but **do not** overtighten.

2. Insert handle into backup pump and stroke until platform reaches **floor level** (see Photo E).

To Fold Platform (In):

Insert handle into backup pump and stroke until platform **stops** (folds **fully**). See Photo E.

Note: Close backup pump release valve securely **before** operating electric pump.

Store pump handle and install pump cover as outlined on page 37.

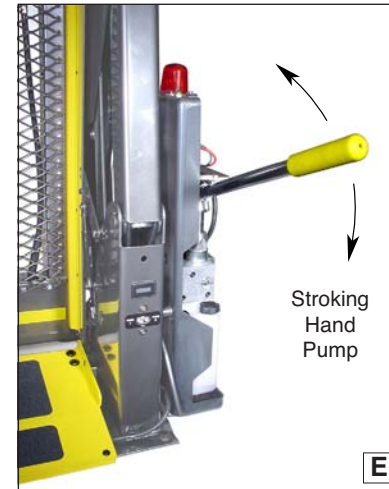

Manual Operating Instructions

To Store Pump Handle:

1. Insert bottom of handle behind bottom clip. See page 33.
2. Rotate top clip to secure (lock) handle.

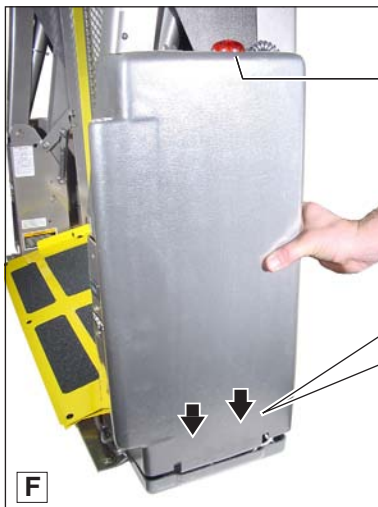

To Install Pump Cover:

1. Position cover over module back cover and red warning light. See Photo F.
2. Align outside cover lip with bottom cover offset and insert outside cover. See Photo G.

Position cover over red light.

Align and insert bottom of cover.



3. Insert wing stud and rotate 1/4 turn to lock cover. See Photo H.



Decals and Antiskid

⚠ WARNING

Replace missing, worn or illegible decals. Failure to do so may result in serious bodily injury and/or property damage.

Note: Clean surfaces as detailed on page 40 before posting decals.

25675

⚠ WARNING

Lift installation and servicing prohibited by anyone who has not been certified by The Braun Corporation Sales and Service School. Certified service technicians should call 1-800-THE LIFT to receive applicable installation/service manual. Failure to follow this policy may result in serious bodily injury and/or property damage.

25675

Decals

30695

The lift is only as safe as the operator. Replace any missing, worn or illegible decals! Part numbers are provided for decals. Inspect your lift for missing, worn or illegible decals. Call 1-800-THE LIFT® for replacements.

29823



29052



31412

MANUAL OPERATION

TO REMOVE PUMP HANDLE:

1. Rotate top clip.

Using hand pump handle:

TO UNFOLD PLATFORM (OUT):

1. Close hand pump valve (turn clockwise).
2. Insert handle in pump and stroke until platform folds fully (stops).
3. Open hand pump valve (turn counterclockwise) until platform reaches floor level. Open 1/2 turn only.
4. Close hand pump valve (turn clockwise).

DOWN (TO LOWER):

Open hand pump valve (turn counterclockwise). Open 1/2 turn only.

UP (TO RAISE):

1. Close hand pump valve (turn clockwise).
2. Insert handle in pump and stroke until platform reaches floor level.

TO FOLD PLATFORM (IN):

Insert handle in pump and stroke.

Note: Close valve before operating electric pump.

TO STORE PUMP HANDLE:

1. Insert bottom of handle behind bottom clip.
2. Rotate clip to lock.

DOT – Public Use Lift

31045

OPERATING INSTRUCTIONS

Read warnings and operate lift as outlined on LIFT OPERATING INSTRUCTIONS decal. Lift operating instructions apply to wheelchair passengers and standees.

Standees: Standees must stand at center of platform (fully inside yellow boundaries), grip handrails and lower head.

Interlocks: Interlocks vary in type and operation. Interlocks must be operational as defined in NHTSA Operations Checklist.

DOT – Public Use Lift

21494



⚠ WARNING

- Read manual before operating lift.
- Load and unload on level surface only.
- Engage vehicle parking brake before operating lift.
- Provide adequate clearance outside of vehicle to accommodate lift.
- Do not operate lift if you suspect lift damage, wear or any abnormal condition.
- Keep operator and bystanders clear of area in which lift operates.

Whenever a wheelchair passenger is on the platform, the:

- Passenger must be positioned fully inside yellow boundaries.
- Wheelchair brakes must be locked.
- Lower roll stop and outer barrier must be up.

Failure to follow these rules may result in serious bodily injury and/or property damage.

LIFT OPERATING INSTRUCTIONS

OPEN DOOR(S) AND SECURE

TO UNFOLD PLATFORM:

Stand clear and press **UNFOLD** switch until platform stops (reaches floor level).

Note: In event platform does not unfold, press **FOLD** switch to release Lift-Tite™ latches.

TO UNLOAD PASSENGER:

1. Load passenger onto platform and lock wheelchair brakes.
2. Press **DOWN** switch until entire platform reaches ground level and outer barrier unfolds fully.
3. Unlock wheelchair brakes and unload passenger from platform.

TO LOAD PASSENGER:

1. Load passenger onto platform and lock wheelchair brakes.
2. Press **UP** switch to fold outer barrier up and raise platform to floor level.
3. Unlock wheelchair brakes and unload passenger from platform.

TO FOLD PLATFORM:

Press **FOLD** switch until platform stops. Release switch.

CLOSE DOOR(S)

DOT – Public Use Lift

Decals and Antiskid

Decals

32410

LCD Lift Codes

Listed below are codes that the lift controller outputs during lift operation. The codes will be displayed on an LCD screen located on the lift control board inside the pump module.

Non-Flashing Numbers

- 01 - Platform stopped
- 02 - Platform unfolding
- 03 - Platform unfolding paused
- 04 - Platform at floor level
- 05 - Platform beginning to lower
- 06 - Platform lowering (platform cannot be occupied from this point down)
- 07 - Outer barrier moving to horizontal position
- 08 - Platform at ground level
- 09 - Outer barrier moving to vertical position
- 10 - Platform raising
- 11 - Platform raising paused at floor
- 12 - Platform folding (initial pressure)
- 13 - Platform folding (full pressure)
- 14 - Inward tilt (jacking lift rise) or (anti-rattle state)
- 15 - Platform folding stopped
- 16 - Paused fold
- 17 - Platform between ground and 3" above ground
- 18 - Platform above 3"
- 19 - Outer barrier moving to horizontal position
- 20 - The doors are not fully opened (only applicable when door operators are installed)
- 21 - The doors are opening (only applicable when door operators are installed)
- 22 - The doors are closing (only applicable when door operators are installed)
- 28 - Illegal function/roll defined
- 29 - Invalk lock not recognized (or has been cleared but a motion button is still pressed)
- 30 - Platform location unknown
- 31 - Platform location transition state; attempting to locate position
- 35 - Two or more motion buttons are being pressed
- 36 - The extension belt cannot be buckled while trying to hold or unfold
- 37 - Motion button being pressed is not a valid motion
- 50 - Outer barrier is not up above inward barrier locked position
- 51 - Thevalk is occupied when platform is 1" or more below floor level
- 52 - Inner rolstop is not up and locked below inner rolstop locked position
- 53 - Inner rolstop occupied sensor is not activated between floor and inner rolstop up position
- 54 - Outer barrier is occupied before it is up
- 55 - Outer barrier is not latched when above the inner rolstop locked position (Millennium only)
- 56 - Outer barrier is not up and latched and bridge switch did not deactuate

32410

25580

BRAUN MILLENNIUM SERIES

31132



32201

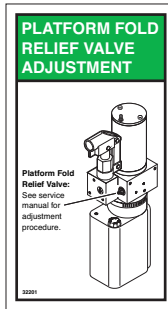

32201

32845



30787



30787

27154

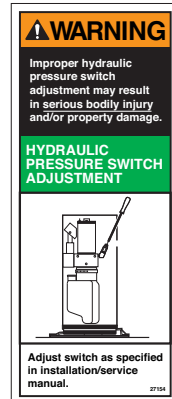

27154

Decals and Antiskid

Decals

22249

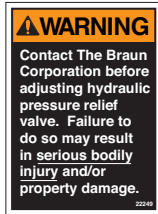

25652



29051

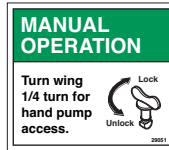

1" Wide Yellow Boundary Tape
 30236R
 (order by the inch as needed)



18229



| Available Antiskid | | |
|--------------------|--------|-----------|
| Size | Color | Part No. |
| 2" x 12" | Black | #24172-BK |
| 2" x 12" | Yellow | #24172-YL |
| 3" x 8" | Black | #31188-BK |
| 3" x 12" | Black | #24173-BK |
| 3" x 12" | Yellow | #24173-YL |
| 6" x 12" | Black | #24174-BK |
| 6" x 12" | Yellow | #24174-YL |

Inspect your lift for any missing or worn antiskid. Order as needed. **Note:** Clean surfaces with isopropyl alcohol before decal or antiskid application. Use a clean cloth or paper towels. **Do not** use oily shop rags. Wipe surface free of residue with dry portion of cleaning cloth.

Maintenance and Lubrication

Proper maintenance is necessary to ensure safe, troublefree operation. Inspecting the lift for any wear, damage or other abnormal conditions should be a part of all transit agencies's daily service program. Simple inspections can detect potential problems.

The maintenance and lubrication procedures specified in the following schedule **must** be performed by a Braun authorized service representative at the scheduled intervals according to the number of cycles.

NL Series lifts are equipped with hardened pins and self-lubricating bushings to decrease wear, provide smooth operation and extend the service life of the lift.

When servicing the lift at the recommended intervals, inspection and lubrication procedures specified in the previous sections should be repeated. **Clean** the components and the surrounding area **before applying lubricants**.

LPS2 General Purpose Penetrating Oil is recommended where Light Oil is called out. Use of improper lubricants can attract dirt or other contaminants which could result in wear or damage to the components. Platform components exposed to contaminants when lowered to the ground may require extra attention.

Lift components requiring grease are lubricated during assembly procedures. When these components are replaced, grease must be applied during installation procedures. Specified lubricants are available from The Braun Corporation (part numbers provided on page 42).

WARNING

Maintenance and lubrication procedures must be performed as specified by an authorized service technician. Failure to do so may result in serious bodily injury and/or property damage.

Maintenance and Lubrication

All listed inspection, lubrication and maintenance procedures should be repeated at “750 cycle” intervals following the scheduled “4500 Cycles” maintenance. These intervals are a general guideline for scheduling maintenance procedures and will vary according to lift use and conditions. Lifts exposed to severe conditions (weather, environment, contamination, heavy usage, etc.) may require inspection and maintenance procedures to be performed more often than specified.

Maintenance Indicator: The Lift Ready green LED mounted on top of the pump cover will begin to blink after every 750 cycles. The blinking LED will not affect the functions of the lift, but is a

reminder to complete necessary maintenance and lubrication. Once the lift has been serviced, fully stow the lift. Once stowed, press the UP button on the hand pendant and the Floor Level Set button on the back side of the pump cover until the Lift Ready green LED stops blinking.

Discontinue lift use immediately if maintenance and lubrication procedures are not properly performed, or if there is any sign of wear, damage or improper operation. Contact your sales representative or call The Braun Corporation at 1-800-THE LIFT®. One of our national Product Support representatives will direct you to an authorized service technician who will inspect your lift.

See the Maintenance/Lubrication Schedule for recommended applications per number of cycles.

| Lubricant | Type | Specified (recommended) Lubricant | Available Amount | Braun Part No. |
|--------------------------|---|---------------------------------------|--------------------|----------------|
| LO - Light Oil | Light Penetrating Oil (30 weight or equivalent) | LPS2, General Purpose Penetrating Oil | 11 oz. Aerosol Can | 15807 |
| DE - Door-Ease | Stainless Stick Style (tube) | Door-Ease Stick (tube) | 1.68 oz. | 15806 |
| LG - Light Grease | Light Grease (Multipurpose) | Lubriplate | 14 oz. Can | 15805 |

Lubrication Diagram

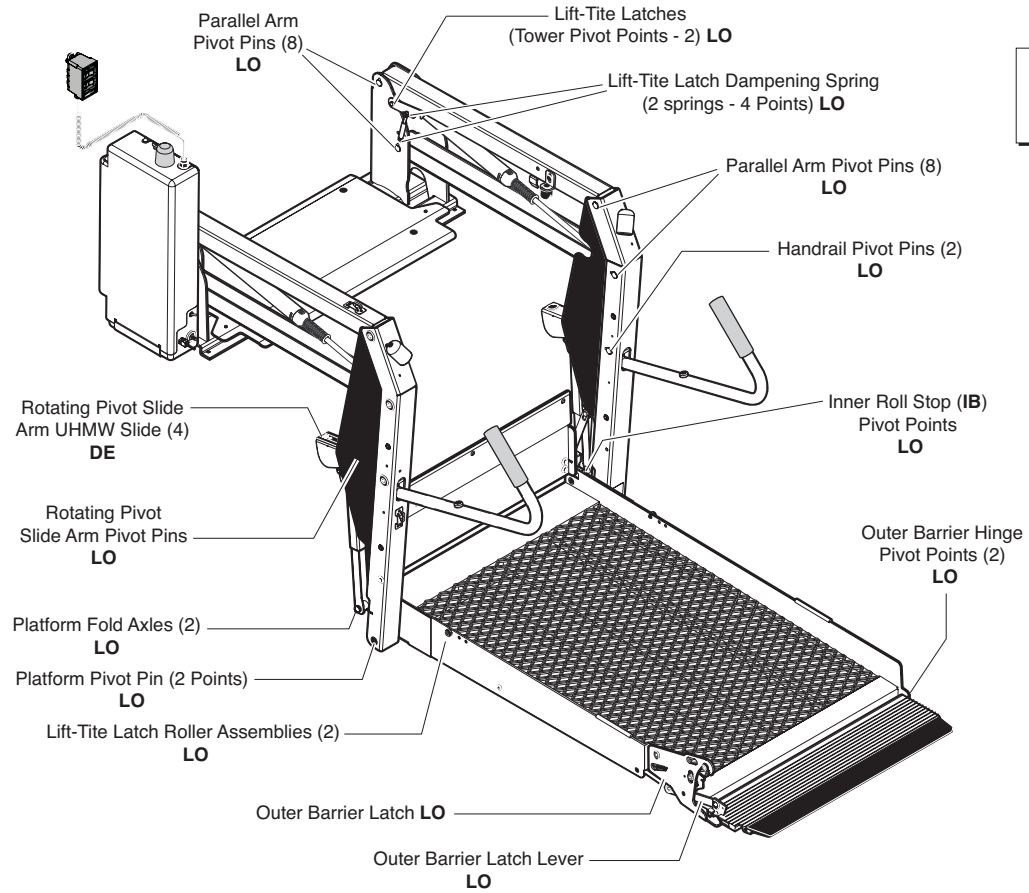

Maintenance and Lubrication Schedule

| | | |
|---|--|---|
| 750 Cycles | Outer barrier hinge pivot points (2) | Apply Light Oil - See Lubrication Diagram |
| | Outer barrier latch (pivot/slide points) | Apply Light Oil - See Lubrication Diagram |
| | Outer barrier latch lever pivot points | Apply Light Oil - See Lubrication Diagram |
| | Lift-Tite™ latches (tower pivot points - 2) | Apply Light Oil - See Lubrication Diagram |
| | Lift-Tite™ latch gas (dampening) spring pivot points (2 springs - 4 points) | Apply Light Oil - See Lubrication Diagram |
| | Inspect Lift-Tite™ latches and gas springs for wear or damage (bent, deformed or misaligned), positive securement (external snap rings) and proper operation | Resecure, replace defective parts or otherwise correct as needed. Note: Apply Light Grease to Lift-Tite™ latch tower pivot point if replacing latch. |
| | Inspect outer barrier for proper operation | Correct or replace defective parts. |
| | Inspect outer barrier latch for proper operation, positive securement, and detached or missing spring | Correct or replace defective parts and/or relubricate. See Lubrication Diagram |
| Inspect lift for wear, damage or any abnormal condition | Correct as needed. | |
| Inspect lift for rattles | Correct as needed. | |

Maintenance and Lubrication Schedule

| | | |
|------------------------------|---|--|
| 1500 Cycles | Perform all procedures listed in previous section also | |
| | Platform pivot pin bearings (2) | Apply Light Oil - See Lubrication Diagram |
| | Platform fold axles (2) | Apply Light Oil - See Lubrication Diagram |
| | Inner roll stop lever bearings (2) | Apply Light Oil - See Lubrication Diagram |
| | Inner roll stop lever slot (2) | Apply Light Oil - See Lubrication Diagram |
| | Rotating pivot slide arm pivot pins (2) | Apply Light Oil - See Lubrication Diagram |
| | Parallel arm pivot bearings (16) | Apply Light Oil - See Lubrication Diagram |
| | Handrail pivot pin bearings (4) | Apply Light Oil - See Lubrication Diagram |
| | Hydraulic cylinder bushings (8) | Apply Light Oil - See Lubrication Diagram |
| | Inspect Lift-Tite™ latch rollers for wear or damage, positive securement and proper operation (2) | Correct, replace defective parts and/or relubricate. |
| Inspect inner roll stop for: | Resecure, replace or correct as needed. See Platform Angle Instructions and Microswitch Adjustment Instructions. | |
| | <ul style="list-style-type: none"> • Wear or damage • Proper operation. Roll stop should just rest on top surface of the base plate. • Positive securement (both ends) | |
| continued | | |

Maintenance and Lubrication Schedule

| | | |
|------------------------|--|---|
| continued | Perform all procedures listed in previous section also | |
| 1500 Cycles | Inspect handrail components for wear or damage, and for proper operation | Replace defective parts. |
| | Inspect microswitches for securement and proper adjustment. | Resecure, replace or adjust as needed. See Microswitch Adjustment Instructions. |
| | Make sure lift operates smoothly | Realign towers and vertical arms. Lubricate or correct as needed. |
| | Inspect external snap rings: <ul style="list-style-type: none"> • Handrail pivot pins (2 per pin) • Platform slide/rotate pivot pins (2 per pin) • Platform fold axles (1 per axle) • Inner roll stop lever bracket pins (1 per pin) • Lift-Tite™ latch gas (dampening) spring (2 per spring) | Resecure or replace if needed. |
| | Inspect platform fold axles and bearings for wear or damage and positive securement | Replace defective parts and resecure as needed. Apply Light Oil. |

Maintenance and Lubrication Schedule

| | | |
|------------------------|--|--|
| 1500 Cycles | <p>Remove pump module cover and inspect:</p> <ul style="list-style-type: none"> • Hydraulic hoses, fittings and connections for wear or leaks • Harness cables, wires, terminals and connections for securement or damage • Control board, circuit breaker, power switch and lights for securement or damage | <p>Resecure, replace or correct as needed.</p> |
| 4500 Cycles | <p style="text-align: center;">Perform all procedures listed in previous sections also</p> <p>Inspect cotter pins on platform pivot pin (2)</p> <p>Hydraulic Fluid (Pump) - Check level. Note: Fluid should be changed if there is visible contamination. Inspect the hydraulic system (cylinder, hoses, fittings, seals, etc.) for leaks if fluid level is low.</p> <p>Inspect cylinders, fittings and hydraulic connections for wear, damage or leaks</p> <p>Inspect outer barrier cylinder hose assembly (hose, fasteners, connections, etc.) for wear, damage or leakage (if equipped)</p> | <p>Resecure, replace or correct as needed</p> <p>Use Braun 32840-QT (Exxon® Univis HVI 26) hydraulic fluid (do not mix with Dextron III or other hydraulic fluids). Check fluid level with platform lowered fully and roll stop unfolded fully. Fill to within 1/2" of the bottom of the 1-1/2" fill tube (neck).</p> <p>Tighten, repair or replace if needed.</p> <p>Tighten, repair or replace if needed.</p> |

continued

Maintenance and Lubrication Schedule

| | | |
|------------------------|---|--|
| continued | Perform all procedures listed in previous section also | |
| 4500 Cycles | Inspect parallel arms, bushings and pivot pins for visible wear or damage | Replace if needed. |
| | Inspect parallel arm pivot pin mounting bolts (8) | Tighten or replace if needed. |
| | Inspect platform pivot pin, bushings and vertical arms for wear, damage and positive securement | Replace defective parts and resecure as needed. Apply Light Grease during reassembly procedures. |
| | Inspect upper/lower fold arms, rotating pivot slide arms, slide support arms and associated pivot pins, bushings, and bearings for visible wear or damage | Replace if needed. |
| | Inspect gas springs (cylinders) for wear or damage, proper operation and positive securement | Tighten, replace or correct as needed |
| | Inspect rotating pivot slide arm UHMW slide bearings (buttons) | Apply Door-Ease or replace if needed. See Lubrication Diagram. |
| | Inspect vertical arm plastic covers | Resecure or replace if needed. |
| | Inspect power cable | Resecure, repair or replace if needed. |

Maintenance and Lubrication Schedule

| | | |
|--|--|---|
| 4500 Cycles | Mounting Decals and Antiskid | Check to see that the lift is securely anchored to the vehicle and there are no loose bolts, broken welds, or stress fractures. Replace decals if worn, missing or illegible. Replace antiskid if worn or missing. See Decals and Antiskid section on pages 38-40. |
| Consecutive 750 Cycle Intervals | Repeat all previously listed inspection, lubrication and maintenance procedures at 750 cycle intervals. | |

"Providing Access to the World"®



Millennium Series Lift Braun "Worry-Free" Five-Year Limited Warranty

The Braun Corporation of Winamac, Indiana, warrants its wheelchair lift against defects in material and workmanship for up to five years*, providing the lift is installed, operated and maintained properly and in conformity with this manual. This warranty is limited to the original purchaser and does not cover defects in the motor vehicle on which it is installed, or defects in the lift caused by a defect in any part of the motor vehicle.

This warranty commences on the date the lift is put into service, providing the warranty registration card is completed and received by The Braun Corporation within twenty days of purchase. If no warranty card is received, the warranty will expire three years from the date of manufacture as identified on the lift serial number tag.

This warranty also covers the cost of labor for the repair or replacement of parts for three years when performed by an approved Braun Dealer. (A labor schedule determines cost allowance for repairs, which can be provided upon request by an approved Braun Dealer).

This warranty does not cover normal maintenance, service, or periodic adjustments necessitated by use or wear. The Braun Corporation will not, under any circumstances, pay for loss of use, incidental or consequential damages related to the lift, or vehicle in which it is installed.

This warranty will become null and void if the lift has been damaged through accident, misuse, or neglect, or if the lift has been altered in any respect.

* The five-year portion of this warranty covers the following lift's power train parts:

- Chain
- Cylinder
- Flow Control
- Gear Box
- Motor
- Pump
- Hydraulic Hose & Fittings
- Solid State Controller

All remaining lift components are covered by a three-year warranty.

All illustrations, descriptions and specifications in this manual are based on the latest product information available at the time of publication. The Braun Corporation reserves the right to make changes at any time without notice.

Free Manuals Download Website

<http://myh66.com>

<http://usermanuals.us>

<http://www.somanuals.com>

<http://www.4manuals.cc>

<http://www.manual-lib.com>

<http://www.404manual.com>

<http://www.luxmanual.com>

<http://aubethermostatmanual.com>

Golf course search by state

<http://golfingnear.com>

Email search by domain

<http://emailbydomain.com>

Auto manuals search

<http://auto.somanuals.com>

TV manuals search

<http://tv.somanuals.com>