

# **INSTALLATION INSTRUCTIONS**

## **FOR B409 DOUBLEWALL TANK SUMP**

### **WITH REINFORCED BOTTOM**



S. Bravo Systems, Inc.  
2929 Vail Ave. - Commerce, CA 90040  
(323) 888-4133 - FAX: (323) 888-4123  
[www.SBravo.com](http://www.SBravo.com)

Written by: Jonathan Smith



ii-B409-DW-10A

# MANDATORY

The B-409 Doublewall Sump w/Bottom from S. Bravo Systems, Inc. **MUST** be installed by **Bravo Certified Contractors**. Details can be found at [www.sbravo.com/cert](http://www.sbravo.com/cert)

<b>READ THESE INSTRUCTIONS - KEEP FOR FUTURE REFERENCE</b>	
<b>TABLE OF CONTENTS</b>	
DRY FITTING SUMP & EQUIPMENT.....	p. 4
A) Installing & Securing.....	p. 5
Install & Test Penetration Fittings.....	p. 5 (A.4)
B) Mandatory Air Integrity Test.....	p. 6
C) Vacuum / Hydrostatic Filling.....	p. 7-8
D) Advanced Leak Detection Procedure.....	p. 9-10
E) Connecting to Manometer.....	p. 11
F) Concrete & Backfill Guidelines.....	p. 12



**Filling Bravo Systems Double Wall Products with Brine (saline) solution will void the product warranty. You must use only Bravo-Supplied Interstitial Fluid.**

***- Closely adhere to all directions and warnings indicated on the product or contained in these instructions. This includes following the OTHER manufacturers recommendations and Installation guidelines including -but not limited to- equipment associated or in contact with, Bravo Systems Products.***

***- Warranty is void if there is any evidence of modification, abuse, negligence or improper installation.***

***SAFETY FIRST! S. Bravo Systems, Inc. urges you to carefully adhere to the normal safety procedures and precautions followed by your company. Please follow the mandates and compliances decreed by OSHA, local, State and federal regulations regarding the use of this product.***

<p style="text-align: center;"><b>WARRANTY</b></p> <p>All containment systems sold by S. Bravo Systems, Inc. are warranted to be free from defects in material and workmanship for a period of one year from date of purchase. This warranty will be limited to the repair and replacement of Bravo parts only and will exclude all claims for labor or consequential damage. No other express warranties given and no affirmation of S. Bravo Systems, Inc., or its agents and/or representatives, by words or action, will constitute a warranty. IT IS EXPRESSLY AGREED THAT THIS WARRANTY WILL BE IN LIEU OF ALL WARRANTIES OF FITNESS AND IN LIEU OF THE WARRANTY OF MERCHANTABILITY.</p> <p>This warranty is void if there is any evidence of modification, abuse, negligence, or improper installation. If any fittings or components, other than S. Bravo Systems approved fittings or components, are used in conjunction with any S. Bravo Systems product, the warranty pertaining to these products is immediately void.</p>
--

## WARNING

### BEFORE PENETRATING FIBERGLASS WALLS ENSURE THAT EACH DOUBLE WALL FIBERGLASS SUMP IS HOLDING VACUUM



It is **REQUIRED** to visually check the Vacuum gauge on each and every Bravo Systems Double Wall product and write on its FAX report **Vacuum level**, **name of observer**, and **date** for every DoubleWall Sump.

## WARRANTY IS VOID: IF ANY OF THE FOLLOWING OCCUR

- A)** There is a failure to comply with the Required written report guidelines as stated above.
- B)** Double Wall Products are DOUBLE-STACKED, stored or shipped in a negligent way.
- C)** Any packaging or wrapping materials are removed before the item reaches It's destination.
- D)** Double Wall Sump Products, Failure to call Bravo Systems If Vacuum level on product is less than 12" HG (Vacuum) (323) 888-4133, refer to sump for further details.
- E)** Double Wall Sump Products are tested per the SB989 Testing procedures. The interior of these sumps must **NOT** be filled with liquid to any level.
- F)** Double Wall Sumps are filled with an unapproved interstitial fluid, or if adhesives or sealants are used that are not Bravo-approved.

If there is any indication or suspect damage, you must mark the freight paperwork ***"Suspect Freight Damage" as directed by your Contractor Warranty sheet.***

# EQUIPMENT DRY-FIT

- BEFORE INSTALLING PENETRATION FITTINGS
- BEFORE CUTTING OPEN SUMP INTERSTICE

**DRY-FIT YOUR SUMP PIECES AND  
INTERNAL EQUIPMENT.**

**PLAN YOUR INSTALLATION AND MAKE  
SURE EVERYTHING FITS, AND WILL FIT  
LATER DURING INSTALLATION.**



## Recommended Tools

(NOT PROVIDED)

Power/air Sanders. Acetone to clean up tools/applicators. Power Cutting Tools.

### T-F-33-SAND-KIT

5/8" sanding disc backs and centralizers for all Bravo Systems Fittings



**SVA-BARB** per sump

**VAC-KIT-D-AB** per site

## HYDROSTATIC ONLY!!

### MANOMETER KIT (PER SUMP)

- Interstitial fluid	<b>TOTAL HEIGHT</b>
- Standard Manometer	4' = 5 gal
- Manometer Bracket	5' = 6 gal
- Factory-Installed	6' = 7 gal
Nylon tubing	7' = 8 gal
w/20" Hg Vacuum on interstice	
w/Combination Pressure/Vacuum Gauge	

# A - INSTALLING AND SECURING YOUR B409

## BEFORE INSTALLING PENETRATION FITTINGS ENSURE THAT THE SUMP BODY IS HOLDING VACUUM.

If the gauge is Below 12 inches of mercury (Hg/Vacuum), then pressurize the sump interstice to 4 PSI and submerge the gauge and tubing assemblies. Soap test the test tubing fittings on the walls. If an air leak is found, contact the factory. If no leak at the tubing is found, soap test the rest of the sump surface starting with the exterior. Visually inspect for damage. If the leak is found, patch per repair directions in this manual.

If the gauge is **AT OR ABOVE 12 INCHES OF MERCURY**, proceed to **Step A.1**

**A.1** - Visually inspect the parts provided by Bravo Systems for In-transit damage and/or missing parts. Continue to keep the Sump clean of debris throughout your installation process.

**A.2** - Set your B409 Piping Sump where it must be per site plans. Secure the Sump to avoid movement while penetrating.

**A.3** - Mark where you will penetrate the Base/Tank Collar wall.

**A.4** - Install Penetration Fittings per their respective Installation Instructions. You must NOT disturb the penetration fittings while the sealant/adhesive is drying. Allow for the maximum cure time as recommended by the manufacturer of the fittings before pressurizing & soaping to test for leaks.

**IMPORTANT** DO NOT FILL DOUBLE WALL PENETRATION FITTINGS WITH FOREIGN MATERIALS, SEALANTS or ADHESIVES.

**IMPORTANT** While Fiberglassing, curing, or sitting overnight, keep the SVA-BARB in place. This will relieve pressure on the Interstice while the sumps are heating up or cooling off.

**SAVE THESE PIECES, DO NOT LOSE THEM!** Remove the SVA-BARB when ready to test.

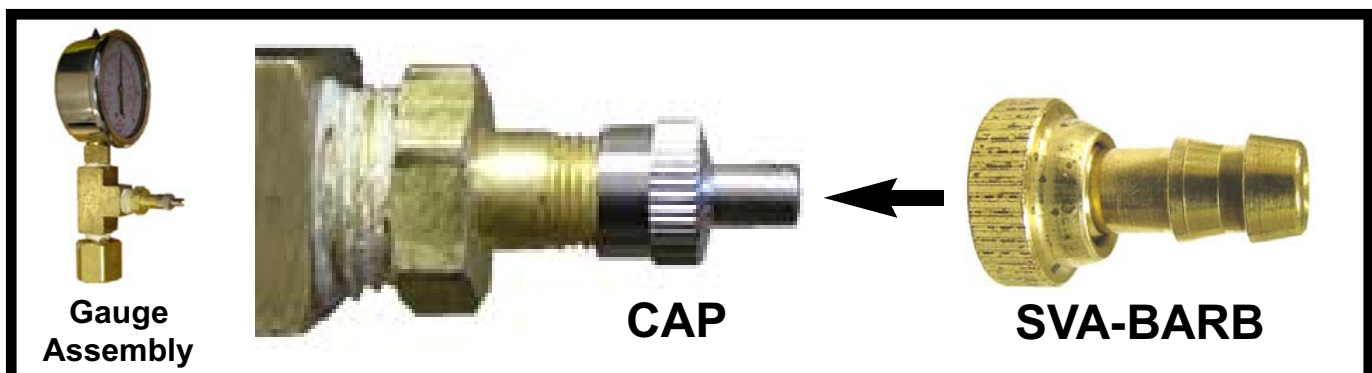

# B - MANDATORY AIR INTEGRITY TEST

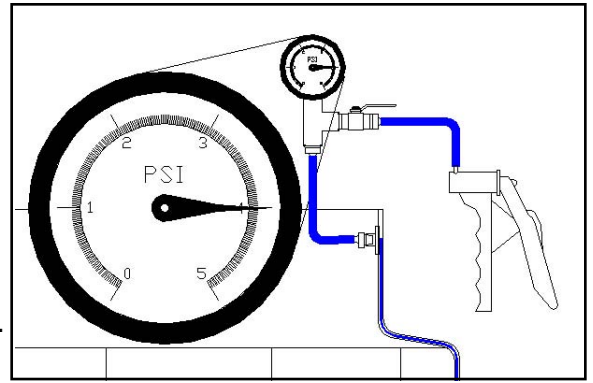

**B.1** - Use test assembly and pressure sump to no more than **4 PSI**. Close off with ball valve and resume other work. Allow **1 Hour** before recording pressure.

**NOTICE**  
**BRAVO**  
QUALITY  
STANDARD

**FIELD AIR INTEGRITY INSPECTION TEST** : Hold pressure for a minimum of 1 hour for a Field Integrity Inspection Test. The Tank Sump **PASSES** the integrity test if the Sump shows **NO** signs of continuous pressure decay.

**IF TEST PASSES - CONTINUE ON TO THE HYDROSTATIC FILL & INTEGRITY TEST.**

## B.2 - IF ANY LEAKS ARE FOUND!!

Look at edges and corners for pinhole leaks. **For large leaks, consult factory.**

- A:** Locate leak point(s) and mark with marker so you can locate it / monitor it.
- B:** Repair or reinstall doublewall penetration fittings according to your doublewall penetration fitting manufacturers' Installation / Maintenance Instructions.
- C:** Abrade a 2" diameter area centered on the leak point until natural resin/fiberglass material can be seen. Dust with shop brush or compressed air and do not use shop towels or acetone on the abraded area(s). Then apply a 3-layer strip of 2" x 2" resin-saturated fiberglass mat squarely on the abraded area.
- D:** Roll out any air bubbles with chamfer roller. Let cure.
- E:** After cure, knock down fiberglass hairs, and apply another flow coat of resin only. Apply any extra resin to repaired leak point(s) while still wet. Let cure for a minimum of 4 hours @ or above 75° F.

**FOR HYDROSTATIC MONITORING - PROCEED TO SECTION C.**

**FOR CONTINUOUS VACUUM MONITORING - The B409 DoubleWall Solid Sump w/Bottom cannot exceed 16" of Mercury. (Vacuum) Follow your vacuum system manufacturer's installation instructions to install, seal, and monitor the doublewall system with vacuum.**



Connect the SVA-BARB to your factory-installed gauge for vacuum monitoring

Continue to Section F.

**WARNING**

**Ensure that the fittings that are being used with the Vacuum Monitored System can withstand the amount of Vacuum your Monitoring System will generate.**

# C - VACUUM / HYDROSTATIC FILLING

## IMPORTANT

FIELD AIR INTEGRITY INSPECTION TEST :

**YOUR PRODUCT WARRANTY WILL BE VOID IF YOU DO NOT** Hold pressure for a minimum of 1 hour for a Field Integrity Inspection Test. *After passing the pressure test, it is HIGHLY RECOMMENDED that the 4 PSI is maintained for as long as possible, up until the time of backfill.*

**WARNING** YOUR PRODUCT WARRANTY WILL BE REVOKED IF YOU CHOOSE TO SKIP THE AIR INTEGRITY TEST OUTLINED IN YOUR COPY OF YOUR PRODUCT INSTALLATION INSTRUCTIONS. YOU **MUST** COMPLETE THE PRESSURE TEST PRIOR TO HYDROSTATIC FILLING OF THE SUMPS.

The Bravo Double Wall product's ship from the factory with a combination gauge factory- installed and held under 20" of mercury / vacuum.

**C.1** - After passing the Field Air Integrity Test per the Installation Instructions and there are no signs of leaks, you must cut the permanently affixed pipe plug from the tubing connected to the side wall. This is NOT the tubing with the gauge connected to it.

**C.2** - Connect (newly cut) open end of tubing to barb-and-ball-valve assembly. (sold seperately)  
A 36" length of clear tubing is factory installed to the barb-and-ball-valve assembly.

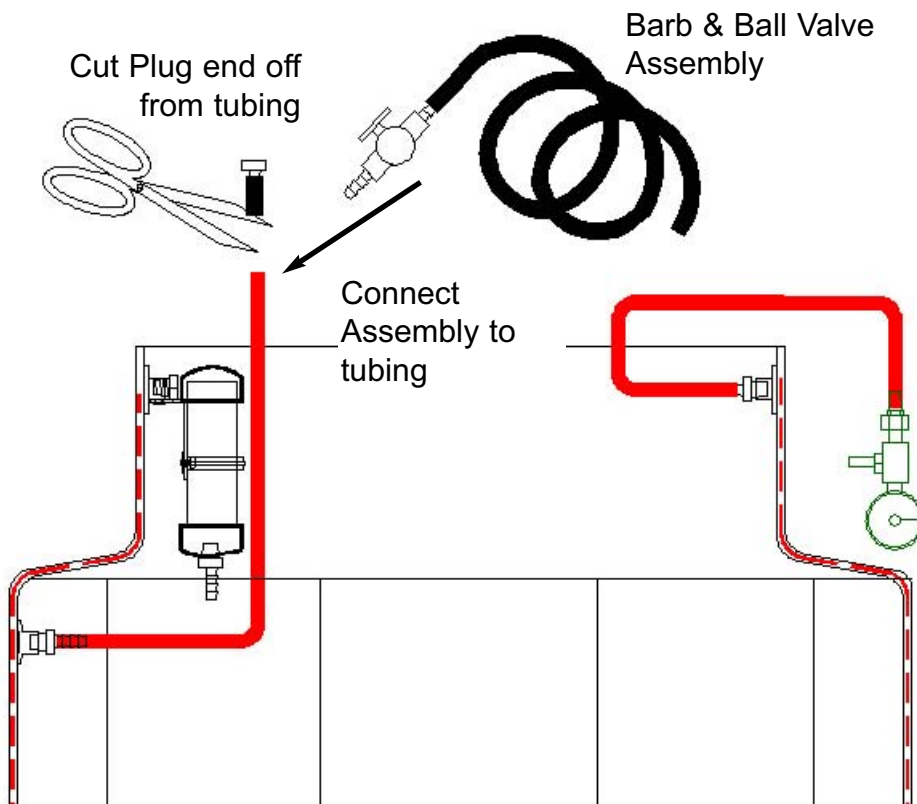

After the penetration fittings have been installed, the vacuum has been lost. Pressure/soap tests should have been conducted prior to filling the sumps with liquid.

You must cut off the barbed plug and connect the provided Barb & Ball Valve Assembly. Close off the ball valve and prepare the Venturi Vacuum Generator and air supply to be used to fill Sump with liquid.

**C.3** - Close off ball valve completely and prime the open ended 36" length of clear tubing with provided Interstitial Fluid. Use a liquid funnel.



## **WARNING**

**Filling Bravo Systems Double Wall Products with Brine (saline) solution will void the product warranty. You must use only Bravo-Supplied Interstitial Fluid, part # IMF-1GAL**

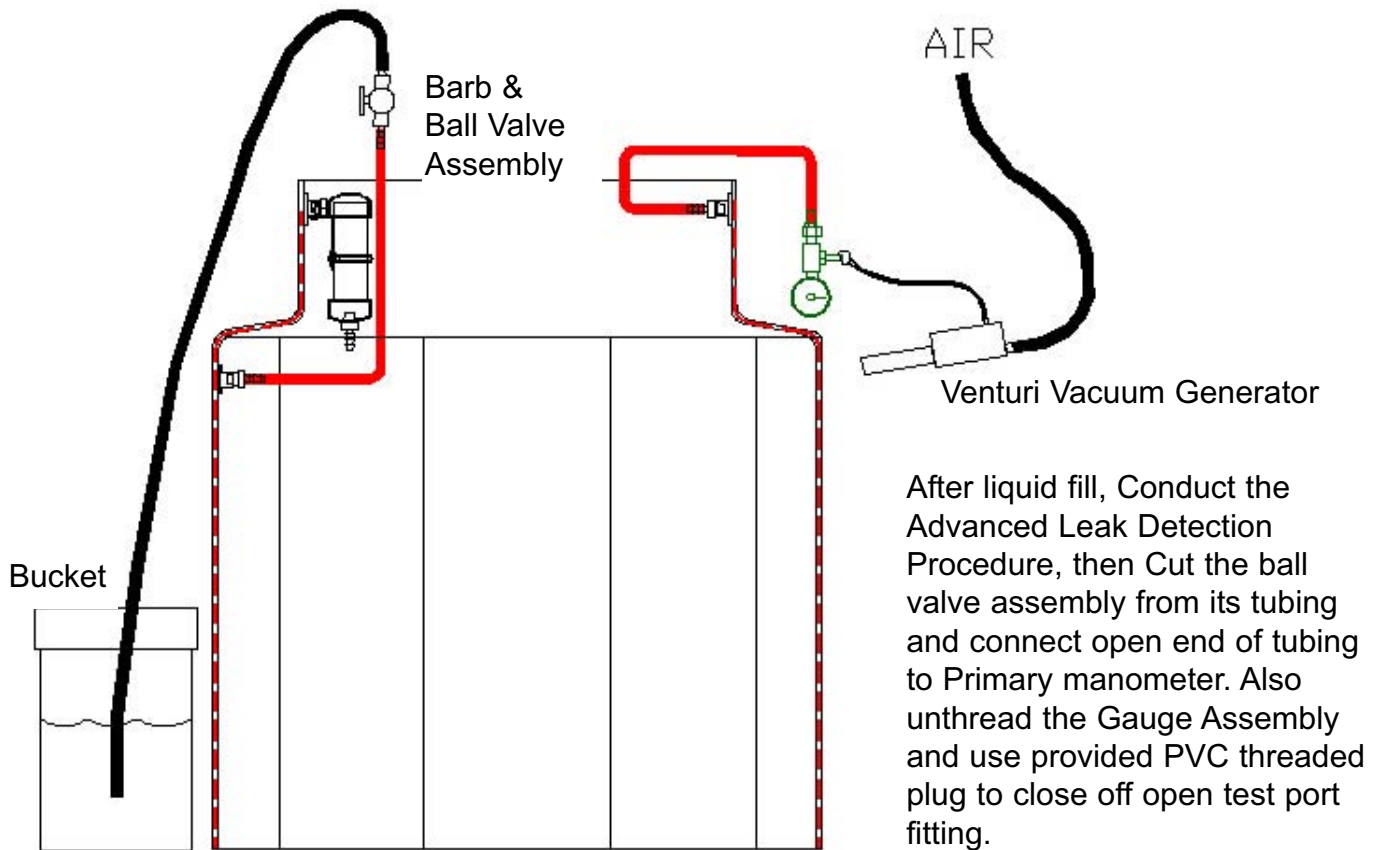

**C.4** - After filling the tubing all the way to the ball valve, **insert open end into your liquid source.** (5 gallon bucket filled with fluid is recommended.)

**C.5** - When ready, pull vacuum using the Venturi Vacuum Assembly (sold separately) to 20 Inches of mercury. Then **SLOWLY** open ball valve and allow Interstitial fluid to flow freely into the system at a rate of about 2 gallons a minute.

## **CRITICAL** ...**SLOWLY** open ball valve...

**C.6** - **STOP PULLING VACUUM WHEN THE LIQUID IS 2-3 INCHES FROM THE VERY TOP OF THE INTERSTITIAL SPACE / TEST PORT.** This is easily visible while filling the DoubleWall Product.



# D) ADVANCED LEAK DETECTION PROCEDURE

## A Bravo Systems Exclusive detection method

**D.1** - Clear debris from the top open area of the DoubleWall Product and ensure that the interior walls are clean of debris and visible.

**D.2** - Apply Vacuum to the sealed interstitial space with the Venturi Vacuum Assembly, and generate 20"-30" of vacuum for a *MINIMUM* of Five [ 5 ] Minutes.

### **WARNING**

**CHECK WITH YOUR EQUIPMENT MANUFACTURERS  
INSTALLATION MANUALS FOR INSTALLATION  
GUIDELINES AND/OR EQUIPMENT LIMITS REGARDING  
VACUUM AND PRESSURE LEVELS.**

**D.3** - As stated in your Instructions, the liquid level is deliberately not filled to the very top of the interstitial space. This pocket of air is necessary to visually check the topmost level of liquid all the way around the Sump for indication of a leak.

**D.4** - Visually inspect the interior walls for signs of trailing (very small) bubbles floating to the top of the liquid level within the interstitial space.

### **NOTICE**

**These air bubbles are visible within the vertical and horizontal channels of the walls. For Tank Sumps look below the reducer.**

### **NOTICE**

**On the top hat reducer of a Tank Sump, any bubbles will burp consistently.**

### **CRITICAL**

**PAY CLOSE AND SPECIAL ATTENTION TO FIELD-INSTALLED  
PENETRATION FITTINGS and FRP JOINTS ON TANK SUMPS.  
THESE ARE COMMON LEAK POINTS.**

### **CAUTION**

Even though Bravo DoubleWall product corners and edges are thicker than the rest of the Containment sump, These areas receive the most susceptible to physical damage by Installing Contractors. You would do well to be extremely careful with these DoubleWall products while storing, moving, transporting and Installing these critical environmental components.

# ALDP IN ACTION DIAGRAM

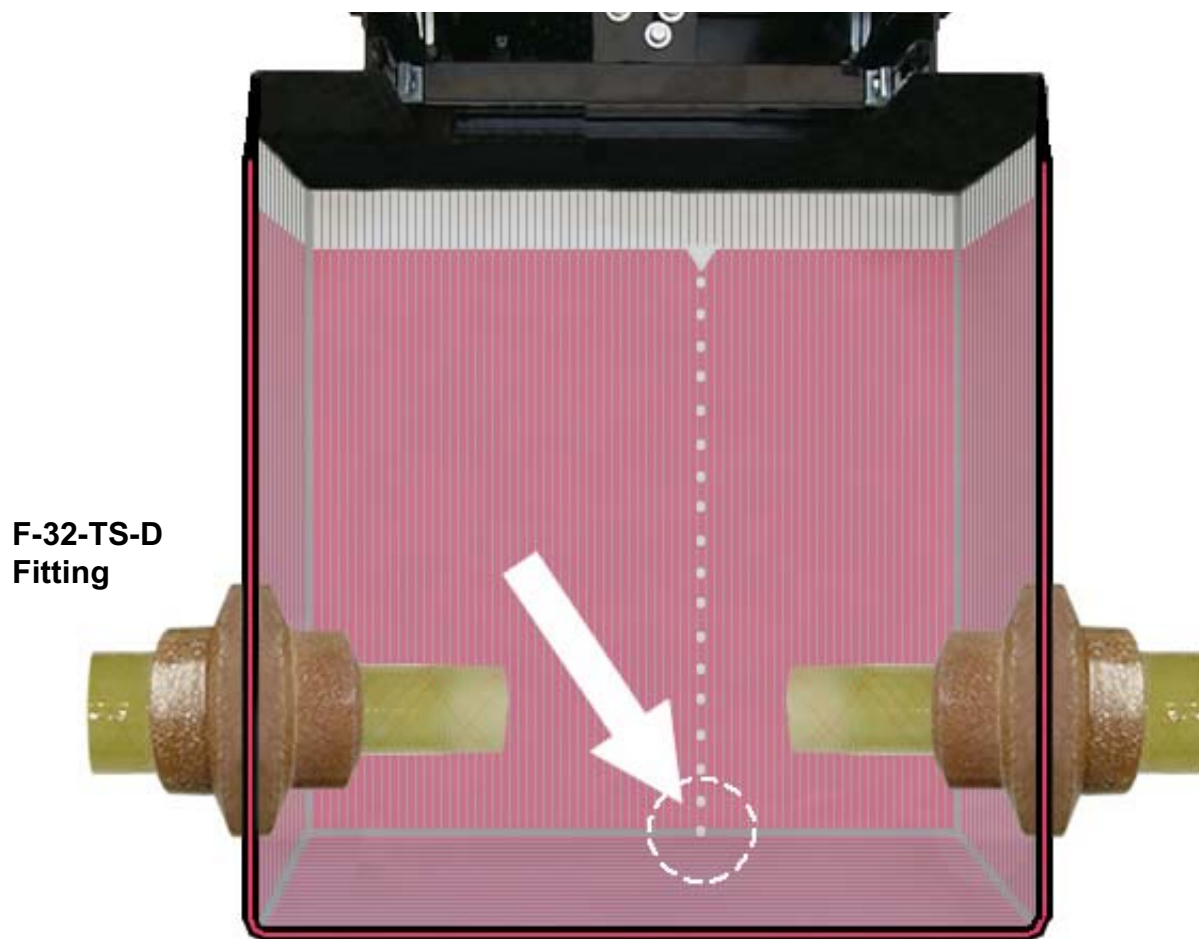

**Here a leak is visible** while a strong vacuum is pulled on the Interstitial space, forcing tiny air bubbles into the interstitial space to travel upwards. These streams of bubbles are easily spotted and can be traced down to its leak point or area.

**▲ CRITICAL**

**PAY CLOSE AND SPECIAL ATTENTION TO FIELD-INSTALLED PENETRATION FITTINGS and FRP JOINTS ON TANK SUMPS. THESE ARE COMMON LEAK POINTS.**

**▲ CAUTION**

Even though Bravo DoubleWall product corners and edges are thicker than the rest of the Containment sump, These areas receive the most susceptible to physical damage by Installing Contractors. You would do well to be extremely careful with these DoubleWall products while storing, moving, transporting and Installing these critical environmental components.

# E - CONNECTING TO MANOMETER

**E.1** - At this point, after the ALDP test, the interstice should still be holding vacuum. Maintain 20" of Vacuum and **slowly** open ball valve to let fluid into the interstice until it exits the venturi assembly. Visually check whether the fluid level reaches the top of the interstitial space.

**E.2** - Cut the barb & ball valve assembly free by cutting the tubing just below it and **connect** open end of tubing to the bottom of the primary Manometer.

**E.3** - **Remove the Barb**, Tubing & Combination gauge assembly from the test port fitting on the side of the sump. **Install a threaded pipe plug** into the open test port fitting and adjust Primary manometer bracket so the manometer is in a position clear of the sump cover.

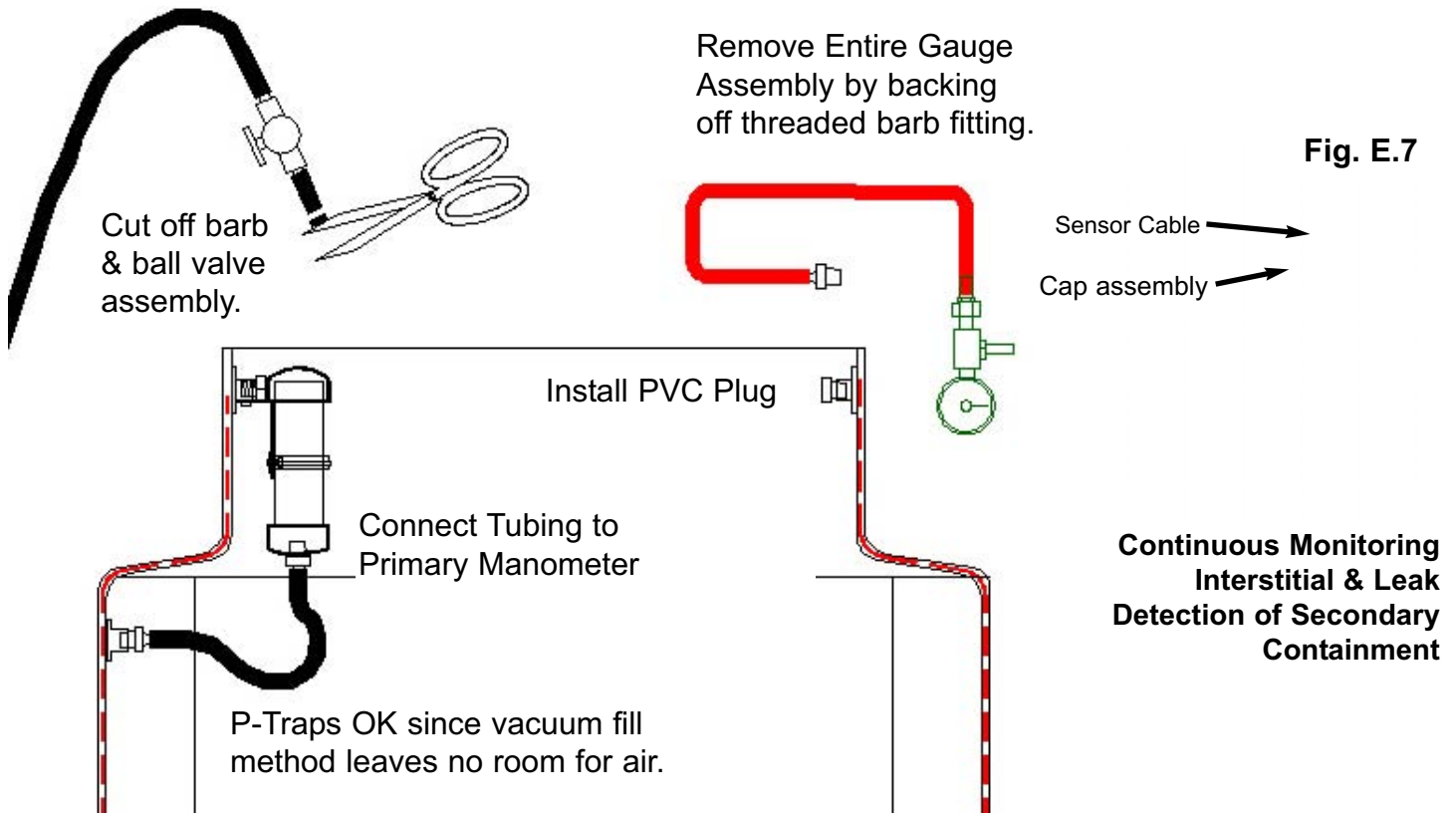

**E.4** - It is not uncommon for some interstitial fluid to be lost while connecting the tubing to the primary manometer. This is ok. Replace lost fluid by topping off manometer with interstitial fluid until the liquid level reaches just 2 inches below the top of manometer.

**E.5 - Hydrostatic Field Integrity Test** - Mark the date and time of test and manometer level. **Allow 1 hour to look for a change in level.** No change in level or visible leaking means box passes test.

**E.6** - If interstitial test fluid changes its level more than 1/4", visually look for any signs of leaking around fittings both interior and exterior to sump. Pay special attention to field installed fittings.

**E.7** - If interstitial monitoring is required, install a California Listed Hydrostatic Sensor (LG-113) using the sensor manufacturer's fitting. Run sensor cable through the cap assembly (**see Fig. E.7**). Level sensor should be set to bottom of manometer. Follow your leak detector manufacturer's installation instructions. Cover the manometer with cap and fasten with wire and lead crimp seal.

# G - Concrete and Backfill Guidelines.

To ensure that no immediate or future damage is done to your Bravo Tank Sump Reducer components, make sure that your manhole skirt **DOES NOT TOUCH OR REST ON THE TANK SUMP SHOULDER**. The Manhole Skirt should be kept at minimum of 4" away from the tank sump shoulder. Follow the manhole manufacturers instructions for installing the manhole. Also follow other details provided by tank and/or engineering firm for tank driveway pad installation.

Backfill your peagravel around the sump maintaining a minimum of 1' foot all the way around (if your site backfill is not entirely peagravel) and 4" minimum distance from the top edge of sump reducer.

When peagravel is in place, use a 3mil or thicker plastic sheet to cover the surface of the peagravel no less than 2 feet away from the sump reducer wall.

Secure this plastic barrier to the **EXTERIOR OF THE MANHOLE SKIRT** using duct tape. This prevents concrete from seeping too far down into the peagravel.

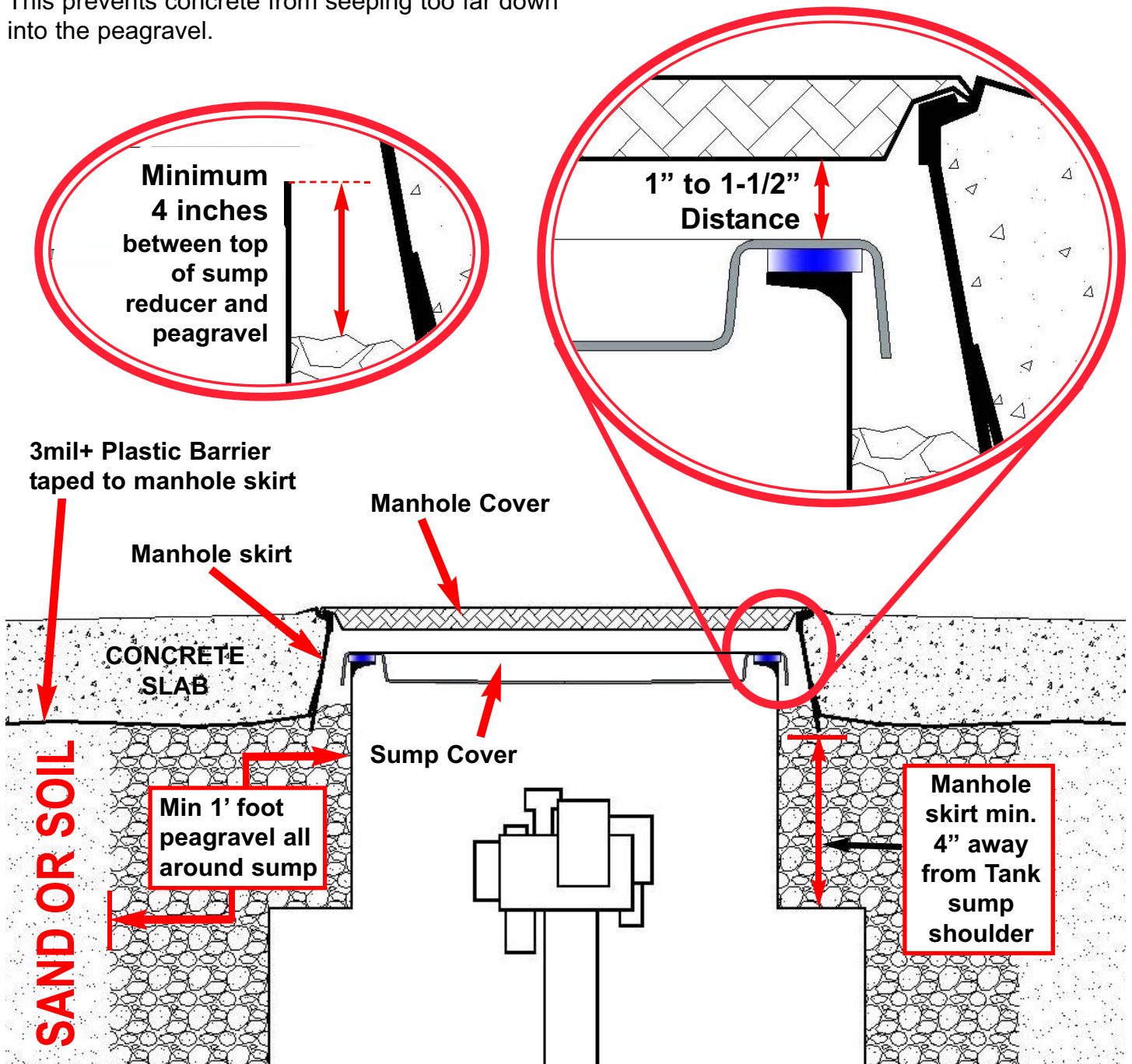

## Free Manuals Download Website

<http://myh66.com>

<http://usermanuals.us>

<http://www.somanuals.com>

<http://www.4manuals.cc>

<http://www.manual-lib.com>

<http://www.404manual.com>

<http://www.luxmanual.com>

<http://aubethermostatmanual.com>

Golf course search by state

<http://golfingnear.com>

Email search by domain

<http://emailbydomain.com>

Auto manuals search

<http://auto.somanuals.com>

TV manuals search

<http://tv.somanuals.com>