

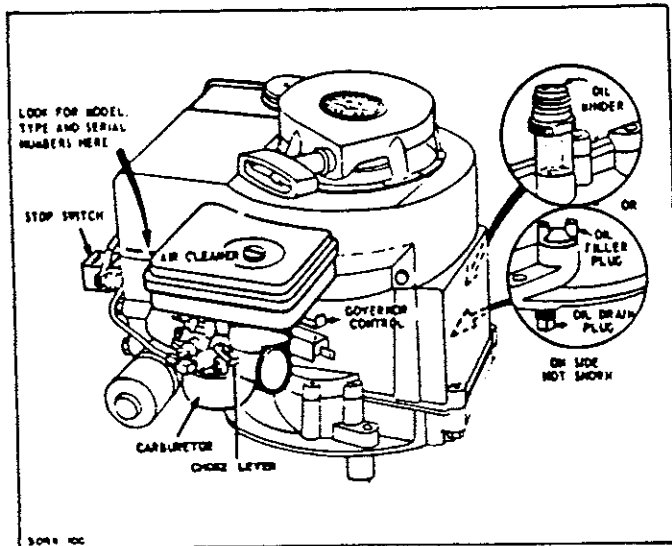

MODEL SERIES
 60700 to 60706
 61700 to 61706
 80700 to 80796
 81700 to 81796

OPERATING AND MAINTENANCE INSTRUCTIONS

IMPORTANT: Do not start this engine before reading Section 2 and Section 11 of this manual. It takes only a few minutes.



CAUTION

1. PROVIDE EFFICIENT VENTILATION. Exhaust gases contain carbon monoxide which is odorless and a deadly poison. Proper care must be taken to provide efficient ventilation.
2. DO NOT FILL GASOLINE TANK WHILE ENGINE IS RUNNING. Avoid spilling gasoline on a hot engine — this may cause an explosion and serious injury.
3. KEEP ENGINE CLEAN. This engine is air-cooled. If cooling system becomes clogged, serious damage may result. Therefore, keep the blower screen, fins on flywheel, cylinder head and block free from grass and dirt.
4. When tipping engine on side for service, spark plug must be in upward position.
5. Be sure nobody is behind you when starting engine with rope starter.
6. ROTARY LAWN MOWERS. Always disconnect spark plug before moving mower blade, cleaning under mower deck or sharpening blade.

SECTION I BEFORE STARTING

FILL SUMP WITH OIL

Remove the oil filler plug or oil minder located on base of engine.

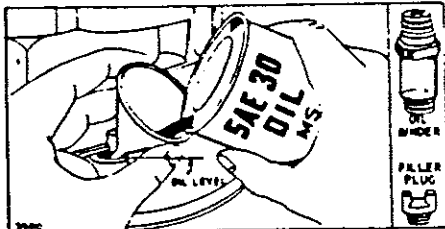

Place the engine level. Fill the oil sump to overflowing. Pour slowly. Capacity 1 1/4 pints. Replace the filler plug or oil minder.

LUBRICATION RECOMMENDATIONS

Any high quality detergent oil bearing the American Petroleum Institute classification "For Service MS" can be used in your Briggs & Stratton engine. Detergent oils keep the engine cleaner and retard the formation of gum and varnish deposits.

Above 32° F. Use SAE-30
 Below 32° F. Use SAE-10W

Nothing should be added to the recommended oils.

OIL-MINDER

Special accessory furnished on some vertical crankshaft engines. This visual gauge permits checking the oil level without removing oil filler plug.

TO OPERATE:

1. Position engine level (Not Running).
2. Press and release bellows several times.

If plastic tube fills with oil it is safe to operate engine. If plastic tube does not fill with oil, engine oil is low. Remove OIL-MINDER and fill crankcase to point of overflowing.

"OIL-FOAM" AIR CLEANER

"Oil-Foam" air cleaners are oiled at the factory and do not require initial service.

*Trademark of Briggs & Stratton Corp

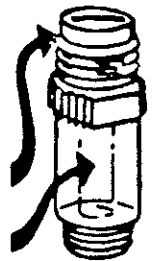

IMPORTANT SAFETY INFORMATION AND INSTRUCTIONS FOR ENGINE SELECTION ENGINE INSTALLATION ENGINE OPERATION

In the USA and Canada, our 24 hour hotline is:
 18002333723
 Briggs & Stratton Corporation
 Milwaukee, Wisconsin 53201
www.briggsandstratton.com

Keep these instructions for future reference.

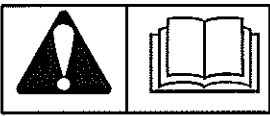



Before installing and operating this engine read and observe all warnings, cautions and instructions on both sides of this sheet, on the engine, and in the operating & maintenance instructions.

NOTE: This sheet of instructions and safety information is not meant to cover all possible conditions and situations that may occur. Read entire Operating & Maintenance Instructions for this engine AND the instructions for the equipment this engine powers. Failure to follow instructions and safety information could result in serious injury or death.

The safety alert symbol () is used to identify safety information about hazards that can result in personal injury.

A signal word (DANGER, WARNING, or CAUTION) is used with the alert symbol to indicate the likelihood and the potential severity of injury. In addition, a hazard symbol may be used to represent the type of hazard.







 **DANGER** indicates a hazard which, if not avoided, will result in death or serious injury.

 **WARNING** indicates a hazard which, if not avoided, could result in death or serious injury.

 **CAUTION** indicates a hazard which, if not avoided, might result in minor or moderate injury.

CAUTION, when used without the alert symbol, indicates a situation that could result in damage to the engine.

HAZARD SYMBOLS AND MEANINGS

 Fire	 Explosion	 Moving Parts
 Toxic Fumes	 Hot Surface	 Shock
 Kickback		

(OVER)

FORM MS-6445-01/03

ENGINE SELECTION



 WARNING

Failure to select the correct engine could result in fire or explosion.



- Some engines are unique and designed for specific applications or types of equipment. If this engine will be used to build new equipment, contact Briggs & Stratton to ensure that the engine is appropriate for the intended use.
Note: For all Go-karts use only a model 136200 series engine, which offers improved safety and performance.
- Replacement engines should be the same model as the original engine, or be the Briggs & Stratton designated replacement engine. Refer to the Operation & Maintenance Instructions for engine identification information.
Note: For all Go-karts use only a model 136200 series engine, which offers improved safety and performance.
- Do not use Briggs & Stratton engines on 3-wheel All-Terrain Vehicles (ATVs), motor bikes, air craft products, or vehicles intended for use in competitive events. Briggs & Stratton does not approve of or authorize such uses.

ENGINE INSTALLATION



- [1] Do not attempt to install this engine if you do not have the appropriate tools and knowledge of small engine installation procedures. Use only Briggs & Stratton parts. Contact your Authorized Service Dealer for assistance.
- [2] Do not modify the engine in any way without Briggs & Stratton factory approval. Any such modification is at the owner's sole risk.
- [3] If the exhaust system on the old engine was supplied by the equipment manufacturer, you must transfer the exhaust system and related components (original muffler and related pipes, brackets, clamps, and shields) to the new engine. All components must be in good condition.
- [4]

 WARNING

 Install muffler (and muffler deflector if used) so outlet points away from operator, fuel tank, and equipment, and so muffler heat will not damage or deform engine and components.
- [5]



 WARNING

 Ensure all fuel lines and fittings are properly assembled and do not leak. Replacement parts must be the same model as the original.
- [6]



 WARNING

 Ensure all wiring, including safety switches and engine shut-off components are completely installed and functioning properly.
- [7] Set engine speed to equipment manufacturer's specification. Refer to equipment manufacturer's manual. Do not tamper with governor springs, or other parts that will increase engine speed above specification.



- [8]

 WARNING



 All engine parts, including fuel cap, spark plug, muffler, air cleaner, and covers and guards for drive components (gears, belts, shafts, couplings, etc.) must be in place before attempting to start engine.
- [9]

 WARNING

 If engine is installed on walk behind lawn mower, all mower components, including cutting blade, must be correctly installed before attempting to start engine.
- [10]









 WARNING

 When working on the engine or equipment, remove spark plug wire from spark plug. For electric start, remove negative wire from battery.
- [11]

 WARNING

 Do not check for spark with spark plug removed. Use Briggs & Stratton spark tester #19368.

ENGINE OPERATION

	 WARNING
	When adding fuel:
Turn engine off and let engine cool at least 2 minutes before removing gas cap. Fill fuel tank outdoors or in well-ventilated area. Fill tank to about 1 inch below lowest portion of neck to allow for fuel expansion. Keep gasoline away from sparks, open flames, pilot lights, heat, and other ignition sources.	
  	 WARNING
	When starting engine:
Remove all external equipment/engine loads. Wait until spilled fuel is evaporated. Start engine outdoors. Pull cord slowly until resistance is felt, then pull rapidly. If engine floods, set choke to OPEN/RUN, place throttle in FAST and crank until engine starts.	
 	 WARNING
	When operating equipment:
Do not tip engine or equipment at angle which causes gasoline to spill. Run engine outdoors. Do not run in enclosed area, even if doors or windows are open. Do not choke carburetor to stop engine.	

SECTION I — BEFORE STARTING (Cont'd)

OIL BATH AIR CLEANER

Oil bath air cleaners must be filled before operating engine. Use same grade oil as in crankcase. Turn filter element counterclockwise to unscrew. Lift off filter element. Lift off bowl.

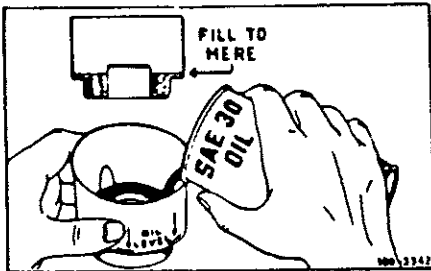
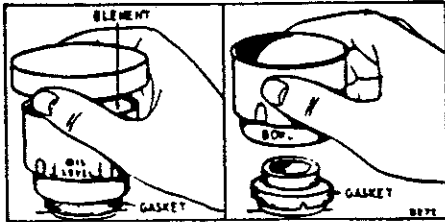

Pour oil in small bottom part of bowl to "OIL LEVEL" mark at end of arrows. Replace bowl on carburetor. Replace filter element and turn clockwise until snug. Be sure gaskets are in place.

FILL FUEL TANK COMPLETELY

CAUTION: Use clean, fresh "regular" grade gasoline. Purchase fuel in small

quantities and keep in clean container. Prolonged storage of gasoline can result in the formation of gum deposits which clog the fuel system.

DO NOT MIX OIL WITH GASOLINE.

Open Fuel Valve

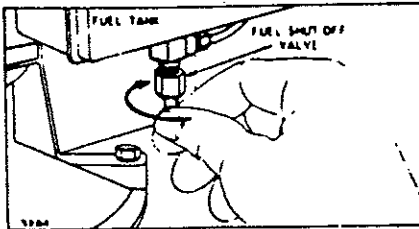

Choke Engine — Choke-A-Matic Control

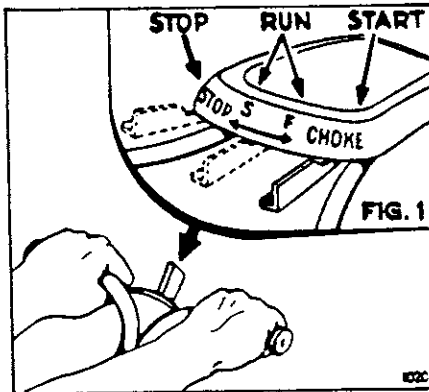

Move lever to "Full Choke" or "Start" position.

NOTE: This should fully close choke on carburetor. If it does not, remote control must be re-adjusted. See "Adjustments of Choke-A-Matic Carburetor Controls" Section IV.

Choke Engine — Manual Control

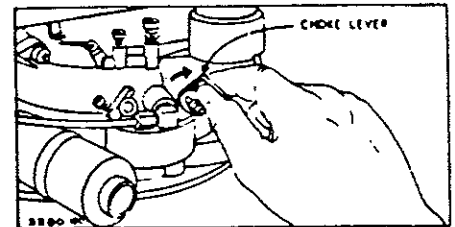

BE SURE THE STOP SWITCH IS AWAY FROM SPARK PLUG

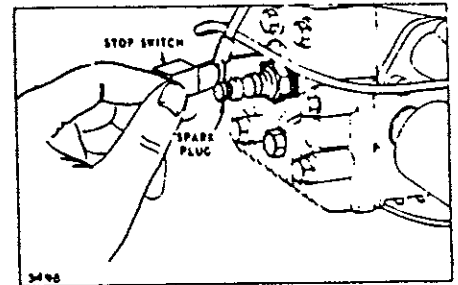

SECTION II STARTING

"Easy-Spin"™ Rewind Starter

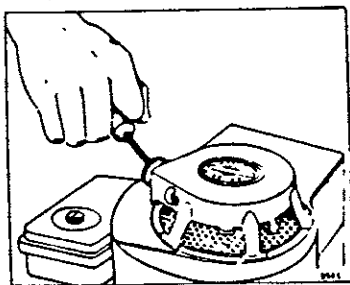

*Trademark of Briggs & Stratton Corp.

Grasp starter grip as illustrated and pull out cord two to three feet.

Repeat if necessary with choke opened slightly. When engine starts, open choke gradually.

"Easy-Spin"™ Rope Starter

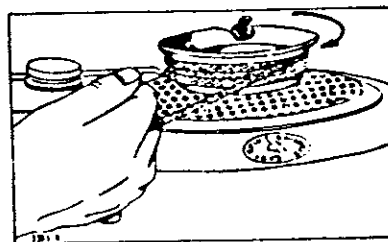

Wind starter rope around the pulley in direction shown by arrow.

Pull the rope with a quick full arm stroke. Repeat if necessary with choke open slightly. When engine starts, open choke gradually.

*Trademark of Briggs & Stratton Corp.

SECTION II — STARTING (Cont'd)

Shock-Free Wind-up Starter

1. Turn control knob, on the side of the blower housing, clockwise to "Crank" position.
2. Lift cranking handle and extend to cranking position.
3. 360° Rotation Type — Turn handle clockwise to wind up starter. Fold cranking handle to retracted position.
20° Ratchet Type — Ratchet type starters are wound up by moving handle clockwise as far as possible and returning handle to original position. Repeat this operation until spring is fully wound. Fold cranking handle to retracted position and place knob between rubber bumpers.
4. Turn control knob on blower housing counter-clockwise to "Start" position. As engine starts, gradually move choke control to open (run) position.

CAUTION: ALWAYS KEEP HANDS AND FEET CLEAR OF MOWER BLADE OR OTHER ROTATING MACHINERY.

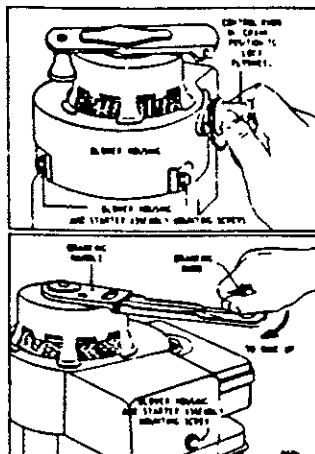

CAUTION: NEVER WORK ON MOWER BLADES WHEN "SHOCK-FREE" STARTER IS WOUND UP. IF BLADE BECOMES JAMMED SO THAT STARTER WILL NOT CRANK ENGINE, REMOVE BLOWER HOUSING AND STARTER ASSEMBLY FROM ENGINE BEFORE DOING ANY WORK ON MOWER OR ENGINE.

Do not turn the control knob to "Crank" position while engine is running.

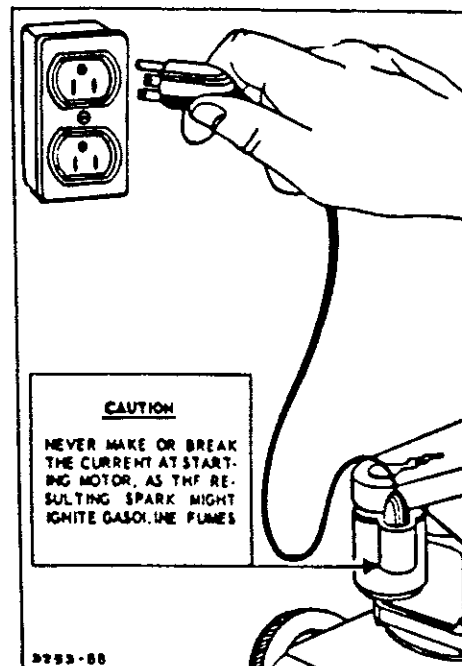

110 Volt A. C. Electric Starter

Attach electrical cord to engine starting motor. Plug cord into wall receptacle. When engine starts, remove plug from wall receptacle. Open choke gradually. A warm engine requires little or no choking. Detach cord at engine.

If the engine does not start after two or three attempts, open choke wide, wait a few seconds, then repeat.

STOPPING

a. Choke-A-Matic Type

Move control lever to "stop" position.

b. Manual Choke Type

Push the stop switch against end of spark plug.

SECTION III REGULAR MAINTENANCE

CHANGE OIL (Oil Sump)

Change oil after first 5 hours of operation while engine is warm. Thereafter change oil every 25 hours of operation while engine is warm. Drain plug is on bottom of oil sump.

Engine may be drained through oil drain Fig. 1, or oil filler opening shown in Fig. 2. Be sure to replace drain plug and oil filler cap. Check oil level regularly — at least after each 5 hours of operation. Be sure oil level is maintained FULL TO POINT OF OVERFLOWING.

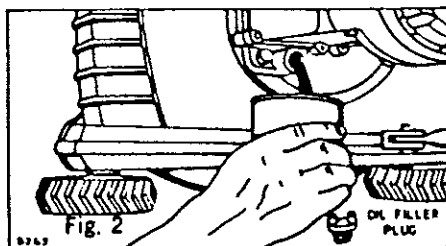
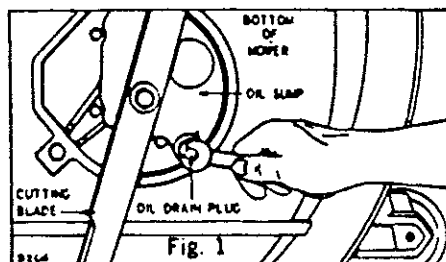

SECTION III — REGULAR MAINTENANCE (Cont'd)

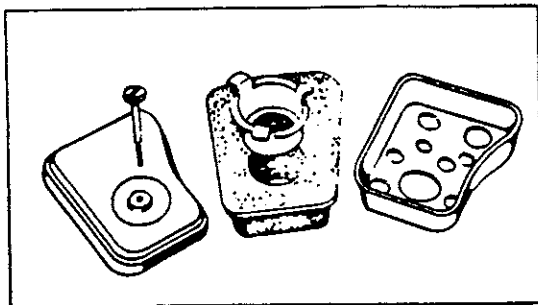

SERVICE AIR CLEANER REGULARLY

Clean and re-oil the air cleaner frequently (every few hours under extremely dusty conditions). Clean and re-oil at least every 25 hours under normal conditions.

"Oil-Foam" Type

1. Remove thumb screw
2. Lift air cleaner from carburetor.

3. Take air cleaner apart
4. A—Wash element in kerosene or solvent.
- B—Squeeze dry and re-oil with 3 tablespoons of engine oil.
- C—Squeeze again to spread oil thru foam.
- D—Assemble parts — fasten to carburetor with screw.

*Trademark of Briggs & Stratton Corp.

Oil Bath Type

1. Turn filter element counterclockwise to unscrew. Lift off filter element.
2. Lift off bowl. Pour out old oil.
3. Wash the filter element and bowl in kerosene or solvent and shake or wipe dry.
4. Pour oil in small bottom part of bowl to "OIL LEVEL" mark shown at end of arrows. Replace bowl on carburetor.
5. Replace filter element and turn clockwise until snug. Be sure gaskets are in place.

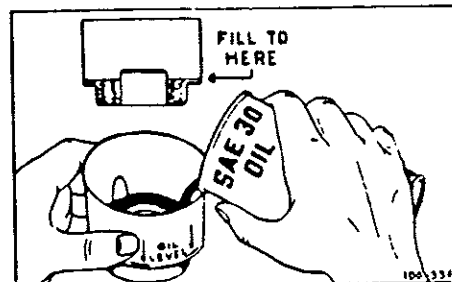
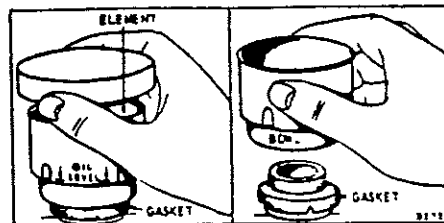

SECTION IV ADJUSTMENTS

CHOKE-A-MATIC CARBURETOR

Proper choke and stop switch operation is dependent upon proper adjustment of remote controls on the powered equipment.

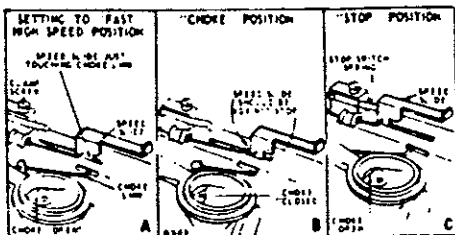

To Check Operation of Controls

1. Remove air cleaner.
2. Move remote control lever to "Choke" position. The carburetor choke should then be closed. Speed slide should be against stop on governor housing. (See B.)

3. Move the remote control lever to "Stop". The speed slide should then make contact with stop switch. (See C).

To Adjust:

Place remote control lever on equipment in "Fast" position. Loosen control casing clamp screw on carburetor. Move control casing and wire forward or backward until speed slide just touches choke operating link. (See A). Tighten casing clamp screw on carburetor. Re-check operation of control after adjustment. Re-assemble air cleaner.

GOVERNOR ADJUSTMENTS

REMOTE GOVERNOR CONTROL

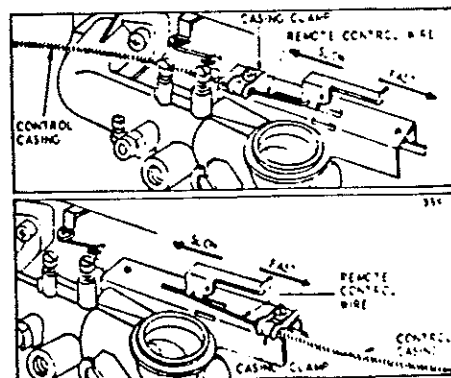

Remote control casing and wire are fastened to inner or outer end of carburetor. Illustration shows direction of movement of control lever on control box to increase or decrease speed.

SECTION IV — ADJUSTMENTS (Cont'd)

MANUAL FRICTION GOVERNOR CONTROL

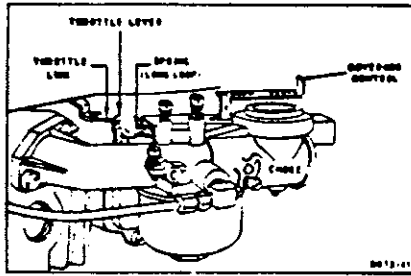

To increase engine speed, pull governor control out. Push in to decrease speed. Governor link must always be in the outer hole of throttle lever on carburetor and larger loop of governor spring in the hole closest to throttle shaft.

CARBURETOR ADJUSTMENT

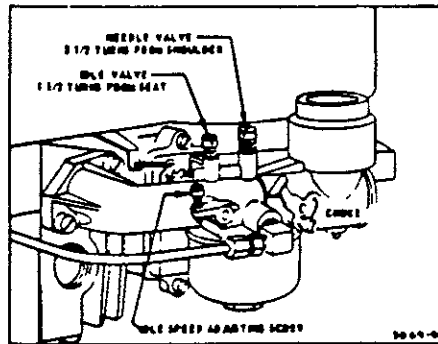

Initial Adjustment

Close the needle valve and then open it 2½ turns. Close idle valve and then open it 1½ turns. This initial adjustment will permit the engine to be started and warmed up before making final adjustment.

Final Adjustment

Turn needle valve in until engine misses (lean mixture), then turn it out past smooth operating point until engine runs unevenly (rich mixture). Now turn needle valve to the mid-point between rich and lean so the engine runs smoothly.

Hold throttle at idle position. Set idle speed adjusting screw until fast idle is obtained (1750 R.P.M.). Hold throttle in idle position and turn idle valve in (lean) and out (rich) until engine idles smoothly. Then reset idle speed so that engine idles at 1750 R.P.M. Release throttle—engine should accelerate without hesitation or sputtering. If engine does not accelerate properly, re-adjust carburetor to a slightly richer mixture.

SECTION V

STORAGE INSTRUCTIONS

DRAINING FUEL TANK AND CLEANING FUEL FILTER

CAUTION: Gasoline is highly flammable. Avoid spark or flame.

1. To drain fuel tank, loosen packing nut and remove fuel shut-off valve assembly.
2. Remove fuel line.
3. Remove fuel tank outlet and filter screen assembly from fuel tank.
4. Clean fuel filter in gasoline, alcohol or lacquer thinner. Screen not removable.
5. Re-assemble fuel tank outlet assembly, fuel line and fuel shut-off assembly.

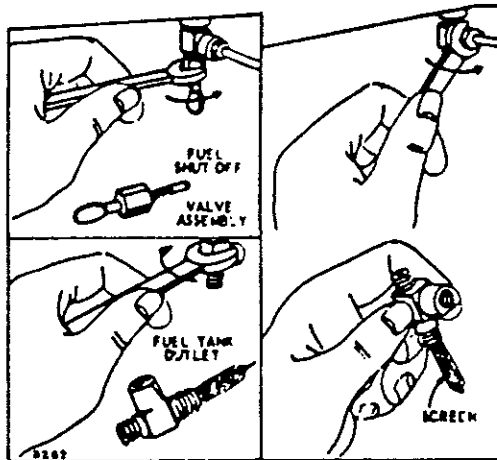

Engines stored over 30 days should be completely drained of fuel to prevent gum deposits forming on essential carburetor parts, fuel filter, fuel lines and tank.

- A. Drain fuel tank completely.
- B. Re-assemble fuel filter assembly, fuel line and fuel shut-off valve. Leave shut-off valve open.
- C. Operate engine until gasoline in carburetor is completely consumed.
- D. While engine is still warm, drain oil from crankcase. Refill with fresh oil.
- E. Remove spark plug, pour 1 ounce of SAE-30 oil into cylinder and crank slowly to distribute oil. Replace spark plug.
- F. Clean dirt and chaff from cylinder, cylinder head fins and blower housing.

SECTION VI PARTS AND SERVICE

GENERAL INFORMATION

These engines are single-cylinder, L-head, air-cooled type

MODEL SERIES	MODEL SERIES
80700 to 80706 and 81700 to 81706	80700 to 80796 and 81700 to 81796
Bore2 $\frac{3}{8}$ "	Bore2 $\frac{3}{8}$ "
Stroke1 $\frac{1}{2}$ "	Stroke1 $\frac{3}{4}$ "
Displacement6.65 cu. in.	Displacement7.75 cu. in.
Horsepower 2.25 HP max. @ 3600 RPM	Horsepower 3.0 HP max. @ 3600 RPM

The horsepower ratings listed above are established by standard I.C.E.I. procedures. For practical operation, the horsepower loading should not exceed 85% of these ratings. Engine power will decrease 3 $\frac{1}{2}$ % for each 1,000 ft. above sea level and 1% for each 10 degrees above 60 degrees F.

BRIGGS & STRATTON ENGINE WARRANTY POLICY

Here is a reproduction of the Briggs & Stratton Warranty that is supplied with each engine. (Be sure to fill out and return registration card at time of purchase):

THE WARRANTY

For ONE YEAR from purchase date, Briggs & Stratton Corp. will replace for the original purchaser, FREE OF CHARGE, any part, or parts found upon examination by any Factory Authorized Service Outlet, or by the Factory at Milwaukee, Wisconsin, to be DEFECTIVE IN MATERIAL AND/OR WORKMANSHIP.

All transportation charges on parts submitted for replacement under this Warranty must be borne by purchaser.

There is no other Warranty express or implied. Briggs & Stratton Corp. shall in no event be liable for consequential damages.

WARRANTY DOES NOT COVER BENT CRANKSHAFTS, FAILURE TO MAINTAIN OIL IN CRANKCASE, USER NEGLIGENCE OR ABUSE

NATION-WIDE SERVICE ORGANIZATION

Briggs & Stratton maintains a vast network of Authorized Service Dealers that are prepared to give you prompt and efficient engine service.



See yellow pages of your Classified Telephone Directory for nearby engine service under heading "Engines - Gasoline" or "Gasoline Engines".

TUNE-UP SPECIFICATIONS

Spark Plug TypeAC-45 Comm.; AL-A7R; Champ. J8.
Spark Plug Gap025"
Ignition Point Gap020"
Intake Valve Clearance005"-.007"
Exhaust Valve Clearance009"-.011"

CAUTION: Blast Cleaning of spark plugs in machines that use abrasive grit is not recommended. Spark plugs should be cleaned by scraping or wire brushing and washing with a commercial solvent or gasoline.

Major engine repairs should not be attempted unless you have the proper tools and a thorough knowledge of internal combustion engines.

REMOVING CARBON DEPOSITS

Clean combustion chamber, top of piston and around both valves every 100-300 hours of operation.

WARRANTY INSTRUCTIONS

When you request engine or parts warranty service always supply the Briggs & Stratton Authorized Service Dealer the following information.

Model Number, Type Number and Serial Number that are stamped on engine blower housing.

Date Purchased.

Kind of equipment engine is used on.

Name or trademark of manufacturer.

Name and address of dealer from whom purchased.

Approximate number of hours engine has run since equipment was purchased.

Also, give complete report of trouble experienced and special servicing instructions.

The above information is necessary to insure prompt and proper service.

Free Manuals Download Website

<http://myh66.com>

<http://usermanuals.us>

<http://www.somanuals.com>

<http://www.4manuals.cc>

<http://www.manual-lib.com>

<http://www.404manual.com>

<http://www.luxmanual.com>

<http://aubethermostatmanual.com>

Golf course search by state

<http://golfingnear.com>

Email search by domain

<http://emailbydomain.com>

Auto manuals search

<http://auto.somanuals.com>

TV manuals search

<http://tv.somanuals.com>