



# IMPORTANT!

You must ensure that you follow these instructions carefully and correctly. If this seat is not fitted securely and your child is not strapped in correctly, your child and other passengers are at serious risk of injury in the event of an accident

## Please read this User Guide carefully BEFORE trying to install your child car seat

The Hampshire Trading Standards Authority and Britax advise that child car seats should not be bought or sold second-hand. Please dispose of your child seat safely. Do not sell or pass it on.

After an accident, the child seat and your car seat belts should be replaced. Although they may look undamaged, if you were to have another accident the child seat and your car seat belts may not be able to protect your child as well as they should.

### No child seat is escape proof

Belt restraint systems cannot be designed to be completely "child proof" and yet comply with the legal requirements of European Standard ECE R44.

### Looking after your child seat

The child seat and its cover have been carefully designed, manufactured and tested to high safety standards.

### Cleaning the cover

Please read the labels on the cover for washing instructions.

**DO NOT** tumble dry the cover – short spin and drip dry only.

### Cleaning the shell

Sponge clean **ONLY** using hand soap and warm water.

**DO NOT** use solvents, detergents or washing-up liquid as these may weaken the seat.

### Pull-out tray and cup holder

**IMPORTANT – DO NOT** place pencils or other sharp pointed objects into the pull-out tray or cup holder.

**NEVER** put hot liquids into the pull-out tray or cup holder.

Small items held in the tray may fall into the casing of the booster section from time to time. In this case simply tip the seat forward to allow them to fall out through the user guide slot.

In some vehicles seat shape and interior design may prevent use of the pull out tray and cup holder.

**IMPORTANT** – The cover is a safety feature. **NEVER** use the child seat without it. Don't put your child's safety at risk by using other makes of replacement cover, they could stop the child seat from protecting your child as well as it should.

A replacement cover is available from your Britax stockist or contact Britax Customer Service Department on **01264 386034**.

### Guarantee

All Britax products are carefully designed, manufactured and tested. However, should this product prove faulty within 12 months of purchase due to a materials or manufacturing fault please return it to the original place of purchase. We will then, at our discretion, either repair it free of charge or replace it with the same or a similar product.

For guarantee purposes proof of purchase will be required. We recommend that you retain your receipt and attach it to this user guide. They should be kept in a safe place.

Britax does not accept liability for damage arising from abuse, misuse or negligence. This guarantee is not transferable and therefore does not apply to second-hand products.

Your statutory rights are not affected by this guarantee.

### Britax Excelsior Limited

1 Churchill Way West  
Andover  
Hampshire SP10 3UW  
United Kingdom

### A Britax Childcare company

Customer Service Helpline: 01264 386034  
Email: [helpline@uk.britaxeurope.com](mailto:helpline@uk.britaxeurope.com)  
Switchboard: 01264 333343  
Fax: 01264 334146

[www.britax.co.uk](http://www.britax.co.uk)

 Britax, whilst taking into account child car seat contact with vehicle seats throughout the development of new products, cannot accept responsibility for damage occurring to vehicle seats or seat belts.

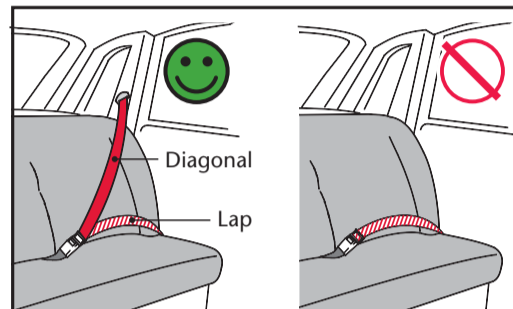

**IMPORTANT** – The child seat **MUST** only be used with a lap and diagonal seat belt (approved to UN/ECE Regulation no. 16 or other equivalent standards).

## WARNING

**DO NOT** use the child seat on a passenger seat fitted with an active front airbag unless your vehicle manufacturer confirms that it is safe.



**DO NOT** use the child seat on side or rearward facing vehicle seats.

**DO NOT** use anything, such as a cushion or coat, to raise the child seat off the passenger seat.

**DO NOT** attempt to dismantle, modify or add to any part of the child seat or change the way your car seat belts are made or used.

**DO NOT** use the child seat without the cover fitted.

**DO NOT** leave loose objects, such as luggage or books, in the back of your car. They must be properly secured.

**DO NOT** leave folding passenger seats unlatched. If you have to stop your car suddenly a loose seat back could injure your child.

**DO NOT** leave children alone in your car, even for a short time.

**DO NOT** allow children to play with or adjust the child seat.

**DO NOT** place hot liquids or sharp objects in the cup holder.

**DO** cover the child seat if your car is left in direct sunlight. Fittings can become hot to touch in sunny weather and the cover may become faded.

**DO** keep this user guide safe for future reference in the storage slot (under seat).

**DO** make sure that the child seat does not become trapped by a folding passenger seat or in the door of your car.

**DO** store the child seat in a safe place when it is not being used. Avoid placing heavy objects on top of it and do not store near direct heat sources.

**DO** always keep the child seat secure, even if it is not being used by your child.

## Introducing your new child car seat

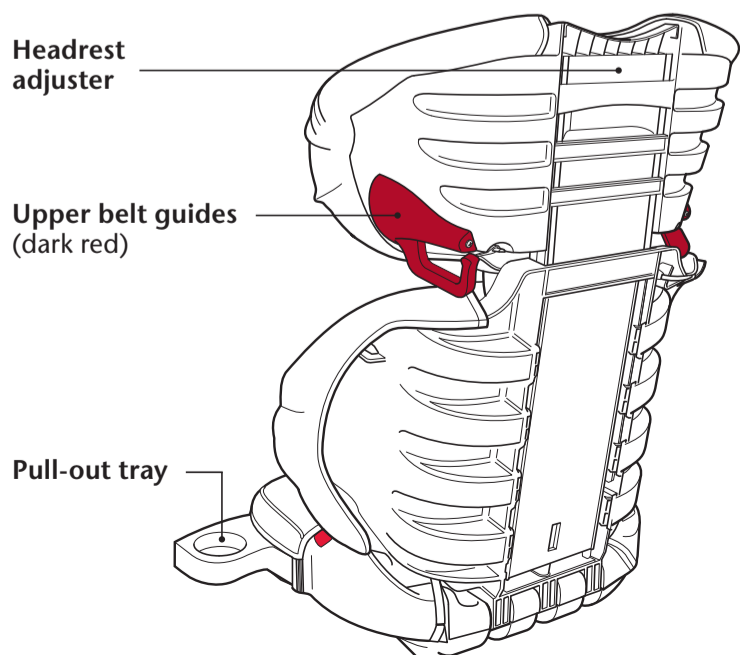
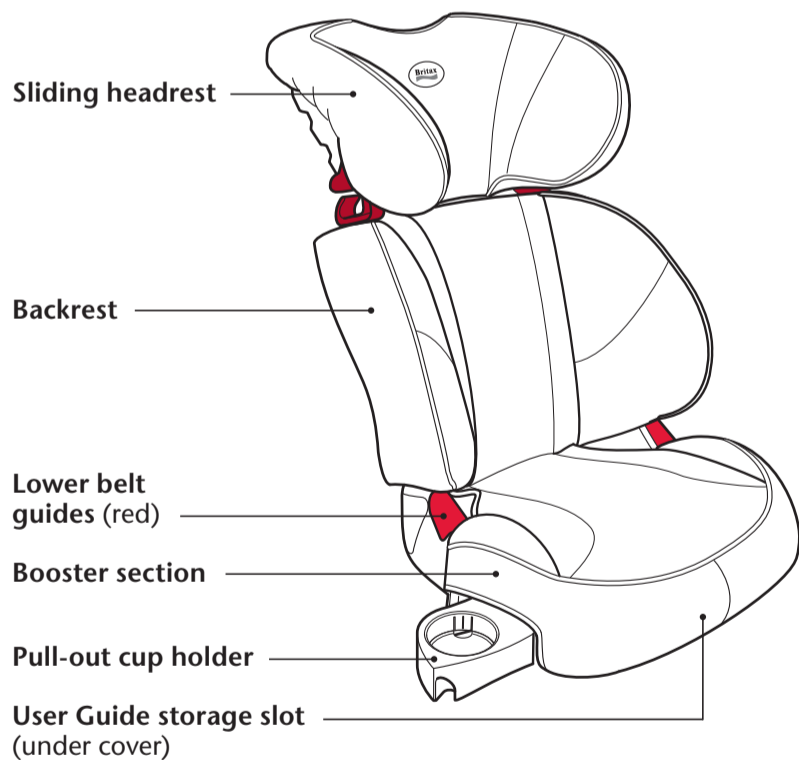

# Britax

## Evoiva 2-3



UK User Guide

# Children weighing 15-36kg (approx 4-11 years)

## 1 Adjusting the child seat

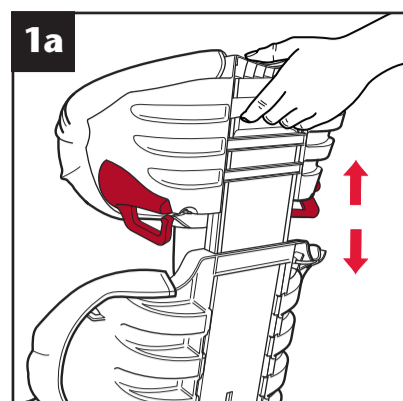

**IMPORTANT** - You must check that the headrest is in the correct position for your child before each journey.

With the seat supported, squeeze the headrest adjuster at the back of the headrest (**dia 1a**).

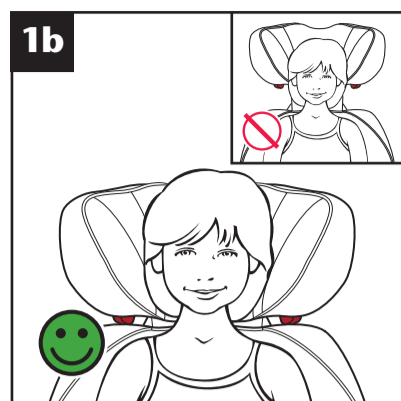

Move the headrest up or down so that the head is positioned centrally as in the picture (**dia 1b**).

When the headrest is in the correct position let go of the headrest adjuster and ensure it has locked into place.

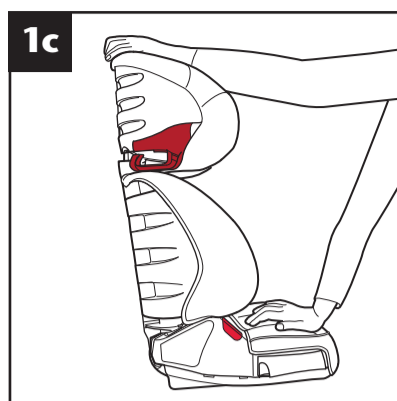

To adjust the backrest, place one hand on the seat section and push firmly on the backrest until you feel and hear a click (**dia 1c**). The backrest will now pivot freely and does not need to click into another position.

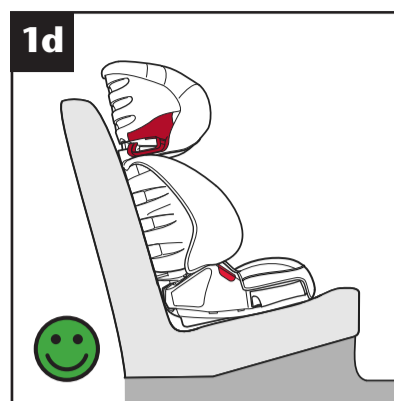

Push the child seat back until it is touching the car's seat back (**dia 1d**). The car's seat back can be moved to a desired angle.

**IMPORTANT** - The backrest of the child seat **MUST** always be in contact with the car's seat back **AND** the base section of the child seat **MUST** always be in contact with the car's seat base.

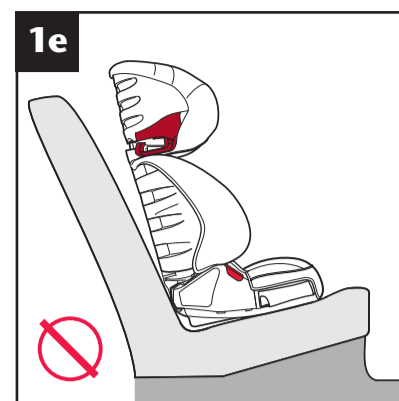

If one or both sections of the child seat are not in contact with both sections of the car's seat you **MUST** angle the car seat more upright (**dia 1e**).

**IMPORTANT** - Have you adjusted the headrest to the correct position for your child and ensured that the seat has an appropriate recline angle?

## 2 Installing the child seat in your car

**IMPORTANT** - This child seat **MUST** only be used with a lap and diagonal seat belt (approved to UN/ECE regulation no. 16 or equivalent standards).

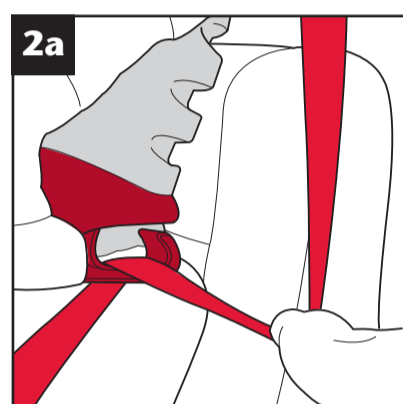

**IMPORTANT** - You **MUST NOT** use the child seat for a child weighing more than 36kg.

Place the child seat forward facing in your car, ensuring it is pushed firmly into the car seat. Feed the diagonal section of the seat belt through the dark red upper belt guide on the **OPPOSITE** side to the buckle (**dia 2a**).

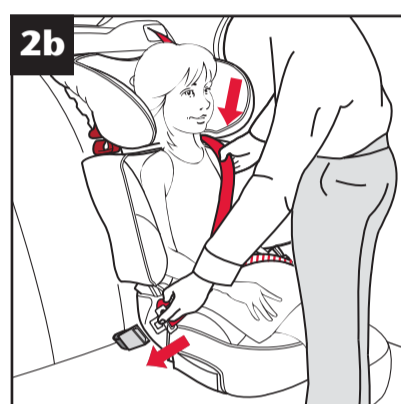

**IMPORTANT** - When installing the child seat, the vehicle seat must be kept in a normal upright position at all times. Reclining the vehicle seat will adversely affect the performance of the seat in a crash. Fasten the seat belt across your child. The lap section of the seat belt should rest on the red lower belt guides on each side of the child seat (**dia 2b**).

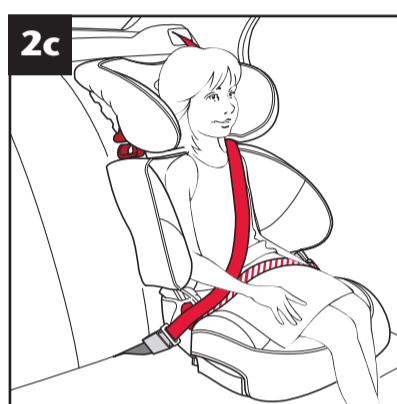

**IMPORTANT** - The lap section of the seat belt should rest as forward and as low as possible over your child's pelvis.

Remove as much slack as possible from the seat belt and make sure it is fitted comfortably, but tightly and is not twisted (**dia 2c**).

**IMPORTANT** - You must use the upper belt guide at all times.

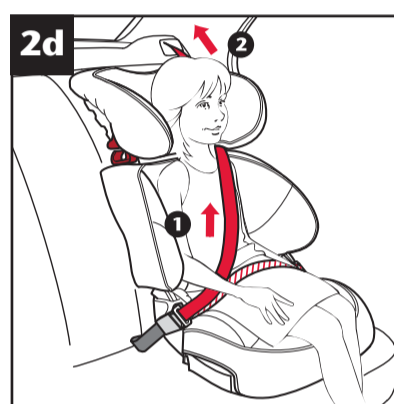

**IMPORTANT** - Ensure that the diagonal section of the belt lays over the shoulder of the child and **NOT** against the neck.

Tighten the seat belt by pulling the diagonal section in the direction of the arrow **1** (**dia 2d**).

If your vehicle has an adjustable seat belt upper anchorage, adjust its height so that the seat belt passes

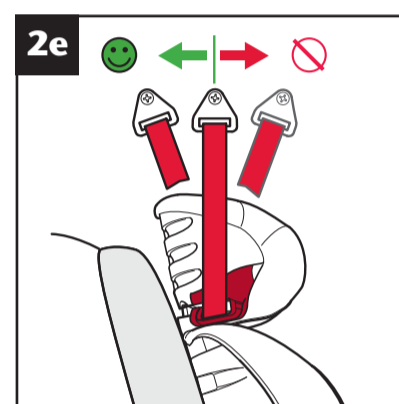

through the centre of the upper belt guide on the child seat and pull the seat belt to tighten **2**.

**IMPORTANT** - The child seat must not be installed in a position where the seat belt anchorage point is level with, or forward of, the upper belt guide (**dia 2e**).

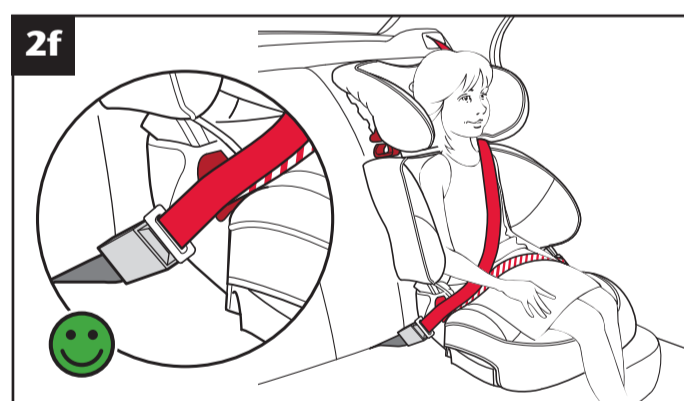

### Correct buckle position

**IMPORTANT** - Once you have installed the child seat it is important that you check the position of the seat belt buckle to ensure a secure installation.

If the seat belt buckle looks like this then the seat belt buckle position is correct (**dia 2f**).

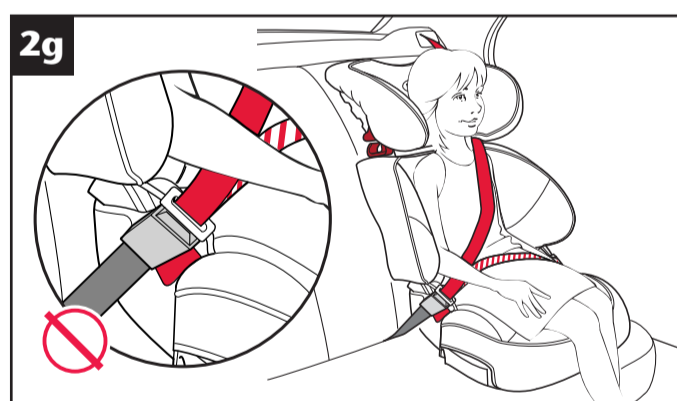

If the seat belt buckle looks like this, where the buckle is being pulled around the shell into the red lower belt guide (**dia 2g**), try another seating position in the car.

**IMPORTANT** - Do not leave your child seat loose. Always fasten the seat belt across the child seat when it is not being used by your child to prevent the seat being hurled forward in the event of an accident.

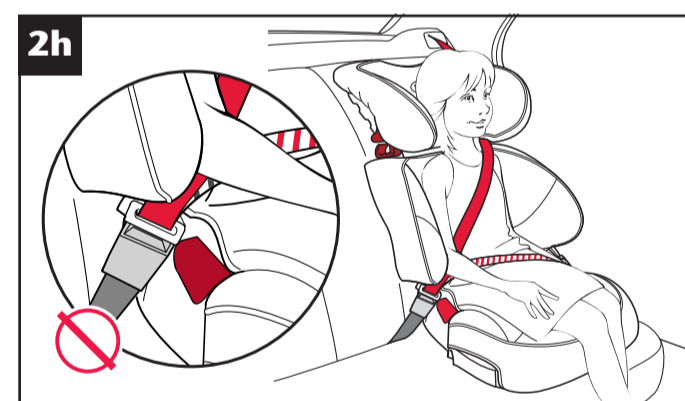

If the seat belt does not lie within the red lower belt guides then the seat is not properly installed (**dia 2h**).

If you are in any doubt contact Customer Services on **01264 386034**.

To release your child simply undo the seat belt.

## 3 Looking after the child seat

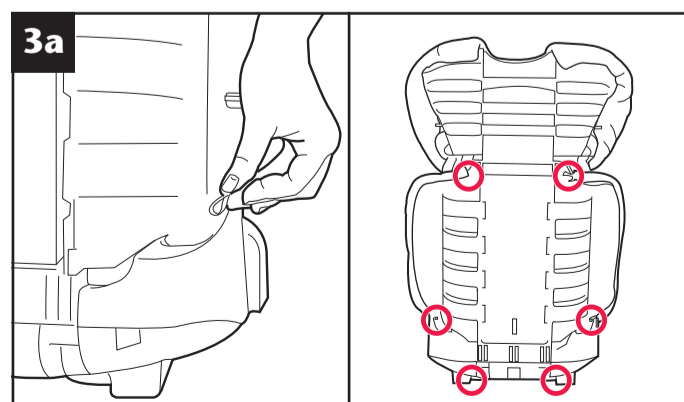

### Removing the cover

Unhook the elastics which hold the main cover section in place (**dia 3a**). The red spots show their location.

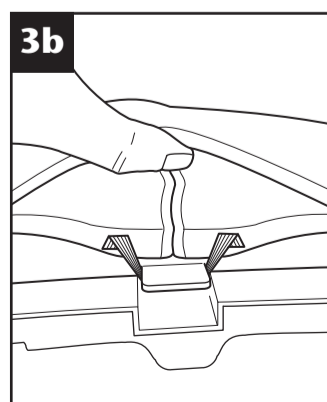

Unhook the elastic from the hook at the front of the seat (**dia 3b**).

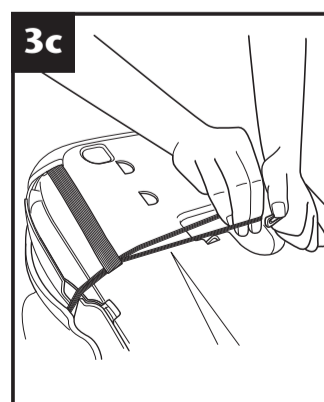

Unhook the elastics from the hooks on the underside of the seat (**dia 3c**).

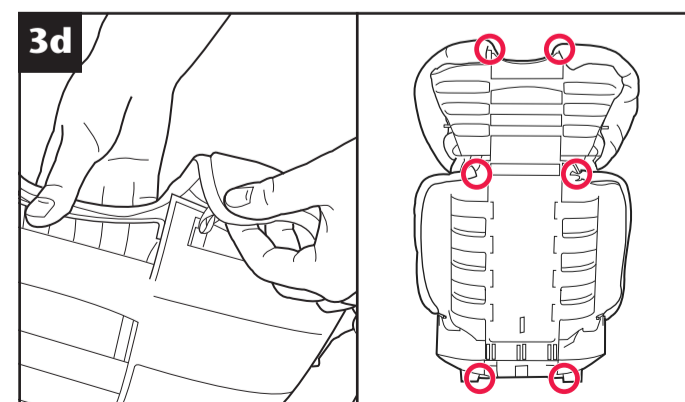

Unhook the elastics which hold the headrest cover section in place (**dia 3c**). The red spots show their location. The edges of the headrest cover section can now be pulled away from the seat.

## Free Manuals Download Website

<http://myh66.com>

<http://usermanuals.us>

<http://www.somanuals.com>

<http://www.4manuals.cc>

<http://www.manual-lib.com>

<http://www.404manual.com>

<http://www.luxmanual.com>

<http://aubethermostatmanual.com>

Golf course search by state

<http://golfingnear.com>

Email search by domain

<http://emailbydomain.com>

Auto manuals search

<http://auto.somanuals.com>

TV manuals search

<http://tv.somanuals.com>