

brother®

USER'S GUIDE

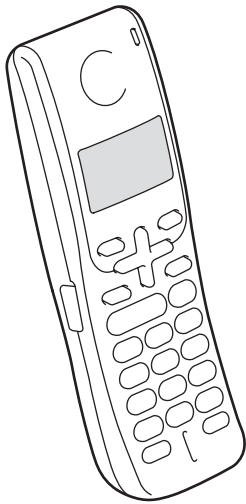

DECT™
Handset
BCL-D70

CE

© 2008 Brother Industries, Ltd.

Approval Information and Compilation and Publication Notice

THIS EQUIPMENT IS DESIGNED TO WORK WITH A TWO WIRE ANALOGUE PSTN LINE FITTED WITH THE APPROPRIATE CONNECTOR.

APPROVAL INFORMATION

Brother advises that this product may not function correctly in a country other than where it was originally purchased, and does not offer any warranty in the event that this product is used on public telecommunication lines in another country.

Compilation and Publication Notice

Under the supervision of Brother Industries Ltd., this manual has been compiled and published, covering the latest product descriptions and specifications.

The contents of this manual and the specifications of this product are subject to change without notice.

Brother reserves the right to make changes without notice in the specifications and materials contained herein and shall not be responsible for any damages (including consequential) caused by reliance on the materials presented, including but not limited to typographical and other errors relating to the publication.

EC Declaration of Conformity



EC Declaration of Conformity

Manufacturer

Brother Industries, Ltd.
15-1, Naeshiro-cho, Mizuho-ku, Nagoya 467-8561, Japan

Plant

Brother Industries (Shen Zhen) Ltd
G02414-1, Bao Chang Li Bonded Transportation Industrial Park,
Bao Long Industrial Estate, Longgang, Shenzhen, China

Herewith declare that:

Products description : Digital Cordless Handset
Model Name : BCL-D70

is in conformity with provisions of the R & TTE Directive (1999/5/EC) and we declare compliance with the following standards :

Standards applied :

Harmonized : Safety EN60950-1:2001+A11: 2004
Radio EN 301 406 V1.5.1
EN 301 489-1 V1.6.1
EN 301 489-6 V1.2.1
EN 50 360 : 2001

Year in which CE marking was first affixed : 2008

Issued by : Brother Industries, Ltd.

Date : 12th June, 2008

Place : Nagoya, Japan

Signature :

Junji Shiota
General Manager
Quality Management Dept.

Table of Contents

1	General Information	1
	Using the documentation	1
	Symbols and conventions used in the documentation	1
	Introduction	1
	Initial Setup	2
	Connecting the battery charger cradle power cord.....	2
	Installing the battery	2
	Setting your country.....	3
	Registering cordless handsets	3
	Deregistering cordless handsets	4
	Choosing a location	5
	Important safety instructions.....	5
	Control panel overview	6
	LCD display indications	7
2	Telephone	8
	Basic operation	8
	Making a telephone call.....	8
	Answering calls.....	8
	Mute (Hold).....	9
	Tone or pulse (Not available in New Zealand)	9
	Search	9
	Call History/Redial.....	9
	Caller ID history	9
	Pause	10
	Storing numbers for easy dialling	10
	Storing numbers	10
	Storing numbers from Call History.....	11
	Storing numbers from the Caller ID history	11
	Changing stored numbers	11
	Deleting stored numbers	12
	Advanced operation.....	12
	Transferring a call at the end of a conversation	12
	Using an intercom.....	13
	Making a three-way conference call	13
	Choosing Base unit	14
	Key Lock.....	14

3 Menu and Features 15

On-screen programming	15
Menu keys	15
Memory storage	15
Menu Table	16
Entering Text	18
General setup	19
Ring Volume	19
Beeper Volume	19
Speaker Volume	19
Handset Volume	19
Ringer Pattern	19
Automatic Daylight Savings Time (For Europe)	20
Daylight Savings Time (For Asia and Oceania)	20
LCD Contrast	20
Date and Time	20
Choosing your language	21
Echo Control	21
Modify PIN	22
Restoring all the settings to factory settings	22

4 Troubleshooting and Routine Maintenance 23

Troubleshooting	23
If you are having difficulty with your cordless handset	23
Error messages	24
Routine maintenance	25
Charging the battery	25
Cleaning	26
Replacing the battery	26

5 Specifications 28

General	28
Cordless handset	28
Battery	28
Battery charger cradle	29
AC adapter	29
Basic Features	29

6 Index 30

Using the documentation

Thank you for buying a Brother machine! Reading the documentation will help you make the most of your cordless DECT™ (Digital Enhanced Cordless Telecommunication) handset. The cordless handset battery is designed so that it can be replaced by the user. For replacement instruction, see *Replacing the battery* on page 26.

Symbols and conventions used in the documentation

The following symbols and conventions are used throughout the documentation.

Bold	Bold typeface identifies specific keys on the control panel of the cordless handset or the machine (base unit).
<i>Italics</i>	Italicized typeface emphasizes an important point or refers you to a related topic.
Courier New	Text in the Courier New font identifies messages on the LCD of the cordless handset.



Warnings tell you what to do to prevent possible personal injury.



Cautions specify procedures you must follow or avoid to prevent possible damage to the cordless handset or other objects.



Notes tell you how you should respond to a situation that may arise or give tips about how the operation works with other features.

Introduction

The cordless handset offers several functions that can be used to enhance the calling features of your Brother machine.

■ Redial:

Allows you to choose one of the last 10 numbers dialed for redialling. You can also store this number in the Phonebook.

■ Store numbers:

You can store up to 100 names with each having a number available in the Phonebook.

■ Transfer:

Transfer calls between the cordless handset and the machine (base unit). If you have additional optional cordless handsets, you can also transfer a call to another cordless handset.

■ Intercom:

Use the intercom feature to make internal calls between the cordless handset and the machine (base unit). If you have additional optional cordless handsets, you can also make an intercom call to another cordless handset.

■ Three-way conference call:

Three-way conference call allows two users to speak with a third party from the machine (base unit) and the cordless handset at the same time.

■ Caller ID:

If you have a Caller ID subscriber service from your telephone company the incoming caller will be identified on the LCD display of the cordless handset. You can also store this number as a Phonebook. This feature may not be available in some countries.

Initial Setup

Your Brother machine can support up to 3 optional cordless handsets for a total of 4 cordless handsets. If you have purchased an optional cordless handset please follow the setup steps instructions below. For the cordless handset that was included with your machine please follow the setup steps instructions in the Quick Setup Guide.

Connecting the battery charger cradle power cord

- 1 Plug the connector into the socket (1) and then hook the cable around its retaining clip (2) as shown in the diagram.

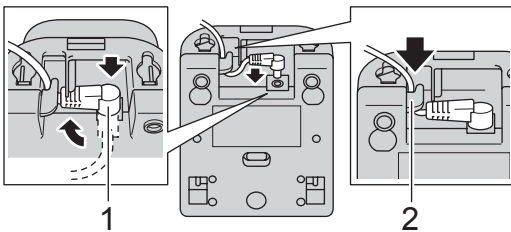

- 2 Plug the AC adapter into the electrical socket.

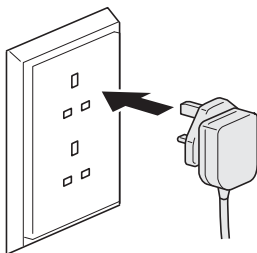

(Example for U.K.)

Installing the battery

- 1 Insert the connector (1) of the battery (2) in the direction shown below.

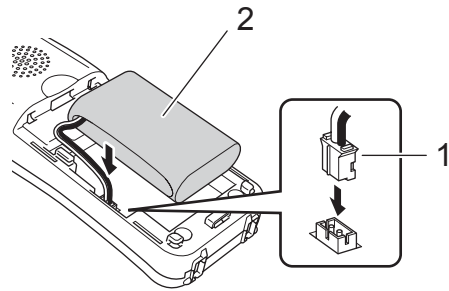

- 2 Place the battery in the position shown.

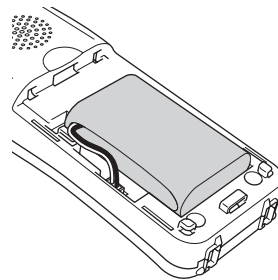

- 3 Install the battery cover by sliding it onto the back of the handset.

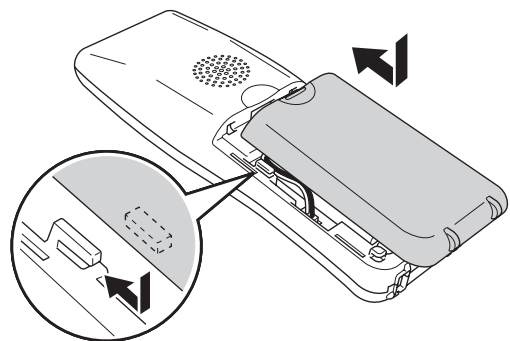

Note

Be careful that you do not catch the battery connector cord.

- 4 Charge the battery by leaving the cordless handset in the cradle for at least 12 hours before you use it. (See *Charging the battery* on page 25.) You can continue to set up the handset during this time.

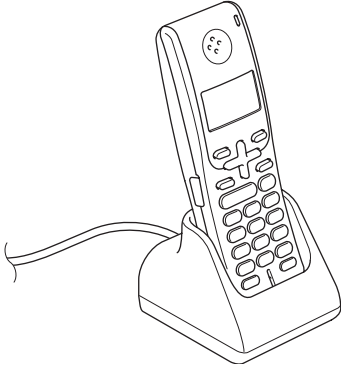

Setting your country

The first time you install the battery, you must set your country so that the cordless handset works correctly on local telecommunication lines.

- 1 Press **Menu/OK**.
- 2 Press **▲** or **▼** to choose your country. Press **Menu/OK**.
- 3 Press **1** to confirm.



Note

(For Asia)

If you do not find your country, choose *Others* in step 2.

Registering cordless handsets

You can register up to 3 additional cordless handsets for a total of 4 cordless handsets to the machine (base unit).

- 1 Press **MENU** on the touchscreen of the machine (base unit).
- 2 Press **▲** or **▼** to display *Initial Setup*.
- 3 Press *Initial Setup*.
- 4 Press **▲** or **▼** to display *Register Handset*.
- 5 Press *Register Handset*.
- 6 Press *Register*.
The machine (base unit) searches for the cordless handset.
- 7 Press **Menu/OK** on the cordless handset.
- 8 Press **▲** or **▼** to choose *Register HS*. Press **Menu/OK**.
- 9 Press **▲** or **▼** to choose *Base1, Base2, Base3* or *Base4*. Press **Menu/OK**.



Note

- If you have already registered the handset to a base unit, make sure you choose a base unit number that is not being used. For example, if you register the handset to an additional base unit and you choose *Base1*, the base unit previously stored in *Base1* will be overwritten and the handset will no longer be connected to it.
- Your machine (base unit) is already stored as *Base1* on the included handset.

- 10 Enter the registered 4-digit PIN number of the machine (base unit) (The factory setting is “0000”.) by pressing the dial pad on the control panel of the cordless handset.
Press **Menu/OK**.



Note

- If you hear three short beeps, the cordless handset did not register. Try to register the cordless handset again.
- If you want to install another cordless handset, repeat steps 6 through 10.
- You can change the PIN number. (See *Modify PIN* on page 22.)
- You may register GAP (Generic Access Profile) compatible DECT™ handsets to your machine (base unit). Follow steps 1 through 6, then refer to your handset documentation to complete the registration. Functions are limited to making and receiving external calls. Some handsets may not work with your machine.

- 11 Press **Stop/Exit** on the control panel of the machine (base unit).

Deregistering cordless handsets

You can deregister your cordless handset. If you are using more than one cordless handset, deregistration will remove all handsets registered with the machine (base unit).

- 1 Press **MENU** on the touchscreen of the machine (base unit).
- 2 Press **▲** or **▼** to display *Initial Setup*.
- 3 Press *Initial Setup*.
- 4 Press **▲** or **▼** to display *Register Handset*.
- 5 Press *Register Handset*.
- 6 Press *Terminate*.
Press **Yes** to confirm.
- 7 Press **Stop/Exit**.

Choosing a location

- Choose a location where the temperature remains between 10° C and 35° C.
- DO NOT put the cordless handset and cradle near heaters, air conditioners, water or chemicals.
- DO NOT expose the cordless handset and cradle to direct sunlight, excessive heat, moisture, or dust.
- DO NOT use the cordless handset near electro-medical equipment.
- We recommend at least 3 m between the machine (base unit) or cordless handset and possible sources of radio interference.

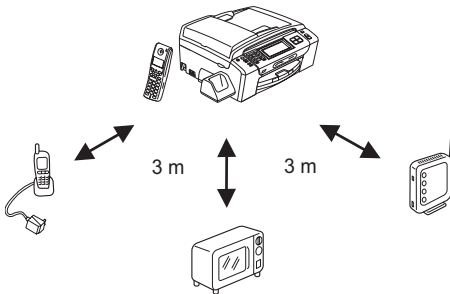

Important safety instructions

! WARNING

Use only the AC adapter and the cradle supplied with this cordless handset.

This product must be installed near an electrical socket that is easily accessible.

Use only a genuine Brother rechargeable battery.

DO NOT dispose of a used battery in a fire. It may explode.

Corrosive fluid rarely leaks out. If it gets in your eyes wash them with water at once. Call a doctor if you are concerned.

DO NOT allow the battery to touch any conductive materials. It can cause a short circuit of the battery.

Small metallic objects such as pins and staples may be attracted to the phone's earpiece.

! CAUTION

DO NOT take off the white plastic that covers the battery.

Control panel overview



1 LCD (liquid crystal display)

Displays messages on the screen to help you set up and use your cordless handset.

2 (Redial/Pause)

Redials any of the last 10 numbers you called. It also lets you put a pause in Phonebook numbers.

3 Headset socket

You can connect an external headset with microphone (not included) to the cordless handset. To access the headset socket fold open the headset socket cover located on the left side of the cordless handset. You can connect any standard headsets that use a 2.5 mm mini style plug.

4 C (Clear)

Press to back up a cursor and delete a letter.

5 (Talk)

Press to make or receive a phone call.

6 Dial Pad

Use these keys to dial a telephone number and as a keyboard for entering information into the cordless handset.

The # key lets you temporarily switch the dialling mode during a telephone call from Pulse to Tone ¹.

¹ Not available in New Zealand

7 (Speaker Phone)

Lets you speak to another party without lifting the cordless handset.

8 Charging LED

Turns green when the cordless handset is being charged.

9 R

Use this key to gain access to an outside line, or transfer a call to another extension when it is connected to a PBX.

(For Asia and Oceania regions)

Gaining access to an outside line is only available to users in Australia and New Zealand.

10 Menu keys:

■ Volume keys



You can press these keys to adjust the ring, speaker or handset volume of the cordless handset.



Lets you look up numbers that are stored in the dialling memory.



Press to scroll through the menus and options.

11 Menu/OK

Lets you access the Menu to program or store your settings in the cordless handset.

12  (Off)

Press to hang up or cancel the current operation.

13 Int (Mute/Intercom, Hold/Intercom)

Puts the current phone call on hold. Also, press this key to speak on the intercom, to transfer an incoming call to the cordless handset or to make a three-way conference call.

LCD display indications

The LCD shows the current cordless handset status.

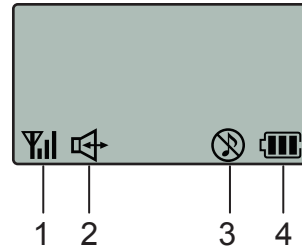

1 Cordless status

A four level indicator shows the current cordless handset signal strength.



2 Speaker Phone

Lets you see when you are speaking with the Speaker Phone.

3 Ring volume status

Lets you see when the ring volume is set to off.

4 Battery status

A four level indicator shows the available battery.

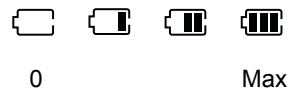

2



Telephone

Basic operation

Making a telephone call

- 1 Pick up the cordless handset.
- 2 Enter a number using the dial pad or choose a number stored in the dialling memory.





- 3 Press .
- 4 Speak clearly toward the microphone.
- 5 Press  to hang up.
- 6 Replace the cordless handset.







Note

If you want to make a telephone call without lifting the cordless handset, press  and enter a number using the dial pad.

Answering calls

- 1 Pick up the cordless handset from the cradle to answer the call. If your cordless handset is not in the cradle you must press  to answer the call.
- 2 To end the call, press .
- 3 Replace the cordless handset.

When the machine (base unit) or the cordless handset rings, instead of lifting the cordless handset, and pressing  you can also press  on the cordless handset. Speak clearly toward the cordless handset. To end the call, press .

If you have a bad connection, your caller might hear your voice echoed during the call. If you experience this problem, pick up the cordless handset and press  to use the handset.



Note



Even if it is a fax call when you answer, the machine (base unit) will receive the fax automatically. See *Fax Detect* in the User's Guide.

Mute (Hold)

If you want to put a call on hold, press the **Int** key. To release the call from hold press **Int** again. You can also transfer to the machine (base unit) or to another cordless handset if you have an additional optional cordless handset. (See *Transferring a call at the end of a conversation* on page 12.)

Tone or pulse (Not available in New Zealand)

If you have a pulse dialling service, but need to send tone signals (for example, for telephone banking), follow the instructions below. If you have a Touch Tone service, you will not need this feature to send tone signals.

- 1 Pick up the cordless handset.
- 2 Press .
- 3 Press **#** on the control panel of your cordless handset. Any digits dialled after this will send tone signals. When you hang up, the cordless handset will return to the pulse dialling service.
- 4 Press .



Search

You can search for names you have stored in the Phonebook memory.

- 1 Pick up the cordless handset.
- 2 Press **▲** () and do one of the following:
 - Press **▲** or **▼** to choose the name you want to call.
 - Use the dial pad to enter the first letter of the name, and then press **▲** or **▼** to choose the name you want to call.

Call History/Redial

The last 10 numbers you called will be stored in the call history. You can choose one of these numbers to make a call, add it to the Phonebook, or delete it from the history.

- 1 Press . You can also choose **Call History** by pressing **Menu/OK**.
- 2 Press **▲** or **▼** to choose the number and do one of the following:
 - To make a call, press .
 - To store or delete the number, press **Menu/OK** and go to step 3.
- 3 Do one of the following:
 - If you want to store the number, press **▲** or **▼** to choose **Add Phonebook**. Press **Menu/OK**. (See *Storing numbers from Call History* on page 11.)
 - Press **▲** or **▼** to choose **Delete**. Press **Menu/OK**. Press **1** to confirm.
 - If you want to delete all the stored numbers, press **▲** or **▼** to choose **All Delete**. Press **Menu/OK**. Press **1** to confirm.

Caller ID history

This feature requires the Caller ID subscriber service offered by many local telephone companies. (See *Caller ID in the User's Guide*.)

The last 30 numbers you received will be stored in the Caller ID history. You can choose one of these numbers to make a call, add it to the Phonebook, or delete it from the history.

- 1 Press **Menu/OK**.



- 2 Press ▲ or ▼ to choose *Caller ID hist..*
Press **Menu/OK**.
- 3 Press ▲ or ▼ to choose the number and do one of the following:
 - To make a call, press .
 - To store or delete the number, press **Menu/OK** and go to step 4.
- 4 Do one of the following:
 - If you want to store the number, press ▲ or ▼ to choose *Add Phonebook*.
Press **Menu/OK**.
(See *Storing numbers from the Caller ID history* on page 11.)
 - Press ▲ or ▼ to choose *Delete*.
Press **Menu/OK**.
Press **1** to confirm.
 - If you want to delete all the stored numbers, press ▲ or ▼ to choose *All Delete*.
Press **Menu/OK**.
Press **1** to confirm.



Note

This feature may not be available in some countries.

Pause

When dialling manually, you can press  to insert a 3.5 second pause between numbers. If you are dialling overseas, you can press  as many times as needed to increase the length of the pause.

Storing numbers for easy dialling

You can set up your cordless handset for easy dialling. When you choose a number stored in the dialling memory, the LCD shows the name, if you stored it, or the number.

Storing numbers

You can store up to 100 locations with a name and a number. When you dial you will only have to press a few keys (For example:

▲ (□□), ▲ or ▼ and ).

- 1 Press **Menu/OK**.
- 2 Press ▲ or ▼ to choose *Phonebook*.
Press **Menu/OK**.
- 3 Press ▲ or ▼ to choose *Add*.
Press **Menu/OK**.
- 4 Do one of the following:
 - Enter the name (up to 16 characters) using the dial pad.
Press **Menu/OK**.
(To help you enter letters, see *Entering Text* on page 18.)
 - To store the number without a name, press **Menu/OK**.
- 5 Enter the telephone number (up to 20 digits).
Press **Menu/OK**.
- 6 Do one of the following:
 - To store another number, go to step 3.
 - To finish the setting, press .

Storing numbers from Call History

You can also store numbers from the call history.

- 1 Press . You can also choose *Call History* by pressing **Menu/OK**.
- 2 Press **▲** or **▼** to choose the number you want to store. Press **Menu/OK**.
- 3 Press **▲** or **▼** to choose *Add Phonebook*. Press **Menu/OK**.
- 4 Do one of the following:
 - Enter the name (up to 16 characters) using the dial pad. Press **Menu/OK**. (To help you enter letters, see *Entering Text* on page 18.)
 - To store the number without a name, press **Menu/OK**.
- 5 Press **Menu/OK** to confirm the number.

Storing numbers from the Caller ID history

If you have the Caller ID subscriber service from your telephone company you can also store Phonebook numbers from incoming calls in the Caller ID history. (See *Caller ID* in the machine's User's Guide.)

- 1 Press **Menu/OK**.
- 2 Press **▲** or **▼** to choose *Caller ID hist..* Press **Menu/OK**.
- 3 Press **▲** or **▼** to choose a number you want to store. Press **Menu/OK**.

- 4 Press **▲** or **▼** to choose *Add Phonebook*. Press **Menu/OK**.
- 5 Do one of the following:
 - Enter the name (up to 16 characters) using the dial pad. Press **Menu/OK**. (To help you enter letters, see *Entering Text* on page 18.)
 - To store the number without a name, press **Menu/OK**.
- 6 Press **Menu/OK** to confirm the number.

Changing stored numbers

You can change a name or number that has already been stored.

- 1 Press **Menu/OK**.
- 2 Press **▲** or **▼** to choose *Phonebook*. Press **Menu/OK**.
- 3 Press **▲** or **▼** to choose *Change*. Press **Menu/OK**.
- 4 Press **▲** or **▼** to choose the name or number you want to change. Press **Menu/OK**.
- 5 Do one of the following:
 - Enter the name (up to 16 characters) using the dial pad. Press **Menu/OK**. (See *Entering Text* on page 18.)
 - If you do not want to change the name, press **Menu/OK**.



Note



How to change the stored name or number:

If you want to change a character, press **◀** or **▶** to position the cursor under the incorrect character, then press **C**. Re-enter the correct letter.

- 6 Do one of the following:
 - Enter the new number (up to 20 digits).
Press **Menu/OK**.
 - If you do not want to change the number, press **Menu/OK**.
- 7 Press .

Deleting stored numbers

You can delete a name or number that has already been stored.

- 1 Press **Menu/OK**.
- 2 Press **▲** or **▼** to choose *Phonebook*.
Press **Menu/OK**.
- 3 Do one of the following:
 - Press **▲** or **▼** to choose *Delete*.
Press **Menu/OK**.
 - If you want to delete all the stored numbers, press **▲** or **▼** to choose *All Delete*.
Press **Menu/OK**.
Press **1** to confirm and then press .
- 4 Press **▲** or **▼** to choose the name or number you want to delete.
Press **Menu/OK**.
Press **1** to confirm.
- 5 Press .

Advanced operation

You can transfer a call, make an intercom call or make a three-way conference call. If you have optional cordless handsets you must register each handset to the machine (base unit). See *Registering cordless handsets* on page 3. The cordless handset that was included with your machine (base unit) is already registered as Handset 1.

Base Unit	Machine
Handset#1	Handset included with the machine
Handset#2	Optional cordless handset
Handset#3	Optional cordless handset
Handset#4	Optional cordless handset

Transferring a call at the end of a conversation

From the machine (base unit)

- 1 When you finish speaking, press **Mute/Intercom (Hold/Intercom)**.
- 2 Press **1**, **2**, **3** or **4** on the dial pad for the handset you want to transfer to.
- 3 After you confirm the other person is on the line, hang up.



Note

If no one is on the line, press **Mute/Intercom (Hold/Intercom)** to release the call from hold.

From the cordless handset

- 1 Press **Int** when you finish speaking.
- 2 Press **▲** or **▼** to choose `Base Unit`. Press **Menu/OK**.
- 3 After you confirm the other person is on the line, press .



Note

- If no one is on the line, press **Int** to release the call from hold.
- If you have one or more optional cordless handsets, you can choose one of these handsets in step 2.

Using an intercom

The intercom feature allows you to make internal calls between the cordless handset and the machine (base unit). If you have additional optional cordless handsets (4 max.) you can also make an intercom call to another cordless handset.

Making a call from the machine (base unit)

- 1 Press **Mute/Intercom (Hold/Intercom)**.
- 2 Press **1, 2, 3** or **4** on the dial pad for the handset you want to connect to.
- 3 After you finish speaking, hang up.

Making a call from the cordless handset

- 1 Pick up the cordless handset.
- 2 Press **Int**.
- 3 Press **▲** or **▼** to choose `Base Unit`. Press **Menu/OK**.
- 4 After you finish speaking, hang up.



Note

If you have one or more optional cordless handsets, you can choose one of these handsets in step 3.

Making a three-way conference call

During a call to or from an outside line you can add another person to the call to make a three way conference call.

Calling the cordless handset from the machine (base unit)

- 1 During a call, press **Mute/Intercom (Hold/Intercom)**.
- 2 Press **1, 2, 3** or **4** on the dial pad to add the handset you want to the call.
- 3 After you confirm the other person is on the line, press **Mute/Intercom (Hold/Intercom)**.

Calling the machine (base unit) from the cordless handset

- 1 During a call, press **Int**.
- 2 Press **▲** or **▼** to choose `Base Unit`. Press **Menu/OK**.
- 3 After you confirm the other person is on the line, press **Int**.



Note

If you have one or more optional cordless handsets, you can choose one of these handsets in step 2.

Choosing Base unit

If you registered multiple base units into your cordless handset, you can choose which base unit you want to use. (See *Registering cordless handsets* on page 3.)

- 1 Press **Menu/OK**.
- 2 Press **▲** or **▼** to choose *HS Settings*. Press **Menu/OK**.
- 3 Press **▲** or **▼** to choose *Select BASE*. Press **Menu/OK**.
- 4 Press **▲** or **▼** to choose *Base1*, *Base2*, *Base3* or *Base4*. Press **Menu/OK**.
- 5 Press .

Key Lock

Key Lock lets you prevent unauthorized access to the cordless handset. While Key Lock is on, the handset will only be able to answer calls.

Turning Key Lock on

- 1 Press **Menu/OK**, **#**.
The LCD shows *Keypad Locked*.

Turning Key Lock off





- 1 Press **Menu/OK**, **#**.

On-screen programming

Your cordless handset is designed to be easy to use with LCD on-screen programming using the menu keys. User-friendly programming helps you take full advantage of all the menu selections your cordless handset has to offer.

Since your programming is done on the LCD, we have created step-by-step on-screen instructions to help you program your cordless handset. All you need to do is follow the instructions as they guide you through the menu selections and programming options.

Menu keys

	<p>Access the menu.</p> <p>Go to the next menu level.</p> <p>Accept an option.</p>
	<p>Delete an incorrect letter when you need to enter text into the cordless handset.</p> <p>Go back to the previous menu level.</p>
	<p>Scroll through the current menu level.</p>
	<p>Exit the menu.</p>

To access the menu mode:

- 1 Press **Menu/OK**.
- 2 Press ▲ or ▼ to choose an option.
- 3 Press **Menu/OK** when that option appears on the LCD.
The LCD will then show the next option.
- 4 Press ▲ or ▼ to choose the option.
- 5 Press **Menu/OK**.
When you finish setting an option, the LCD shows *Accepted*.

Memory storage

Even if your battery is discharged, you will not lose your menu settings because they are stored permanently. You may have to reset the date and time.

Menu Table

The menu table will help you understand the menu selections and options that are found in the cordless handset's programs. The factory settings are shown in Bold with an asterisk.

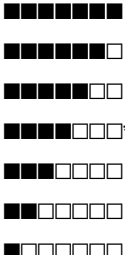
Level1	Level2	Level3	Options	Descriptions	Page
Phonebook	Add Change Delete All Delete	—	—	You can add, change or delete a number.	10
Call History	—	Delete All Delete Add Phonebook	—	You can choose a number from the call history and then make a phone call to it, add it to the Phonebook, or delete it.	9
Caller ID hist.	—	Delete All Delete Add Phonebook	—	You can choose a number from the Caller ID history and then make a phone call to it, add it to the Phonebook, or delete it.	9
Modify Pin	—	—	—	You can change the PIN number of the machine (base unit).	22
HS Settings	Setup Ringer	Beeper	On* Off	Adjusts the volume level of the beeper.	19
		Ringer Pattern	Signal 1* Signal 2 Signal 3 Signal 4 Signal 5 Melody 1 Melody 2	You can choose a ring pattern.	19
	Auto Daylight (For Europe)	—	On* Off	Changes for daylight savings time automatically.	20
	Daylight Save (For Asia and Oceania)	—	On Off	Changes for daylight saving time manually.	20
	LCD Contrast	—		Adjusts the contrast of the LCD.	20

Level1	Level2	Level3	Options	Descriptions	Page
HS Settings (Continued)	Date&Time	—	—	Puts the date and time on the LCD.	20
	Select Language	—	English* French German Dutch Italian Spanish Portuguese Norwegian Swedish Finnish Danish	Allows you to change the LCD language for your country.	21
	Select BASE	—	Base1* Base2 Base3 Base4	You can choose a base unit.	14
	HS Default	—	—	Restores all settings to the factory default.	22
Register HS	—	—	Base1 Base2 Base3 Base4	Registers the cordless handset into the machine (base unit).	3

Entering Text

When you are storing a name or a number in the Phonebook memory, you may need to enter text into the cordless handset. Most number keys have three or four letters printed on them. The keys for **0**, **#** and ***** do not have printed letters because they are used for special characters.

By pressing the relevant number key repeatedly, you can access the character you want.

Press Key	one time	two times	three times	four times
2	A	B	C	2
3	D	E	F	3
4	G	H	I	4
5	J	K	L	5
6	M	N	O	6
7	P	Q	R	S
8	T	U	V	8
9	W	X	Y	Z

Putting spaces

To enter a space in a name, press ► twice between characters.

Making corrections

If you entered an incorrect letter and want to change it, press ◀ to move the cursor under the incorrect character, press **C** to delete, and then re-enter the correct character. You can also back up and insert letters.

Repeating letters

If you need to enter a letter that is on the same key as the letter before, press ► to move the cursor to the right before you press the key again.

Special characters and symbols

Press *****, **#** or **0**, repeatedly until you see the special character or symbol you want.

Press ***** for (space) ! " # \$ % & ' () *
+ , - . / €



Press **#** for ; < = > ? @ [] ^ _

Press **0** for Ä Ë Ö Ü À Ç È É 0

General setup

Ring Volume

You can choose a range of ring volume levels, from High to Off.

- 1 Press  or  to adjust the volume level. This setting will stay until you change it again.











Note

- If you choose Off,  will appear on the LCD.
- Even if you choose Off, the cordless handset will ring in the lowest volume level when you receive a transferred call.





Beeper Volume

When the beeper is on, the cordless handset will beep when you press a key.

- 1 Press **Menu/OK**.
- 2 Press  or  to choose **HS Settings**. Press **Menu/OK**.
- 3 Press  or  to choose **Setup Ringer**. Press **Menu/OK**.
- 4 Press  or  to choose **Beeper**. Press **Menu/OK**.
- 5 Press  or  to choose **On** or **Off**. Press **Menu/OK**.
- 6 Press .



Speaker Volume

You can choose a range of speaker volume levels, from High to Low.

- 1 Press .
- 2 Press  or . This setting will stay until you change it again.
- 3 Press .









Handset Volume

You can adjust the cordless handset volume any time you are talking on the telephone.

- 1 Press  or . This setting will stay until you change it again.

Ringer Pattern

You can choose a ring pattern from five signal (regular ring patterns) or two types of melodies.

- 1 Press **Menu/OK**.
- 2 Press  or  to choose **HS Settings**. Press **Menu/OK**.
- 3 Press  or  to choose **Setup Ringer**. Press **Menu/OK**.
- 4 Press  or  to choose **Ringer Pattern**. Press **Menu/OK**.
- 5 Press  or  to choose **Signal 1**, **Signal 2**, **Signal 3**, **Signal 4**, **Signal 5**, **Melody 1** or **Melody 2**. Press **Menu/OK**.
- 6 Press .

Melody name

Melody 1	My Grandfather's Clock
Melody 2	The Four Seasons Concerto No.1 "Spring"

Automatic Daylight Savings Time (For Europe)

You can set the cordless handset to change automatically for daylight savings time. It will reset itself forward one hour in the Spring and backward one hour in the Autumn. Make sure you have set the correct date and time in the **Date&Time** setting.

- 1 Press **Menu/OK**.
- 2 Press **▲** or **▼** to choose **HS Settings**. Press **Menu/OK**.
- 3 Press **▲** or **▼** to choose **Auto Daylight**. Press **Menu/OK**.
- 4 Press **▲** or **▼** to choose **On** or **Off**. Press **Menu/OK**.
- 5 Press .

Daylight Savings Time (For Asia and Oceania)

You can set the cordless handset to change for daylight savings time. It will reset itself forward one hour in the Spring and backward one hour in the Autumn. Make sure you have set the correct date and time in the **Date&Time** setting.

- 1 Press **Menu/OK**.
- 2 Press **▲** or **▼** to choose **HS Settings**. Press **Menu/OK**.
- 3 Press **▲** or **▼** to choose **Daylight Save**. Press **Menu/OK**.

- 4 Press **▲** or **▼** to choose **On** or **Off**. Press **Menu/OK**.

- 5 Press .

LCD Contrast

You can adjust the LCD contrast for a sharper and more vivid display. If you are having difficulty reading the LCD, try changing the contrast setting.

- 1 Press **Menu/OK**.
- 2 Press **▲** or **▼** to choose **HS Settings**. Press **Menu/OK**.
- 3 Press **▲** or **▼** to choose **LCD Contrast**. Press **Menu/OK**.
- 4 Press **◀** or **▶** to adjust the contrast. Press **Menu/OK**.
- 5 Press .

Date and Time

The cordless handset displays the date and time.

- 1 Press **Menu/OK**.
- 2 Press **▲** or **▼** to choose **HS Settings**. Press **Menu/OK**.
- 3 Press **▲** or **▼** to choose **Date&Time**. Press **Menu/OK**.
- 4 Enter the two digits for the day on the dial pad.
(e.g. Enter **0 1** for the first of the month.)
- 5 Enter the two digits for the month on the dial pad.
(e.g. Enter **0 3** for March.)
- 6 Enter the last two digits of the year on the dial pad.
Press **Menu/OK**.
(e.g. Enter **0 8** for 2008.)

- 7 Enter the time in 24-hour format on the dial pad.
Press **Menu/OK**.
(e.g. Enter **1 5, 2 5** for 3:25 P.M.)
- 8 Press .

Choosing your language

You can change the LCD language.

- 1 Press **Menu/OK**.
- 2 Press **▲** or **▼** to choose **HS Settings**.
Press **Menu/OK**.
- 3 Press **▲** or **▼** to choose **Select Language**.
Press **Menu/OK**.
- 4 Press **▲** or **▼** to choose your language.
Press **Menu/OK**.
- 5 Press .

Echo Control

Under some conditions you may experience an echo when using the cordless handset. You can reduce or remove the echo by choosing a level in the echo control setting from the control panel of the machine (base unit). It will take a moment for the level setting to change. During this time you cannot answer a call.

- 1 Press **MENU** on the touchscreen of the machine (base unit).
- 2 Press **▲** or **▼** to display **General Setup**.
- 3 Press **General Setup**.
- 4 Press **▲** or **▼** to display **Echo Control**.
- 5 Press **Echo Control**.
- 6 Press **level1, level2, level3** or **level4**.
- 7 Press **Stop/Exit**.

Modify PIN

You can change the PIN number of the machine (base unit). The factory setting is 0000.

- 1 Press **Menu/OK**.
- 2 Press **▲** or **▼** to choose `Modify Pin`. Press **Menu/OK**.
- 3 Enter a 4-digit number for the current PIN number. Press **Menu/OK**.
- 4 Enter a 4-digit number for a new PIN number. Press **Menu/OK**. Press **1** to confirm.
- 5 Press .



Note

Make sure that you make a note of your new PIN number and keep it in a safe place. If you forget or lose your PIN number please call your Brother dealer for service.

Restoring all the settings to factory settings

You can reset all the settings you have changed to the factory settings, such as the phonebook memory, call history, Caller ID history and other settings.

- 1 Press **Menu/OK**.
- 2 Press **▲** or **▼** to choose `HS Settings`. Press **Menu/OK**.
- 3 Press **▲** or **▼** to choose `HS Default`. Press **Menu/OK**. Press **1** to confirm.

Troubleshooting

If you think there is a problem with your cordless handset, check the chart below and follow the troubleshooting tips.

Most problems can be easily resolved by yourself. If you need additional help, the Brother Solutions Center offers latest FAQs and troubleshooting tips. Visit us at <http://solutions.brother.com>.

If you are having difficulty with your cordless handset

Difficulties	Suggestions
The cordless handset does not operate.	Check that the battery is charged properly. (See <i>Charging the battery</i> on page 25.)
Dialling or receiving does not work.	Check phone line connection of the machine (base unit).
	Check that the machine (base unit) is plugged in. For dialling feature, check that the machine (base unit) is not in Power Save Mode.
	Check that the battery is charged properly. (See <i>Charging the battery</i> on page 25.)
	Move closer to the machine (base unit). The cordless handset may be too far away from the machine (base unit).
Bad phone line connection	If you have registered the handset to more than one machine (base unit), check that you have chosen the correct machine (base unit) from the handset menu. (See <i>Choosing Base unit</i> on page 14.)
	Make sure that there are no possible sources of radio interference between the machine (base unit) and the cordless handset.
	Move closer to the machine (base unit). The cordless handset may be too far away from the machine (base unit).
	During the conversation, try adjusting the angle of the antenna on the right of the machine (base unit) to improve reception.
The battery does not charge.	Move away from walls.
	Check that the battery is installed properly in the cordless handset. (See <i>Replacing the battery</i> on page 26.)
	Check that the cordless handset is placed properly in the cradle and LED turns green. (See <i>Charging the battery</i> on page 25.)
The battery performance is still poor after recharging.	Clean the charge contacts for both cordless handset and the cradle. (See <i>Cleaning</i> on page 26.)
	It is time to replace the battery. (See <i>Replacing the battery</i> on page 26.)
The cordless handset beeps during a call.	Move closer to the machine (base unit). The cordless handset may be too far away from the machine (base unit).
	Your battery may be discharged. If you want to continue the call, transfer the call to the machine (base unit) and use the Speaker Phone key to answer. (See <i>Transferring a call at the end of a conversation</i> on page 12.) Charge the battery. (See <i>Charging the battery</i> on page 25.)

Difficulties	Suggestions
You cannot make an internal call.	The cordless handset or the machine (base unit) you want to call to may be making an internal call or an outside call. Wait until the line is free.
	If you have more than one machine (base unit), check that your handset is registered to the correct machine (base unit).
	Make sure that the machine (base unit) is not in Power Save condition. Then press  on the cordless handset to go back to standby mode.
You cannot register an optional cordless handset.	Check that both the cordless handset and the machine (base unit) are in standby mode.

Error messages

As with any sophisticated office product, errors may occur. If this happens, your cordless handset identifies the error and shows an error message. The most common error messages are shown below.

You can correct most errors by yourself. If you need more help, the Brother Solutions Center offers latest FAQs and troubleshooting tips.

Visit us at <http://solutions.brother.com>.

Error Message	Cause	Action
Base Unit in use	The machine (base unit) is being used for intercom calling.	Wait until the line is free.
	The machine (base unit) is being set up for cordless handset registration.	Wait until the registration is finished.
	The machine (base unit) is being used for TAD functions such as OGM recording or ICM playing.	Wait until machine (base unit) is back in standby mode.
Cannot register handset	Handset registering was unsuccessful.	Try to register the cordless handset again. (See <i>Registering cordless handsets</i> on page 3.)
Line in use	Another person is on the phone with machine's (base unit) speaker phone or other cordless handset.	Wait until the line is free.
	The machine (base unit) is receiving faxes.	Wait until the line is free.
Low Battery Put handset on cradle	The battery of the cordless handset is discharged.	Charge the battery. (See <i>Charging the battery</i> on page 25.)
No Caller ID	There is no incoming call history. You have not received any calls, you have not activated the Caller ID feature on your machine (base unit), or you have not subscribed to the Caller ID service from your telephone company.	If you want to use the Caller ID feature call your telephone company. (See <i>Caller ID</i> in the User's Guide.)

Error Message	Cause	Action
Power Off	The machine (base unit) is in Power Save mode.	If you want to make a phone call, press the Power Save key on your machine (base unit) to bring your machine out of Power Save mode. Then press  on the cordless handset to go back to standby mode.
Searching for Base Unit (Base Unit not detected)	The cordless handset is too far away from the machine (base unit).	Move the cordless handset closer to the machine (base unit).
	Your machine (base unit) is not plugged in.	Make sure that the machine (base unit) is plugged in.
	You have not registered the cordless handset.	Register the cordless handset. (See <i>Registering cordless handsets</i> on page 3.)
	The antenna on the right of the machine (base unit) is in the down position.	Make sure the antenna is in the up position.

Routine maintenance

Charging the battery

If the battery charge level is getting low, you should charge the battery. You can see the battery charge level indicator at the bottom right of the LCD.

- 1 Make sure the AC adapter of the cradle or the machine (base unit) is connected to an electrical socket.

- 2 Place the cordless handset in the cradle with the dial pad facing forward.

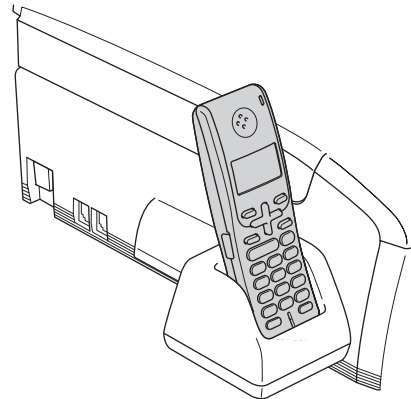

Cleaning

Clean the outside of the cordless handset with a soft cloth. You should also clean the charge contacts once a month. If the charge contacts are not clean, the battery may not charge properly.

! CAUTION

Use neutral detergents. Cleaning with volatile liquids such as thinner or benzene will damage the outside surface of the cordless handset.

DO NOT use cleaning materials that contain ammonia.

DO NOT use isopropyl alcohol to remove dirt from the control panel. It may crack the panel.

Clean the charge contacts as follows:

- 1 Unplug the cradle from the electrical socket.
- 2 Clean the charge contacts (1) for both the cordless handset and the cradle with a cotton swab.

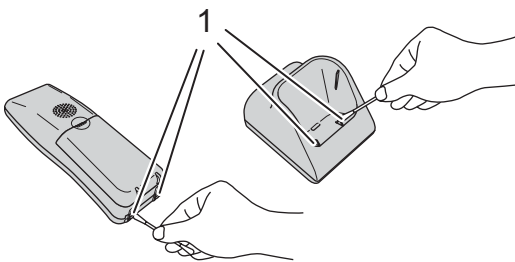

Replacing the battery

If the battery charge level indicator empties very quickly after recharging, make sure that you have charged the battery correctly. If the battery performance is still poor, it is time to replace it.

! WARNING

Use a genuine Brother rechargeable battery (BCL-BT20). If not, it may cause damage or personal injury.

! CAUTION

DO NOT take off the white plastic that covers the battery.

- 1 Press the area indicated (1) on the battery cover (2) and slide it off the cordless handset.

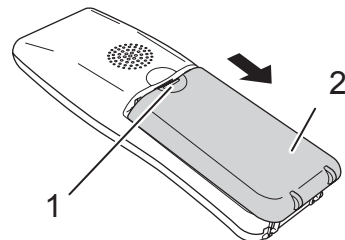

- 2 Remove the old battery and pull out the connector.
- 3 Insert the connector (1) of the new battery (2) in the direction shown below.

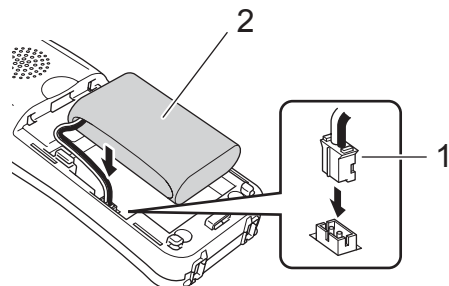

- 4 Place the battery in the position shown.

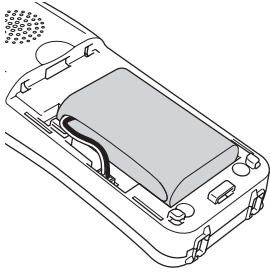

- 5 Install the battery cover by sliding it onto the back of the handset.

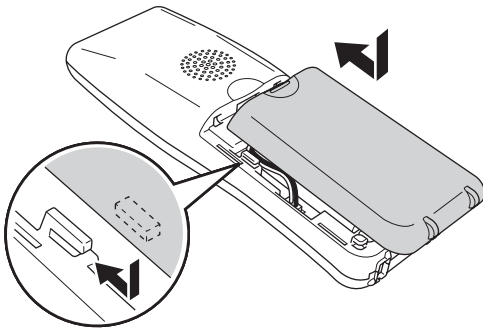

Note

- After battery replacement, you should set the date and time.
(See *Date and Time* on page 20.)
- Be sure to dispose of the expired battery as directed by local regulations for the disposal of nickel metal hydride battery.

5

Specifications

General

Cordless handset

Frequency	1.9 GHz
Standard	DECT™
Multi Handset Capability	Up to 4 handsets
Dimensions	

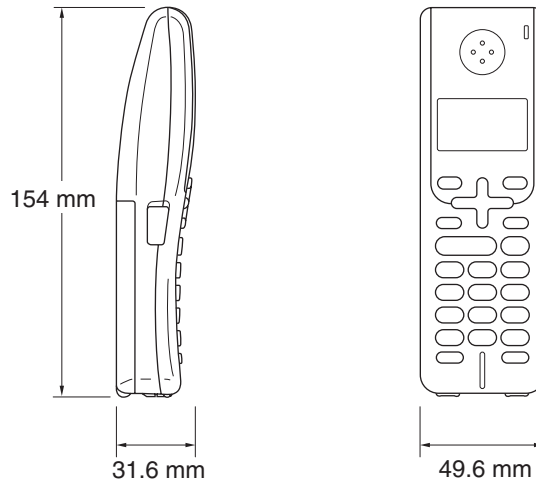

Weight (including battery)	149 g
LCD (liquid crystal display)	16-Digit, 3-Line (+1-Line for Pict), Backlit (Orange)
Charge Indicator	Yes (LED)
Full Charge Time	12 hours
While in Use (TALK)	10 hours
While Not in Use (Standby)	200 hours

Battery

Type	BCL-BT20
Rating	Ni-MH 3.6 V 730 mAh

Battery charger cradle

Dimensions

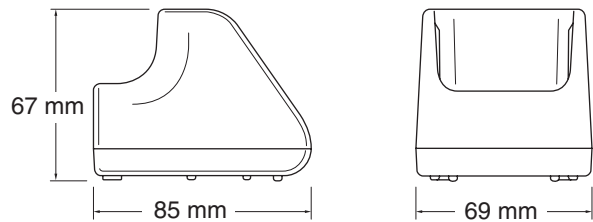

Weight	71.6 g
Power Consumption (during charge)	Charging: Average 2 W

AC adapter

Type	BCL-ADB (For U.K., Singapore, Hong Kong and Malaysia) BCL-ADOCE (For Australia and New Zealand) BCL-ADC (For others)
Input	AC 220 to 240 V 50/60 Hz
Output	DC 11.0 V

Basic Features

Tel-Index	Up to 100 numbers with names
Redial	Yes
Melody ringer patterns	Yes (2 melodies, 5 signals)
2 Way Intercom	Handset-to-Handset and Handset-to-Base Unit
Talk Time display	Yes

6

Index

B	
<hr/>	
Battery	
charging	25
installing	2
replacing	26
C	
<hr/>	
Cleaning	26
Control panel overview	6
D	
<hr/>	
Date and time	20
Daylight saving time	20
Dialling	
call history/redial	9
caller ID history	9
pause	10
phonebook	9
E	
<hr/>	
Error messages on LCD	24
H	
<hr/>	
Handset default	22
HELP	
LCD messages	15
using menu keys	15
menu table	15
L	
<hr/>	
LCD (liquid crystal display)	7, 15
changing language	21
contrast	20
M	
<hr/>	
Maintenance, routine	25
Memory storage	15
Menu table	16
P	
<hr/>	
Phonebook	
changing	11
deleting	12
storing	10
from call history	11
from caller ID history	11
PIN	
entering	3, 22
modifying	22
Programming your cordless handset	15
R	
<hr/>	
Registering	3
Ringer pattern	19
S	
<hr/>	
Safety instructions	5
T	
<hr/>	
Telephone	8
caller ID history	9
choosing base unit	14
hold	9
intercom	1, 13
mute	9
three-way conference call	1, 13
transferring	12
Text, entering	18
special characters	18
Troubleshooting	23
error messages on LCD	24
if you are having difficulty	23
V	
<hr/>	
Volume, setting	
beeper	19
handset	19
ring	19
speaker	19

EU Directive 2002/96/EC and EN50419



European Union only

This equipment is marked with the above recycling symbol. It means that at the end of the life of the equipment you must dispose of it separately at an appropriate collection point and not place it in the normal domestic unsorted waste stream. This will benefit the environment for all.
(European Union only)

EU Directive 2006/66/EC and EN61429



The battery is marked with the above recycling symbol. It means that at the end of the life of the battery, you must dispose of it separately at an appropriate collection point, and not place it in the normal domestic unsorted waste stream. This will benefit the environment for all.

Trademark

The Brother logo is a registered trademark of Brother Industries, Ltd.

Brother is a registered trademark of Brother Industries, Ltd.

DECT is a trademark of ETSI.

© 2008 Brother Industries, Ltd. All rights reserved.

All other brand and product names mentioned in this User's Guide are registered trademarks of their respective companies.

brother®

Visit us on the World Wide Web
<http://www.brother.com>

This machine is approved for use in the country of purchase only. Local Brother companies or their dealers will only support machines purchased in their own countries.

Free Manuals Download Website

<http://myh66.com>

<http://usermanuals.us>

<http://www.somanuals.com>

<http://www.4manuals.cc>

<http://www.manual-lib.com>

<http://www.404manual.com>

<http://www.luxmanual.com>

<http://aubethermostatmanual.com>

Golf course search by state

<http://golfingnear.com>

Email search by domain

<http://emailbydomain.com>

Auto manuals search

<http://auto.somanuals.com>

TV manuals search

<http://tv.somanuals.com>