

MMAC-Plus™ 9A000, SFCS-200BX,  
SFCS-200WG and SFCS-1000  
ATM SWITCH  
User's Guide

**CABLETRON**  
*SYSTEMS*  
The Complete Networking Solution™



## Notice

Cabletron Systems reserves the right to make changes in specifications and other information contained in this document without prior notice. The reader should in all cases consult Cabletron Systems to determine whether any such changes have been made.

The hardware, firmware, or software described in this manual is subject to change without notice.

IN NO EVENT SHALL CABLETRON SYSTEMS BE LIABLE FOR ANY INCIDENTAL, INDIRECT, SPECIAL, OR CONSEQUENTIAL DAMAGES WHATSOEVER (INCLUDING BUT NOT LIMITED TO LOST PROFITS) ARISING OUT OF OR RELATED TO THIS MANUAL OR THE INFORMATION CONTAINED IN IT, EVEN IF CABLETRON SYSTEMS HAS BEEN ADVISED OF, KNOWN, OR SHOULD HAVE KNOWN, THE POSSIBILITY OF SUCH DAMAGES.

© Copyright April 1996 by:

Cabletron Systems, Inc.  
35 Industrial Way  
Rochester, NH 03867-0505

All Rights Reserved  
Printed in the United States of America

Order Number: 9031473-03

**LANVIEW** is a registered trademark of Cabletron Systems, Inc.  
**MMAC-Plus** is a trademark of Cabletron Systems, Inc.  
**CompuServe** is a registered trademark of CompuServe, Inc.

## FCC Notice

This device complies with Part 15 of the FCC rules. Operation is subject to the following two conditions: (1) this device may not cause harmful interference, and (2) this device must accept any interference received, including interference that may cause undesired operation.

**NOTE:** This equipment has been tested and found to comply with the limits for a Class A digital device, pursuant to Part 15 of the FCC rules. These limits are designed to provide reasonable protection against harmful interference when the equipment is operated in a commercial environment. This equipment uses, generates, and can radiate radio frequency energy and if not installed in accordance with the operator's manual, may cause harmful interference to radio communications. Operation of this equipment in a residential area is likely to cause interference in which case the user will be required to correct the interference at his own expense.

**WARNING:** Changes or modifications made to this device which are not expressly approved by the party responsible for compliance could void the user's authority to operate the equipment.

## VCCI Notice

This equipment is in the 1st Class Category (information equipment to be used in commercial and/or industrial areas) and conforms to the standards set by the Voluntary Control Council for Interference by Information Technology Equipment (VCCI) aimed at preventing radio interference in commercial and/or industrial areas.

Consequently, when used in a residential area or in an adjacent area thereto, radio interference may be caused to radios and TV receivers, etc.

Read the instructions for correct handling.

この装置は、第一種情報装置（商工業地域において使用されるべき情報装置）で商工業地域での電波障害防止を目的とした情報処理装置等電波障害自主規制協議会（VCCI）基準に適合しております。

従って、住宅地域またはその隣接した地域で使用すると、ラジオ、テレビジョン受信機等に受信障害を与えることがあります。

取扱説明書に従って正しい取り扱いをして下さい。

# Table of Contents

## Preface

Technical Support.....	vii
Typographical Styles.....	vii
Important Information Indicators .....	viii
Laser Warning.....	x
Safety Agency Compliance.....	xi
Safety Precautions.....	xi
Symbols .....	xi
Modifications to Equipment.....	xii
Placement of a Cabletron Systems Product .....	xii
Power Cord Connection.....	xii

## Chapter 1 Introduction

1.1 Overview of the ATM Standard .....	1-1
1.2 Hardware Description.....	1-2
1.2.1 Front Panel Description .....	1-4
1.2.2 9A000 and SFCS Series Hardware Configuration.....	1-4
1.2.3 9A000 and SFCS Series Switch Board .....	1-4
1.2.4 Switch Control Processor.....	1-5
1.2.5 9A000 and SFCS Series Network Modules .....	1-5
1.2.6 Environmental Information.....	1-5
1.2.7 Standards Compliance .....	1-7
1.2.8 Safety Compliance .....	1-7
1.2.9 Emissions Compliance .....	1-7
1.2.10 Electromagnetic Compatibility (EMC) .....	1-7
1.3 Software Description .....	1-7
1.3.1 Switch Control Software .....	1-7

## Chapter 2 Installing the 9A000

2.1 Installing the 9A000 .....	2-1
2.2 The Reset Switch .....	2-3

## Chapter 3 Switch Hardware

3.2 Switch Hardware Components.....	3-5
3.2.1 Switch Board.....	3-5
3.2.2 Switch Control Processor.....	3-5
3.2.2.1 i960 Switch Control Processor .....	3-6
3.2.3 Network Modules.....	3-9
3.2.3.1 Port Numbering.....	3-9
3.2.4 Power Supply Modules.....	3-11
3.2.4.1 SFCS-200BX AC Power Supply .....	3-11

3.2.4.2	SFCS-1000 AC Power Supply (Model A).....	3-12
3.2.4.3	SFCS-1000 AC Power Supply (Model B).....	3-15
3.2.5	SFCS-1000 Fan Tray .....	3-18
3.2.6	SFCS-1000 Temperature Sensing.....	3-18
3.2.7	SFCS-1000 Common Equipment Card (CEC).....	3-19
3.2.7.1	CEC Front Panel.....	3-19
3.2.7.2	Alarm Relay Contacts.....	3-19
3.2.7.3	CEC Status LEDs.....	3-21
3.2.7.4	Ethernet Port.....	3-22

## Chapter 4 Switch Setup

4.2	Unpacking .....	4-1
4.2.1	Inventorying the Unit.....	4-2
4.3	Electrical Considerations.....	4-3
4.4	Rack-Mounting an SFCS-200BX.....	4-4
4.4.1	Required Tools.....	4-4
4.4.2	Installing the Rack-mount Brackets.....	4-5
4.5	Rack-Mounting an SFCS-200WG.....	4-7
4.5.1	Required Tools.....	4-7
4.5.2	Installing the Rack-mount Brackets.....	4-8
4.6	Rack-Mounting an SFCS-1000.....	4-10
4.6.1	Installing the SFCS-1000.....	4-11
4.7	Installing the Serial Cable .....	4-12
4.8	Modem Configuration.....	4-13
4.8.1	Modem Parameters.....	4-13
4.9	Configuring IP Addresses.....	4-14
4.10	AMI Security .....	4-15
4.11	Subsequent Operation .....	4-15
4.12	Verifying the Installation.....	4-16
4.13	Product Registration Information.....	4-16

## Chapter 5 Hardware Maintenance Procedures

5.1.1	Overview .....	5-1
5.1.2	Multicast Mode.....	5-2
5.1.3	Hot-swapping Network Modules .....	5-3
5.2	Power Supply Module Replacement.....	5-4
5.2.1	SFCS-200BX Power Supply Module Replacement.....	5-4
5.2.1.1	Replacing an SFCS-200BX AC Power Supply.....	5-4
5.2.2	SFCS-1000 Power Supply Module Replacement.....	5-6
5.2.2.1	Replacing an SFCS-1000 AC Power Supply (Model A).....	5-6
5.2.2.2	Replacing an SFCS-1000 AC Power Supply (Model B) .....	5-9
5.3	SFCS-1000 Fan Tray Replacement.....	5-12
5.4	Switch Control Processor Replacement .....	5-13
5.5	Switch Board Replacement .....	5-15

## Chapter 6 Software Upgrade Instructions

6.1	Obtaining the Software Upgrade File via Diskette .....	6-2
6.2	Performing the Software Upgrade .....	6-4
6.3	Changing between Multiple Versions of Software.....	6-7
6.4	Using bootp to Download Software to the Switch.....	6-9
6.4.1	Overview.....	6-9
6.4.2	Setting Up Your bootp Server .....	6-9
6.4.3	Adding an Entry for Your Switch in the bootptab File.....	6-10
6.4.4	Setting Up a tftpboot Server.....	6-12

## Appendix A Troubleshooting

A.1.1	Run Looptest .....	A-3
A.1.2	Check Self-Test (Automatically Performed) .....	A-4
A.1.3	Firmware Download (Automatically Performed) .....	A-4
A.1.4	Hardware Detected by Driver .....	A-5
A.1.5	Check Firmware.....	A-6
A.1.6	Check Physical Link .....	A-7
A.2	Testing Network Connectivity Using PVCs.....	A-8
A.2.1	Verifying the Outgoing ATM ARP Entry.....	A-11
A.2.2	atmstat .....	A-12
A.2.2.1	No Cells Received by Remote End .....	A-13
A.2.2.2	Cells and VPI/VCI Errors Received by Remote .....	A-13
A.2.2.3	Cells and AAL* Errors Received by Remote .....	A-13
A.2.2.4	Cells and No Errors Received by Remote and Transmitting No Cells .....	A-14
A.2.2.5	Cells and No Errors Received by Remote and Transmitting Cells A-14	A-14
A.3	Collecting Additional Information.....	A-15
A.3.1	Basic Information.....	A-15
A.3.2	Adapter Information .....	A-15
A.3.3	Switch Information.....	A-18

## Appendix B SCP Diagnostics

B.1.1	Accessing the Monitor Mode.....	B-2
B.1.2	Running the Hardware Tests .....	B-4
B.1.2.1	Clock Test .....	B-4
B.1.2.2	DRAM Test .....	B-4
B.1.2.3	DRAM Chip Test .....	B-5
B.1.2.4	Ethernet Test.....	B-5
B.1.2.5	FLASH Test .....	B-5
B.1.2.6	FLASH Chip Test.....	B-6
B.1.2.7	Serial Port Test .....	B-7
B.1.2.8	SRAM Test .....	B-7
B.1.2.9	Timer Test .....	B-7
B.1.2.10	Hardware Test.....	B-7
B.1.2.11	Complete Hardware Test.....	B-8

## Appendix C Hardware Specifications

C.1.1	SFCS-200WG .....	C-2
C.1.2	SFCS-200BX .....	C-3
C.1.3	SFCS-1000 .....	C-4
C.2	ATM Network Modules.....	C-5
C.2.1	100 Mbps TAXI Module .....	C-5
C.2.2	155 Mbps OC-3c/STM-1 MM Module .....	C-6
C.2.3	155 Mbps STS-3c/STM-1 UTP Module.....	C-7
C.2.3.1	155 Mbps UTP Pinout Specifications .....	C-8
C.2.3.2	Connecting Switches with 155 Mbps UTP Network Modules	C-8
C.2.4	622 Mbps OC-12c/STM-4c MM Module .....	C-9
C.2.5	25 Mbps TP25 Module.....	C-10
C.2.5.1	Connecting Switches with TP25 Network Modules .....	C-11
C.2.5.2	Connecting Switches with Token Ring Pinouts to Cabletron Switches .....	C-11
C.2.5.3	Connecting Adapters with Token Ring Pinouts to Cabletron Switches .....	C-12
C.2.6	34 Mbps E3 Module .....	C-13
C.2.7	45 Mbps DS3 Module .....	C-14
C.2.8	155 Mbps OC-3c/STM-1 SM Module.....	C-15
C.2.9	155 Mbps OC-3c/STM-1 3MM/1SM Module.....	C-16
C.2.10	622 Mbps OC-12c/STM-4c SM Module.....	C-18
C.3	ATM Adapters.....	C-19
C.3.1	Adapter Cabling Specifications.....	C-19
C.3.1.1	Fiber-Optic Cable Specifications .....	C-19
C.3.1.2	UTP Cable Specifications .....	C-20
C.3.1.3	UTP Pinouts .....	C-20
C.3.2	ESA-200PC Technical Specifications.....	C-21
C.3.3	PCA-200PC Technical Specifications .....	C-22
C.3.4	PCA-200MAC Technical Specifications .....	C-23
C.3.5	NBA-200 Technical Specifications.....	C-24
C.3.6	GIA-200 Technical Specifications .....	C-25
C.3.7	HPA-200 Technical Specifications .....	C-26
C.3.8	MCA-200 Technical Specifications.....	C-27
C.3.9	SBA-200 Technical Specifications.....	C-28
C.3.10	ESA-200 Technical Specifications .....	C-29
C.3.11	VMA-200 Technical Specifications .....	C-30



## PREFACE

This manual provides technical information needed to install and operate the *Cabletron*<sup>TM</sup> 9A000 and SecureFast Cell Switch-200BX ATM Switches. It provides information for the 9A000 and SFCS-200BX switches and the user-installable network modules offering both LAN and WAN interfaces. This document also provides safety instructions, general product information, network configuration information and information on software administration capabilities.

## Technical Support

---

In the U.S.A., you can contact Cabletron Systems' Technical Support by any one of four methods:

By phone: Monday through Friday between 8 A.M. and 8 P.M. Eastern Standard Time at (603) 332-9400

By CompuServe<sup>®</sup>: GO CTRON from any ! prompt

By Internet mail: support@ctron.com

By mail: Cabletron Systems, Inc.  
P.O. Box 5005  
Rochester, NH 03867-0505

By FAX: (603) 335-4743

Technical support for non-U.S.A. customers should be handled through your local distributor.

No matter which method is used for technical support, please be prepared to provide your support contract ID number, the serial number(s) of the product(s), and as much information as possible describing your problem/question.

## Typographical Styles

---

Throughout this manual, all specific commands meant to be entered by the user will appear on a separate line in bold **Avant Garde** typeface. In addition, use of the Enter or Return key will be represented as <ENTER>. The following example demonstrates this convention.

```
cd /usr <ENTER>
```

Commands or file names that appear within the text of this manual will be represented in the following style: "...the `fore_install` program will install this distribution".

As in the following example, any messages that appear on your screen during software installation and network interface administration will appear in Courier font to distinguish them from the rest of the text.

```
.... Are all four conditions true?
```

## Important Information Indicators

---

To call your attention to safety and otherwise important information that must be reviewed to insure correct and complete installation, as well as to avoid damage to the *ForeRunner* Switch or your system, Cabletron Systems utilizes the following *WARNING/CAUTION/NOTE* indicators.

**WARNING** statements contain information that is critical to the safety of the operator and/or the system. Do not proceed beyond a **WARNING** statement until the indicated conditions are fully understood or met. This information could prevent serious injury to the operator, damage to the *ForeRunner* Switch, the system, or currently loaded software, and will be indicated as follows:

**WARNING!** Hazardous voltages are present. If the instructions are not heeded, there is a risk of electrical shock and danger to personal health.



Information contained in **CAUTION** statements is important for proper installation/operation. **CAUTION** statements can prevent possible equipment damage and/or loss of data and will be indicated as:

**CAUTION** You risk damaging your equipment and/or software if you do not follow these instructions.



Information contained in **NOTE** statements has been found important enough to be called to the special attention of the operator and will be set off from the text as follows:

**NOTE:** Cabletron Systems strongly recommends that you disconnect the serial cable once you have configured the ATM switch and then access the switch over the ATM network.

## Laser Warning

---

**Class 1 Laser Product:  
This product conforms to  
applicable requirements of  
21 CFR 1040 at the date of  
manufacture.**

Class 1 lasers are defined as products which do not permit human access to laser radiation in excess of the accessible limits of Class 1 for applicable wavelengths and durations. These lasers are safe under reasonably foreseeable conditions of operation.

The following network modules contain Class 1 lasers:

NM-2/155SMSRA-1	NM-2/155SMSRB-1	NM-2OC3/SMSRA-1
NM-4/155SMSRA-1	NM-4/155SMSRB-1	NM-4OC3/SMSRA-1
NM-4OC3/SMSRA-1A	NM-4OC3/SMSRB-1	NM-2/155SMSRC
NM-4/155SMSRC	NM-2/155SMLRA-1	NM-2/155SMLRB-1
NM-2/155SMLRC-1	NM-2OC3/SMLRB-1	NM-2OC3/SMMRA-1
NM-4/155SMLRB-1	NM-4/155SMLRC-1	NM-4OC3/SMLRB-1
NM-4OC3/SMMRA-1	NM-1/622SMIRC	NM-4/155LR3SCC
NM-4/155SR3SCC		

## Safety Agency Compliance

---

This preface provides safety precautions to follow when installing a Cabletron Systems, Inc., product.

### Safety Precautions

For your protection, observe the following safety precautions when setting up your equipment:

- Follow all warnings and instructions marked on the equipment.
- Ensure that the voltage and frequency of your power source matches the voltage and frequency inscribed on the equipment's electrical rating label.
- Never push objects of any kind through openings in the equipment. Dangerous voltages may be present. Conductive foreign objects could produce a short circuit that could cause fire, electric shock, or damage to your equipment.

### Symbols

The following symbols appear in this book:

#### **WARNING!**



Hazardous voltages are present. If the instructions are not heeded, there is a risk of electrical shock and danger to personal health.

#### **CAUTION**



You risk damaging your equipment and/or software if you do not follow these instructions.

## Modifications to Equipment

Do not make mechanical or electrical modifications to the equipment. Cabletron Systems, Inc., is not responsible for regulatory compliance of a modified product.

## Placement of a Cabletron Systems Product

### CAUTION



To ensure reliable operation of your Cabletron Systems product and to protect it from overheating, openings in the equipment must not be blocked or covered. A Cabletron Systems product should never be placed near a radiator or heat register.

## Power Cord Connection

### WARNING!



Cabletron Systems products are designed to work with single-phase power systems having a grounded neutral conductor. To reduce the risk of electrical shock, do not plug Cabletron Systems products into any other type of power system. Contact your facilities manager or a qualified electrician if you are not sure what type of power is supplied to your building.

### WARNING!



Your Cabletron Systems product is shipped with a grounding type (3-wire) power cord. To reduce the risk of electric shock, always plug the cord into a grounded power outlet.

The *Cabletron 9A000 and SFCS series* ATM Switch brings ATM connectivity to LAN workgroup, LAN backbone, and LAN/WAN internetworking applications. Together with the *Cabletron* series of ATM Computer Interfaces, the 9A000 and SFCS series meet the networking demands of today's distributed, time-critical applications.

The *Cabletron 9A000 and SFCS series* ATM high-performance ATM switches deliver switching capacity and speed for ATM applications. A non-blocking switching capacity of 2.5 Gbps is continually available for connectivity to 16 users or networking devices, each running at speeds up to 622 Mbps or 24 users or network devices running at 100 Mbps.

This chapter provides an overview of the ATM Standard and Cabletron Systems *9A000 and SFCS series* Switches. It details the hardware and software requirements necessary to use the 9A000 and SFCS series and also provides information on the contents of the 9A000 and SFCS series Switch packages.

## 1.1 Overview of the ATM Standard

---

Asynchronous Transfer Mode, or ATM, is a communication architecture based on the switching of small fixed length packets of data called *cells*. In ATM, all data is transferred in 53-byte cells. Each cell has a 5-byte header that identifies the cell's route through the network and 48-bytes containing user data. This user data in turn carries any headers or trailers required by higher level protocols.

The operation of an ATM switch is conceptually quite simple. The header of each cell contains a virtual connection (VC) identifier, consisting of a virtual path identifier (VPI) and a virtual channel identifier (VCI). On each incoming link, an arriving cell's VC identifier uniquely determines a new VC identifier to be placed in the cell header, and the outgoing link over which to transmit the cell. In the case of a multicast connection, the VC identifier maps to a set of new VC identifiers and outgoing links.

Perhaps the single most important advantage offered by ATM, in addition to the speed at which data is transferred, is its open-ended growth path. ATM is not locked into a single physical medium or speed. The fixed-size ATM cell allows traffic from multiple sources (simultaneous video, audio, and data

communication) to be switched to multiple destinations by fast ATM switches such as the *Cabletron 9A000 and SFCS series* (connecting up to 64 workstations with an aggregate capacity of 2.5 Gbps or 96 workstations running at 100 Mbps). Larger LANs can be built by interconnecting multiple *9A000 and SFCS series* ATM switches.

Based upon international standards developed by the CCITT, ATM allows for fast packet switching of cells, 53 bytes in length. By using small cells to transfer data, coupled with a low latency switch supporting isochronous timing, ATM is able to support a wide range of audio, video, image, and data communications requirements.

Unlike shared-medium LAN technologies such as Ethernet and Token Ring, in which users must contend for bandwidth, ATM switching provides dedicated, deterministic, high-speed connectivity. In addition, ATM is scalable from 155 Mbps to 2.5 Gbps - to the desktop, or for the entire network.

## 1.2 Hardware Description

---

The *9Cabletron 9A000 and SFCS series* ATM switches, as shown in Figure 1-1 and Figure 1-2, provide connectivity for up to 16 computer workstations, hubs, or routers at rates operating up to 622 Mbps/sec (or 24 workstations running at 100 Mbps) via dedicated fiber optic links and twisted pair links.

Wide-area network (WAN) connectivity is seamlessly integrated into the *9A000 and SFCS series* for connection to private networks or ATM SONET, DS-3, DS-1, E-3, or J-2 services.

Interconnecting multiple *9A000 and SFCS series* switches at various speeds is simple. Once a new *9A000 and SFCS series* switch is added to the network, all other switches recognize its presence and dynamically establish connections to ports on the new switch. Furthermore, scaling the network is accomplished without costly and time consuming address reconfiguration and LAN segmentation.

The *9A000 and SFCS series* is a self-contained ATM switch that includes an Ethernet connection to provide network management access.



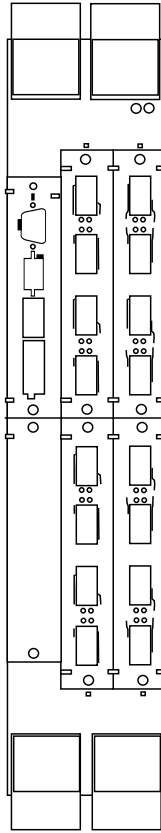

**Figure 1.1 - 9A000 Switch Configuration**

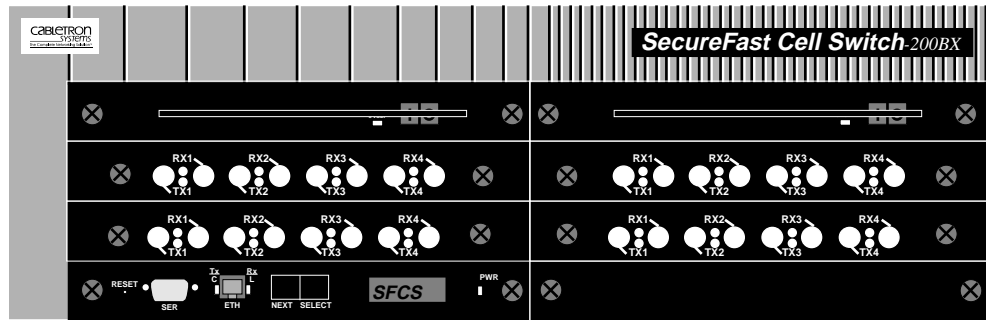

Figure 1.2 - SFCS-200BX Switch Configuration

### 1.2.1 Front Panel Description

The front panel of the 9A000 and SFCS series includes the following features: a power switch, two power supply LEDs, a RESET button, an RS-232 serial port, an Ethernet 10BaseT port, a NEXT pushbutton, a SELECT pushbutton, a display LED, and a power LED. For more information about these features, please refer to Appendix A of this manual.

### 1.2.2 9A000 and SFCS Series Hardware Configuration

The 9A000 and SFCS series hardware consists of a switch board, an i960 switch control processors, and network modules. These components work together to provide ATM switching capabilities, as well as distributed connection set-up and management. A functional description for each component follows.

### 1.2.3 9A000 and SFCS Series Switch Board

The 9A000 and SFCS series switch board contains the VPI/VCI lookup tables, and routing circuitry to ensure that a cell received from an input port is correctly switched to one or more output ports. The 9A000 and SFCS series switch board can accept up to four network modules, which themselves contain up to six ports each. The switch board also has an interface, controlled by the switch control processor, that is functionally equivalent to an ATM host interface. (See Switch Control Software for more information).

### 1.2.4 Switch Control Processor

The i960 switch control processor provides the distributed connection set-up for a network of ATM switches. The switch control processor primarily provides management access through SNMP and is responsible for storing and updating all SNMP management information. Additionally, the switch control processor can access the ATM switch in-band in very much the same manner as an ATM adapter in a workstation (such as the *Fore* SBA-200 SBus Adapter). Since it has the ability to communicate over IP, the 9A000 and SFCS series can route IP traffic from one given IP network to another. The switch control processor, and associated software, manages the behavior of the 9A000 and SFCS series switch board (i.e., connection setup), but is not involved in the actual cell switching.

### 1.2.5 9A000 and SFCS Series Network Modules

The network modules for the 9A000 and SFCS series act as the physical input/output ports to the 9A000 and SFCS series switch. A network module may have up to six physical ports, depending on its physical configuration.

There is also a logical control port located inside the SCP which is referred to in the switch software as the Control Port (CTL). This control port is a logical (not physical) location where cells that are directed to the SCP itself are sent. (See section 1.4.1 for more information.)

### 1.2.6 Environmental Information

In the 9A000 and SFCS series, there is a temperature sensor, located over the switch fabric area of the enclosure, which ensures that the internal cabinet temperature is not too high. This temperature is displayed on the Environmental Module LCD readout, within the MMAC Plus chassis. The power utilization for the 9A000 and SFCS series is also monitored and can be displayed on the Environmental Module.

**Table 1.1 - System Hardware and Environmental Specifications**

<b>Features</b>	<b>SFCS Series/9A000</b>
<b>Switching Fabric</b>	2.5 Gbps non-blocked
<b>Traffic Policing</b>	UNI 3.1 dual leaky bucket support
<b>Number of Ports</b>	up to 24 ports
<b>Switch Transit Delay</b>	< 10 microseconds
<b>Connection Setup Time</b>	< 10 milliseconds
<b>Maximum Port Speed</b>	622 Mbps (OC-12/STM-4)
<b>Power (nominal)</b>	90 - 270 VAC @ 47 - 63 Hz 2.2 amps maximum
<b>Dimensions</b>	H: 4.75" (12.1 cm) W: 17.5" (44.5 cm) D: 18" (45.7 cm)
<b>Weight</b>	43 lbs (19.5 kg)
<b>Operating Temperature</b>	5°C to 40°C up to 10,000 ft
<b>Operating Humidity</b>	10 to 90% RH
<b>Storage Temperature</b>	-40°C to 70°C up to 30,000 ft
<b>Storage Humidity</b>	5 to 95% RH

### 1.2.7 Standards Compliance

- ITU I.361 ATM Layer
- ATM Forum UNI 3.0

### 1.2.8 Safety Compliance

- US: UL 1950
- Canada: CSA 22.2 No. 950-M89
- Europe: EN 60950

### 1.2.9 Emissions Compliance

- FCC Part 15, Class A
- CISPR 22, Class A
- VCCI, Class 1

### 1.2.10 Electromagnetic Compatibility (EMC)

The following all comprise EN 50082-1:

- ESD Susceptibility: IEC 801-2, Level 3
- Radiated Susceptibility: IEC 801-3, Level 2
- Electrical Fast Transient Compatibility: IEC 801-4, Level 2

## 1.3 Software Description

---

The software for the 9A000 and SFCS series runs on a FLASH file system to accomplish switch and connection management, IP connectivity, and SNMP network management.

### 1.3.1 Switch Control Software

The Switch Control Software (SCS) is the “brains” of the 9A000 and SFCS series switches. The SCS controls the 9A000 and SFCS series switch board and handles connection set-up and tear-down duties. The SCS can also communicate with other Cabletron Systems switches using the SPANS NNI protocol to learn network topology and establish connections across multiple switches. In addition, there is an SNMP agent built into the SCS to allow SNMP management and control.



This chapter contains the procedures for installing the 9A000. The installation of the SFCS series is covered in Chapter 3.

## 2.1 Installing the 9A000

---

To install the Cabletron 9A000, follow the steps below:

1. Switch off the power supplies and remove all power from the MMAC-Plus chassis.
2. Remove the blank panels, covering the slots that the module is being mounted in. All other slots must be covered, if modules are not being installed, to ensure proper airflow and cooling.
3. Carefully remove the module from the shipping box. (Save the box and packing materials in the event the module must be reshipped.)
4. Attach one end of the ESD wrist strap packaged with the MMAC-Plus chassis to your wrist. Plug the other end into the ESD Wrist Strap Grounding receptacle in the lower right corner of the MMAC-Plus Chassis shown in Figure 2.1.
5. Remove the module from the plastic bag. Observe all precautions to prevent damage from Electrostatic Discharge (ESD).
6. Carefully examine the module, checking for damage. If any damage exists, DO NOT install the module. Contact Cabletron Systems Technical Support immediately.
7. The modules are installed into the chassis by sliding them into slots and locking down both the top and bottom plastic tabs, as shown in Figure 2.1. Take care that the module slides in straight and engages the backplane connectors properly. When installing the module, ensure that both circuit cards are between the card guides, as shown in Figure 2.1. Check both the upper and lower tracks of both cards.

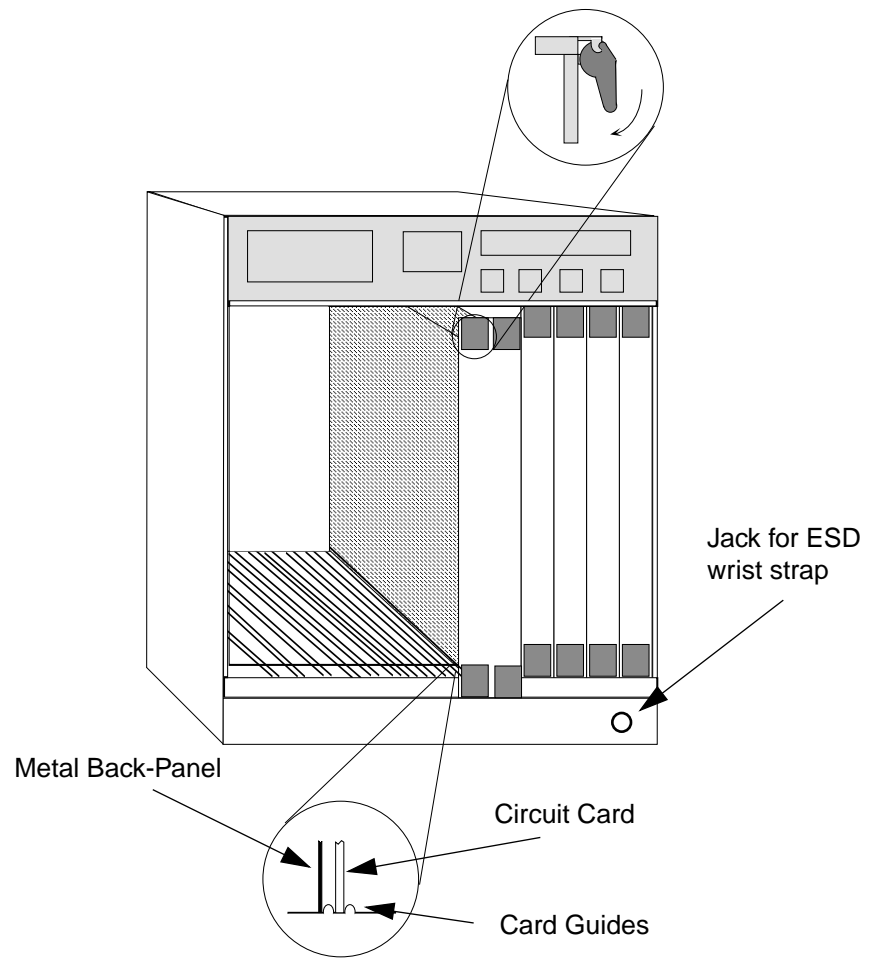

**Warning:**  
Ensure that the circuit card is between the card guides.  
Lock down the top and bottom plastic tabs  
at the same time, applying even pressure.

**Figure 2.1 - Installing the 9A000 Module**



## 2.2 The Reset Switch

The Reset switch is located on the rightmost front panel, under the top plastic tab as shown in Figure 2.2. It serves two functions:

- Pressing the reset switch twice within three seconds causes the processor (i960) to reset.
- Pressing and holding the switch on for three or more seconds causes the module to shutdown. Pressing and holding again for three seconds restarts the module.

SNMP management may be used to disable this switch to enhance module security.

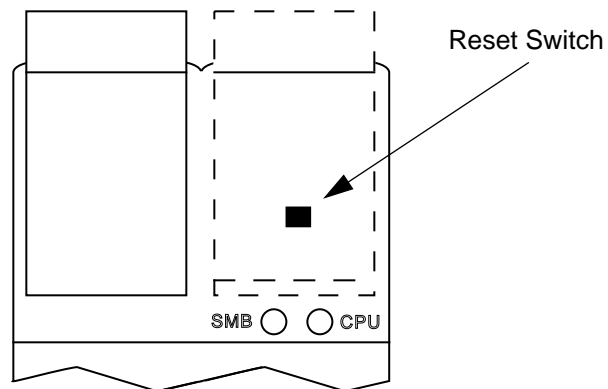

**Figure 2.2 - The Reset Switch**



Cabletron Systems offers a full line of ATM products that work together to provide a complete ATM network solution. The Cabletron SFCS-200WG ATM switch provide high-performance ATM connectivity for LAN workgroup and desktop applications. The SFCS-200BX ATM switch and the SFCS-1000 ATM switch offer high reliability and port density for LAN backbone and LAN/WAN internetworking applications. Together with the Cabletron series of ATM LAN and WAN Network Modules, these switches meet the networking demands of today's distributed, time-critical applications.

All of the Cabletron ATM switches deliver high-performance switching capacity and speed for ATM applications. A non-blocking switching capacity of 2.5 Gbps is continually available on the SFCS-200WG, and the SFCS-200BX. Each switch provides up to 4 ports of connectivity, each running at speeds up to 622 Mbps; or up to 16 ports, each running at speeds up to 155 Mbps; or up to 24 ports, each running at speeds up to 100 Mbps. The SFCS-1000 provides 10 Gbps of switching capacity for up to 16 ports of connectivity, each running at speeds up to 622 Mbps; or up to 64 ports, each running at speeds up to 155 Mbps; or up to 96 ports, each running at speeds up to 100 Mbps.

Wide-area network (WAN) connectivity is seamlessly integrated into the SFCS-200BX and the SFCS-1000 for connection to private networks or ATM SONET, DS3 and E3 services.

Interconnecting multiple Cabletron switches at various speeds is simple. Once a new Cabletron switch is added to the network, all other switches recognize its presence and dynamically establish connections to ports on the new switch. Furthermore, scaling the network is accomplished without costly and time consuming address reconfiguration and LAN segmentation.

This chapter provides an overview of the Cabletron Systems' family of ATM switches. It details the hardware requirements necessary to use these switches and also provides information on the contents of each of the switch packages.

### 3.1 Switch Hardware Configurations

The SFCS-200WG, as shown in Figure 3.1, is a self-contained ATM switch that provides an Ethernet connection for network management access. The SFCS-200WG ATM switch hardware consists of a single switch board with an i960 SCP, network modules, and fans. These components work together to provide ATM switching capabilities, as well as distributed connection setup and management.

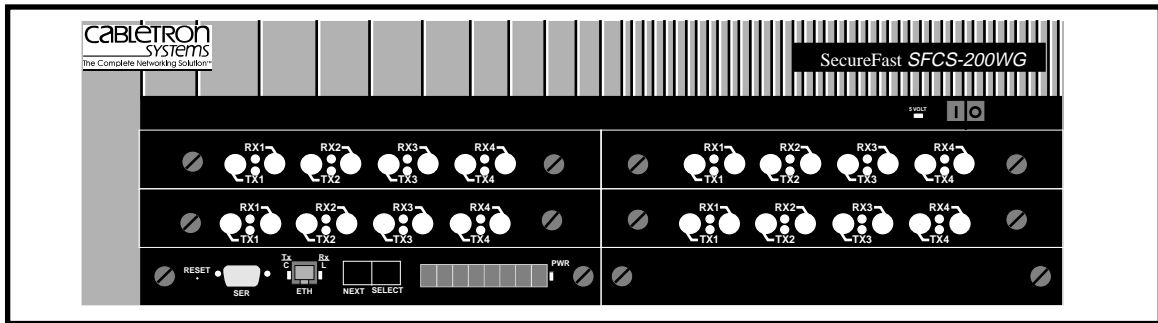
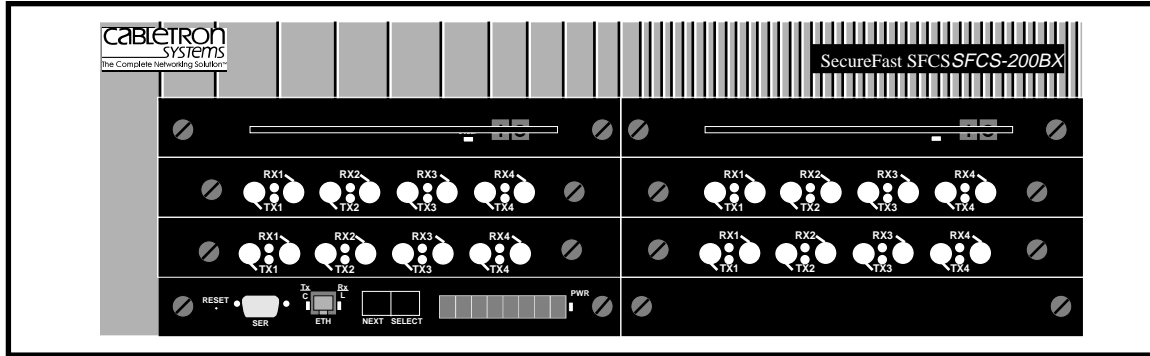

Figure 3.1 - SFCS-200WG Switch Configuration

The SFCS-200BX, as shown in Figure 3.2, is a self-contained ATM switch that provides an Ethernet connection for network management access. The SFCS-200BX hardware consists of a single switch board with an i960 SCP, network modules, redundant power supplies, and fans. These components work together to provide ATM switching capabilities, as well as distributed connection setup and management.



**Figure 3.2 - SFCS-200BX Switch Configuration**

The SFCS-1000, as shown in Figure 3.3, is a self-contained ATM switch that provides an Ethernet connection for network management access. The hardware for the SFCS-1000 consists of up to four switch boards, each with an i960 SCP; network modules; redundant power supplies; a Common Equipment Card (CEC); and a removable fan tray. These components work together to provide ATM switching capabilities, as well as distributed connection setup and management.

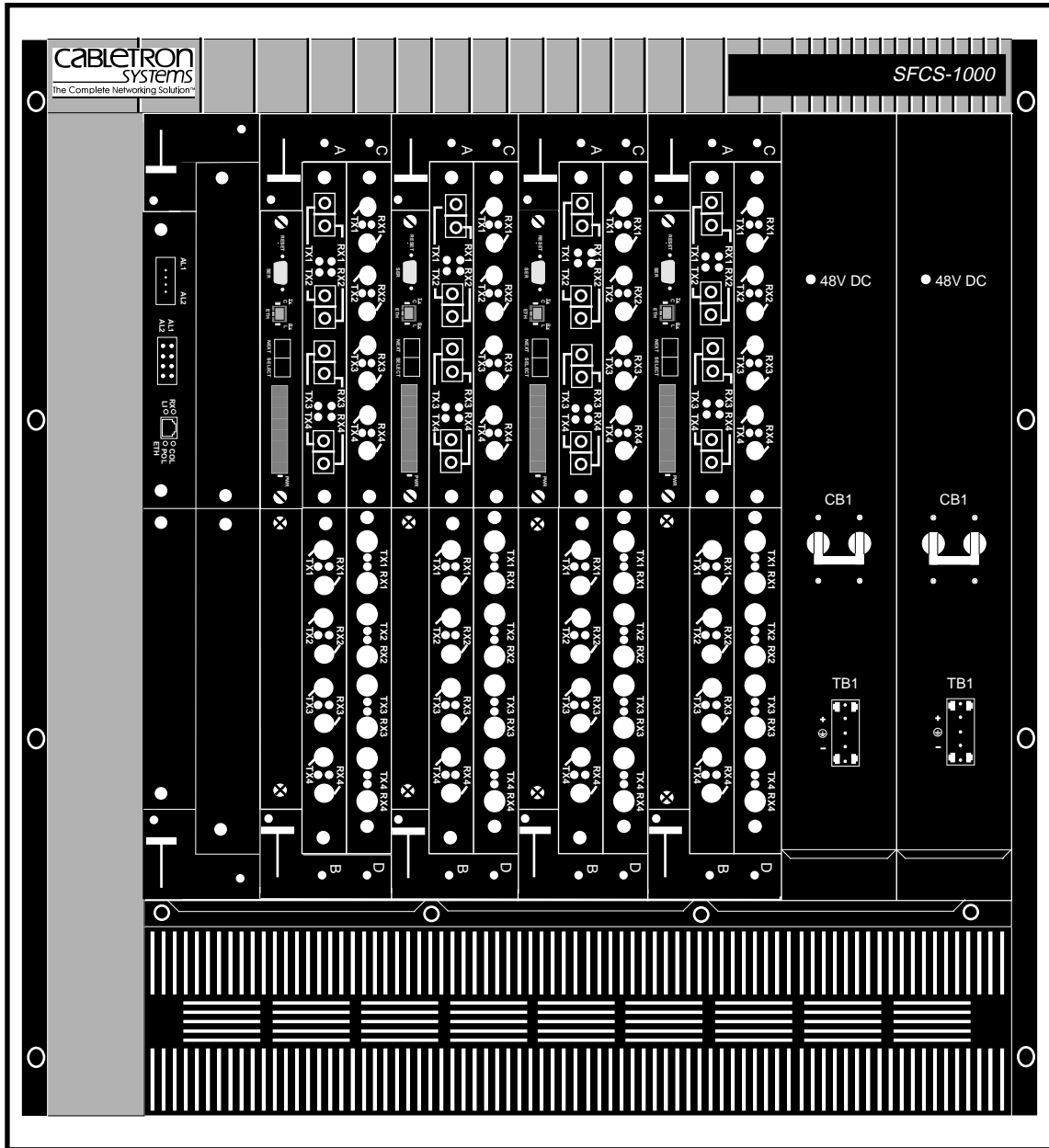

Figure 3.3 - SFCS-1000 Switch Configuration

## **3.2 Switch Hardware Components**

---

### **3.2.1 Switch Board**

The switch board (also referred to as the “switch fabric”) contains the VPI/VCI lookup tables and routing circuitry to ensure that a cell received from an input port is correctly switched to one or more output ports. The SFCS-200WG, and the SFCS-200BX each come with one switch board. The SFCS-1000 can be populated with as many as four switch boards. Each switch board can accept up to four network modules, which themselves can contain up to six ports each. The switch board also has an interface, controlled by the SCP, that is functionally equivalent to an ATM host interface.

### **3.2.2 Switch Control Processor**

The i960 SCP in the SFCS-200WG, SFCS-200BX, and the SFCS-1000 provide the distributed connection setup for a network of ATM switches. The SCP primarily provides management access through SNMP and is responsible for storing and updating all SNMP management information. Additionally, the SCP has direct access to the switch board. The SCP, and associated software, manages the behavior of the switch board (i.e., connection setup), but is not involved in the actual cell switching.

### 3.2.2.1 i960 Switch Control Processor

The front panel of an i960 SCP for the SFCS-200WG, SFCS-200BX, and the SFCS-1000 includes the following features: a RESET button, an RS-232 serial port, an Ethernet 10BaseT port, a NEXT pushbutton, a SELECT pushbutton, a display LED, and a power LED. All of the features are illustrated in Figure 3.4 and are described in detail in the subsections that follow.

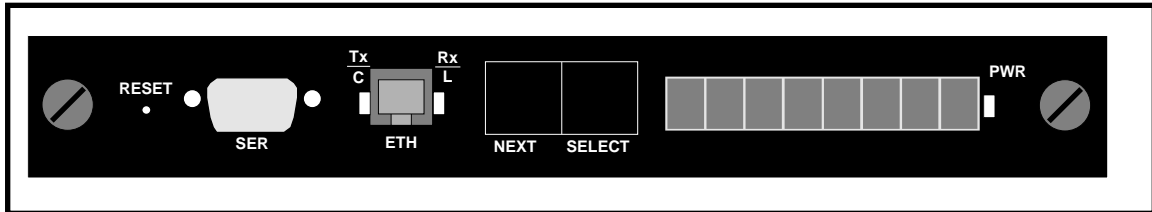

Figure 3.4 - i960 Switch Control Processor Front Panel

#### 3.2.2.1.1 RESET Button

The RESET button allows the user to reset the switch control software on the SCP. Using RESET “soft boots” the SCP and runs the initial power-on diagnostics. All open AMI sessions are ended by the SCP, and all ports lose any active sessions and initially go off-line after a reset. The ports then return to the configuration stored in the CDB. Because the RESET button is small (to avoid accidental resets), it is recommended that you use a straightened paper clip to push the RESET button.

#### 3.2.2.1.2 RS-232 Serial Port

The RS-232 serial port provides terminal access for any VT100 (or similar) terminal or terminal emulation package to the SCP. The serial port has a standard DB-9 female connector as shown in Figure 3.5.

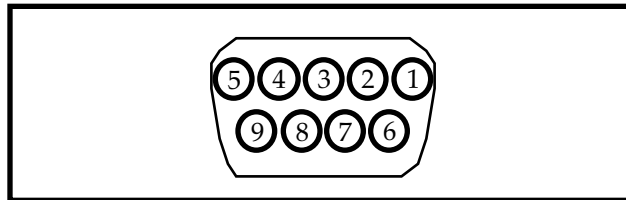

Figure 3.5 - RS-232 Serial Port Pinouts



Table 1.1 describes the RS-232 serial port pinouts that are illustrated in Figure 3.5.

**Table 3.1 - RS-232 Serial Port Pinouts**

Pin Number	Signal Mnemonic	Signal Name
1	DCD	Data Carrier Detect
2	RXD	Receive Data
3	TXD	Transmit Data
4	DTR	Data Terminal Ready
5	GND	Signal Ground
6	DSR	Data Set Ready
7	RTS	Request to Send
8	CTS	Clear to Send
9		Not Used

### 3.2.2.1.3 Ethernet 10BaseT Port

The Ethernet 10BaseT port on the front panel of the SCP has a standard RJ45 connector. There is a transmit LED to the left of this port and a receive LED to the right of this port. Tables 1.2 and 1.3 describe the states of the LEDs and their meanings.

**Table 3.2 - Ethernet 10BaseT Transmit LED Description**

LED Color	Meaning
red	There is a collision on the port.
green	The port is transmitting normally.

**Table 3.3 - Ethernet 10BaseT Receive LED Description**

LED Color	Meaning
red	The port is failing link integrity.
green	The port is receiving normally.

#### 3.2.2.1.4 CTL Port

A control port inside the SCP, referred to in the switch software as the CTL port, is a logical (not physical) location where cells that are directed to the SCP itself are sent. The CTL port has two roles, serving as both a host and a switch board controller. All signalling from the switch host and every attached host must interact with the switch board controller.

#### 3.2.2.1.5 NEXT Pushbutton

The NEXT pushbutton lets you scroll through the menu that is shown on the display LED after the power is turned on or after the SCP is reset/rebooted.

#### 3.2.2.1.6 SELECT Pushbutton

The SELECT pushbutton lets you choose an option from the menu that is shown on the display LED after the power is turned on or after the SCP is reset/rebooted.

#### 3.2.2.1.7 Display LED

During the boot process and the initial power-on diagnostics, the display LED shows messages about what is happening to the SCP. It is also used to show the menu choices for the NEXT and SELECT pushbuttons after the power is turned on or after the SCP is reset/rebooted. The choices shown on the display LED are as follows:

- Flash ?** When chosen, the SCP will attempt to boot from the FLASH file.
- Ethernet ?** When chosen, the SCP boots from the network.
- Monitor ?** When chosen, the user can connect a terminal to the serial port and run hardware self-diagnostics.
- Auto ?** When chosen, the SCP will attempt to boot from the FLASH. If this is unsuccessful, then the SCP will perform an Ethernet boot.

To access the modes listed above, press the NEXT pushbutton while the switch is booting until the mode you want to access is shown on the display LED. Then, press the SELECT pushbutton.

After the boot process and self-diagnostics are complete, the name of the SCP is shown in the display LED during normal operations, if an SCP name has been assigned. If an SCP name has not been assigned, it will display ATM SWITCH. For information on creating or modifying the SCP name, please refer to the section on configuring the SCP name in Appendix B, AMI Configuration Commands, in the Cabletron ATM Switch Configuration Manual.

### 3.2.2.1.8 Power LED

The power LED that is located to the right of the display LED on the front panel of the SCP reflects the current state of power to the SCP. Table 1.4 lists the states of the power LED and their meanings.

**Table 3.4 - Power LED Description**

LED Color	Meaning
red	The SCP has power, but has failed. (The individual SCP, not the entire switch, has not passed self-diagnostics.)
green	The SCP is powered up and is in good status.
off	There is no power to the SCP.

A power switch is located on the upper right-hand corner of the SFCS-200WG. When the power is turned on, the power LED, located to the right of the display LED, illuminates green and the initial power-on diagnostics are run. When the power is turned off, the power LED is extinguished.

## 3.2.3 Network Modules

The network modules in a Cabletron switch board act as the physical input/output ports to the switch board. A network module may have one, two, four, or six physical ports, depending on its configuration.

### 3.2.3.1 Port Numbering

The individual ports on a network module are numbered according to the Board-Network Module-Port (BNP) notation.

- Board** Refers to the number of the switch board that contains the port being numbered. "Board" is always 1 in an SFCS-200BX, or an SFCS-200WG, since these switches each contain only one switch board. "Board" can be 1, 2, 3, or 4 in an SFCS-1000, depending on the number of the physical switch board that contains the port being numbered.
- Network Module** Refers to the slot (A, B, C, or D) in the switch board that contains the port being numbered.
- Port** Refers to the physical port (1 - 6) being numbered on the individual network module.

For example, according to this notation, the fourth port on a network module in slot B of switch board #2 is port 2B4.

Figure 3.6 illustrates how the ports of various network modules, located in switch board #4 of an SFCS-1000, for example, would be numbered.

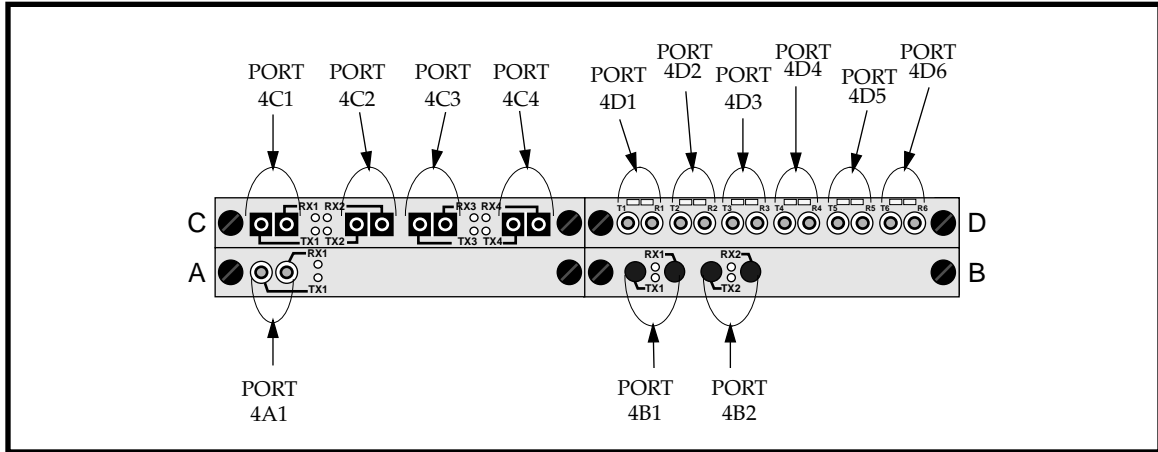

Figure 3.6 - Network Module Port Numbering

**NOTE:** For information about the technical and operating specifications for all of the Cabletron ATM network modules, see Appendix C, Hardware Specifications, in this manual.

### 3.2.4 Power Supply Modules

The SFCS-200BX and the SFCS-1000 each come with two removable power supply modules. In the event of a single power supply failure, the power supply indicator LED(s) on the front panel of the supplies will indicate the failed supply. The failed power supply can be removed and replaced while the other supply continues to provide power to the enclosure. In this manner, a single power supply failure will not cause the switch to stop functioning.

**WARNING!**



The SFCS-200WG comes with internal, non-removable power supplies. Attempting to remove these power supplies could result in serious injury or may cause permanent damage to the unit.

#### 3.2.4.1 SFCS-200BX AC Power Supply

The SFCS-200BX has two power supply LEDs, one for each removable, hot-swappable power supply. Each LED is located to the left of the power switch on the front panel for that supply. On the AC power supply for the SFCS-200BX, the LED is green under normal circumstances, indicating that the 5-volt supply coming from that particular power supply is functioning properly.

**CAUTION**



If the power supply LED is red, the faulty supply should be turned off as soon as possible, using the single power switch which controls power to that supply. The problem should then be diagnosed and repaired. Please refer to Chapter 3, Hardware Maintenance Procedures, for details about how to hot-swap a power supply in the SFCS-200BX.

**NOTE:** A replacement AC power supply will not function in a DC-equipped SFCS-200BX, and vice-versa. However, no damage will be done if this occurs.

### 3.2.4.2 SFCS-1000 AC Power Supply (Model A)

The model A AC power supply for an SFCS-1000 is shown in Figure 3.7.

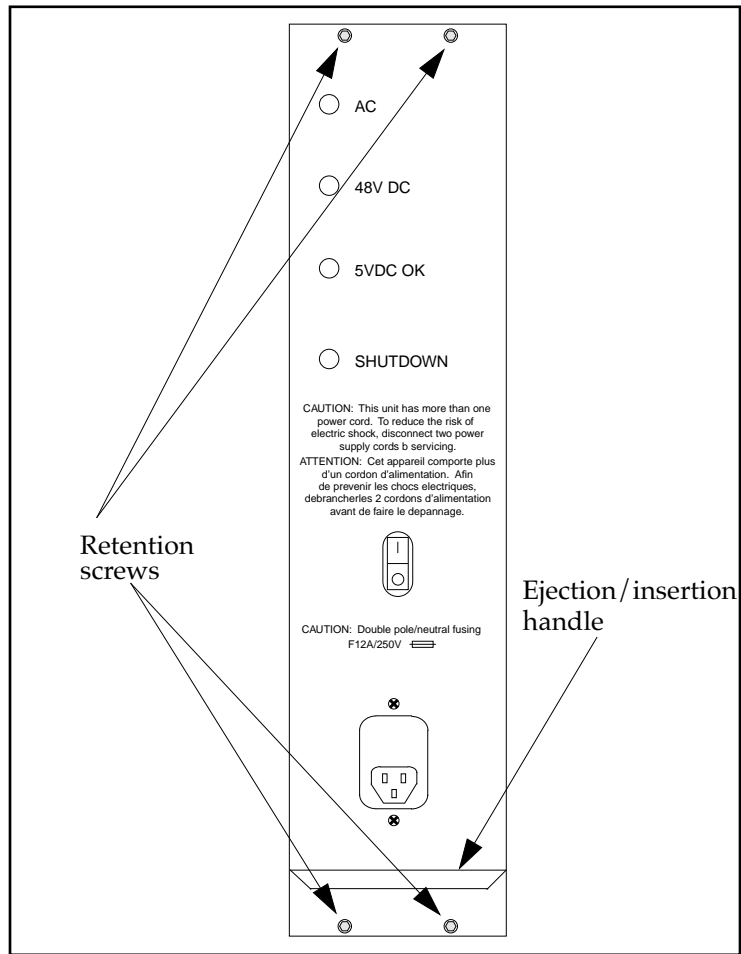

Figure 3.7 - Model A SFCS-1000 AC Power Supply

#### 3.2.4.2.1 Power Supply LEDs

There are four LEDs on the front panel of the model A SFCS-1000 AC power supply which indicate the status of the power supply. The LEDs and their functions are described in the following table:

**Table 3.5 - SFCS-1000 Power Supply LED Descriptions**

#### 3.2.4.2.2 Shutdown Conditions

To avoid damaging itself or the switch, the model B SFCS-1000 AC power supply shuts itself down under the following condition:

**Overload** The power supply is overloaded or the AC input is out of specification, and the supply voluntarily shuts down to avoid damage to the system.

**NOTE:** The SFCS-1000 CEC can not shut down the model A power supply. Only the power supply can shut itself down in an overload state.

If a model A power supply goes into shutdown, it will remain shut down until the power switch is turned off and turned on again (power cycle). The power switch must remain off long enough for the SHUTDOWN LED to extinguish (this allows the capacitors to discharge).

**WARNING!**

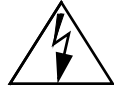

A replacement AC power supply should never be placed in an SFCS-1000 that already contains a DC power supply, and vice-versa. If these instructions are not heeded, there is a risk of electrical shock, danger to personal health, and serious damage to the equipment.

If the power supply needs to be replaced, please refer to Chapter 3, Hardware Maintenance Procedures, for hot-swap information.



### 3.2.4.3 SFCS-1000 AC Power Supply (Model B)

The model B AC power supply for an SFCS-1000 is shown in Figure 3.8.

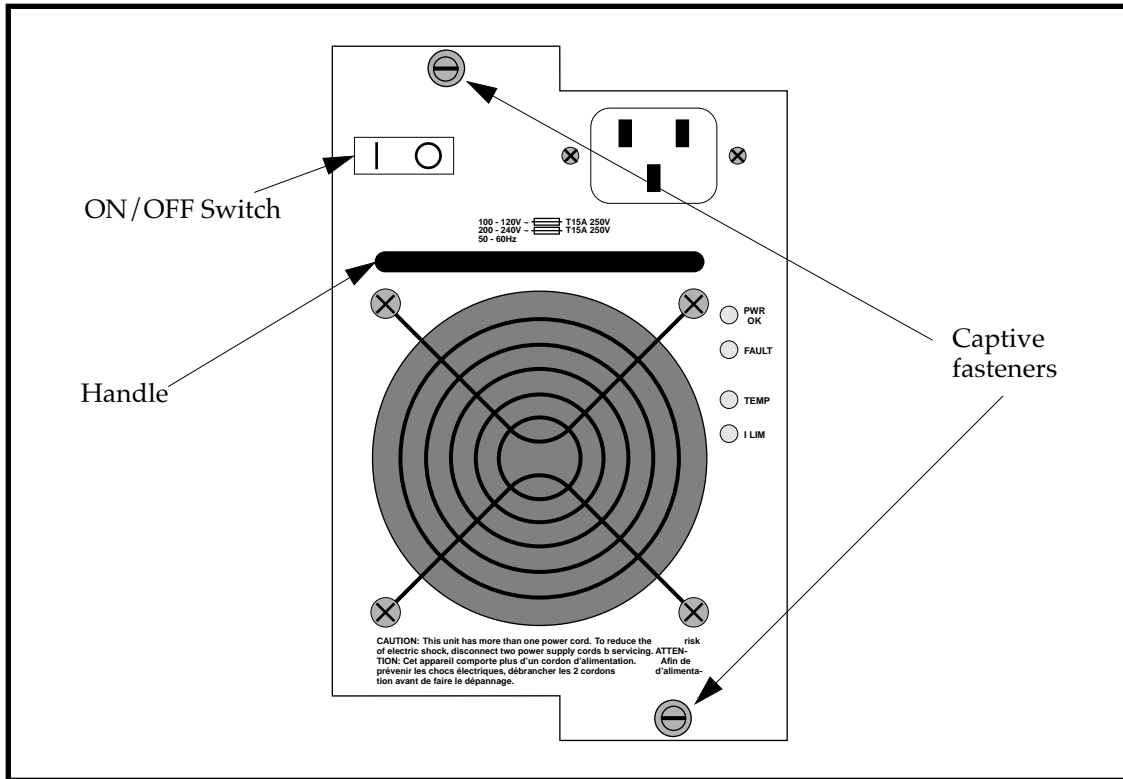

**Figure 3.8 - Model B SFCS-1000 AC Power Supply**

### 3.2.4.3.1 Power Supply LEDs

There are four LEDs on the front panel of the model B SFCS-1000 AC power supply which indicate the status of the power supply. The LEDs and their functions are described in the following table:

**Table 3.6 - SFCS-1000 Power Supply LED Descriptions**

### 3.2.4.3.2 Shutdown Conditions

To avoid damaging itself or the switch, the model B SFCS-1000 AC power supply shuts itself down under the following error conditions:

<b>Input undervoltage</b>	The AC line voltage is below $87 \pm 5$ VAC RMS.
<b>Output undervoltage</b>	Output 1 is $42 \pm 2$ VDC or Output 2 is below $4.5 \pm 0.25$ VDC. Shutdown from undervoltage is defeated during power-up period (2 seconds maximum) to allow slow-start.
<b>Output overvoltage</b>	The voltage at Output 1 or Output 2 is above $125\% \pm 8\%$ of the nominal voltage.
<b>Overtemperature</b>	Any power semiconductor has reached 90% of its maximum junction temperature.

**NOTE:** The SFCS-1000 CEC can not shut down the model B power supply. Only the power supply can shut down and restart itself.

If a model B power supply goes into shutdown, it remains turned off until the fault condition is rectified. At that point, the power supply restarts itself, except in the case of an overvoltage condition.

To recover from a shutdown caused by an overvoltage state, the AC line input must be turned off for at least one second.

**WARNING!**



A replacement AC power supply should never be placed in an SFCS-1000 that already contains a DC power supply, and vice-versa. If these instructions are not heeded, there is a risk of electrical shock, danger to personal health, and serious damage to the equipment.

If the power supply needs to be replaced, please refer to Chapter 3, Hardware Maintenance Procedures, for hot-swap information.

### 3.2.5 SFCS-1000 Fan Tray

The SFCS-1000 comes with a removable fan tray. The speed of each fan is monitored by circuitry in the CEC, and is available via SNMP. In this manner, the failure of any fan can be detected immediately. The fan tray is hot-swappable, and the entire tray may be replaced in the event of a single or multiple fan failure. Please refer to Chapter 3, Hardware Maintenance Procedures, for information about how to hot-swap a fan tray.

**NOTE:** The fans in the SFCS-200WG, and the SFCS-200BX are not removable.

### 3.2.6 SFCS-1000 Temperature Sensing

In the SFCS-1000, a built-in thermal temperature sensor resides on each switch board and reads out the board's local temperature. By default, the switch control software will trigger an alarm at 65°C and will reset the alarm when the temperature drops back down to 60°C. However, the user can configure these alarm and reset thresholds in the software on an individual board via AMI. Please refer to Appendix C, AMI Operation Commands, in the Cabletron ATM Switch Configuration Manual for more information about configuring these thresholds. If the temperature of an individual switch board were ever to reach 75°C, the switch board would shut itself down immediately.

### 3.2.7 SFCS-1000 Common Equipment Card (CEC)

The CEC provided with the SFCS-1000 performs several functions. Because each SCP contains an Ethernet port, a major function of the CEC is to provide a single, unified Ethernet port connection for all of the SCPs. The CEC is also responsible for monitoring the environmental conditions of the switch and reporting this information to the SCPs. The CEC reports conditions such as malfunctioning fans, overheated power supplies, and an overheated enclosure.

#### 3.2.7.1 CEC Front Panel

The front panel of the SFCS-1000 CEC includes the following features: alarm relay contacts, CEC status LEDs, and an Ethernet port with four LEDs. These features are illustrated in Figure 3.9. Refer to the following subsections for detailed descriptions of these features.

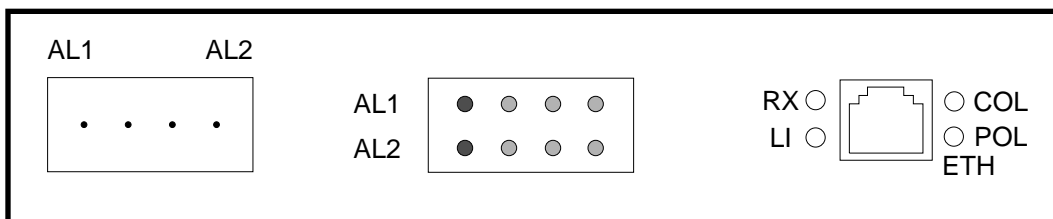

Figure 3.9 - CEC Front Panel Status Indicators

#### 3.2.7.2 Alarm Relay Contacts

Pins 1 and 2 are the contacts for AL1, and pins 3 and 4 are the contacts for AL2. Although the pins are not actually labeled on an SFCS-1000 CEC, they will be referred to as shown in Figure 3.10.

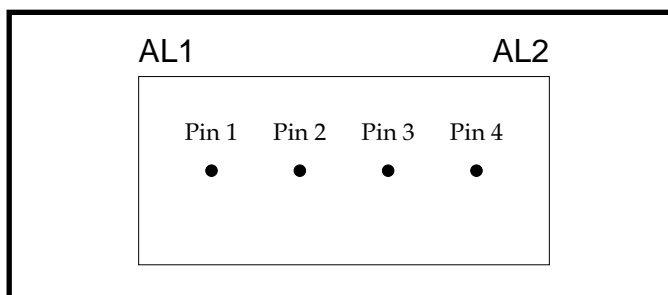

Figure 3.10 - Alarm Relay Contacts for AL1 and AL2

The alarm relay contacts are normally closed when there is no power to the switch. The user can attach alarm circuits to these contacts to trigger an external alarm in the case of an alarm condition on the switch.

The user can define AL1 and AL2 as major and minor alarm indicators and can display which condition is alarming through the use of AMI. For more information, please refer to the alarm configuration section in Appendix B, AMI Configuration Commands, in the Cabletron ATM Switch Configuration Manual.

**Table 3.7 - Alarm Relay Contact Status During Major and Minor Alarms**

<b>Condition</b>	<b>Pins 1 and 2</b>	<b>Pins 3 and 4</b>
Switch Powered OFF	Jumped	Jumped
During Boot	Indeterminate	Indeterminate
Normal Operation	Open	Open
Minor Alarm Only	Jumped	Open
Major Alarm Only	Open	Jumped
Major and Minor Alarms	Jumped	Jumped

**NOTE:** In Table 1.7, “Jumped” indicates that the circuit between the indicated pins has been closed (i.e., an external alarm would be triggered if connected to the pins).

### 3.2.7.3 CEC Status LEDs

This subsection discusses the meaning of the status LEDs on the CEC of the SFCS-1000 switch. The LEDs have been designed to provide information pertaining to the state of the switch at a glance.

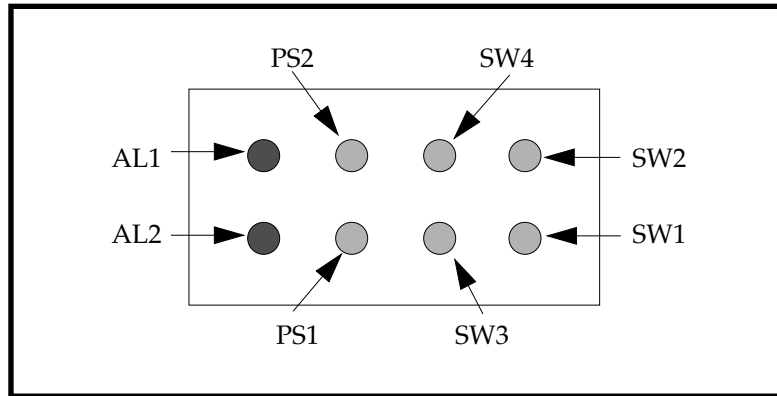

**Figure 3.11 - CEC Status LEDs**

There are eight status LEDs located on the front panel of the CEC in a 2 row x 4 column arrangement. The only LEDs that are actually labeled are AL1 and AL2, but for the purposes of discussion, the other LEDs will be referred to as labeled in Figure 3.11. The LEDs have been broken down into the following function groups: alarm LEDs, power supply LEDs, and switch board LEDs.

#### 3.2.7.3.1 Alarm LEDs

The LEDs labeled AL1 and AL2 are alarm relay LEDs. During boot-up, AL1 and AL2 are in an indeterminate state. During normal operation, they will be off. During a state of alarm, they will illuminate red. By default, AL1 is the major alarm indicator for SPANS failure and for link failure. By default, AL2 is the minor alarm indicator for fan failure, an overtemperature condition, or a power supply failure. The user may display and/or change these configurations through the use of AMI. For more information, please refer to the alarm configuration section in Appendix B, AMI Configuration Commands, in the Cabletron ATM Switch Configuration Manual.

### 3.2.7.3.2 Power Supply LEDs

There are two power supply LEDs on the front panel of the CEC, one for each power supply. The LEDs for the two power supplies should be illuminated yellow, indicating that the CEC is on and that the power supply corresponding to that LED is functioning correctly. The LED for a failed power supply will be extinguished. On an SFCS-1000, power supply "1" is in the slot labeled PS1 on the enclosure, while power supply "2" is in the slot labeled PS2 on the enclosure.

### 3.2.7.3.3 Switch Board LEDs

There are four switch board LEDs on the front panel of the CEC, one for each possible switch board. These LEDs should be blinking, indicating that the switch has booted and is operating correctly. If the SCP is removed, the LEDs may remain in a steady-on or steady-off state. Even if the SCP has booted correctly, the LEDs will not illuminate if the SCP is running a software version prior to 3.2.0. If the switch board in the slot corresponding to the LED is not intended for an SFCS-1000 (e.g., it is an SFCS-200BX board), or if the entire switch board corresponding to that LED is removed, then that LED will be extinguished. On an SFCS-1000, the SW1 LED corresponds to switch board "1," which is in the slot labeled 1 on the enclosure, and so on.

### 3.2.7.4 Ethernet Port

The Ethernet port located on the CEC of the SFCS-1000 has a standard RJ-45 female connector and is designed to provide a single, unified Ethernet connection. It is connected via the backplane and simple Ethernet repeater to each SCP's Ethernet port, thus eliminating the need to attach each SCP individually. This Ethernet port has four LEDs which indicate its current status as shown in Figure 3.12. These LEDs are described in Tables 1.8 through 1.11.

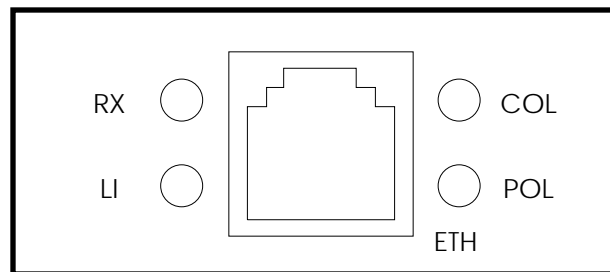

**Figure 3.12 - CEC Ethernet Port and LEDs**



**Table 3.8 - CEC Receive (RX) LED Description**

LED Color	Meaning
green	The Ethernet port is receiving traffic normally.
off	The Ethernet port is NOT receiving traffic.

**Table 3.9 - CEC Link Integrity (LI) LED Description**

LED Color	Meaning
green	The status of the twisted pair cable connected to the CEC Ethernet port is OK.
off	The Ethernet port is NOT receiving link integrity pulses. Check the integrity of the connection.

**Table 3.10 - CEC Collision (COL) LED Description**

LED Color	Meaning
red	An Ethernet collision has been detected on the CEC Ethernet port.
off	No Ethernet collisions have been detected.

**Table 3.11 - CEC Polarity (POL) LED Description**

LED Color	Meaning
amber	A reverse polarity condition has been detected on the twisted pair cable connected to the CEC Ethernet port. The polarity is automatically corrected, but the amber light will remain illuminated until a corrected twisted pair cable is inserted into the Ethernet port.
off	The polarity of the twisted pair cable connected to the CEC Ethernet port is OK.



# CHAPTER 4

## Switch Setup

This chapter describes how to handle and set up a Cabletron ATM switch prior to its operation.

### 4.1 Introduction

---

Before installing a Cabletron ATM switch, there are several important factors that must be taken into consideration, depending on the type of installation site. The following sections discuss in detail how to install a Cabletron ATM switch and any prerequisites to the installation.

**NOTE:** It is important to read through the ENTIRE installation procedure before attempting to turn on the power to the unit.

### 4.2 Unpacking

---

Upon receipt of, and before opening your Cabletron ATM switch, inspect the package for any damage that may have occurred during shipping. If the package shows any signs of external damage or rough handling, notify your carrier's representative.

When unpacking your Cabletron ATM switch, be sure to keep all original packing materials. They may be needed for storing, transporting, or returning the product.

### 4.2.1 Inventorying the Unit

A complete inventory of the Cabletron ATM switch package should be performed before any power is supplied to the unit.

The Cabletron ATM switch package should contain the following:

- Cabletron ATM switch
- Cabletron ATM Switch User's Manual (this manual)
- Cabletron ATM Switch Configuration Manual
- Power cords<sup>1</sup>
- International power cords (optional)<sup>1</sup>
- Modem serial cable
- Anti-static grounding strap
- Product registration card
- Rack-mount kit (standard with an SFCS-200BX)<sup>2</sup>

The rack-mount kit should contain the following:

- 1 left rack-mount bracket
- 1 right rack-mount bracket
- 1 cable strain relief rail
- 6 Phillips-head screws

If any of the items listed above are missing or damaged, please contact Cabletron Systems' Technical Support immediately.

---

1. The SFCS-200WG comes with one power cord (or international power cord). The SFCS-200BX and the SFCS-1000 each come with two power cords (or international power cords).

2. The rack-mount kit is not applicable to the SFCS-1000. The rackmount kit is optional for the SFCS-200WG and may be purchased separately.

### 4.3 Electrical Considerations

---

The following items should be considered when setting up the switch:

**CAUTION**



Consideration should be given to the connection of the equipment to the supply circuit and the effect that the overloading of circuits could have on overcurrent protection and supply wiring. Appropriate consideration of equipment nameplate ratings should be used when addressing this concern.

**CAUTION**



Reliable grounding of rack-mounted equipment should be maintained. Particular attention should be given to supply connections other than direct connections to the branch (i.e., use of power strips).

## 4.4 Rack-Mounting an SFCS-200BX

---

The SFCS-200BX is designed to be installed either as a stand-alone unit placed on the desktop, or as a rack-mounted unit using the included rack-mount kit (refer to section 4.2.1). The following items should be addressed when rack-mounting this switch:

**WARNING!**



When rack-mounting equipment, make sure that a hazardous condition is not created due to uneven weight distribution.

**CAUTION**



To prevent damage to your equipment, Cabletron Systems recommends that the maximum operating temperature not exceed 40°C. Consideration must be made if the switch is to be installed in a closed or multi-unit rack assembly, because the ambient temperature of the rack environment may be greater than the room ambient temperature.

**CAUTION**



Take care not to block the air vents of the switch, as this would compromise the amount of air flow required for proper cooling.

### 4.4.1 Required Tools

A set of rack-mount brackets, a cable relief strain rail, and 6 Phillips-head screws are supplied with each SFCS-200BX for rack-mounting the unit. You will need to supply a Phillips screwdriver.

**WARNING!**



To prevent user injury and possible damage to equipment, Cabletron Systems recommends that at least two people be present when rack-mounting the SFCS-200BX.

#### 4.4.2 Installing the Rack-mount Brackets

To install the rack-mount brackets and cable relief strain rail, use the following procedure:

1. Carefully place the SFCS-200BX unit upside down on a clean, flat, sturdy work surface with the front of the unit still facing front.
2. Using a Phillips screwdriver, remove the four feet from the bottom of the unit.
3. Each rack-mount bracket has three screws that secure the bracket to the bottom of the unit. The screw closest to the front of the unit is used to secure the bracket to the bottom of the unit as well as secure the cable relief strain rail to the front of the unit. Tighten the three screws to secure the left bracket, marked HWST0027-0001, and the left side of the cable relief strain rail to the left side of the unit. Tighten the three screws to secure the right bracket, marked HWST0027-0002, and the right side of the cable relief strain rail to the right side of the unit.

#### CAUTION



When attaching the rack-mount brackets, the use of screws other than those provided could result in damage to the unit.

4. Once the brackets and the cable relief strain rail are secure, choose a rack position for the SFCS-200BX. The SFCS-200BX should be placed right side up in the rack with the front of the unit facing forward.

#### CAUTION



When it is mounted in the equipment rack, do not use the SFCS-200BX chassis to support other equipment. This could overload the mounting brackets and cause damage to the unit.

**NOTE:** The SFCS-200BX is an operational ATM switch at this point if used with other Cabletron switches or with ATM interface cards. However, if other vendor equipment is connected, you may have to complete an initial user configuration.

**NOTE:** If you wish to have remote access to the switch, you must first install a serial cable and configure a modem. Please refer to subsections 4.7 and 4.8 for more information.



## 4.5 Rack-Mounting an SFCS-200WG

The SFCS-200WG is designed to be installed either as a stand-alone unit placed on the desktop, or as a rack-mounted unit using the optional rack-mount kit (refer to section 4.2.1), which may be purchased separately. The following items should be addressed when rack-mounting this switch:

**WARNING!**



When rack-mounting equipment, make sure that a hazardous condition is not created due to uneven weight distribution.

**CAUTION**



Cabletron Systems recommends that the maximum operating temperature not exceed 40°C. Consideration must be made if the switch is to be installed in a closed or multi-unit rack assembly, because the ambient temperature of the rack environment may be greater than the room ambient temperature.

**CAUTION**



Take care not to block the air vents of the switch, as this would compromise the amount of air flow required for proper cooling.

### 4.5.1 Required Tools

A set of rack-mount brackets, a cable relief strain rail, and 6 Phillips-head screws can be purchased separately for rack-mounting the SFCS-200WG. You will also need to supply a Phillips screwdriver.

**WARNING!**



To prevent user injury and possible damage to equipment, Cabletron Systems recommends that at least two people be present when rack-mounting the SFCS-200WG.

## 4.5.2 Installing the Rack-mount Brackets

To install the rack-mount brackets and cable relief strain rail, use the following procedure:

1. Carefully place the SFCS-200WG unit upside down on a clean, flat, sturdy work surface with the front of the unit still facing front.
2. Using a Phillips screwdriver, remove the four feet from the bottom of the unit.
3. Each rack-mount bracket has three screws that secure the bracket to the bottom of the unit. The screw closest to the front of the unit is used to secure the bracket to the bottom of the unit as well as secure the cable relief strain rail to the front of the unit. Tighten the three screws to secure the left bracket, marked HWST0027-0001, and the left side of the cable relief strain rail to the left side of the unit. Tighten the three screws to secure the right bracket, marked HWST0027-0002, and the right side of the cable relief strain rail to the right side of the unit.

### CAUTION



When attaching the rack-mount brackets, the use of screws other than those provided could result in damage to the unit.

4. Once the brackets and the cable relief strain rail are secure, choose a rack position for the SFCS-200WG. The SFCS-200WG should be placed right side up in the rack with the front of the unit facing forward.

### CAUTION



When it is mounted in the equipment rack, do not use the SFCS-200WG chassis to support other equipment. This could overload the mounting brackets and cause damage to the unit.

**NOTE:** The SFCS-200WG is an operational ATM switch at this point if used with other Cabletron switches or with ATM interface cards. However, if other vendor equipment is connected, you may have to complete an initial user configuration.

**NOTE:** If you wish to have remote access to the switch, you must first install a serial cable and configure a modem. Please refer to subsections 4.7 and 4.8 for more information.

## 4.6 Rack-Mounting an SFCS-1000

---

The SFCS-1000 switch is designed to be rack-mounted. The following items should be addressed when rack-mounting this switch:

**WARNING!**



When rack-mounting equipment, make sure that a hazardous condition is not created due to uneven weight distribution.

**CAUTION**



Cabletron Systems recommends that the maximum operating temperature not exceed 40°C. Consideration must be made if the switch is to be installed in a closed or multi-unit rack assembly, because the ambient temperature of the rack environment may be greater than the room ambient temperature.

**CAUTION**



Take care not to block the air vents of the switch, as this would compromise the amount of air flow required for proper cooling.

**CAUTION**



Ensure that any unpopulated switch board slots are covered with a blank panel before turning on your SFCS-1000. Operating the switch with any of these slots left open can cause a significant temperature rise in a very short time.

### 4.6.1 Installing the SFCS-1000

To install the SFCS-1000 in the equipment rack, use the following procedure:

1. Choose a rack position for the SFCS-1000.

**WARNING!**

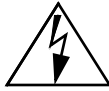

Because of the unit's weight, two people should lift the unit to place it in the equipment rack.

2. Place the SFCS-1000 in the rack with the front of the unit facing forward.

**CAUTION**



When it is mounted in the equipment rack, do not use the SFCS-1000 chassis to support other equipment. This could overload the mounting brackets and cause damage to the unit.

3. After mounting the enclosure, verify that the enclosure is screwed tightly to the rack to ensure that proper grounding is maintained. Additionally, the rack should be connected to an earth ground.

**NOTE:** The SFCS-1000 is an operational ATM switch at this point if used with other Cabletron switches or with ATM interface cards. However, if other vendor equipment is connected, you may have to complete an initial user configuration.

**NOTE:** If you wish to have remote access to the switch, you must first install a serial cable and configure a modem. Please refer to subsections 4.7 and 4.8 for more information.

## 4.7 Installing the Serial Cable

---

Connect the serial cable (supplied with the switch) from the switch's serial port to any tty-type device (such as a terminal, or the serial port of a workstation or PC running a terminal emulation program).

**NOTE:** The switch's tty port comes configured at 9600 baud, 8 bits, no parity and 1 stop bit.

When you turn on the switch, you should see the switch boot on the tty device connected to the switch's serial port.

**NOTE:** The switch is ready for user configuration as soon as it is connected to a tty-type device. To access the switch, enter `asx` at the prompt of the tty device.

---

## 4.8 Modem Configuration

---

All Cabletron ATM switches support modem access. This may be useful if a switch is installed in a remote location where direct, physical access to the switch is not possible or practical. Keep the following in mind when using a modem to access a Cabletron ATM switch:

- To allow the Cabletron ATM switch to communicate with the modem, a Null-Modem Adapter must be installed on the factory-supplied serial cable.
- The Cabletron ATM switch will not disconnect an ATM Management Interface (AMI) session on loss-of-carrier; therefore, you must ensure that you have completely exited from an open AMI session before disconnecting the modem session.

To allow a modem to work with a Cabletron ATM switch, you must complete two sets of configurations. First, the speed of the serial port on the Cabletron ATM switch must be set to match that of the attached modem and, second, the modem parameters must be configured correctly.

### 4.8.1 Modem Parameters

You should use a Hayes-compatible modem, as the configuration parameters supplied here are applicable to this type of modem. The following parameters should be applied to your Hayes-compatible modem to allow it to function properly with the switch's serial port. You may attach a tty device to the modem to set these parameters.

<u>Setting</u>	<u>Comment</u>
ATE0	Turn off Echoing
ATQ1	No Return Codes
AT&C0	Force Carrier Detect (CD) High
AT&D0	Ignore Data Terminal Ready (DTR)
AT&W	Save Modem Configuration

## 4.9 Configuring IP Addresses

---

The recommended configuration for a Cabletron ATM switch is to assign an IP address to its network interfaces. This allows you to communicate with the switch from any workstation connected to your ATM LAN. IP addresses must be assigned to the network interfaces in order to perform any SNMP functions. Additionally, if you intend to connect the switch to an Ethernet, you should assign an IP address to the switch's Ethernet network interface.

To configure the IP addresses, log in to an AMI session on the switch. To modify the IP address of the SCP's IP interfaces, enter the following parameters:

**NOTE:** On an SFCS-1000, the IP address must be configured individually for each SCP.

**configuration ip address <interface> <address>**

The <interface> variable indicates the name of the IP interface to be managed. The <address> variable indicates the IP address for this interface.

To modify the IP subnet mask, enter the following parameters:

**configuration ip mask <interface> <mask>**

The <interface> variable indicates the name of the IP interface. The <mask> variable indicates the subnet mask for this IP interface.

The IP address that you assign for the switch's ATM interface must be an address within a subnet that is assigned to your ATM LAN. In general, the entire ATM LAN should be configured as a single IP subnet. Consequently, the ATM interfaces of all Cabletron switches in the ATM LAN should be in the same IP subnet. Consult your systems administrator for help if you are unsure of how to do so.



---

## 4.10 AMI Security

---

The administrative password on your Cabletron ATM switch may be changed to provide password-protected access to AMI. Cabletron Systems recommends that you do this to prevent unauthorized users from accessing your Cabletron ATM switch. This option is available in AMI at the operation level. Be sure that you want to change the password because upon entering the command string operation password, the user is prompted to enter a new password immediately.

For complete information about how to assign or change the password, please refer to the section entitled "Setting or Changing the Password" in Appendix C, AMI Operation Commands, in the Cabletron ATM Switch Configuration Manual.

---

## 4.11 Subsequent Operation

---

After its initial configuration is complete, a Cabletron switch DOES NOT require a terminal for normal operation.

**NOTE:** Cabletron Systems strongly recommends that you disconnect the serial cable once you have configured the switch and then access the switch over the ATM network or over Ethernet.

All further communication with your Cabletron switch can be performed over the ATM network or over Ethernet. For example, you can access AMI using telnet.

**WARNING!**



Once installed, before any service is performed on the unit, the power should be turned off and the power cord disconnected, except when following the hot-swap instructions in this manual.

## 4.12 Verifying the Installation

---

To verify that your switch is up and running, log in to AMI and open a session on the switch. Enter the following parameters at the `localhost::>` prompt to show the configuration of all of the ports on an individual switch fabric:

`configuration port show`

## 4.13 Product Registration Information

---

After you have successfully completed the installation process, please fill out the enclosed product registration card for your Cabletron ATM switch, and return it to Cabletron Systems immediately.

This chapter discusses various hardware maintenance procedures for the Cabletron ATM switches. Items discussed include the following:

- Network Module Replacement
- Power Supply Replacement
- Fan Tray Replacement
- Switch Control Processor Replacement
- Switch Board Replacement

## **5.1 Network Module Replacement**

---

### **5.1.1 Overview**

The network modules in all Cabletron ATM switches are hot-swappable, meaning that they can be removed and replaced with the unit under power. Network modules should only be hot-swapped for purposes of replacing a failed unit. Therefore, they should be replaced with a network module of the same type, the same Series, and with the same number of ports. A network module's type is the class to which the network module belongs (e.g., OC-3, E3, TAXI, etc.).

If a network module is removed and replaced by a network module of another type or by a network module with fewer ports, all configuration information for that network module's slot will be deleted, and the new network module will be configured with the defaults for its type. For example, if a 4-port Series A OC-3c is replaced by a 4-port Series C OC-3c, the Series C network module will use the same configuration of the Series A network module. Any additional configurable variables will contain OC-3c defaults. If a 4-port OC-3c is replaced by a 4-port DS3, all configuration information for that slot will be deleted and the DS3 will be initialized with DS3 defaults. If a 6-port DS3 is replaced by a 2-port DS3, all configuration information for the slot will be deleted, and the new DS3 initialized with DS3 defaults. If a network module is placed into a previously vacant slot, it will be initialized into the default state appropriate to that type of network module.

### 5.1.2 Multicast Mode

When hot-inserting or hot-swapping a network module, the mode in which the switch is running must also be considered. A Cabletron 200 Series switch can operate in one of two multicast modes: extended mode or non-extended mode.

- Extended mode - The added features of Series C network modules give Cabletron switches greater flexibility when choosing VCIs for multicast connections. This flexibility provides more successful multicast (point-to-multipoint, or PMP) connection setups. If a switch fabric contains no network modules or if it contains only Series C network modules, the switch will operate in extended mode.
- Non-extended mode - If a switch fabric contains at least one Series A or at least one Series B network module, that switch fabric will operate in non-extended (or mixed) mode.

**NOTE:** The mode in which the switch operates is determined each time the SCP restarts. If a switch is running in extended mode and a Series A or B network module is hot-inserted, the switch will not automatically revert to non-extended mode. The switch must be restarted immediately so that it operates in non-extended mode. If it is not restarted, all multicast connections fail on the Series A or B network module.

You can display the multicast mode in which your switch is operating by using the configuration board show command in the ATM Management Interface (AMI).

**NOTE:** If a switch is running in non-extended mode, originating path 0 should always exist on port 1 of each Series C network module for multicast connection setups to succeed. Multicast connection information for all of the ports of Series C network modules is stored in the space allocated for port 1 and path 0 on each Series C network module.

### 5.1.3 Hot-swapping Network Modules

When removing or replacing network modules, use the following procedure:

**WARNING!**

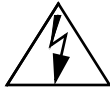

To reduce risk to the user and to prevent damage to equipment, it is recommended that you use the included grounding strap when handling this or any other component.

**NOTE:**

All AMI sessions should be terminated before hot-swapping network modules of different types.

1. Label and remove all network connections from the ports on the network module.
2. Loosen the two captive fasteners on either edge of the network module using a straight screwdriver.
3. Pull firmly but carefully on the captive fasteners, removing the network module from the switch as shown in Figure 3.1.
4. Insert the replacement module by sliding it into the card guides. Push firmly to seat the network module so that the faceplate is flush with the switch. Re-tighten the captive fasteners.

**CAUTION**



For continued safety, tighten the captive fasteners with a straight screwdriver.

5. Restore the network connections from Step 1.

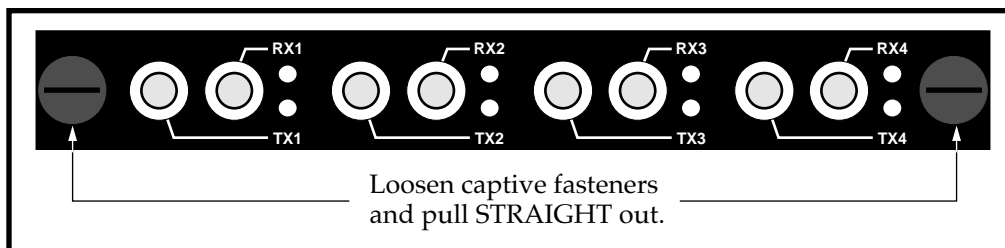

**Figure 5.1** - Removal of Network Modules

## 5.2 Power Supply Module Replacement

---

The power supplies in the SFCS-200BX and the SFCS-1000 are hot-swappable, meaning that they can be removed/replaced without having to shut down the switch.

**WARNING!**



DO NOT attempt to replace a power supply module without reading this section. Serious injury to the user or damage to the equipment may result if proper replacement procedures are not followed.

### 5.2.1 SFCS-200BX Power Supply Module Replacement

#### 5.2.1.1 Replacing an SFCS-200BX AC Power Supply

The procedure for hot-swapping an SFCS-200BX AC power supply module is as follows:

**WARNING!**



To reduce risk to the user and to prevent damage to the equipment, it is recommended that you use the included grounding strap when handling this or any other component.

**NOTE:**

A replacement AC power supply will not function in a DC-equipped SFCS-200BX, and vice-versa. However, no damage will result if this occurs.

1. Determine which power supply is defective by examining the power supplies themselves. A red LED or an extinguished LED indicates the failed supply. Power supply "1" is on the left-hand side of the unit, and power supply "2" is on the right-hand side (while facing the front of the unit).

**WARNING!** Failure to perform Step 2 can result in serious injury to the user or damage to the equipment.

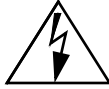

2. Turn OFF the power switch on the front of the defective power supply.
3. Unplug and remove the power cord from the rear of the unit that corresponds to the failed supply. When facing the front of the unit, power supply 1 (on the left) corresponds to the top power cord in the rear.
4. Unscrew the two captive fasteners on the front of the unit using a straight blade screwdriver.
5. Pull forward on the handle to remove the sliding tray.
6. Unscrew the four nuts securing the inner tray to the sliding tray.
7. Lift the inner tray from the sliding tray.
8. Place the new power supply inner tray assembly in the sliding tray and screw down the four nuts securing the inner tray.
9. Check to see that the fuses on the new unit are of the same type and rating as the fuses in the replaced power supply. The fuses should be 4A, 240V.

**WARNING!** Failure to perform Step 10 can result in serious injury to the user or damage to the equipment.



10. Ensure that the power switch on the new power supply is turned OFF before inserting it into the enclosure.
11. Push the sliding tray back into the enclosure, being careful to align the card guides.
12. To ensure maximum safety, and to ensure that the connectors have seated properly, re-tighten the captive fasteners using a straight blade screwdriver.
13. Once the new supply is completely installed, re-insert and plug in the power cord, and turn the power switch to the ON position.

## 5.2.2 SFCS-1000 Power Supply Module Replacement

### 5.2.2.1 Replacing an SFCS-1000 AC Power Supply (Model A)

A model A AC power supply module for an SFCS-1000 is shown in Figure 3.2.

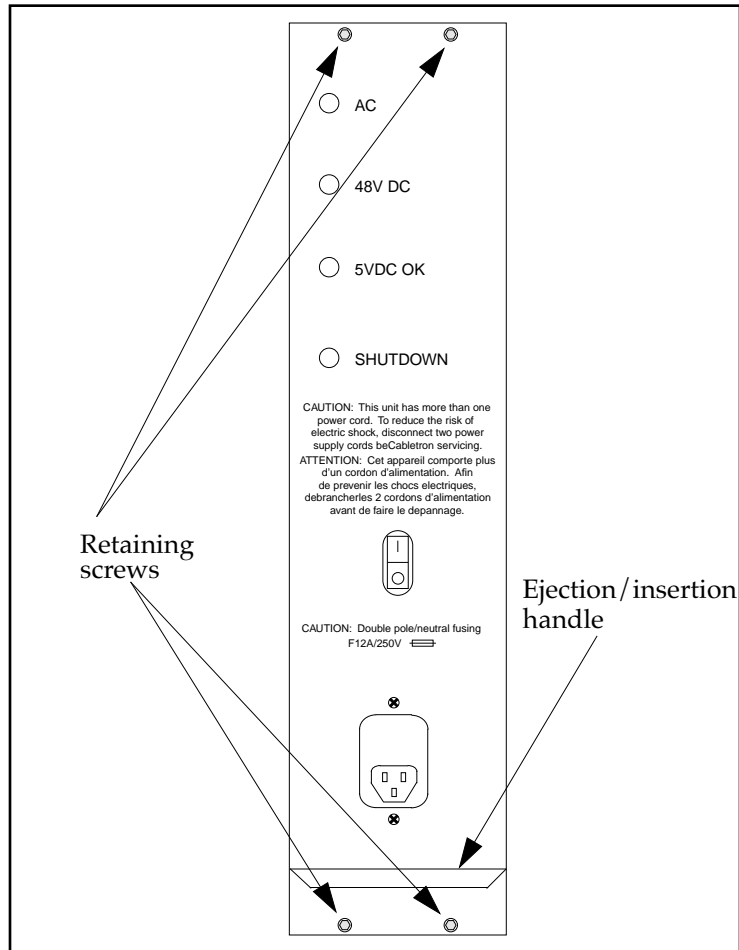

Figure 5.2 - Model A SFCS-1000 AC Power Supply



The procedure for hot-swapping a model A SFCS-1000 AC power supply is as follows:

**WARNING!**



A replacement DC power supply should never be placed in an SFCS-1000 that already contains an AC power supply, and vice-versa. If these instructions are not heeded, there is a risk of electrical shock, danger to personal health, and serious damage to the equipment.

**WARNING!**



It is highly recommended that you use the included grounding strap when handling this or any other component.

1. Determine which power supply is defective by examining the power supplies themselves. A red LED or an extinguished LED indicates the failed supply. On an SFCS-1000, power supply "1" is in the slot labeled PS1 on the chassis, while power supply "2" is in the slot labeled PS2 on the chassis.

**WARNING!**



Failure to perform Step 2 can result in serious injury to the user or damage to the equipment.

2. Turn OFF the power switch on the front of the defective power supply. Wait for the yellow SHUTDOWN LED to extinguish before moving to Step 3.
3. Unplug and remove the power cord from the failed supply.
4. Unscrew the four retaining screws with a 3/32-inch Allen wrench and pull forward on the handle located below the power cord.
5. Remove the defective supply and prepare to install the new one.

**WARNING!**



Failure to perform Steps 6 or 7 can result in serious injury to the user or damage to the equipment.

6. Ensure that the power switch on the new power supply is turned OFF before inserting it into the enclosure.
7. Ensure that the fuses on the new unit are rated at 12.5A, 250V.
8. Carefully align the guide rails on the new AC power supply in the slot.
9. Push on the center of the front panel of the power supply to slide it back into the enclosure.
10. To ensure maximum safety and to ensure that the connectors have been seated properly, re-tighten the four retaining screws using a 3/32-inch Allen wrench.
11. Reconnect and plug in the power cord to the new power supply.
12. Turn the power switch on the new supply to the ON position.

### 5.2.2.2 Replacing an SFCS-1000 AC Power Supply (Model B)

A model B AC power supply module for an SFCS-1000 is shown in Figure 3.3.

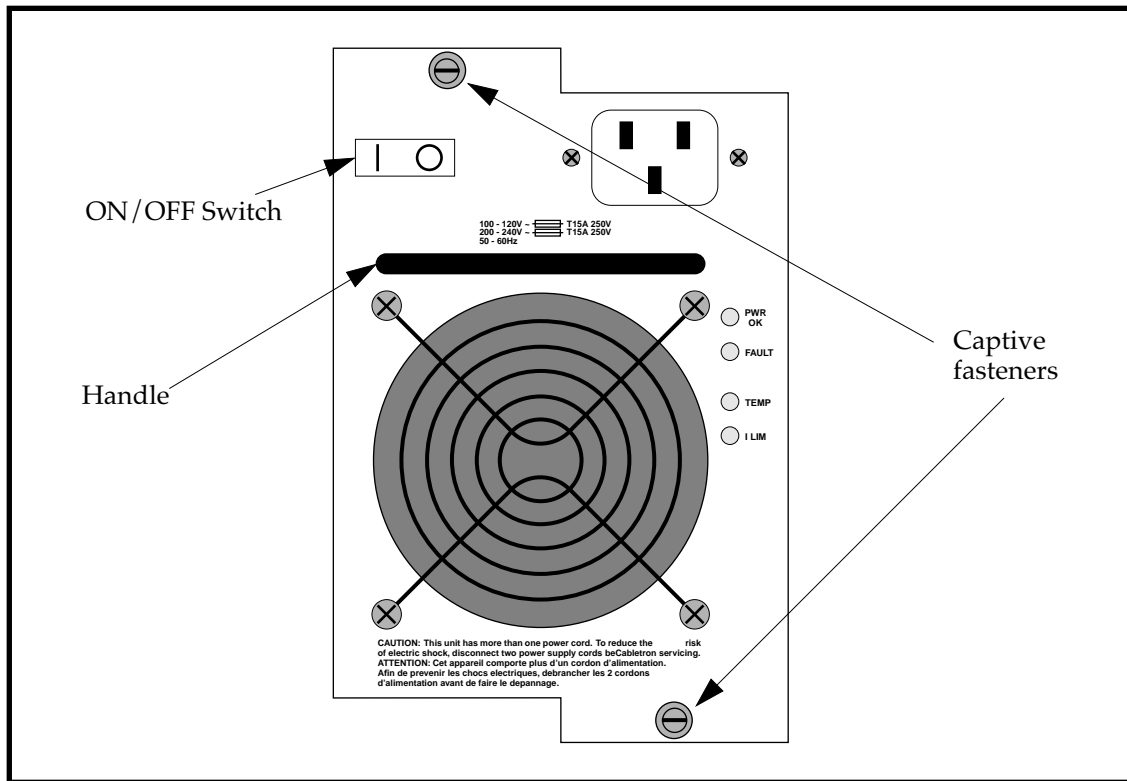
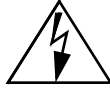

Figure 5.3 - Model B SFCS-1000 AC Power Supply

The procedure for replacing a model B SFCS-1000 AC power supply module is as follows:

**WARNING!**



A replacement DC power supply should never be placed in an SFCS-1000 that already contains an AC power supply, and vice-versa. If these instructions are not heeded, there is a risk of electrical shock, danger to personal health, and serious damage to the equipment.

**WARNING!**



It is highly recommended that you use the included grounding strap when handling this or any other component.

1. Determine which power supply is defective by examining the power supplies themselves. An extinguished "PWR OK" LED or an illuminated "FAULT" LED indicates the failed supply. On an SFCS-1000, power supply "1" is in the slot labeled PS1 on the chassis (top), while power supply "2" is in the slot labeled PS2 on the chassis (bottom).

**WARNING!**



Failure to perform Step 2 can result in serious injury to the user or damage to the equipment.

2. Turn OFF the power switch on the front of the defective power supply. Wait at least one (1) second after turning off the power before moving on to the next step.
3. Disconnect the AC line from the front of the defective power supply.
4. Unscrew the two captive fasteners (one on the upper, left corner of the faceplate and one on the lower, right corner of the faceplate, see Figure 3.3) using a straight blade screwdriver.

5. Pull forward on the power supply's handle (located below the power switch and AC plug) to remove it from the chassis.
6. Set the failed supply aside and prepare to install the new one.

**WARNING!**

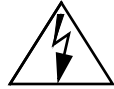

Failure to perform Steps 7 or 8 can result in serious injury to the user or damage to the equipment.

7. Ensure that the power switch on the new AC power supply is turned OFF before inserting the supply into the metal enclosure.
8. Check to see that the fuses on the new unit are rated at 15A, 250V.
9. Set the supply on the guide rails in the enclosure so that the supply is properly aligned in the slot. Position the supply so that the rear connectors are on top.
10. Once the rails are properly aligned, push on the handle on the front of the supply to slide it back into the chassis. Press firmly to ensure that the connectors on the rear of the supply have mated with those on the backplane.
11. To ensure maximum safety and to ensure that the connectors have mated properly, tighten the two captive fasteners on the front of the supply using a straight blade screwdriver.
12. Once completely installed, you may reconnect the AC line and turn the power switch to the ON position.
13. After a second or two, the PWR OK LED on each supply illuminates green, indicating that the supply is functioning properly.

## 5.3 SFCS-1000 Fan Tray Replacement

---

The SFCS-1000 has a removable fan tray with large fans that cool the switch hardware and power supply modules. Located at the base of the upright unit, the fan tray is removable from the front of the unit and is hot-swappable, meaning that it can be replaced with the SFCS-1000 under power. The procedure for replacing a fan tray is as follows:

**WARNING!** It is highly recommended that you use the included grounding strap when handling this, or any other component.



1. Remove the four retaining screws at the top of the fan tray with a 3/32-inch Allen wrench.
2. Remove the fan tray by pulling it away from the switch unit.
3. Set the old fan tray aside and place the new fan tray in front of the vacant slot in the SFCS-1000.
4. Insert a new fan tray in the slot and slide it all the way into the chassis. Seat the connectors by pressing firmly on the unit (this will apply power to the fan tray).
5. Once seated, replace the four screws removed in Step 1 above. This will properly secure the unit in the chassis.

**CAUTION** Do not run the unit for any great length of time without the fan tray installed or the unit will shut itself down because of an overtemperature condition.



## 5.4 Switch Control Processor Replacement

The following procedure explains how to remove an i960 switch control processor (SCP) from a switch fabric and install a new SCP.

**WARNING!**

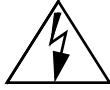

It is highly recommended that you use the included grounding strap when handling this or any other component.

**CAUTION**



Do not attempt to remove or replace an SCP without first removing all connections to the SCP (i.e., serial or Ethernet connections).

1. Loosen the two captive fasteners on either edge of the SCP using a straight screwdriver.
2. Pull firmly and carefully on the two captive fasteners, removing the SCP from the switch fabric as shown in Figure 3.5.

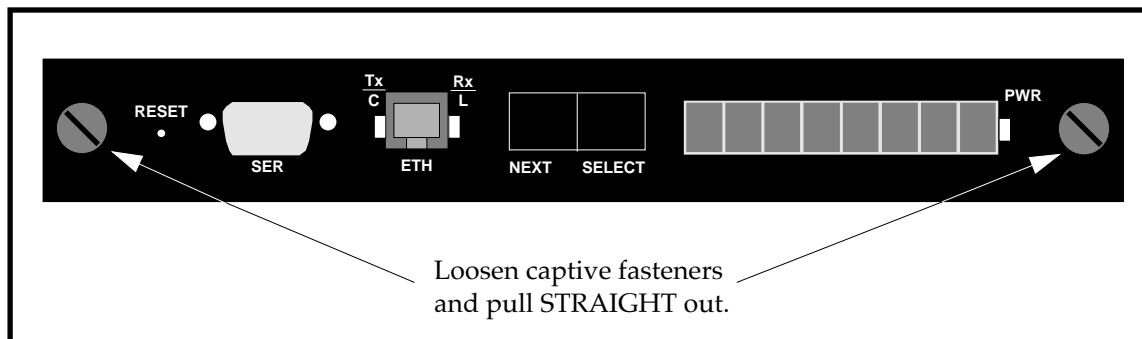

**Figure 5.4 - Removal of an SCP**

3. Set the old SCP aside.

**CAUTION**

Take care to properly align the SCP in the card guides in the following step.



4. Insert the new SCP into the switch fabric by sliding it into the card guides.
5. Push firmly to seat the SCP so that its faceplate is flush with the front panel of the switch board.
6. Re-tighten the captive fasteners with a straight screwdriver to ensure the SCP is secure.

Once the SCP has been installed and the system reboots, the PVCs will be re-established provided that none of the network modules were replaced after the SCP was removed and provided that all of these steps have been performed properly.



## 5.5 Switch Board Replacement

---

The switch boards in the SFCS-1000 are hot-swappable, meaning that they can be removed and replaced with the chassis under power. The proper procedure for hot-swapping a switch board is as follows:

**WARNING!**



It is highly recommended that you use the included grounding strap when handling this, or any other component.

**CAUTION**



Ensure that any unpopulated switch board slots are covered with a blank panel before turning on your SFCS-1000. Operating the switch with any of these slots left open can cause a significant temperature rise in a very short time.

**NOTE:**

As a precaution, it is recommended that you back up your CDB before performing this process. Instructions for backing up your CDB can be found in Appendix C, AMI Operation Commands, of the Cabletron ATM Switch Configuration Manual.

**NOTE:**

Only replace a switch board with another switch board of the same type (i.e., an SFCS-1000 switch board with an SFCS-1000 switch board).

**NOTE:** To ensure that the switch will work with the previously established network configuration, the relative position of the network modules must not change when you transfer them to the new fabric. For example, an OC-3c network module that is removed from slot A of the old switch fabric must be installed in slot A of the new switch fabric. Therefore, it is recommended that you label all network connections and network modules before removing them.

**NOTE:** To maintain your CDB, the SCP must be removed before the network modules are removed and it must be installed in the new fabric after the network modules have been installed.

1. Log out of all open AMI sessions on the switch board that is to be replaced.
2. Remove the SCP from the old switch board using the instructions found in Section 3.4, Switch Control Processor Replacement. Place the SCP on a clean, static-free work area.
3. Label and remove all fibers or coaxial cables connected to the ports on the switch board that is to be replaced. Then label and remove all network modules from the old switch board using the instructions found in Section 3.1, Network Module Replacement. Place the network modules on a clean, static-free work area.
4. Unscrew the retaining screws at the top and bottom of the switch board with a 3/32-inch Allen wrench. On an SFCS-1000, press the top black locking tab up towards the top and bottom black locking tab down towards the bottom of the chassis until they are parallel with the front panel of the switch.
5. Using the tabs as a handle, pull the switch board out of the chassis.

**CAUTION**

Make sure the replacement board is properly aligned in the slot in the next step.



6. Carefully slide the replacement board into the chassis using enough force to ensure that the connectors on the board mate with the connectors in the chassis.
7. Be sure to align the holes properly and screw the board into the chassis using the screws at the top and bottom of the board. Tighten until snug, but do not overtighten.
8. Re-install the network modules using the instructions found in Section 3.1, Network Module Replacement. Reconnect all fibers or coaxial cables to the ports.
9. Re-install the SCP using the instructions found in Section 3.4, Switch Control Processor Replacement.

Once the SCP has been installed and the system reboots, the PVCs will be re-established if all of the steps have been performed correctly and in the proper sequence.



This chapter details the steps necessary to upgrade the software on your Cabletron ATM switch. Some instructions in this chapter are only necessary under certain conditions—check the following before you proceed:

- If, after performing the upgrade, you wish to continue using an older version of software on your switch, you must read Section 6.4.
- If you wish to begin using the latest version of software immediately after performing the upgrade, you can skip Section 6.4.
- If you are unable to boot your switch from its FLASH, you must follow the instructions in Section 6.5.

First, you need the upgrade file from Cabletron Systems. This file can be obtained via ftp or diskette. To obtain the file via ftp, you must have ftp access. To obtain the file from diskette, you will need the distribution diskettes from Cabletron Systems.

**NOTE:** Sections 6.1 - 6.4 detail how to upgrade an SFCS200WG, SFCS-200BX or an SFCS-1000.

**NOTE:** You will also need a UNIX workstation with at least 5 Mbytes of free disk space. If you are upgrading from the distribution diskettes, the UNIX workstation must also be equipped with a floppy drive. The UNIX workstation must be connected (via ATM or Ethernet) to the SCP being upgraded.

### CAUTION



As a precaution, it is recommended that you back up your CDB before performing the upgrade process. For more information, see the section entitled, “Backing Up the CDB” in Appendix C of the Cabletron ATM Switch Configuration Manual.

**NOTE:** Each of the SCPs on an SFCS-1000 must be upgraded individually.

## 6.1 Obtaining the Software Upgrade File via Diskette

Using the Cabletron Systems distribution diskettes, the upgrade software must be installed on a workstation attached (via Ethernet or ATM) to the SCP being upgraded. The first disk contains a part of the distribution software, as well as a script that extracts the remaining software from the rest of the disks and builds the upgrade distribution on the workstation. The first disk can be extracted using the tar command:

```
tar -xvf <device>
```

where <device> is the block device name of the floppy drive. This disk should then be ejected from the floppy drive. On a SunOS system, the following command will eject a floppy disk:

```
eject <device>
```

where <device> is the block device name of the floppy drive. On other operating systems, there may be a different command for ejecting a floppy disk or there may be a manual eject button. If there is a manual eject button, eject the disk and proceed. If there is a UNIX command for ejecting the floppy, use that command to eject the floppy and proceed.

At this point, two files should have been created: `fore_extract` and `SFCS-200BX_<version>` (where <version> is the new software version). The `fore_extract` file is the script that will extract the files from the other floppies. If there is a command to eject a floppy on your system, set the following environment variable so the `fore_extract` script can properly eject the floppies:

```
setenv FORE_EJECT <eject_command> (for csh)
```

or

```
FORE_EJECT=<eject_command>;export FORE_EJECT (for sh)
```

On a Sun running SunOS 4.1.x, set the following environment variable so the `fore_extract` script can properly eject the floppies:

```
setenv FORE_EJECT eject
```

Execute the `fore_extract` script with the following command:

**`./fore_extract <device>`**

Once again, `<device>` is the block device name of the floppy drive. You will be asked to insert the remaining disks in sequence. If these steps are performed correctly, something similar to the following should appear on the screen:

```
filename: ASX-200BX_<version>  
directory: <directory from which it was extracted>
```

The `fore_extract` script will create a file called `ASX-200BX_<version>` in the current directory. This is the file that the SCP will use to upgrade its software. You will need to provide this filename and path later during the upgrade process.

## 6.2 Performing the Software Upgrade

---

To perform the software upgrade, you will use the operation upgrade command in AMI. The underlying file transfer mechanism used by this command is TFTP. If TFTP is to run properly between two machines, the file(s) being transferred must reside in a specific directory called "tftpboot." TFTP operates this way for security reasons.

When the operation upgrade command is issued in AMI, the switch starts up TFTP to the host, which searches for the file requested. The host, which is running TFTP, looks for the file in /tftpboot. When creating the path and filename to transfer the file to the switch, the host appends "/tftpboot" in front of the path name that appears after the colon (:) in the operation upgrade command.

For example, issuing operation upgrade 169.144.3.54:asx-scp\_4.0.0\_1.3 will cause TFTP to transfer the file "/tftpboot/asx-scp\_4.0.0\_1.3." For this reason, it is imperative that you place the upgrade file in the /tftpboot directory on the workstation to which you downloaded/extracted the file. If this directory does not already exist, create it by issuing the following command on the workstation:

```
mkdir /tftpboot
```

Now move the upgrade file to the /tftpboot directory with the following command:

```
mv <filename> /tftpboot
```

Once you have moved the software upgrade file to the /tftpboot directory on your workstation, you need to invoke the upgrade process on the SCP. Log in to AMI and enter the following parameters at the localhost : : > prompt:

```
operation upgrade ?
```

This will display the specific parameters that you need to enter as follows:

```
upgrade <remotehost>:<full path to remotefile>
```

Enter the remote machine name or IP address of the workstation to which you downloaded/extracted the upgrade file in the remotehost field. In the full path to remotefile field, enter ONLY the filename of the upgrade file (which should be in the /tftpboot directory on the remote host).



**NOTE:** If you obtained the upgrade file via ftp, full path to remotefile is the name of the uncompressed file. If you obtained the file from diskette, full path to remotefile is the path name printed during extraction.

For example, if you used ftp, you would enter something similar to the following:

```
operation upgrade 169.144.3.54:asx-scp_4.0.0_1.3
```

If you extracted the file from diskette, you would enter something similar to the following:

```
operation upgrade 169.144.3.54:ASX-200BX_4.0.0_1.3
```

In either case, you should receive messages similar to the following:

```
Received 688128 bytes in 5.3 seconds  
upgrade successful
```

```
Reboot the switch[y]?
```

**NOTE:** You have an important decision to make now. At this point, the boot pointer will have the new software's filename in it. A reboot will load the new version of software to FLASH, and the switch will be running the upgraded version when it comes up. If you wish, however, you can still run the old version of software. If you want to use the old version and change to the new version at a later time, enter `n` at the reboot prompt and follow the instructions in the next section, "Changing between Multiple Versions of Software."

To use the new version of software that you have just loaded, type y and press <ENTER> or simply press <ENTER> to reboot.

```
Reboot the switch[y]? y
```

Once the SCP reboots, you will be closed out of all active sessions on the SCP. You will need to log in to AMI again if you want to begin another session.

**NOTE:** If something went wrong during the upgrade process, a new file named “upgrade” will appear in the FLASH file system and you will not be prompted with the “Reboot the switch [y]?” message.

If the upgrade is unsuccessful or if you have any other problems with the upgrade, please contact Cabletron Systems’ Technical Support.

## 6.3 Changing between Multiple Versions of Software

It is possible to select between multiple versions of installed software at any time (not just during an upgrade procedure). You can display all the versions that are installed by typing the following:

```
localhost::operation flash> dir

FT330.35
CURRENT
FT340.11
```

However, in this list, CURRENT is simply a pointer to the version that will be used as the current switch software AFTER a reboot. To display the version to which CURRENT is pointing, as well as all the versions that are installed, type the following:

```
localhost::operation> version
Software versions installed : FT330.35 FT340.11
Current software version is FT330.35
```

Notice that no parameter for version was specified above. If no parameter is specified, it will list the current and installed versions, but will not change anything.

In this example, to change the current version of software from FT330.35 to FT340.11, type the following:

```
localhost::operation> version FT340.11
Current software version is FT340.11
Software versions installed : FT330.35 FT340.11
```

**NOTE:** By using the operation version command and specifying a version, you change the version to which CURRENT is pointing.

At this point, the switch is still running FT330.35, but CURRENT is pointing to FT340.11. To make the change complete, enter the following:

```
localhost::operation> reboot
```

```
Are you sure you want to reboot this switch [n]? y
```

When the SCP reboots, it will look to see which version that CURRENT is specifying. In this case, it will see FT340.11 and use that version.

---

## 6.4 Using bootp to Download Software to the Switch

---

**NOTE:** Section 6.5 needs to be performed only if your SCP fails to boot from its FLASH.

### 6.4.1 Overview

Each SCP on a Cabletron switch comes with its hardware address (Ethernet MAC address) burned in from the factory, but it does not come preconfigured with an IP address. Any time that the switch is turned on, the SCP attempts to boot from its FLASH memory.

If an SCP can not boot from its FLASH (e.g., the FLASH has recently been initialized or the switch software image in the FLASH is corrupt), it attempts to locate a bootp server on its Ethernet interface.

The SCP broadcasts its Ethernet MAC address in a bootp datagram. Bootp servers on the network that receive that broadcast look up that MAC address in their bootptab file. If they find an entry for that MAC address, they broadcast a reply to the SCP that contains a pointer to a switch software image file residing on the bootp server.

When the SCP sees the bootp reply, it initiates a tftp session with the bootp server using the path and filename returned in the datagram from the server.

### 6.4.2 Setting Up Your bootp Server

If the process described above is to happen, you need to provide the bootp server with the SCP's Ethernet MAC address and the path to the switch software image.

Before the bootp server will work, you must add or uncomment the following line in /etc/inetd.conf:

```
bootps dgram udp wait root /etc/bootpd -d4 /etc/bootptab
```

with the bootpd and the bootptab files in the /etc directory. Also, the following line must appear in /etc/services:

```
bootp          67/udp        bootps
```

Before any of the above changes can take effect, `inetd` must re-read the configuration file.

**NOTE:** If you need to set up a `tftpd` server, as described in Section 6.5.4, the following process is not necessary at this time. Instead, make `inetd` re-read its configuration file after setting up your server.

Determine the process number of `inetd` by entering the following:

```
host: ps -aux | grep inetd
```

Something similar to the following will be displayed:

```
root      216  0.0  0.0  48   0 ?  IW   Jan 27  0:14  inetd
```

where 216 represents the process number of `inetd`.

Now that you know the process number, enter the following command line to make `inetd` re-read its configuration file:

```
host: kill -HUP 216
```

### 6.4.3 Adding an Entry for Your Switch in the `bootptab` File

On the workstation that is the `bootp` server, add the following lines to `/etc/bootptab`:

**NOTE:** The lines given here are an example. See the descriptions that follow for an explanation of the values that you need to enter on your SCP.

```
myswitch:\
:ht=ether:\
:ha=002048200097:\
:sm=255.255.255.0:\
:bf=upgrade-file:
```

**NOTE:** Make sure the last line added to bootptab ends in a colon (:) and not a backslash (\). Otherwise, that line will merge with the next entry, causing your switch to cycle in its attempts to find a bootp server.

The variables in the previous example are defined as follows:

- myswitch** Indicates the name you have assigned to your SCP.
- ht** Indicates the hardware type. For the purposes of switch software image loading, this is ether (stands for Ethernet).
- ha** Indicates the hardware address. This is the Ethernet MAC address of your SCP that is burned in from the factory. If you connect a terminal device to the SCP's serial port, you will see the Ethernet MAC address displayed during the EPROM boot sequence.
- sm** Indicates the subnet mask. This is the subnet mask for your network.
- bf** Indicates the bootfile. This is <your boot image file name>.

**NOTE:** For more information about bootp, please refer to RFC-1048 and RFC-951.

Once these lines are added, the bootp server will be able to tell your SCP where to find the switch software image to be downloaded. The next step in performing the upgrade is to set up a workstation as a tftpboot server and put the upgrade file (the line indicated by bf in the previous example) there.

### 6.4.4 Setting Up a tftpboot Server

To set up a tftpboot server, on a SunOS 4.1.x system, perform the following steps:

**NOTE:** This procedure only has to be done the first time that the switch is turned on and each SCP is upgraded. The next time that the software is upgraded, put the upgrade file in /tftpboot.

1. In /etc/inetd.conf, uncomment the last line shown below so that the file appears as follows:

```
#
# Tftp service is provided primarily for booting.  Most sites
# run this only on machines acting as "boot servers."
# Since these can be security holes, they are commented out by default.
#
tftp dgram udp wait root /usr/etc/in.tftpd in.tftpd /tftpboot
```

2. Add the following line to /etc/services:

```
tftp          69/udp
```

3. Set up the tftpboot directory with the following command lines:

```
host: mkdir /tftpboot
host: cp <upgrade-file> /tftpboot
```

4. At the root level, determine the process number of inetd by entering the following:

```
host: ps -aux | grep inetd
```

Something similar to the following will be displayed:

```
root          216  0.0  0.0  48   0 ?  IW   Jan 27  0:14  inetd
```

where 216 represents the process number of inetd.

5. Enter the following command to make inetd re-read its configuration file:

```
host: kill -HUP 216
```



# **APPENDIX A** Troubleshooting

The troubleshooting tests detailed in this appendix will clearly indicate and identify the most common problems in establishing ATM networks. Therefore, before calling Cabletron Systems' Technical Support, perform these tests to correct or at least pinpoint the problem.

If you need to call Technical Support, please have the results of these tests ready, in addition to the information requested in Section A.3, when reporting your problem.

## **A.1 Adapter Hardware Troubleshooting**

---

The flowchart in Figure A.1 illustrates the tests used to check the basic hardware functionality of a Cabletron Systems adapter, with the adapter card isolated from the network. The tools used to perform the tests are provided by Cabletron Systems and the computer hardware vendor. Each of the tests, indicated by the diamond-shaped blocks in Figure A.1, is described individually in the following subsections.

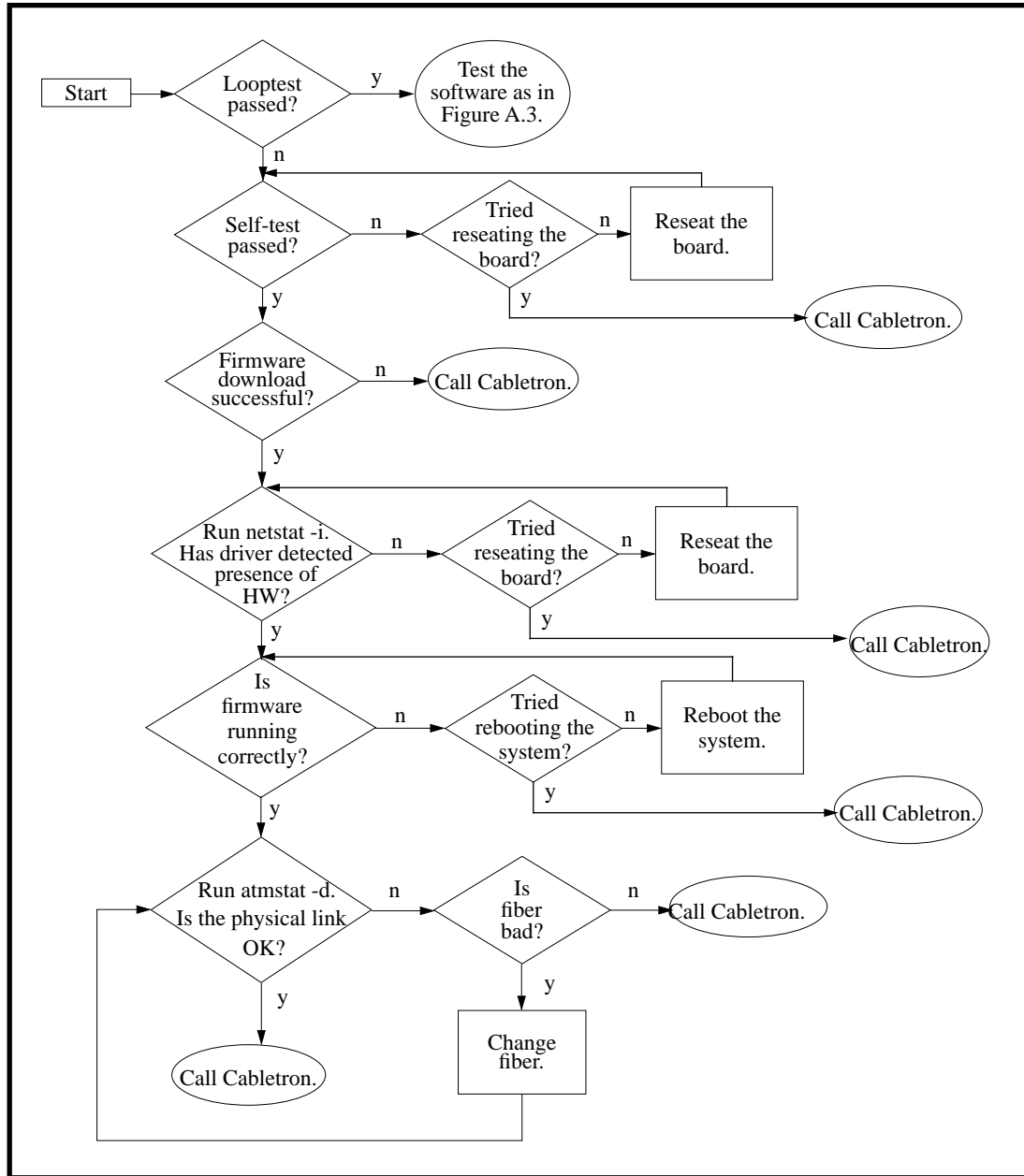

Figure A.1 - Adapter Hardware Troubleshooting Flowchart

### A.1.1 Run Looptest

To determine if an interface is functioning properly, run the looptest utility on a host that has been disconnected and isolated from the network.

**NOTE:** Before running looptest, the Receive and Transmit connectors on the backplate of the card must be connected to each other using a short loop of fiber-optic cable. This fiber should remain on throughout this test.

The looptest utility uses Cabletron Systems' ATM user-level Application Programming Interface. For proper operation, looptest requires read/write access to the ATM device. To run looptest, enter the following command at the system prompt in the working directory:

```
looptest fa0
```

where fa0 is the default device name for a single ATM adapter.

The looptest utility verifies that the board of an adapter is operating correctly. Correct operation means that all of the following conditions are true:

1. The self-test has been passed successfully.
2. The firmware has been downloaded successfully.
3. The driver has detected the existence of the hardware.
4. The firmware is running.
5. The physical link is up.

If looptest passes, then the board hardware of the adapter is OK. The next step is to test the software as shown in Figure A.3.

If looptest fails, the point of failure will be indicated by messages generated for each of the five items above. Refer to the following subsections for instructions about testing the individual items.

### **A.1.2 Check Self-Test (Automatically Performed)**

During a system boot, the ATM adapter automatically performs a self-test of the hardware, running a low-level diagnostic which checks memory read/write capability. Upon completion of the self-test, a message is printed to the console of the workstation indicating whether or not the hardware failed.

If the self-test is successful, proceed to the instructions regarding the firmware download as described in the next subsection.

If the self-test fails, reseal the board by performing the following steps to ensure that failure was not due to improper insertion of the board:

1. Halt the system, being sure to follow the procedures outlined in Chapter 2 of the User's Manual for the adapter.
2. Open the computer as shown in Chapter 2 of the User's Manual for the adapter, and reseal the board.
3. Reboot the system.

If the board still fails after a reseal, then it should be returned for repair. Call Cabletron Systems' Technical Support for further assistance.

### **A.1.3 Firmware Download (Automatically Performed)**

Before operating as an ATM interface, the firmware is automatically downloaded from the system RAM to the onboard i960 processor during host system boot. A message similar to: "XXX-200 initializing..." is displayed on the console, indicating that the board is being initialized. When the initialization is complete, success is indicated with the message "done" and failure is indicated with the message "failed".

If the download is successful, check to see if the hardware has been detected by the driver as described in the next subsection.

If the firmware failed to download, then there is most likely a hardware problem. Call Cabletron Systems' Technical Support for further assistance.

### A.1.4 Hardware Detected by Driver

To determine if the driver software on the host has detected the presence of an ATM adapter board, issue the following command once the host system has come up completely:

```
netstat -i
```

If the driver has located the ATM board, the screen output shows fa0 in response to the netstat command. If there is more than one adapter card, the next board will be named fa1, and so on. If you have configured a Classical IP interface, this will also be shown. The option -i shows the state of interfaces that were auto-configured, as happens when the Cabletron software is loaded and run upon system boot. Interfaces statically configured in a system, but not located at boot time, are not shown.

If the driver does not see the ATM board, no response will be given. Reseat the board by performing the following steps to ensure that failure was not due to improper insertion of the board:

1. Halt the system, being sure to follow the procedures outlined in Chapter 2 of the User's Manual for the adapter.
2. Open the computer as shown in Chapter 2 of the User's Manual for the adapter, and reseat the board.
3. Reboot the system.

If the board still fails after a reseat, then it should be returned for repair. Call Cabletron Systems' Technical Support for further assistance.

### A.1.5 Check Firmware

To check whether or not the firmware is running correctly, issue the following command:

```
atmstat fa0 1
```

In this command, the last parameter "1", causes the command to be repeated at one-second intervals.

If the firmware is running correctly, the response will show Input, Output, and Error Statistics for the adapter in the following format:

```
PHY/ATM/AAL statistics:
      Output                Input                Errors
      ATM   AAL*           ATM   AAL*   4B5B   4B5B   ATM   AAL*   AAL*
      Cells CS-PDUs       Cells CS-PDUs Framing Hdr-CRC VPI/VCI Pay-CRC Proto
161747  153692   142289  134685     0     0     20     0     0
```

If the firmware is not running correctly, `atmstat` hangs and nothing is returned, indicating either a problem with the firmware, a problem with the board, or a severe software failure. Call Cabletron Systems' Technical Support for further assistance.

If the output shows zeros for all possible values, the firmware may not have been initialized. Try rebooting the system. If there is still a problem, call Cabletron Systems' Technical Support for further assistance.

## A.1.6 Check Physical Link

To see the carrier state of the board, issue the following command:

```
atmstat -d fa0
```

The -d option displays device statistics in the following format:

```
Device statistics:
  Buffer Allocation Failures
    Type 1          Type 2
  Small   Large   Small   Large   Receive Queue Full   Carrier
    0       0       0       0       0                   ON
```

If ON is displayed in the Carrier field, then the physical link is fine.

If the board does not see a carrier (OFF is displayed in the Carrier field), then there is either a problem with the loopback fiber or there is a hardware problem with the optical drivers on the board. Check the fiber. If the fiber is bad, replace the fiber and run `looptest` again. If the fiber is not bad, then call Cabletron Systems' Technical Support for further assistance.

Alternatively, if you have access to the back of the host and can see the LED displays on the adapter backplate, a red LED on the R (Receive port) also indicates carrier failure.

## A.2 Testing Network Connectivity Using PVCs

---

The network connectivity tests require that two ATM adapters be connected to an ATM switch fabric with PVCs (as shown in Figure A.2). The carrier lights should be extinguished on the adapters and on the switch fabric, indicating that the fibers are OK.

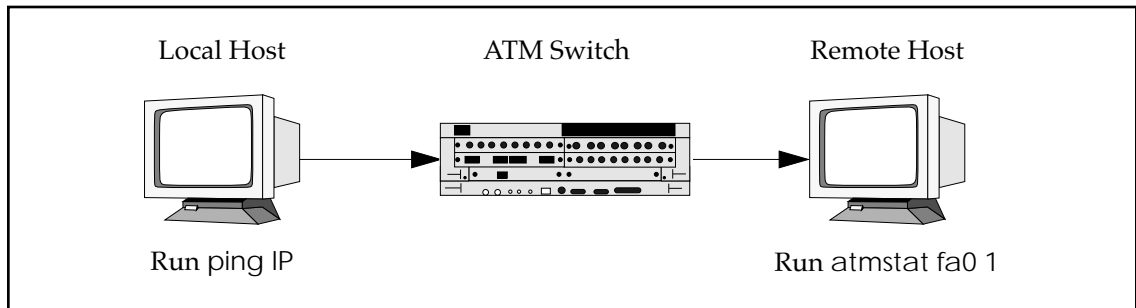

**Figure A.2** - Hardware Configuration for Checking PVCs

The network connectivity test suite, shown in Figure A.3, examines higher level functionality after basic adapter board performance has been verified by passing all the tests and checks shown in Figure A.1.



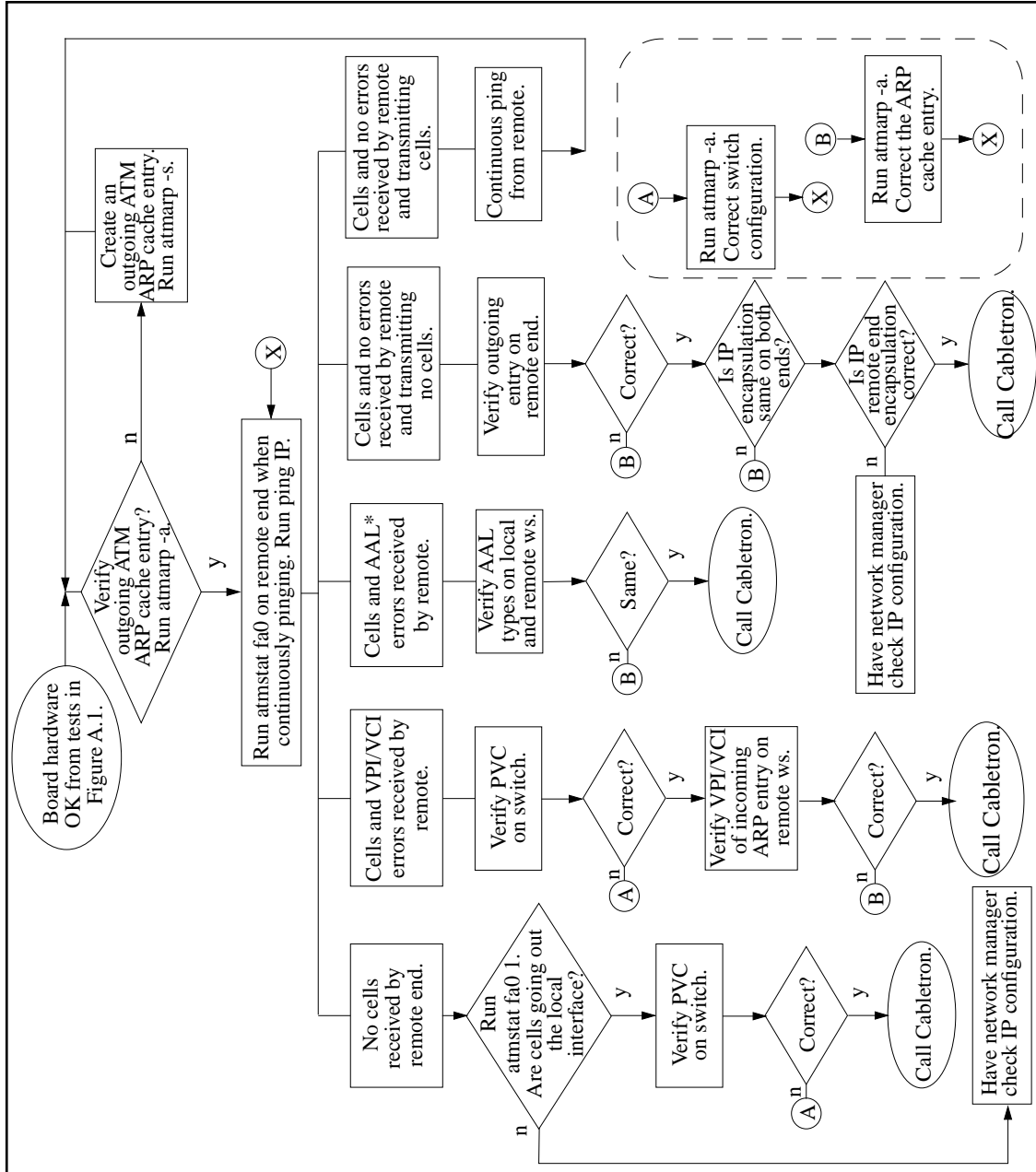

Figure A.3 - Networking Connectivity Using PVCs

This test sequence requires that the switch fabric be configured with a valid PVC and the endstations to have the proper IP configuration and ATM ARP cache entries. The tests in Figure A.3 assume that there is no IP connectivity between the two endstations. The lack of an IP connection is checked by trying a ping and getting no response (ping failed).

The tests in Figure A.3 also require that if a switch fabric is used, it is a Cabletron Systems switch fabric on which SPANS has been disabled on both the ports of the switch fabric and on the ATM endstations. SPANS must be disabled because it automatically creates ATM connections, which may alter the test results.

All of the failure conditions are the result of running a continuous ping with the following command:

```
ping <IP_address_of_remote_workstation>
```

## A.2.1 Verifying the Outgoing ATM ARP Entry

To verify the outgoing ATM ARP cache entry for the endstation originating the ping, enter the following command on the host:

```
atmarp -a
```

The following is an example of a typical ATM ARP cache display:

```
Outgoing connections:
fa0: ws2-atm (198.29.21.74): vpi.vci=0.100 aal=5
      switch.port=-.-
      flags=(PVC) encapsulation=NULL peak rate=(unlimited)
fa0: ws3-atm (198.29.21.94): vpi.vci=0.200 aal=5
      switch.port=-.-
      flags=(PVC) encapsulation=NULL peak rate=(unlimited)
Incoming connections:
fa0: switch.port=-.- vpi.vci=0.100 aal=5 flags=(PVC) decapsulation=NULL
fa0: switch.port=-.- vpi.vci=0.200 aal=5 flags=(PVC) decapsulation=NULL
```

Make sure the ARP cache entry does indeed match the IP address of the remote endstation and is using the PVC configured on the switch fabric.

If the prompt is returned with no information displayed, this indicates that the ATM ARP cache is empty.

Use the following two commands to create a PVC on the host:

```
./atmarp -s <hostname> <device> <vpi> <vci> <aal>
```

```
./atmarp -l <device> <vpi> <vci> <aal>
```

If the ATM ARP cache entry is valid, then perform the instructions in the next subsection for atmstat.

## A.2.2 atmstat

To determine a particular failure state, enter the following command on the remote workstation while continuously pinging:

**atmstat fa0 1**

PHY/ATM/AAL statistics:

Output		Input				Errors			
ATM	AAL*	ATM	AAL*	4B5B	4B5B	ATM	AAL*	AAL*	
Cells	CS-PDUs	Cells	CS-PDUs	Framing	Hdr-CRC	VPI/VCI	Pay-CRC	Proto	
161747	153692	142289	134685	0	0	20	0	0	

The failure states are determined by examining the output from the atmstat fa0 1 command string. The failures are classified by whether or not cells are sent (or received) and whether or not errors are received. The output shown below is typical of the first response from the atmstat fa0 1 command string. Succeeding lines of data continue in the same column format. Refer to the following subsections for a description of each type of failure.

#### A.2.2.1 No Cells Received by Remote End

If no cells are received by the remote end (the Input ATM Cells field displays zero), then run the following command on the local machine to verify that cells are going out to the ATM interface:

```
atmstat fa0 1
```

If there are no cells going out (the ATM Output Cells field shows zero), then there is most likely an IP routing problem rather than an ATM problem. Please have your network administrator check the IP configuration.

If cells are going out (the ATM Output Cells field shows a value other than zero), then the PVC on the switch fabric may be configured incorrectly. Check the PVC configuration. If it is not set up properly, then correct the PVC and rerun the test. If the PVC is configured correctly and the error persists, call Cabletron Systems' Technical Support for further assistance.

#### A.2.2.2 Cells and VPI/VCI Errors Received by Remote

If the remote workstation is receiving cells and is receiving VPI/VCI errors, then this indicates that cells are coming into the workstation, but are on a VPI/VCI that may not be configured correctly.

Check the PVC configuration. If it is not set up properly, then correct the PVC and rerun the test. If the PVC is configured correctly and the error persists, then the incoming ARP entry on the remote workstation is most likely the problem. List the ATM ARP cache using `atmarp -a` and check the incoming ARP entry for that connection.

If the incoming ARP entry is not configured properly, then correct the configuration and rerun the test. If the incoming ARP entry is configured properly and the error persists, then call Cabletron Systems' Technical Support for further assistance.

#### A.2.2.3 Cells and AAL\* Errors Received by Remote

If the remote workstation is receiving cells and AAL\* errors, it is likely that the AAL types of the outgoing entry on the local workstation and the incoming entry on the remote workstation do not match. Check both ATM AAL types using `atmstat` to see if they match. If they are different, set the AAL parameter to the same type and rerun the test. If they match and the error persists, then call Cabletron Systems' Technical Support for further assistance.

#### **A.2.2.4 Cells and No Errors Received by Remote and Transmitting No Cells**

If the remote workstation is receiving cells with no errors, but is not transmitting any cells, then either the outgoing IP address on the remote end is incorrect or the IP encapsulation does not match on both ends. (A Classical IP PVC uses LLC/SNAP encapsulation while a regular PVC uses AAL5-based, Multiplexing-based (NULL) encapsulation).

First, check the outgoing IP address on the remote end using `atmarp -a`. If it is not configured properly, then correct the configuration and rerun the test. If the outgoing ARP entry is configured properly, then check to see if the IP encapsulation matches on both ends using `atmarp -a`.

If the IP encapsulation does not match on both ends, then correct the configuration and rerun the test. If the IP encapsulation matches on both ends and the error persists, then there may be an IP routing problem on the remote host.

The network administrator should verify the IP routing. If there is still a problem, then call Cabletron Systems' Technical Support for further assistance.

#### **A.2.2.5 Cells and No Errors Received by Remote and Transmitting Cells**

If the remote end is receiving cells with no errors and is transmitting cells in response, then the remote end is OK. Looking at Figure A.2, reverse the direction. From the remote host, start a continuous ping and then run these same tests starting again with Section A.2.1, Verifying the Outgoing ATM ARP Entry. Watch the results of these tests on the local host.

## A.3 Collecting Additional Information

Once basic adapter installation and network connectivity have been tested, this section explains how to obtain all of the additional information that you need to have ready before calling Cabletron Systems Technical Support. This information should exist either on-line (by redirecting the output to a file) or in hard copy form.

### A.3.1 Basic Information

The following basic network information is very useful in helping Cabletron Systems' Technical Support staff troubleshoot your problem:

1. Host platform configuration
  - Vendor name
  - Platform type
  - RAM (MB)
  - Disk drive size (approximate)
2. Patches installed (very important for SunOS and Solaris)
3. Network topology (physical configuration)
  - Sketch and FAX in, if possible

Please have your support contract ID number and serial number ready, also.

### A.3.2 Adapter Information

On the host, at a command line, type the following six commands and note the responses:

- `uname -a` (Shows operating system, and platform names and versions)
- `ifconfig fa0` (Shows adapter interface configuration)
- `netstat -nr` (Shows routing table with destinations, gateways, and flags)
- `netstat -in` (Shows device names and addresses, and usage information)
- `adinfo fa0` (Shows adapter device name and version information)
- `atmstat -d fa0` (Shows carrier state and a variety of error counters)

Typical responses are shown under each command. The responses from these commands enable support to gather sufficient information to resolve the majority of problems.

**NOTE:** The assumed adapter name in the examples is fa0. On your particular system, the adapter may have a different designation. To check the name of your adapter, use the command: netstat -in.

**uname -a**

```
IRIX beluga 5.3 11091812 IP22 mips
```

**ifconfig fa0**

```
fa0: flags=863<UP,BROADCAST,NOTRAILERS,RUNNING,MULTICAST>  
    inet 198.29.38.206 netmask 0xffffffff broadcast 198.29.38.255
```

**netstat -nr**

```
Routing tables
```

Destination	Gateway	Flags	Refcnt	Use	Interface
127.0.0.1	127.0.0.1	UH	3	2264661	lo0
198.29.24.0	198.29.16.74	UG	1	9751	fa0
default	192.88.243.19	UG	3	123714	ie0
198.29.16.0	198.29.16.54	U	29	10892307	fa0
204.95.89.0	198.29.16.28	UG	0	2080	fa0
198.29.25.0	192.88.243.19	UG	0	0	ie0
198.29.26.0	192.88.243.19	UG	0	2696	ie0
198.29.27.0	192.88.243.19	UG	0	7853	ie0
198.29.19.0	198.29.16.85	UG	0	0	fa0
192.88.243.0	192.88.243.54	U	350	9188789	ie0
204.120.44.0	192.88.243.19	UG	1	1677	ie0
198.29.28.0	198.29.16.8	UG	0	87706	fa0
198.29.29.0	198.29.16.2	UG	0	0	fa0
198.29.31.0	198.29.16.75	UG	5	16417	fa0
198.29.23.0	192.88.243.53	UG	6	122731	ie0



**netstat -in**

Name	Mtu	Network	Address	Ipkts	Ierrs	Opkts	Oerrs	Coll
ec0	1500	192.88.243	192.88.243.171	1173050	39926	509363	0	107115
fa0	9188	198.29.38	198.29.38.206	0	0	0	0	0
qaa0	9180	198.29.22	198.29.22.206	0	0	0	0	0
qaa1*9180	none	none		0	0	0	0	0
qaa2*9180	none	none		0	0	0	0	0
qaa3*9180	none	none		0	0	0	0	0
lo0	8304	127	127.0.0.1	32048	0	32048	0	0

**adinfo fa0**

FORE Systems Release: ForeThought\_3.0.1b (1.20)  
 fa0: esa-200 media=4b5b-100 hw=1.0.0 fw=2.3.0 serial=2 slot=0

**atmstat -d fa0**

Device statistics:

Buffer Allocation Failures				Receive Queue Full	Carrier
Type 1		Type 2			
Small	Large	Small	Large		
0	0	0	0	0	ON

### A.3.3 Switch Information

On the host, at a command line, type the following commands and note the responses:

- atmstat fa0 command
- netstat -ai command
- asxmon command
- cport command

Log in to the ATM Management Interface (AMI) and open a session on the switch fabric to check the following:

- configuration spans show
- configuration port show
- configuration uni30 show
- Configuration of Network Modules (TAXI, DS3, DS1, SONET, E3, E1, and/or J2)

Typical responses are shown under each command. The responses from these commands enables support to gather sufficient information to resolve the majority of problems.

#### atmstat fa0

PHY/ATM/AAL statistics:

Output		Input				Errors		
ATM	AAL*	ATM	AAL*	4B5B	4B5B	ATM	AAL*	AAL*
Cells	CS-PDUs	Cells	CS-PDUs	Framing	Hdr-CRC	VPI/VCI	Pay-CRC	Proto
476058	469354	276580	273789	0	0	0	0	0

#### netstat -ai

Name	Mtu	Network	Address	Ipkts	Ierrs	Opkts	Oerrs	Coll
ec0	1500	fore	gar-eth	1174803	39928	509563	0	107117
			ALL-SYSTEMS.MCAST.N					
			08:00:69:07:e3:93					
fa0	9188	198.29.38	198.29.38.206	0	0	0	0	0
			ALL-SYSTEMS.MCAST.N					
qaa0	9180	fore-sw	198.29.22.206	0	0	0	0	0
qaal*9180		none	none	0	0	0	0	0
lo0	8304	loopback	localhost	32072	0	32072	0	0
			ALL-SYSTEMS.MCAST.N					

**asxmon <switch\_name>**

```
ASX-200 switch up 3:35, 17 ports (9 active), software 2.3.5, hardware 1.1
port name      uptime VPs/max VCs/max   Kb/s   free   max   total Mb
B1 198.29.22.34 2:57 1/1 5/5      0     0 140000    847
B2 198.29.22.18 3:35 1/1 3/3      0     0 140000    141
C1 198.29.22.27 3:35 1/1 4/4      0     0 140000  83035
C2 198.29.22.3  3:35 1/1 4/4      0     0 140000    11
D1 198.29.22.2  3:35 1/1 2/2      0     0 100000    11
D2 198.29.22.11 3:35 1/1 3/3      0     0 100000    11
CTL 198.29.22.37 3:35 1/1 36/36   0     0  80000   203
```

**NOTE:** In the output above, the Kb/s and free columns do not contain valid data.

**cport <switch\_name>**

Input				Output								
Port	Type	Mb/s	State	Time	VPs	VCs	BW	Cells	VPs	VCs	BW	Cells
B1	user	100	down	19:08:15	1	2	100	0	1	2	100	137783
B2	user	100	down	19:08:15	1	2	100	0	1	2	100	137784
B3	user	100	up	19:08:15	1	3	100	141332	1	4	100	149078
B4	user	100	down	19:08:15	1	2	100	0	1	2	100	137784
C1	user	140	up	19:08:15	1	4	140	140569	1	3	140	148928
C2	net	140	up	02:44:38	1	7	140	1046 M	1	6	140	193732
C3	net	140	up	19:08:15	1	5	140	1297 M	1	6	140	455400
C4	user	140	up	19:06:57	1	5	140	138800	1	5	140	1046 M
CTL	user	80	up	19:08:13	1	22	80	1 M	1	22	80	1 M

The following commands are run by logging in to AMI and opening a session on the switch fabric. Enter the following parameters at the prompt for the type of network modules that are installed in your switch fabric:

**configuration spans show**

Port	VPI	State	Type	CDVT	Action	RemoteAddress
1C1	0	down	uni	250	tag	
1C2	0	down	uni	250	tag	
1C3	0	down	uni	250	tag	
1C4	0	up	uni	250	tag	169.144.60.108
1D1	0	down	uni	250	tag	
1D2	0	down	uni	250	tag	
1D3	0	down	uni	250	tag	
1D4	0	down	uni	250	tag	
1CTL	0	up	uni	0	tag	10.10.10.48

**configuration port show**

Port	Carrier	Mb/s	iVps	iVcs	iBw	oVps	oVcs	oBw	Model
1C1	no	155.0	1	4	155.0	1	4	155.0	OC3
1C2	no	155.0	1	4	155.0	1	4	155.0	OC3
1C3	no	155.0	1	4	155.0	1	4	155.0	OC3
1C4	yes	155.0	1	4	155.0	1	4	155.0	OC3
1D1	no	155.0	1	2	155.0	1	3	0.0	OC3
1D2	no	155.0	1	5	155.0	1	4	155.0	OC3
1D3	no	155.0	1	4	155.0	1	4	155.0	OC3
1D4	no	155.0	1	4	155.0	1	4	155.0	OC3
1CTL	yes	80.0	1	28	0.0	1	36	0.0	ASX

**configuration uni30 show**

Port	VPI	State	ILMI	UNISide	Type	OperType	RemoteAddress
1C1	0	down	down	network	auto	privateUNI	
1C2	0	down	down	network	auto	privateUNI	
1C3	0	down	down	network	auto	privateUNI	
1C4	0	down	up	network	auto	privateUNI	169.144.64.108
1D2	0	down	down	network	auto	privateUNI	
1D3	0	down	down	network	auto	privateUNI	
1D4	0	down	down	network	auto	privateUNI	
1CTL	0	up	down	network	auto	privateUNI	

**configuration port taxi show**

Port	Carrier	State	Obuf	Version	Loopback	Model
1B1	yes	up	256	B	none	NM-B-TAXI-100-6PT
1B2	yes	up	256	B	none	NM-B-TAXI-100-6PT
1B3	yes	up	256	B	none	NM-B-TAXI-100-6PT
1B4	yes	up	256	B	none	NM-B-TAXI-100-6PT
1B5	no	down	256	B	none	NM-B-TAXI-100-6PT
1B6	no	down	256	B	none	NM-B-TAXI-100-6PT

**configuration port ds3 show**

Port	Carrier	Status	Mode	Framing	Loopback	ClockSrc	Scrambling	IdleCells	Length
1A1	no	0x80	hcs	cbit	diag	internal	off	unassigned	Gt225
1A2	no	0x24	plcp	cbit	none	internal	off	unassigned	Gt225

### configuration port ds1 show

Port	Carrier	Status	Mode	Framing	Loopback	ClockSource	LineLength	IdleCells
1C1	no	0x60	hcs	ESF	none	internal	Lt110	unassigned
1C2	no	0x60	hcs	ESF	none	internal	Lt110	unassigned

### configuration port sonet show

Port	Width	Carrier	Status	Line	Mode	Loopback	ClockSource	Scramb.	IdleCells
1A1	sts3c	no	0x2	SMM	sonet	none	internal	on	unassigned
1A2	sts3c	no	0x2	SMM	sonet	none	internal	on	unassigned
1A3	sts3c	yes	0x1	SMM	sonet	none	internal	on	unassigned
1A4	sts3c	no	0x2	SMM	sonet	none	internal	on	unassigned

### configuration e1 show

Port	Carrier	Status	Mode	LineType	Loopback	ClockSource	LineLength	IdleCells
1D1	yes	0x100	hcs	CRC	none	internal	Lt110	idle
1D2	yes	0x100	hcs	CRC	none	internal	Lt110	idle

### configuration port e3 show

Port	Carrier	Status	Mode	Loopback	ClockSource	Scrambling	IdleCells
1D1	no	0x72	hcs	none	internal	off	unassigned
1D2	no	0x72	hcs	none	internal	off	unassigned

### configuration port j2 show

Port	LineLength	Loopback	ClockSource
1D1	short	none	internal
1D2	short	none	internal
1D3	short	none	internal
1D4	short	none	internal

# **APPENDIX B** SCP Diagnostics

The tests provided in this section are very specific diagnostics that are only to be run if you have determined that there is a problem with your SCP. The diagnostics for the SFCS-200WG, SFCS-200BX, and SFCS-1000 are described first.

## **B.1 SFCS-200WG, SFCS-200BX, SFCS-1000 Diagnostics**

If you have determined that there is a hardware problem on a switch control processor (SCP), run the SCP diagnostics that are available by connecting a terminal device to that SCP's serial port.

**NOTE:** These diagnostics will only test the individual SCPs, not the switch fabrics themselves.

**NOTE:** All AMI sessions should be closed before these test are run.

**NOTE:** It is recommended that you back up your CDB before running any tests that check the FLASH and/or the SRAM. The chips are saved before testing each one and then restored. However, if a power failure would occur or if the switch were rebooted during the test, some of the data may not be restored properly.

### B.1.1 Accessing the Monitor Mode

To access the Monitor mode on an i960 SCP to run these tests, perform the following steps:

1. Soft boot the SCP by pressing the RESET button on the front panel of the SCP. Because the RESET button was designed to avoid accidental resets, you will need to use a straightened paper clip to push the RESET button.
2. Press the SELECT button on the front panel of the SCP. The display LED will cycle through the following parameters:

- 12:00 a.m.
- TTY Test
- DRAM 00-15 MB
- DRAM OK
- Timer T
- Clock T
- TEST BUS
- FLASH?

3. When the display LED shows FLASH?, press the NEXT button. ETHERNT? will be shown on the display LED.
4. Press the NEXT button again so that MONITOR? is shown on the display LED.
5. Press the SELECT button. The ? will disappear from MONITOR on the display LED, indicating that MONITOR has been chosen. The terminal device will indicate that user is in the SCP Debug Monitor.
6. Press the RETURN key on your terminal device's keyboard to get to the => prompt.
7. At the => prompt, type ? and press the RETURN key. The following menu will be displayed:

Available commands are:

```
he [cmd]      - help info for optional cmd
? [cmd]      - help info for optional cmd
ve           - print out version header
rs          - reset board, retaining baud rate
rb          - reset board and autobaud
```



```
do [offset]      - download using Xmodem
ps [address]    - single step through program, skipping procedure
                  calls
st [address]    - single step through program
go [address]    - go from start, or continue from breakpoint
fr address#times - display one or more real (32 bit) floating
                  point numbers
fl address#times - display one or more long real (64 bit)
                  floating point numbers
fx address#times - display one or more extended real (80 bit)
                  floating point numbers
da address#times - disassemble one or more instructions
db address#bytes - display one or more bytes
ds address#shrts - display one or more shorts
di address#words - display one or more words
dd address#times - display one or more sets of double words
dt address#times - display one or more sets of triple words
dq address#times - display one or more sets of quad words
re              - dump contents of registers
di reg         - display the contents of the register 'reg'
mo reg         - modify a register. Reg can NOT be fp0-fp3,
mo address#words - modify one or more words in memory
mb address     - modify a byte in memory (doesn't read byte first)
fi address address data - fill memory with data value
tr option on/off - turn on or off one of the following trace options
                  branch, call, return or supervisor call
br [address]    - set instruction break. If no address is given,
                  all current breakpoints are displayed
bd [address]    - set data breakpoint. If no address is given,
                  all current breakpoints are displayed
de address     - delete specified instruction or data breakpoint
                  - repeat previous command
test-clock     - test Real Time Clock
test-dram      - test DRAM
test-dc <bank> <chip> - test DRAM chip # <chip> in bank <bank>
test-ethernet  - test Ethernet
test-flash     - test Flash
test-fc <chip> - test Flash chip <chip>
test-serial    - test Serial Port
test-sram      - test SRAM
test-timer     - test Timer
test-all      - test all devices, except Flash and SRAM
test-manufact  - test all devices
```

## B.1.2 Running the Hardware Tests

This last portion from the displayed list is the group of hardware tests that the user can run on the SCP:

```
test-clock           - test Real Time Clock
test-dram            - test DRAM
test-dc <bank> <chip> - test DRAM chip # <chip> in bank <bank>
test-ethernet       - test Ethernet
test-flash           - test Flash
test-fc <chip>       - test Flash chip <chip>
test-serial          - test Serial Port
test-sram            - test SRAM
test-timer           - test Timer
test-all             - test all devices, except Flash and SRAM
test-manufact       - test all devices
```

Type the test command at the prompt to run the individual test. A test that completes correctly will be reported as "OK" on both the terminal connected to the serial port and on the display LED on the front panel of the SCP. A test that is not successful will be reported as "failure" on the terminal connected to the serial port and as "BAD" on the display LED. If any of the tests fail, contact Cabletron Systems' Technical Support.

The following subsections depict an example of how to perform each test through the serial port and the SCP's confirmation message to the terminal connected to the serial port that the test was successful. The user input is in *avant garde* font and the SCP's response is shown in *courier* font.

### B.1.2.1 Clock Test

This test checks the real time clock to verify that it is ticking correctly. It takes about two seconds to run.

```
=>test-clock
Clock: OK
```

### B.1.2.2 DRAM Test

This test checks the DRAM's functionality. It takes about two seconds to run.

```
=>test-dram
DRAM: OK
```

### B.1.2.3 DRAM Chip Test

This test checks the functionality of a DRAM chip. It takes about two seconds to run.

```
=>test-dc a  
DRAM chip: OK
```

### B.1.2.4 Ethernet Test

This test checks the functionality of the Ethernet chip. It takes about two seconds to run.

```
=>test-ethernet  
Ethernet: OK
```

### B.1.2.5 FLASH Test

This test checks the functionality of each FLASH chip. It takes about five minutes to run.

**NOTE:** It is recommended that you back up your CDB before running this test. The chips are saved before testing each one and then restored. However, if a power failure would occur or if the switch were rebooted during the test, some of the data may not be restored properly.

```
=>test-flash  
Flash Test  
Save Chip 0
```

```
Erase Chip  
Pattern 0
```

```
Erase Chip  
Pattern 1
```

```
Erase Chip  
Pattern 2
```

```
Erase Chip  
Pattern 3  
.
```

```
.  
.
Erase Chip
Pattern 1

Erase Chip
Pattern 2

Erase Chip
Pattern 3
Flash: OK
```

#### **B.1.2.6 FLASH Chip Test**

This test checks the functionality of an individual FLASH chip. It takes about one and a half minutes to run.

**NOTE:** It is recommended that you back up your CDB before running this test. The chip is saved before it is tested and then restored. However, if a power failure would occur or if the switch were rebooted during the test, some of the data may not be restored properly.

```
=>test-fc 1
Save Chip 1

Erase Chip
Pattern 0

Erase Chip
Pattern 1

Erase Chip
Pattern 2

Erase Chip
Pattern 3
Flash: OK
```

**B.1.2.7 Serial Port Test**

This test checks the serial port's functionality. It takes about two seconds to run.

```
=>test-serial  
Serial: OK
```

**B.1.2.8 SRAM Test**

This test checks the SRAM's functionality. It takes about two seconds to run.

**NOTE:** It is recommended that you back up your CDB before running this test. The SRAM is saved before testing and then restored. However, if a power failure would occur or if the switch were rebooted during the test, some of the data may not be restored properly.

```
=>test-sram  
SRAM: OK
```

**B.1.2.9 Timer Test**

This test checks to see if the timer is counting correctly. It takes about two seconds to run.

```
=>test-timer  
Timer: OK
```

**B.1.2.10 Hardware Test**

This series of tests checks the functionality of all of the hardware devices in the SCP, except the FLASH chips and SRAM. It takes about fifteen seconds to run.

```
=>test-all  
Clock: OK  
DRAM: OK  
Ethernet: OK  
Timer: OK  
    }Serial: OK
```

### B.1.2.11 Complete Hardware Test

This series of tests checks the functionality of all of the hardware devices, in the SCP including the FLASH chips and SRAM. It takes about six minutes to run.

**NOTE:** It is recommended that you back up your CDB before running this test. The chips are saved before testing each one and then restored. However, if a power failure would occur or if the switch were rebooted during the test, some of the data may not be restored properly.

```
=>test-manufact
Clock: OK
DRAM: OK
Ethernet: OK
Timer: OK
      }Serial: OK
SRAM: OK
Flash Test
.
.
.
Erase Chip
Pattern 1

Erase Chip
Pattern 2

Erase Chip
Pattern 3
Flash: OK
```

# **APPENDIX C** Hardware Specifications

This appendix provides information about the hardware for all of Cabletron Systems' ATM products. Information provided includes fiber-optic and UTP cabling specifications; pinout specifications; and hardware and general operating specifications. The products described in this appendix include the following:

- Cabletron ATM Switches
- ATM Network Modules
- ATM Adapters

## **C.1 Cabletron ATM Switches**

---

Cabletron Systems offers a complete line of ATM switches that provide scalable ATM connectivity ranging from desktop-to-desktop connections to those spanning wide area networks. Cabletron ATM switches provide high-performance, high-reliability ATM connectivity for LAN workgroup and desktop applications, LAN backbone applications, and LAN/WAN internetworking applications. Together with the Cabletron series of ATM LAN and WAN network nodules, these switches meet the networking demands of today's distributed, time-critical applications.

All of the Cabletron ATM switches deliver high-performance switching capacity and speed for ATM applications. A non-blocking switching capacity of 2.5 Gbps is continually available on the SFCS-200WG, or the SFCS-200BX. Each switch provides up to 4 ports of connectivity, each running at speeds up to 622 Mbps; or up to 16 ports, each running at speeds up to 155 Mbps; or up to 24 ports, each running at speeds up to 100 Mbps. The ASX-1000 provides 10 Gbps of switching capacity for up to 16 ports of connectivity, each running at speeds up to 622 Mbps; or up to 64 ports, each running at speeds up to 155 Mbps; or up to 96 ports, each running at speeds up to 100 Mbps.

This section provides an overview of the Cabletron Systems family of ATM switches. It details operating, environmental, and general specifications, as well as the hardware requirements necessary to use the different switches.

### C.1.1 SFCS-200WG

The SFCS-200WG ATM switch has the following specifications:

Features	Specification
<b>Switching Fabric</b>	2.5 Gbps, non-blocking
<b>Number of Ports</b>	12 to 24 ports
<b>Traffic Policing</b>	UPC, dual leaky bucket support
<b>Switch Transit Delay</b>	< 10 microseconds
<b>Connection Setup Time</b>	< 10 milliseconds, 100 calls/second
<b>Control Processor</b>	i960 CA switch control processor
<b>Maximum Port Speed</b>	622 Mbps (OC-12/STM-4c)
<b>Ethernet Interface</b>	Standard RJ-45 connector
<b>Serial Interface</b>	DB-9 female connector
<b>Power (nominal)</b>	90 - 270VAC @ 47 - 63Hz, 2.2 amps maximum (198 - 594 watts)
<b>Dimensions</b>	H: 4.75" (12.1 cm), W: 17.5" (44.5 cm), D: 18" (45.7 cm)
<b>Weight</b>	27.6 lbs (12.5 kg) maximum
<b>General Specifications</b>	
<b>Standards Compliance</b>	ITU I.361 ATM Layer, ATM Forum UNI v3.0
<b>Emissions</b>	FCC Part 15, Class A; CISPR 22, Class A; VCCI Class 1
<b>Safety</b>	US: UL 1950; Canada: CSA 22.2; No. 950-M89; Europe: EN 60950
<b>Operating Temperature</b>	5°C to 40°C up to 10,000 ft
<b>Operating Humidity</b>	10 - 90% relative humidity, non-condensing
<b>Storage Temperature</b>	-40°C to 70°C up to 30,000 ft
<b>Storage Humidity</b>	5 to 95% relative humidity, non-condensing



### C.1.2 SFCS-200BX

The SFCS-200BX ATM switch has the following specifications:

Features	Specification
<b>Switching Fabric</b>	2.5 Gbps, non-blocking
<b>Number of Ports</b>	2 to 24 ports
<b>Traffic Policing</b>	UPC, dual leaky bucket support
<b>Switch Transit Delay</b>	< 10 microseconds
<b>Connection Setup Time</b>	< 10 milliseconds, 100 calls/second
<b>Control Processor</b>	i960 CF switch control processor
<b>Maximum Port Speed</b>	622 Mbps (OC-12/STM-4c)
<b>Ethernet Interface</b>	Standard RJ-45 connector
<b>Serial Interface</b>	DB-9 female connector
<b>Power (nominal) - AC</b>	90 - 270VAC @ 47 - 63Hz, 2.2 amps maximum (198 - 594 watts)
<b>DC</b>	36 - 76 VDC, 10 amps maximum
<b>Dimensions</b>	H: 4.75" (12.1 cm), W: 17.5" (44.5 cm), D: 18" (45.7 cm)
<b>Weight</b>	43 lbs (19.5 kg) maximum
<b>General Specifications</b>	
<b>Standards Compliance</b>	ITU I.361 ATM Layer, ATM Forum UNI v3.0
<b>Emissions</b>	FCC Part 15, Class A; CISPR 22, Class A; VCCI Class 1
<b>Safety</b>	US: UL 1950; Canada: CSA 22.2; No. 950-M89; Europe: EN 60950
<b>Operating Temperature</b>	5°C to 40°C up to 10,000 ft
<b>Operating Humidity</b>	10 - 90% relative humidity, non-condensing
<b>Storage Temperature</b>	-40°C to 70°C up to 30,000 ft
<b>Storage Humidity</b>	5 to 95% relative humidity, non-condensing

### C.1.3 SFCS-1000

The SFCS-1000 ATM switch has the following specifications:

Features	Specification
<b>Switching Fabric</b>	10 Gbps, non-blocking
<b>Number of Ports</b>	2 to 96 ports
<b>Traffic Policing</b>	UPC, dual leaky bucket support
<b>Switch Transit Delay</b>	< 11 microseconds
<b>Connection Setup Time</b>	< 10 milliseconds, 100 calls/second
<b>Control Processor</b>	i960 CF (multiple) switch control processor
<b>Maximum Port Speed</b>	622 Mbps (OC-12/STM-4c)
<b>Ethernet Interface</b>	Standard RJ-45 connector
<b>Serial Interface</b>	DB-9 female connector
<b>Power (nominal) (Model A)</b>	97 - 264VAC @ 47 - 63Hz, 12 amps maximum 36 to 72VDC, 20 amps maximum
<b>Power (nominal) (Model B)</b>	100-120VAC @ 50 - 60Hz, 12 amps maximum 200-240VAC @ 50 - 60Hz, 6.5 amps maximum
<b>Dimensions</b>	H: 24.5" (62.2 cm), W: 19" (48.3 cm), D: 18" (45.7 cm)
<b>Weight</b>	112 lbs (51 kg)
<b>General Specifications</b>	
<b>Standards Compliance</b>	ITU I.361 ATM Layer, ATM Forum UNI v3.0
<b>Emissions</b>	FCC Part 15, Class A; CISPR 22, Class A; VCCI Class 1
<b>Safety</b>	US: UL 1950; Canada: CSA 22.2; No. 950-M89; Europe: EN 60950
<b>Operating Temperature</b>	5°C to 40°C up to 10,000 ft
<b>Operating Humidity</b>	10 - 90% relative humidity, non-condensing
<b>Storage Temperature</b>	-40°C to 70°C up to 30,000 ft
<b>Storage Humidity</b>	5 to 95% relative humidity, non-condensing

## C.2 ATM Network Modules

The LAN and WAN network modules are the physical ATM port interface cards that provide LAN/WAN connectivity to other ATM switches, ATM-compatible desktop computers and servers, hubs, routers, multiplexers, and carrier ATM services. Currently, network modules are available to provide ATM connections ranging from 1.5 Mbps to 622 Mbps over both fiber-optic and copper media.

This section details the technical specifications for each of the network modules. All network modules are hot-swappable, reducing network and maintenance downtime. For complete information about hot-swapping network modules, please refer to Chapter 3, Hardware Maintenance Procedures, in this manual.

### C.2.1 100 Mbps TAXI Module

The following specifications apply to network modules NM-6/100SCC and NM-6/100STC:

Description	Specification
<b>Port Capacity</b>	Six TAXI ports per module
<b>Data Rate</b>	100 Mbps
<b>Output Buffer</b>	13,312 cell capacity
<b>Media</b>	Multimode fiber
<b>Max. Line Length</b>	~2 km
<b>Connectors</b>	ST or dual SC
<b>Line Encoding</b>	4B/5B
<b>Loopbacks</b>	Transmit and receive loopbacks
<b>Power</b>	-14 to -20 dBm transmit, -14 to -30 dBm receive, 0 to 10 dB path attenuation
<b>Core Diameter</b>	62.5 $\mu\text{m}$
<b>Fiber Diameter</b>	125 $\mu\text{m}$
<b>Wavelength</b>	1310 nm
<b>Statistics</b>	TAXI statistics including Header Check Sequence (HCS) errors
<b>Compliance</b>	ATM Forum TAXI UNI v3.1, ITU-T I.432, ANSI X3T9.5, ISO DIS9314-3

## C.2.2 155 Mbps OC-3c/STM-1 MM Module

The following specifications apply to network modules NM-4/155MMSCC and NM-4/155MMSTC:

Description	Specification
<b>Port Capacity</b>	Four SONET/SDH ports per module
<b>Data Rate</b>	155.52 Mbps
<b>Output Buffer</b>	13,312 cell capacity
<b>Media</b>	Multimode fiber
<b>Max. Line Length</b>	~2 km
<b>Connectors</b>	ST or dual SC
<b>Line Encoding</b>	Non-Return to Zero (NRZ)
<b>Framing</b>	STS-3c/STM-1
<b>Clock Accuracy</b>	±20 ppm
<b>Timing</b>	Internal timing or per port network timing
<b>Loopbacks</b>	Transmit and receive loopbacks
<b>Power</b>	-14 to -20 dBm transmit, -14 to -30 dBm receive, 0 to 10 dB path attenuation
<b>Core Diameter</b>	62.5 µm
<b>Fiber Diameter</b>	125 µm
<b>Wavelength</b>	1310 nm
<b>Statistics/Alarms</b>	SONET/SDH statistics include Loss of Signal (LOS), Loss of Frame (LOF), Loss of Pointer (LOP), Far End Block Errors (FEBE), Alarm Indication Signal (AIS), Far End Receive Failure (FERF), Yellow Alarm, Bit Interleaved Parity errors (Line BIP-24, Section BIP-8, Path BIP-8), Header Check Sequence (HCS) errors
<b>Compliance</b>	ATM Forum STS-3c UNI v3.1, ITU-T I.432, ANSI T1E1.2/93-020, T1S1/92-185, ITU-T G.957, Bellcore TR-NWT-000253

### C.2.3 155 Mbps STS-3c/STM-1 UTP Module

The following specifications apply to network modules NM-4/155UTP5EC and NM-4/155UTP5C:

Description	Specification
<b>Port Capacity</b>	Four SONET/SDH ports per module
<b>Data Rate</b>	155.52 Mbps
<b>Output Buffer</b>	2,560 or 13,312 cell capacity
<b>Media</b>	Category 5 Unshielded Twisted Pair (UTP)
<b>Max. Line Length</b>	100 m
<b>Connectors</b>	RJ-45
<b>Line Encoding</b>	Non-Return to Zero (NRZ)
<b>Framing</b>	STS-3c/STM-1
<b>Clock Accuracy</b>	±20 ppm
<b>Timing</b>	Internal timing or per port network timing
<b>Loopbacks</b>	Transmit and receive loopbacks
<b>Statistics/Alarms</b>	SONET/SDH statistics include Loss of Signal (LOS), Loss of Frame (LOF), Loss of Pointer (LOP), Far End Block Errors (FEBE), Alarm Indication Signal (AIS), Far End Receive Failure (FERF), Yellow Alarm, Bit Interleaved Parity errors (Line BIP-24, Section BIP-8, Path BIP-8), Header Check Sequence (HCS) errors
<b>Compliance</b>	ATM Forum STS-3c UNI v3.1, ITU-T I.432, ANSI T1E1.2/93-020, T1S1/92-185, ATM Forum AF-PHY-0015.000

**C.2.3.1 155 Mbps UTP Pinout Specifications**

155 Mbps UTP network modules have a standard RJ-45 female connector and use RJ-45 network equipment pinouts as illustrated in the table below:

Pin Number	Signal Mnemonic	Signal Name
1	RX+	Receive Data +
2	RX-	Receive Data -
3		Not Used
4		Not Used
5		Not Used
6		Not Used
7	TX+	Transmit Data +
8	TX-	Transmit Data -

**C.2.3.2 Connecting Switches with 155 Mbps UTP Network Modules**

When connecting switches using 155 Mbps UTP network modules, you need to use a category 5 UTP crossover cable with the following specifications:

- Pin 1 to pin 7 in both directions.
- Pin 2 to pin 8 in both directions.

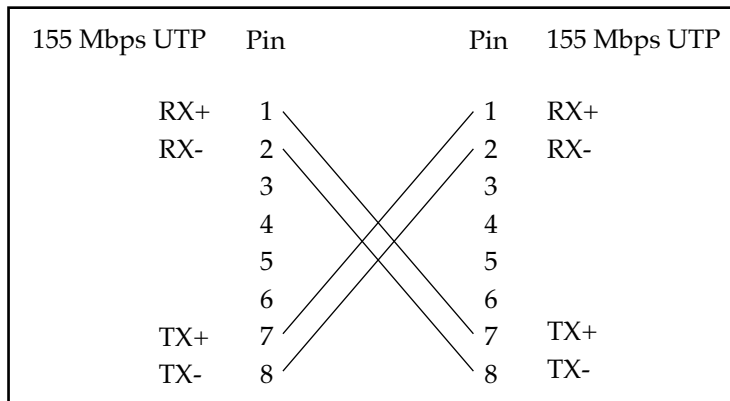

### C.2.4 622 Mbps OC-12c/STM-4c MM Module

The following specifications apply to network module NM-1/622MMSCC and NM-1/622MMSTC:

Description	Specification
<b>Port Capacity</b>	One SONET/SDH port per module
<b>Data Rate</b>	622.08 Mbps
<b>Output Buffer</b>	13,312 cell capacity
<b>Media</b>	Multimode fiber
<b>Max. Line Length</b>	500 m
<b>Connectors</b>	SC or ST
<b>Line encoding</b>	Non-Return to Zero (NRZ)
<b>Framing</b>	STS-12c/STM-4c
<b>Clock Accuracy</b>	±20 ppm
<b>Timing</b>	Primary and secondary 8kHz reference from internal (default) or network
<b>Loopbacks</b>	Transmit and receive loopbacks
<b>Power</b>	-20 to -14 dBm transmit power, -26 to -14 dBm receive sensitivity, 0 to 6 dB path attenuation for 62.5 μm fiber, 0 to 2 dB path attenuation for 50 μm fiber
<b>Core Diameter</b>	62.5 μm, 50 μm
<b>Fiber Diameter</b>	125 μm
<b>Wavelength</b>	1270 - 1380 nm
<b>Statistics/Alarms</b>	SONET/SDH statistics include Loss of Signal (LOS), Loss of Frame (LOF), Loss of Pointer (LOP), Far End Block Errors (FEBE), Alarm Indication Signal (AIS), Far End Receive Failure (FERF), Yellow Alarm, Bit Interleaved Parity (Line BIP-24, Section BIP-8, Path BIP-8) errors, Header Check Sequence (HCS) errors, cells received (RxCells), cells transmitted (TxCells)
<b>Compliance</b>	ATM Forum AF-PHY-0046.000, ITU-T I.432, ANSI T1E1.2/93-020, T1S1/92-185, ITU-T G.957, Bellcore TR-NWT-000253

### C.2.5 25 Mbps TP25 Module

The following specifications apply to network module NM-6/25UTPEC:

Description	Specification
<b>Port Capacity</b>	Six TP25 ports per module
<b>Data Rate</b>	25.6 Mbps
<b>Output Buffer</b>	2,560 cell capacity
<b>Media</b>	Cat. 3, 4, or 5 Unshielded Twisted Pair (UTP)
<b>Max. Line Length</b>	100 m
<b>Connector</b>	RJ-45
<b>Line Encoding</b>	4B/5B
<b>Clock Accuracy</b>	±100 ppm
<b>Timing</b>	Primary and secondary 8kHz reference from internal (default) or network
<b>Loopbacks</b>	Receive loopback
<b>Impedance</b>	100 ohms
<b>Statistics/Alarms</b>	Header Check Sequence (HCS) errors, cells received (RxCells), cells transmitted (TxCells), and symbol errors
<b>Compliance</b>	ATM Forum 25.6 Mbps specification AF-PHY-0040.000



**C.2.5.1 Connecting Switches with TP25 Network Modules**

The TP25 network modules have a standard RJ45 connector that uses pins 1, 2, 7 and 8. When connecting switches using TP25 network modules, you will need to use a UTP crossover cable with the following specification:

- Pin 1 to pin 7 in both directions.
- Pin 2 to pin 8 in both directions.

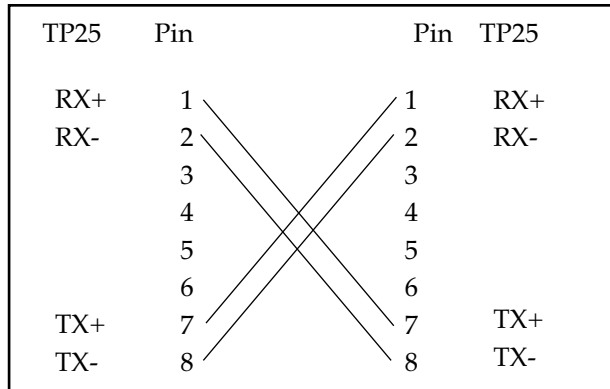

**C.2.5.2 Connecting Switches with Token Ring Pinouts to Cabletron Switches**

Although Cabletron Systems' Switches use the 1, 2, 7 and 8 pin assignment recommended by the ATM Forum, some switches use pins 3, 4, 5 and 6. Connecting one of these switches to a Cabletron Switch would require the connections to be mapped as follows:

- Pin 3 to pin 7 in both directions.
- Pin 4 to pin 1 in both directions.
- Pin 5 to pin 2 in both directions.
- Pin 6 to pin 8 in both directions.

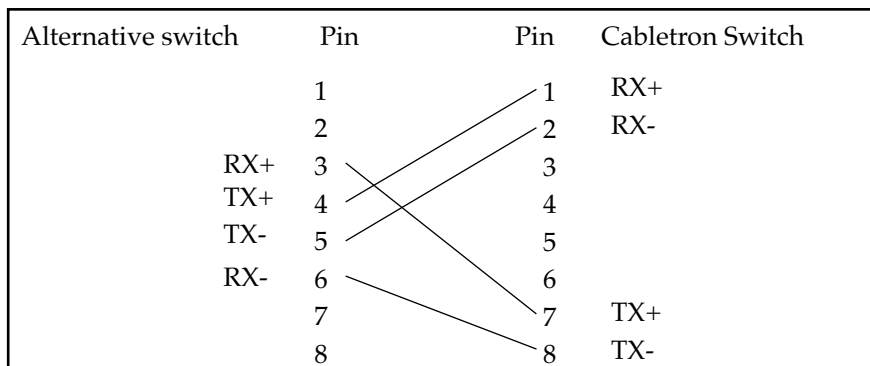

### C.2.5.3 Connecting Adapters with Token Ring Pinouts to Cabletron Switches

Like switches, some adapters use different pin assignments than those mentioned before. Connecting one of these adapters to a Cabletron Switch would require the connections to be mapped as follows:

- Pin 3 to pin 1 in both directions.
- Pin 4 to pin 7 in both directions.
- Pin 5 to pin 8 in both directions.
- Pin 6 to pin 2 in both directions.

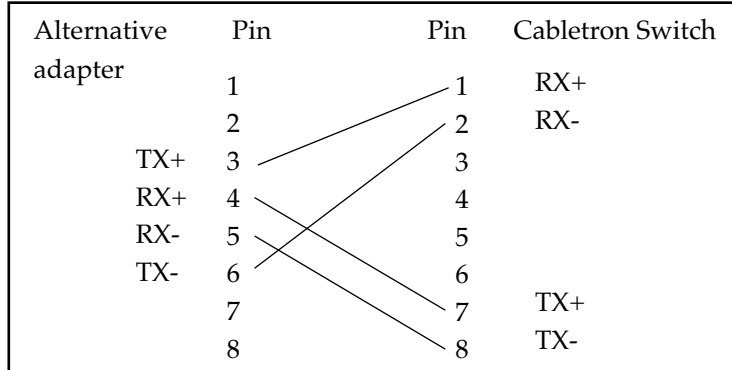

**NOTE:** The cable used in the connections shown in sections 2 and 3 above must be either a UTP-3 or UTP-5 bidirectional crossover cable, with 8-pin male RJ-45 modular connectors at each end.

### C.2.6 34 Mbps E3 Module

The following specifications apply to network modules NM-2/E3C and NM-4/E3C:

Description	Specification
<b>Port Capacity</b>	Two or four E3 ports per module
<b>Data Rate</b>	34.368 Mbps
<b>Output Buffer</b>	13,312 cell capacity
<b>Media</b>	Coaxial
<b>Max. Line Length</b>	~450 ft
<b>Connector</b>	BNC
<b>Line Encoding</b>	HDB3
<b>Framing</b>	Per ITU-T G.832 or G.751
<b>Clock Accuracy</b>	±20 ppm
<b>Timing</b>	Primary and secondary 8kHz reference from internal (default) or network
<b>Loopbacks</b>	Transmit and receive loopbacks
<b>Impedance</b>	75 ohms nominal
<b>Statistics/Alarms</b>	Line code violations (LCV), framing bit errors (FER), P-bit and C-bit errors, header check sequence (HCS) errors, cells received (RxCells), cells transmitted (TxCells), signal/clock detection, code violations, bit errors, parity errors, and AIS indication
<b>Compliance</b>	ATM Forum AF-PHY-94-0406 R5, ITU-T G.703, G.751, G.832, G.804

### C.2.7 45 Mbps DS3 Module

The following specifications apply to network modules NM-2/DS3C and NM-4/DS3C:

Description	Specification
<b>Port Capacity</b>	Two or four DS3 ports per module
<b>Data Rate</b>	44.736 Mbps
<b>Output Buffer</b>	13,312 cell capacity
<b>Media</b>	Coaxial
<b>Max. Line Length</b>	~450 ft
<b>Connector</b>	BNC
<b>Line Encoding</b>	B3ZS
<b>Framing</b>	C-bit parity or clear channel
<b>Clock Accuracy</b>	±20 ppm
<b>Timing</b>	Primary and secondary 8kHz reference from internal (default) or network
<b>Loopbacks</b>	Transmit and receive loopbacks
<b>Impedance</b>	75 ohms nominal
<b>Statistics/Alarms</b>	Line code violations (LCV), framing bit errors (FER), P-bit and C-bit errors, header check sequence (HCS) errors, cells received (RxCells), cells transmitted (TxCells), signal/clock detection, and AIS indication
<b>Compliance</b>	ATM Forum DS3 UNI v3.1, ANSI/Bellcore T1.102, T1.107, TR-TSY-000009

### C.2.8 155 Mbps OC-3c/STM-1 SM Module

The following specifications apply to network modules NM-4/155SMSRC and NM-4/155SMLRC:

Description	Specification
<b>Port Capacity</b>	Four SONET/SDH ports per module
<b>Data Rate</b>	155.52 Mbps
<b>Output Buffer</b>	13,312 cell capacity
<b>Media</b>	Short or long reach single mode fiber
<b>Max. Line Length</b>	~2 km (short reach); ~40 km (long reach)
<b>Connectors</b>	FC
<b>Line Encoding</b>	Non-Return to Zero (NRZ)
<b>Framing</b>	STS-3c/STM-1
<b>Clock Accuracy</b>	±20 ppm
<b>Timing</b>	Primary and secondary 8kHz reference from internal (default) or network
<b>Loopbacks</b>	Transmit and receive loopbacks
<b>Power - Short Reach</b>	-8 to -15 dBm transmit power, -8 to -23 dBm receive sensitivity, 0 to 8 dB path attenuation
<b>Power - Long Reach</b>	0 to -5 dBm transmit power, -10 to -34 dBm receive sensitivity, 10 to 29 dB path attenuation
<b>Core Diameter</b>	10 µm
<b>Fiber Diameter</b>	125 µm
<b>Wavelength</b>	1310 nm
<b>Statistics/Alarms</b>	SONET/SDH statistics include Loss of Signal (LOS), Loss of Frame (LOF), Loss of Pointer (LOP), Far End Block Errors (FEBE), Alarm Indication Signal (AIS), Far End Receive Failure (FERF), Yellow Alarm, Bit Interleaved Parity errors (Line BIP-24, Section BIP-8, Path BIP-8), Header Check Sequence errors (HCS)
<b>Compliance</b>	ATM Forum STS-3c UNI v3.1, ITU-T I.432, ANSI T1E1.2/93-020, T1S1/92-185, ITU-T G.957, Bellcore TR-NWT-000253

### C.2.9 155 Mbps OC-3c/STM-1 3MM/1SM Module

The 155 Mbps OC-3c/STM-1 3MM/1SM network module contains one SONET/SDH single mode port (port 4) and three SONET/SDH multimode ports (ports 1, 2, and 3) per module.

The following specifications apply to port 4 on network modules NM-4/155SR3SCC and NM-4/155LR3SCC:

Description	Specification
<b>Data Rate</b>	155.52 Mbps
<b>Output Buffer</b>	13,312 cell capacity
<b>Media</b>	Short or long reach single mode fiber
<b>Max. Line Length</b>	~2 km (short reach); ~40km (long reach)
<b>Connectors</b>	FC
<b>Line Encoding</b>	Non-Return to Zero (NRZ)
<b>Framing</b>	STS-3c/STM-1
<b>Clock Accuracy</b>	±20 ppm
<b>Timing</b>	Primary and secondary 8kHz reference from internal (default) or network
<b>Loopbacks</b>	Transmit and receive loopbacks
<b>Power - Short Reach</b>	-8 to -15 dBm transmit power, -8 to -23 dBm receive sensitivity, 0 to 8 dB path attenuation
<b>Power - Long Reach</b>	0 to -5 dBm transmit power, -10 to -34 dBm receive sensitivity, 10 to 29 dBm path attenuation
<b>Core Diameter</b>	10 µm
<b>Fiber Diameter</b>	125 µm
<b>Wavelength</b>	1310 nm
<b>Statistics/Alarms</b>	SONET/SDH statistics include Loss of Signal (LOS), Loss of Frame (LOF), Loss of Pointer (LOP), Far End Block Errors (FEBE), Alarm Indication Signal (AIS), Far End Receive Failure (FERF), Yellow Alarm, Bit Interleaved Parity errors (Line BIP-24, Section BIP-8, Path BIP-8), Header Check Sequence errors (HCS)
<b>Compliance</b>	ATM Forum STS-3c UNI v3.1, ITU-T I.432, ANSI T1E1.2/93-020, T1S1/92-185, ITU-T G.957, Bellcore TR-NWT-000253

The following specifications apply to ports 1, 2, and 3 on network modules NM-4/155SR3SCC and NM-4/155LR3SCC:

Description	Specification
<b>Data Rate</b>	155.52 Mbps
<b>Output Buffer</b>	13,312 cell capacity
<b>Media</b>	Multimode fiber
<b>Max. Line Length</b>	~2 km
<b>Connectors</b>	SC
<b>Line Encoding</b>	Non-Return to Zero (NRZ)
<b>Framing</b>	STS-3c/STM-1
<b>Clock Accuracy</b>	±20 ppm
<b>Timing</b>	Primary and secondary 8kHz reference from internal (default) or network
<b>Loopbacks</b>	Transmit and receive loopbacks
<b>Power</b>	-14 to -20 dBm transmit power, -14 to -30 dBm receive sensitivity, 0 to 10 dB path attenuation
<b>Core Diameter</b>	62.5 μm
<b>Fiber Diameter</b>	125 μm
<b>Wavelength</b>	1310 nm
<b>Statistics/Alarms</b>	SONET/SDH statistics include Loss of Signal (LOS), Loss of Frame (LOF), Loss of Pointer (LOP), Far End Block Errors (FEBE), Alarm Indication Signal (AIS), Far End Receive Failure (FERF), Yellow Alarm, Bit Interleaved Parity errors (Line BIP-24, Section BIP-8, Path BIP-8), Header Check Sequence errors (HCS)
<b>Compliance</b>	ATM Forum STS-3c UNI v3.1, ITU-T I.432, ANSI T1E1.2/93-020, T1S1/92-185, ITU-T G.957, Bellcore TR-NWT-000253

### C.2.10 622 Mbps OC-12c/STM-4c SM Module

The following specifications apply to network module NM-1/622SMIRC:

Description	Specification
<b>Port Capacity</b>	One SONET/SDH port per module
<b>Data Rate</b>	622.08 Mbps
<b>Output Buffer</b>	13,312 cell capacity
<b>Media</b>	Single mode fiber
<b>Max. Line Length</b>	~14 km
<b>Connectors</b>	FC
<b>Line Encoding</b>	Non-Return to Zero (NRZ)
<b>Framing</b>	STS-12c/STM-4c
<b>Clock Accuracy</b>	±20 ppm
<b>Timing</b>	Primary and secondary 8kHz reference from internal (default) or network
<b>Loopbacks</b>	Transmit and receive loopbacks
<b>Power</b>	-8 to -15 dBm transmit power, -8 to -28 dBm receive sensitivity, 0 to 13 dB path attenuation
<b>Core Diameter</b>	10 µm
<b>Fiber Diameter</b>	125 µm
<b>Wavelength</b>	1310 nm
<b>Statistics/Alarms</b>	SONET/SDH statistics include Loss of Signal (LOS), Loss of Frame (LOF), Loss of Pointer (LOP), Far End Block Errors (FEBE), Alarm Indication Signal (AIS), Far End Receive Failure (FERF), Yellow Alarm, Bit Interleaved Parity errors (Line BIP-24, Section BIP-8, Path BIP-8), Header Check Sequence errors (HCS), cells received (RxCells), cells transmitted (TxCells)
<b>Compliance</b>	ATM Forum STS-12c UNI v3.1, ITU-T I.432, ANSI T1E1.2/93-020, T1S1/92-185, ITU-T G.957, Bellcore TR-NWT-000253



## C.3 ATM Adapters

The family of ATM adapters provides a flexible ATM interface for the communications needs of today's high-speed workstations and personal computers.

### C.3.1 Adapter Cabling Specifications

#### C.3.1.1 Fiber-Optic Cable Specifications

The table below lists the recommended cable specifications for all ATM adapters that use fiber-optic cabling to ensure optimal adapter and switch performance:

Description	Specification for Multimode Products
Core Diameter	62.5 $\mu\text{m}$
Fiber Diameter	125 $\mu\text{m}$
Wavelength	1310 nm
Loss Characteristic	$\sim 0.5$ dB/km
Connector Style	SC or ST
Power Budget	11 dB *
Approximate Distance	2 km
Transmit Power	-19 dBm (minimum)
Receive Power	-30 dBm (minimum)
* If a 50 $\mu\text{m}$ core fiber is used, the power budget is derated by 4 dB.	

### C.3.1.2 UTP Cable Specifications

The table below lists the recommended cable specifications for all Cabletron ATM adapters that use UTP cabling to ensure optimal adapter and switch performance.

Description	Value
<b>AWG</b>	24
<b>Impedance (<math>\Omega</math>)</b>	100 $\pm$ 15%
<b>Attenuation (dB/1000 ft Max)</b>	25 dB @ 16 mHz 52 dB @ 62.5 mHz 67 dB @ 100 mHz
<b>Maximum Run</b>	100 m *
<b>Connector Style</b>	RJ-45
* Within the 100 meter run, a maximum of two connections are permissible.	

### C.3.1.3 UTP Pinouts

All ATM Adapters that can be connected using copper cabling use a standard RJ-45 connector with the following pinouts:

Number	Transmit/Receive
1	Transmit (+)
2	Transmit (-)
3	not used
4	not used
5	not used
6	not used
7	Receive (+)
8	Receive (-)

### C.3.2 ESA-200PC Technical Specifications

The ESA-200PC ATM Adapter provides ATM connectivity to EISA-based PCs and servers, and has the following specifications:

<b>Hardware</b>	
<b>Architecture</b>	On-board 25 Mhz i960 RISC processor
<b>AAL Support</b>	Special-purpose hardware for AAL5 and AAL3/4, HEC, and CRC calculations
<b>UNI</b>	100 Mbps TAXI (4B/5B encoding); 155Mbps OC-3/SONET STS-3c/SDH STM-1
<b>Form Factor</b>	Single-slot EISA bus, half-card
<b>Compliance</b>	ATM cell processing per ANSI T1S1.5/92-002R3, ITU I.361, and ATM Forum v3.0 UNI specification
<b>Cabling</b>	Duplex 62.5/125 $\mu$ m multimode fiber (2 km max. run, 10 dB loss); 2-pair 100 ohm CAT 5, or CAT 5 screened, UTP (100 meters max.)
<b>Connectors</b>	ST and SC Types for multimode fiber; RJ-45 for CAT 5 UTP copper
<b>Software</b>	
Transparent standard protocol interface NDIS 3.0, ODI Server	
SPANS Switched Virtual Circuits (SVCs) signaling protocol	
Permanent Virtual Circuits (PVCs)	
Supports up to 1024 Virtual Circuit Identifiers (VCIs)	
Support for UNI 3.0 signalling	
Support for LAN Emulation Clients	
<b>General</b>	
<b>Dimensions</b>	H: 0.6" x W: 5.0" x D: 9.4" (1.5 cm x 12.7 cm x 23.8 cm)
<b>Weight</b>	8.3 oz (235 g)
<b>Power Requirements</b>	2 amps (maximum) @ +5V
<b>Operating Temperature</b>	32°F to 104°F (0°C to 40°C)
<b>Operating Humidity</b>	20% to 80% non-condensing @ 40°C
<b>Compliance</b>	FCC Part 15, Class A Verification and UL 1950

### C.3.3 PCA-200PC Technical Specifications

The PCA-200PC ATM Adapter provides ATM connectivity to PCI-based PCs and servers, and has the following specifications:

<b>Hardware</b>	
<b>Architecture</b>	On-board 25 Mhz i960 RISC processor
<b>AAL Support</b>	Special-purpose hardware for AAL5 and AAL3/4, HEC, and CRC calculations
<b>UNI</b>	100 Mbps TAXI (4B/5B encoding); 155Mbps OC-3/SONET STS-3c/SDH STM-1
<b>Form Factor</b>	Single-slot PCI bus, half-card
<b>Compliance</b>	ATM cell processing per ANSI T1S1.5/92-002R3, ITU I.361, and ATM Forum UNI v3.0 specification
<b>Cabling</b>	Duplex 62.5/125 $\mu$ m multimode fiber (2 km max. run, 10 dB loss); 2-pair 100 ohm CAT 5, or CAT 5 screened, UTP (100 meters max.)
<b>Connectors</b>	ST and SC Types for multimode fiber; RJ-45 for CAT 5 UTP copper
<b>Software</b>	
Transparent standard protocol interface NDIS 3.0, ODI Server	
SPANS Switched Virtual Circuits (SVCs) signaling protocol	
Permanent Virtual Circuits (PVCs)	
Supports up to 1024 Virtual Circuit Identifiers (VCIs)	
Support for UNI 3.0 signalling	
Support for LAN Emulation Clients	
<b>General</b>	
<b>Dimensions</b>	H: 0.5" x W: 3.3" x D: 5.8" (1.3 cm x 8.4 cm x 14.7 cm)
<b>Weight</b>	6 oz (170 g)
<b>Power Requirements</b>	2 amps (maximum) @ +5V
<b>Operating Temperature</b>	32°F to 104°F (0°C to 40°C)
<b>Operating Humidity</b>	20% to 80% non-condensing @ 40°C
<b>Compliance</b>	FCC Part 15, Class A Verification and UL 1950

### C.3.4 PCA-200MAC Technical Specifications

The PCA-200MAC ATM Adapter provides ATM connectivity to PCI-based Apple Power Macintoshes, and has the following specifications:

<b>Hardware</b>	
<b>Architecture</b>	On-board 25 Mhz i960 RISC processor
<b>AAL Support</b>	Special-purpose hardware for AAL5 and AAL3/4, HEC, and CRC calculations
<b>UNI</b>	100 Mbps TAXI (4B/5B encoding); 155Mbps OC-3/SONET STS-3c/SDH STM-1
<b>Form Factor</b>	Single-slot PCI bus, half-card
<b>Compliance</b>	ATM cell processing per ANSI T1S1.5/92-002R3, ITU I.361, and ATM Forum UNI v3.0 specification
<b>Cabling</b>	Duplex 62.5/125 $\mu$ m multimode fiber (2 km max. run, 10 dB loss); 2-pair 100 ohm CAT 5, or CAT 5 screened, UTP (100 meters max.)
<b>Connectors</b>	ST and SC Types for multimode fiber; RJ-45 for CAT 5 UTP copper
<b>Software</b>	
Supports up to 1024 Virtual Circuit Identifiers (VCIs)	
Support for UNI 3.0 signalling	
Support for LAN Emulation Clients	
<b>General</b>	
<b>Dimensions</b>	H: 0.5" x W: 3.3" x D: 5.8" (1.3 cm x 8.4 cm x 14.7 cm)
<b>Weight</b>	6 oz (170 g)
<b>Power Requirements</b>	2 amps (maximum) @ +5V
<b>Operating Temperature</b>	32°F to 104°F (0°C to 40°C)
<b>Operating Humidity</b>	20% to 80% non-condensing @ 40°C
<b>Compliance</b>	FCC Part 15, Class A Verification and UL 1950

### C.3.5 NBA-200 Technical Specifications

The NBA-200 ATM Adapter provides ATM connectivity to 68040-based Macintosh workstations and servers with full-size NuBus slots, and has the following specifications:

<b>Hardware</b>	
<b>Architecture</b>	On-board 25 mHz i960 cell processor with VMEbus master burst transfer capability
<b>AAL Support</b>	Special purpose, on-board hardware for HEC, CRC, and AAL5 and AAL3/4 calculations
<b>UNI</b>	100 Mbps TAXI (4B/5B encoding); 155Mbps OC-3/SONET STS-3c/SDH STM-1
<b>Form Factor</b>	Single-slot NuBus (full-length)
<b>Compliance</b>	ATM cell processing per ANSI TSI 1.5/92-002R3, ITU I.361, ATM Forum v3.0 UNI specification, and ANSI IEEE NuBus Standard 1196-1987
<b>Cabling</b>	Duplex 62.5/125 $\mu$ m multimode fiber (2,000 meters maximum)
<b>Connectors</b>	ST and SC for multimode fiber; RJ-45 for CAT 5 UTP copper
<b>Software</b>	
Emulated EtherTalk Phase 2	
Enhanced-performance ATM Application Programming Interface (API) Library	
Transparent TCP/IP interface	
Multi-zone AppleTalk	
LAN Emulation Software 1.0	
Ethernet and AppleTalk support	
Control Panel GUI interface to user-level information on adapter status, ATM cell statistics, cell errors, and VCI/VPI information	
SNMP MIB access to adapter status, ATM cell statistics, cell errors, and VCI/VPI information	
<b>General</b>	
<b>Dimensions</b>	0.6" H (1.5 cm), 4.3" W (8.4 cm), 5.8" D (14.7 cm)
<b>Weight</b>	9 oz. (255g)
<b>Power Requirements</b>	2A max @ +5V
<b>Operating Temperature</b>	32°F to 104°F (0°C to 40°C)
<b>Operating Humidity</b>	20% to 80%, non-condensing @ 40°C
<b>Compliance</b>	FCC Part 15, Class A Verification, and UL 1950

### C.3.6 GIA-200 Technical Specifications

The GIA-200 ATM Adapter provides ATM connectivity to Silicon Graphics Indy and Indigo (R3K, R4K, and Challenge S supported) workstations, and has the following specifications:

<b>Hardware</b>	
<b>Architecture</b>	On-board 25 mHz i960 cell processor
<b>AAL Support</b>	Special purpose, on-board hardware for HEC, CRC, and AAL5 and 3/4 calculations
<b>UNI</b>	100 and 140 Mbps TAXI (4B/5B encoding); 155Mbps OC-3/SONET STS-3c/SDH STM-1
<b>Form Factor</b>	Single-slot GIO bus
<b>Compliance</b>	ATM cell processing per ANSI T1S1.5/92-002R3, ITU I.361, and ATM Forum v3.0 UNI specification
<b>Cabling</b>	Duplex 62.5/125 $\mu$ m multimode fiber (2 km max. run, 10 dB loss); 2-pair 100 ohm CAT 5, or CAT 5 screened, UTP (100 meters max.)
<b>Connectors</b>	ST and SC Types for multimode fiber; RJ-45 for CAT 5 UTP copper
<b>Memory</b>	256 kbytes on-board RAM
<b>DMA Support</b>	32-bit burst mode, bus master; "Fly-by," scatter-gather DMA support; Supports block transfers up to 16 words; Full 32-bit datapath
<b>Software</b>	
Transparent TCP/IP protocol interface	
Enhanced-performance ATM Application Programming Interface (API) Library	
SPANS Switched Virtual Circuit (SVC) signalling protocol	
Permanent Virtual Circuits (PVC), Supports up to 1024 Virtual Circuit Identifiers (VCIs)	
Application-controlled multicasting and broadcasting with recipient add and delete capabilities	
Support for UNI 3.0 signalling, ILMI, LAN Emulation Clients, Classical IP	
SNMP MIB access to adapter status, ATM cell statistics, cell errors, and VCI/VPI information	
<b>General</b>	
<b>Dimensions</b>	0.6" H x 3.375" W x 6.352" D (1.5 cm x 8.57 cm x 16.1 cm)
<b>Weight</b>	6 oz. (170 g)
<b>Power Requirements</b>	2A (maximum) @ +5V
<b>Operating Temperature</b>	32°F to 104°F (0°C to 40°C)
<b>Operating Humidity</b>	20% to 80%, non-condensing @ 40°C
<b>Compliance</b>	FCC Part 15, Class A Verification (UTP); FCC Class B Certification (fiber-optic connectors)

### C.3.7 HPA-200 Technical Specifications

The HPA-200 ATM Adapter provides ATM connectivity to the following machines: HP9000/715, HP9000/720, HP9000/725, HP9000/730, HP9000/735, HP9000/750, HP9000/755, and has the following specifications:

<b>Hardware</b>	
<b>Architecture</b>	On-board 25 mHz i960 cell processor
<b>AAL Support</b>	Special purpose, on-board hardware for HEC, CRC, and AAL5 and 3/4 calculations
<b>UNI</b>	100 and 140 Mbps TAXI (4B/5B encoding); 155Mbps OC-3/SONET STS-3c/SDH STM-1
<b>Form Factor</b>	Single-slot EISA bus
<b>Compliance</b>	ATM cell processing per ANSI T1S1.5/92-002R3, ITU I.361, and ATM Forum v3.0 UNI specification
<b>Cabling</b>	Duplex 62.5/125 $\mu$ m multimode fiber (2 km max. run, 10 dB loss); 2-pair 100 ohm CAT 5, or CAT 5 screened, UTP (100 meters max.)
<b>Connectors</b>	ST and SC Types for multimode fiber; RJ-45 for CAT 5 UTP copper
<b>Memory</b>	256 kbytes on-board RAM
<b>DMA Support</b>	32-bit burst mode, bus master; "Fly-by," scatter-gather DMA support; Supports block transfers up to 16 words; Full 32-bit datapath
<b>Software</b>	
Transparent TCP/IP protocol interface	
Enhanced-performance ATM Application Programming Interface (API) Library	
SPANS Switched Virtual Circuit (SVC) signalling protocol	
Permanent Virtual Circuits (PVC), Supports up to 1024 Virtual Circuit Identifiers (VCIs)	
Application-controlled multicasting and broadcasting with recipient add and delete capabilities	
Support for UNI 3.0 signalling, ILMI, LAN Emulation Clients, Classical IP	
SNMP MIB access to adapter status, ATM cell statistics, cell errors, and VCI/VPI information	
<b>General</b>	
<b>Dimensions</b>	0.6" H x 5.5" W x 9.4" D (1.5 cm x 12.7 cm x 23.8 cm)
<b>Weight</b>	8.3 oz. (235 g)
<b>Power Requirements</b>	2A (maximum) @ +5V
<b>Operating Temperature</b>	32°F to 104°F (0°C to 40°C)
<b>Operating Humidity</b>	20% to 80%, non-condensing @ 40°C
<b>Compliance</b>	FCC Part 15, Class A Verification (UTP); FCC Class B Certification (fiber-optic connectors)



### C.3.8 MCA-200 Technical Specifications

The MCA-200 ATM Adapter provides ATM connectivity to MicroChannel-based workstations, PCs, and servers, and has the following specifications:

<b>Hardware</b>	
<b>Architecture</b>	On-board 25 MHz i960 cell processor with Micro Channel bus master burst transfer capability
<b>AAL Support</b>	Special purpose, on-board hardware for HEC and AAL5 and 3/4 calculations
<b>UNI</b>	100 and 140 Mbps TAXI (4B/5B encoding); 155Mbps SONET STS-3c/ SDH STM-1
<b>Form Factor</b>	Single-slot MicroChannel bus
<b>Compliance</b>	ATM cell processing per ANSI T1S1.5/92-002R3, ITU I.361, and ATM Forum v3.0 UNI specification
<b>Cabling</b>	Duplex 62.5/125 $\mu$ m multimode fiber (2 km max. run, 10 dB loss); 2-pair 100 ohm CAT 5 or CAT 5 screened UTP (100 meters max.)
<b>Connectors</b>	ST and SC Types for multimode fiber; RJ-45 for CAT 5 UTP copper
<b>Memory</b>	256 kbytes on-board RAM
<b>DMA Support</b>	32-bit burst mode, bus master; "Fly-by," scatter-gather DMA support; Supports block transfers up to 16 words; Full 32-bit datapath
<b>Software</b>	
Transparent TCP/IP protocol interface	
Enhanced-performance ATM Application Programming Interface (API) Library	
SPANS Switched Virtual Circuit (SVC) signalling protocol	
Permanent Virtual Circuits (PVC), Supports up to 1024 Virtual Circuit Identifiers (VCIs)	
Application-controlled multicasting and broadcasting with recipient add and delete capabilities	
Support for UNI 3.0 signalling, ILMI, LAN Emulation Clients, Classical IP	
SNMP MIB access to adapter status, ATM cell statistics, cell errors, and VCI/VPI information	
<b>General</b>	
<b>Dimensions</b>	0.6" H x 5.0" W x 9.4" D (1.5 cm x 12.7 cm x 23.8 cm)
<b>Weight</b>	8.3 oz. (235 g)
<b>Power Requirements</b>	2A (maximum) @ +5V
<b>Operating Temperature</b>	32°F to 104°F (0°C to 40°C)
<b>Operating Humidity</b>	20% to 80%, non-condensing @ 40°C
<b>Compliance</b>	FCC Part 15, Class A Verification (UTP); FCC Class B Certification (fiber-optic connectors)

### C.3.9 SBA-200 Technical Specifications

The SBA-200 ATM Adapter provides ATM connectivity to Sun Microsystems' SPARC 1, 1+, 2, 10, 20, 630 MP, 670 MP, 690 MP, SPARC 5, SPARCstation IPC, IPX, LX, SPARCclassic, SPARCserver 1000, and SPARCcenter 2000, and has the following specifications::

<b>Hardware</b>	
<b>Architecture</b>	On-board 25 mHz i960 cell processor
<b>AAL Support</b>	Special purpose, on-board hardware for HEC, CRC, and AAL5 and 3/4 calculations
<b>UNI</b>	100 and 140 Mbps TAXI (4B/5B encoding); 155Mbps OC-3/SONET STS-3c/SDH STM-1
<b>Form Factor</b>	Single-slot Sbus
<b>Compliance</b>	ATM cell processing per ANSI T1S1.5/92-002R3, ITU I.361, and ATM Forum v3.0 UNI specification
<b>Cabling</b>	Duplex 62.5/125 $\mu$ m multimode fiber (2 km max. run, 10 dB loss); 2-pair 100 ohm CAT 5 or CAT 5 screened UTP (100 meters max.)
<b>Connectors</b>	ST and SC Types for multimode fiber; RJ-45 for CAT 5 UTP copper
<b>Memory</b>	256 kbytes on-board RAM
<b>DMA Support</b>	32-bit burst mode, bus master; "Fly-by," scatter-gather DMA support; Supports block transfers up to 16 words; Full 32-bit datapath
<b>Software</b>	
Transparent TCP/IP protocol interface	
Enhanced-performance ATM Application Programming Interface (API) Library	
SPANS Switched Virtual Circuit (SVC) signalling protocol	
Permanent Virtual Circuits (PVC), Supports up to 1024 Virtual Circuit Identifiers (VCIs)	
Application-controlled multicasting and broadcasting with recipient add and delete capabilities	
Support for UNI 3.0 signalling, ILMI, LAN Emulation Services (SunOS only) and Clients (SunOS and Solaris), Classical IP	
SNMP MIB access to adapter status, ATM cell statistics, cell errors, and VCI/VPI information	
<b>General</b>	
<b>Dimensions</b>	0.5" H x 3.3" W x 5.8" D (1.3 cm x 8.4 cm x 14.7 cm)
<b>Weight</b>	6 oz (170 g)
<b>Power Requirements</b>	2A (maximum) @ +5V
<b>Operating Temperature</b>	32°F to 104°F (0°C to 40°C)
<b>Operating Humidity</b>	20% to 80%, non-condensing @ 40°C
<b>Compliance</b>	FCC Part 15, Class A Verification (UTP); FCC Class B Certification (fiber-optic connectors)

### C.3.10 ESA-200 Technical Specifications

The ESA-200 ATM Adapter provides ATM connectivity to EISA-based workstations, PCs, and servers, and has the following specifications:

<b>Hardware</b>	
<b>Architecture</b>	On-board 25 mHz i960 cell processor
<b>AAL Support</b>	Special purpose, on-board hardware for HEC, CRC, and AAL5 and 3/4 calculations
<b>UNI</b>	100 and 140 Mbps TAXI (4B/5B encoding); 155Mbps OC-3/SONET STS-3c/SDH STM-1
<b>Form Factor</b>	Single-slot EISA bus
<b>Compliance</b>	ATM cell processing per ANSI T1S1.5/92-002R3, ITU I.361, and ATM Forum v3.0 UNI specification
<b>Cabling</b>	Duplex 62.5/125 $\mu$ m multimode fiber (2 km max. run, 10 dB loss); 2-pair 100 ohm CAT 5 or CAT 5 screened UTP (100 meters max.)
<b>Connectors</b>	ST and SC Types for multimode fiber; RJ-45 for CAT 5 UTP copper
<b>Memory</b>	256 kbytes on-board RAM
<b>DMA Support</b>	32-bit burst mode, bus master; "Fly-by," scatter-gather DMA support; Supports block transfers up to 16 words; Full 32-bit datapath
<b>Software</b>	
Transparent TCP/IP protocol interface	
Enhanced-performance ATM Application Programming Interface (API) Library	
SPANS Switched Virtual Circuit (SVC) signalling protocol	
Permanent Virtual Circuits (PVC), Supports up to 1024 Virtual Circuit Identifiers (VCIs)	
Application-controlled multicasting and broadcasting with recipient add and delete capabilities	
Support for UNI 3.0 signalling, ILMI, LAN Emulation Clients, Classical IP	
SNMP MIB access to adapter status, ATM cell statistics, cell errors, and VCI/VPI information	
<b>General</b>	
<b>Dimensions</b>	0.6" H x 4.3" W x 11.7" D (1.5 cm x 10.9 cm x 29.7 cm)
<b>Weight</b>	9 oz. (255 g)
<b>Power Requirements</b>	2A (maximum) @ +5V
<b>Operating Temperature</b>	32°F to 104°F (0°C to 40°C)
<b>Operating Humidity</b>	20% to 80%, non-condensing @ 40°C
<b>Compliance</b>	FCC Part 15, Class A Verification (UTP); FCC Class B Certification (fiber-optic connectors)

### C.3.11 VMA-200 Technical Specifications

The VMA-200 ATM Adapter provides ATM connectivity to Crimson, Onyx, Challenge XL, Challenge L, and Power Challenge machines, and has the following specifications:

<b>Hardware</b>	
<b>Architecture</b>	On-board 25 mHz i960 cell processor
<b>AAL Support</b>	Special purpose, on-board hardware for HEC, CRC, and AAL5 and 3/4 calculations
<b>UNI</b>	155 Mbps SONET STS-3c/SDH STM-1
<b>Form Factor</b>	Single-slot 6U or 9U VMEbus
<b>Compliance</b>	ATM cell processing per ANSI T1S1.5/92-002R3, ITU I.361, and ATM Forum v3.0 UNI specification.
<b>Cabling</b>	Duplex 62.5/125 $\mu$ m multimode fiber (2 km max. run, 10 dB loss); 2-pair 100 ohm CAT 5 or CAT 5 screened UTP (100 meters max.)
<b>Connectors</b>	ST and SC Types for multimode fiber; RJ-45 for CAT 5 UTP copper
<b>Memory</b>	256 kbytes on-board RAM
<b>DMA Support</b>	"Fly-by," scatter-gather DMA support; VMEbus Master; A32/D32, 64 word maximum block transfers; A32/D64, 512 word maximum block transfers; Full 32-bit datapath
<b>VMEbus modes supported</b>	Master: A32/D32, A32/D64; Slave: A16/D16, A32/D32 Requester: Level 3 only - fair requester; Interrupter: Level [7:1]
<b>Software</b>	
Transparent TCP/IP protocol interface	
Enhanced-performance ATM Application Programming Interface (API) Library	
SPANS Switched Virtual Circuit (SVC) signalling protocol	
Permanent Virtual Circuits (PVC), Supports up to 1024 Virtual Circuit Identifiers (VCIs)	
Application-controlled multicasting and broadcasting with recipient add and delete capabilities	
Support for UNI 3.0 signalling, ILMI, LAN Emulation Services Clients, Classical IP	
SNMP MIB access to adapter status, ATM cell statistics, cell errors, and VCI/VPI information	
<b>General</b>	
<b>Dimensions</b>	6U: 0.6" H x 6.3" W x 9.2" D ( 1.5 cm x 16 cm x 23.4 cm) 9U: 0.6" H x 14.4" W x 15.7" D ( 1.5 cm x 36.6 cm x 39.9 cm)
<b>Weight</b>	6U: 10.8 oz. (306 g), 9U: 32.5 oz. (922 g)
<b>Power Requirements</b>	2A (maximum) @ +5V; 50 mA @ + 12V
<b>Operating Temperature</b>	32°F to 104°F (0°C to 40°C)
<b>Operating Humidity</b>	20% to 80%, non-condensing @ 40°C
<b>Compliance</b>	FCC Part 15, Class A Verification (UTP); FCC Class B Certification (fiber-optic connectors)





## GLOSSARY

**802.1d Spanning Tree Bridging** - the IEEE standard for bridging; a MAC layer standard for transparently connecting two or more LANs (often called subnetworks) that are running the same protocols and cabling. This arrangement creates an extended network, in which any two workstations on the linked LANs can share data.

**802.3 Ethernet** - the IEEE standard for Ethernet; a physical-layer standard that uses the CSMA/CD access method on a bus-topology LAN.

**802.5 Token Ring** - the IEEE physical-layer standard that uses the token-passing access method on a ring-topology LAN.

**AAL (ATM Adaptation Layer)** - the AAL divides the user information into segments suitable for packaging into a series of ATM cells. There are several types of AALs in use. FORE Systems currently supports AAL 5 and AAL 3/4. AAL 3/4 supports connection-oriented VBR data transfer and connectionless VBR data transfer, respectively. AAL 5 is defined as Simple and Efficient Adaptation Layer (SEAL).

**AAL Connection** - an association established by the AAL between two or more next higher layer entities.

**ABR (Available Bit Rate)** - a type of traffic for which the ATM network attempts to meet that traffic's bandwidth requirements. It does not guarantee a specific amount of bandwidth and the end station must retransmit any information that did not reach the far end.

**Address Mask** - a bit mask used to identify which bits in an address (usually an IP address) are network significant, subnet significant, and host significant portions of the complete address. This mask is also known as the subnet mask because the subnetwork portion of the address can be determined by comparing the binary version of the mask to an IP address in that subnet. The mask holds the same number of bits as the protocol address it references.

**Agent (SNMP)** - a component of network- and desktop-management software, such as SNMP, that gathers information from MIBs.

**AIS (Alarm Indication Signal)** - a line AIS is asserted when a 111 binary pattern is detected in bits 6, 7, 8 of the K2 byte for five consecutive frames. A line AIS is removed when any pattern other than 111 is detected in these bits for five consecutive frames.

**AMI (ATM Management Interface)** - the user interface to FORE Systems' *ForeThought* switch control software (SCS). AMI lets users monitor and change various operating configurations of FORE Systems switches and net-

work module hardware and software, IP connectivity, and SNMP network management.

**ANSI (American National Standards Institute)** - a private organization that coordinates the setting and approval of some U.S. standards. It also represents the United States to the International Standards Organization.

**API (Application Program Interface)** - a language format that defines how a program can be made to interact with another program, service, or other software; it allows users to develop custom interfaces with FORE products.

**APP (application program)** - a complete, self-contained program that performs a specific function directly for the user.

**AppleTalk** - a networking protocol developed by Apple Computer for communication between Apple's products and other computers. Independent of the network layer, AppleTalk runs on LocalTalk, EtherTalk and TokenTalk.

**ARP (Address Resolution Protocol)** - a method used to resolve higher level protocol addressing (such as IP) into the appropriate header data required for ATM; i.e., port, VPI, and VCI; also defines the AAL type to be used.

**ASCII (American Standard Code for Information Interchange)** - a standard character set that (typically) assigns a 7-bit sequence to each letter, number, and selected control characters.

**Assigned Cell** - a cell that provides a service to an upper layer entity or ATM Layer Management entity (ATMM-entity).

**asxmon** - a FORE program that repeatedly displays the state of the switch and of all its active ports.

**Asynchronous time division multiplexing** - a multiplexing technique in which a transmission capability is organized into a priori, unassigned time slots. The time slots are assigned to cells upon request of each application's instantaneous real need.

**ATM (Asynchronous Transfer Mode)** - a transfer mode in which the information is organized into cells. It is asynchronous in the sense that the recurrence of cells containing information from an individual user is not necessarily periodic.

**ATM Forum** - an international non-profit organization formed with the objective of accelerating the use of ATM products and services through a rapid convergence of interoperability specifications. In addition, the Forum promotes industry cooperation and awareness.

**ATM Layer link** - a section of an ATM Layer connection between two adjacent active ATM Layer entities (ATM-entities).

**ATM Link** - a virtual path link (VPL) or a virtual channel link (VCL).



**ATM Peer-to-Peer Connection** - a virtual channel connection (VCC) or a virtual path connection (VPC) directly established, such as workstation-to-workstation. This setup is not commonly used in networks.

**ATM Traffic Descriptor** - a generic list of parameters that can be used to capture the intrinsic traffic characteristics of a requested ATM connection.

**ATM User-to-User Connection** - an association established by the ATM Layer to support communication between two or more ATM service users (i.e., between two or more next higher layer entities or between two or more ATM entities). The communication over an ATM Layer connection may be either bidirectional or unidirectional. The same Virtual Channel Identifier (VCI) is used for both directions of a connection at an interface.

**atmarp** - a FORE program that shows and manipulates ATM ARP entries maintained by the given device driver. This is also used to establish PVC connections.

**atmconfig** - a FORE program used to enable or disable SPANS signalling.

**atmstat** - a FORE program that shows statistics gathered about a given adapter card by the device driver. These statistics include ATM layer and ATM adaptation layer cell and error counts. This can also be used to query other hosts via SNMP.

**Backbone** - the main connectivity device of a distributed system. All systems that have connectivity to the backbone connect to each other. This does not stop systems from setting up private arrangements with each other to bypass the backbone for cost, performance, or security.

**Bandwidth** - usually identifies the capacity or amount of data that can be sent through a given circuit; may be user-specified in a PVC.

**BGP (Border Gateway) Protocol** - used by gateways in an internet, connecting autonomous networks. It is derived from experiences learned using the EGP.

**BIP (Bit Interleaved Parity)** - an error-detection technique in which character bit patterns are forced into parity, so that the total number of one bits is always odd or always even. This is accomplished by the addition of a one or zero bit to each byte, as the byte is transmitted; at the other end of the transmission, the receiving device verifies the parity (odd or even) and the accuracy of the transmission.

**B-ISDN (Broadband Integrated Services Digital Network)** - a common digital network suitable for voice, video, and high-speed data services running at rates beginning at 155 Mbps.

**Bridge** - a device that expands a Local Area Network by forwarding frames between data link layers associated with two separate cables, usually carrying

a common protocol. Bridges can usually be made to filter certain packets (to forward only certain traffic).

**Broadband** - a service or system requiring transmission channels capable of supporting rates greater than the Integrated Services Digital Network (ISDN) primary rate.

**Broadband Access** - an ISDN access capable of supporting one or more broadband services.

**Brouter (bridging/router)** - a device that routes some protocols and bridges others based on configuration information.

**BUS (Broadcast and Unknown Server)** - in an emulated LAN, the BUS is responsible for accepting broadcast, multicast, and unknown unicast packets from the LECs to the broadcast MAC address (FFFFFFFFFFFF) via dedicated point-to-point connections, and forwarding the packets to all of the members of the ELAN using a single point-to-multipoint connection.

**CAC (Connection Admission Control)** - the procedure used to decide if a request for an ATM connection can be accepted based on the attributes of both the requested connection and the existing connections.

**Call** - an association between two or more users or between a user and a network entity that is established by the use of network capabilities. This association may have zero or more connections.

**CBR (Constant Bit Rate)** - a type of traffic that requires a continuous, specific amount of bandwidth over the ATM network (e.g., digital information such as video and digitized voice).

**cchan** - a FORE program used to manage virtual channels on a FORE Systems ATM switch running asxd.

**CCITT (International Telephone and Telegraph Consultative Committee)** - the international standards body for telecommunications.

**CDV (Cell Delay Variation)** - a quantification of cell clumping for a connection. The cell clumping CDV ( $y_k$ ) is defined as the difference between a cell's expected reference arrival time ( $c_k$ ) and its actual arrival time ( $a_k$ ). The expected reference arrival time ( $c_k$ ) of cell  $k$  of a specific connection is  $\max [c_{\{k-1\}} + T, a_k]$ .  $T$  is the reciprocal of the negotiated peak cell rate.

**CE (Connection Endpoint)** - a terminator at one end of a layer connection within a SAP.

**CEI (Connection Endpoint Identifier)** - an identifier of a CE that can be used to identify the connection at a SAP.

**Cell** - an ATM Layer protocol data unit (PDU).

**Cell Header** - ATM Layer protocol control information.

**Cell Transfer Delay** - the transit delay of an ATM cell successfully passed between two designated boundaries.

**CLP (Cell Loss Priority)** - the last bit of byte four in an ATM cell header; indicates the eligibility of the cell for discard by the network under congested conditions. If the bit is set to 1, the cell may be discarded by the network depending on traffic conditions.

**Concentrator** - a communications device that offers the ability to concentrate many lower-speed channels into and out of one or more high-speed channels.

**Connection** - the concatenation of ATM Layer links in order to provide an end-to-end information transfer capability to access points.

**Connectionless Service** - a type of service in which no pre-determined path or link has been established for transfer of information, supported by AAL 4.

**Connection-Oriented Service** - a type of service in which information always traverses the same pre-established path or link between two points, supported by AAL 3.

**Corresponding Entities** - peer entities with a lower layer connection among them.

**cpath** - a FORE program used to manage virtual paths on a FORE Systems ATM switch running asxd.

**cport** - a FORE program used to monitor and change the state of ports on a FORE Systems ATM switch running asxd.

**CRC (Cyclic Redundancy Check)** - an error detection scheme in which a number is derived from the data that will be transmitted. By recalculating the CRC at the remote end and comparing it to the value originally transmitted, the receiving node can detect errors.

**CS (Convergence Sublayer)** - a portion of the AAL. Data is passed first to the CS where it is divided into rational, fixed-length packets or PDUs (Protocol Data Units). For example, AAL 4 processes user data into blocks that are a maximum of 64 kbytes long.

**DARPA (Defense Advanced Research Projects Agency)** - the US government agency that funded the ARPANET.

**DCS (Digital Cross-connect System)** - an electronic patch panel used to route digital signals in a central office.

**Demultiplexing** - a function performed by a layer entity that identifies and separates SDUs from a single connection to more than one connection. (See multiplexing.)

**DIP Switch (Dual In-line Package)** - a device that has two parallel rows of contacts that let the user switch electrical current through a pair of those contacts to on or off. They are used to reconfigure components and peripherals.

**Domain Name Server** - a computer that converts names to their corresponding Internet numbers. It allows users to telnet or FTP to the name instead of the number.

**DNS (Domain Name System)** - the distributed name and address mechanism used in the Internet.

**DSn (Digital Standard n (0, 1, 1C, 2, and 3))** - a method that defines the rate and format of digital hierarchy.

Asynchronous data rates are defined as follows:

DS0	64kb/s	1 voice channel
DS1	1.544Mb/s	24 DS0s
DS1C	3.152 Mb/s	2 DS1s
DS2	6.312 Mb/s	4 DS1s
DS3	44.736 Mb/s	28 DS1s

Synchronous data rates (SONET) are defined as:

STS-1/OC-1	51.84 Mb/s	28 DS1s or 1 DS3
STS-3/OC-3	155.52 Mb/s	3 STS-1s byte interleaved
STS-3c/OC-3c	155.52 Mb/s	Concatenated, indivisible payload
STS-12/OC-12	622.08 Mb/s	12 STS-1s, 4 STS-3cs, or any mixture
STS-12c/OC-12c	622.08 Mb/s	Concatenated, indivisible payload
STS-48/OC-48	2488.32 Mb/s	48 STS-1s, 16 STS-3cs, or any mixture

**EGP (Exterior Gateway) Protocol** - used by gateways in an internet, connecting autonomous networks.

**EISA (Extended Industry Standard Architecture)** - a bus architecture for desktop computers that provides a 32-bit data passage while maintaining compatibility with the ISA or AT architecture.

**elarp** - a FORE program that shows and manipulates MAC and ATM address mappings for LAN Emulation Clients (LECs).

**elconfig** - a FORE program that shows and modifies LEC configuration. Allows the user to set the NSAP address of the LAN Emulation Configuration Server (LECS), display the list of Emulated LANs (ELANs) configured in the LECS for this host, display the list of ELANs locally configured along with the membership state of each, and locally administer ELAN membership.

**EPROM** - Erasable Programmable Read Only Memory (See PROM.)

**ES (End System)** - a system in which an ATM connection is terminated or initiated. An originating end system initiates the ATM connection, and a terminating end system terminates the ATM connection. OAM cells may be generated and received.

**Ethernet** - a 10-Mbps, coaxial standard for LANs in which all nodes connect to the cable where they contend for access.

**Fairness** - as related to Generic Flow Control (GFC), fairness is defined as meeting all of the agreed quality of service (QoS) requirements by controlling the order of service for all active connections.

**FCC** - a board of commissioners appointed by the President under the Communications Act of 1934, with the authority to regulate all interstate telecommunications originating in the United States, including transmission over phone lines.

**FDI (Fiber Distributed Data Interface)** - high-speed data network that uses fiber-optic as the physical medium. Operates in similar manner to Ethernet or Token Ring, only faster.

**FDM (Frequency Division Multiplexing)** - a method of dividing an available frequency range into parts with each having enough bandwidth to carry one channel.

**FEBE (Far End Block Error)** - an error detected by extracting the 4-bit FEBE field from the path status byte (G1). The legal range for the 4-bit field is between 0000 and 1000, representing zero to eight errors. Any other value is interpreted as zero errors.

**FERF (Far End Receive Failure)** - a line error asserted when a 110 binary pattern is detected in bits 6, 7, 8 of the K2 byte for five consecutive frames. A line FERF is removed when any pattern other than 110 is detected in these bits for five consecutive frames.

**FIFO (First-In, First-Out)** - a method of coordinating the sequential flow of data through a buffer.

**Flag** - a specific bit pattern used to identify the beginning or end of a frame.

**Frame** - a variable length group of data bits with a specific format containing flags at the beginning and end to provide demarcation.

**Frame Relay** - a fast packet switching protocol based on the LAPD protocol of ISDN that performs routing and transfer with less overhead processing than X.25.

**FT-PNNI (*ForeThought* PNNI)** - a FORE Systems routing and signalling protocol that uses private ATM (NSAP) addresses; a precursor to ATM Forum PNNI (see PNNI).

**ftp (File Transfer Protocol)** - a TCP/IP protocol that lets a user on one computer access, and transfer data to and from, another computer over a network. ftp is usually the name of the program the user invokes to accomplish this task.

**GCRA (Generic Cell Rate Algorithm)** - an algorithm which is employed in traffic policing and is part of the user/network service contract. The GCRA is a scheduling algorithm which ensures that cells are marked as *conforming* when they arrive when expected or later than expected and *non-conforming* when they arrive sooner than expected.

**GFC (Generic Flow Control)** - the first four bits of the first byte in an ATM cell header. Used to control the flow of traffic across the User-to-Network Interface (UNI), and thus into the network. Exact mechanisms for flow control are still under investigation and no explicit definition for this field exists at this time. (This field is used only at the UNI; for NNI-NNI use (between network nodes), these four bits provide additional network address capacity, and are appended to the VPI field.)

**GIO** - a proprietary bus architecture used in certain Silicon Graphics, Inc. workstations.

**Header** - protocol control information located at the beginning of a protocol data unit.

**HEC (Header Error Control)** - a CRC code located in the last byte of an ATM cell header that is used for checking cell integrity only.

**HIPPI (High Performance Parallel Interface)** - an ANSI standard that extends the computer bus over fairly short distances at speeds of 800 and 1600 Mbps.

**HPUX** - the Hewlett-Packard version of UNIX.

**HSSI (High-Speed Serial Interface)** - a serial communications connection that operates at speeds of up to 1.544 Mbps.

**Hub** - a device that connects to several other devices, usually in a star topology.

**I/O Module** - FORE's interface cards for the LAX-20 LAN Access Switch, designed to connect Ethernet, Token Ring, and FDDI LANs to *ForeRunner* ATM networks.

**ICMP (Internet Control Message Protocol)** - the protocol that handles errors and control messages at the IP layer. ICMP is actually a part of the IP protocol layer. It can generate error messages, test packets, and informational messages related to IP.

**IEEE (Institute of Electrical and Electronics Engineers)** - the world's largest technical professional society. Based in the U.S.A., the IEEE sponsors technical conferences, symposia & local meetings worldwide, publishes nearly 25% of the world's technical papers in electrical, electronics & computer engineering, provides educational programs for its members, and promotes standardization.

**IETF (Internet Engineering Task Force)** - a large, open, international community of network designers, operators, vendors and researchers whose purpose is to coordinate the operation, management and evolution of the Internet to resolve short- and mid-range protocol and architectural issues.

**ILMI (Interim Local Management Interface)** - the standard that specifies the use of the Simple Network Management Protocol (SNMP) and an ATM management information base (MIB) to provide network status and configuration information.

**Interface Data** - the unit of information transferred to/from the upper layer in a single interaction across a SAP. Each Interface Data Unit (IDU) controls interface information and may also contain the whole or part of the SDU.

**internet** - while an internet is a network, the term "internet" is usually used to refer to a collection of networks interconnected with routers.

**Internet** - (note the capital "I") the largest internet in the world including large national backbone nets and many regional and local networks worldwide. The Internet uses the TCP/IP suite. Networks with only e-mail connectivity are not considered on the Internet.

**Internet Addresses** - the numbers used to identify hosts on an internet network. Internet host numbers are divided into two parts; the first is the network number and the second, or local, part is a host number on that particular network. There are also three classes of networks in the Internet, based on the number of hosts on a given network. Large networks are classified as Class A, having addresses in the range 1-126 and having a maximum of 16,387,064 hosts. Medium networks are classified as Class B, with addresses in the range 128-191 and with a maximum of 64,516 hosts. Small networks are classified as Class C, having addresses in the range 192-254 with a maximum of 254 hosts. Addresses are given as dotted decimal numbers in the following format:

nnn.nnn.nnn.nnn

In a Class A network, the first of the numbers is the network number, the last three numbers are the local host address.

In a Class B network, the first two numbers are the network, the last two are the local host address.

In a Class C network, the first three numbers are the network address, the last number is the local host address.

The following table summarizes the classes and sizes:

<u>Class</u>	<u>First #</u>	<u>Max# Hosts</u>
A	1-126	16,387,064
B	129-191	64,516
C	192-223	254

Network mask values are used to identify the network portion and the host portion of the address. For:

Class A - the default mask is 255.0.0.0

Class B - the default mask is 255.255.0.0

Class C - the default mask is 255.255.255.0

Subnet masking is used when a portion of the host ID is used to identify a subnetwork. For example, if a portion of a Class B network address is used for a subnetwork, the mask could be set as 255.255.255.0. This would allow the third byte to be used as a subnetwork address. All hosts on the network would still use the IP address to get on the Internet.

**IP (Internet Protocol)** - a connectionless, best-effort packet switching protocol that offers a common layer over dissimilar networks.

**IPX Protocol (Internetwork Packet Exchange)** - a NetWare protocol similar to the Xerox Network Systems (XNS) protocol that provides datagram delivery of messages.

**IS (Intermediate system)** - a system that provides forwarding functions or relaying functions or both for a specific ATM connection. OAM cells may be generated and received.

**ISA Bus** - a bus standard developed by IBM for expansion cards in the first IBM PC. The original bus supported a data path only 8 bits wide. IBM subsequently developed a 16-bit version for its AT class computers. The 16-bit AT ISA bus supports both 8- and 16-bit cards. The 8-bit bus is commonly called the PC/XT bus, and the 16-bit bus is called the AT bus.



**ISDN (Integrated Services Digital Network)** - an emerging technology that is beginning to be offered by the telephone carriers of the world. ISDN combines voice and digital network services into a single medium or wire.

**ISO (International Standards Organization)** - a voluntary, non treaty organization founded in 1946 that is responsible for creating international standards in many areas, including computers and communications.

**Isochronous** - signals carrying embedded timing information or signals that are dependent on uniform timing; usually associated with voice and/or video transmission.

**Jumper** - a patch cable or wire used to establish a circuit, often temporarily, for testing or diagnostics; also, the devices, shorting blocks, used to connect adjacent exposed pins on a printed circuit board that control the functionality of the card.

**LAN (Local Area Network)** - a data network intended to serve an area of only a few square kilometers or less. Because the network is known to cover only a small area, optimizations can be made in the network signal protocols that permit higher data rates.

**lane** - a program that provides control over the execution of the LAN Emulation Server (LES), Broadcast/Unknown Server (BUS), and LAN Emulation Configuration Server (LECS) on the local host.

**LAN Access Concentrator** - a LAN access device that allows a shared transmission medium to accommodate more data sources than there are channels currently available within the transmission medium.

**Layer Entity** - an active layer within an element.

**Layer Function** - a part of the activity of the layer entities.

**Layer Service** - a capability of a layer and the layers beneath it that is provided to the upper layer entities at the boundary between that layer and the next higher layer.

**Layer User Data** - the information transferred between corresponding entities on behalf of the upper layer or layer management entities for which they are providing services.

**le** - a FORE program that implements both the LAN Emulation Server (LES) and the Broadcast/Unknown Server (BUS).

**LEC (LAN Emulation Client)** - the component in an end system that performs data forwarding, address resolution, and other control functions when communicating with other components within an ELAN.

**lecs** - a FORE program that implements the assignment of individual LECs to different emulated LANs.

**LECS (LAN Emulation Configuration Server)** - the LECS is responsible for the initial configuration of LECs. It provides information about available ELANs that a LEC may join, together with the addresses of the LES and BUS associated with each ELAN.

**leq** - a FORE program that provides information about an ELAN. This information is obtained from the LES, and includes MAC addresses registered on the ELAN together with their corresponding ATM addresses.

**LES (LAN Emulation Server)** - the LES implements the control coordination function for an ELAN. The LES provides the service of registering and resolving MAC addresses to ATM addresses.

**LLC (Logical Link Control)** - a protocol developed by the IEEE 802 committee for data-link-layer transmission control; the upper sublayer of the IEEE Layer 2 (OSI) protocol that complements the MAC protocol; IEEE standard 802.2; includes end-system addressing and error checking.

**LOF (Loss Of Frame)** - a type of transmission error that may occur in wide-area carrier lines.

**looptest** - a program that tests the interface for basic cell reception and transmission functionality. It is usually used for diagnostic purposes to determine if an interface is functioning properly.

**LOP (Loss Of Pointer)** - a type of transmission error that may occur in wide-area carrier lines.

**LOS (Loss Of Signal)** - a type of transmission error that may occur in wide-area carrier lines.

**MAC (Media Access Control)** - a media-specific access control protocol within IEEE 802 specifications; currently includes variations for Token Ring, token bus, and CSMA/CD; the lower sublayer of the IEEE's link layer (OSI), which complements the Logical Link Control (LLC).

**Metasignalling** - an ATM Layer Management (LM) process that manages different types of signalling and possibly semipermanent virtual channels (VCs), including the assignment, removal, and checking of VCs.

**Metasignalling VCs** - the standardized VCs that convey metasignalling information across a User-to-Network Interface (UNI).

**MIB (Management Information Base)** - the set of parameters an SNMP management station can query or set in the SNMP agent of a networked device (e.g., router).

**MIC (Media Interface Connector)** - the optical fiber connector that joins the fiber to the FDDI controller.

**MicroChannel** - a proprietary 16- or 32-bit bus developed by IBM for its PS/2 computers' internal expansion cards; also offered by others.

**MTU (Maximum Transmission Unit)** - the largest unit of data that can be sent over a type of physical medium.

**Multi-homed** - a device that has both an ATM and another network connection, typically Ethernet.

**Multiplexing** - a function within a layer that interleaves the information from multiple connections into one connection. (See demultiplexing.)

**Multipoint Access** - user access in which more than one terminal equipment (TE) is supported by a single network termination.

**Multipoint-to-Point Connection** - a Point-to-Multipoint Connection may have zero bandwidth from the Root Node to the Leaf Nodes, and non-zero return bandwidth from the Leaf Nodes to the Root Node. Such a connection is also known as a Multipoint-to-Point Connection.

**Multipoint-to-Multipoint Connection** - a collection of associated ATM VC or VP links, and their associated endpoint nodes, with the following properties:

1. All N nodes in the connection, called Endpoints, serve as a Root Node in a Point-to-Multipoint connection to all of the (N-1) remaining endpoints.

2. Each of the endpoints on the connection can send information directly to any other endpoint, but the receiving endpoint cannot distinguish which of the endpoints is sending information without additional (e.g., higher layer) information.

**Network Module** - ATM port interface cards which may be individually added or removed from any *ForeRunner* ATM switch to provide a diverse choice of connection alternatives. Each network module provides between one and six full-duplex ATM physical connections to the *ForeRunner* switch.

**NMS (Network Management Station)** - the system responsible for managing a network or a portion of a network. The NMS talks to network management agents, which reside in the managed nodes.

**NNI (Network-to-Network Interface or Network Node Interface)** - the interface between two public network pieces of equipment.

**NuBus** - a high-speed bus used in the Macintosh family of computers, structured so that users can put a card into any slot on the board without creating conflict over the priority between those cards

**OAM (Operation and Maintenance) Cell** - a cell that contains ATM LM information. It does not form part of the upper layer information transfer.

**OpenView** - Hewlett-Packard's network management software.

**OSI (Open Systems Interconnection)** - the 7-layer suite of protocols designed by ISO committees to be the international standard computer network architecture.

**OSPF (Open Shortest Path First) Protocol** - a routing algorithm for IP that incorporates least-cost, equal-cost, and load balancing.

**Out-of-Band Management** - refers to switch configuration via the serial port or over Ethernet, not ATM.

**Packet Switching** - a communications paradigm in which packets (messages) are individually routed between hosts with no previously established communications path.

**PBX (Private Branch Exchange)** - a private phone system (switch) that connects to the public telephone network and offers in-house connectivity. To reach an outside line, the user must dial a digit like 8 or 9.

**PCI (Peripheral Component Interconnect)** - a local-bus standard created by Intel.

**PCM (Pulse Code Modulation)** - a modulation scheme that samples the information signals and transmits a series of coded pulses to represent the data.

**PDN (Public Data Network)** - a network designed primarily for data transmission and intended for sharing by many users from many organizations.

**PDU (Protocol Data Unit)** - a unit of data specified in a layer protocol and consisting of protocol control information and layer user data.

**Peak Cell Rate** - at the PHY Layer SAP of a point-to-point VCC, the Peak Cell Rate  $R_p$  is the inverse of the minimum inter-arrival time  $T_0$  of the request to send an ATM-SDU.

**Peer Entities** - entities within the same layer.

**PHY (Physical Layer)** - the actual cards, wires, and/or fiber-optic cabling used to connect computers, routers, and switches.

**Physical Layer (PHY) Connection** - an association established by the PHY between two or more ATM-entities. A PHY connection consists of the concatenation of PHY links in order to provide an end-to-end transfer capability to PHY SAPs.

**PMD (Physical Medium Dependent)** - a sublayer concerned with the bit transfer between two network nodes. It deals with wave shapes, timing recovery, line coding, and electro-optic conversions for fiber based links.

**PNNI (Private Network Node Interface or Private Network-to-Network Interface)** - a protocol that defines the interaction of private ATM switches or groups of private ATM switches

**ping (Packet Internet Groper)** - a program used to test reachability of destinations by sending them an ICMP echo request and waiting for a reply.

**Point-to-Multipoint Connection** - a collection of associated ATM VC or VP links, with associated endpoint nodes, with the following properties:

1. One ATM link, called the Root Link, serves as the root in a simple tree topology. When the Root node sends information, all of the remaining nodes on the connection, called Leaf nodes, receive copies of the information.
2. Each of the Leaf Nodes on the connection can send information directly to the Root Node. The Root Node cannot distinguish which Leaf is sending information without additional (higher layer) information. (See the following note for Phase 1.)
3. The Leaf Nodes cannot communicate directly to each other with this connection type.

Note: Phase 1 signalling does not support traffic sent from a Leaf to the Root.

**Point-to-Point Connection** - a connection with only two endpoints.

**Primitive** - an abstract, implementation-independent interaction between a layer service user and a layer service provider.

**PROM (Programmable Read-Only Memory)** - a chip-based information storage area that can be recorded by an operator but erased only through a physical process.

**Protocol** - a set of rules and formats (semantic and syntactic) that determines the communication behavior of layer entities in the performance of the layer functions.

**Protocol Control Information** - the information exchanged between corresponding entities using a lower layer connection to coordinate their joint operation.

**Proxy** - the process in which one system acts for another system to answer protocol requests.

**Proxy Agent** - an agent that queries on behalf of the manager, used to monitor objects that are not directly manageable.

**PSN (Packet Switched Network)** - a network designed to carry data in the form of packets. The packet and its format is internal to that network.

**PT (Payload Type)** - bits 2...4 in the fourth byte of an ATM cell header. The PT indicates the type of information carried by the cell. At this time, values 0...3 are used to identify various types of user data, values 4 and 5 indicate management information, and values 6 and 7 are reserved for future use.

**PVC (Permanent Virtual Circuit (or Channel))** - a circuit or channel through an ATM network provisioned by a carrier between two endpoints; used for dedicated long-term information transport between locations.

**Q.2931** - Derived from Q.93B, the narrowband ISDN signalling protocol, an ITU standard describing the signalling protocol to be used by switched virtual circuits on ATM LANs.

**Relaying** - a function of a layer by means of which a layer entity receives data from a corresponding entity and transmits it to another corresponding entity.

**RFCs (Requests For Comment)** - IETF documents suggesting protocols and policies of the Internet, inviting comments as to the quality and validity of those policies. These comments are collected and analyzed by the IETF in order to finalize Internet standards.

**RFI (Radio Frequency Interference)** - the unintentional transmission of radio signals. Computer equipment and wiring can both generate and receive RFI.

**RIP (Routing Information Protocol)** - a distance vector-based protocol that provides a measure of distance, or hops, from a transmitting workstation to a receiving workstation.

**RISC (Reduced Instruction Set Computer)** - a generic name for CPUs that use a simpler instruction set than more traditional designs.

**Router** - a device that forwards traffic between networks or subnetworks based on network layer information.

**SBus** - hardware interface for add-in boards in later-version Sun 3 workstations.

**SAP (Service Access Point)** - the point at which an entity of a layer provides services to its LM entity or to an entity of the next higher layer.

**SAR (Segmentation And Reassembly)** - the SAR accepts PDUs from the CS and divides them into very small segments (44 bytes long). If the CS-PDU is less than 44 bytes, it is padded to 44 with zeroes. A two-byte header and trailer are added to this basic segment. The header identifies the message type (beginning, end, continuation, or single) and contains sequence numbering and message identification. The trailer gives the SAR-PDU payload length, exclusive of pad, and contains a CRC check to ensure the SAR-PDU integrity. The result is a 48-byte PDU that fits into the payload field of an ATM cell.

**SCSI (Small Computer Systems Interface)** - a standard for a controller bus that connects disk drives and other devices to their controllers on a computer bus. It is typically used in small systems.

**SDLC (Synchronous Data Link Control)** - IBM's data link protocol used in SNA networks.

**SDU (Service Data Unit)** - a unit of interface information whose identity is preserved from one end of a layer connection to the other.

**SEAL (Simple and Efficient Adaptation Layer)** - also called AAL 5, this ATM adaptation layer assumes that higher layer processes will provide error recovery, thereby simplifying the SAR portion of the adaptation layer. Using this AAL type packs all 48 bytes of an ATM cell information field with data. It also assumes that only one message is crossing the UNI at a time. That is, multiple end-users at one location cannot interleave messages on the same VC, but must queue them for sequential transmission.

**Segment** - a single ATM link or group of interconnected ATM links of an ATM connection.

**Semipermanent Connection** - a connection established via a service order or via network management.

**SGMP (Simple Gateway Management Protocol)** - the predecessor to SNMP.

**Shaping Descriptor** -  $n$  ordered pairs of GCRA parameters (I,L) used to define the negotiated traffic shape of an APP connection. The traffic shape refers to the load-balancing of a network. In this context, load-balancing means configuring the data flows to maximize the efficiency of the network.

**SIR (Sustained Information Rate)** - the long-term average data transmission rate across the User-to-Network Interface.

**SMDS (Switched Multimegabit Data Service)** - a high-speed, datagram-based, public data network service expected to be widely used by telephone companies in their data networks.

**SMTP (Simple Mail Transfer Protocol)** - the Internet electronic mail protocol used to transfer electronic mail between hosts.

**SNAP** - SubNetwork Access Protocol

**SNMP (Simple Network Management Protocol)** - the Internet standard protocol for managing nodes on an IP network.

**snmpd** - an SMNP agent for a given adapter card.

**SONET (Synchronous Optical Network)** - a new and growing body of standards that defines all aspects of transporting and managing digital traffic over optical facilities in the public network.

**Source Traffic Descriptor** - a set of traffic parameters belonging to the ATM Traffic Descriptor used during the connection set-up to capture the intrinsic traffic characteristics of the connection requested by the source.

**Spanning Tree Protocol** - provides loop-free topology in a network environment where there are redundant paths.

**SPANS (Simple Protocol for ATM Network Signalling)** - FORE Systems' proprietary signalling protocol used for establishing SVCs between FORE Systems equipment.

**SPARC (Scalable Processor Architecture Reduced instruction set Computer)** - a powerful workstation similar to a reduced-instruction-set-computing (RISC) workstation.

**SPE (Synchronous Payload Envelope)** - the payload field plus a little overhead of a basic SONET signal.

**SPVC (Smart PVC)** - a generic term for any communications medium which is permanently provisioned at the end points, but switched in the middle. In ATM, there are two kinds of SPVCs: smart permanent virtual path connections (SPVPCs) and smart permanent virtual channel connections (SPVCCs).

**Static Route** - a route that is entered manually into the routing table.

**STM (Synchronous Transfer Mode)** - a transport and switching method that depends on information occurring in regular and fixed patterns with respect to a reference such as a frame pattern.

**STP (Shielded Twisted Pair)** - two or more insulated wires that are twisted together and then wrapped in a cable with metallic braid or foil to prevent interference and offer noise-free transmissions.

**STS (Synchronous Transport Signal)** - a SONET electrical signal rate.

**Sublayer** - a logical subdivision of a layer.

**SVC (Switched Virtual Circuit (or Channel))** - a channel established on demand by network signalling, used for information transport between two locations and lasting only for the duration of the transfer; the datacom equivalent of a dialed telephone call.



**Switched Connection** - a connection established via signalling.

**Symmetric Connection** - a connection with the same bandwidth value specified for both directions.

**Synchronous** - signals that are sourced from the same timing reference and hence are identical in frequency.

**Systems Network Architecture (SNA)** - a proprietary networking architecture used by IBM and IBM-compatible mainframe computers.

**Tachometer** - in *ForeView*, the tachometer shows the level of activity on a given port. The number in the tachometer shows the value of a chosen parameter in percentage, with a colored bar providing a semi-logarithmic representation of that percentage.

**TAXI** - Transparent Asynchronous Transmitter/Receiver Interface

**TC (Transmission Convergence)** - generates and receives transmission frames and is responsible for all overhead associated with the transmission frame. The TC sublayer packages cells into the transmission frame.

**TCP (Transmission Control Protocol)** - a specification for software that bundles and unbundles sent and received data into packets, manages the transmission of packets on a network, and checks for errors.

**TCP/IP (Transmission Control Protocol/Internet Protocol)** - a set of communications protocols that has evolved since the late 1970s, when it was first developed by the Department of Defense. Because programs supporting these protocols are available on so many different computer systems, they have become an excellent way to connect different types of computers over networks.

**TDM (Time Division Multiplexing)** - a traditional digital multiplexing in which a signal occupies a fixed, repetitive time slot within a higher-rate signal.

**Token Ring** - a network access method in which the stations circulate a token. Stations with data to send must have the token to transmit their data.

**topology** - a program that displays the topology of a FORE Systems ATM network. An updated topology can be periodically re-displayed by use of the interval command option.

**Traffic** - the calls being sent and received over a communications network. Also, the packets that are sent on a data network.

**Trailer** - the protocol control information located at the end of a PDU.

**Transit Delay** - the time difference between the instant at which the first bit of a PDU crosses one designated boundary, and the instant at which the last bit of the same PDU crosses a second designated boundary.

**trap** - a program interrupt mechanism that automatically updates the state of the network to remote network management hosts. The SNMP agent on the switch supports these SNMP traps.

**UBR (Unspecified Bit Rate)** - a type of traffic that is not considered time-critical (e.g., ARP messages, pure data), allocated whatever bandwidth is available at any given time. UBR traffic is given a "best effort" priority in an ATM network with no guarantee of successful transmission.

**UDP (User Datagram Protocol)** - the TCP/IP transaction protocol used for applications such as remote network management and name-service access; this lets users assign a name, such as "RVAX\*2,S," to a physical or numbered address.

**Unassigned Cells** - a cell identified by a standardized virtual path identifier (VPI) and virtual channel identifier (VCI) value, which has been generated and does not carry information from an application using the ATM Layer service.

**UNI (User-to-Network Interface)** - the physical and electrical demarcation point between the user and the public network service provider.

**UNI 3.0** - the User-to-Network Interface standard set forth by the ATM Forum that defines how private customer premise equipment interacts with private ATM switches.

**UTP (Unshielded Twisted Pair)** - a cable that consists of two or more insulated conductors in which each pair of conductors are twisted around each other. There is no external protection and noise resistance comes solely from the twists.

**VBR (Variable Bit Rate)** - a type of traffic that, when sent over a network, is tolerant of delays and changes in the amount of bandwidth it is allocated (e.g., data applications).

**VC (Virtual Channel (or Circuit))** - a communications path between two nodes identified by label rather than fixed physical path.

**VCC (Virtual Channel Connection)** - a unidirectional concatenation of VCLs that extends between the points where the ATM service users access the ATM Layer. The points at which the ATM cell payload is passed to, or received from, the users of the ATM Layer (i.e., a higher layer or ATMM-entity) for processing signify the endpoints of a VCC.

**VCI (Virtual Channel Identifier)** - the address or label of a VC.

**VCL (Virtual Channel Link)** - a means of unidirectional transport of ATM cells between the point where a VCI value is assigned and the point where that value is translated or removed.

**VINES (Virtual Network Software)** - Banyan's network operating system based on UNIX and its protocols.

**Virtual Channel Switch** - a network element that connects VCLs. It terminates VPCs and translates VCI values. The Virtual Channel Switch is directed by Control Plane functions and relays the cells of a VC.

**Virtual Path Switch** - a network element that connects VPLs, it translates VPI (not VCI) values and is directed by Control Plane functions. The Virtual Path Switch relays the cells of a Virtual Path.

**VPT (Virtual Path Terminator)** - a system that unbundles the VCs of a VP for independent processing of each VC.

**VP (Virtual Path)** - a unidirectional logical association or bundle of VCs.

**VPC (Virtual Path Connection)** - a concatenation of VPLs between virtual path terminators (VPTs). VPCs are unidirectional.

**VPDN (Virtual Private Data Network)** - a private data communications network built on public switching and transport facilities rather than dedicated leased facilities such as T1s.

**VPI (Virtual Path Identifier)** - the address or label of a particular VP.

**VPL (Virtual Path Link)** - a means of unidirectional transport of ATM cells between the point where a VPI value is assigned and the point where that value is translated or removed.

**VPN (Virtual Private Network)** - a private voice communications network built on public switching and transport facilities rather than dedicated leased facilities such as T1s.

**VT (Virtual Tributary)** - a structure used to carry payloads such as DS1s that run at significantly lower rates than STS-1s.

**WAN (Wide-Area Network)** - a network that covers a large geographic area.

**X.25** - a well-established data switching and transport method that relies on a significant amount of processing to ensure reliable transport over metallic media.



## Free Manuals Download Website

<http://myh66.com>

<http://usermanuals.us>

<http://www.somanuals.com>

<http://www.4manuals.cc>

<http://www.manual-lib.com>

<http://www.404manual.com>

<http://www.luxmanual.com>

<http://aubethermostatmanual.com>

Golf course search by state

<http://golfingnear.com>

Email search by domain

<http://emailbydomain.com>

Auto manuals search

<http://auto.somanuals.com>

TV manuals search

<http://tv.somanuals.com>