

STHI

INTELLIGENT

TOKEN RING STACKABLE HUB

USER'S GUIDE

CABLETRON
SYSTEMS Inc.

The Complete Networking Solution™

CABLETRON SYSTEMS, P. O. Box 5005 Rochester, NH 03866-5005

Download from Www.Somanuals.com. All Manuals Search And Download.

NOTICE

Cabletron Systems reserves the right to make changes in specifications and other information contained in this document without prior notice. The reader should in all cases consult Cabletron Systems to determine whether any such changes have been made.

The hardware, firmware, or software described in this manual is subject to change without notice.

IN NO EVENT SHALL CABLETRON SYSTEMS BE LIABLE FOR ANY INCIDENTAL, INDIRECT, SPECIAL, OR CONSEQUENTIAL DAMAGES WHATSOEVER (INCLUDING BUT NOT LIMITED TO LOST PROFITS) ARISING OUT OF OR RELATED TO THIS MANUAL OR THE INFORMATION CONTAINED IN IT, EVEN IF CABLETRON SYSTEMS HAS BEEN ADVISED OF, KNOWN, OR SHOULD HAVE KNOWN, THE POSSIBILITY OF SUCH DAMAGES.

© Copyright May, 1995 by:
Cabletron Systems, Inc.
P.O. Box 5005, Rochester, NH 038666-5005

All Rights Reserved

Printed in the United States of America

Order Number: 9031390 May, 1995

SPECTRUM, LANVIEW, Remote LANVIEW, and HubSTACK, STH, STHI, are trademarks of Cabletron Systems, Inc.

i960 is a registered trademark of Intel Corporation.

DEC and VT100 are trademarks of Digital Equipment Corporation.

CompuServe is a registered trademark of CompuServe, Inc.

Windows is a registered trademark of Microsoft Corporation.

Printed On



Recycled Paper

FCC NOTICE

This device complies with Part 15 of the FCC rules. Operation is subject to the following two conditions: (1) this device may not cause harmful interference, and (2) this device must accept any interference received, including interference that may cause undesired operation.

NOTE: This equipment has been tested and found to comply with the limits for a Class A digital device, pursuant to Part 15 of the FCC rules. These limits are designed to provide reasonable protection against harmful interference when the equipment is operated in a commercial environment. This equipment uses, generates, and can radiate radio frequency energy and if not installed in accordance with the operator's manual, may cause harmful interference to radio communications. Operation of this equipment in a residential area is likely to cause interference in which case the user will be required to correct the interference at his own expense.

WARNING: Changes or modifications made to this device which are not expressly approved by the party responsible for compliance could void the user's authority to operate the equipment.

DOC NOTICE

This digital apparatus does not exceed the Class A limits for radio noise emissions from digital apparatus set out in the Radio Interference Regulations of the Canadian Department of Communications.

Le présent appareil numérique n'émet pas de bruits radioélectriques dépassant les limites applicables aux appareils numériques de la class A prescrites dans le Règlement sur le brouillage radioélectrique édicté par le ministère des Communications du Canada.

CABLETRON SYSTEMS, INC. PROGRAM LICENSE AGREEMENT

IMPORTANT: Before utilizing this product, carefully read this License Agreement.

This document is an agreement between you, the end user, and Cabletron Systems, Inc. ("Cabletron") that sets forth your rights and obligations with respect to the Cabletron software program (the "Program") contained in this package. The Program may be contained in firmware, chips or other media. **BY UTILIZING THE ENCLOSED PRODUCT, YOU ARE AGREEING TO BECOME BOUND BY THE TERMS OF THIS AGREEMENT, WHICH INCLUDES THE LICENSE AND THE LIMITATION OF WARRANTY AND DISCLAIMER OF LIABILITY. IF YOU DO NOT AGREE TO THE TERMS OF THIS AGREEMENT, PROMPTLY RETURN THE UNUSED PRODUCT TO THE PLACE OF PURCHASE FOR A FULL REFUND.**

CABLETRON SOFTWARE PROGRAM LICENSE

1. **LICENSE.** You have the right to use only the one (1) copy of the Program provided in this package subject to the terms and conditions of this License Agreement.

You may not copy, reproduce or transmit any part of the Program except as permitted by the Copyright Act of the United States or as authorized in writing by Cabletron.

2. **OTHER RESTRICTIONS.** You may not reverse engineer, decompile, or disassemble the Program.
3. **APPLICABLE LAW.** This License Agreement shall be interpreted and governed under the laws and in the state and federal courts of New Hampshire. You accept the personal jurisdiction and venue of the New Hampshire courts.

EXCLUSION OF WARRANTY AND DISCLAIMER OF LIABILITY

1. **EXCLUSION OF WARRANTY.** Except as may be specifically provided by Cabletron in writing, Cabletron makes no warranty, expressed or implied, concerning the Program (including Its documentation and media).

CABLETRON DISCLAIMS ALL WARRANTIES, OTHER THAN THOSE SUPPLIED TO YOU BY CABLETRON IN WRITING, EITHER EXPRESS OR IMPLIED, INCLUDING BUT NOT LIMITED TO IMPLIED WARRANTIES OF MERCHANTABILITY AND FITNESS FOR A PARTICULAR PURPOSE, WITH RESPECT TO THE PROGRAM, THE ACCOMPANYING WRITTEN MATERIALS, AND ANY ACCOMPANYING HARDWARE.

2. **NO LIABILITY FOR CONSEQUENTIAL DAMAGES.** IN NO EVENT SHALL CABLETRON OR ITS SUPPLIERS BE LIABLE FOR ANY DAMAGES WHATSOEVER (INCLUDING, WITHOUT LIMITATION, DAMAGES FOR LOSS OF BUSINESS, PROFITS, BUSINESS INTERRUPTION, LOSS OF BUSINESS INFORMATION, SPECIAL, INCIDENTAL, CONSEQUENTIAL, OR RELIANCE DAMAGES, OR OTHER LOSS) ARISING OUT OF THE USE OR INABILITY TO USE THIS CABLETRON PRODUCT, EVEN IF CABLETRON HAS BEEN ADVISED OF THE POSSIBILITY OF SUCH DAMAGES. BECAUSE SOME STATES DO NOT ALLOW THE EXCLUSION OR LIMITATION OF LIABILITY FOR CONSEQUENTIAL OR INCIDENTAL DAMAGES, OR ON THE DURATION OR LIMITATION OF IMPLIED WARRANTIES IN SOME INSTANCES THE ABOVE LIMITATIONS AND EXCLUSIONS MAY NOT APPLY TO YOU.

**UNITED STATES GOVERNMENT
RESTRICTED RIGHTS**

The enclosed product (a) was developed solely at private expense; (b) contains “restricted computer software” submitted with restricted rights in accordance with Section 52227-19 (a) through (d) of the Commercial Computer Software - Restricted Rights Clause and its successors, and (c) in all respects is proprietary data belonging to Cabletron and/or its suppliers.

For Department of Defense units, the product is licensed with “Restricted Rights” as defined in the DoD Supplement to the Federal Acquisition Regulations, Section 52.227-7013 (c) (1) (ii) and its successors, and use, duplication, disclosure by the Government is subject to restrictions as set forth in subparagraph (c) (1) (ii) of the Rights in Technical Data and Computer Software clause at 252.227-7013. Cabletron Systems, Inc., 35 Industrial Way, Rochester, New Hampshire 03866

CHAPTER 1 Introduction

1.1	Contents of This Manual.	1-1
1.2	STHI Overview.	1-1
1.2.1	LANVIEW LEDs	1-2
1.2.2	TCU Ports	1-3
1.2.3	RI & RO Ports.	1-4
1.2.4	Hub-By-Hub Bypass Control	1-5
1.2.5	Automatic Beacon Recovery Process	1-5
1.2.6	Support for Passive MAU Workgroups	1-5
1.2.7	Flash Downloads.	1-6
1.2.8	IP Address Discovery	1-6
1.2.9	Local Management	1-8
1.2.10	Remote Network Management Capabilities.	1-8
1.3	Related Manuals	1-8
1.4	Getting Help	1-8

CHAPTER 2 Requirements & Specifications

2.1	General Networking Considerations.	2-1
2.2	Operating Specifications.	2-3
2.2.1	Hubstack Interconnect Cables.	2-3
2.2.2	TCU and COM Ports	2-3
2.2.3	Supported MIB Groups.	2-5
2.2.4	Ring Speed	2-5
2.2.5	Ring Sequence	2-6
2.2.6	Safety	2-6
2.2.7	Computing Hardware	2-7
2.2.8	Environmental Requirements	2-7
2.2.9	Physical Specifications	2-7

CHAPTER 3 Installation

3.1	Installing the STHI	3-1
3.1.1	Unpacking the STHI.	3-1
3.1.2	Stacking the STHI.	3-2
3.1.3	Attaching the Strain Relief Bracket	3-2

3.1.4	Rack-Mounting the STHI	3-2
3.1.5	Wall-Mounting the STHI	3-3
3.1.6	Free-Standing Installations	3-5
3.1.7	Connecting the STHI to the Power Source	3-6
3.2	TPIM Installation	3-6
3.3	Finishing the Installation	3-6

CHAPTER 4 Troubleshooting

4.1	LANVIEW LED Signals	4-1
4.2	Trouble Resolution	4-2
4.3	The Reset Button	4-3
4.4	NVRAM Reset Switch	4-4

CHAPTER 5 Local Management

5.1	Accessing LM	5-1
5.1.1	Dumb Terminal Configuration	5-2
5.1.2	Console Cable Configuration	5-3
5.1.3	Entering LM	5-3
5.2	Using LM Screens	5-4
5.2.1	Working with LM Screens	5-4
5.2.2	Screen Hierarchy	5-6
5.2.3	Screen Introductions	5-6
5.3	The System Level Screen	5-8
5.3.1	System Date and System Time	5-8
5.3.2	IP Address	5-8
5.3.3	Subnet Mask	5-9
5.3.4	Enable IP Address Discovery	5-9
5.3.5	Enable Beacon Recovery	5-10
5.3.6	MAC Address	5-11
5.3.7	Locally Administered Address	5-11
5.4	The SNMP Community Names Screen	5-11
5.4.1	Community Name	5-12
5.4.2	Access Policy	5-12
5.5	The SNMP Traps Screen	5-13

5.5.1	Trap Destination	5-13
5.5.2	Trap Community Name	5-13
5.5.3	Enable Traps	5-13
5.6	The Chassis Status View Screen.	5-14
5.6.1	The Screen Mode Screen Command.	5-14
5.6.2	Multiplexer Configuration Fields	5-15
5.6.3	Port Configuration Fields	5-16
5.6.4	NEXT and PREVIOUS.	5-20
5.6.5	ENABLE ALL PORTS.	5-20
5.6.6	REFRESH.	5-20
5.7	The Component Status Screen	5-20
5.8	The Device Statistics Screen.	5-21
5.8.1	Screen Mode	5-22
5.8.2	REFRESH 3SEC.	5-22
5.8.3	General Counter Fields (Group 1)	5-23
5.8.4	Ring Information Fields (Group 2).	5-23
5.8.5	Isolating Errors Fields (Group 3)	5-25
5.8.6	Non-Isolating Errors (Group 4)	5-26
5.9	The SNMP Tool Screen	5-27
5.9.1	Community Name.	5-28
5.9.2	OID Prepend	5-28
5.9.3	GET.	5-28
5.9.4	GETNEXT	5-29
5.9.5	STEP.	5-29
5.9.6	WALK.	5-30
5.9.7	CYCLES.	5-30
5.9.8	RECALL-OID.	5-30
5.9.9	SET	5-30
5.9.10	REPEAT	5-31
5.9.11	Firmware Image Downloads.	5-31

Appendix A TPIM Specifications

A.1	Overview.	A-1
A.2	Twisted Pair TPIM Pinouts.	A-1
A.3	Fiber Optic TPIM Specifications	A-2

A.3.1 TPIM-F2 for Multimode Fiber A-3
A.3.2 TPIM-F3 for Single Mode Fiber. A-4

Appendix B Media Specifications

B.1 Unshielded Twisted Pair (UTP)B-1
 B.1.1 UTP Cable Categories.B-1
 B.1.2 UTP Lobe LengthsB-2
B.2 Shielded Twisted Pair (STP).B-3
 B.2.1 STP Cable CategoriesB-3
 B.2.2 STP Lobe Lengths.B-4
 B.2.3 Mixed STP Cable TypesB-4
B.3 Single Mode and Multimode Fiber Optic CablingB-5

CHAPTER 1

Introduction

Welcome to the Cabletron Systems **STHI Intelligent Stackable Token Ring Hub User's Guide**. Please read through this manual to gain an understanding of the features and capabilities of the STHI. A general knowledge of IEEE 802.5 Token Ring communications networks and their physical layer components will be helpful.

1.1 Contents of This Manual

Chapter 1, **Introduction**, outlines the contents of this manual, describes STHI features, and offers leads to further information.

Chapter 2, **Requirements & Specifications**, describes installation requirements, network guidelines, and STHI operating specifications.

Chapter 3, **Installation**, contains instructions for installing the STHI and making network connections.

Chapter 4, **Troubleshooting**, describes how to use the LANVIEW LED system to troubleshoot network problems.

Chapter 5, **Local Management**, describes how to use the Local Management application.

1.2 STHI Overview

The STHI is an SNMP compliant intelligent hub that provides basic management functionality including port and station control, statistical error and trap tracking, and enhanced beacon recovery for a Token Ring LAN. Its front panel TCU (Trunk Connector Unit) ports allow for network connections to either active stations or passive Multi-Station Access Units (MAUs) while its TPIM (Token Ring Port Interface Module) ports allow for ring expansions across a variety of media. Its rear panel HubSTACK ports provide for ring expansion through connections to multiple STHI non-intelligent hubs. See Figure 1-1.

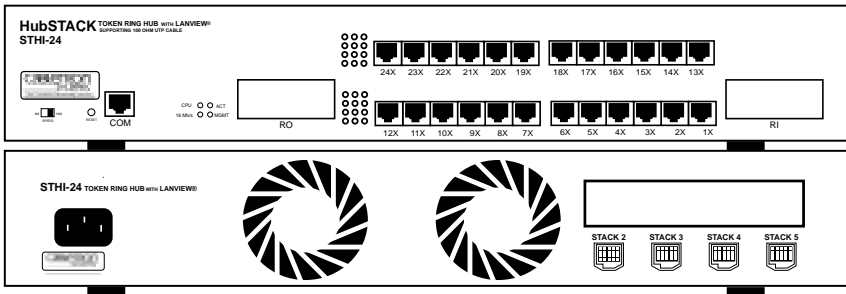

Figure 1-1. Front and Back Views of the STHI-24

The STHI may be installed as a fully managed stand-alone device, or it may be stacked with up to four STH hubs, each of which adds 12 or 24 TCU ports to the LAN, bringing the total count to a maximum of 120 managed TCU ports in the stack. The STHI serves as the logical “top” of the stack and provides full frame and error statistics for the managed ring.

The STHI fully conforms to IEEE 802.5 Token Ring specifications for connectivity to Token Ring equipment and offers the following Token Ring enhancement features:

- **Local Management**, a user interface for management control;
- **Cabletron Systems’ Automatic Beacon Recovery Process (ABRP)**;
- **Multiple Ring Out connectivity for Passive MAU workgroups**;
- **automatic speed fault protection**;
- **active filtering, equalizing, and amplifying circuitry**;
- **and LANVIEW LEDs for “at-a-glance” diagnostic monitoring.**

1.2.1 LANVIEW LEDs

Cabletron Systems’ LANVIEW status monitoring and diagnostics system is an array of LEDs which helps users to diagnose power failures, beaconing conditions, cable faults, and connection problems. Refer to Section 4.1, **LANVIEW LED Signals**, for more detail.

1.2.2 TCU Ports

The four STHI models are functionally identical with the exception of the number and type of network ports they offer:

Table 1-1. TCUs and Media Types per Model

STHI-22	12 unshielded RJ45 ports
STHI-24	24 unshielded RJ45 ports
STHI-42	12 shielded RJ45 ports
STHI-44	24 shielded RJ45 ports

Each STHI is equipped with TCU ports fitted with female RJ45 modular connector jacks to support the attachment of either STP (shielded twisted pair) or UTP (unshielded twisted pair) cabling with RJ45 connector plugs. Models that support STP cabling use RJ45 connectors that provide a grounded connection for the cabling shield. See Section 2.2.2, **TCU and COM Ports**, for pinouts.

Lobe Port and Multiple Ring Out Port Configurations

Each TCU port on the STHI is internally defaulted to operate as a lobe interface to support the insertion of a Token Ring station into a ring. However, each TCU port may also be reconfigured via the Local Management (LM) application (see Section 5.6.3, **Port Configuration Fields**) to function as a Ring Out port which will support connections to non-intelligent, passive MAU (Multi-Station Access Unit) workgroups.

Refer also to Section 1.2.6, **Support for Passive MAU Workgroups**.

Ring Speed Fault Protection

STHI hubs also provide Ring Speed Fault Protection on each TCU port to protect against beaconing conditions caused by stations inserting at the wrong ring speed. If a ring speed mismatch is detected, the STHI blocks the port to keep the misconfigured station isolated from the ring and provides a simple visible LED signal (blinking red at the port's LED) to indicate that Ring Speed Fault Protection is blocking the port. The port remains blocked until the ring speed mismatch condition is removed or resolved.

Active Circuitry

On each TCU port, STHI hubs provide active circuitry which filters, equalizes, and amplifies all received signals before transmitting them to the next point on the ring. The result is enhanced signal integrity and extended maximum station lobe cable distances.

Daughter Board Upgrade Kit

The following daughter board upgrade kits may be used to expand STHI hubs from 12 to 24 TCU ports:

- TR-UTP-UGKT for STHI-22.
- TR-STP-UGKT for STHI-42.

1.2.3 RI & RO Ports

The STHI incorporates a pair of RI/RO port sockets for Token Ring Port Interface Modules (TPIMs). This Ring In / Ring Out port pair allows for the expansion of the main ring to other hubs. Refer to Section 5.6.3, **Port Configuration Fields**, Subsection **RING OUT ENABLE Mode**, for the procedure to enable RI/RO ports.

Essentially, TPIMs are media adapters which enable their host modules to expand their network connections to other media types. The TPIM models listed in Table 1-2 are produced by Cabletron Systems and may be installed in the RI/RO port sockets on the STHI. Refer to Section 3.1, **Installing the STHI**, for installation instructions.

Table 1-2. TPIMs, Supported Media, and Connectors

TPIM	Media Type	Connector
TPIM-T1	Shielded Twisted Pair	DB9
TPIM-T2	Unshielded Twisted Pair	RJ45
TPIM-T4	Shielded Twisted Pair	RJ45
TPIM-F2	Multimode Fiber	ST
TPIM-F3	Single Mode Fiber	ST

1.2.4 Hub-By-Hub Bypass Control

Unless otherwise configured by a user, all hubs in an STH/STHI stack are interconnected to form a continuous Token Ring. Through Local Management, however, each hub may be individually bypassed from the continuous ring to form its own isolated ring which does not exchange data with the other hubs.

If an STH is bypassed from the main ring, the STH module will not receive data-dependent services such as statistical tracking and beacon recovery, but other physical control functions such as port configuration remain unaffected. If the STHI is bypassed, only its TCUs are actually bypassed from the stack's common ring: TPIM Ring ports and management systems maintain their connection to the stack's common ring.

Refer to Section 5.6.2, **Multiplexer Configuration Fields**, for instructions regarding bypass control.

1.2.5 Automatic Beacon Recovery Process

To guard the network against operational interruptions due to beaconing conditions, the STHI protects itself and its attached STH hubs with Cabletron Systems' advanced Automatic Beacon Recovery Process. ABRP engages more quickly and is able to treat conditions beyond the scope of the IEEE standard beacon recovery process. The STHI automatically partitions problematic lobes from the ring, allowing the rest of the ring to continue operating. The hub checks partitioned Ring In/Out ports periodically and re-enables them automatically if they have recovered; partitioned TCU ports remain disabled until re-enabled by a user.

1.2.6 Support for Passive MAU Workgroups

By default, each TCU port is configured to its STN (station) setting to support lobe connections to stations. Whereas a station signals a TCU to open its interface by providing phantom current down its lobe cable, a passive Multi-Station Access Unit cannot provide phantom current. To allow for MAU connections, the user may reconfigure TCU ports via Local Management to function in Ring Out mode. A TCU port in Ring Out mode looks for the presence of data bits, rather than phantom current, to determine link status. Refer to Section 5.6.3, **Port Configuration Fields**, Subsection **RING OUT ENABLE Mode**, for configuration instructions.

Improved Protection from Beaconing

By utilizing multiple Ring Out TCU ports, users can provide enhanced reliability for existing networks which use passive MAUs because Ring Out TCU ports allow for the separate attachment of each MAU. Rather than daisy-chaining MAUs together as a single entity and risking their collective isolation in case of beaoning, the user can now attach each MAU individually, reducing the number of MAU ports that are at risk; ABRP is able to bypass individual Ring Out-to-MAU connections on an individual basis, leaving other workgroups unaffected. See Figure 1-2.



The Ring Out TCU configuration does not provide for the MAU's redundant connection to the ring. To achieve dual attachment to a MAU, use the Ring In and Ring Out TPIM ports.

1.2.7 Flash Downloads

New and updated firmware may be downloaded into the STHI hub's Flash EPROMs. This process may be executed by Cabletron's Remote LANVIEW / Windows, version 3.0 or later, or by any device using BOOTP or TFTP protocols. Refer to Section 5.9.11, **Firmware Image Downloads**, for download instructions.

1.2.8 IP Address Discovery

The STHI supports IP Address Discovery. Through a BootP server (a network device that holds a user-defined list of MAC addresses and corresponding IP addresses), network managers may attribute an IP address to any known MAC address. When the STHI is powered up without an IP address and IP Address Discovery is enabled, it issues BootP requests at user-set intervals, essentially asking "does anybody know my name?" If the BootP server recognizes the MAC address, it tells the STHI what IP address has been attributed to it. If no BootP sever responds after 500 request cycles, the STHI automatically boots from its own FLASH memory and remains without an IP address until a user provides one through the Local Management interface.

Each STHI has on its backplate a sticker which indicates its MAC address.

DAISY-CHAIN MAU CONFIGURATION

When MAUs are daisy-chained, they are connected as single collective entity.

The entire chain must be bypassed

to isolate the hub from a single beaoning station.

All stations lose connection if beaoning occurs on any station.

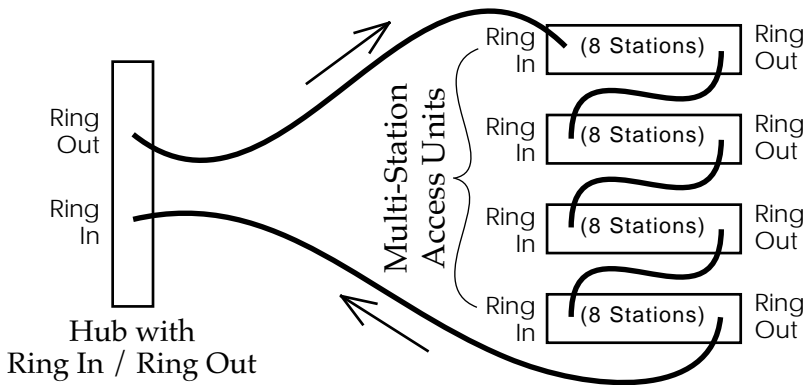

RING OUT TCU MAU CONFIGURATION

When each MAU is individually connected to the STHi hub,

only one MAU must be bypassed

to isolate the hub from a beaoning MAU station.

The stations on that MAU still go down,

but the remaining MAUs and their stations stay operational.

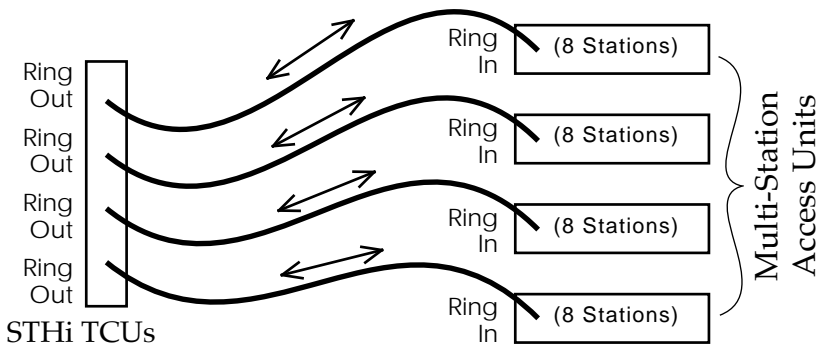

Figure 1-2. Improved Beacon Recovery Resolution for MAUs

1.2.9 Local Management

The STHI hub's Local Management application displays packet and error statistics for the entire stack, for each individual device, or for individual ports, and enables the user to provide management support for the STHI and all its attached segments.

Users with actual or emulated VT100 dumb terminals may access Local Management out-of-band via the RJ45 COM port. Refer to Section 5.1 for connection instructions.

1.2.10 Remote Network Management Capabilities

The STHI may be managed remotely by a variety of SNMP network management systems including the following from Cabletron Systems:

- Cabletron Systems SPECTRUM®
- Cabletron Systems Remote LANVIEW®/Windows™
- Cabletron Systems Remote LANVIEW® for SunNet™ Manager

1.3 Related Manuals

Use the Cabletron Systems **STH-22/24 /42/44 User's Guide** to supplement the procedures and other technical data provided in this manual. The procedures contained therein are referenced where appropriate, but are not repeated in this manual.

1.4 Getting Help

To present any questions, comments, or suggestions concerning this manual or any Cabletron Systems Product, please contact Cabletron Systems Technical Support:

By phone	(603) 332-9400 Monday-Friday; 8am - 8pm EST
By CompuServe®	GO CTRON from any ! prompt
By Internet mail	support@ctron.com
By Fax:	(603) 337-3075
By BBS:	(603) 337-3750

By FTP	ctron.com (134.141.197.25) Login: <i>anonymous</i> Password: <i>your email address</i>
By United States Postal Service	Cabletron Systems, Inc. P.O. Box 5005 Rochester, NH 03866-5005

CHAPTER 2

Requirements & Specifications

This chapter describes network guidelines, power requirements, and operating specifications for the STHI. Before performing the installation, read this chapter and confirm that the network meets the requirements and conditions specified herein. Failure to follow these guidelines may result in poor network performance.

Refer to Appendix A, **TPIM Specifications**, for TPIM specifications.

Refer to Appendix B, **Media Specifications**, for cable specifications.

2.1 General Networking Considerations

Take care in planning and preparing the cabling and connections for the network. The susceptibility of the LAN's cables to crosstalk and noise determines the network's error rate, and thus, the efficiency of data propagation on the network. The quality of the connections, the length of cables and other conditions of the installation are critical factors in determining the quality of the network.

All devices connected to the STHI must meet IEEE 802.5 Token Ring specifications.

Maximum Number of Stations on a Ring

The maximum stack composed of four 24-port STH hubs and one 24-port STHI offers a total of 120 TCU ports, but the number of ports available on the LAN may be increased by the use of passive Multi-Station Access Units (see to Section 1.2.6, **Support for Passive MAU Workgroups**) and TPIM Ring In / Ring Out connections to other devices (see Section 1.2.3, **RI & RO Ports**).

While there is no recommended limit to the number of TCU ports to be made available in a stack, the recommended maximum number of stations to be inserted simultaneously into a single ring is 255 when using STP lobe cabling and 150 when using UTP cabling anywhere on the ring. If the ring has been extended through RI/RO connections, consider the number of ports on ring extensions as well as those in the stack itself.

Crosstalk

Crosstalk is interference caused by signal coupling between different cable pairs contained within a multi-pair cable bundle. Multi-pair cables should not be used for UTP lobe cabling. Avoid mixing Token Ring signals with other applications (voice, etc.) within the same cable.

Noise

Noise can be caused by either crosstalk or externally induced impulses. Outside systems (motors, switching equipment, fluorescent lighting, high amperage equipment) may produce electrical interference causing noise. The number and quality of cable connections also contribute considerably to noise levels. To reduce noise induced errors, it may be necessary to re-route cabling away from potential noise sources, or to ensure that the electrical wiring in the area is properly wired and grounded, or to replace connectors along affected segments.

Temperature

Signal attenuation varies significantly with temperature when PVC-insulated cable is used. In areas where temperatures exceed 40°C, it is strongly recommended that plenum-rated cables be used instead to ensure that signal attenuation remains within specifications.

Installation Recommendations

In addition to complying with the cable specifications presented in Appendix A, **TPIM Specifications**, the cabling installation should comply with the following recommendations to obtain optimum performance from the network:

- UTP cabling should be free of splices, stubs, or bridged taps.
- Metal troughs, ducts, etc. carrying Token Ring signals should be properly grounded.
- Cables should be routed away from sources of electrical noise, such as power lines, fluorescent lights, electric motors, radio interference, and heavy machinery.
- Token Ring signals should not be routed through UTP cables that exit a building or which are adjacent to cables either exiting a building or exposed to lightning strikes and power surges.

- UTP cables that contain Token Ring signals should not be simultaneously used for applications which may impress high voltages (greater than 5 volts) with sharp rise or fall times, since the noise coupling from such signals could directly cause errors on the Token Ring network.
- Where practical, dedicated cable should be used for Token Ring signals.
- Work area wall plates and outlets used for the Token Ring network should be clearly labeled as Token Ring network lobe connections.

2.2 Operating Specifications

Cabletron Systems reserves the right to change these specifications without notice.

2.2.1 Hubstack Interconnect Cables

Cabletron's HubSTACK Interconnect cables (Part Number 9380141) must be used when interconnecting STH devices with the STHI.

2.2.2 TCU and COM Ports

The STHI hub's network ports are female RJ45 connectors. The pinouts shown in Figure 2-1 are common to all STHI and STH TCU ports.

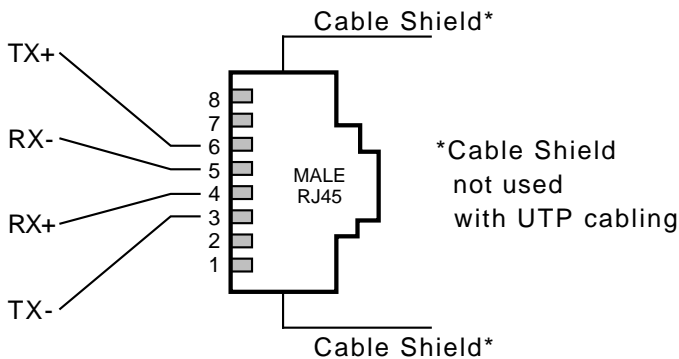

Figure 2-1. TCU pinouts

On STHI models -42/-44, each RJ45 connector is encased in a metallic shield which provides a means of connection for the STP cable shield.

Shield continuity is maintained by contacts within the female RJ45 that contact the metallic casing of the male RJ45 on the STP lobe cable.

The COM port is a female RJ45 connector supporting EIA RS232C connections via cables with pinout configurations as specified in Figure 2-2 or Figure 2-3.

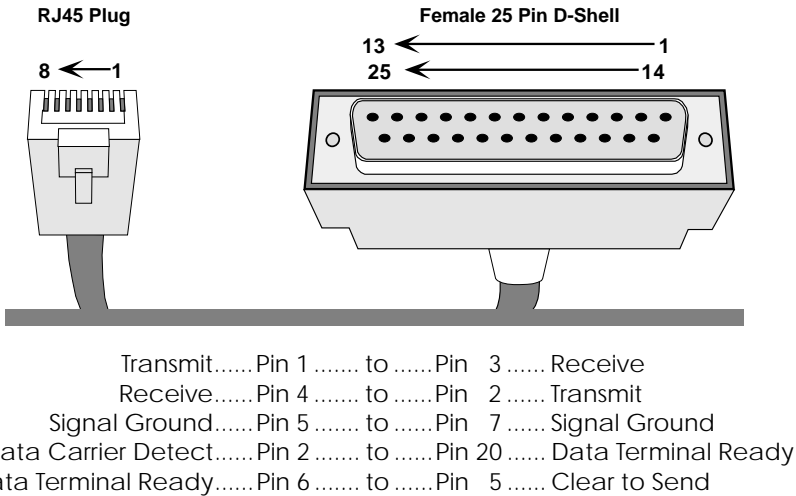

Figure 2-2. RJ45 to DB25 Connector Pinout

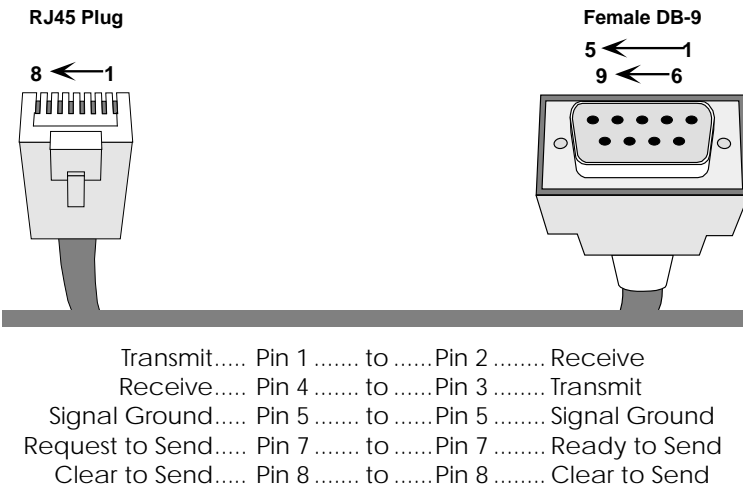

Figure 2-3. RJ45 to DB9 Connector Pinout

2.2.3 Supported MIB Groups

The STHI provides access to the following Management Information Base groups and their respective functionality:

Standard MIBs

- MIB-2 (RFC 1231)

Cabletron Enterprise MIBs

- Download
- MIB-II Extensions
- Token Ring FNB (Flexible Network Bus)
- DOT 5 Physical & Logical
- Token Ring Station Assignment
- Device
- PIC MIB (Product Information Chip MIB)
- Chassis MIB

2.2.4 Ring Speed

The operating ring speed for the STHI may be set via the Ring Speed Switch on the front face of the STHI or by MIB commands via the SNMP Tool screen in Local Management.

The STHI hub's Ring Speed switch setting is read only at power-up. In order to change the ring speed via the Ring Speed switch, the user must first change the switch setting and then reset the STHI (see Section 4.3, **The Reset Button**).

MIB commands override the Ring Speed switch setting. Once the switch setting has been overridden, the MIB command ring speed setting will remain in effect at all subsequent power-ups as long as the switch setting is not changed. MIB commands are accessible through the MIB Navigator screen on the intelligent hub's Local Management application and through other SNMP network management software packages including Cabletron Systems' Remote LANVIEW[®]/Windows.

The user may cancel the MIB override and regain switch control over the STHI hub's ring speed by changing the current switch position and resetting the STHI by the reset button.



*When cancelling a MIB override, the user may have to reset **twice** (as described in the steps below) to actually **change** the STHI hub's ring speed by the switch.*

To return to switch control from a MIB-overridden Ring Speed setting:

1. **Regain switch control.** Regardless of the actual desired ring speed, the user must toggle the switch out of its current position and then reset the STHI to put a switch-position change into effect, cancelling the MIB override.
2. **Select the desired ring speed.** If the Ring Speed switch setting is not yet the desired setting (it may now be the same as the setting dictated by the MIB command), the user must again change the switch setting and reset the STHI to complete the change from the MIB-commanded speed setting to the desired switch-set speed setting,

2.2.5 Ring Sequence

The ring sequence for the stations on the ring (the order in which stations are logically arranged on the ring) is determined by the physical location of each TCU connection, progressing in ascending stack number and port number order. The sequence is changed each time a station is inserted or de-inserted from a ring.

To determine the ring sequence, consider only those ports inserted into the ring. Beginning at the STHI hub's lowest numbered inserted port, list in ascending numerical order the number of each inserted port. If STH hubs have been stacked to the STHI, then continue by listing those inserted in the STH hub numbered lowest in the stack. Repeatedly move to each next STH and list the inserted ports in numerical order until all ports inserted into the ring have been listed. The order is continuous, wrapping directly from the stack's last inserted port to the first—from the bottom of the list, right back to the top.



Hubs that are bypassed from the stack's common ring must not be counted in the common ring sequence; they comprise their own separate rings with separate ring sequences.

2.2.6 Safety

This equipment is designed in accordance with UL478, UL910, NEC 725-2(b), CSA, IEC, TUV, VDE Class A, and meets FCC Part 15, Class A limits.

2.2.7 Computing Hardware

Operating System Memory:	2.0 MB
Internal Processor:	Intel i960 operating at 16 MHz
Non-Volatile RAM:	128 KB with battery back-up
EPROM:	128 KB
FLASH MEMORY:	1 MB

2.2.8 Environmental Requirements

Operating Temperature:	+5° to +50° C fluctuation $\leq 10^\circ$ per hour
Non-operating Temperature:	-30° to +90° C
Operating Humidity:	5 to 95% (non-condensing)

2.2.9 Physical Specifications

Dimensions:	2.8 H x 17.0 W x 8.0 D inches (7.2 x 43.6 x 20.5 cm)
Predicted MTBF: (mean time between failure)	STHI-22/42: 523,989 hours STHI-24/44: 505,811 hours

CHAPTER 3

Installation

This chapter outlines the procedure for installing the STHI. Confirm that the network meets the guidelines and requirements outlined in Chapter 2, **Requirements & Specifications**, before installing the STHI.

3.1 Installing the STHI

The STHI may be installed as a stand-alone hub or as part of a stack. Provided with the STHI is an accessory kit that includes rack-mount brackets for installations into 19 inch racks, wall-mount brackets and mounting screws for installations on walls, and a strain relief bracket to direct the stresses inflicted by cables hanging from the TCU ports.

All installations must meet the following requirements:

- A single phase 120Vac, 15A, grounded power receptacle must be located within 7 feet of the STHI.
- Shelving units must be able to support 30 pounds of static weight for each device in the stack. This accounts for both hub and cable weight.
- The ambient temperature must be maintained between -30° and 90°C at all times and between 5° and 50°C during operation.

3.1.1 Unpacking the STHI

Unpack the STHI as follows:

1. Carefully remove the STHI from the shipping box, preserving the packaging materials for future transport.
2. Visually inspect the STHI. If there are any signs of damage, contact Cabletron Systems Technical Support immediately.
3. Read any Release Notes or Addendums included in the shipping box.



The package includes a 3-1/2" floppy disk containing a backup copy of the STHI's Flash Firmware Image File which may be downloaded to the STHI if the original image becomes corrupted.

3.1.2 Stacking the STHI

The rear panel of the STHI has four STACK ports exclusively reserved for connections to STH modules. Refer to the STH manual for stacking instructions.

3.1.3 Attaching the Strain Relief Bracket

To reduce lateral stresses imposed on TCU ports and cable plugs by the weight of cables hanging from the TCU ports of a horizontally mounted STHI, the strain relief bracket ensures that cable forces pull nearly straight out from the port, rather than prying sharply downward.

Attach the strain relief bracket to the front of the STHI as follows:

1. Locate the strain relief bracket and four 8-32 x 3/8" screws.



Use of longer screws may cause damage to the unit or electrical shock to the user.

2. Carefully turn the STHI upside down.
3. Attach the strain relief bracket to the bottom of the STHI as shown in Figure 3-1.

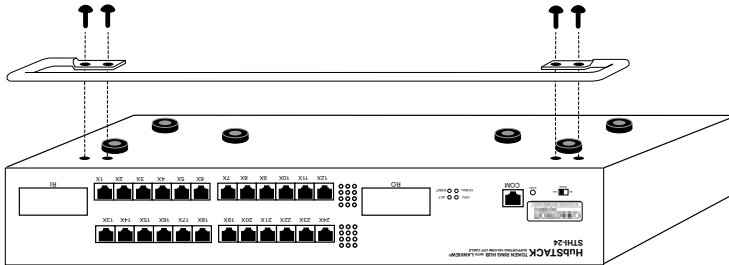

Figure 3-1. Attaching the Strain Relief Bracket

3.1.4 Rack-Mounting the STHI

Perform these steps to install the STHI in a 19-inch rack:

1. Remove the four cover screws (two from each side) located near the front-most edges of each side of the STHI.
2. Using the four screws removed in step 1, attach the rack-mounting brackets to each side of the STHI as shown in Figure 3-2.

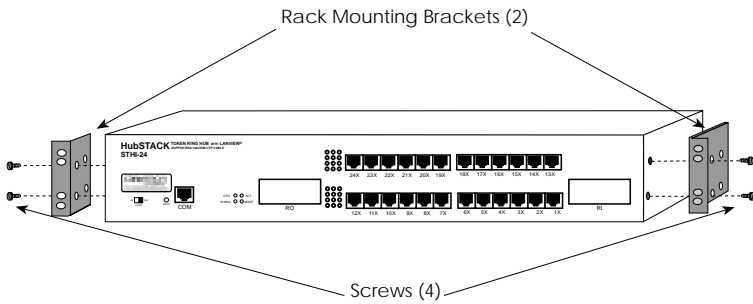

Figure 3-2. Installing the Rack-Mount Brackets

3. With the mounting brackets installed, position the STHI between the vertical frame members of the 19-inch rack and fasten it securely with the mounting screws as shown in Figure 3-3.

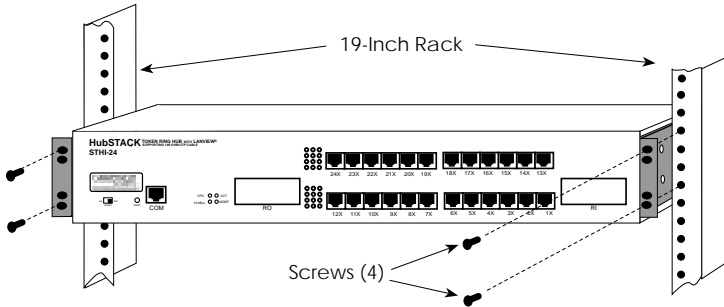

Figure 3-3. Installing the STHI in a Rack

3.1.5 Wall-Mounting the STHI

When an STHI is installed on a wall, it must face downward so that all attached cables will hang straight out from the TCUs, rather than prying at angles to the ports.

1. Use the provided 3/8" screws to attach the wall-mounting brackets to the bottom of the STHI as shown in Figure 3-4. There are two brackets, one for each side.

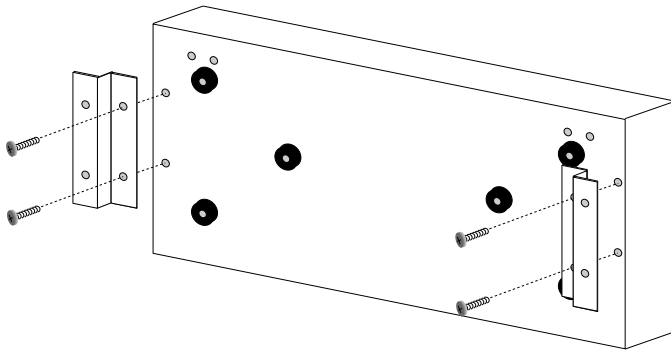

Figure 3-4. Installing the Wall-Mounting Brackets

2. Select a wall location for the STHI within 7 feet of a power outlet.



Potential *SHOCK HAZARD*: Select a wall location where pilot holes for screws will not intersect with electrical wiring in the wall.

3. Get a pencil and refer to Figure 3-5. With the wall-mounting brackets attached to the STHI, position the STHI against the wall where it will be permanently mounted, with the network ports facing down, and mark the screw holes' positions on the wall.
4. Set the STHI aside and carefully drill four 1/4" pilot holes for the screw anchors, one at each mark made in step 3.
5. Install the screw anchors. If installing on a hollow wall, use the provided Molly bolt anchors (pictured in collapsed form as "Hollow Wall Anchor" in Figure 3-5): insert the anchor into the hole, tighten the screw to collapse the anchor's bracing arms, and remove the screw. If installing on a solid wall, a different type of anchor will be required.
6. Position the STHI on the wall, aligning the screw holes over the anchors, and fasten the STHI to the anchors with the four anchor screws. Tighten the screws.

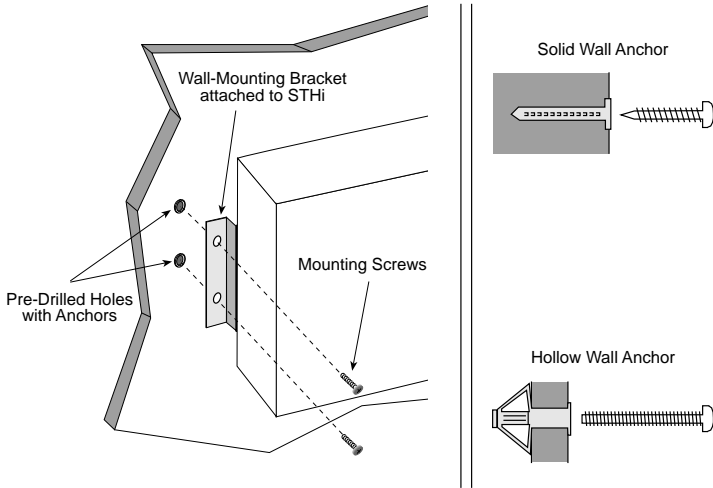

Figure 3-5. Wall-mounting the STHi

3.1.6 Free-Standing Installations

For a free-standing shelf of table-top installation, install the STHi on an unrestricted free surface area 21 inches wide, 18 inches deep, and 6 inches high, within 7 feet of its power source, as shown in Figure 3-6.

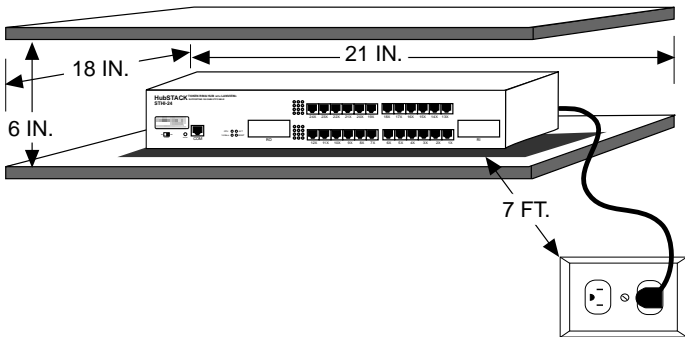

Figure 3-6. Shelf or Table-top Installation

3.1.7 Connecting the STHI to the Power Source

Plug one end of the power cord into the back panel of the STHI and connect the other end into a grounded wall outlet. Verify that the PWR LED is on, indicating that the STHI is receiving power.

3.2 TPIM Installation

TPIM use is an option, not a requirement, for STHI operation.



Electrostatic Discharge (ESD) can damage the TPIM. Observe all precautions to prevent electrostatic discharges when handling the TPIM. Avoid touching the components or surface of the board. Hold only the edges of the board or the metal front panel.

Install a TPIM as follows:

1. Remove the TPIM port coverplate from the STHI hub's faceplate.
2. Carefully insert the TPIM into the TPIM port with its edges in the guide tracks. The TPIM seats firmly, snug against the face of the STHI when the connector pins on the back of the TPIM are fully inserted into their pin slots.
3. Finger-tighten the mounting screw (upper right-hand corner of the TPIM faceplate) to secure the TPIM in place.

3.3 Finishing the Installation

Before placing the network into service, test the installation thoroughly, making sure that all stations can receive data and that the STHI and all connected stations are indicating normal operation. Confirm that the networking software is configured properly to match the installed network. If problems emerge, proceed to Chapter 4, **Troubleshooting**.

CHAPTER 4

Troubleshooting

This chapter contains instructions for using LANVIEW LEDs to troubleshoot physical layer network problems.

4.1 LANVIEW LED Signals

The STHI incorporates the Cabletron Systems LANVIEW Status Monitoring and Diagnostics System. These LEDs can help in the diagnosis of physical layer problems such as power failures or cable faults. Table 4-1 lists the LANVIEW LEDs and defines their messages:

Table 4-1. LANVIEW LED Signals

LED	Color	Condition
CPU	blinking Green	normal operations
	Red	malfunction
ACT	Green flash	normal frame received
	Red flash	Beacon Recovery running
16 Mb	Yellow	Ring Speed set to 16 Mbps.
	off	Ring Speed set to 4 Mbps.
MGMT	Green	management operational
	Red	management failure

Table 4-1. LANVIEW LED Signals (Continued)

LED	Color	Condition
Ports	off	Port enabled but not linked.
	Green	Port enabled and linked.
	Red	Port disabled (or set to Ring Out) and not linked.
	blinking Red	Ring Speed Fault -OR- Port linked but disabled.

4.2 Trouble Resolution

If this section does not guide the user to a solution, please contact Cabletron Systems Technical Support (see Section 1.4, **Getting Help**.)

Loss Of Power

If the STHI is having power problems, check the power delivery system (power cable, power outlet, circuit breaker, fuse).

Failure to Link on Enabled Port

Check that the Token Ring devices at either end of the cable are powered-up.

Verify that the network cable's connectors have the proper pinouts. Refer to Section 2.2.2, **TCU and COM Ports**.

Check the cable for continuity. A variety of tools are available for this test, depending on the media being used.

Check that the cables meet specifications for dB loss as described in Appendix A, **TPIM Specifications**.

Ring Speed Fault

The network device being linked at this port is operating at a ring speed different from the STHI hub's currently set ring speed. Set the two devices to the same speed.

Management Failure

If the MGMT LED is red, try resetting the STHI. If this does not resolve the problem, contact Cabletron Systems Tech Support. Meanwhile, the STHI will continue to operate, but will not provide Beacon Recovery or statistical monitoring.

4.3 The Reset Button

The STHI incorporates a recessed Reset button (see Figure 4-1). Pressing this button causes the STHI to clear all counters, run all startup diagnostics, and reload the flash resident firmware into the CPU local memory. It does NOT initialize Non-Volatile Random Access Memory (NVRAM), the battery-backed random access memory where the STHI stores network management parameters. (See also Section 4.4, **NVRAM Reset Switch.**)

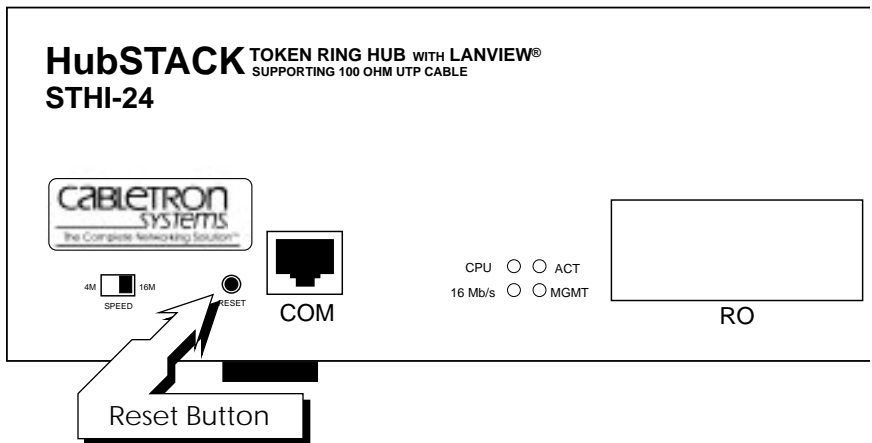

Figure 4-1. Reset Button



Management services will be suspended during the reset process.

4.4 NVRAM Reset Switch

The STHI incorporates a recessed NVRAM Reset switch (see Figure 4-2) which initializes NVRAM, the nonvolatile random access memory. To use it, toggle the switch and then reset the STHI. This clears all user configurations and settings and returns the STHI to its factory defaults.

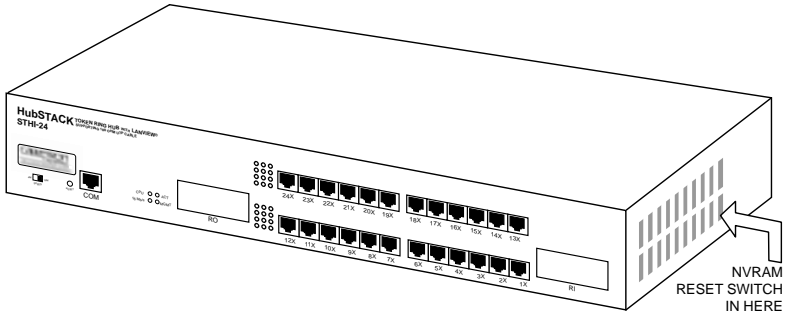

Figure 4-2. NVRAM Switch

CHAPTER 5

Local Management

This chapter explains how to set up a console to access the STHI's Local Management interface (LM) and explains how to use LM screens and commands.



Users wishing to skip instructions for connecting a management terminal to the STHI may proceed directly to Section 5.2 for instructions regarding the use of LM.

LM enables the user to perform the following actions on the STHI and all of its attached segments:

- assign an IP address and subnet mask to the STHI;
- select a default gateway for the transmission of SNMP traps;
- configure, enable, and disable ports throughout the stack;
- control access to the STHI through community names;
- designate which Network Management Stations (NMS) are to receive trap messages from the device;
- access and manipulate the Management Information Base (MIB);
- and view statistics regarding errors, beacons, and traffic for the entire stack, individual module, or individual port.

5.1 Accessing LM

To access LM, the user needs the following equipment:

- an actual or emulated Digital Equipment Corporation VT series terminal.
- a console cable to attach the management terminal to the STHI. Refer to Section 2.2.2, **TCU and COM Ports** for pinout information.



The STHI is shipped with a UTP console cable with RJ45 connectors on each end and adapters for DB9 or DB25 connections. The user must provide the terminal.

5.1.1 Dumb Terminal Configuration

Configure the LM console according to the parameter settings defined in Table 5-1. On VT100/200/300 series terminals, press *F3* to access the Setup Directory. For setup parameters not listed in the following table, any selection should be acceptable. Refer to terminal's manual for more instructions if necessary.

Table 5-1. Setup Requirements for LM Console

Menu	Parameter	Setting
Display Setup:	Columns	80 Columns
	Controls	Interpret controls
	Auto wrap	No Auto wrap
	Text Cursor	No Cursor
General Setup:	Mode	VT100, 7 bit control
	Cursor keys	Normal cursor keys
Communications Setup:	Transmit	(all values from 2400 to 19,200 accepted)
	Receive	Receive = transmit
	Bits, parity	8 Bits, no parity
	Stop Bit	1 Stop Bit
	Local Echo	No Local Echo
	Port	Data Leads Only
	Auto Answerback	No Auto Answerback
Keyboard Setup:	Keys	Typewriter keys
	Margin bell	Margin bell
	Warning bell	Warning bell
	Auto Answerback	No Auto Answerback

5.1.2 Console Cable Configuration

Connect the console cable to the STHI as follows:

1. Attach the male RJ45 connector to the COM port of the STHI.
2. Attach the female end to the 25-pin or 9-pin COM port on the terminal.

5.1.3 Entering LM

After configuring the LM terminal and properly attaching the cable to the STHI, the user may access the Local Management interface.

1. Activate the console: power up the terminal, or run the emulator program. After the STHI is fully booted, the STHI Password screen shown in Figure 5-1 appears on the console's monitor.

```
                STHI LOCAL MANAGEMENT

                Cabletron Systems, Incorporated
                  P.O. Box 5005
                Rochester, NH 03866-5005
                  (603) 332-9400

                (c) Copyright Cabletron Systems, Inc. 1995

                Flash Image Version:  1.00.00
                Boot EPROM Version:   01.00.00
                Board Revision:       112

                Enter User Password:
```

Figure 5-1. Password Screen

2. Enter a password. (There are two factory default passwords for super-user access: "public" and a blank entry.) Then press the **Return** key.

Passwords are user-definable and may be accorded varying degrees of access to the functions of LM. Refer to Section 5.4, **The SNMP Community Names Screen**, for details.

If the password entry is invalid, the entry is cleared and the cursor returns to the beginning of the password entry field. If the password is valid, the associated access level in effect for the session is reported briefly on the

bottom line of the screen, then the Main Menu screen shown in Figure 5-2 appears.

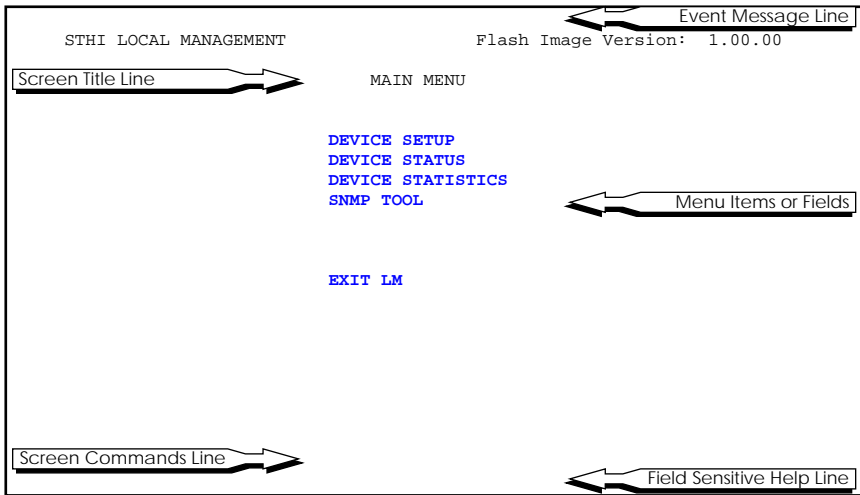

Figure 5-2. Main Menu with Screen Anatomy Labels



As a precaution against unauthorized access, if LM detects no keyboard activity for 15 minutes, it closes the current session and returns to the Password screen.

5.2 Using LM Screens

5.2.1 Working with LM Screens

This section describes how to work with all LM screens. Refer to Figure 5-2 for screen anatomy.

Invoking Menu Options or Screen Commands

1. Use the **Tab** key or **arrow** keys to highlight the item.
2. Press the **Return** key.

Invoking a menu option opens the named screen.

Invoking a screen command executes the named action. The **RETURN** screen command returns the user from the current screen to its parent screen. The **SAVE** or **EXECUTE** screen commands record all entries set on the screen and put them into effect.

Setting or Modifying Fields

The Field Sensitive Help Line offers help while certain fields are selected. The Event Message Line reports the status of certain field-related actions (e.g.: “Saved OK” or “Bad Value”).

1. Use the **Tab key** or **arrow keys** to highlight fields.
2. Set the new value:

With toggle fields (those that appear in square brackets), use the **Return** key to scroll through to the desired option.

There are two edit methods available in each editable field. All editable fields offer the same first method: replace the entire current string simply by typing into the field. As for the second method, some fields offer “return to default,” others offer “overstrike.” If a field has a default value, the default may be restored simply by selecting the field and pressing **Return**. If the field has no default, pressing **Return** activates the overstrike mode whereby the user may use the arrow keys to move through the current string and replace individually selected characters by typing new ones in their place. Press **Return** again to exit overstrike mode.

3. Invoke the **SAVE** command at the bottom of the screen to store all settings currently shown on the screen, or skip this step to throw away all recent screen edits since last save when exiting the screen.

If a user with an ineligible access level attempts to edit a restricted-access field, a message of refusal appears on the Event Message line. Refer to Section 5.4.2, **Access Policy** for details.

Exiting the Local Management Interface Session

1. Return to the Main Menu by invoking **RETURN** on each screen.
2. Invoke the Main Menu’s **EXIT LM** command to close the session and return to the Password Screen. (Enter a password to regain entry.)

The user may leave the connection active, or simply disconnect the terminal or stop the emulator program.

5.2.2 Screen Hierarchy

Figure 5-3 illustrates the organization of the entire LM screen system.

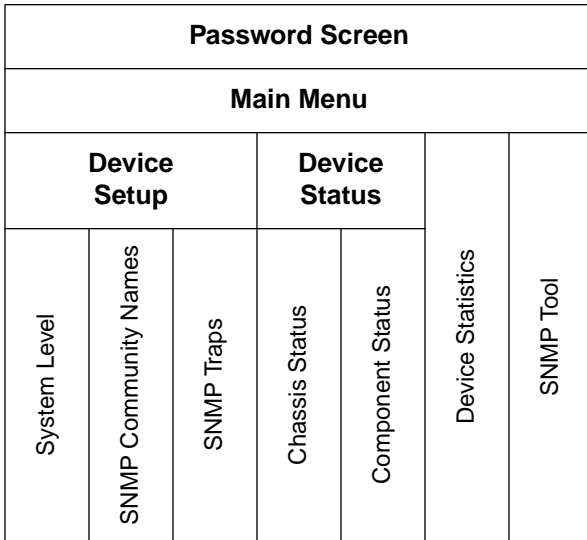

Figure 5-3. LM Screen Hierarchy

The Main Menu screen offers access to the Device Setup screen, the Device Status screen, the Device Statistics screen, and the SNMP Tool screen.

5.2.3 Screen Introductions

System Level

The System Level screen (Section 5.3) is used to provide the STHI with basic configuration settings including IP address, Locally Administered physical address, subnet mask, Beacon Recovery options, and Runtime IP Address Discovery.

SNMP Community Names

The SNMP Community Names screen (Section 5.4) is used to specify SNMP community names and their respective levels of access to LM (read-only, read-write, super-user).

SNMP Traps

The SNMP Traps screen (Section 5.5) is used to designate which Network Management Workstations will receive SNMP traps from the STHI, and to provide those stations with community names for access to various MIBs.

Chassis Status View

The Chassis Status View screen (Section 5.6) is used to monitor and configure the modules in the stack, to set operational configurations for TCU ports and RI/RO ports, and to execute port/module bypassing.

Component Status

The Component Status screen (Section 5.7) is used to view the operational status of various functional entities within the STHI.

Device Statistics

The Device Statistics screen (Section 5.8) is used to view network performance statistics and network configuration information.

SNMP Tool

The SNMP Tool screen (Section 5.9) is used to view and manipulate MIB objects.

5.3 The System Level Screen

Access the System Level screen (Figure 5-4) from the Device Setup menu.

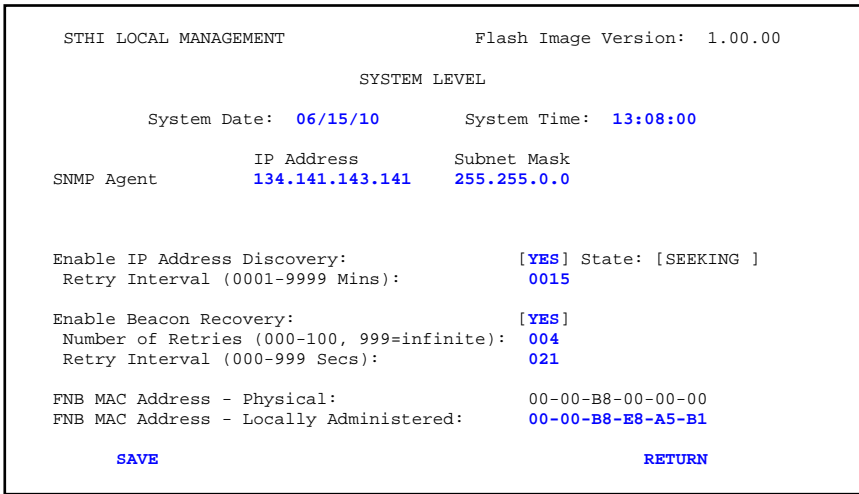

Figure 5-4. System Level Screen

5.3.1 System Date and System Time

Use these fields to set the correct date and time.

Type the date into the field in a MM/DD/YY format for the date, and HH:MM:SS for the time. If the format entered is invalid, the message “Invalid Date” or “Invalid Time” appears and the edit is rejected.

5.3.2 IP Address

Use this field to set the host Internet Protocol (IP) address for the STHI.

If the IP Address is changed, the STHI will execute a soft-reset after **SAVE** is invoked to re-initialize all affected parameters.



Only a user with Super-User access can change the device's IP address. See Section 5.4 for information about Super-User access.

5.3.3 Subnet Mask

The Subnet Mask determines how the STHI directs SNMP Trap messages (discussed in Section 5.5). The mask defines the portion of the trap destination's IP address to be compared to the IP address of the STHI. If the designated address portions match, the destination station is determined to exist on the same subnet as the STHI; Network Management Stations (NMS) within the STHI hub's own subnet are addressed directly. Traps destined for stations on other subnets are sent through a router.

- Set a new value for the Subnet Mask when workstations designated to receive traps reside on a different subnet. In most cases, 255.255.0.0 (the 8-bit subnet mask) is the appropriate mask.
- Use the Subnet Mask setting of 0.0.0.0 when all workstations designated to receive trap messages exist within the same subnet as the STHI.

If the Subnet Mask is changed, the STHI will execute a soft-reset after **SAVE** is invoked to re-initialize all affected parameters.

5.3.4 Enable IP Address Discovery

This Yes/No toggle field is used to enable/disable IP Address Discovery. (Refer to Section 1.2.8, **IP Address Discovery**.) Use the **Return** key to toggle the field. When the toggle field set to **YES** and **SAVE** is invoked, the accompanying **State** field indicates that the device is **SEEKING** an IP Address. If it finds one, the **State** field indicates **ACQUIRED**. If it fails 500 times, it displays **FAILED**.

Retry Interval

The **Retry Interval** field determines the duration between automatic attempts at IP Address Discovery. Each attempt takes about one half-minute. The STHI then waits for as many minutes as specified in the **Retry Interval** field before trying again. This cycle continues until the address is acquired, the IP Address Discover feature is disabled, or the process is attempted 500 times.



*To force an immediate check, rather than waiting for the next cycle, toggle **Enable IP Address Discovery** to **NO** and then to **YES** again, and then invoke **SAVE**.*

5.3.5 Enable Beacon Recovery

This field allows the user to enable or disable the STHI's Advanced Beacon Recovery Process (ABRP).

Beaconing is part of a standard IEEE 802.5 Token Ring process by which a Token Ring LAN attempts to recover from cable or hardware problems by automatically locating and bypassing the fault, thereby restoring network communications without operator intervention. Networks that rely upon the IEEE standard beaconing process are disabled when beaconing fails. Cabletron's ABRP protects against such network stoppages.



ABRP is supported only by Cabletron products. To secure the reliability of ABRP beaconing protection for the entire network, use only Cabletron Systems devices.

If beacon recovery is enabled, ABRP is automatically invoked whenever the STHI detects a beaconing condition on the ring. It is often able to correct the problem before the standard IEEE process even begins. Once ABRP locates the problem and corrects it, the STHI generates traps to provide the network's designated remote management station with the following information regarding the incident:

- the beaconing device's address;
- the address of the beaconing device's Nearest Active Upstream Neighbor (NAUN);
- the beacon type;
- the duration of the beaconing condition;
- and the port(s) and/or modules left in bypass to partition the problematic ring segment.

Number of Retries

Use the Number of Retries field to determine how many times the STHI will attempt to re-enable an RI or RO port which has been disabled by ABRP. If the beaconing condition still exists when the port is checked, the port is not allowed to re-enable.

The field accepts values from 000 to 100, and also accepts 999 to indicate infinite retries. The default number of retries is 4.

Retry Interval

The Retry Interval field determines the duration between automatic retries of RI/RO ports disabled by ABRP. Intervals are selectable to a resolution of 7 seconds between ring port retry attempts. The default setting is 21.

5.3.6 MAC Address

This read-only field displays the Media Access Control (MAC) address which, by universal default, identifies the hub at the network's physical layer.

5.3.7 Locally Administered Address

Users may assign a locally administered address which is used instead of the MAC address to identify the FNB interface at the network's physical layer. If enabled, the locally administered address takes effect after the next reset of the STHI.

5.4 The SNMP Community Names Screen

Access the SNMP Community Names screen, shown in Figure 5-5, from the Device Setup menu.

Component Name	Community Name	Access
STHI Chassis MGR	public	READ-ONLY
STHI Chassis MGR	public	READ-WRITE
STHI Chassis MGR	public	SUPER-USER

Figure 5-5. Community Name Table Screen

The SNMP Community Names screen enables the user to establish or modify the community names which serve as passwords to LM and to determine the level of security access the LM user is accorded.

5.4.1 Community Name

Use these fields to define community name strings. Each name set in these fields will be accorded the security access level named on the same line to the right, in the Access Policy column.

5.4.2 Access Policy

The Access Policy column indicates the access status accorded to the corresponding community name. Three pre-configured levels of LM access are available:

Read-only

This level of access allows a user partial access to view LM screens. The user will not be allowed to write to any field in LM, nor will the user be allowed to view the super-user or read-write community names.

Read-write

This level of access allows a user to view LM screens and to change values set in them, including the read-only community name. The user will not be able to write to the IP Address, the Subnet Mask, or read-write community name fields, nor will the user will be allowed to view the super-user name.

Super-user

This level of access is absolute and will grant a user full LM access privileges to read and edit any LM parameters, including community names.

5.5 The SNMP Traps Screen

Access the System Level screen (Figure 5-6) from the Device Setup menu.

STHI LOCAL MANAGEMENT		Flash Image Version: 1.00.00
SNMP TRAPS		
Trap Destination	Trap Community Name	Enable Traps
0.0.0.0	<CR>	N
0.0.0.0	<CR>	N
0.0.0.0	<CR>	N
0.0.0.0	<CR>	N
0.0.0.0	<CR>	N
0.0.0.0	<CR>	N
0.0.0.0	<CR>	N
0.0.0.0	<CR>	N

SAVE
RETURN

Figure 5-6. SNMP Traps Screen

The SNMP Traps screen is used to provide the STHI with the IP addresses of remote management stations intended to receive SNMP traps, and to provide those stations with the community names they will need to access the STHI with SNMP requests.

5.5.1 Trap Destination

Use these fields to set an IP Address for each workstation designated to receive trap alarms from the STHI.

5.5.2 Trap Community Name

SNMP protocol requires that all traps issued include an SNMP community name. This field holds the community name to be sent to the corresponding network device. Some network management systems make use of this community name when polling the STHI.

5.5.3 Enable Traps

Setting the value in this toggle field to **YES** enables the STHI to send SNMP trap messages to the corresponding device; **NO** disables the same.

5.6 The Chassis Status View Screen

Access the Chassis Status View screen (Figure 5-7) from the Device Status menu.

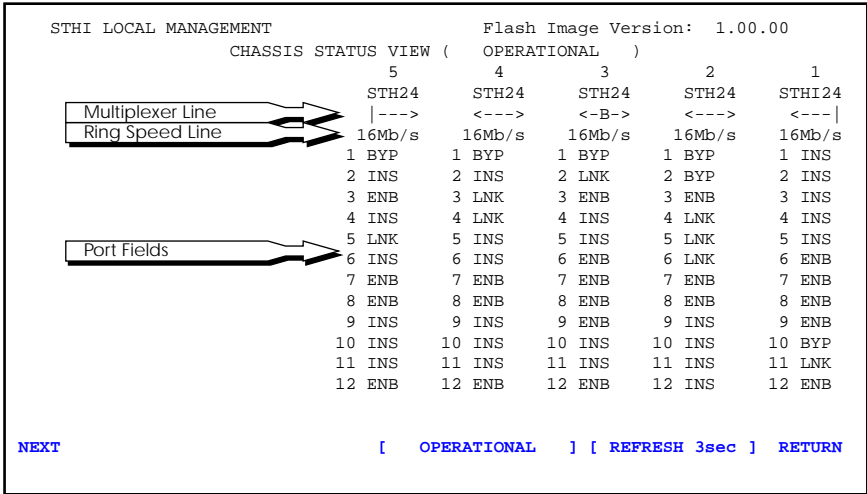

Figure 5-7. Chassis Status View Screen with Anatomy Labels

Functions of the Chassis Status View Screen

Each column in the Chassis Status View screen displays current status information about a module in the stack. Use the Chassis Status View screen for the following functions:

- view/change the connection settings between modules throughout the stack,
- view/change the current status of each port,
- view the ring speed setting,
- and configure each TCU port for station or Ring Out connections.

All hub devices are polled at user-defined intervals and the screen is dynamically updated to show current settings and status readings.

5.6.1 The Screen Mode Screen Command

The Chassis Status View screen offers three different modes of operation, each of which brings different functionality to the screen's port and multiplexer fields.

- **OPERATIONAL** (read-only) lists each port's operational status.
- **ADMINISTRATIVE** allows the user to enable/disable ports and to place entire hubs in bypass mode.
- **RING OUT ENABLE** allows the user to set TCU ports to station or Ring Out operational configurations.

The roles of these modes are discussed further in the following sections regarding port fields and multiplexer fields.

Use the toggling command field in the center of the screen command line to select the screen mode.

5.6.2 Multiplexer Configuration Fields

All hubs in an STH/STHI stack are interconnected to form a single Token Ring LAN, logically organized and represented on the LM screen (Figure 5-7, page 5-14) as a string of left/right neighbors. The multiplexer fields on the multiplexer line indicate the state of each hub's connection to the common Token Ring LAN that interconnects all hubs in the stack. In **OPERATIONAL** and **RING OUT ENABLE** modes, the multiplexer fields are read-only, but in **ADMINISTRATIVE** mode, all multiplexer fields become toggle fields, allowing the user to manipulate the connections between hubs in the stack.

The multiplexer field allows the user to bypass individual hubs from the stack's common ring. A bypassed hub operates as its own local ring, providing interconnectability for all of its TCU ports, but not permitting data contact with the stack's common ring. If the STHI is bypassed, its ring-monitoring functionality continues to serve the stack's common ring, rather than the STHI's bypassed ring. Also, if the STHI is bypassed, its TPIM ports continue to provide access to the stack's common ring.

Multiplexer field symbols are defined below. Left/right connections are not user-configurable through LM; they are determined by the physical configuration of the interconnect cables between the STHI and any STH hubs. Only the bypass setting is user-configurable. Toggle the multiplexer field to select the bypass setting for each hub.

The following multiplexer status symbols may appear.

- <--->** Attached left/right - This STH is connected to the stack's common ring. The ring connection is continued by neighbor hubs in both directions.

- <-B->** Attached left/right & Bypassed - This STH is bypassed from the stack's common ring. The ring connection is continued by neighbor hubs in both directions.
- |---->** Attached right - This STH is connected to the stack's common ring. The ring connection is continued by a neighbor hub to the right.
- | -B->** Attached right & Bypassed - This STH is bypassed from the stack's common ring. The ring connection is continued by a neighbor hub to the right.
- <---- |** Attached left - The STHI is connected to the stack's common ring. The ring connection is continued by an STH to the left and possibly extended through TPIM Ring In / Ring Out ports as well.
- <-B- |** Attached left & Bypassed - The STHI is bypassed from the stack's common ring, but the common ring connection is continued by an STH to the left and possibly extended through TPIM Ring In / Ring Out ports as well.
- |---- |** Detached - The STHI is connected to the stack's common ring. There are no neighbor hubs, but the common ring may be extended through TPIM Ring In / Ring Out ports.
- | -B- |** Detached & Bypassed - The STHI is bypassed from the stack's common ring. There are no neighbor hubs, but the common ring may be extended through TPIM Ring In / Ring Out ports.

5.6.3 Port Configuration Fields

The Chassis Status View screen lists all the ports from all the hubs in the stack. TCU ports are shown in numbered ranges of 12 at a time, and TPIM ports are listed last.

The function of each port field is determined by the screen mode currently in effect.

ADMINISTRATIVE Mode

With the Chassis Status View screen in **ADMINISTRATIVE** mode (Figure 5-8), all Port Status fields become toggle fields which allow the user to change the current administrative state of each port.

Each port field (whether TPIM or TCU) may be set as follows:

- ON** The port is enabled and will allow insertion.
- OFF** The port is disabled.

```

STHI LOCAL MANAGEMENT                               Flash Image Version:  1.00.00

                CHASSIS STATUS VIEW ( ADMINISTRATIVE )
                5           4           3           2           1
                STH24      STH24      STH24      STH24      STHI24
                |--->    <--->    <-B->    <--->    <---|
                16Mb/s   16Mb/s   16Mb/s   16Mb/s   16Mb/s
1  [OFF]  1  [OFF]  1  [OFF]  1  [OFF]  1  [ON]
2  [ON]   2  [ON]  2  [OFF]  2  [OFF]  2  [ON]
3  [ON]   3  [OFF]  3  [ON]  3  [ON]  3  [ON]
4  [ON]   4  [OFF]  4  [ON]  4  [OFF]  4  [ON]
5  [OFF]  5  [ON]  5  [ON]  5  [OFF]  5  [ON]
6  [ON]   6  [ON]  6  [ON]  6  [OFF]  6  [ON]
7  [ON]   7  [ON]  7  [ON]  7  [ON]  7  [ON]
8  [ON]   8  [ON]  8  [ON]  8  [ON]  8  [ON]
9  [ON]   9  [ON]  9  [ON]  9  [ON]  9  [ON]
10 [ON]  10 [ON] 10 [ON] 10 [ON] 10 [OFF]
11 [ON]  11 [ON] 11 [ON] 11 [ON] 11 [OFF]
12 [ON]  12 [ON] 12 [ON] 12 [ON] 12 [ON]

NEXT                               [ ADMINISTRATIVE ] [ REFRESH 3sec ] RETURN
    
```

Figure 5-8. Chassis Status View Screen in ADMINISTRATIVE Mode

RING OUT ENABLE Mode

With the Chassis Status View screen in **RING OUT ENABLE** mode (Figure 5-9), all Port Status fields become toggle fields which allow the user to set the current configuration of each TCU port to either station or Ring Out.

```
STHI LOCAL MANAGEMENT                               Flash Image Version: 1.00.00
CHASSIS STATUS VIEW ( RING OUT ENABLE )
      5              4              3              2              1
    STH24          STH24          STH24          STH24          STHI24
    |--->         <---->         <-B->         <---->         <---|
    16Mb/s       16Mb/s       16Mb/s       16Mb/s       16Mb/s
  1 [STN]      1 [RO]       1 [RO]       1 [STN]      1 [RO]
  2 [RO]       2 [STN]      2 [STN]      2 [STN]      2 [STN]
  3 [STN]      3 [STN]      3 [STN]      3 [STN]      3 [STN]
  4 [STN]      4 [STN]      4 [STN]      4 [STN]      4 [STN]
  5 [STN]      5 [STN]      5 [STN]      5 [STN]      5 [STN]
  6 [RO]       6 [RO]       6 [STN]      6 [STN]      6 [STN]
  7 [STN]      7 [STN]      7 [STN]      7 [STN]      7 [STN]
  8 [STN]      8 [STN]      8 [STN]      8 [STN]      8 [STN]
  9 [RO]       9 [RO]       9 [STN]      9 [STN]      9 [STN]
 10 [RO]      10 [RO]      10 [STN]     10 [STN]     10 [STN]
 11 [RO]      11 [RO]      11 [STN]     11 [STN]     11 [STN]
 12 [STN]     12 [STN]     12 [STN]     12 [STN]     12 [STN]

NEXT                               [ RING OUT ENABLE ] [ REFRESH 3sec ] RETURN
```

Figure 5-9. Chassis Status View Screen in **RING OUT ENABLE** Mode

Each TCU port may be toggled to:

- STN** The port is configured to support connections by network devices which are capable of generating phantom current.
- RO** The port is configured to support connections by passive network devices (e.g. Multi-station Access Units) which are not capable of generating phantom current.

OPERATIONAL Mode

In **OPERATIONAL** mode (Figure 5-7), the Chassis Status View screen is read-only, displaying the operational status of all ports throughout the stack. The possible states for Ring ports differ from those for STN TCUs.

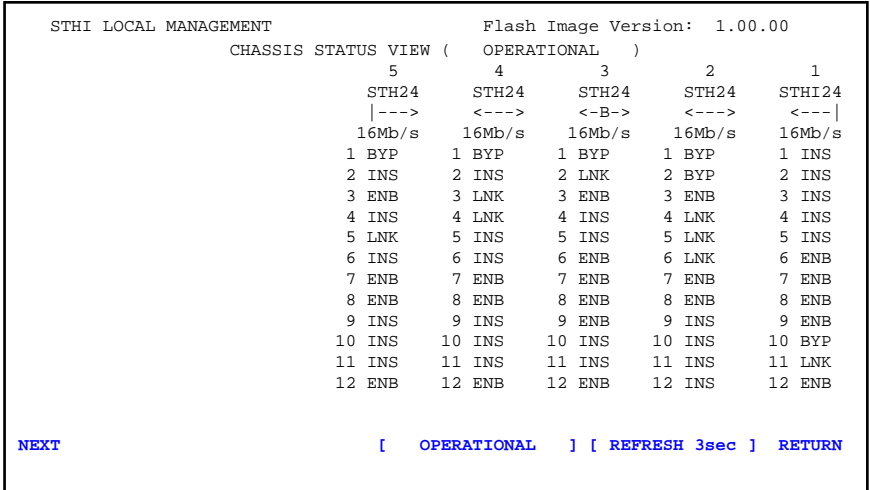

Figure 5-10. Chassis Status View Screen in **OPERATIONAL** Mode

Each Ring port (TPIM port or Ring Out TCU) may be listed as:

- ACT** The enabled ring port has opened its connection, having detected data on the line. The attached device is inserted into a ring.
- WRP** The port is in the wrap state. Either the port is disabled, or is not detecting data and is remaining closed.

Each station TCU port may be listed as:

- INS** The port is enabled and the attached device is applying phantom current. The device is inserted into the ring.
- ENB** The port is enabled but no phantom current is present.
- BYP** The port is disabled (see **ADMINISTRATIVE** mode) and no phantom current is present.
- LNK** An attached device is applying phantom current, but the port is disabled, preventing insertion of the attached device into the ring.

5.6.4 NEXT and PREVIOUS

The Chassis Status View screen lists ports in ranges of 12 at a time. Use the **NEXT** and **PREVIOUS** screen commands to view ports from the next or previous range.

5.6.5 ENABLE ALL PORTS

Invoke this screen command to enable all ports in the stack. It is available only in **ADMINISTRATIVE** mode.

5.6.6 REFRESH

The user may toggle this screen command to select screen refresh intervals from 3 to 10 seconds.

5.7 The Component Status Screen

Access the Component Status screen (Figure 5-11) from the Device Status menu.

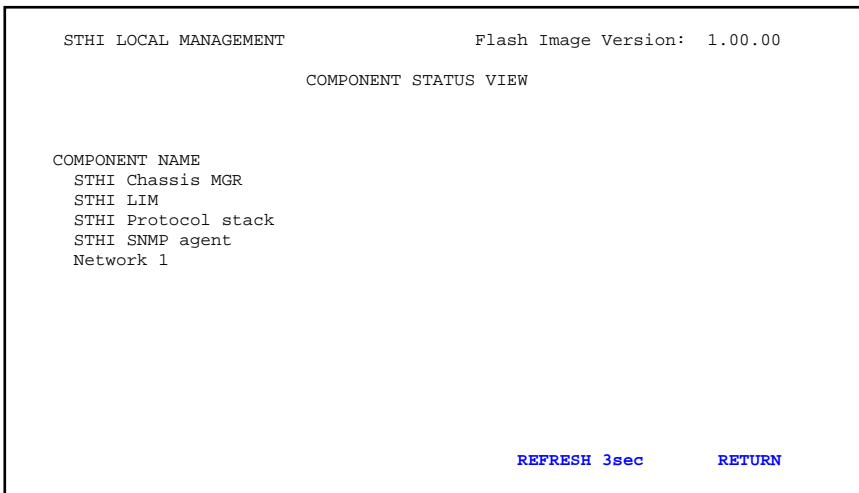

Figure 5-11. Component Status Screen

The Component Status View screen is a read-only screen which lists the enabled/disabled status of the STHI hub's operating system and associated components. (Software applications, resources, and functions registered in the STHI are known as components.) All compatible

components, whether optionally available or included with the STHI, are listed on the Component Status View screen. Components not yet installed in the STHI are listed as disabled.

The Component Status View screen may list the following entities:

- **Chassis Mgr** - the entity that controls the interconnections between the hubs in the stack managed by the STHI.
- **Local Mgmt** - the Local Management application.
- **SNMP Agent** - the entity for the SNMP management agent.
- **Protocol Stack** - the entity for the device driver protocol stack.
- **Network** - Numbered LANs (including both bypassed and common rings) currently configured in the STHI.

The user can establish separate Community Name access for each component and change its enabled/disabled status via the SNMP Tool screen (Section 5.9), or through a remote management application such as Remote LANVIEW/Windows' MIB Tree utility.

5.8 The Device Statistics Screen

Access the Device Statistics screen (Figure 5-12) from the Main Menu.

```
STHI LOCAL MANAGEMENT                               Flash Image Version:  1.00.00

                                DEVICE STATISTICS (TOTAL)

INTERFACE: 1

    Frames Received: 2083
    KBytes Received: 194
    Errors Received: 0
    Beacon States: 0
    Ring Purges: 0
Active Monitor Changes: 0

    RING INFORMATION
Active Monitor Addr: 00-00-B8-F0-13-40
    Ring Status: Normal
    Ring Number: 0
    Stations on Ring: 2
    Ports Enabled: 24
    Ring Speed (Mb/s): 16

ISOLATING ERRORS
    Line Errors: 0
    Burst Errors: 0
    AC Errors: 0
Abort Transmit Errors: 0
    Internal Errors: 0

NON-ISOLATING ERRORS
    Lost Frame Errors: 0
    Frame Copied Errors: 0
    Rcvr Congestion Errors: 0
    Token Errors: 0
    Frequency Errors: 0

ACCUMULATE      DELTA                               REFRESH 3sec      RETURN
```

Figure 5-12. Device Statistics Screen in **TOTAL** Mode

This read only screen enables the user to monitor the performance of the managed network. The error statistics provided here can be useful in the diagnosis of LAN problems.

The counters are updated at each screen refresh.

5.8.1 Screen Mode

The screen operates under three different counting modes, described below. The screen mode currently in effect is listed in parentheses on the screen title line. The remaining two modes-in-waiting are listed on the screen command line. To select another screen mode, invoke it from the screen command line.

TOTAL

In this mode, the counters display totals since the STHI hub's last reset.

DELTA

In this mode, the counters display totals since last screen refresh.

ACCUMULATE

In this mode, the screen provides a **CLEAR** screen command which clears all counters, enabling the user to monitor network performance from a user-determined moment. **Clear Date** and **Clear Time** fields are provided to note the moment the counters were reset.

```
INTERFACE: 1                DEVICE STATISTICS (ACCUMULATE)
Clear Date: 01/01/89        Clear Time: 00:02:21
RING INFORMATION
Active Monitor Addr: 00-00-B8-00-00-00
KBytes Received: 0          Ring Status: Normal
Frames Received: 0
```

Figure 5-13. Device Statistics Screen in **ACCUMULATE** Mode

5.8.2 REFRESH 3SEC

The user may toggle this screen command to select counter update intervals from 3 to 10 seconds.

5.8.3 General Counter Fields (Group 1)

Frames Received

This displays the number of frames received by the STHI.

KBytes Received

This displays the amount of data (in kilobytes) received by the STHI.

Errors Received

This displays the number of Isolating and Non-Isolating Errors (described below) detected on the ring.

Beacon States

This displays the number of beacon conditions detected on the ring. Stations transmit beacons when they detect bit streaming or signal loss on the ring.

Ring Purges

This displays the number of ring purge frames transmitted by the active monitor.

Active Monitor Changes

This displays the number of times the role of active monitor has been transferred between stations.

5.8.4 Ring Information Fields (Group 2)

Ring Information provides ring status information.

Active Monitor Addr

This displays the MAC address of the current active monitor. The active monitor is the station designated (automatically by Token Ring protocol) to initiate recovery procedures in response to various error conditions.

Ring Status

This displays the status of the ring to which the STHI is currently connected: if the STHI is bypassed, it refers only to the STHI hub's internal ring; otherwise, it refers to the stack's common ring.

- **Unknown** — This reflects a transient state during which the management agent is unable to determine the current ring status.
- **Closed** —The STHI has disconnected itself completely from other hubs in the stack: it is not supporting the common ring and cannot determine the ring state.
- **Normal** — The ring is operating trouble-free.
- **Purge** — The active monitor has issued a ring purge command to clear all circulating transmissions. Communications will be restored momentarily—when the active monitor releases a new token.
- **Contention** — The ring has entered into the active monitor contention process to determine a new active monitor for the ring.
- **Beaconing** — The STHI has detected a beacon frame.
- **Lobe Fail** — A station failed the lobe self-test when attempting to insert into the ring; soft-errors may have occurred.

Ring Number

This identifies the ring on which a bridge is available. Zero indicates that there is no bridge on any ring in the stack.

Stations on a Ring

This displays the number of stations currently inserted into the ring. If the STHI is bypassed, only the stations on the STHI's self-supported ring are counted.

Ports Enabled

This displays the number of TCU ports currently enabled.

Ring Speed

This displays the STHI hub's currently set ring speed.

5.8.5 Isolating Errors Fields (Group 3)

Frames reporting isolating errors provide information that can be used to determine the physical domain of a fault. These errors are common soft errors, meaning that they are to be expected and can be overcome by normal Token Ring operations. While they will not completely halt a network, excessive soft errors reduce a network's efficiency.

Line Errors

Line Errors are corrupted frames normally caused by stations entering and leaving the ring. Replacement frames are automatically generated.

This error can also indicate a problem with the receiver of the reporting node, or the transmitter of its Nearest Active Upstream Neighbor (NAUN), or the cabling and hub hardware between them.

Burst Errors

A burst error is an absence of clocking signals at a node's receiver. This error normally occurs when passive stations (those that do not generate phantom current) enter or leave the ring.

This error can also indicate a problem with the receiver of the reporting node, or the transmitter of its NAUN, or the cabling and hub hardware between them.

AC Errors

These Address Recognized/Frame Copied errors may indicate that the reporting station's NAUN is faulty—unable to set the address recognized indicator and/or frame copied indicator bits in the frame which it has copied, leaving the downstream node with an incorrect NAUN address.

Abort Transmit Errors

This displays the number of abort delimiter frames transmitted by a station. A frame of this type may indicate that either the reporting node has detected an error on itself, or there is an error with its NAUN or the cabling and wiring hubs between them.

Internal Errors

Internal errors may be detected by the adapter's hardware and/or firmware. These errors cause the adapter to remove itself from the ring and indicate a problem with the adapter hardware or firmware.

5.8.6 Non-Isolating Errors (Group 4)

Frames reporting non-isolating errors do not provide sufficient information to determine the physical domain of a fault. These errors are common soft errors, meaning that they are to be expected and can be overcome by normal Token Ring operations. While they will not completely halt a network, excessive non-isolating errors reduce a network's efficiency.

Lost Frame Errors

A Lost Frame Error may indicate that an adapter did not detect the return of the end of a frame it transmitted; the frame was lost somewhere on the ring. This can be caused by stations entering or leaving the ring. Replacement frames are automatically generated.

Frame Copied Errors

A Frame Copied Error may indicate that a station received a frame with its address as the destination, but the address recognized indicator bits were not set to zero. This is primarily caused by stations having duplicate physical addresses (at least one of which would be a Locally Administered address). All MAC addresses are unique. Ensure that any Locally administered addresses assigned do not duplicate another network device's physical address.

Rcvr Congestion Errors

A Rcvr Congestion Error may indicate that a station has received/repeated a frame addressed to it, but had no buffer space available to copy the frame. Replacement frames are automatically generated, but an excessive amount of these errors may indicate a hardware problem.

Token Errors

A Token Error may indicate that an active monitor either has detected a recirculating frame or token, or has found that its Timer Valid Transmission (TVX) time has expired before any token has been detected circulating on the ring (i.e.: a lost frame error has occurred). The active monitor is responsible for purging the ring and issuing new tokens in response to these errors.

Frequency Errors

A Frequency Error may indicate that the frequency of the incoming signal deviates excessively from that of the reporting station's onboard crystal oscillator. When frequency errors are detected, the ring enters the monitor contention process to establish a new active monitor.

5.9 The SNMP Tool Screen

Access the SNMP Tool screen (Figure 5-14) from the Main Menu.

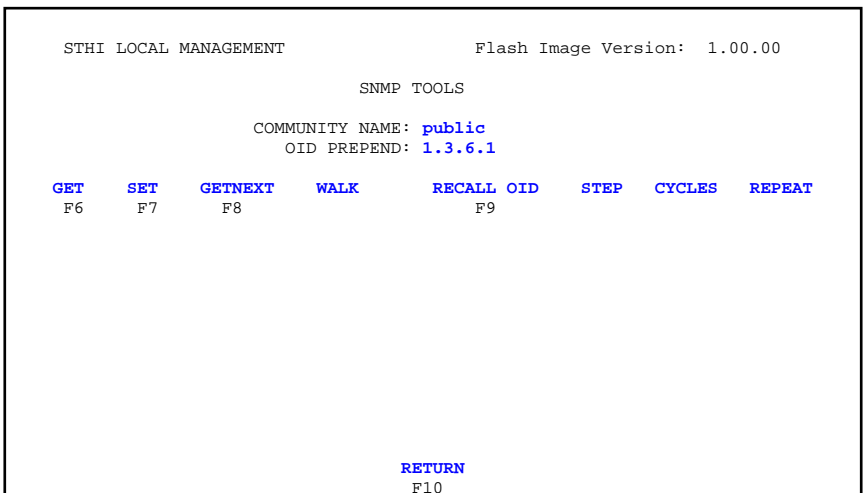

Figure 5-14. SNMP Tool Screen

Through the SNMP Tool screen, the user can access information stored in the STHI hub's Management Information Base (MIB). MIBs and their objects are logically arranged as trees with subsequent branches and leaves; each leaf is a **MIB object**. One leaf, for example, contains the hub's

IP address; another contains the current operational status of TCU port number 6. To access a specific bit of information, the user specifies an **object identifier (OID)** which is a series of numbers separated by decimal points that indicates the path through a MIB trunk and subsequent branches to the specific leaf that contains the desired information, effectively identifying the MIB object.

On the SNMP Tool screen, a row of MIB commands is presented. These commands, which are described below, may be invoked in the same manner as screen commands. Some of them may also be invoked through function keys.

5.9.1 Community Name

The Community Name field lets the user input a password to access MIBs that have been set up to refuse access to users without the proper password.

5.9.2 OID Prepend

It is likely that many of the MIB leaves which the user will be accessing will reside within the same family of branches in the MIB (e.g.: they all begin with 1.3.6.1). The user may use the OID Prepend field to specify a prefix (e.g.: 1.3.6.1) which will be applied automatically (unless otherwise directed) to subsequent OIDs, allowing the user to leave out this OID portion when accessing MIB leaves on a common family of branches.

5.9.3 GET

Use the **GET** command to view a single MIB leaf by specifying its OID. It displays the following information for each MIB object:

- Specified OID - lists the OID for each object displayed.
 - Size - lists the number of memory bytes occupied by the object.
 - Type - lists the object's variable type (e.g., int = integer).
 - Data - lists the object's current value.
1. Invoke **GET** on screen or press the **F6** function key.
 2. After "<GET> OID (= | F9)" appears, specify the desired OID by one of the following methods:
 - Enter the OID minus the OID's prepend: if the prepend is 1.3.6.1, and the user enters 4.1.3, OID 1.3.6.1.4.1.3 is requested.

- Enter an '=' followed by the complete OID. This bypasses the OID prepend specified above, enabling the user to digress from the current MIB branch and access MIB leaves on other branches. If the user enters =4.1.3, then OID 4.1.3 is requested.
- Press **F9** to recall the last-specified OID, and then edit that OID as desired.

3. Press the **Return** key.

If there is no instance of that OID, the message, "MIB NO INSTANCE" will appear; otherwise, information about the corresponding MIB leaf's data type, length, and value appear.

5.9.4 GETNEXT

Use the **GETNEXT** command to view the MIB leaf numerically following a specified OID.

1. Invoke **GETNEXT** by the on-screen selection method, or press the **F8** key.
2. After "<GETNEXT> OID (= | F9)" appears, specify an OID by the same methods used in the **GET** procedure:
 - Enter an OID minus the OID's prepend.
 - Enter an '=' to bypass the OID prepend, and follow with a complete OID.
 - Press **F9** to recall the last-specified OID, and then edit that OID as desired.
3. Press the **Return** key.

5.9.5 STEP

STEP functions like **GETNEXT**, scrolling through a MIB leaf by leaf, but it does not ask the user to specify an OID. Instead, it simply recalls the last-specified OID and gets the next one, allowing the user to display one OID after another, simply by pressing **Return** to advance each step.

1. Invoke **STEP** by the on-screen selection method and press **Return**.
SNMP Tool gets the next object.
2. Repeatedly press **Return** to display subsequent objects. This can be repeated until all sublayers of the MIB have been shown.

5.9.6 WALK

WALK functions like an automatically repeating **STEP**, rapidly scrolling through a MIB leaf by leaf from a user-specified OID without requiring the user to initiate each step. **WALK** steps continuously until either the user stops the process or the list ends.

1. Invoke **WALK** by the on-screen selection method.
2. After "<INITIAL> OID (= | F9)" appears, specify an OID from which to begin walking, and press the **Return** key.
The screen will begin walking through the MIB's sublayers.
3. Press the **Space Bar** to stop the walk (or to resume if stopped), or wait for "***MIB WALK COMPLETED***" to appear on the screen.

5.9.7 CYCLES

CYCLES functions like **WALK** except that the user specifies the number of steps to be taken and the time to elapse between each step, allowing the user to limit the speed and duration (content) of the display.

1. Invoke **CYCLES** by the on-screen selection method.
2. After "ENTER CYCLE COUNT:" appears, set the number of steps to be taken, then press the **Return** key.
3. After "ENTER CYCLE DELAY (secs):" appears, set the delay (in seconds) to occur between steps, then press the **Return** key.
4. After "<INITIAL> OID (= | F9)" appears, specify an OID from which to begin walking, and press the **Return** key.

5.9.8 RECALL-OID

RECALL-OID is a tool of convenience used only when specifying an OID. Rather than retyping the last-specified OID, the user presses F9 and the OID appears. **RECALL-OID** may be invoked only by pressing F9.

5.9.9 SET

SET enables users with read-write and super-user access to change the current values of modifiable MIB objects. For example, a super-user may change the current community name protecting a certain MIB, or change the STHI hub's operating ring speed.

1. Invoke **SET** on screen, or press the **F7** function key.

2. After "<SET> OID (= | F9)" appears, specify an OID by the same methods used in the **GET** procedure:
3. Press the **Return** key.
If there is no instance of that OID, "MIB NO INSTANCE" will appear; otherwise "DATA TYPE:" appears.
4. Designate a data type for the OID: integer, string, null, OID, IP address, counter, gauge, timeticks, and opaque are the available options. (Refer to the MIB for proper data type.) Press the **Return** key to accept the designation.
5. After "DATA" appears, enter the MIB object's new value and press **Return**.
If accepted, "<SET> OPERATION CODE: xxxx <OK>" appears, otherwise an error message appears.

5.9.10 REPEAT

The **REPEAT** command is the same as a **GET** command expect that it re-executes itself continuously, scrolling updated values for the specified OID on the screen and counting the number of times it has been shown, until stopped by the user. In other words, by using **REPEAT** the user can monitor an object's changes over time.

5.9.11 Firmware Image Downloads

The SNMP Tool screen may be used to initiate a Flash file download. The user will need to know the IP address of the TFTP server and the full path name of the firmware image to be downloaded from that server.

Set the following OIDs as prescribed below in order to properly initiate and complete the download.

- `ctDLForceOnBoot - 1.3.6.1.4.1.52.4.1.5.8.1.1.0`
Cabletron's Download Force On Boot OID determines whether the STHI will force a Flash image download at next reset or will boot from its current Flash file. Set this integer value to 1 to force the download (or 0 to disable).
- `ctDLTFTPRequestHost - 1.3.6.1.4.1.52.4.1.5.8.1.4.0`
Cabletron's Download TFTP Request Host OID holds the IP address of the designated TFTP server. Set it to the IP address of the TFTP server which contains the image to be downloaded.

- [ctDLCommitRAMtoFlash - 1.3.6.1.4.1.52.4.1.5.8.1.2.0](#)
Cabletron's Download Commit RAM to Flash OID determines whether the downloaded image will be committed to Flash memory after a successful download. Set this integer value to 1 to commit the downloaded image to Flash (or 0 to disable). If not committed to Flash, the downloaded file will be lost at power-down.
- [ctDLTFTPRequest - 1.3.6.1.4.1.52.4.1.5.8.1.5.0](#)
Cabletron's Download TFTP Request OID holds the full pathname of the file to be downloaded. Set it to the fully qualified path name of the image file to be downloaded.
- [ctDLInitiateColdBoot - 1.3.6.1.4.1.52.4.1.5.8.1.3.0](#)
Cabletron's Download Initiate Cold Boot OID is an integer value. When set to 1, it forces the STHI to reset and reboot. This OID must be set last, because the STHI will reset immediately after processing this request.

APPENDIX A

TPIM Specifications

A.1 Overview

Token Ring Port Interface Modules (TPIMs) are media adapter cards which extend network connections onto a variety of media. When installed into Ring In and Ring Out ports, TPIMs support the expansion of a Token Ring from the host module into other devices. Each TPIM has a different type of cable port to support a different media connection. Table A-1 lists each available Cabletron Systems TPIM and its respective connector.

Table A-1. TPIMs and their Corresponding Media

TPIM	Media Type	Connector
TPIM-T1	Shielded Twisted Pair	DB9
TPIM-T2	Unshielded Twisted Pair	RJ45
TPIM-T4	Shielded Twisted Pair	RJ45
TPIM-F2	Multimode Fiber Optic	ST
TPIM-F3	Single mode Fiber Optic	ST

The LNK (Link) LED on the face of each TPIM indicates the following:

- Green - Inserting.
- Red (TPIM-T1/T2/T4 only) - No Link (Autowrapped)
- Off - No Link (Wrapped or Disabled)

All Cabletron TPIMs are interchangeable and hot-swappable.

A.2 Twisted Pair TPIM Pinouts

Each TPIM that supports Twisted Pair cabling has two operating modes: Ring In / Ring Out and Station. For use with STHI, the TPIM is switched to operate in Ring In / Ring Out mode. The pinouts for TPIMs in station applications are different from pinouts for Ring In / Ring Out applications. Illustrations of the Ring In / Ring Out pinouts follow.

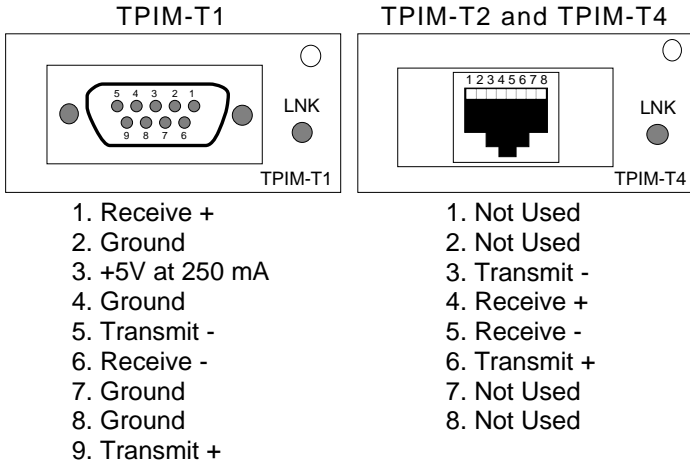

Figure A-1. TPIM-T1/T2/T4 Pinouts for Ring In.

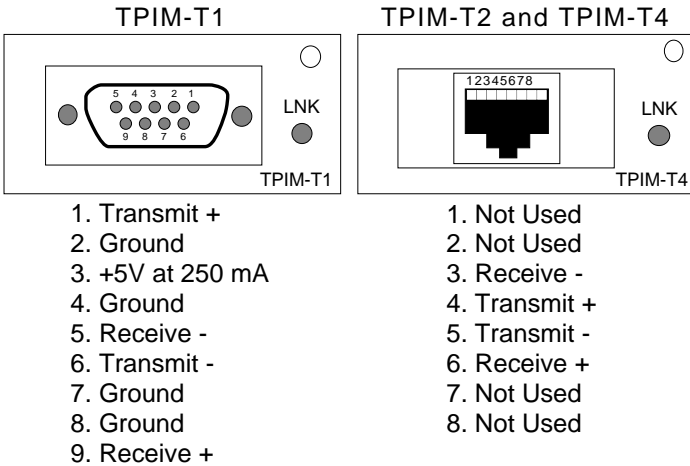

Figure A-2. TPIM-T1/T2/T4 Pinouts for Ring Out.

A.3 Fiber Optic TPIM Specifications

TPIM-F2 and TPIM-F3 support Multimode and Single Mode Fiber Optic cabling respectively. Figure A-3 shows the face layout common to both modules.

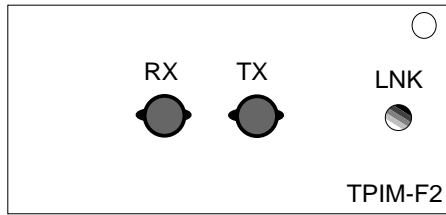

Figure A-3. The TPIM-F2 Faceplate.

A.3.1 TPIM-F2 for Multimode Fiber

The TPIM-F2 connector supports Multimode Fiber Optic Cabling.

Table A-2. TPIM-F2 Specifications.

Parameter	Typical Value	Worst Case	Worst Case Budget	Typical Budget
Receive Sensitivity	-30.5 dBm	-28.0 dBm	—	—
Peak Input Power	-7.6 dBm	-8.2 dBm	—	—
Transmitter Power:				
50/125 μm	-13.0 dBm	-15.0 dBm	13.0 dB	17.5 dB
62.5/125 μm	-10.0 dBm	-12.0 dBm	16.0 dB	20.5 dB
100/140 μm	-7.0 dBm	-9.0 dBm	19.0 dB	23.5 dB
Error Rate: Better than 10^{-10}				

The transmitter power and receive sensitivity levels given in Table A-2 are Peak Power Levels after optical overshoot. A Peak Power Meter must be used to correctly compare the given values to those measured on any particular port. If Power Levels are being measured with an Average Power Meter, then 3 dBm must be added to the measurement to correctly compare those measured values to the values listed in Table A-2 (i.e. -30.5 dBm peak=-33.5 dBm average).

A.3.2 TPIM-F3 for Single Mode Fiber

The TPIM-F3 connector supports Single Mode Fiber Optic cabling.

Transmitter Power decreases as temperatures rise. Use the Output Power Coefficient (-0.15 dBm) to calculate increased or decreased power output for the operating environment. For example, the typical power output at 25°C is -16.4 dBm. For a 4°C temperature increase, multiply the typical coefficient (-0.15 dBm) by four and add the result to typical output power: (4 x -0.15 dBm + -16.4 = -17.0).

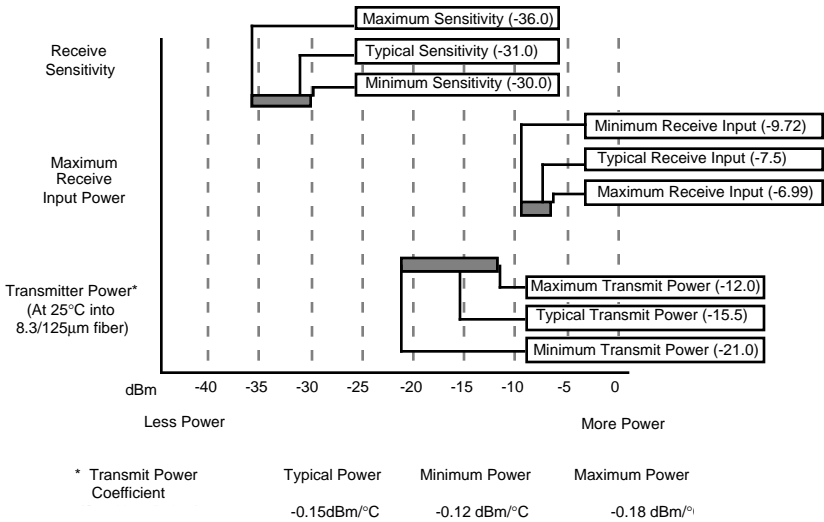

Figure A-4. Transmitter Power Levels

Table A-3. TPIM-F3 Specifications

Parameter	Typical	Minimum	Maximum
Transmitter Peak Wave Length	1300 nm	1270 nm	1330 nm
Spectral Width	60 nm	–	100 nm
Rise Time	3.0 nsec	2.7 nsec	5.0 nsec

Table A-3. TPIM-F3 Specifications (Continued)

Parameter	Typical	Minimum	Maximum
Fall Time	2.5 nsec	2.2 nsec	5.0 nsec
Duty Cycle	50.1%	49.6%	50.7%
Bit Error Rate: Better than 10^{-10}			

The transmitter power levels given in Table A-3 are Peak Power Levels after optical overshoot. A Peak Power Meter is required to correctly compare the values given above to those measured on any particular port. When measuring power levels with an Average Power Meter, add 3 dBm to the average power measurement to correctly compare the average power values measured to the values listed in Table A-3 (i.e., -33.5 dBm average + 3 dB = -30.5 dBm peak).

APPENDIX B

Media Specifications

Use of the STHI may involve a variety of cable types. The STHI hub's network ports support either Shielded Twisted Pair (STP) or Unshielded Twisted Pair (UTP) cabling, depending on the STHI model, while Token Ring Port Interface Modules (TPIMs) allow for network expansions onto UTP, STP, Multimode Fiber Optic, and Single Mode Fiber Optic cabling.

The HubSTACK Interconnect cable (Part Number 9380141) which is needed to interconnect an STH hub with an STHI is provided with each STH.

Take care in planning and preparing the cabling and connections for the network. The quality of the connections and the length of cables are critical factors in determining the reliability of the network.

B.1 Unshielded Twisted Pair (UTP)

STHI models 22 and 24 and TPIM-T2 support D-inside wiring (DIW) voice grade Unshielded Twisted Pair (UTP) cable as described below and in **EIA SP-1907B**. All category 5, all category 4, and *some* (see **Section 2.3.2 on page 5**) category 3 UTP cables meet Token Ring network performance requirements.

B.1.1 UTP Cable Categories

Both UTP modules (STHI-22 / 24) support UTP cables classified as category 3, 4, and 5.

UTP cable is categorized according to the following specifications:

Category 3 consists of (usually) four Unshielded Twisted Pairs of 24 AWG solid wire for data or voice communication. (IBM Type 3 is coincidentally the same as UTP Category 3.) It is typically used to wire cable runs within the walls of buildings. In some installations, pre-existing UTP building wiring can be used for Token Ring cabling.



At 16 Mbps ring speeds, some Category 3 cable does not meet the performance requirements of a Token Ring network. This may impose lower limits on lobe cable distances and ring node counts. See Table B-1.

Table B-1. UTP Cable Category Specifications

UTP Cat.	Operating Frequency	Electrical Impedance	Signal Attenuation per 100m	NEXT loss (@ $\geq 100\text{m}$)
3	4 MHz	$\leq 100\Omega \pm 15\%$	$\leq 5.6 \text{ dB}$	$\geq 32 \text{ dB}$
	16 MHz	$\leq 100\Omega \pm 15\%$	$\leq 13.1 \text{ dB}$	$\geq 23 \text{ dB}^*$
4	4 MHz	$\leq 100\Omega \pm 15\%$	$\leq 4.3 \text{ dB}$	$\geq 47 \text{ dB}$
	16 MHz	$\leq 100\Omega \pm 15\%$	$\leq 8.9 \text{ dB}$	$\geq 38 \text{ dB}$
5	4 MHz	$\leq 100\Omega \pm 15\%$	$\leq 4.3 \text{ dB}$	$\geq 63 \text{ dB}$
	16 MHz	$\leq 100\Omega \pm 15\%$	$\leq 8.2 \text{ dB}$	$\geq 44 \text{ dB}$

*below Token Ring performance requirement of $\geq 30.5 \text{ dB}$.

Categories 4 and 5 are higher quality versions of category 3. They use the same gauge of wire but demonstrate superior performance due to improvements in material quality and assembly (e.g. more twists per foot).



Because Near-End Crosstalk (NEXT) contributes the majority of its detrimental effects near the end of a lobe cable, the quality of jumper cables and patch cables is critical. Seek the highest practical grade. The quality of connectors and terminators is also critical.



DO NOT connect UTP cabling to any non-Token Ring network conductors (telephone, etc.) or ground. If in doubt, test wiring before using. Telephone Battery and Ringing voltages used in UTP telephone circuits may present a shock hazard and may damage Token Ring equipment when connected to Token Ring cabling.

B.1.2 UTP Lobe Lengths

The physical length of the cable connecting a station to a TCU port on the STHI is referred to as the **lobe length**. The maximum lobe length attainable under ideal conditions, is shown in Table B-2. Cable routing, connector attenuation, noise, and crosstalk can adversely affect the maximum lobe length.

Table B-2. UTP Maximum Lobe Lengths.

UTP Category	@ 4 Mbps		@ 16 Mbps	
	meter s	(feet)	meter s	(feet)
3	200	(656)	100*	(328)*
4	225	(738)	110	(360)
5	250	(820)	120	(393)

* for cable with NEXT loss ≥ 30.5 dB per 100m

Some UTP category 3 cables fail to meet the performance minimums required to support a Token Ring network. Whereas category 3 allows for near end crosstalk (NEXT) loss as low as 23 dB per 100 m at 16 Mbps, Token Ring performance requirements demand a NEXT loss of at least 30.5 dB. To safeguard against worst case conditions (running at 16 Mbps and using category 3 cable with the category's lowest qualifying NEXT loss—23 dB), the recommended maximum lobe length should be reduced to keep crosstalk interference within acceptable levels.

B.2 Shielded Twisted Pair (STP)

STHI models 42 and 44 and TPIM models T1 and T4 support all STP cables classified as IBM Types 1, 2, 6, and 9, all of which meet Token Ring network performance requirements.

B.2.1 STP Cable Categories

The supported STP cable types meet the following specifications:

IBM Type 1 consists of two shielded twisted pairs (STP) of 22 AWG solid wire for data. Used for the longest cable runs within the walls of buildings.

IBM Type 2 consists of six pairs of unshielded twisted pairs of 24 AWG solid wire and a shield casing. The two pairs carried within the shield casing are used to carry Token Ring data. The four pairs carried outside of the shield casing are typically used for voice communication. Type 2 is frequently used to wire cable runs within the walls of buildings.

Table B-3. STP Cable Type Specifications.

IBM Type	Operational Frequency	Impedance	Attenuation per...	
			1000 m	(1000 ft)
1 & 2	4 MHz	$\leq 150\Omega \pm 15\%$	≤ 22 dB	(≤ 6.7 dB)
	16 MHz	$\leq 150\Omega \pm 15\%$	≤ 45 dB	(≤ 13.7 dB)
6 & 9	4 MHz	$\leq 150\Omega \pm 15\%$	≤ 33 dB	(≤ 10.0 dB)
	16 MHz	$\leq 150\Omega \pm 15\%$	≤ 66 dB	(≤ 20.0 dB)

IBM Type 6 consists of two STP of 26 AWG stranded wire for data. Because of its high attenuation, Type 6 is **used only in patch panels or to connect devices to/from wall jacks**. Attenuation for Type 6 cable is 3/2 x Type 1 cable (attenuation for 66 m of Type 6 = attenuation for 100 m of Type 1).

IBM Type 9 is similar to Type 1, but uses 26 AWG *solid* wire. Like Type 6, because of its high attenuation, Type 9 is **used only in patch panels or to connect devices to/from wall jacks**. Attenuation for Type 9 cable is 3/2 x Type 1 cable (66 m of Type 9 = 100 m of Type 1).



IBM Types 6 & 9 are to be used only for lobe connections from station to wall jack and patch panels.

B.2.2 STP Lobe Lengths

The maximum lobe length attainable under ideal conditions, is shown in Table B-4. Cable routing, connector attenuation, noise and crosstalk can adversely affect the maximum lobe length.

B.2.3 Mixed STP Cable Types

If cable types are to be mixed in the LAN, compensations must be made for the different cable attenuations. For example, Type 6 & 9 cables can be run for only 2/3 the distance of Type 1: 100 meters of Type 1 \approx 66 meters of Types 6 or 9)

Table B-4. STP Maximum Lengths

IBM Type	Max. Lobe Length		Max. Drive Distance	
	4 Mbps	16 Mbps	4 Mbps	16 Mbps
1 & 2	200 meters (660 feet)	100 meters (300 feet)	770 meters (2525 feet)	346 meters (1138 feet)
6 & 9	30 meters (99 feet)	30 meters (99 feet)	513 meters (1683 feet)	230 meters (755 feet)

B.3 Single Mode and Multimode Fiber Optic Cabling

TPIM models F2 and F3 support multimode and singlemode fiber optic cable respectively. Table B-5 below defines total signal attenuation tolerances for fiber cabling. Both media have a typical constant attenuation rate per km of fiber cable and each connector on the cable system contributes significant additional attenuation. Maximum drive distances define maximum allowable cable length.

Table B-5. Signal Tolerances for Fiber Optic Cable

Cable Type		Total Allowable Attenuation	Maximum Drive Distance
Multimode	50/125 μm	13.0 dB or less	2 km (2187.2 yards)
	62.5/125 μm	16.0 dB or less	
	100/140 μm	19.0 dB or less	
Typical Signal Attenuation Rate: ≤ 2.5 dB/km.			
Single	8/125-12/125 μm	10.0 dB or less	10 km (10936.0 yards).
	Typical Signal Attenuation Rate: ≤ 0.5 dB/km.		



The attenuation values shown in Table B-5 include the attenuation attributable to cables, connectors, patch panels, and reflection losses due to impedance mismatches in the segment.

Free Manuals Download Website

<http://myh66.com>

<http://usermanuals.us>

<http://www.somanuals.com>

<http://www.4manuals.cc>

<http://www.manual-lib.com>

<http://www.404manual.com>

<http://www.luxmanual.com>

<http://aubethermostatmanual.com>

Golf course search by state

<http://golfingnear.com>

Email search by domain

<http://emailbydomain.com>

Auto manuals search

<http://auto.somanuals.com>

TV manuals search

<http://tv.somanuals.com>