

# CANNON



# PROFESSIONAL 1000 TRADITIONAL 1000

# FREESTANDING GAS COOKER

## Use and Installation Instructions

This appliance must be installed in accordance with the regulations in force and only used in a well ventilated space.

The data badge is fitted on the rear panel. The model/serial number can also be found on a badge located below the left-hand oven door beneath the door seal.

**Read these instructions before installing or using the appliance and retain them for future reference.**

**These instructions are only valid for the countries whose symbols appear in the manual and on the serial number plate.**

---

# CONTENTS

---

**PAGE**

<b>Introduction</b>	<b>3</b>
<b>For Your Safety</b>	<b>4</b>
Oven Timer Operation	6
Hotplate	12
Griddle	15
Some recipe ideas for your griddle	16
Grill	17
Ovens	19
Oven Cooking Chart	20
The "Slow Cook" Setting	22
Care and Cleaning	23
Something wrong with your Cooker?	25
<b>Installation Instructions</b>	<b>27</b>
Guarantee Information	35
Service Information	36

---

# INTRODUCTION

---

To help you make the best use of your cooker, PLEASE READ THIS BOOKLET CAREFULLY.

Your new cooker is guaranteed and will give lasting service. The guarantee is only applicable if the cooker has been installed in accordance with the Installation Instructions.

The cooker is designed specifically for domestic use and responsibility will not be accepted for use in any other installation.

When first using the cooker ensure that the room is well ventilated (e.g. open a window or use an extractor fan) and that persons who may be sensitive to the odour avoid any fumes. It is suggested that any pets be removed from the room until the smell has ceased. This odour is due to any temporary finish and also any moisture absorbed by the insulation.

Our policy is one of continual improvement in design and development, therefore strict accuracy of illustrations and descriptions cannot be guaranteed.



This appliance conforms to the following EEC directives:

**Gas Appliances**

- 90/396/EEC

**Low Voltage Equipment**

- 2006/95/EEC

- 93/68/EEC

**Electromagnetic Compatibility;**

- 89/336/EEC

- 92/31/EEC

- 93/68/EEC

---

# FOR YOUR SAFETY

---

**Please read the precautions below before using your cooker.**

## **ALWAYS . . .**

- ALWAYS make sure you understand the controls before using the cooker.
- ALWAYS check that all controls on the cooker are turned off after use.
- ALWAYS stand back when opening an oven door to allow heat to disperse.
- ALWAYS use dry, good quality oven gloves when removing items from the ovens.
- ALWAYS take care when removing items from the top oven/grill when the main oven is on, as the contents may be hot.
- ALWAYS keep the oven and grill doors closed when the cooker is not in use.
- ALWAYS place pans centrally over the hotplate burners and position them so that the handles cannot accidentally be caught or knocked or become heated by other burners.
- ALWAYS keep the cooker clean, as a build up of grease or fat from cooking can cause a fire.
- ALWAYS allow the cooker to cool before cleaning.
- ALWAYS follow the basic principles of food handling and hygiene to prevent the possibility of bacterial growth.
- ALWAYS keep ventilation slots clear of obstructions.
- ALWAYS turn off the electricity supply before cleaning or replacing an oven lamp.
- ALWAYS refer servicing to CORGI registered appliance service engineers.
- ALWAYS ACCESSIBLE PARTS MAY BECOME HOT WHEN THE GRILL IS USED. YOUNG CHILDREN SHOULD BE KEPT AWAY.
- ALWAYS Children should be supervised to ensure that they do not play with the appliance
- ALWAYS During use the appliance becomes hot. Care should be taken to avoid touching heating elements inside the oven

---

# FOR YOUR SAFETY

---

## NEVER . . .

- NEVER leave children unsupervised where the cooker is installed as all surfaces will get hot during and after use.
- NEVER allow anyone to sit or stand on any part of the cooker.
- NEVER store items that children may attempt to reach above the cooker.
- NEVER heat up unopened food containers as pressure can build up causing the container to burst.
- NEVER store chemicals, food stuffs, pressurised containers in or on the cooker, or in cabinets immediately above or next to the cooker.
- NEVER fill a deep fat frying pan more than 1/3 full of oil, and never use a lid. **DO NOT LEAVE UNATTENDED WHILE COOKING.**
- NEVER place flammable or plastic items on or near the hotplate.
- NEVER use proprietary spillage collectors on the hotplate.
- NEVER use the cooker as a room heater.
- NEVER dry clothes or place other items over or near to the hotplate or oven/grill doors.
- NEVER wear garments with long flowing sleeves whilst cooking.
- NEVER operate the grill with the grill doors closed. This may cause overheating of your cooker.
- NEVER line the shelves, floor or sides of the oven or grill with aluminium foil as over heating and damage can result.
- NEVER use steam cleaners.
- NEVER touch the heating elements inside the oven or grill even when off.

NOTE: The use of a gas cooking appliance results in the production of heat and moisture in the room in which it is installed. Always ensure that the kitchen is well ventilated; keep natural ventilation holes open or install a mechanical ventilation device (mechanical extractor hood).

In particular when using the grill or more than one hotplate burner, open a window if a mechanical ventilation device is not operating.

**!** The appliance should not be operated by people (including children) with reduced physical, sensory or mental capacities, by inexperienced individuals or by anyone who is not familiar with the product. These individuals should, at the very least, be supervised by someone who assumes responsibility for their safety or receive preliminary instructions relating to the operation of the appliance.

---

# OVEN TIMER OPERATION

---

The oven timer offers you the following features:

1. Time of Day
2. Automatic Cooking
3. Minute Minder

## **AUTOMATIC COOKING**

The LEFT HAND oven can be controlled automatically.

## **GUIDANCE ON AUTOMATIC COOKING**

1. Select foods which will take the same time to cook.
2. Set the oven timer so that the food has just finished or is just about to finish cooking on your return to the oven. This will ensure the food has not cooled down and does not require reheating before serving.
3. Food should be as cold as possible when it goes into the oven, ideally straight from the refrigerator. Frozen meat and poultry should be thawed thoroughly before it is put in the oven.
4. Warm food should never be placed in the oven if there is to be a delay period. Stews prepared by frying the meat and vegetables should be cooked as soon as possible.
5. Dishes containing left-over cooked poultry or meat, for example Shepherds Pie, should not be cooked automatically if there is to be a delay period.
6. Stews and joints should be cooked by the long slow method, so that the delay period is kept to a minimum.
7. On warm days, to prevent harmful bacterial growth in certain foods (ie poultry, joints, etc) the delayed start should be kept to a minimum.
8. Wine or beer may ferment and cream may curdle during the delay period, so it is best to add these ingredients just before serving.
9. Foods which discolour should be protected by coating in fat or tossing in water to which lemon juice has been added, prior to placing food in the oven.
10. Dishes containing liquid should not be filled too full to prevent boiling over.
11. Food should be well sealed (but not airtight) in a container to prevent the loss of liquid during cooking. Aluminium foil gives a good seal.
12. Ensure food is cooked thoroughly before serving.

# OVEN TIMER OPERATION



## CLOCKFACE

The timer incorporates a 24 hour clock.

**Ensure the correct time of day is always set, before using your cooker.**

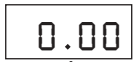

## SYMBOLS

A 'bell' symbol will light up when you select a Minute Minder Period and will remain lit for the period set.

At the end of the Minute Minder Period, the timer will emit an audible tone and the 'bell' symbol will disappear.

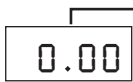

The 'cookpot' symbol will light up either:-

- When the timer is in manual mode, or
- During the actual Cook Period.



'AUTO' will light up:-

- When the timer is first turned on it will flash. It will go out when a time of day is set or when the timer is set to manual.

The 'AUTO' symbol will flash at the end of an Auto Cooking programme to indicate that the programme has finished.



***(When the 'AUTO' symbol is flashing, to return the oven to Manual operation, turn the oven controls off, ensure that the correct time of day is set, and press the "Manual" button - The 'AUTO' symbol will go out).***

## TIMER FUNCTION BUTTONS

### Minute Minder Button

Here you can set a time period of up to 23 hours 59 minutes, that will count down. When it reaches zero, the timer will emit an audible tone.

**For Example:** If you set 20 minutes, the audible tone will occur 20 minutes later.

## AUTO COOKING PROGRAMME

### Cook Period Button

Cook Period is the actual length of time for which, the timer will switch the oven(s) on as part of an "Auto Cooking" programme. (e.g. If you set 2 hours, the food will be cooked for 2 hours).

### End Time Button

The time of day at which you want an "Auto Cooking" programme to end.

**For Example:** If you set a "Cook Period" for 2 hours, and "End Time" of 11:00. The timer will switch the oven(s) on at 9:00 and turn the oven(s) off at 11:00. You will hear a audible tone at 11:00, to indicate that the Auto Cooking Programme has finished.

### Notes:

- When setting an Auto Cooking programme you will need to set the oven control(s) to the required temperature(s) when you set the timer.
- If an Auto Cooking programme has been set the oven(s) will only operate during the pre-programmed time.

### Manual Button

Needs to be pressed to cancel an Auto Cooking programme and return the oven(s) to Manual operation.

### "+" and "-" Buttons

Used to adjust the various timer function settings.

# OVEN TIMER OPERATION

## SETTING THE TIME OF DAY

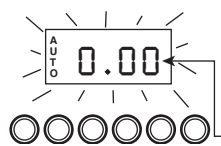

**Step 1** Make sure all oven controls are turned Off.

**Step 2** Check the electricity supply to the cooker is turned on.

**Step 3** When switched on the display will show 0.00 and the Auto symbol, flashing intermittently.

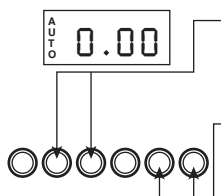

**Step 4** Press & hold in both the Cook Period & End Time buttons together.

**Step 5** With the Cook Period & End Time buttons still held in, press either the "+" or "-" buttons to set the correct time of day.

**Step 6** Release all the buttons simultaneously. THE TIME OF DAY IS NOW SET.

*To change the time of day repeat Steps 4, 5 & 6 above.*

**Note:** You cannot adjust the time of day if the timer has been set for an Auto Cooking Programme.

## SETTING THE MINUTE MINDER

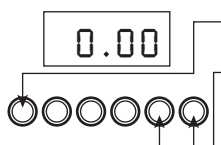

**Step 1** Ensure the time of day is set correctly.

**Step 2** Press and hold the Minute Minder button.

**Step 3** With the Minute Minder button held in, set the required Minute Minder period using the "+" and "-" buttons. A 'bell' symbol will light up.

Release all buttons and the timer display will revert back to the time of day. The 'bell' symbol will remain lit to signify that a Minute Minder period has been set.

At the end of the set time an audible tone will be heard, and the 'bell' symbol will disappear.

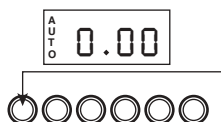

**Step 4** To cancel the audible tone press the Minute Minder button.

**Note 1** When the Minute Minder has been set, the time remaining can be checked at any time by simply pressing the Minute Minder button.

**Note 2** If necessary the Minute Minder can be cancelled before the tone sounds by pressing and holding the Minute Minder button and then at the same time pressing the "-" button until 0.00 appears in the display window.



# OVEN TIMER OPERATION

## AUTO COOKING PROGRAMMES

There are two Auto Cooking programmes that can be selected using your timer:-

- (a) To set the timer to switch the oven(s) On and Off Automatically
- (b) To set timer to switch on immediately and OFF automatically after a set cook period.

### a) TO SET THE TIMER TO SWITCH THE OVEN(S) ON AND OFF AUTOMATICALLY

*This allows you to cook at a specified time for a chosen period before the oven switches off Automatically.*

**Step 1** Check that the correct time of day is set, if not follow instructions for setting the time of day.

**Step 2** Place food onto the correct shelf position in the oven and close the oven door(s).

 **Step 3** Press and hold in the Cook Period button. The display will read 0.00 with the 'cookpot' symbol lit.

 **Step 4** With the Cook Period button still held in, set the required Cook Period using the "+" and "-" buttons.

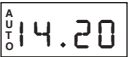
 Release the buttons and the timer display will revert to the time of day with the 'Auto' symbol and 'cookpot' symbol lit.

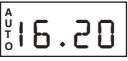

 **Step 5** Press and hold in the End Time button. The display will read the earliest possible end time for the Cook Period that you have set above. The 'Auto' symbol and 'cookpot' symbol will be lit.

 **Step 6** With the End Time button still held in, use the "+" and "-" buttons to set the 'End Time' (i.e. The time you require the oven to switch off ). Release all the buttons and the timer will revert back to the time of day.

 The 'Auto' symbol will remain lit to signify that an Auto Cooking Programme has been set. The 'cookpot' symbol will go out.



**Step 7** Turn the oven control(s) to the required temperature, and if necessary select the appropriate oven function.

At the end of the Automatic Cook Period the Auto Symbol will flash and an intermittent beeping sound will be heard.

The audible tone will continue unless cancelled.

The 'Auto' symbol will continue to flash until the timer is returned to Manual operation (see below).





**Step 8** Press the Manual button, the audible tone will be cancelled and the oven(s) will be returned to Manual.

**Step 9** Turn the oven control(s) to the OFF position.

# OVEN TIMER OPERATION

**Note 1** When cooking automatically the Cook Period can be checked at any time by simply pressing the Cook Period button.

**Note 2** When cooking automatically the End Time can be checked at any time by simply pressing the End Time button.

## b) TO SET TIMER TO SWITCH ON IMMEDIATELY AND OFF AUTOMATICALLY AFTER A SET COOK PERIOD

**Step 1** Check that the correct time of day is set, if not follow instructions for setting the time of day.

**Step 2** Place food onto the correct shelf position in the oven and close the oven door(s).

**Step 3** Turn the oven control(s) to the required temperature, and if necessary select the appropriate oven function.

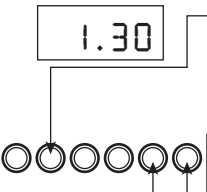

**Step 4** Press & hold in the Cook Period button, the display will read 0.00 and the 'cookpot' symbol will light up. With the Cook Period button still held in set the required Cook Period using the "+" and "-" buttons. Example: 1hr 30 minutes (as shown).

**Step 5** Release all buttons.

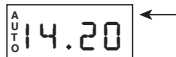

The timer display will revert to the time of day with the 'Auto' symbol lit & 'cookpot' symbol remaining lit.



NOTE: The Cookpot symbol disappears

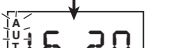

At the end of the Cook Period the 'Auto' symbol will flash and an intermittent audible tone will be heard. The audible tone will continue until cancelled. The 'Auto' symbol will continue to flash until the timer is returned to Manual operation (see below).

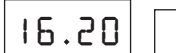
**Step 6** Press the Manual button. The audible tone will be cancelled and the oven(s) will be returned to Manual.



**Step 7** Turn the oven control(s) to the OFF position.

# OVEN TIMER OPERATION

## TO CANCEL AN AUTO COOKING PROGRAMME BEFORE THE COOK PERIOD HAS FINISHED.

**Step 1** Turn the oven control to the OFF position.

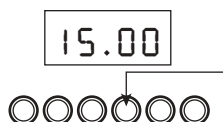

**Step 2** Press the Manual button to return the oven to "Manual" operation. The 'Auto' symbol will go out.

**Note 1** When cooking automatically the Cook Period can be checked at any time by simply pressing the Cook Period button.

### OTHER NOTES ON TIMER OPERATION

1. When cooking Automatically the Cook Period can be checked at any time simply by pressing the Cook Period button.
2. When cooking Automatically the End Time can be checked at any time by simply pressing the End Time button.
3. Having set a Cook Period and End Time an electronic device stores the information. The device within the timer will switch the oven(s) on and off at the required times.
4. When setting an Auto Cooking Programme and a mistake is made, to clear:-
  - (a) Press & release the Manual button.
  - (b) Start the sequence again.
5. If at any time the display shows three flashing zero's 0.00 and 'Auto', it is likely that the electricity supply to the oven has been interrupted. Reset the timer to the correct time of day. ***Food in the oven may, therefore, not have been cooked, before serving check food is thoroughly heated and completely cooked.***
6. To set each function always press and hold the required function button and at the same time press "+" or "-" buttons.

---

# HOTPLATE

---

The dual control wok burner consist of a smaller inner and larger outer burner that can operate either together or separately. The use of both burners on maximum setting, together with large pans, gives a very high output and reduces heating times. Use of the two burners together provides a more uniform distribution of heat on the bottom of the pan.

Cookware of all sizes can be used above the dual control wok burner.

For small pans it is recommended that only the inner burner is used.

The control knob marked  operates the outer burner.

The control knob marked  operates the inner burner.

## OVAL BURNERS

The two oval burners on the right hand side of the hotplates can be turned through 90° to suit the shape of the cookware being used.

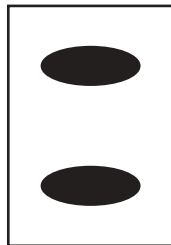

Example for:  
rectangular dishes  
and when using  
the griddle plate.



Example for:  
when using oval dishes  
(ie. fish pans).

All pans should be placed centrally over the burners. All hotplates can accommodate pans between 100mm (4") and 200mm (8"). Pans up to 260mm (10") can be used on the dual wok burner.

---

# HOTPLATE

---

## TO USE THE HOTPLATE

1. Press the ignition button and then push in and turn the control knob of the chosen burner anti-clockwise to the large flame symbol. Continue to press the ignition button until the spark lights the gas. When operating the dual control burner there is a separate control knob for the inner and outer burners.
2. Turn the control knob anti-clockwise to the desired setting. Only turn the control knob between the large flame symbol and the small flame symbol for adjusting the setting.
3. To turn off, turn the control knob fully clockwise to the **O** position.

**DO NOT** use mis-shapen pans which may be unstable.

**DO NOT** use round base woks directly on the pan supports.

Each burner is fitted with a spark ignitor for lighting the gas.

To ensure rapid lighting of the burners every time they are used, the ignitors must be kept **clean and dry**. Remove any food spillage or cleaning materials from the ignitor using a small nylon brush such as a tooth brush.

Access to the ignitor can be achieved by lifting off the loose burner parts carefully when the burners are cool.

In the event of the burner flames being accidentally extinguished, turn off the burner controls and do not attempt to re-ignite the burners for at least 1 minute.

If aluminium based pans are used, a silvery deposit may appear on the top edge of the pan support fingers. See 'Care and Cleaning' section for cleaning information.

## **Models with Hob Gas Burner Safety Devices to Prevent Leaks** (only available on certain models)

These models can be identified by the presence of the device itself.

**!** Since the hob burners are equipped with a safety device, you must hold the control knob in for about 3 seconds after the burner has been lighted to allow the gas to pass until the safety thermocouple has heated.

---

# HOTPLATE

---

For the hotplate to work in the most efficient way possible and in order to save on the amount of gas consumed, it is recommended that only pans which have a lid and a flat base are used. They should also be suited to the size of the hotplate.

Hotplate	∅ Cookware diameter (cm)
Rear left	24 - 26
Front left	16 - 22
Centre rear	10 - 14
Front right	16 - 22
Rear right	16 - 22
Centre front (DCDR internal)	10 - 14
Centre front (DCDR external)	26 - 28

! Make sure the pans do not overlap the edges of the hob while it is being used.

## SAFETY REQUIREMENTS FOR DEEP FAT FRYING

1. Never fill chip pans more than one third full with oil or fat.
2. Never leave oil or fat unattended during the heating or cooling period.
3. Never heat fat or fry with a lid on the pan.
4. Always dry food thoroughly before frying, and lower it slowly into the hot oil or fat. Frozen foods in particular will cause frothing and spitting if added too quickly.
5. Always keep the outside of the pan clean and free from streaks of oil or fat.

## HOW TO DEAL WITH A FAT FIRE

1. **Do not** move the pan.
2. Turn off the hotplate burners.
3. Smother the flames with a fire blanket or damp cloth to extinguish the fire. **Do not** use water or a fire extinguisher as the force of it may spread the burning fat or oil over the edge of the pan.
4. Leave the pan for at least 60 minutes before moving it.

---

# GRIDDLE

---

A non-stick griddle is supplied for use over the two burners on the right hand side of the hob. The griddle is made of cast iron and the surface is covered with a special nonstick finish. To protect the non-stick coating never use metal cooking utensils as they may scratch the surface. Wooden or heat resistant plastic utensils may be used. Do not use saucepans on the griddle plate.

**UNDER NO CIRCUMSTANCES MUST THE GRIDDLE PLATE BE USED OVER ANY OTHER HOTPLATE BURNERS.**

## USE OF THE GRIDDLE

The griddle may be used with either or both of the burners on, depending on the food being cooked. The griddle can be positioned with the ridged portion at the front or at the rear.

1. Secure the griddle above the two simmer burners, on the right hand side of the hob, making sure that the support feet are located correctly on the pan support fingers.
2. Press the ignition button and then push in and turn the control knob(s) of the burners anticlockwise to the large flame symbol. Continue to press the ignition button until the spark lights the gas. Preheat the griddle plate for approximately four minutes.
3. Place the food directly on the griddle plate. However when cooking drier foods eg. drop scones the griddle plate can be lightly greased.
4. The controls can be left at high for the sealing of foods or turned down to a lower heat setting depending on what food is being cooked. NB. A gentle heat is all that is required for the majority of griddling. Once the griddle plate is up to temperature it maintains the cooking temperature on a medium/low setting.
5. Cook the food for the required time, which will depend on the type of food being cooked.
6. To turn off, push in and turn the control knob(s) fully clockwise to the **0** position.
7. Allow the griddle plate to cool before cleaning.

In the event of the burner flames being accidentally extinguished, turn off the burner controls and do not attempt to re-ignite the burners for at least 1 minute.

## - SOME RECIPE IDEAS FOR YOUR GRIDDLE -

### DROPPED SCONES

4oz (100g) plain flour  
1/4 tsp salt  
1 level tsp (5ml) cream of tartar  
1/2 level tsp (2.5ml) bicarbonate of soda  
1 egg  
1oz (25g) caster sugar  
1/4 pint (150ml) milk  
1/2oz (10g) margarine

### METHOD

1. Rub the fat into the flour.
2. Beat in the remaining ingredients.
3. When a smooth batter has been obtained, drop spoonfuls on to the pre-heated griddle plate.
4. Turn each scone when bubbles start to burst on the upper side.
5. Cook on the reverse side until light brown and the scone, when split, is dried through.
6. Allow approx. 3 minutes for the first side and 2 minutes for the second.
7. Place inside a clean folded towel laid over a cooling rack.
8. When cool, butter and serve.

### WELSH CAKES

6oz (175g) plain flour  
1/2 level tsp (2.5ml) salt  
1/4oz (5g) baking powder  
2oz (50g) margarine  
2oz (50g) sugar  
2oz (50g) currant or sultanas  
1/4 tsp grated nutmeg  
1 egg  
a little milk

### METHOD

1. Sieve the flour and salt into a bowl.
2. Rub in the fat.
3. Add the dry ingredients.
4. Beat the egg and mix to a soft dough adding a little milk to obtain a soft consistency.
5. Roll out 1/4" (5mm) thickness.
6. Cut out with a 2" (50mm) plain cutter.
7. Cook on the pre-heated griddle for about 6 minutes each side.
8. They may be eaten hot or cold and should be split and buttered.

### POTATO CAKES

8oz (225g) warm creamed potatoes  
2oz (50g) plain flour  
1/2 (2.5ml) salt  
pepper to taste  
2 tsp (10ml) milk

### METHOD

1. Mix all the ingredients together.
2. Knead lightly.
3. Roll out thinly and cut with a pastry cutter to suit requirements.
4. Cook on a pre-heated griddle for 3-4 minutes on each side.



# GRILL

**CAUTION - ACCESSIBLE PARTS MAY BECOME HOT WHEN THE GRILL IS USED. YOUNG CHILDREN SHOULD BE KEPT AWAY.**

**GRILLING SHOULD NEVER BE UNDERTAKEN WITH THE GRILL DOOR CLOSED.**

The grill control is designed to provide variable heat control of either the full width of the grill or just the grill half. Turning the control knob clockwise will switch on the full width and turning anticlockwise will switch on just the grill half.

A gentle flow of air will be blown from underneath the control panel when the grill is in use.

**If the fan fails to blow air beneath the control panel when the grill is in use, you should contact your service engineer immediately (see back page).**

## Using the grill pan kit

The grill pan handle is detachable from the pan to facilitate cleaning and storage. Fix the pan handle securely before use:

1. Fit the handle to the grill pan so the external 'hooks' embrace the that edge of the pan (fig. 1)
2. Make sure that the middle part of the handle fits exactly the protruding support of the pan (fig .2) and holds the pan from the bottom.

The food must be placed on the rack in the grill pan.

Position the grill pan on top of the oven rack. The best results are achieved by placing the oven rack on the uppermost shelves. Pouring a little water into the grill pan will make the collection of grease particles more efficient and prevent the formation of smoke.

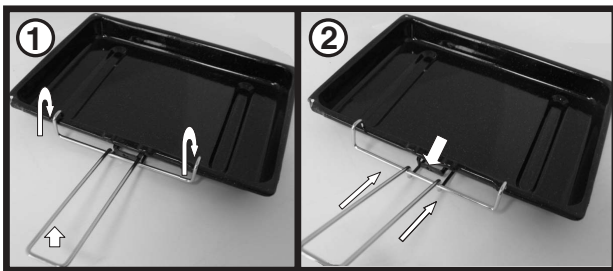

## TO USE THE GRILL

1. Check that the electricity supply is switched on.
2. Open the grill door and remove the grill pan.
3. Place shelf in chosen position. Refer to grilling chart.
4. Press the ignition button and then push in and turn the control knob clockwise to the large flame symbol. Continue to press the ignition button until the sparks light the gas. If, after 15 seconds, the burner is still not alight, release the knob, open the oven door and wait for at least 1 minute before trying to light it again.
5. Slide the grill pan along the shelf towards the rear of the grill compartment until it stops.
6. Turn the control knob to the desired setting. Only turn the control knob between the large flame symbol and the small flame symbol when adjusting the setting.
7. To turn off, turn the control knob anti-clockwise to the symbol **O**.

An odour may be noticed when first using the grill - this should cease after a short period of use.

**DO NOT** cover the grill pan or grid with aluminium foil as this can hold fat, intensify the heat and create a fire hazard.

# GRILL

Use the following chart as a guide only. Grilling can be started from cold but for best results preheat for approximately two minutes. Most cooking is done with the heat on full, but it may be desirable to reduce it for thicker pieces of meat or for keeping food warm.

There are 3 shelf positions available for grilling.

Shelf Position	Food
HIGH POSITION	Toast, pikelets/crumpets, bacon, thin sausages, beefburgers, tomato halves, steak (rare and medium), kippers, gammon, kidneys and toasted snacks.
CENTRE POSITION	Toast, toasted snacks, thick sausages, beefburgers, fish fingers, steak (well done) and gammon, chops (with heat turned down for part of cooking time).
LOW POSITION	Whole fish, fish fillets and fish steaks (on base of pan). Chicken portions (with heat turned down for part of cooking time).

For au gratin dishes eg. Macaroni Cheese and meringue toppings eg. Baked Alaska, place the dish on the floor of the grill compartment. The base of the grill pan can be used for warming fruit garnishes on the reduced setting.

---

# OVENS

---

The two ovens work in the same way, except only the left hand oven can be controlled with the timer (see Oven Timer Operation).

The oven has different heat zones - the thermostat settings refer to the temperature on the middle shelf position; above this shelf it is hotter and below it is cooler.

Two shelves provide five possible cooking levels enabling full use of the different temperatures inside the oven.

Each shelf has a safety stop to prevent it from being pulled out too far when attending to remove food. Shelves are removed from the oven by pulling them out to the stop and then lifting them at the front to withdraw.

The baking dish and grill pan without the handle can be used in the oven. The maximum size of baking tray that should be used is 300mm x 330mm (12" x 13").

## TO USE THE MAIN OVEN

1. Check that the electricity supply is switched on and the timer is set to manual mode.
2. Place oven shelves in the chosen positions (refer to cooking charts).
3. Push in and turn the oven control knob fully anti-clockwise. Sparking will continue until the burner is lit.
4. Turn the control knob clockwise to the required setting (refer to cooking chart). There is a delay of about one minute whilst the safety device operates before the burner comes on full.
5. To turn off, turn the control knob fully clockwise to the symbol **O**.

NEVER place dishes over the burner.

An odour may be noticed when first using the oven - this should cease after a short period of use.

## COLD START COOKING

Anything requiring long slow cooking such as casseroles and rich fruit cakes can be put into a cold oven. Satisfactory results can also be obtained with creamed mixture, rich pastries or yeast mixtures, but for perfection we recommend preheating the oven for about 15 minutes at the gas mark you require for cooking.

## ROASTING OF LARGE POULTRY

The maximum weight of poultry that can be accommodated is 11.5kg (25 lbs) of suitable shape. It is important to check that the bird DOES NOT overhang the burner at the back of the oven.

## STORAGE AND RE-HEATING OF FOOD

It is vitally important to strictly adhere to the basic principles of food handling and hygiene to prevent the possibility of bacterial growth.

1. If food is to be frozen or not served immediately, cool it in a clean container as quickly as possible.
2. Completely thaw frozen food in the refrigerator before re-heating.
3. Re-heat food thoroughly and quickly either on the hotplate or in a hot oven, Mk. 6, and then serve immediately.
4. Only re-heat food once.

## 'COOK CHILL' DISHES

These should always be placed in a pre-heated oven ideally on the first or second shelf position. Follow the packet instructions for cooking time.

## ALUMINIUM FOIL

If using Aluminium Foil:

1. Remember that it is important to increase the cooking time by one third.
2. Never allow the foil to touch the sides of the oven.
3. Never cover the oven interior with foil.
4. Never cover the oven shelves with foil.

# OVEN COOKING CHART

The following times and setting are for guidance only. You may wish to alter the setting to give a result more to your satisfaction. When a different setting to that shown below is given in a recipe, the recipe instructions should be followed. Allow 15 minutes preheat for best results.

Always turn the thermostat knob to Mark 9 first, before turning back to the required Gas Mark.

Shelf position 1 is the highest.

Food	Gas Mark	Shelf Positions	Approx. Cooking Time and Comments
<b>FISH</b>			
Oily and white fish	3 or 4	4	25-60 mins. depending on recipe
<b>MEAT AND POULTRY</b>			
Beef	4 or 5	4	25 - 30 mins per 450g (1lb) + 25 mins. extra
Ham	5	4	40 mins per 450g (1lb) covered in foil plus 40 mins extra
Lamb	5	4	30 mins per 450g (1lb) + 30 mins. extra
Pork	5	4	40 mins per 450g (1lb) + 40 mins. extra
Chicken	5	4	25 mins per 450g (1lb) + 25 mins. extra
Duckling & Goose	5	4	25 mins per 450g (1lb) + 25 mins. extra
Turkey	4 or 5	4 or 5	15 - 20 mins per 450g (1lb) + 20 min.
Game birds	6	4	50 mins Removed bacon for last 15 mins. Add extra 15 mins if roasting brace
Casseroles	3	3 or 4	2-6 hrs. depending on cut of meat
<b>VEGETABLES</b>			
Baked jacket potatoes	4 or 5	3	1 ½ - 3 hrs. until soft, depending on size
<b>PUDDINGS</b>			
Milk Puddings (500ml/1pt)	3	4	1¼ - 2 ½ hrs stand dish on a baking tray and started with warm milk
Baked Custard (500ml/1pt)	3	4	45 - 60 mins. in bain-marie
Baked Sponge Puddings	4	3	40 - 50 mins
Baked Apples	3	3	30 - 45 mins depending on the size and type of apples
Meringue Topped Puddings	1	3 or 4	15 mins or until 'tinged' with brown
Apple Tart (1x205mm/8")	6	3	45 - 60 mins
Fruit Crumble	5	3	35 - 45 mins

# OVEN COOKING CHART

Food	Gas Mark	Shelf Positions	Approx. Cooking Time and Comments
<b>CAKES, PASTRIES &amp; BISCUITS</b>			
Small Cakes (16 per tray) 2 trays	5	2 and 4	17 - 25 mins
1 tray	5	2	17 - 25 mins
Victoria sandwich (2 x180mm / 7" )	4	2 and 4	20 - 30 mins.
Swiss Roll (3 egg quantity)	5	2	20 - 25 mins.
Christmas cake (1 x 205mm / 8")	2	3 or 4	3 - 6 hrs depending on recipe
Madeira cake (1 x 180mm / 7")	4	3	1¼ - 1½ hrs.
Rich Fruit cake (1 x 180mm / 7")	2	3	3 - 3½ hrs.
Scones - 16 per tray	7	2 and 4	10 - 30 mins. depending on recipe
Shortbread (1 x 180mm /7")	2	3	45 - 60 mins. depending on recipe
Biscuits	4	2 and 4	15 - 35 mins. depending on recipe
Shortcrust Pastry	6	2 and 4	15 - 60 mins. depending on recipe
Rich Short Crust	5	2 and 4	20 - 40 mins. depending on recipe
Flaky/Puff Pastry	7	2 and 4	10 - 30 mins. depending on recipe
Choux Pastry	6	2	25 - 35 mins.
<b>YEAST MIXTURES</b>			
Bread - Rolls	7	2 and 3	15 - 45 mins. depending on recipe
<b>MISCELLANEOUS</b>			
Yorkshire Pudding - large	7	2	35 - 45 mins
Yorkshire Pudding - individual	7	2	20 - 30 mins
Meringues	Slow Cook	4 and baseplate	2 - 5 hrs starting on shelf 4 until 'set' and then on the baseplate until dried out - turn when necessary.

When baking with two trays or tins on two levels, the top tray is removed first and the lower tray moved up to the top position for a few minutes longer.

**Soft Margarine** - Use the oven settings recommended by the margarine manufacturer and **not** those indicated on the cooking chart.

---

# THE 'SLOW COOK' SETTING

---

With the fanned oven thermostat set to **90°** the oven can be used for slow cooking - The 'Slow Cook' setting.

## PREPARING FOOD FOR SLOW COOKING

1. All dishes cooked by the 'Slow Cook' setting should be cooked for a minimum 6 hours. They will 'hold' at this setting for a further hour but marked deterioration in appearance will be noticed in some cases.
2. Joints of meat and poultry should be cooked at Mark 6 for 30 minutes before turning to the 'Slow Cook' setting and never be cooked lower than the middle shelf position.
3. Joints of meat over 6 lbs (2.7kg) and poultry over 4 lbs 8oz (2 kg) should not be cooked using the 'Slow Cook' setting.
4. Always stand covered joints on a rack over the meat tin to allow good air circulation.
5. A meat thermometer should be used when cooking pork joints and poultry. The internal temperature of the food should reach at least 88°C.
6. This method is unsuitable for stuffed meat and stuffed poultry.
7. Always bring soups, casseroles and liquids to the boil before putting in the oven.
8. Cover casseroles with foil and then the lid to prevent loss of moisture.
9. Always thaw frozen food completely before cooking.
10. Root vegetables will cook better if cut into small pieces.
11. Adjust seasonings and thickenings at the end of the cooking time.
12. Use the zones of heat in the oven, e.g. meringues and milk puddings can be cooked lower in the oven whilst other dishes requiring greater heat can be cooked above them.
13. Egg and fish dishes need only 1-5 hours cooking and should be included in day cooking sessions, when they can be observed from time to time.
14. Dried red kidney beans must be boiled for a minimum of ten minutes after soaking, before inclusion in any dish.

## WARMING COMPARTMENT

The warming compartment is situated at the bottom right hand side of the cooker. It can be used for keeping plates or food warm. It is not designed as a 'Slow Cook' oven.

---

# CARE AND CLEANING

---

**! Never use steam cleaners or pressure cleaners on the appliance.**

! Clean the glass part of the oven door using a sponge and a non-abrasive cleaning product, then dry thoroughly with a soft cloth. Do not use rough abrasive material or sharp metal scrapers as these could scratch the surface and cause the glass to crack.

! The accessories can be washed like everyday crockery (even in your dishwasher).

**! Switch off the electricity supply and allow to cool before cleaning the cooker.**

**! Clean the cooker regularly and wipe up spills soon after they occur to prevent them from becoming burnt on. Never use biological washing powder, caustic cleaners, harsh abrasives, scouring pads, steam cleaners, aerosol cleaners or oven chemical cleaners of any kind.**

**! Before moving your cooker ensure that it is cool and note that it is heavy so you may require assistance.** The cooker is fitted with rear wheels and will slide in and out of position easily.

Movement of your cooker is most easily achieved as follows:

Open the grill/oven door sufficiently to allow a comfortable grip on the underside front edge of the oven roof, avoiding contact with any grill or oven furniture and then lift and slide at the same time.

When repositioning the cooker, ensure that it is level. Take care to ensure that any floor covering is not damaged.

## 'HEAT CLEAN' LINERS

The oven linings are coated with a special enamel which has a continuous cleaning action. The higher the oven temperature the more effective the action. In most cases this cleaning operation will proceed during normal cooking.

However, if high temperatures are not used regularly it may be necessary to run the oven empty at maximum setting for one hour. If desired, they can be wiped over with a soapy cloth followed by a wipe with a clean, damp cloth.

## CLEANING THE GRIDDLE PLATE

After cooking, leave the griddle plate on the hob and allow to cool before cleaning. It can then be taken to the sink and washed using warm soapy water, gently wipe the cooking surface with a dishcloth. DO NOT use abrasive cleaning materials.

## REPLACEMENT OF OVEN LIGHT BULB

**CAUTION: DISCONNECT THE APPLIANCE FROM THE ELECTRICITY SUPPLY BEFORE REPLACING THE LAMP TO AVOID THE POSSIBILITY OF AN ELECTRIC SHOCK.**

Light bulbs are not covered by the manufacturer's guarantee.

A new 15W, 300°C rated SES bulb can be obtained from your cooker supplier or any major electrical retailer.

1. Remove the shelves from the oven.
2. Unscrew the lens using a thick cloth to protect your fingers in the unlikely event of a lens fracture.
3. Unscrew bulb.
4. Fit new bulb and refit lens.

# CARE AND CLEANING

COOKER FINISH	CLEANING METHOD
<p><b>Vitreous Enamel</b> Hotplate (Traditional), pan supports, burner caps, roasting dish, grill pan, oven base, rear and roof, door inner panels, grill and warming compartments.</p>	<p>Cloth wrung out in warm soapy water. Stubborn stains can be removed with a cream paste, liquid cleaner or by rubbing with fine steel wool soap pads e.g. Brillo, Ajax. Check that the cleaning agent is approved by the Vitreous Enamel Association.</p>
<p><b>Aluminium</b> Burner bodies, door handles.</p>	<p>Similar to paint cleaning above. Use a nylon brush to remove any cleaning materials, water or dirt from the hotplate burner ports. Care should be taken when refitting the bodies over the electrodes.</p>
<p><b>Glass</b></p>	<p>As for enamel cleaning. Polish with a clean dry cloth or kitchen roll.</p>
<p><b>Chromium Plating</b> Oven shelves, grill pan grid, grill pan handle support.</p>	<p>Wipe with a cloth wrung out in warm soapy water. A fine steel wool soap pad e.g. Brillo, Ajax, or a chrome or stainless steel cleaner may be used.</p>
<p><b>Plastic</b> Grill pan handle, control knobs, door handle supports.</p>	<p>Wipe with a cloth wrung out in warm soapy water.</p>
<p><b>Stainless Steel (Professional)</b> Door trims, control panel, hotplate</p>	<p>Wipe with a cloth wrung out in warm soapy water. Polish with a clean dry cloth or kitchen towel. For stubborn stains, use a proprietary stainless steel cleaner and follow the instructions on the container.</p>
<p><b>Paint</b> Control panel and doors (Traditional), side panels</p>	<p>Wipe with a cloth wrung out in warm soapy water only. DO NOT USE ABRASIVES.</p>



# SOMETHING WRONG WITH YOUR COOKER

Before contacting your nearest Service Centre/Installer, check the problem guide below; there may be nothing wrong with your cooker.

PROBLEM	CHECK
<b>Slight odour or small amount of smoke when grill/oven used for first time.</b>	This is normal and should cease after a short period.
<b>Oven cooks too fast or too slow.</b>	Check that the oven setting and shelf positions are as recommended in the Cooking Charts. However, it may be necessary to increase or decrease the recommended setting slightly to suit your taste.
<b>Ignition does not work:</b>	<p><u>If all burners fail to ignite:</u> Check that sparks appear at the burners; a clicking noise should be heard. If not;</p> <p>(i) Check that the electricity supply is turned on. (ii) Check other appliances to see if you have had a power cut.</p> <p><u>If only one burner fails to ignite:</u> (i) Check the burner cap is seated correctly. (ii) Check the slots in the burner bodies are not blocked with any soap residue or cooking soil (see care and cleaning). (iii) Check, if the burners have recently been cleaned using a wire wool pad eg. "Brillo Pad", ensure that no stray strands are caught on the ignitor or burner body.</p> <p>NOTE. Satisfactory ignition will only be achieved if all the hotplate burners are fitted. In the event of an electricity failure, all burners can be lit with a match.</p>
Cannot set an "Auto Cook" programme or cannot get the timer to turn the oven on or off at the required times.	Read the Timer instructions in this book carefully remembering that the Cook period is the length of time that the timer will switch the oven(s) on as part of an Auto Cooking Programme.
Timer Display shows "0:00" with "AUTO" Flashing.	The electricity supply to the cooker may have been interrupted, but has now come back on again. Set the correct time of day by following the instructions given in the timer section of this book.
Fanned oven does not work, but the grill, top oven and hotplate burners work.	The Timer may be set for an Auto Cooking programme. Check the Timer to see if "AUTO" is illuminated. If it is, follow the instructions given in the Timer section of this book to cancel the Auto Cooking programme.
Oven lamp does not work.	The oven lamp is not covered by the guarantee. The part is easily changed (see the section on oven lamp replacement). A new lamp may be obtained from our Parts department, (see back page).

If there is still a problem contact your local Service office (see back page).

---

## Disposal of your product

To minimise the risk of injury to children please dispose of your product carefully and safely. Remove all doors and lids. Remove the mains cable (where fitted) by cutting off flush with the appliance and always ensure that no plug is left in a condition where it could be connected to the electricity supply.

To help the environment, Local Authority instructions should be followed for the disposal of your product.

## Disposal of old electrical appliances



The European Directive 2002/96/EC on Waste Electrical and Electronic Equipment (WEEE), requires that old household electrical appliances must not be disposed of in the normal unsorted municipal waste stream. Old appliances must be collected separately in order to optimise the recovery and recycling of the materials they contain and reduce the impact on human health and the environment.

The crossed out "wheeled bin" symbol on the product reminds you of your obligation, that when you dispose of the appliance it must be separately collected.

Consumers should contact their local authority or retailer for information concerning the correct disposal of their old appliance.

# INSTALLATION INSTRUCTIONS

Prior to installation, ensure that the local distribution conditions (nature of the gas and gas pressure) and the adjustment conditions are compatible. The adjustment conditions for this appliance are stated on the data badge which is fitted on the back panel.

This appliance is not designed to be connected to a combustion products evacuation device. It must be installed and connected in accordance with current installation regulations. Particular attention should be given to the relevant requirements regarding ventilation.

## **MODEL NUMBERS 10750G, 10755G, 10756G**

### **Category I2H (GB)**

This model is set to burn NATURAL GAS (G20) at 20 mbar.

## **GAS SAFETY (INSTALLATION & USE) REGULATIONS**

It is the law that all gas appliances are installed by competent persons in accordance with the current edition of the above regulations. It is in your interest and that of safety to ensure compliance with the law.

In the UK, CORGI registered installers work to safe standards of practice.

The cooker must also be installed in accordance with BS 6172.

Failure to install the cooker correctly could invalidate the warranty liability claims and could lead to prosecution.

## **LOCATION**

The cooker may be located in a kitchen, kitchen/diner or a bed-sitting room, but not in a room containing a bath or shower. The cooker must not be installed in a bed-sitting room of less than 20m<sup>3</sup>.

## **PROVISION FOR VENTILATION**

The room containing the cooker should have an air supply in accordance with BS 5440: Part 2.

The room must have an opening window or equivalent; some rooms may also require a permanent vent. If the room has a volume between 5 and 10m<sup>3</sup>, it will require an air vent of 50cm<sup>2</sup> effective area unless it has a door which opens directly to outside. If the room has a volume of less than 5m<sup>3</sup>, it will require an air vent of 100cm<sup>2</sup> effective area. If there are other fuel burning appliances in the same room, BS 5440: Part 2 should be consulted to determine air vent requirements.

# INSTALLATION INSTRUCTIONS

## TECHNICAL DATA

### DIMENSIONS

Height	900 - 915 mm
Width	1000 mm
Depth	600 mm (excluding door handles)

### GENERAL

Gas connection	Rp ½ (½" BSP female)
Pressure test point	Hotplate burner injector
Gas rate adjustment	None
Aeration adjustment	None
Electrical connection	Flexible cord fitted with a 13A plug 230-240V~ 50Hz. 3A fuse.

	230-240V~	Cat I2H G20 at 20 mbar	
BURNER	HEAT INPUT	HEAT INPUT	INJECTOR
HOTPLATE Front Left		1.90 kW	102 Z
HOTPLATE Rear Left		3.00 kW	116 Y
HOTPLATE Centre Front		4.10 kW	110 x 2
HOTPLATE Centre Front		1.00 kW	74
HOTPLATE Centre Rear		1.00 kW	71 X
HOTPLATE Front Right		1.50 kW	88 X
HOTPLATE Rear Right		1.50 kW	88 X
GRILL		3.90 kW	128 Y
LEFT OVEN		2.60 kW	123
RIGHT OVEN		2.60 kW	123
WARMING DRAWER	0.15 kW		

# INSTALLATION INSTRUCTIONS

## SPACE FOR FIXING

The cooker can be close fitted below hotplate level. This requires a minimum distance of 600mm between cupboard units of hotplate height.

When installing next to a tall cupboard, partition or wall, for a minimum distance of 400mm above hotplate level, allow a side clearance of at least 65mm.

The diagram below illustrates the minimum clearance between the cooker and adjacent walls, cupboards etc.

The wall behind the cooker between the hotplate and 450mm above, and the width of the cooker, must be a non-combustible material such as ceramic wall tiles.

If the cooker is to be fitted close to a corner on the left hand side, ensure that there is a clearance of at least 50mm to allow the main oven door to open fully for when removing oven shelves.

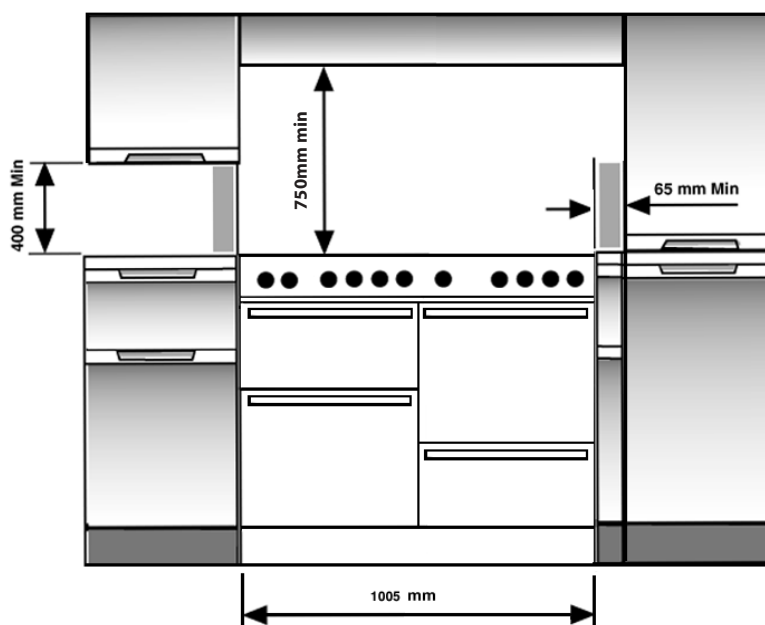

## COOKER HOODS

If a cooker hood is to be installed, refer to the cooker hood manufacturers' instructions regarding fixing height.

# INSTALLATION INSTRUCTIONS

## UNPACKING THE COOKER

Unpack the components from inside the grill and oven. Check that the following parts are present:

Meat pan	Pan supports
Grill pan, grid and handle	Griddle
Hotplate burner parts	Oven and Grill shelves
Wok Stand	Literature pack

After unpacking your cooker, make sure that you remove all the packing from the oven and grill, and any stickers from the oven door and the hob.

## LEVELLING

Your cooker is heavy, so it would be advisable for two people to move it. The cooker is fitted with rear wheels and will slide into position easily. Movement of your cooker is most easily achieved as follows. Open the grill/oven door sufficiently to allow a comfortable grip on the underside front edge of the oven roof, avoiding any grill or oven interior furniture, and then lift and slide back at the same time.

Your cooker must stand on a flat surface so that the hob is perfectly level, and the cooker is stable and cannot be rocked, this is easily achieved by adjusting the three feet which are under the front of the cooker and the 3 castors under the rear of the cooker, if necessary.

## STABILITY BRACKET

The cooker must be fitted with a stability device firmly secured to the fabric of the building.

The M6 bolt at the top of the rear of the cooker can be used to engage a stability chain. Keep the chain clear of controls and pipes on the rear of the cooker.

The chain must be fitted to the wall behind the cooker.

**NOTE:** If the cooker is to be placed on a base, precautions must be taken to prevent it from slipping off the base.

# INSTALLATION INSTRUCTIONS

The cooker is designed to match the depth of standard 600mm worktops. An adaptor backplate should, therefore, be fitted within the shaded area shown to allow the cooker to be pushed fully to the wall. If a forward facing backplate is used, it must be chased into the wall.

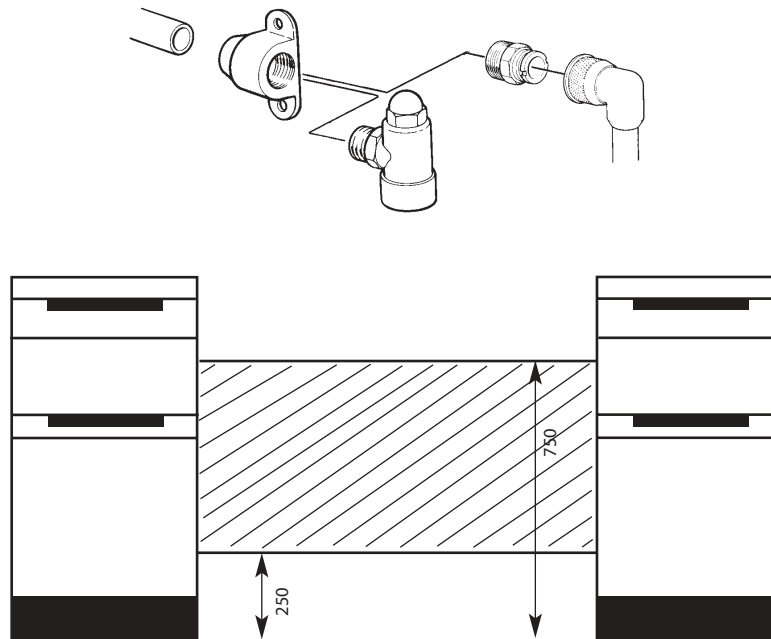

Connection to the cooker should be made with an approved appliance flexible connection to BS 669. A length of 0.9 to 1.25m is recommended. The length of hose chosen should be such that when the cooker is in situ, the hose does not touch the floor.

The temperature rise of areas at the rear of the cooker that are likely to come in contact with the flexible hose do not exceed 70°C.

# ELECTRICAL CONNECTION

**WARNING - THIS APPLIANCE MUST BE EARTHED. CONNECT TO A 230-240V A.C. SUPPLY ONLY.**

Connection to the electricity supply should be made via a properly earthed, readily accessible wall socket which is adjacent to but not directly above, and not more than 1.25m away from the appliance and capable of electrical isolation.

The mains lead should be routed such that it cannot touch hot parts of the cooker i.e. the back panel above a height of 650mm from the floor.

Should this plug not fit the socket outlet in your home it should be cut off and replaced with a suitable plug as outlined below.

**NOTE:** The removed plug cannot be used for any other appliance and should therefore be properly disposed of and not left where children might find it and plug it into a supply socket - with the obvious consequent danger.

## IF THE FITTED PLUG IS REMOVED

The flexible mains lead must be correctly connected as below to a three pin plug of not less than 13 amp capacity. If a B.S. 1363 fused plug is used, it must be fitted with a fuse which is approved to B.S. 1362.

**IMPORTANT:** The wires in the mains lead fitted to this appliance are coloured in accordance with the following code:

GREEN AND YELLOW - EARTH  
BLUE - NEUTRAL  
BROWN - LIVE

The power supply cable must be type H05RR-F

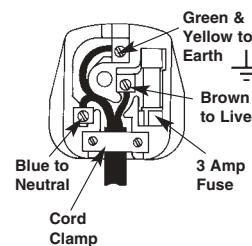

As the colours of the wires in the mains lead of this appliance may not correspond with the coloured markings identifying the terminals in your plug, proceed as follows:

The wire which is coloured green and yellow must be connected to the terminal in the plug which is marked with the letter E or by the earth symbol  $\equiv$  or coloured green or green and yellow.

The wire which is coloured blue must be connected to the terminal which is marked with the N or coloured black. The wire which is coloured brown must be connected to the terminal which is marked with the letter L or coloured red.

When wiring the plug, ensure that all strands of wire are securely retained in each terminal. Do not forget to tighten the mains lead clamp on the plug.

As the appliance must be earthed, **do not use 2-pin sockets outlets, if you are in doubt, consult a qualified electrician.**

Should the mains lead ever require replacement, it is essential that this operation be carried out by a qualified electrician and should only be replaced with a flexible cord of the same size i.e. 1.0mm<sup>2</sup> cross sectional area PVC cable, available from our parts department (see Back Cover).

## IF A MOULDED PLUG IS FITTED

In the event of replacing a fuse in the plug supplied an ASTA approved fuse to BS1362 must be fitted.

**NOTE:** The fuse cover must be refitted when changing the fuse. In the event of losing the fuse cover the plug must not be used until a replacement fuse cover has been obtained and fitted. A new fuse cover can be obtained from your local Electricity Board. The colour of the correct replacement fuse cover is that of the coloured marks or inserts in the base of the plug.

Make sure that the cable does not become trapped when pushing the cooker into position.



# INSTALLATION INSTRUCTIONS

## INSTALLATION & OPERATIONAL CHECKS

After installation, check for gas soundness.

Fit the hotplate burner parts and pan supports.

1. Check that the hotplate burners ignite correctly and burn with a steady flame.  
Check for a steady flame on the low setting.
2. Check that the grill burner ignites correctly and burns with a steady flame.  
Check for a steady flame on the low setting.
3. For both ovens, check that with the main oven set to Mark 9, the burner ignites at low rate and then increase to full rate within 60 seconds. Leave the oven on full, with the door closed for 10 minutes. Then check that when the control is turned to the 'Slow Cook' setting that the flame reduces. Allow the oven to cool.
4. Check that the warming drawer heats up.
5. Check that the operation of the clock and oven lights.
6. Check that the cooling fan comes on when the grill or left hand oven are on.

Instruct the user on the operation of the cooker.





## Guarantee

### 12 months Parts and Labour Guarantee

Your appliance has the benefit of our manufacturer's guarantee, which covers the cost of breakdown repairs for twelve months from the date of purchase.

This gives you the reassurance that if, within that time, your appliance is proven to be defective because of either workmanship or materials, we will, at our discretion, either repair or replace the appliance at no cost to you.

#### The guarantee is subject to the following conditions:

- The appliance has been installed and operated correctly and in accordance with our operating and maintenance instructions.
- The appliance is only used on the electricity or gas supply printed on the rating plate.
- The appliance has been used for normal domestic purposes only.
- The appliance has not been altered, serviced, maintained, dismantled or otherwise interfered with by any person not authorised by us.
- Any repair work must be undertaken by us or our appointed agent.
- Any parts removed during repair work or any appliance that is replaced become our property.
- The appliance is used in the United Kingdom or Republic of Ireland.

#### The guarantee does not cover:

- Damage resulting from transportation, improper use, neglect or interference or as a result of improper installation.
- Replacement of any consumable item or accessory. These include but are not limited to: plugs, cables, batteries, light bulbs, fluorescent tubes and starters, covers and filters.
- Replacement of any removable parts made of glass or plastic.

THE GUARANTEE WILL NOT APPLY IF THE APPLIANCE HAS BEEN USED IN COMMERCIAL OR NON-DOMESTIC PREMISES.

### 5 Year Parts Guarantee

Cannon also offers you a FREE 5 year parts guarantee. This additional guarantee is conditional on you registering your appliance with us and the parts being fitted by one of our authorised engineers. There will be a charge for our engineer's time. To activate the extra parts warranty on your appliance, simply call our registration line on **08448 24 24 24 (ROI 01 230 0800)**

### Extended Guarantees

We offer a selection of protection plans that enable you to fully cover yourself against the expense of repair bills for the life of your policy. To find the ideal plan for you please call our advice line on **08448 226 226 (ROI 01 230 0233)**.

### Free Helpdesk Service

We have a dedicated team who can provide free advice and assistance with your appliance if you experience any technical difficulties within the first 90 days of ownership. Simply call our Cannon Service Hotline on **08448 224 224 (ROI 0818 313 413)** for telephone assistance, or, where necessary, to arrange for an engineer to call.



## After Sales Service

No one is better placed to care for your Cannon appliance during the course of its working life than us - the manufacturer.

### Essential Contact Information

#### Cannon Service

We are the largest service team in the country offering you access to 400 skilled telephone advisors and 1000 fully qualified engineers on call to ensure you receive fast, reliable, local service.

**UK: 08448 224 224**

**Republic of Ireland: 0818 313 413**

**[www.cannonservice.co.uk](http://www.cannonservice.co.uk)**

**Please note: Our advisors will require the following information:**

Model number

Serial number

#### Parts & Accessories

We supply a full range of genuine replacement parts as well as accessory products that protect and hygienically clean your appliance to keep it looking good and functioning efficiently throughout its life.

**UK: 08448 225 225**

**Republic of Ireland: 0818 313 413**

**[www.cannonservice.co.uk](http://www.cannonservice.co.uk)**

#### Appliance Registration

We want to give you additional benefits of Cannon ownership. To activate your FREE 5 year parts guarantee you must register your appliance with us.

**UK: 08448 24 24 24**

**Republic of Ireland: 01 230 0800**

**[www.cannonservice.co.uk](http://www.cannonservice.co.uk)**

**Indesit** Company UK Limited, Morley Way, Peterborough, PE2 9JB

**Indesit** Company, Unit 49 Airways Industrial Estate, Dublin 17

#### Recycling and Disposal Information

As part of Cannon's continued commitment to helping the environment, Cannon reserves the right to use quality, recycled components to keep down customer costs and minimise material wastage.

Please dispose of packaging and old appliances carefully. To minimise the risk of injury to children, remove the door, plug, and cut the mains cable off flush with the appliance. Dispose of these parts separately to ensure that the appliance can no longer be plugged into mains socket, and the door cannot be locked shut.

03/2009 Part no. 195053234.05

## Free Manuals Download Website

<http://myh66.com>

<http://usermanuals.us>

<http://www.somanuals.com>

<http://www.4manuals.cc>

<http://www.manual-lib.com>

<http://www.404manual.com>

<http://www.luxmanual.com>

<http://aubethermostatmanual.com>

Golf course search by state

<http://golfingnear.com>

Email search by domain

<http://emailbydomain.com>

Auto manuals search

<http://auto.somanuals.com>

TV manuals search

<http://tv.somanuals.com>