

Canon

FAX-B180C/B160

User's Guide

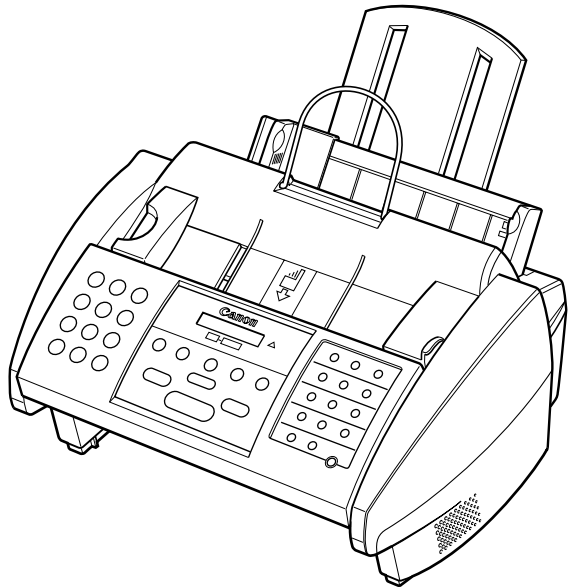

ENGLISH

Table of Contents

INTRODUCTION

Using this guide.....	vii
Customer support	vii
Important safety instructions	viii
Handling and maintenance	viii
Location	ix
Power supply	ix

1. SETTING UP

Unpacking	1-2
Removing the shipping materials	1-3
Assembling the fax.....	1-4
Attaching components	1-4
Making connections	1-5
Connecting the optional handset, telephone line and external devices	1-5
Connecting the AC power cord.....	1-7
Installing the BJ cartridge	1-8
Guidelines.....	1-8
Installing the BJ cartridge in your fax.....	1-9
Loading paper	1-11
Selecting the right kind of paper	1-11
Paper guidelines	1-11
Loading paper in the multi-purpose tray	1-12
Setting the TEL LINE TYPE.....	1-13
Dialling through a switchboard (PBX).....	1-14
Registering the access type and the outside line access number	1-14
Testing the fax	1-16

2. PREPARING TO USE YOUR FAX

Main components of your fax.....	2-2
Fax controls the operation panel	2-3
Guidelines for entering numbers, letters, and symbols.....	2-5
Correcting mistakes	2-7
Registering sender information	2-8
Personalising your fax	2-8
Setting the date and time.....	2-9
Registering your fax/telephone number and name.....	2-10
Registering one-touch speed dialling numbers and names	2-12
Registering coded speed dialling numbers and names	2-14
Registering group dialling numbers and names	2-15
Automatic dialling	2-18
Sending a document using one-touch speed dialling, coded speed dialling or group dialling numbers	2-18
Special dialling	2-19

Table of Contents

3. HANDLING DOCUMENTS

Preparing documents	3-2
Types of documents you can scan	3-2
Problem documents.....	3-2
Loading documents	3-3
Problems with multipage documents	3-4
Adding pages to the document.....	3-4

4. HANDLING PAPER

Paper requirements	4-2
Printable area	4-2
Loading paper.....	4-2

5. MAKING COPIES

Copying documents	5-2
--------------------------------	------------

6. SENDING DOCUMENTS

Preparing to send a document	6-2
Adjusting the quality of your documents	6-2
Sending methods.....	6-3
Dialling methods	6-4
Sending documents	6-5
Memory sending	6-5
Manual sending	6-6
Messages displayed during sending	6-7
Cancelling sending	6-8
Redialling when the line is busy	6-9
Manual redialling	6-9
Automatic redialling	6-9
Sequential broadcasting	6-12
Sending a document to more than one location	6-12
Documents stored in memory	6-13
Printing a list of documents in memory	6-13
Printing a document in memory	6-13
Deleting a document from memory	6-14
Delayed sending	6-15
Sending other documents while the fax is set for delayed sending.....	6-16
Cancelling delayed sending.....	6-16

Table of Contents

7. RECEIVING DOCUMENTS

Different ways to receive a document	7-2
Receiving documents automatically: FAX ONLY MODE	7-3
Receiving both documents and telephone calls automatically:	
Fax/Tel mode	7-3
Receiving documents manually: MANUAL MODE	7-7
Receiving documents with an answering machine:	
ANS.MACHINE MODE	7-9
Other features	7-10
Receiving documents while performing other tasks	7-10
Receiving documents in memory when a problem occurs ...	7-10
Polling to receive documents	7-11
Cancelling receiving	7-12
Receiving restriction	7-13

8. SETTINGS AND ACTIVITY REPORTS

Selecting a menu	8-2
Activity reports	8-7
How to print a report	8-7
Activity report	8-8
One-touch speed dialling list	8-9
Coded speed dialling list	8-9
Group dialling list	8-9
User's data list	8-10
Doc. memory list	8-10
TX (Transmission) report	8-11
RX (Reception) report	8-12
Multi TX/RX (Transaction) report	8-12
Restricting use of the fax	8-13
Locking the fax	8-13
Changing the access password	8-14
Cancelling the restriction setting	8-15

Table of Contents

9. SOLUTIONS TO COMMON PROBLEMS

Clearing jams	9-2
Jams in the Automatic Document Feeder (ADF)	9-2
Jams in the multi-purpose tray	9-3
Periodic cleaning	9-4
Cleaning the exterior of the fax	9-4
Cleaning the interior of the fax	9-4
Testing and cleaning the BJ cartridge print head	9-7
Replacing the BJ cartridge	9-8
Troubleshooting	9-11
Paper feeding problems	9-11
Faxing problems	9-12
Copying problems	9-16
Telephone problems	9-16
Print quality problems	9-17
General problems	9-17
LCD messages	9-18
In case of a power failure	9-23
During a power failure	9-23
Memory clear report	9-23

APPENDIX: OPTIONS

Optional handset	A-2
Package contents	A-2
Attaching the handset to your fax	A-3
Maintaining your handset	A-4

Specifications	S-1
-----------------------------	------------

Index	I-1
--------------------	------------



This equipment (H12240/H12241) conforms with the essential requirements of EC Directive 1999/5/EC.

We declare that this product conforms with the EMC requirements of EC Directive 1999/5/EC at nominal mains input 230V, 50Hz although the rated input of the product is 200V-240V, 50/60Hz.

If you move to another EU country and are experiencing trouble please call the Canon Help Desk.

(For Europe Only)

Copyright

Copyright © 2002 by Canon, Inc. All rights reserved. No part of this publication may be reproduced, transmitted, transcribed, stored in a retrieval system, or translated into any language or computer language in any form or by any means, electronic, mechanical, magnetic, optical, chemical, manual, or otherwise, without the prior written permission of Canon, Inc.

Trademarks

Canon and BJ are registered trademarks. UHQ is a trademark of Canon Inc.

All other product and brand names are registered trademarks, trademarks or service marks of their respective owners.



As an ENERGY STAR® Partner, Canon has determined that these products meet the ENERGY STAR® guidelines for energy efficiency

Using this guide

This guide provides detailed information on how to set up, operate, maintain, and troubleshoot your fax. Please read the list below to become familiar with the symbols, terms, and abbreviations used in this guide.



Cautions tell you how to avoid actions that could injure you or damage your fax. In order to use your fax safely, always observe these cautions.



Notes provide advice on using your fax more effectively, describe operating restrictions, and tell you how to avoid minor difficulties. Reading these is recommended to make the most of your fax and its functions.

(see p. xx)	Indicates a page number that you can refer to for more information on the topic of the previous sentence or paragraph.	
default	A setting that remains in effect unless you change it.	
document	The original sheet(s) of paper you send or receive with your fax.	
menu	A list of settings from which you select an item to set up or change. A menu has a title which appears on the LCD	
Λ and ∨ buttons	Used to select an item in a menu. Press ∨ to select the next item, and press Λ to select the previous item.	
transaction number	When you send or receive a document, your fax automatically assigns the document a unique transaction number. A transaction number is a four-digit number that will help you keep track of documents you send and receive.	
TX/RX NO.	TX/RX NO. is the abbreviation used for “transaction number.”	
TX	TX Denotes Transmission.	
RX	Denotes Reception.	
<table border="1"><tr><td>TRANSMITTING OK</td></tr></table>	TRANSMITTING OK	LCD display. The contents of the LCD display may vary depending on the current settings.
TRANSMITTING OK		

In addition, this guide uses brackets to identify the buttons you press when performing different functions: [Stop]



This guide contains information for two Canon models. Please note that the illustrations of the fax in this guide may differ from your model. Instructions for specific models are labelled with the fax names.

Customer support

Your fax is designed with the latest technology to provide trouble-free operation. If you encounter a problem with the fax's operation, try to solve it by using the information in Chapter 9. If you cannot solve the problem or if you think your fax needs servicing, contact your local authorised Canon dealer or the Canon Help Desk.

Important safety instructions

Read these safety instructions thoroughly before using your fax.



Caution

Except as specifically described in this guide, do not attempt to service the fax yourself. Never attempt to disassemble the fax: opening and removing its interior covers will expose you to dangerous voltages and other risks. For all service, contact your local authorised Canon dealer or the Canon Help Desk.

■ Handling and maintenance

- Follow all warnings and instructions marked on the fax.
- Do not subject the fax to strong physical shock or vibration.
- Always unplug the fax before moving or cleaning it.
- To avoid paper jams, never unplug the power cord, open the printer cover, or remove paper from the multi-purpose tray while printing.
- When transporting the fax, be sure to remove the BJ cartridge.
- Always lift the fax as shown below. Never lift it by any of its attachments.

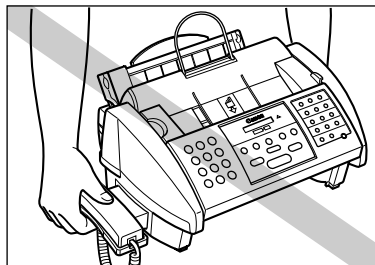
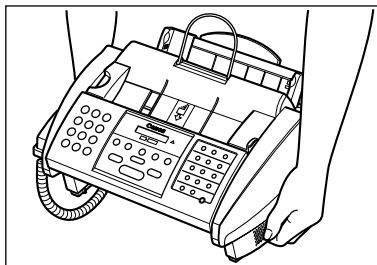

- Do not push objects of any kind into the slots or openings on the cabinet as they may touch dangerous voltage points or short out parts. This could result in fire or electric shock.
- Do not allow small objects (such as pins, paper clips, or staples) to fall into the fax. If something does fall into the fax, unplug it immediately and contact your local authorised Canon dealer or the Canon Help Desk.
- To avoid spillage in or around the fax, do not eat or drink near it. If you spill liquid or if any substance falls into the fax, unplug the fax immediately and contact your local authorised Canon dealer or the Canon Help Desk.
- Keep the fax clean. Dust accumulation can prevent the fax from operating properly.
- Unplug the fax from the wall outlet and refer service to qualified personnel under the following conditions:
 - When the power cord or plug is damaged or frayed.
 - If liquid has spilled into the fax.
 - If the fax has been exposed to rain or water.
 - If the fax does not operate normally when you have followed the instructions in this guide. Adjust only those controls that are covered by the instructions in this guide. Improper adjustment of other controls may result in damage and may require extensive work by a qualified technician to restore the product to normal operation.
 - If the fax has been dropped or the cabinet has been damaged.
 - If the fax exhibits a distinct change in performance, indicating a need for servicing.

■ Location

- Place the fax on a flat, stable, vibration-free surface that is strong enough to support its weight (approx. 5.1 kg).
- Place the fax in a cool, dry, clean, well ventilated place.
 - Make sure the area is free from dust.
 - Make sure the location is not affected by extreme temperature changes, and always stays between 10° and 32.5°C.
 - Make sure the area's relative humidity is always between 20% and 85%.
- Keep the fax away from direct sunlight as this can damage it. If you have to place it near a window, install heavy curtains or blinds.
- Do not use the fax near water. Make sure that no wet or humid objects come into contact with the fax.
- Do not use or store the fax outdoors.
- Do not install the fax near devices that contain magnets or generate magnetic fields, such as speakers.
- If possible, place the fax near an existing telephone outlet to avoid the expense of installing a new one.
- Place the fax near a standard 200-240 V AC power outlet.
- To ensure reliable operation of the fax and to protect it from overheating (which can cause it to operate abnormally and create a fire risk), do not block the exhaust vent and never block or cover any openings on the fax by placing it on a bed, sofa, rug, or other similar surface. Do not place the fax in a cupboard or built-in installation, or near a radiator or other heat source unless proper ventilation is provided. Install the fax approximately 10 cm away from walls and other equipment. For the dimensions of the fax, see p. S-1.
- Do not place the fax on the edge of a desk so as to prevent received documents from falling onto the floor.
- Do not stack boxes or furniture around the power outlet. Keep the area free so you can reach the outlet quickly. If you notice anything unusual (smoke, strange odours, noises) around the fax, unplug it immediately. Contact your local authorised Canon dealer or the Canon Help Desk.
- Do not allow anything to rest on the power cord, and do not place the fax where the cord will be walked on. Make sure the cord is not knotted or kinked.

■ Power supply

- During electrical storms, disconnect the power cord from the power outlet. (Please note that any documents stored in the fax's memory will be deleted when you unplug the fax.)
- Whenever you unplug the fax, wait at least five seconds before you plug it in again.
- If dust accumulates around the plug of the power cord when it is connected to a power outlet, unplug the fax and wipe the plug with a clean, dry cloth.



This product emits low level magnetic flux. If you use a cardiac pacemaker and feel abnormalities, please move away from this product and consult your doctor.

Caution



1

SETTING UP

Unpacking	1-2
Removing the shipping materials	1-3
Assembling the fax.....	1-4
Attaching components	1-4
Making connections	1-5
Connecting the optional handset, telephone line and external devices	1-5
Connecting the AC power cord.....	1-7
Installing the BJ cartridge	1-8
Guidelines.....	1-8
Installing the BJ cartridge in your fax.....	1-9
Loading paper.....	1-11
Selecting the right kind of paper	1-11
Paper guidelines.....	1-11
Loading paper in the multi-purpose tray	1-12
Setting the TEL LINE TYPE.....	1-13
Dialling through a switchboard (PBX).....	1-14
Registering the access type and the outside line access number.....	1-14
Testing the fax	1-16

Unpacking

As you unpack your fax, save the carton and packing material in case you want to move or ship the fax in the future.

Carefully remove all items from the box.

- It is best to have someone hold the box while you lift the fax and its protective packaging out of the carton.

Make sure you have the following items:

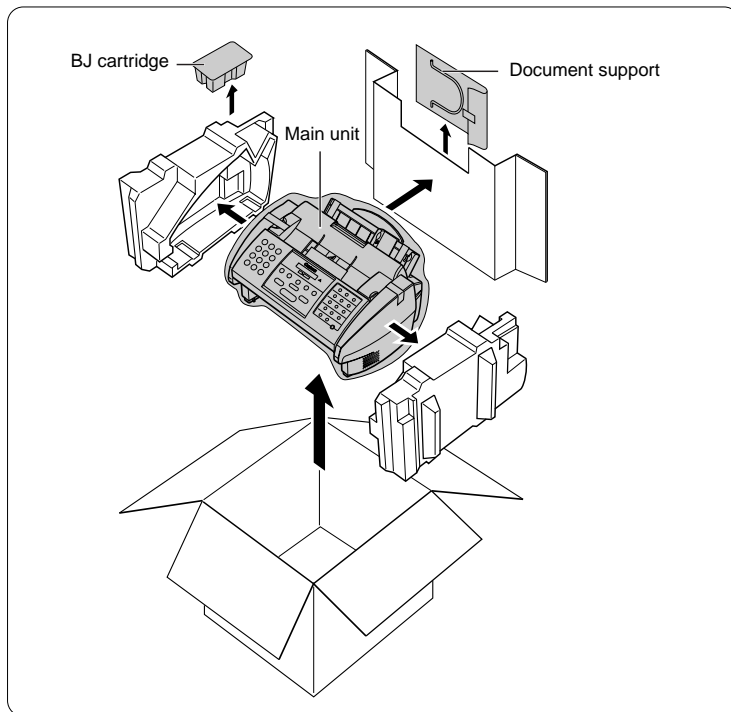

You should also have the following:

- Power cord
- Telephone line
- Documentation
- Warranty*

If any of these items are damaged or missing, notify your Canon dealer immediately.



Note

The actual shipping materials may differ in shape, quantity, and position from the ones shown above.

* This item is only included in some countries.

Removing the shipping materials

Remove the shipping materials as shown below.

- 1 Remove the shipping tapes from the top of the fax.
- 2 Remove the protective piece from the multi-purpose tray.

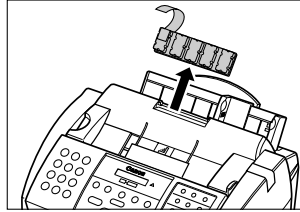
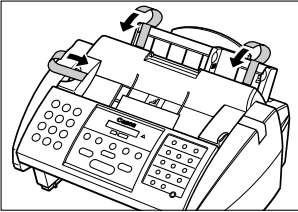

- 3 Open the operation panel partially by gently pulling it towards you (it only opens slightly).
- 4 Remove the protective sheet from the Automatic Document Feeder (ADF). Close the operation panel by pressing it down from the centre until it locks into place.

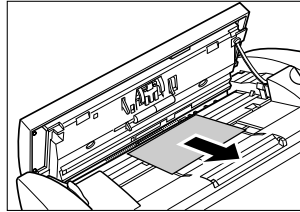
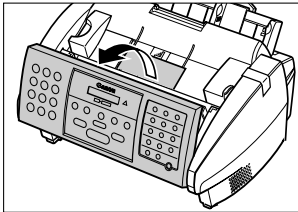

- 5 Open the printer cover using the printer cover tab. (see p. 2-2)
- 6 Remove the shipping tape from the side of the fax. Close the printer cover.

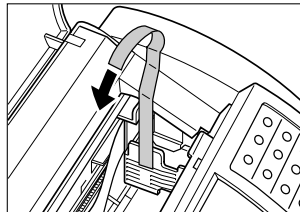
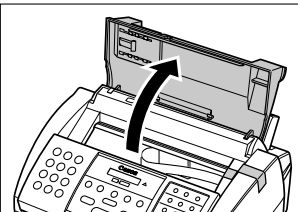

Note

The actual shipping materials may differ in shape, quantity, and position from the ones shown above.

Assembling the fax

To see how the fax looks fully assembled, see Main components of your fax, p. 2-2.

Attaching components

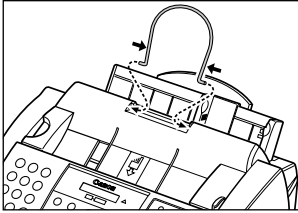

- 1** Hold the document support upright and fit the tabs of the support into the slots above the ADF.

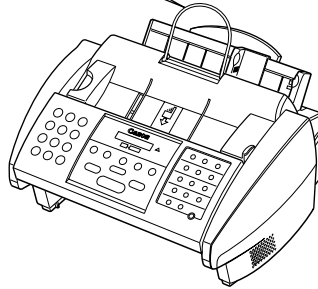

For details on attaching the optional handset to the fax, see the Appendix.

Making connections

Connecting the optional handset, telephone line and external devices

There are three jacks on the rear of the fax for connection of the following:

- Telephone line
- Optional handset or Telephone
- Extension phone (i.e. an additional telephone that you may wish to place away from the fax to answer calls from a different location) or answering machine.

If you only have one telephone line and plan to use the fax for receiving both fax and voice calls, you will need to connect the optional handset or an answering machine to the fax.

Be sure to connect any external devices before using the fax.

Follow the procedure below to connect the telephone line and external devices.

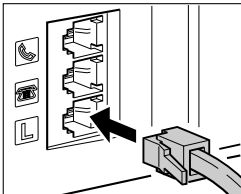
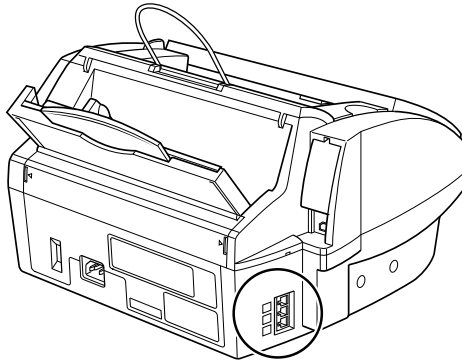

1 Connect the supplied telephone line to the ☎ jack, then connect the other end of the line to the telephone jack on your wall.

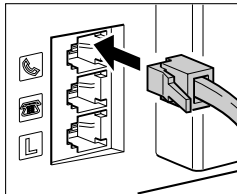

2 Connect the line from the optional handset or telephone to the ☎ jack.

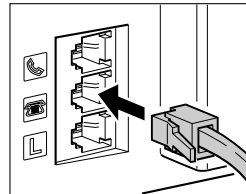

3 Connect the line from the extension phone or answering machine to the ☎ jack.



- Due to the range of specifications, Canon cannot guarantee that all answering machines will be compatible with your fax.
- If you have connected an external device to your fax, be sure to select the correct receive mode. (see Chapter 7)
- To connect an extension phone as well as an answering machine, connect the extension phone to the answering machine, and then connect the answering machine to your fax.
- If the extension phone does not have its own power supply, any redial data in the extension phone memory may be lost after an extended fax transmission.

Connecting the AC power cord

Plug the fax into a 200-240 volt AC 50/60 Hz outlet.

- 1 Plug the power cord connector into the rear of the fax.
- 2 Plug the other end of the power cord into a properly grounded AC power outlet.

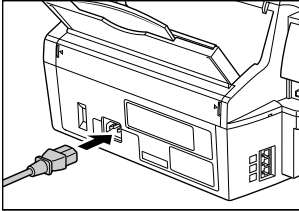

Note There is no power switch on the fax. The power is on as long as the fax is plugged in.

When you plug in the fax for the first time, you need to select the correct language for the LCD display and reports, and the country* of use.

■ Setting the language and country

- 1 Plug in the fax.

After a few seconds, the LCD changes to this display.

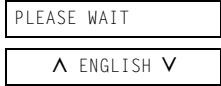

- 2 Use [▲] or [▼] to select the preferred language for the LCD display and reports.

Press [Set].

Wait a second for COUNTRY SELECT* to appear.

Press [Set].



Set



Set



1 sec.

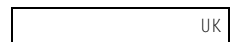

- 3 Use [▲] or [▼] to select the country where you are using the fax*.

Press [Set].

Registration ends and the fax enters standby mode.



Set

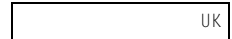

* This setting is only available for some countries.

Installing the BJ cartridge

The first time you set up your fax, you have to install the BJ cartridge before you can begin receiving and copying documents.

For information on replacing the BJ cartridge, see p. 9-8.

Guidelines

Follow these guidelines to ensure optimum performance of your BJ cartridge.

- Use only a Canon BX-20 Black BJ* cartridge in your fax.
- Store BJ cartridges at room temperature.
- Keep BJ cartridges in their packaging until you are ready to use them. This is to prevent the BJ cartridge from drying out.
- Replace BJ cartridges after one year of use.
- Never remove the BJ cartridge unless you are going to replace it. When left exposed, the cartridge print head dries out, making it unusable.
- To change a BJ cartridge, be sure to press [Cartridge] to move the cartridge holder to the centre.
- Make sure the cartridge holder is in its home position (on the right side of the fax) when you are not using the fax. If it is not in its home position, press [Cartridge]. Leaving the cartridge holder out of its home position will cause the BJ cartridge to remain uncapped and dry out.



Caution

- **Store BJ cartridges out of the reach of children. If a child inadvertently ingests ink, consult a physician immediately.**
- **Do not touch the precision components on the BJ cartridge.**

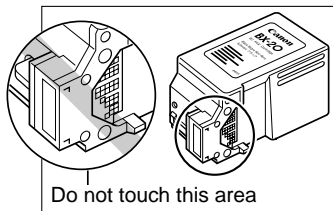

The ink in the BJ cartridge is difficult to clean up if spilled. Follow the precautions below when handling the BJ cartridge.

- Carefully remove packaging from BJ cartridges.
- Do not attempt to disassemble or refill BJ cartridges.
- Do not shake or drop BJ cartridges or tip the print head downwards.

* FAX-B180C will also accept Canon BC-21e Colour BJ cartridge. However, only black and white output is possible even with this cartridge. Colour output is only possible when the machine is used as a printer.

Installing the BJ cartridge in your fax _____

When there is no BJ cartridge installed in your fax, PUT IN CARTRIDGE is displayed on the LCD. Follow the procedure below to install the BJ cartridge.

1 Make sure the fax is plugged in.

2 Open the printer cover using the printer cover tab. (see p. 2-2)

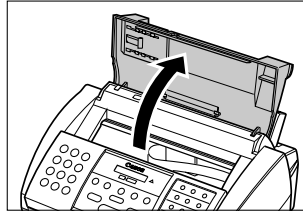

Note

When you plug in the fax for the first time, the cartridge holder automatically moves to the centre of the fax so you can install the BJ cartridge. If this does not happen, press [Cartridge].

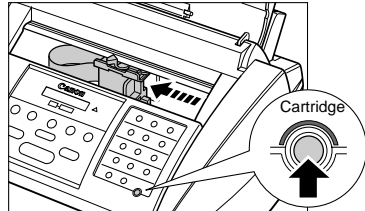

3 Raise the blue cartridge lock lever on the cartridge holder.

Remove the BJ cartridge from its package, then remove the orange protective cap ① and tape ②.

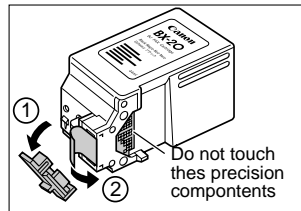
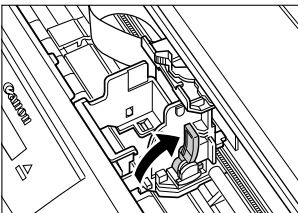

- Discard the cap and tape. Never attempt to reattach them to the BJ cartridge print head.
- Install the BJ cartridge immediately after removing the cap and tape.

- 5** With the label facing outwards, insert the BJ cartridge into the cartridge holder. Lower the blue cartridge lock lever until it locks into position.

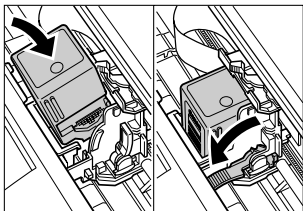

- 6** Press [Cartridge].

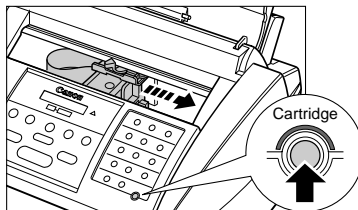

The cartridge holder moves to its home position on the right side of the fax and begins cleaning the BJ cartridge print head. This process takes about 40 seconds.

- 7** Close the printer cover.



Caution

- Do not try to manually move or stop the cartridge holder since this may damage the fax.
- Do not touch the components shown or any metal parts since this may adversely affect operation of the fax and/or affect print quality.

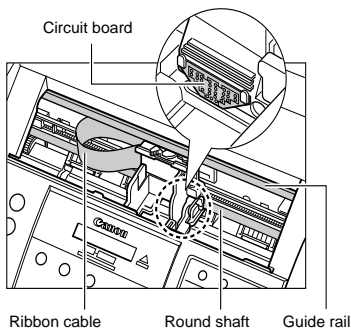

Note

If you need to unplug the fax, wait until it is in standby mode (time and receive mode displayed on the LCD). Otherwise the cartridge holder may not be in its home position; causing the BJ cartridge to remain uncapped and dry out.

Loading paper

Selecting the right kind of paper

The quality of the paper you use affects the print quality of the fax. Using paper that meets the following guidelines will ensure the best possible printing results.

Paper guidelines

- Be sure to load paper of the correct size, weight, and quantity recommended for your fax. (see p. 4-2)
- Store all paper wrapped and on a flat surface until ready to use. Keep opened packs in their original packaging, in a cool, dry location.
- Store paper at 18°-24°C, 40%-60% relative humidity.
- To avoid paper jams and poor print quality, do not print on damp, curled, wrinkled, or torn paper.
- Use cut-sheet paper only, not paper that comes on a roll.
- Use only paper that has a thickness of between 0.08 and 0.13 mm. Thick paper may damage the BJ cartridge print head.
- Do not load paper beyond the paper limit mark (▶) or beyond the tab on the multi-purpose tray. Doing so may cause problems. Also, make sure there are no gaps on either side of the paper stack.

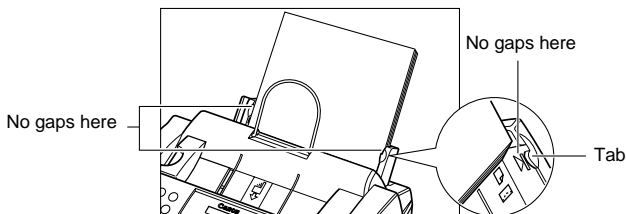



- Let the paper run out before refilling the multi-purpose tray. Avoid mixing new stock with paper already loaded.
- Do not leave paper stacked in the multi-purpose tray for long periods of time since it may bend or curl and cause problems.
- Certain environmental conditions, such as extreme temperatures or humidity, can cause some paper to misfeed in the multi-purpose tray. If you have trouble, feed one sheet at a time.
- Depending on the density of the printed pages, the ink may need time to dry. Within two or three seconds, the ink becomes smudge resistant. After drying for several minutes, the ink becomes water-resistant.
- If your printed page contains a large amount of graphics, the ink on the page may be damp due to the print density. Leave the page for 30 to 60 seconds to allow the ink to dry. Then remove the page carefully without touching any surfaces.
- If paper curls after printing, remove it immediately; otherwise paper jams may occur.
- The platen (a roller inside the fax) may become inked if you print data beyond the width of the page. If this happens, clean inside the fax. (see p. 9-4)

Loading paper in the multi-purpose tray

Follow the procedure below to load paper in the multi-purpose tray.

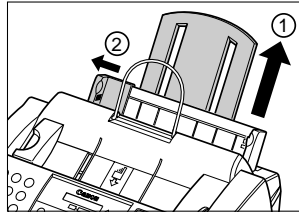
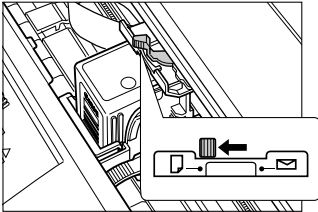
- 1** Open the printer cover using the printer cover tab. (see p. 2-2)
- 2** Press [Cartridge].
- 3** Make sure the paper thickness lever is set to  (left).
- 4** Raise the paper rest until it stops **①**, then move the paper guide to the left to match the size of your paper **②**.



- Do not set the paper thickness lever while the fax is printing since this will cause problems.
- The paper thickness lever should always be set to  (left) for the best printing results.

- 5** Fan the stack of paper that you want to feed into the fax. Then tap the edge of the stack on a flat surface to even the stack.
- 6** Insert the stack into the multi-purpose tray **①**, and align the right edge of the stack with the right side of the multi-purpose tray. Then slide the paper guide snugly against the left edge of the stack **②**.

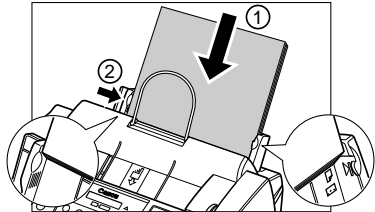
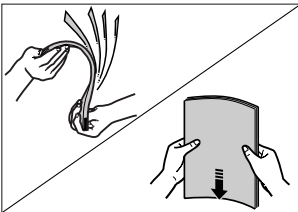









- The multi-purpose tray holds up to 100 sheets of 75 g/m² plain paper.
- Make sure the stack does not exceed the paper limit mark (▶).

Setting the TEL LINE TYPE

Before using your fax, you need to make sure it is set for your telephone line type. If you are unsure of your telephone line type, check with your local telephone company.

Follow the procedure below if you need to change the telephone line type setting.

- | | |
|--|--|
| <p>1 Press [Function].
Press [Data Registration].</p> | <p>Function
 
 Data Registration
  DATA REGISTRATION</p> |
| <p>2 Press [Set] twice.</p> | <p>Set
 
 USER SETTINGS
 DATE & TIME</p> |
| <p>3 Use [^] or [v] to select TEL LINE TYPE.
Press [Set].</p> | <p>TEL LINE TYPE
 
 Set
  ROTARY PULSE</p> |
| <p>4 Use [^] or [v] to select TOUCH TONE.
Press [Set].</p> | <p>TOUCH TONE
 
 Set
  R-KEY SETTING</p> |
| <p>5 Press [Stop].
Registration ends and the fax returns to standby mode.</p> | <p>Stop
 </p> |

Dialling through a switchboard (PBX)













A PBX (private branch exchange) is an on-site telephone switchboard.

- If your fax is connected through a switchboard, dial an outside line access number first. Then dial the rest of the number.
- If you want to dial with automatic dialling, you may have to insert a pause between the outside line access number and the telephone number when you register the number for one-touch or coded speed dialling. To enter a pause, press [Redial/Pause].
- When you have to make calls to an outside line or an extension, you may have to press the [R] button. Before you can use the [R] button, you need to register the access type and outside line access number under it. (see below)



Registering the access type and the outside line access number

When the fax is connected to a PBX or other telephone switching system, you can register the access type and outside line access number under the [R] button. Once you have registered them, you simply need to press [R] before dialling a fax or telephone number.

Follow the procedure below to register the access type and outside line access number under the [R] button.

1	Press [Function]. ▼ Press [Data Registration].	Function  ▼ Data registration 	<table border="1" style="margin-left: auto; margin-right: auto;"><tr><td style="padding: 5px;">DATA REGISTRATION</td></tr></table>	DATA REGISTRATION							
DATA REGISTRATION											
2	Press [Set] twice.	Set 	<table border="1" style="margin-left: auto; margin-right: auto;"><tr><td style="padding: 5px;">USER SETTINGS</td></tr><tr><td style="padding: 5px;">DATE & TIME</td></tr></table>	USER SETTINGS	DATE & TIME						
USER SETTINGS											
DATE & TIME											
3	Use [^] or [V] to select R-KEY SETTING. ▼ Press [Set].	<table border="0" style="margin-left: auto; margin-right: auto;"><tr><td style="text-align: center;"></td><td style="text-align: center;"></td></tr><tr><td colspan="2" style="text-align: center;">▼</td></tr><tr><td colspan="2" style="text-align: center;">Set </td></tr></table>			▼		Set 		<table border="1" style="margin-left: auto; margin-right: auto;"><tr><td style="padding: 5px;">R-KEY SETTING</td></tr><tr><td style="padding: 5px;">PSTN</td></tr></table>	R-KEY SETTING	PSTN
											
▼											
Set 											
R-KEY SETTING											
PSTN											

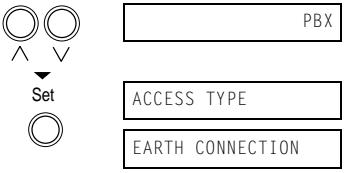
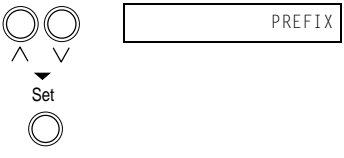
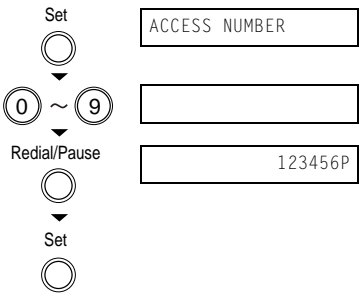
Dialling through a switchboard (PBX)

- | | |
|--|--|
| <p>4 Use [^] or [v] to select PBX.
Press [Set] twice.</p> |  |
| <p>5 Use [^] or [v] to select the access line type for the switching system.
Press [Set].</p> |  |
| <p>6 If you chose PREFIX in step 5:
Press [Set].
Enter the outside line access number (up to 19 digits) using the numeric buttons and then press [Redial/Pause].
Press [Set].</p> |  |
| <p>7 Press [Stop]
Registration ends and the fax returns to standby mode.</p> |  |

Testing the fax

After you have assembled the fax, installed the BJ cartridge, and loaded the paper, you can make sure the fax is printing properly by making several copies of a document. (see p. 5-2)

If you have problems printing, see Chapter 9.

2

PREPARING TO USE YOUR FAX

Main components of your fax.....	2-2
Fax controls — the operation panel	2-3
Guidelines for entering numbers, letters, and symbols.....	2-5
Correcting mistakes	2-7
Registering sender information	2-8
Personalising your fax	2-8
Setting the date and time.....	2-9
Registering your fax/telephone number and name.....	2-10
Registering one-touch speed dialling numbers and names	2-12
Registering coded speed dialling numbers and names	2-14
Registering group dialling numbers and names	2-15
Automatic dialling	2-18
Sending a document using one-touch speed dialling, coded speed dialling or group dialling numbers.....	2-18
Special dialling	2-19

Main components of your fax

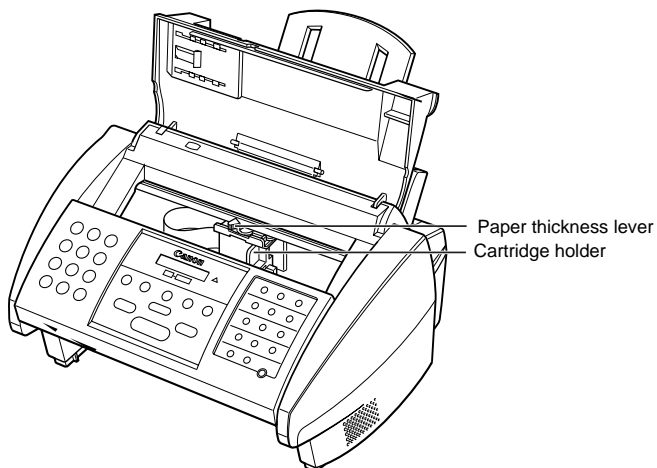
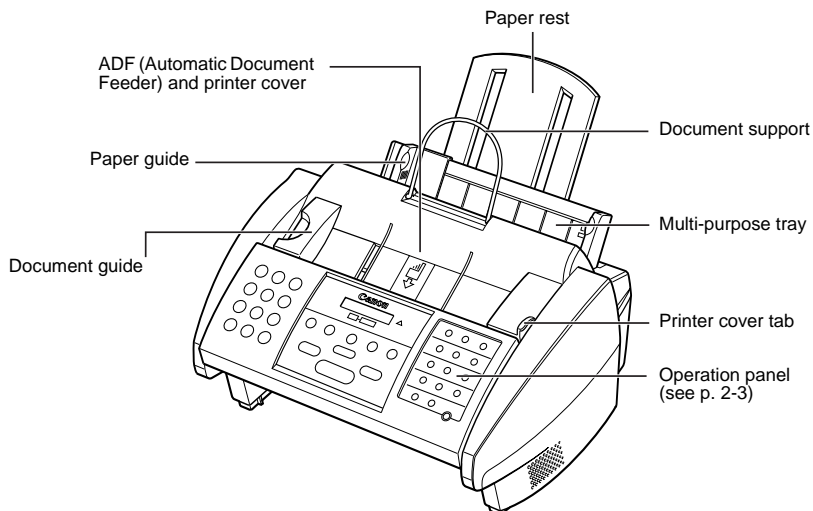

Note

Please note that your fax may differ from the illustration above.

Fax controls – the operation panel

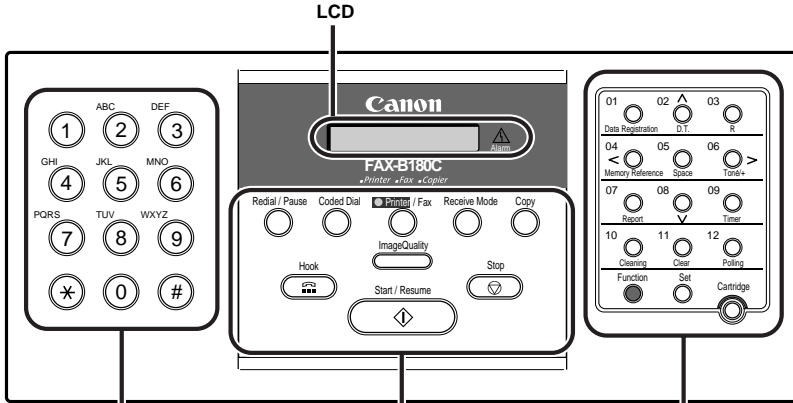

Numeric buttons
(see p. 2-5)

These are the buttons on the FAX-B180C operation panel. See p. 2-4 for buttons on the FAX-B160 operation panel.

One-touch speed dialling/ special function buttons
(see below)

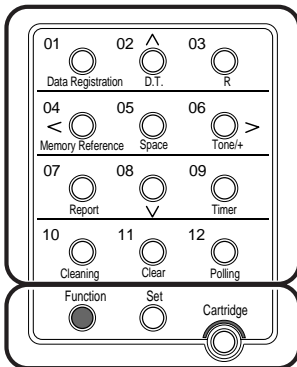

Data Registration button
(see p. 8-2)

▲, ▼ buttons (see p. 8-2)

D.T. button (see p. 2-19)

R button (see p. 1-14)

<, > buttons

(see pp. 2-6, 2-7)

Memory Reference button

(see pp. 6-13, 6-14)

Space button

(see pp. 2-6, 2-7, 2-10, 2-13)

Tone/+ button (see p. 2-19)

Report button (see p. 8-7)

Timer button (see p. 6-15, 6-16)

Cleaning button

(see pp. 9-7, 9-8)

Clear button (see p. 2-7)

Polling button (see p. 7-11)

Function button/light (see below)

Set button (see p. 8-2)

Cartridge button (see pp. 1-8, 9-9)

The buttons on the right of the operation panel have the following two functions:

- **One-touch speed dialling buttons** (see pp. 2-16, 2-18)
When the [Function] button's light is off, the buttons marked 01 to 12 can be used for one-touch speed dialling.
- **Special function buttons**
When the [Function] button's light is on, the special function buttons (function marked under each button) can be used to perform various operations.

■ FAX-B180C

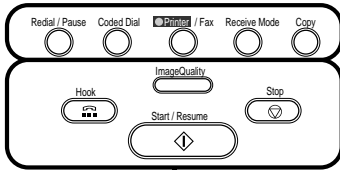

Redial/Pause button (see pp. 2-19, 6-9)
Coded Dial button (see pp. 2-16, 2-18)
Printer/Fax button (see Printer Guide)
Receive Mode button (see Chapter 7)
Copy button (see Chapter 5)

Image Quality button (see pp. 5-2, 6-2)
Hook button (see p. 6-6)
Stop button
Start/Resume button

■ FAX-B160

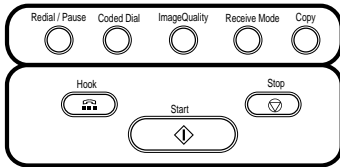

Redial/Pause button (see pp. 2-19, 6-9)
Coded Dial button (see pp. 2-16, 2-18)
Image Quality button (see pp. 5-2, 6-2)
Receive Mode button (see Chapter 7)
Copy button (see Chapter 5)

Hook button (see p. 6-6)
Stop button
Start button

Guidelines for entering numbers, letters, and symbols

When you come to a step that requires you to enter a name or number, see the table below to determine which numeric button to press for the character you want.

Button	Uppercase Letter Mode (:A)	Lowercase Letter Mode (:a)	Number Mode (:1)
1			1
<small>ABC</small> 2	ABCÄÅÄÄÄÄÆÇ	abcääääääæç	2
<small>DEF</small> 3	DEFÐÉÉÉÉ	defðééèè	3
<small>GHI</small> 4	GHIÏÎÎ	ghiiiîî	4
<small>JKL</small> 5	JKL	jkl	5
<small>MNO</small> 6	MNOÑØÖÓÒÕÔ	mnoñøöóòõô	6
<small>PQRS</small> 7	PQRSP	pqrsp	7
<small>TUV</small> 8	TUVÜÚÛÜ	tuvüúûü	8
<small>WXYZ</small> 9	WXYZÝ	wxyzý	9
0			0
#	- . * # ! " , ; : ^ ` _ = / ' ? \$ @ % & + () [] { } < >		
*	Uppercase letter mode (:A) → Lowercase letter mode (:a) → Number mode (:1)		



Note After 60 seconds of no operation panel input, the fax returns to standby mode and any unregistered changes are lost.

■ Switching between number and letter modes

Press [*****] to select uppercase letter mode (:A), lowercase letter mode (:a), or number mode (:1).



— :A

(Uppercase letter mode)

— :a

(Lowercase letter mode)

— :1

(Number mode)

■ Entering letters

1

Press [*****] to switch to uppercase letter mode (:A) or lowercase letter mode (:a).



— :A

2

Press the numeric button that contains the letter you want.

- Press repeatedly until the letter you want appears. Each button cycles through the letters it contains.
- If you are unsure which button to press for the letter you want, see p. 2-5.



C :A

3

Continue entering other letters using the numeric buttons.

- If the next letter you want to enter is under a different numeric button, simply press that button until the letter you want appears.

-or-

If the next letter you want to enter is under the same numeric button you pressed in step 2, press [**>**] to move the cursor to the right. Then press that same numeric button repeatedly until the letter you want appears.

- To enter a space, press [Space].



CA :A

■ Entering numbers

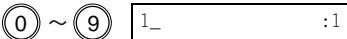

- 1 Press [*****] to switch to number mode (:1). 
- 2 Press the numeric button that contains the number you want. To enter a space, press [Space]. 

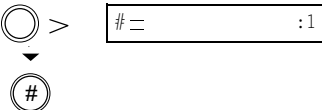
■ Entering symbols

- 1 Press [**#**] repeatedly until the symbol you want appears. 
- 2 If you want to enter another symbol, press [**>**] to move the cursor to the right, then press [**#**] repeatedly until the symbol you want appears. 

Correcting mistakes

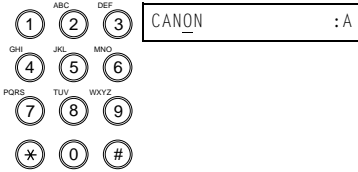
You can clear an entire entry by pressing [Clear]. Alternatively, follow the procedure below to correct individual characters:

- 1 Use [**<**] or [**>**] to move the cursor under the incorrect character. 
- 2 Use the numeric buttons to enter the correct character over the incorrect character. 
- 3 When you have finished making corrections, press [**Set**] to register your new entry. 

Registering sender information

Personalising your fax

■ Identifying your documents

When sending a document, you can have your fax number and your name (known as your ID), and the current date and time printed out by the receiving fax machine. This information is called your TTI (Transmit Terminal Identification) and appears at the top of the faxed document in small type.

By identifying the documents you send, the receiving party will be able to recognise your fax messages at a glance. The illustration below shows a sample document with the identifying information.

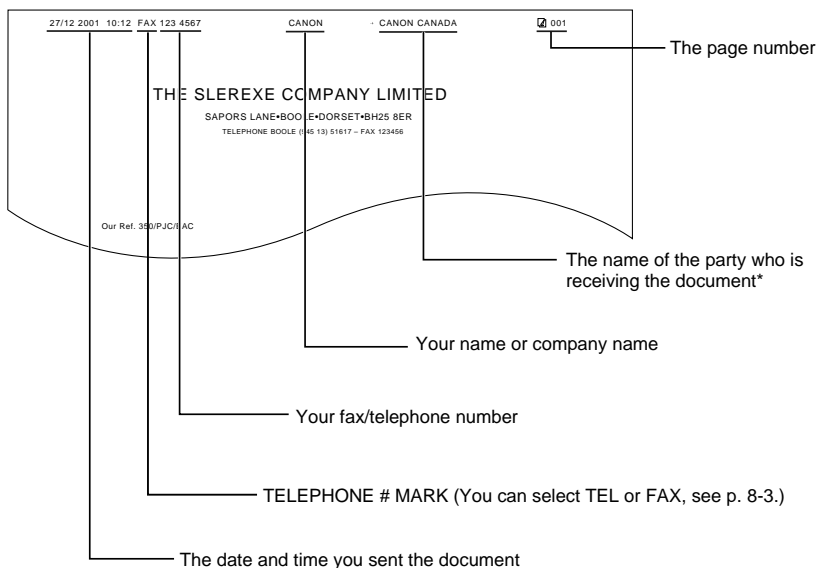

* The top line includes the name of the receiving party if you send the document using one-touch speed dialling or coded speed dialling and you registered the party's name.

Setting the date and time

Follow the procedure below to set the date and time for your fax. The date and time appear on the LCD as well as on the documents you send.

- 1** Press [Function].
Press [Data Registration].

Function



Data registration



DATA REGISTRATION

- 2** Press [Set] three times.

Set



USER SETTINGS

DATE & TIME

_20/12 2001 13:30

- 3** Use the numeric buttons to enter the date and time using the day-month-year format (DD/MM YYYY).

0 ~ 9



27/12 2001 15:00

 - Set the time using the 24-hour clock system.
Precede single digits with a zero.
Example: 7:30 a.m. = 07:30
 - Correct errors by moving the cursor under the incorrect number using [<] or [>] and entering the correct number.
 - To change the date format, see SYSTEM SETTINGS, p. 8-6.

- 4** Press [Set].
Wait a second for UNIT TELEPHONE # to appear.

Set



DATA ENTRY OK

1 sec.

UNIT TELEPHONE #











- 5** Press [Stop].
Registration ends and the fax returns to standby mode.

Stop



Registering your fax/telephone number and name

Follow the procedure below to register your fax/telephone number and name or company name so that this information appears at the top of each document you send.

<p>1 Press [Function]. ▼ Press [Data Registration].</p>	<p>Function  ▼ Data registration  DATA REGISTRATION</p>
<p>2 Press [Set] twice.</p>	<p>Set  USER SETTINGS DATE & TIME</p>
<p>3 Use [^] or [v] to select UNIT TELEPHONE #. ▼ Press [Set].</p>	<p>  ^ ▼ Set  UNIT TELEPHONE # TEL=</p>
<p>4 Enter your fax number (up to 20 digits) using the numeric buttons. • To enter a space, press [Space]. • To enter a plus sign (+) before the number, press [Tone/+]. • Correct errors by pressing [Clear] and re-enter the number.</p>	<p> ~  ITEL= 123 4567</p>
<p>5 Press [Set]. Wait a second for UNIT NAME to appear. ▼ Press [Set].</p>	<p>Set  DATA ENTRY OK 1 sec. ▼ Set  UNIT NAME _ : A</p>

Registering sender information

6 Enter your name (up to 24 characters) using the numeric buttons. (see p. 2-5)

Correct errors by moving the cursor under the incorrect character using [**<**] or [**>**] and entering the correct character.

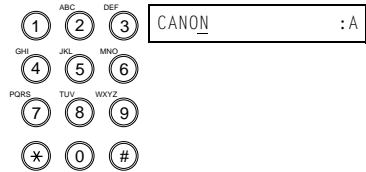

7 Press [Set].

Set



DATA ENTRY OK

1 sec.

TX TERMINAL ID

8 Press [Stop].

Stop



Registering one-touch speed dialling numbers and names

The quickest way to dial a fax number is to use one-touch speed dialling. This allows you to dial a number by pressing a single button. Before you can use one-touch speed dialling, you must register the receiving number with your fax.

One-touch speed dialling allows you to register a fax number (up to 120 digits) under a one-touch speed dialling button (01 to 12). You can also register the name of the party (up to 16 characters); the name appears on the printout of the one-touch speed dialling list. See One-touch speed dialling list, p. 8-9.

Follow the procedure below to register numbers and names for one-touch speed dialling.

- 1** Press [Function].
 Press [Data Registration].

Function



Data registration



DATA REGISTRATION

- 2** Use [^] or [v] to select TEL REGISTRATION.
 Press [Set].

^ v



Set



TEL REGISTRATION

Set



1-TOUCH SPD DIAL

- 3** Press [Set].

Set



01=

- 4** Use [^] or [v] to select the number of the one-touch button you want to use for the number.

 - If a number is already registered under this one-touch speed dialling button, the number or GROUP DIAL is displayed on the LCD.*
 - It is also possible to select a one-touch speed dialling button by pressing the button directly.

If necessary, press [Function] to turn its light off.

Press [Set] twice.

^ v



Set



04=

Set



TELEPHONE NUMBER

Set





TEL=_

* To delete the name and number registered under the one-touch speed dialling button, press [Clear] after you perform steps 1 to 4 above.

Registering one-touch speed dialling numbers and names

5 Enter the party's number (up to 120 digits) using the numeric buttons.

 ~ 
TEL=2 50921_

- Correct errors by pressing [Clear] and re-entering the number.
- Press [**<**] to delete the rightmost digit.
- To enter a space, press [Space].

6 Press [Set] to register the number.

Wait a second for NAME to appear.

DATA ENTRY OK
1 sec.













NAME
_ : A

▼
Press [Set].



7 Enter the party's name (up to 16 characters) using the numeric buttons. (see p. 2-5)

Correct errors by moving the cursor under the incorrect character using [**<**] or [**>**] and entering the correct character.

	ABC	DEF	
			
GHI	JKL	MNO	
			
PQRS	TVW	WXYZ	
			
			

CANON ITALIA_ :A

8 Press [Set] to register the name.

DATA ENTRY OK
1 sec.

05=

9 To assign additional one-touch speed dialling numbers, start from step 4. To finish, press [Stop].



Registering coded speed dialling numbers and names

Use coded speed dialling to dial a fax number at the press of three buttons. A fax/telephone number can be registered under each two-digit speed dialling code (00-99) and you can register up to 100 locations, with each number containing up to 120 digits. You can also register the name of the party (up to 16 characters); the name appears on the printout of the coded speed dialling list. See Coded speed dialling list, p. 8-9.

Follow the procedure below to register numbers and names for coded speed dialling.

- 1** Press [Function].
Press [Data Registration].

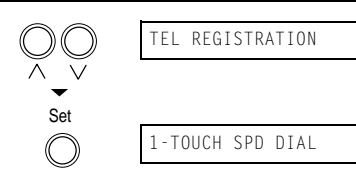

- 2** Use [^] or [v] to select TEL REGISTRATION.
Press [Set].

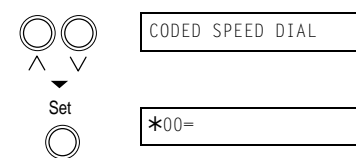

- 3** Use [^] or [v] to select CODED SPEED DIAL.
Press [Set].

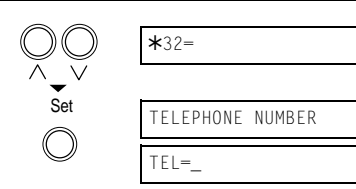

- 4** Use [^] or [v] to select the two-digit code under which you want to register the number.

 - If a number is already registered under this coded speed dialling code, the number or GROUP DIAL is displayed on the LCD.*
 - It is also possible to select a two-digit code directly by pressing [Coded Dial] followed by the two-digit code.

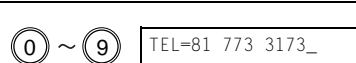
Press [Set] twice.

- 5** Enter the party's number and name the same way you registered them for one-touch speed dialling.
(See steps 5 to 8, Registering one-touch speed dialling numbers and names, p. 2-12.)

- 6** To assign additional coded speed dialling numbers, start from step 4.
To finish, press [Stop].



* To delete the name and number registered under the coded speed dialling code, press [Clear] after you perform steps 1 to 4 above.

Registering group dialling numbers and names

The quickest way to send a document to multiple destinations is to use group dialling. This allows you to send a document to fax numbers registered in a group by either pressing a one-touch speed dialling button, or by pressing [Coded Dial] and then entering the two-digit code under which the group is registered. Before you can use group dialling, you must register a group of fax numbers for one-touch or coded speed dialling with your fax.

You can register up to 111 fax numbers in a group, with each number containing up to 120 digits. You can also register the name of the group (up to 16 characters); the name appears on the printout of the group dialling list. See Group dialling list, p. 8-9.

Follow the procedure below to register numbers and names for group dialling.

- 1** Press [Function].
Press [Data Registration].

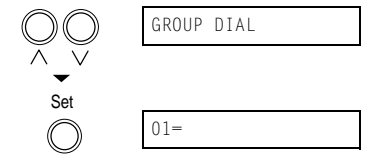

- 2** Use [^] or [v] to select TEL REGISTRATION.
Press [Set].

- 3** Use [^] or [v] to select GROUP DIAL.
Press [Set].

- 4** Select a one-touch speed dialling button or coded speed dialling code under which you want to register the group.

 - To register a group under a one-touch speed dialling button:

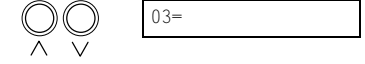
Use [^] or [v] to select the button under which you want to register the group (01 to 12).

 - It is also possible to select a one-touch speed dialling button by pressing the button directly. If necessary, press [Function] to turn its light off.
 - If a one-touch speed dialling button has already been registered, 1-TOUCH SPD or GROUP DIAL appears.

- To register a group under a coded speed dialling code: Press [Coded Dial], then use the numeric buttons to enter the code under which you want to register the group (00 to 99).
- If a coded speed dialling code has already been registered, CODED SPEED or GROUP DIAL appears.

Coded Dial



*21=



Note

If you wish to register a group under a button or code already registered for speed dialling, or you want to re-register a group, you must delete the old information first. (see pp. 2-12, 2-14)

5 Press [Set] twice.

Set



TELEPHONE NUMBER

TEL=

6 Enter the one-touch and/or coded speed dialling numbers you want to register in the group.

- To enter a destination registered for one-touch speed dialling:

Press the one-touch speed dialling button(s) under which the number(s) you want to register in the group are registered. If necessary, press [Function] to turn its light off.



Data Registration

Polling

01=905 795 1111

- To enter a destination registered for coded speed dialling: Press [Coded Dial], then use the numeric buttons to enter the two-digit code under which the number you want to register in the group is registered.

Coded Dial



*03=516p488 6700

Repeat for other codes.

- The number registered under the one-touch speed dialling button or coded speed dialling code you enter appears. GROUP DIAL appears if you select a group.
- You cannot use the numeric buttons to enter numbers not registered for one-touch or coded speed dialling.
- You can enter the numbers of buttons or codes that have groups registered under them.
- To add destinations to a group already registered, simply enter them as explained in this step.
- If you enter the wrong destination, or if you want to delete a destination already registered in a group, use [Λ] or [V] to select that entry, then press [Clear].
- To cancel group dialling for the button or code you selected, press [Clear] until all entries are deleted, then press [Set]. Press [Stop] to return to standby mode. All fax numbers and the name of the group registered under that button or code will be deleted.



Registering group dialling numbers and names

7 Press [Set] twice.

Set



NAME
_ :A

8 Enter the party's name (up to 16 characters) using the numeric buttons. (see p. 2-5)

Correct errors by moving the cursor under the incorrect character using [<] or [>] and entering the correct character.

If necessary, press [Function] to turn its light on.



Canon GROUP 1_ :1

9 Press [Set] to register the name.

Set



DATA ENTRY OK
1 sec.
04=1-TOUCH SPD

10 To assign additional group dialling numbers, start from step 4.
To finish, press [Stop].

Stop



2

PREPARING TO USE YOUR FAX

Automatic dialling

Sending a document using one-touch speed dialling, coded speed dialling or group dialling numbers

To use this feature you must first register numbers for one-touch speed dialling (see pp. 2-12, 2-13), coded speed dialling (see p. 2-14) or group dialling (see pp. 2-15 to 2-17).

Follow the procedure below to send a document using a one-touch speed dialling, coded speed dialling or group dialling number.

1 Load the document face down into the Automatic Document Feeder (ADF).

See Loading documents, p. 3-3.

You can set the scanning resolution and the contrast.
(see p. 6-2)

DOCUMENT READY

2 Press the one-touch speed dialling button under which the number you wish to fax is re-gistered.

01 ~ 12
Data Registration ~ Polling
TEL=905 795 1111

-or- Press [Coded Dial] and enter the appropriate two-digit coded speed dialling code.

The registered number appears.

- If a group is already registered under a one-touch speed dialling button or coded speed dialling code, TEL=GROUP DIAL appears.
- If no number is registered for the one-touch speed dialling button or coded speed dialling code you pressed, the LCD shows NO DATA. Make sure you pressed the correct button or entered the correct code and that the number you want to dial is registered correctly.
- If you make a mistake, press [Stop]. Then press the correct one-touch speed dialling button or press [Coded Dial] and re-enter the code.
- If an error message appears on the LCD, correct the error and press [Stop]. If necessary, see Faxing problems, p. 9-12 and LCD Messages, p. 9-18.

Coded Dial

0 ~ 9

TEL=1 49 39 25 25

Special dialling

This section explains how to dial long-distance numbers, confirm a dial tone, and switch temporarily to tone dialling.

■ Long-distance dialling

When you register a long-distance number, you may have to insert a pause within or after the number. For long-distance dialling, the location and length of the pause may differ depending on the telephone system. To enter a pause, press [Redial/Pause]. The length of this pause can be adjusted. See MID PAUSE SET, p. 8-4. A pause at the end of a number is fixed at 10 seconds.

■ Confirming a dial tone

The availability of this feature depends on the current country selection. You can print the USER DATA LIST to check the current setting. (see p. 8-7)

When you register a number, you may have to confirm the dial tone in the middle of a fax/telephone number before entering the rest of the number. This is called dial tone detection. When dial tone detection is required, press [D.T.]; a small dot (.) appears on the LCD*.

■ Switching temporarily to tone dialling

Many information services for banks, airline reservations, hotel reservations, etc., require tone dialling for their services. If your fax is connected to a rotary pulse line, when tone dialling is required, press [Tone/+]. Numbers dialled after pressing [Tone/+] will be dialled using tone dialling. Tone dialling is cancelled when you disconnect the call.

* This function is only available with some country settings.

3

HANDLING DOCUMENTS

Preparing documents	3-2
Types of documents you can scan	3-2
Problem documents.....	3-2
Loading documents	3-3
Problems with multipage documents.....	3-4
Adding pages to the document.....	3-4

Preparing documents

Types of documents you can scan

■ Size

The fax can scan standard A4-, letter-, or legal-size documents.

■ Thickness

Each sheet of the document should be of the same thickness and between 0.08 mm and 0.13 mm thick, with a paper weight between 75 g/m² and 90 g/m².

■ Scanned area

The actual area scanned by the fax is shown below.

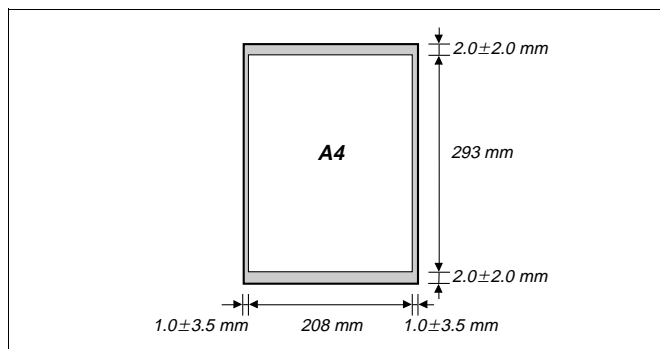

The margin on either side of the sheet and the margin on the top and bottom are not picked up by the scanner.

Problem documents

To prevent document jams in the ADF, do not attempt to load the following types of document into the fax.



Wrinkled or creased paper



Curled or rolled paper



Torn paper



Carbon paper or carbon-backed paper



Coated paper or glossy paper



Onion skin or thin paper



Envelopes



- Remove all staples, paper clips, etc. before loading the document into the ADF.
- Make sure any glue, ink or correction fluid on the paper is completely dry before loading the document into the ADF.
- Make a photocopy of any document that will not feed into the fax so that you can then load the copy into the ADF.

Loading documents

Follow the procedure below to load documents into the Automatic Document Feeder (ADF).

- 1** Adjust the document guide to the width of the document.
- 2** Gently insert the top of the document face down into the ADF until you hear a beep.

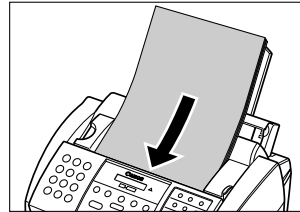
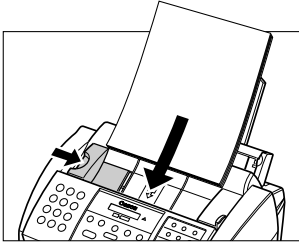

Tap multipage documents on a flat surface to even the edges before inserting them into the ADF.



- For a multipage document, the pages are fed one by one from the bottom of the stack.
- Wait until all pages of your document have been scanned before starting a new job.
- Make sure you follow the procedure above to load documents into the ADF. If the document is not loaded into the ADF correctly, it may not feed into the fax properly; resulting in a jam, or in pages not being sent or copied.
- If your document has more than 20 A4- or letter-size pages, or 10 legal-size pages, divide the document into 2 sections and send or copy each section separately.

Problems with multipage documents

If you have trouble feeding multipage documents from the Automatic Document Feeder (ADF) into the fax, remove the stack and tap it on a flat surface to even the edges. Then slant the stack so that its front edge is bevelled, and insert the stack into the ADF.

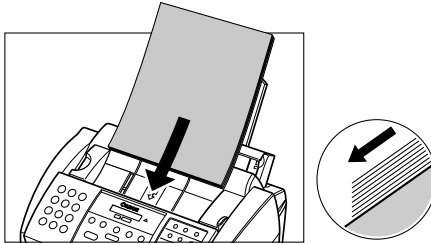

Note

To avoid feeding problems, make sure the document meets the document requirements. (see p. 3-2)

Adding pages to the document

You can load up to 20 A4- or letter-size sheets, or 10 legal-size sheets at a time into the ADF. For longer documents, wait until the final sheet has started feeding, then load up to 20 more sheets (10 for legal-size). If you want to add pages while the fax is sending or copying a document, insert the first new page so that it overlaps the last page by about 2 cm.

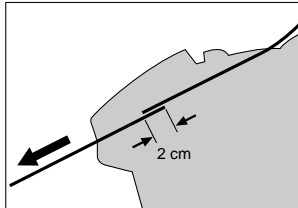

Note

Where possible, you should avoid adding pages to the document you are sending or copying as this may lead to a jam in the ADF or a paper misfeed.

4

HANDLING PAPER

Paper requirements.....	4-2
Printable area	4-2
Loading paper.....	4-2

Paper requirements

Your fax supports A4-, letter-, and legal-size paper in portrait orientation. You can use regular copier paper, cotton bond paper, or typical letterhead. Your fax does not require special ink jet paper. Always use paper without curls, folds, staples, or damaged edges. Look at the label on the package to see if the paper has a preferred side for printing.

You can stack the following paper in the multi-purpose tray.

Size (W × L)	Weight	Quantity
A4 (210 × 297 mm/8.27 × 11.69 in.)	64-90 g/m ²	Approx. 100 sheets* (Max. 10 mm stack)

Letter (215.9 × 279.4 mm/8.5 × 11 in.)

Legal (215.9 × 355.6 mm/8.5 × 14 in.)



Be sure to test paper before purchasing large quantities.

Printable area

The shaded area below shows the printable area of A4-size paper. Be sure to print within this area.

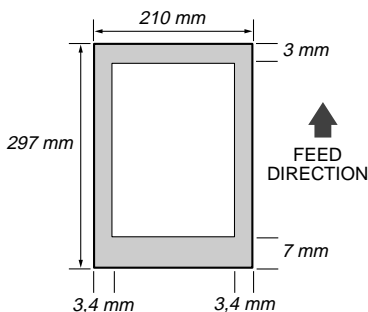

Loading paper

For details on loading paper in the multi-purpose tray, see p. 1-12.

* 75 g/m² paper

5

MAKING COPIES









Copying documents	5-2
-------------------------	-----

Copying documents

Before you copy a document, see Chapter 3: HANDLING DOCUMENTS.

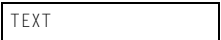
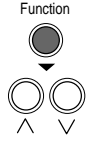
One of the convenient features of the fax is its ability to make high quality copies. You can make up to 99 copies of one document at a time.

Follow the procedure below to copy a document.

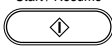
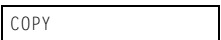
- 1 Load the document face down into the Automatic Document Feeder (ADF).**
See Loading documents, p. 3-3.

- 2 Press [Copy].**

- 3 Press [Image Quality].**
You can select TEXT or PHOTO.

- 4 To make a reduction of your document, press [Function], then use [^] or [v] to select the percentage.**
You can select 100%, 90%, 80% or 70%.

- 5 Enter the number of copies (up to 99) using the numeric buttons.**
To make a correction to the number of copies, make sure the [Function] button's light is on and then press [Clear] and re-enter the number and if necessary, reduction percentage.

- 6 Press [Start].**
To stop copying anytime, press [Stop]. You may then need to lift the operation panel to remove the document. See Jams in the Automatic Document Feeder (ADF), p. 9-2.





Note

You will be unable to make multiple copies if MEMORY FULL appears on the LCD. Print or delete any documents stored in memory (see pp. 6-13, 6-14, 7-10) to free up space in the fax's memory, then start again. Also, if you are copying multiple pages with many graphics, separate the pages into smaller stacks or make the desired number of copies one at a time as needed.

6

SENDING DOCUMENTS

Preparing to send a document.....	6-2
Adjusting the quality of your documents.....	6-2
Sending methods.....	6-3
Dialling methods.....	6-4
Sending documents	6-5
Memory sending.....	6-5
Manual sending.....	6-6
Messages displayed during sending.....	6-7
Cancelling sending.....	6-8
Redialling when the line is busy	6-9
Manual redialling.....	6-9
Automatic redialling.....	6-9
Sequential broadcasting.....	6-12
Sending a document to more than one location.....	6-12
Documents stored in memory.....	6-13
Printing a list of documents in memory.....	6-13
Printing a document in memory.....	6-13
Deleting a document from memory.....	6-14
Delayed sending.....	6-15
Sending other documents while the fax is set for delayed sending.....	6-16
Cancelling delayed sending.....	6-16

Preparing to send a document

Before you send a document, see Chapter 3: HANDLING DOCUMENTS.

Adjusting the quality of your documents _____

■ Setting the scanning resolution

Resolution is a measure of the fineness or clarity of a printout. Low resolutions may cause text and graphics to have a jagged appearance, while higher resolutions provide smoother curves and lines, crisp text and graphics, and a better match to traditional typeface designs.



Note

The higher the resolution, the higher the output quality, but the slower the scanning speed.

1 Press [Image Quality] to select the resolution.

You can select FAX STANDARD, FAX FINE or FAX PHOTO.

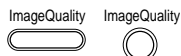

FAX PHOTO

After about 10 seconds, the fax returns to standby mode.



Note

You can change the resolution setting while the document is being scanned for sending. However, please note that your new setting will only be effective from the next page scanned.

■ Setting the scanning contrast

Contrast is the difference in brightness between the lightest and darkest parts of a printed document. You can adjust the contrast your fax uses to send or copy documents, according to how light or dark your document is.

Follow the procedure below to set the scanning contrast.

1 Press [Function].

Press [Data Registration].

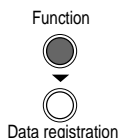



DATA REGISTRATION

2 Press [Set] twice.

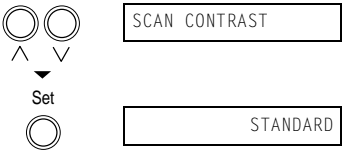
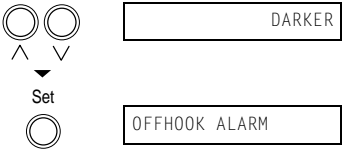

USER SETTINGS

DATE & TIME

- 3** Use [^] or [v] to select SCAN CONTRAST.
Press [Set].
- 
- 4** Use [^] or [v] to adjust the scanning contrast.
You can select STANDARD, DARKER or LIGHTER.
Press [Set].
- 
- 5** Press [Stop].
Setting ends and the fax returns to standby mode.
- 

Sending methods

■ Memory sending (see p. 6-5)

Each time you send a document, the fax quickly scans the document into memory and then sends the document from memory after it has dialled the receiving party. This is called memory sending. Memory sending allows you to remove the original document immediately after scanning.

If MEMORY FULL appears on the LCD when scanning the document, the rest of the document is not scanned into memory but is sent directly to the receiving party.

■ Manual sending (see p. 6-6)

If you would like to speak with the receiving party before sending a document to them, use manual sending. When sending manually, you dial, converse normally and then press [Start] to begin sending.

For manual sending, you need to have the optional handset, a telephone or an extension phone connected.

Dialling methods

There are several methods of dialling the receiving party's number, depending on how your fax is set up.

■ Regular dialling

Dial a fax number using the numeric buttons.

Remember that when using regular dialling, you must press [Start] after entering the number.

■ One-touch speed dialling (see p. 2-12)

Dial a fax number that has been registered under a one-touch speed dialling button by simply pressing the corresponding one-touch speed dialling button.

■ Coded speed dialling (see p. 2-14)

Dial a fax number that has been registered under a coded speed dialling code by pressing [Coded Dial] and the two-digit code under which the number is registered.

Scroll through coded speed dialling locations by pressing [Coded Dial] and then using [^] or [V] to scroll through a list of coded speed dialling codes under which numbers have been registered.

■ Group dialling (see p. 2-15)

Dial fax numbers registered in a group by either pressing a one-touch speed dialling button, or by pressing [Coded Dial] and then entering the two-digit code under which the group is registered.

Sending documents

Memory sending

When you send a document, the fax uses memory sending to send your document. With memory sending, the fax dials the receiving party, quickly scans the document into memory, and then sends the document from memory. This means you do not have to wait for the fax to finish sending before you can retrieve your original document.

You can send up to 20* A4-size pages at a time with memory sending.



If MEMORY FULL appears on the LCD when you scan the document, the rest of the document is not scanned into memory but is sent directly to the receiving party.

Follow the procedure below to send a document.

1

Load the document face down into the Automatic Document Feeder (ADF).

See Loading documents, p. 3-3.

You can set the scanning resolution and contrast. (see p. 6-2)

DOCUMENT READY

2

Dial the receiving party's fax number.

Use one of the dialling methods described on page 6-4.

If the TIME OUT setting is set to ON the fax will start dialling automatically. (see p. 8-4)

TEL= 34567890

3

Press [Start].

The fax begins sending.

Start / Resume



TEL= 34567890

SCANNING P.001



- If an error occurs during sending, the fax beeps intermittently for a few seconds. If this happens, try sending the document again.
- The fax automatically redials if the receiving party does not answer or if the line is busy. (You can specify the number of times it redials; see AUTO REDIAL, p. 8-4.)
- If an error message appears on the LCD, correct the error and then press [Stop]. See LCD messages, p. 9-18.
- You may not be able to use memory sending if the percentage of currently used memory shown on the LCD is close to 100%. If the memory becomes full while the fax is scanning your document into memory, MEMORY FULL is displayed on the LCD. If this should happen, you can wait until enough memory is available and the fax begins to scan the document again automatically. If you want to remove the document from the fax and try to send it again later, open the operation panel and remove the document. In this case, see Jams in the Automatic Document Feeder (ADF), p. 9-2.

* A maximum of 42 pages (Canon FAX Standard Chart No.1, standard resolution) can be scanned into the fax memory. A maximum of 20 pages can be loaded into the ADF.

Manual sending

If you would like to first speak with the person you are sending the document to, use manual sending. You need to connect the optional handset, a telephone or an extension phone to the fax for manual sending.

Follow the procedure below to send a document using manual sending.

1 Load the document face down into the Automatic Document Feeder (ADF).

See Loading documents, p. 3-3.

You can set the scanning resolution and contrast. (see p. 6-2)

DOCUMENT READY

2 Lift the handset or press [Hook] and dial the receiving party's fax number.

Use one of the dialling methods described on page 6-4.

Hook



TEL= 34567890

3 If a person answers, converse normally using the handset, then ask them to press the start button on their fax. Press [Start] and hang up.

If you hear a high pitch tone, press [Start] and hang up.

Start / Resume

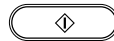

Note

- The fax will beep if the optional handset is not hung up properly. Make sure the optional handset is seated properly in its cradle. If you do not want the fax to beep, disable the OFFHOOK ALARM setting. (see p. 8-3)
- If an error occurs during sending, the fax beeps intermittently for a few seconds. If this happens, try sending the document again.
- If an error message appears on the LCD, correct the error and then press [Stop]. See LCD messages, p. 9-18.

Messages displayed during sending

When your fax sends a document, the following messages are displayed as the call progresses.

The LCD tells you when scanning begins.

TX/RX NO. 0003



SCANNING P.001



TX

The fax is dialling the receiving party's phone number.

DIALLING

The receiving party's phone is ringing.

CALLING

After a few moments the LCD begins changing every second.

TX/RX NO. 0003



CANON INC.

Receiving party's name
(This may not be displayed in some cases.)



7893456

Receiving party's number



ECM TX P.002

or TX P.002

If ECM is not being used, "TX P.xxx" is displayed.

After the document is sent, the fax beeps once (after manual sending only) and the LCD tells you when the transmission has ended.

TRANSMITTING OK

Cancelling sending

Follow one of the procedures below to stop sending a document before transmission is completed.

■ Cancelling memory sending

1

Press [Stop].

The fax asks you to confirm that you want to cancel sending.

Stop



CANCEL? *YES #NO

YES=(*) NO=(#)

2

Press [*] to cancel sending.

- Sending is not cancelled until you press [*].
- If you change your mind and want to continue sending, press [#].
- The fax prints an ERROR TX REPORT. (see p. 8-11)



■ Cancelling manual sending

1

Press [Stop].

- The transmission is cancelled.
- The fax prints an ERROR TX REPORT. (see p. 8-11)

Stop



Note

When you cancel sending, you may need to open the operation panel to remove the document from the Automatic Document Feeder (ADF). See Jams in the Automatic Document Feeder (ADF), p. 9-2.

Redialling when the line is busy

There are two methods of redialling: manual redialling and automatic redialling. This section explains these two methods.

Manual redialling

Press [Redial/Pause] to dial the last number you dialled with the numeric buttons. (This starts redialling regardless of whether automatic redialling is enabled.)

■ Cancelling manual redialling

To cancel manual redialling, press [Stop].

Automatic redialling

■ What is automatic redialling?

When you are sending a document using memory sending and the receiving party's line is busy, the fax waits the specified time and then dials the same number again. You can set the fax to redial several times if previous attempts fail because of a busy signal. This feature is called automatic redialling.

After the initial dial attempt, the fax will try to dial again. Automatic redialling can be turned off and on. The number of redialling attempts and the time interval between attempts can also be adjusted. (see AUTO REDIAL, p. 8-4)





If all redialling attempts are unsuccessful, the fax will cancel the transmission and print an ERROR TX REPORT to remind you that the transmission was not completed. (see p. 8-11)

When automatic redialling is in use, the LCD alternately displays AUTO REDIAL and the transaction number (TX/RX NO. xxxx) while the fax is waiting to redial.

■ Cancelling automatic redialling

Automatic redialling cannot be cancelled with the [Stop] button while the fax is waiting to redial. Redialling can be cancelled by using [Memory Reference]. (see p. 6-14)

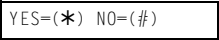
Follow the procedure below to cancel automatic redialling.





- 1 Wait until the fax begins redialling.**

- 2 Press [Stop].**
The fax asks you to confirm that you want to cancel automatic redialling.



- 3 Press [*] to cancel redialling.**
 - Redialling is not cancelled until you press [*].
 - If you change your mind and want to continue redialling, press [#].
 - The fax prints an ERROR TX REPORT. (see p. 8-11)



■ Setting the options for automatic redialling

You can set the following options for automatic redialling:

- Whether or not the fax redials automatically.
- The number of times the fax attempts to redial.
- The time interval between redialling attempts.

Follow the procedure below to set the automatic redialling settings.

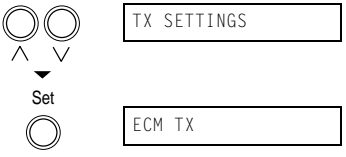
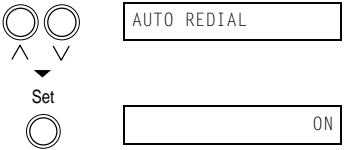
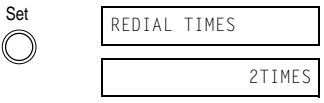
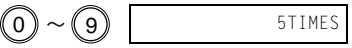
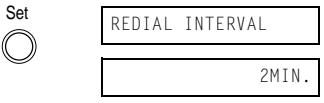
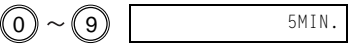
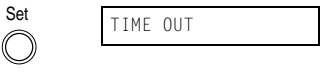
- 1 Press [Function].**
▼
Press [Data Registration].

Data registration

- 2 Press [Set].**



- | | |
|---|--|
| <p>3 Use [^] or [V] to select TX SETTINGS.
Press [Set].</p> |  |
| <p>4 Use [^] or [V] to select AUTO REDIAL.
Press [Set].</p> <ul style="list-style-type: none"> To disable automatic redialling, use [^] or [V] to select OFF, then press [Set]. Press [Stop] to return to standby mode. To enable automatic redialling, use [^] or [V] to select ON and continue with the steps below. |  |
| <p>5 Press [Set] twice.</p> |  |
| <p>6 Use the numeric buttons to enter the number of times you want the fax to redial.</p> |  |
| <p>7 Press [Set] twice.</p> |  |
| <p>8 Use the numeric buttons to enter the time interval between redialling attempts.</p> |  |
| <p>9 Press [Set].</p> |  |
| <p>10 Press [Stop].
Setting ends and the fax returns to standby mode.</p> |  |

Sequential broadcasting

Sending a document to more than one location

Sequential broadcasting sends one document to more than one location.

You can send to a total of 113 locations as follows:

One-touch speed dialling = 12 locations

Coded speed dialling = 100 locations

Regular dialling (Numeric buttons dialling) = 1 location

You can enter the one-touch speed dialling, coded speed dialling and regular dialling locations in any order. Remember that when using regular dialling, you must press [Set] after entering the number.

You can send up to 20*A4-size pages.

1 Load the document face down into the Automatic Document Feeder (ADF).

See Loading documents, p. 3-3.

You can set the scanning resolution and contrast. (see p. 6-2)

DOCUMENT READY

2 Dial the receiving party's fax number.

- You can also press [Redial/Pause] to redial the last number dialled with the numeric buttons.
- You must press the second button within 5 seconds of the first one, and each subsequent button within 10 seconds of the preceding one. The fax begins the operation approximately 10 seconds after you press the last button.

TEL= 34567890

3 Press [Start].

- The fax reads the document into memory and begins sending.
- To cancel a transmission, press [Stop] during dialling or transmission. All transmissions in the sequence are cancelled.

Start / Resume



TX/RX NO. 0007

1 sec.

SCANNING P.001

* A maximum of 42 pages (Canon FAX Standard Chart No.1, standard resolution) can be scanned into fax memory. A maximum of 20 pages can be loaded into the ADF.

Documents stored in memory

Printing a list of documents in memory

Your fax can print a list of documents stored in memory, along with the transaction number (TX/RX NO.) of each document. Once you know the transaction number of a document in memory, you can print it or delete it. See Doc. memory list, p. 8-7.

Printing a document in memory

Follow the procedure below to print a document stored in memory.

- 1** Press [Function].
Press [Memory Reference].

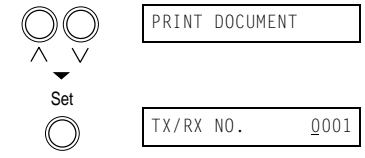

- 2** Use [^] or [v] to select PRINT DOCUMENT.
Press [Set].

- 3** Use [^] or [v] to select the transaction number (TX/RX NO.) of the document you want to print.

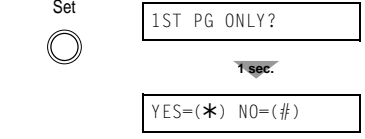
 - If you are unsure of the transaction number (TX/RX NO.), print the Doc. memory list. (see p. 8-7)
 - Use [<] or [>] to display details of the transaction (destination, for example).
 - The transaction number preceded by # shows the document currently being sent.
- 4** Press [Set].

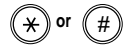







- 5** Press [*] to print the first page only, or press [#] to print all pages of the document.
The fax prints the document.

- 6** To continue printing other documents in memory, repeat the procedure from step 3.
To finish, press [Stop].



Deleting a document from memory

Follow the procedure below to delete a document from memory.











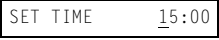

-
- 1** Press [Function].
Press [Memory Reference].
- Function

Memory Reference

- DOC. MEMORY LIST
-
- 2** Use [^] or [v] to select DELETE DOCUMENT.
Press [Set].
- 
Set

- DELETE DOCUMENT
- TX/RX NO. 0001
-
- 3** Use [^] or [v] to select the transaction number (TX/RX NO.) of the document you want to delete.
- If you are unsure of the transaction number (TX/RX NO.), print the Doc. memory list. (see p. 8-7)
 - Use [<] or [>] to display details of the transaction (destination, for example).
- 
- TX/RX NO. 0003
-
- 4** Press [Set].
The fax asks you to confirm that you want to delete the document.
- Set

- OK TO DELETE?
- YES=(*) NO=(#)
-
- 5** Press [*] to delete the document.
If you change your mind and want to keep the document in memory, press [#].
- 
- ERASING END
-
- 6** To continue deleting other documents in memory, repeat the procedure from step 3.
To finish, press [Stop].
- Stop

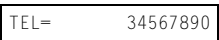
-

Delayed sending

Your fax can send documents automatically at a preset time. This allows you to take advantage of lower late night long-distance rates offered by some telephone companies.

It is possible to set the fax to send transmissions at 30 different preset times. See *Sending a document to more than one location* for details, p. 6-12.

Follow the procedure below to send a document using delayed sending.

- 1 Load the document face down into the Automatic Document Feeder (ADF).**
See *Loading documents*, p. 3-3.
You can set the scanning resolution and contrast. (see p. 6-2)

- 2 Press [Function].**
Press [Timer].

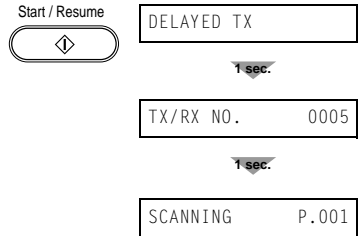

- 3 Press [Set].**

- 4 Enter the desired sending time (24-hour clock) using the numeric buttons.**
 ~ 

 - Set the time using the 24-hour clock system.
Precede single digits with a zero.
Example: 7:30 a.m. = 07:30
 - Press [Clear] if you need to re-enter the time.
 - You can also use [<] or [>] to move the cursor.
- 5 Press [Set].**



- 6 Enter the receiving party's fax number.**

 - You can enter the receiving party's fax number using the numeric buttons, one-touch speed dialling, coded speed dialling, or group dialling (see p. 2-18). If necessary, press [Function] to turn its light off.
 - If you use the numeric buttons, press [Set] after entering the number to register it before going on to the next number.

7 Press [Start].
The fax scans the document into memory.



8 When the set time comes, the fax dials and sends the document.

Sending other documents while the fax is set for delayed sending

You can send, receive, and copy other documents even when the fax is set for sending at a preset time.

The fax can only register one preset sending operation at a time.

To send or copy other documents after setting the fax for delayed sending, simply send or copy using any other sending procedure in this guide.



Note

Delayed sequential broadcasting is applicable for sending one document to more than one location at a later time when multiple fax numbers are dialed. (see p. 6-12)

Cancelling delayed sending

Follow the procedure below to cancel delayed sending.

1 Press [Function].
Press [Timer].

Function



Timer

REGISTER

2 Use [^] or [V] to select DELETE FILE.
To check the contents of a file, select PRINT.
(see p. 6-13)

Press [Set].



Set

DELETE FILE

TX/RX NO. 0006

3 Use [^] or [v] to select the file you want to delete.

Use [<] or [>] to display the telephone number and the time at which delayed sending was set.

Press [Set].

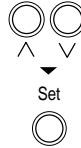

TX/RX NO. 0005

OK TO DELETE?

YES=(*) NO=(#)

4 Press [*] to delete the file.

- The file is not deleted until you press [*].
- If you change your mind and want to continue sending, press [#].
- If you want to cancel delayed sending for any other documents, repeat the procedure from step 3.



ERASING END

5 Press [Stop].

The fax returns to standby mode.

Stop





7

RECEIVING DOCUMENTS

Different ways to receive a document	7-2
Receiving documents automatically: FAX ONLY MODE	7-3
Receiving both documents and telephone calls automatically:	
Fax/Tel mode	7-3
Receiving documents manually: MANUAL MODE	7-7
Receiving documents with an answering machine:	
ANS.MACHINE MODE	7-9
Other features	7-10
Receiving documents while performing other tasks	7-10
Receiving documents in memory when a problem occurs ...	7-10
Polling to receive documents.....	7-11
Cancelling receiving.....	7-12
Receiving restriction	7-13

Different ways to receive a document

Your fax provides you with several modes for receiving documents. To determine which mode best suits your requirements, see the table below.

Receive Mode	Main Use	Operation	Requirements	Details
FAX ONLY MODE	Fax	Answers all calls as fax calls. Receives documents automatically and disconnects voice calls.	Separate telephone line for fax use only.	p. 7-3
FAX/TEL AUTO SW (Fax/Tel mode)	Fax/Tel	Automatically switches between fax and voice calls. Receives documents automatically and rings for voice calls.	Optional handset, telephone, or extension phone connected to the fax.	p. 7-3
MANUAL MODE	Tel	Rings for every call, regardless of whether the call is a fax call or a voice call. For a fax call, you have to manually activate reception of the fax.	Optional handset, telephone, or extension phone connected to the fax.	p. 7-7
ANS.MACHINE MODE	Fax/Tel	Receives documents automatically and routes voice calls to the answering machine.	Answering machine connected to the fax.	p. 7-9

Once you have decided which mode is suitable for your needs, set the mode as described in this chapter. You can change the mode at any time.

Receiving documents automatically: FAX ONLY MODE

If you have a separate telephone line for your fax, set FAX ONLY MODE for the fax to answer all calls as fax calls.

■ Setting FAX ONLY MODE

- 1 Press [Receive Mode] to select FAX ONLY MODE.

Receive Mode



FAX ONLY MODE

After a few seconds, the LCD changes to this display:

15:00 FaxOnly

Receiving both documents and telephone calls automatically: Fax/Tel mode

Set this mode if you want your fax to automatically switch between voice and fax calls



For this mode, you need to connect the optional handset, a telephone or an extension phone to your fax. (see pp. 1-5, 1-6)

■ Setting Fax/Tel mode

- 1 Press [Receive Mode] to select Fax/Tel Mode.

Receive Mode



Fax/Tel Mode

After a few seconds, the LCD changes to this display:

15:00 FaxTel

■ What happens when Fax/Tel mode is selected

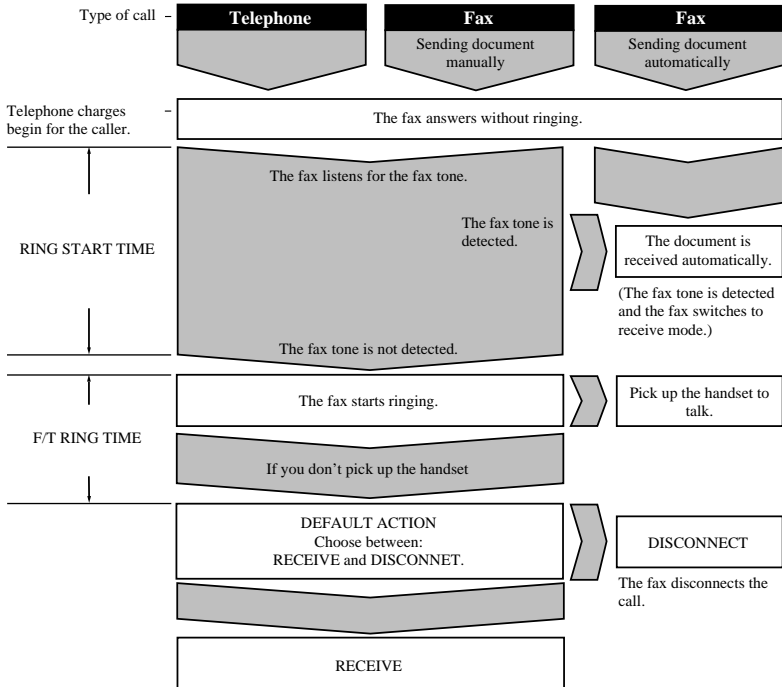

Not all fax machines are capable of sending a fax tone. For those cases if you set the DEFAULT ACTION to RECEIVE, the fax switches to receive mode automatically and starts receiving the document. If no document comes in, it disconnects the call after approximately 40 seconds.

■ Setting the options for Fax/Tel mode

If you set Fax/Tel mode, you can control precisely how the fax handles incoming calls by adjusting the following settings:

- Adjust the time the fax takes to check whether a call is from a fax machine or a telephone (RING START TIME setting).
- Adjust the length of time the fax rings when the call is a voice call (F/T RING TIME setting).
- Set whether the fax switches to receive mode after the ring time set in F/T RING TIME has elapsed (DEFAULT ACTION setting).

















Note

The default settings and selectable settings vary depending on the current country selection.

Different ways to receive a document

Follow the procedure below to set the Fax/Tel mode options.

- | | |
|---|---|
| <p>1 Press [Function].
 Press [Data Registration].</p> | <p>Function
 
 Data Registration
  DATA REGISTRATION</p> |
| <p>2 Press [Set].</p> | <p>Set
  USER SETTINGS</p> |
| <p>3 Use [^] or [v] to select RX SETTINGS.
 Press [Set].</p> | <p>  RX SETTINGS
 ^ v
 Set
  ECM RX</p> |
| <p>4 Use [^] or [v] to select FAX/TEL AUTO SW.
 Press [Set].</p> | <p>  FAX/TEL AUTO SW
 ^ v
 Set
  RING START TIME</p> |
| <p>5 Press [Set].</p> | <p>Set
  8SEC</p> |
| <p>6 Use the numeric buttons to enter the time the fax waits before ringing when it receives a call.</p> | <p> ~  9SEC</p> |
| <p>7 Press [Set] twice.</p> | <p>Set
  F/T RING TIME
 22SEC</p> |
| <p>8 Use the numeric buttons to enter the time the fax rings while waiting for someone to pick up the handset.</p> | <p> ~  30SEC</p> |

9 Press [Set] twice.

Set



DEFAULT ACTION

RECEIVE

10 Use [^] or [v] to select RECEIVE or DISCONNECT.

- This setting tells the fax what to do if the handset is not picked up within the specified ring time set in step 9.



DISCONNECT

11 Press [Set].

Set



INCOMING RING

12 Press [Stop].

Setting ends and the fax returns to standby mode.

Stop



Receiving documents manually: MANUAL MODE

In MANUAL MODE, if you connect the optional handset, a telephone or an extension phone to the fax, you can receive voice calls as well as manually activate reception of documents. You can activate reception from the fax or from the extension phone connected to the fax. This is called remote receiving.



Note

- For this mode, you need to connect the optional handset, a telephone or an extension phone to your fax. (see pp. 1-5, 1-6)
- Make sure the REMOTE RX setting is enabled. (see p. 8-5)

■ Setting MANUAL MODE

Follow the procedure below to set the receive mode to MANUAL MODE.

- 1 Press [Receive Mode] to select MANUAL MODE.

Receive Mode



MANUAL MODE
▼
15:00 Manual

After a few seconds, the LCD changes to this display:

■ Receiving a document manually

Follow the procedure below to receive a document manually.

- 1 Check that Manual is displayed on the LCD. (see above)

15:00	Manual
-------	--------

- 2 Check that the optional handset, a telephone or an extension phone is connected to the fax. (see pp. 1-5, 1-6)
- 3 When you hear the optional handset, telephone or extension phone ring, pick up the handset.

4

■ **If you hear a person's voice:**
Start your conversation. If the caller wants to send a document after talking to you, ask them to press the start button on their fax machine. When you hear a slow beep, press [Start] on the fax to begin receiving the document. Hang up the handset.

- If the extension phone is located away from your fax, dial the remote receiving ID on the extension phone and hang up. (see p. 8-5)
- The fax begins receiving the document.

■ **If you hear a slow beep tone:**
Someone is trying to send you a document. Press [Start] on the fax to begin receiving the document. Hang up the handset.

- If the extension phone is located away from your fax, dial the remote receiving ID on the extension phone and hang up. (see p. 8-5)
- The fax begins receiving the document.



Note

Be sure to hang up the handset after you press [Start] otherwise the call will be disconnected.

Receiving documents with an answering machine: ANS.MACHINE MODE

Connecting an answering machine to your fax allows you to receive documents and telephone messages while you are out.

In ANS.MACHINE MODE, your fax allows the answering machine to answer incoming calls, then listens for the fax tone and automatically receives the document if it detects this tone.



For this mode, you need to connect an answering machine to your fax. (see pp. 1-5, 1-6)

■ Setting ANS.MACHINE MODE

Follow the procedure below to set the receive mode to ANS.MACHINE MODE.

- 1 Press [Receive Mode] to select ANS.MACHINE MODE.

Receive Mode



ANS.MACHINE MODE



15:00 AnsMode

After a few seconds, the LCD changes to this display:

■ Using your fax with an answering machine

Follow these guidelines when using your fax with an answering machine.

- Set the answering machine to answer on the first or second ring.
- When recording an outgoing message on the answering machine:
 - The entire message must be no longer than 15 seconds. For example:
“Hello. I can’t answer the phone right now, but please leave a message after the beep. I’ll return your call as soon as possible.”

Other features

Receiving documents while performing other tasks

Your fax is a multitasking device so it can receive documents and voice calls while you are performing other tasks.

If you receive a document while performing certain tasks, the fax stores the incoming document in memory. As soon as you finish your task, the fax automatically prints the document.

Receiving documents in memory when a problem occurs

If your fax encounters a problem when receiving a document, it automatically stores the unprinted pages in memory, and the LCD displays REC'D IN MEMORY as well as one or more messages. For an explanation of the message(s) and details on the action to take, see p. 9-18



Note

- The fax memory can store up to approximately 42 pages.*
- You can set the fax not to store documents in memory if a problem occurs during reception. (see MEMORY RX, p. 8-5)
- Once the pages are printed, they are deleted from memory.
- If the memory becomes full, you will not be able to receive the remaining pages. Contact the sending party and ask them to resend the remainder of the document.

* Based on Canon FAX Standard Chart No. 1, standard mode.

Polling to receive documents

The polling feature allows you to request a document to be faxed to you from another fax machine. The sending party only needs to make sure the document is on a fax machine and ready to be sent. Thus, when your fax polls the other fax machine, the document is sent automatically. The fax can poll any fax machine that supports polling.



Note

- Before attempting to poll a fax machine, make sure that the other fax machine supports polling.
- Your fax cannot be polled by another fax machine.

Follow the procedure below to poll another fax machine.

- | | | |
|----------|--|---|
| 1 | <p>Press [Function].</p> <p>Press [Polling].</p> | <p>Function</p> <p><input checked="" type="radio"/></p> <p><input type="radio"/></p> <p>Polling</p> <p>POLLING RX</p> |
| 2 | <p>Press [Set].</p> | <p>Set</p> <p><input type="radio"/></p> <p>TEL=</p> |
| 3 | <p>Dial the fax number of the fax machine you wish to poll.</p> <p>Use one of the dialling methods described on page 6-4. If necessary, press [Function] to turn its light off.</p> | <p>TEL= 34567890</p> |
| 4 | <p>Press [Start].</p> <p>Your fax begins receiving the document.</p> | <p>Start / Resume</p> <p><input type="button" value="↕"/></p> <p>TX/RX NO. 0047</p> |



Note

- If the other party is using a Canon fax machine which has the Polling ID function, ask them to set the Polling ID of their fax machine to 255 (11111111 binary number). For details on the Polling ID, see the other party's fax machine manual. In all other cases the Polling ID is not a concern.

Cancelling receiving

Follow the procedure below if you want to stop receiving a document before reception is completed.

1 Press [Stop].

The fax asks you to confirm that you want to cancel receiving.



CANCEL? *YES #NO

YES=(*) NO=(#)

2 Press [*] to cancel receiving.

- Receiving is not cancelled until you press [*].
- If you change your mind and want to continue receiving, press [#].

















TX/RX CANCELLED

TX/RX NO. 5003

Receiving restriction

Follow the procedure below to turn restricted receiving on and off.

- | | |
|---|--|
| <p>1 Press [Function].
Press [Data Registration].</p> | <p>Function
</p> <p>Data Registration
</p> <p>DATA REGISTRATION</p> |
| <p>2 Press [Set].</p> | <p>Set
</p> <p>USER SETTINGS</p> |
| <p>3 Use [^] or [v] to select RX SETTINGS.
Press [Set].</p> | <p> </p> <p>^ v</p> <p>Set
</p> <p>RX SETTINGS
ECM RX</p> |
| <p>4 Use [^] or [v] to select RX RESTRICTION.
Press [Set].</p> | <p> </p> <p>^ v</p> <p>Set
</p> <p>RX RESTRICTION
OFF</p> |
| <p>5 Use [^] or [v] to select ON or OFF.
– OFF
Your fax will receive all documents.
– ON
Your fax will receive a document only under the receiving conditions.</p> | <p> </p> <p>^ v</p> <p>Set
</p> <p>ON</p> |
| <p>■ If you selected OFF in step 5:</p> | |
| <p>6 Press [Set].</p> | <p>Set
</p> <p>PRINTER SETTINGS</p> |
| <p>7 Press [Stop].
Registration ends and the fax returns to standby mode.</p> | <p>Stop
</p> |

■ If you selected ON in step 5:

6 Press [Set] twice.

Set



RX CONDITION

WITH SENDER INFO

7 Use [^] or [v] to select the receiving conditions.

• You can select from the following:

– WITH SENDER INFO

When the sender has registered their fax number on their machine, your fax will receive the document.

– REGISTERED SENDER

When the sender has registered their fax number on their machine, and the sender's fax number is registered in a speed dialling button on your fax, your fax will receive the document.



REGISTERED SENDER

8 Press [Set].

Set



PRINTER SETTINGS

9 Press [Stop].

Registration ends and the fax returns to standby mode.

Stop



8

SETTINGS AND ACTIVITY REPORTS



Selecting a menu	8-2
Activity reports	8-7
How to print a report	8-7
Activity report	8-8
One-touch speed dialling list	8-9
Coded speed dialling list	8-9
Group dialling list	8-9
User's data list	8-10
Doc. memory list	8-10
TX (Transmission) report	8-11
RX (Reception) report	8-12
Multi TX/RX (Transaction) report	8-12
Restricting use of the fax	8-13
Locking the fax	8-13
Changing the access password	8-14
Cancelling the restriction setting	8-15

Selecting a menu



The USER SETTINGS, REPORT SETTINGS, TX SETTINGS, RX SETTINGS, PRINTER SETTINGS, and SYSTEM SETTINGS menus allow you to customise the way your fax works. Each menu contains settings that control different functions of your fax.

Follow the procedure below to access the different menus.

- 1** Press [Function].
Press [Data Registration].



Function

Data registration
 DATA REGISTRATION
- 2** Press [Set].

Set
 USER SETTINGS
- 3** Use [^] and [v] to scroll through the menus and select the menu you want.
You can select the USER SETTINGS, REPORT SETTINGS, TX SETTINGS, RX SETTINGS, PRINTER SETTINGS or SYSTEM SETTINGS menu. (see pp. 8-3 to 8-6)

 
^ v TX SETTINGS
- 4** Press [Set] to access the settings under the menu you selected.

Set
 ECM TX
- 5** See the tables on the following pages (see pp. 8-3 to 8-6) for guidelines on selecting and registering settings.

 - Use [^] and [v] to scroll through the settings.
 - To register a setting or access a sub-setting, press [Set].
 - To return to a previous level, press [Data Registration].

 
^ v AUTO REDIAL
- 6** Press [Stop].
Setting ends and the fax returns to standby mode.

Stop



Note

- If at any stage you want to return to standby mode, press [Stop].
- If you pause for more than 60 seconds while accessing a menu, the fax will automatically return to standby mode.



The default settings and selectable settings vary depending on the current country selection. The values shown here are average values.

USER SETTINGS

For details on accessing the settings below, see p. 8-2.

Name	Description	Settings
DATE & TIME	Set the date and time (24-hour clock) using the numeric buttons.	-
UNIT TELEPHONE #	Enter your fax number using the numeric buttons.	-
UNIT NAME	This is the name that appears at the top of each fax page you send. (see p. 2-8)	-
TX TERMINAL ID	This option sets the parameters for the identification header that appears on every page you send.	ON/OFF
TTI POSITION	Select the position of the TTI. INSIDE IMAGE: Position the TTI inside the image area. OUTSIDE IMAGE: Position the TTI outside the image area.	INSIDE IMAGE/ OUTSIDE IMAGE
TELEPHONE # MARK	Select the prefix for the telephone/fax number.	TEL/FAX
SCAN CONTRAST	Set the density of the reproduction. Set DARKER for light originals and LIGHTER for dark originals.	STANDARD/DARKER/ LIGHTER
OFFHOOK ALARM	Enable/disable the off hook alarm. The alarm alerts you that the optional handset is not seated properly in its cradle.	ON/OFF
VOLUME CONTROL	Set the volume of the fax sounds.	-
CALLING VOLUME	Set the volume of the ring produced when the fax detects a voice call when Fax/Tel mode is set.	1/2/3
KEYPAD VOLUME	Set the volume of the keypad.	0 (off)/1/2/3
ALARM VOLUME	Set the volume of the error alarm sound.	0 (off)/1/2/3
LINE MONITOR VOL	Set the volume of the line monitor (sound during dialling).	0 (off)/1/2/3
RX CALL LEVEL	Set the ring tone.	STANDARD/HIGH
TEL LINE TYPE	Set the dialling method the fax uses to match the type of phone line you have.	TOUCH TONE/ ROTARY PULSE
R-KEY SETTING	Set the type of line to which your fax is connected.	PSTN/PBX
PSTN	Your fax is connected directly to an outside line.	-
PBX: ACCESS TYPE	Your fax is connected through a PBX. You can set the PBX type to PREFIX, HOOKING or EARTH CONNECTION.	EARTH CONNECTION/ PREFIX/HOOKING
ACCESS NUMBER	If you select PREFIX, you can enter an outside line access number of up to 19 digits.	-

REPORT SETTINGS

For details on accessing the settings below, see p. 8-2.

Name	Description	Settings
TX REPORT	Enable/disable automatic printing of the transmission report. OUTPUT YES: Set the fax to print an activity report every time you send a document. PRINT ERROR ONLY: Print only when an error occurs during sending. OUTPUT NO: Turn off the activity report feature.	OUTPUT NO/ PRINT ERROR ONLY/ OUTPUT YES
PRINT WITH IMAGE	When you set TX REPORT to OUTPUT YES or PRINT ERROR ONLY, you can add to the TX report half of the first page of the document that was being sent. This can help remind you which document was being sent. Valid only for memory sending.	ON/OFF
RX REPORT	Enable/disable automatic printing of the reception report. OUTPUT YES: Set the fax to print an activity report every time you receive a document. PRINT ERROR ONLY: Print only when an error occurs during receiving. OUTPUT NO: Turn off the activity report feature.	OUTPUT NO/ PRINT ERROR ONLY/ OUTPUT YES
ACTIVITY REPORT	Enable/disable automatic printing of the activity report.	-
AUTO PRINT	When you set ON, your fax is set to print an activity report for every 20 transactions (sending and receiving).	ON/OFF

TX SETTINGS

For details on accessing the settings below, see p. 8-2.

Name	Description	Settings
ECM TX	Enable/disable error correction during transmission.	ON/OFF
MID PAUSE SET	Set the length of the pause you insert into a dialling sequence.	4 seconds (1 to 15)
AUTO REDIAL	Determine whether the fax will redial a number if it fails to get a response on the first attempt.	ON/OFF
REDIAL TIMES	Set the number of retries.	2 times (1 to 10)
REDIAL INTERVAL	Set the period of time between redialling attempts.	2 minutes (1 to 99)
TIME OUT	Enable/disable automatic scanning of documents after the fax number is entered. When you set ON, scanning begins automatically 5 seconds after you enter the fax number.	ON/OFF

RX SETTINGS

For details on accessing the settings below, see p. 8-2.

Name	Description	Settings
ECM RX	Enable/disable error correction during reception.	ON/OFF
FAX/TEL AUTO SW	Set the receive mode options. You can set RING START TIME, F/T RING TIME and DEFAULT ACTION. (see p. 7-4)	
INCOMING RING	When the optional handset, a telephone or an extension phone is connected, set the fax to ring when it receives a call.	ON/OFF
RING COUNT	Set the number of incoming rings before the fax answers.	2 times (1 to 99)
MAN/AUTO SWITCH	Determine if the fax switches to document receive mode after the fax rings for a specified time when the fax is in the manual receive mode.	ON/OFF
F/T RING TIME	Set the amount of time the fax will ring before switching to document receive mode.	15 seconds (1 to 99)
REMOTE RX	Enables/disables remote receiving.	ON/OFF
REMOTE RX ID	If you set REMOTE RX to ON, you can select the remote receiving ID.	25 (00 to 99)
MEMORY RX	Turn on/off memory receiving of a document.	ON/OFF
RX RESTRICTION	Enables/disables receiving restriction.	ON/OFF
RX CONDITION	If you select ON above, you can select the receiving condition. WITH SENDER INFO: When the sender has registered their fax number on their machine, your fax will receive the document. REGISTERED SENDER: When the sender has registered their fax number on their machine, and the sender's fax number is registered in a speed dialling button on your fax, your fax will receive the document.	WITH SENDER INFO/ REGISTERED SENDER

PRINTER SETTINGS

For details on accessing the settings below, see p. 8-2.

Name	Description	Settings
RX REDUCTION	Enable/disable reduction for received documents.	ON/OFF
REDUCE DIMENSION	Select reduction in height only or both width and height.	VERTICAL ONLY/ HORIZ & VERTICAL
PAPER SIZE	Select the size of the loaded fax paper.	A4/LTR/LGL
ECONOMY PRT	Enable/disable economy printing (ink saving feature).	ON/OFF

SYSTEM SETTINGS

For details on accessing the settings below, see p. 8-2.

Name	Description	Settings
UNLOCK PHONE	Restrict sending with a password.	-
PASSWORD	Set a four-digit password to restrict access to the LOCK PHONE setting below.	0000 to 9999
LOCK PHONE	Restrict sending.	ON/OFF
DATE SETUP	Set the date format.	YYYY MM/DD MM/DD/YYYY DD/MM YYYY
DISPLAY LANGUAGE	Set the language of the LCD messages.	ENGLISH/FRENCH/ SPANISH/GERMAN/ ITALIAN/DUTCH/ FINNISH/ PORTUGUESE/ NORWEGIAN/SWEDISH /DANISH/SLOVENE/ CZECH/HUNGARIAN/ RUSSIAN
TX START SPEED	Set the speed at which the fax starts transmitting. Set this to a lower speed if you have difficulties connecting over long distance or noisy lines.	14400bps/9600bps/ 7200bps/4800bps/ 2400bps
RX START SPEED	Set the speed at which the fax starts receiving. Set this to a lower speed if you have difficulties connecting over long distance or noisy lines.	14400bps/9600bps/ 7200bps/4800bps/ 2400bps
COUNTRY SELECT*	Select the country where you are using your fax. (Changing the country setting may cause other settings to change.)	UK/GERMANY/ FRANCE/ITALY/ SPAIN/HOLLAND/ DENMARK/ NORWAY/SWEDEN/ FINLAND/ AUSTRIA/ BELGIUM/ SWITZERLAND/ PORTUGAL/ IRELAND/ GREECE/ LUXEMBOURG/ HUNGARY/ CZECH/RUSSIA/ OTHERS

* This setting is only available for some countries.

Activity reports

Your fax keeps track of most of its sending and receiving operations. These operations can be printed out in the form of activity reports that can help you check the dates and times of fax transmissions and whether or not each transaction was successful.

How to print a report

Depending on the type of report, you can have the fax print the report automatically, or you can print it directly. The TX report, RX report, MULTI TX/RX report, and Memory clear report can only be printed automatically. See REPORT SETTINGS (p. 8-4) on how and when reports are printed automatically.

Follow the procedure below to print an ACTIVITY REPORT, SPEED DIAL LIST, USER DATA LIST or DOC. MEMORY LIST.

- 1** Press [Function].
Press [Report].



Function
Report

ACTIVITY REPORT
- 2** Use [^] or [v] to display the type of report you want to print.
You can select ACTIVITY REPORT, SPEED DIAL LIST, USER DATA LIST or DOC. MEMORY LIST.
Press [Set].



^ v
Set

SPEED DIAL LIST
- 3** If you chose SPEED DIAL LIST in step 2, use [^] or [v] to select the list you want to print.
You can select 1-TOUCH LIST (1-TOUCH SPD DIAL LIST), CODED DIAL LIST or GROUP DIAL LIST.
You can select the order in which you want destinations in the 1-TOUCH LIST or CODED DIAL LIST to be listed. (see p. 8-9)
Press [Set].



^ v
Set

1-TOUCH LIST

Activity report

Summarises the information for the sending and receiving activities of your fax after 20 transactions. For automatic printing see ACTIVITY REPORT, p. 8-4.

Transactions in an activity report are listed chronologically.

27/12 2001 15:00 FAX 123 4567		CANON				001	
***** *** ACTIVITY REPORT *** *****							
ST. TIME	CONNECTION	ID	NO.	MODE	PGS.	RESULT	
*27/12 13:43	905 795 1111	Canon CANADA	5001	AUTO RX	ECM	1	OK 00'33
*27/12 13:45	905 795 1111	Canon CANADA	5002	AUTO RX	ECM	1	OK 00'24
*27/12 13:51	03 3758 2111	Canon TOKYO	0001	B'CAST	ECM	3	OK 01'18
*27/12 14:05	2 887 0166	Canon AUSTRALIA	0001	B'CAST	ECM	3	OK 01'18
*27/12 14:10	905 795 1111	Canon CANADA	5003	AUTO RX	ECM	1	OK 00'18
*27/12 14:16	2 887 0166	Canon AUSTRALIA	5004	AUTO RX	ECM	4	OK 03'59
*27/12 14:27	20 545 8545	Canon EUROPA	0002	TRANSMIT	ECM	1	OK 01'20
*27/12 14:30	20 545 8545	Canon EUROPA	0003	TRANSMIT	ECM	1	OK 04'12
27/12 14:53	03 3758 2111	Canon TOKYO	5005	AUTO RX	ECM	1	OK 01'16
27/12 14:57	2 887 0166	Canon AUSTRALIA	0004	TRANSMIT	ECM	3	NG 01'25
27/12 14:59	1 432 2060	CANON OPTICS	0005	TRANSMIT		0	NG 00'01
						0	#018

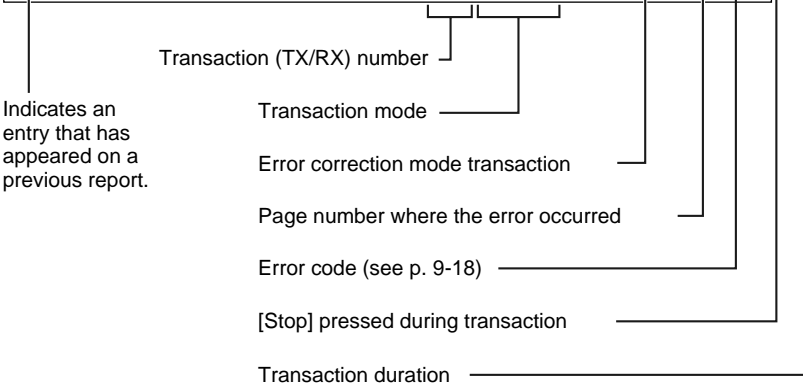

One-touch speed dialling list

Lists the numbers and names registered under one-touch speed dialling buttons.

NO.	CONNECTION	ID
[01]	905 795 1111	Canon AUSTRALIA
[03]	GROUP DIAL	Canon CANADA
[04]	2 509 21	Canon EUROPA
[05]	1 432 2060	Canon ITALIA
[06]	2 887 0166	Canon OPTICS

Unsorted list: Destinations listed in button order.

Sorted list: Destinations listed in alphabetical order.

Coded speed dialling list

Lists the numbers and names registered under coded speed dialling codes.

NO.	CONNECTION	ID
[* 00]	2131 1250	Canon DEUTCH.
[* 01]	03 3758 2111	Canon FRANCE
[* 02]	1 49 39 25 25	Canon GROUP 1
[* 03]	516p488 6700	Canon TOKYO
[* 21]	GROUP 1	Canon U.S.A.
[* 32]	81 773 3173	Canon UK

Unsorted list: Destinations listed in code order.

Sorted list: Destinations listed in alphabetical order.

Group dialling list

Lists groups registered under one-touch speed dialling buttons and coded speed dialling codes.

[03] Canon EUROPA	[04] 2 509 21	Canon ITALIA
	[* 00] 2131 1250	Canon DEUTSCH.
	[* 02] 1 49 39 25 25	Canon FRANCE
	[* 32] 81 773 3173	Canon UK
[* 21] Canon GROUP 1	[01] 905 795 1111	Canon CANADA
	[* 03] 516p488 6700	Canon U.S.A.

User's data list

Lists the current settings of the fax and the registered sender information.

27/12 2001 17:23 FAX 123 4567	CANON	001
***** *** USER'S DATA LIST *** *****		
1. USER SETTINGS		
UNIT TELEPHONE #		123 4567
UNIT NAME	CANON	
TX TERMINAL ID	ON	
TTI POSITION		OUTSIDE IMAGE
TELEPHONE # MARK		FAX
SCANNING CONTRAST		STANDARD
OFFHOOK ALARM		ON
VOLUME CONTROL		
CALLING VOLUME		
KEYPAD VOLUME	2	
ALARM VOLUME		2
LINE MONITOR VOL.		2
RX CALL LEVEL		
TYPE	HIGH	
	TOUCH TONE	

Doc. memory list

Lists the documents currently stored in the fax's memory. (see p. 6-13)

27/12 2001 23:42 FAX 123 4567	CANON	001			
***** *** DOC MEMORY LIST *** *****					
TX/RX NO	MODE	CONNECTION	PGS.	SET TIME	ST. TIME
0046	TRANSMIT	[* 01] Canon TOKYO	3	27/12 23:24	
0047	TRANSMIT	[04] Canon ITALIA	2	27/12 23:26	
0048	B'CAST	[01] Canon CANADA	1	27/12 23:38	
		[* 02] Canon FRANCE			
0049	DELAYED TX	0297772911	1	27/12 16:43	23:42

TX (Transmission) report

You can set the fax to print an activity report every time you send a document, or only when an error occurs during sending. See TX REPORT, p. 8-4.

27/12 2001 14:59 FAX 123 4567 CANON 001

*** TX REPORT ***

TRANSMISSION OK

TX/RX NO 0003
CONNECTION 1 432 2060

27/12 2001 14:59 FAX 123 4567 CANON 001

*** ERROR TX REPORT ***

TX FUNCTION WAS NOT COMPLETED

TX/RX NO 0004
CONNECTION 20 545 8545
ID Canon EUROPA
ST.TIME 27/12 14:59
USAGE T 00'00
PGS. SENT 0
RESULT NG #018 BUSY/NO SIGNAL

THE SLEREXE COMPANY LIMITED
SAPORS LANE • BOOLE • DORSET • BH25 8ER
TELEPHONE BOLLE (945 13) 51617 – FAX 123456

Our Ref. 350/PJC/EAC
Dr. P. N. Cundall,
Mining Surveys Ltd.,
Holroyd Road,
Reading
Berks.

27 December, 2001

OK: Transmission succesful
NG: Some or no pages sent

Number of pages sent

Transmission duration

Transmission time

If you enable the PRINT WITH IMAGE setting (see p. 8-4), the first page of the fax will print on the report to remind you of the contents of the fax.

RX (Reception) report

You can set the fax to print an activity report every time you receive a document, or only when an error occurs during receiving. See RX REPORT, p. 8-4.

27/12 2001 14:59 FAX 123 4567 CANON 001

```
*****  
***          RX REPORT          ***  
*****  
  
RECEPTION OK  
  
TX/RX NO          5004  
CONNECTION                905 795 1111  
ID          Canon CANADA  
ST.TIME        27/12 14:59  
USAGE T        01'59  
PGS.           4  
RESULT         OK
```

OK: Reception succesful
NG: Some or no pages received

Number of pages received
Reception duration
Reception time

Multi TX/RX (Transaction) report

Lists the results of a sequential broadcasting transmission.

27/12 2001 14:59 FAX 123 4567 CANON 001

```
*****  
***          MULTI TX/RX REPORT          ***  
*****  
  
TX/RX NO          0054  
PGS.              1  
TX/RX INCOMPLETE  
TRANSACTION OK   [ 01]905 795 1111      Canon CANADA  
                  [* 01]03 3758 2111    Canon TOKYO  
                  [* 02]1 49 39 25 25    Canon FRANCE  
  
ERROR INFORMATION
```

If you set the fax to print activity reports (TX REPORT or RX REPORT) and then use sequential broadcasting, a MULTI TX/RX REPORT will be printed instead of a TX (Transmission) REPORT. See TX REPORT, p. 8-4.



Note

A memory clear report is printed automatically when power is restored after a power failure. See Memory clear report, p. 9-23.

Restricting use of the fax

Use the lock feature of the fax to prevent unauthorised use of the fax.
To restrict access to the LOCK PHONE setting, you need to register a password. Set the password and LOCK PHONE setting as explained below.

Locking the fax

Follow the procedure below to restrict use of the fax.

- 1** Press [Function].
Press [Data Registration].

Function
Data registration

DATA REGISTRATION
- 2** Press [Set].

Set

USER SETTINGS
- 3** Use [^] or [v] to select SYSTEM SETTINGS.
Press [Set].

SYSTEM SETTINGS

Set

UN/LOCK PHONE
- 4** Press [Set] twice.
PASSWORD appears on the LCD.

Set

PASSWORD

PASSWORD= _
- 5** Enter a four-digit access password using the numeric buttons.
Press [Set] twice.

0 ~ 9

PASSWORD= 7777

Set

LOCK PHONE

OFF

6 Use [^] or [v] to select ON.

Press [Set].

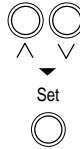

ON

7 Press [Stop].

Setting ends and the fax returns to standby mode.

Stop



Changing the access password

Follow the procedure below to change the access password.

1 Follow steps 1 to 3 on p. 8-13.

UN/LOCK PHONE

2 Press [Set].

PASSWORD appears on the LCD.

Set



PASSWORD _

3 Enter the current four-digit access password using the numeric buttons.

The password is not displayed as you enter it.

Press [Set] twice.



Set



PASSWORD

PASSWORD

PASSWORD= 7777

4 Enter a new four-digit access password using the numeric buttons.

Press [Set].



Set



PASSWORD= 8888

5 Press [Stop].

Setting ends and the fax returns to standby mode.

Stop



Cancelling the restriction setting

Follow the procedure below to cancel the restriction setting.

- 1** Follow steps 1 to 3 on p. 8-13.

UN/LOCK PHONE
- 2** Press [Set].
PASSWORD appears on the LCD.

Set
○

PASSWORD _
- 3** Enter the current four-digit access password using the numeric buttons.
The password is not displayed as you enter it.
Press [Set] four times.

0 ~ 9
▼
Set
○

PASSWORD

Set
○

PASSWORD

Set
○

PASSWORD= 8888

Set
○

LOCK PHONE

Set
○

ON
- 4** Use [^] or [v] to select OFF.
Press [Set].

○ ○
^ v
▼
Set
○

OFF
- 5** Press [Stop].
Setting ends and the fax returns to standby mode.

Stop
○

○

9

SOLUTIONS TO COMMON PROBLEMS

Clearing jams	9-2
Jams in the Automatic Document Feeder (ADF)	9-2
Jams in the multi-purpose tray	9-3
Periodic cleaning	9-4
Cleaning the exterior of the fax.....	9-4
Cleaning the interior of the fax.....	9-4
Testing and cleaning the BJ cartridge print head	9-7
Replacing the BJ cartridge	9-8
Troubleshooting	9-11
Paper feeding problems	9-11
Faxing problems	9-12
Copying problems.....	9-16
Telephone problems	9-16
Print quality problems	9-17
General problems	9-17
LCD messages	9-18
In case of a power failure	9-23
During a power failure	9-23
Memory clear report	9-23

Clearing jams

Jams in the Automatic Document Feeder (ADF)

When a document jams or misfeeds in the ADF, CHECK DOCUMENT is displayed on the LCD. Follow the procedure below to clear the document jam.



Note

You do not need to unplug the fax when clearing document jams.

1 Press [Stop].

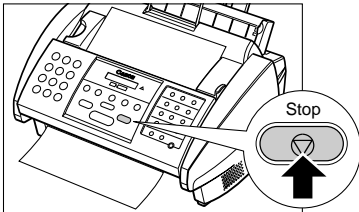

2 Open the operation panel partially by gently pulling it towards you.

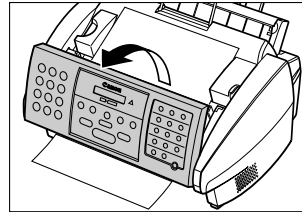

- It only opens slightly.
- Do not try to pull the document out without opening the operation panel since you may tear or smudge the document.

3 While holding the operation panel open, remove the document.

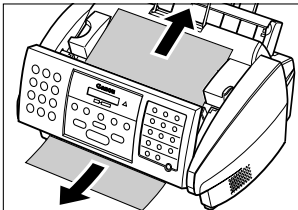

- Pull it gently in either direction.
- If a multipage document is loaded, remove the entire document from the ADF.

4 When you are finished, close the operation panel by pressing it down from the centre.

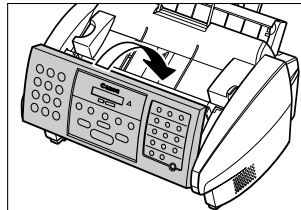

Be sure to close the operation panel until it locks into place, or the fax will not function properly.



Note

If the paper does not pull out easily, do not force it. Contact your local authorised Canon dealer or the Canon Help Desk.

Jams in the multi-purpose tray

If paper jams in the multi-purpose tray, CLEAR PAPER JAM is displayed on the LCD. Follow the procedure below to clear the jam.



You do not need to unplug the fax when clearing paper jams.

- 1** Gently pull any jammed paper out of the fax as shown.
- 2** Remove the paper stack from the multi-purpose tray and reload it. (see p. 1-12)

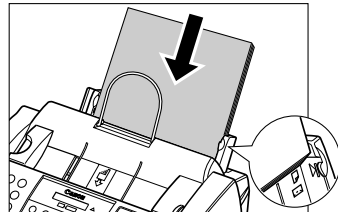
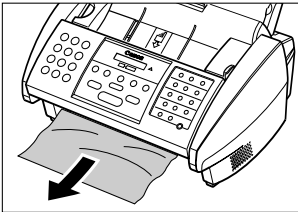

Make sure the stack does not exceed the paper limit mark (▶).

- 3** Press [Start].

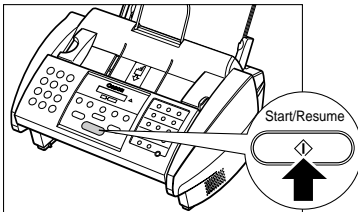

Periodic cleaning

Your fax requires little periodic maintenance. This section describes the necessary cleaning procedures for the fax. Please note the following before cleaning:

- Be sure to disconnect the power cord before cleaning the fax. Since documents in memory are erased when the power is disconnected, print any documents stored in memory before disconnecting the power cord. (see p. 6-13)
- Do not use tissue paper, paper towels, or similar materials for cleaning; they can stick to the components or generate static charges.



Never use volatile liquids such as thinners, benzene, acetone, or any other chemical cleaner to clean the interior of the fax; these can damage its components.

Cleaning the exterior of the fax _____

Follow the procedure below to clean the outer casing of the fax.

- 1** Disconnect the power cord from the fax.
- 2** Wipe the exterior of the fax with a clean, soft, lint-free cloth moistened with water or diluted dishwashing detergent solution.
- 3** When you are finished, reconnect the power cord.

Cleaning the interior of the fax _____

■ Cleaning inside the printer cover

To prevent ink spots and paper dust from accumulating inside the fax and affecting print quality, clean the print area of the fax periodically.

Follow the procedure below to clean inside the fax.

- 1** Disconnect the power cord from the fax.
- 2** Open the printer cover using the printer cover tab. (see p. 2-2)



Do not touch the components or any metal parts since this may adversely affect operation of the fax and/or affect print quality.

- 3** Use a clean, soft, dry, lint-free cloth to remove any ink or paper debris from the interior of the fax (shaded area), especially around the platen.

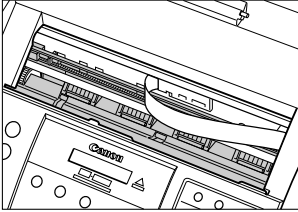

Be careful not to touch the BJ cartridge or its holder.

- 4** When you are finished, close the printer cover.

- 5** Reconnect the power cord.

■ Cleaning the scanner components

Follow the procedure below to periodically check and clean the scanner components.

- 1** Disconnect the power cord from the fax.
- 2** Open the operation panel partially by gently pulling it towards you.

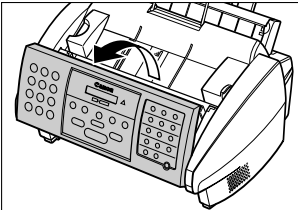

It only opens slightly.

- 3** While holding the operation panel open, clean these components:

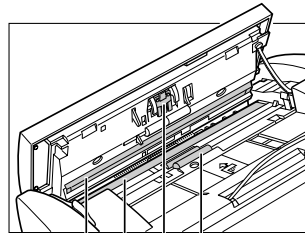

Separation roller
Separation guide
Scanning glass
White sheet

- **Separation guide and separation roller**
Wipe with a clean, soft, dry, lint-free cloth.
- **White sheet and scanning glass**
Wipe with a clean, soft, lint-free cloth moistened with water, then wipe with a clean, soft, dry, lint-free cloth.



- If the scanner components are dirty, the documents you send or copy will also be dirty.
- Be sure to use a soft cloth to avoid scratching the components.



Do not use tissue paper, paper towels, or similar materials for cleaning; they can stick to the components or generate static charges.

- 4 Use a clean, soft, dry, lint-free cloth to clean the shaded area of the operation panel**

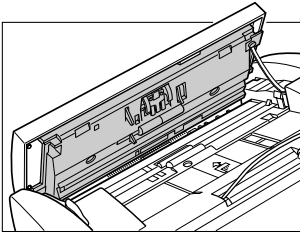

Dirt and dust particles that collect on the underside of the operation panel affect the quality of the documents you copy or send.

- 5 Use a clean, soft, dry, lint-free cloth to wipe up paper dust from the areas (shaded) surrounding the separation roller.**

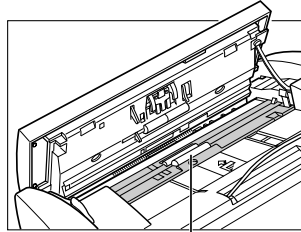

Separation roller

- 6 When you are finished, close the operation panel by pressing it down from the centre.**

Be sure to close the operation panel until it locks into place, or the fax will not function properly.

- 7 Reconnect the power cord.**

Testing and cleaning the BJ cartridge print head

The print head in the BJ cartridge contains nozzles through which ink is propelled onto the paper. To maintain the best possible print quality, these nozzles need to be cleaned from time to time. Your fax is equipped with a print head cleaning function that does this.

■ Printing the nozzle check pattern

Before cleaning the print head, you may want to print the nozzle check pattern to test the print head of the BJ cartridge installed in the fax. This test shows if each print head nozzle is operating properly.

Follow the procedure below to print the nozzle check pattern.

- 1** Press [Function].

Press [Cleaning].

Function

Cleaning

NOZZLE CHECK
- 2** Press [Set].

The fax prints the nozzle check pattern.

Set

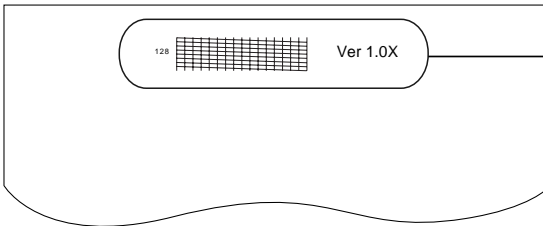

Nozzle check pattern
If the pattern is broken or missing, clean the BJ cartridge print head. (see p. 9-8)



Note Print the nozzle check pattern again after cleaning the BJ cartridge print head to check if cleaning corrected the problem.

■ Cleaning the BJ cartridge print head

If your printouts become faint or streaked, or if their quality otherwise deteriorates, print the nozzle check pattern to see if the print head nozzles are operating properly (see p. 9-7). If the pattern is broken or missing, clean the BJ cartridge print head.



Note

- To maintain the best possible print quality, clean the BJ cartridge print head from time to time.
- Cleaning the print head consumes a small amount of ink. Cleaning too often reduces the amount of ink in the BJ cartridge.

Follow the procedure below to clean the BJ cartridge print head.

1

Press [Function].

Press [Cleaning].

Function



Cleaning

NOZZLE CHECK

2

Use [^] or [v] to select HEAD CLEANING.



HEAD CLEANING

3

Press [Set].

The fax cleans the print head.

Set



Note

- You can clean the print head up to five consecutive times if necessary.
- After cleaning, print the nozzle check pattern to check if cleaning corrected the problem. (see p. 9-7)
- If cleaning does not improve print quality, replace the BJ cartridge (see below).

Replacing the BJ cartridge

This section describes how to replace the BJ cartridge.



Note

Do not replace the BJ cartridge while the fax is printing or performing another operation.

Follow the procedure below to replace the BJ cartridge.

1

Make sure the fax is plugged in.

2 Open the printer cover using the printer cover tab. (see p. 2-2)

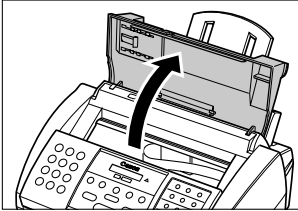

3 Press [Cartridge].

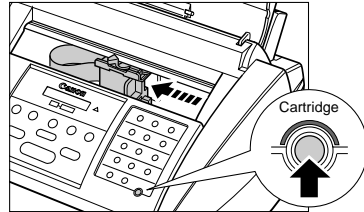

- Do not try to manually move or stop the cartridge holder since this may damage the fax.
- Do not touch the components shown or any metal parts since this may adversely affect operation of the fax and/or affect print quality.
- The fax has an automatic protection feature that helps keep it from overheating. If the cartridge holder does not move, unplug the fax and let it cool for several minutes. Then plug it in again and press [Cartridge] to move the cartridge holder.

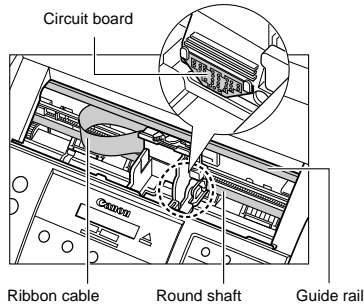

4 Raise the blue cartridge lock lever on the cartridge holder and remove the BJ cartridge.

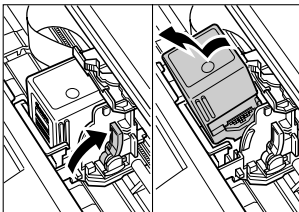

5 Remove the new BJ cartridge from its package, then remove the orange protective cap ① and tape ②.

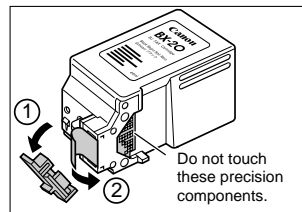

- Discard the old BJ cartridge immediately according to the local laws and regulations for disposal of consumables. You may want to place it in a plastic bag to keep any residual ink from spilling.
- Spilled ink can stain any surface; protect yourself and your work area.

- Discard the cap and tape. Never attempt to reattach them to the BJ cartridge print head.
- Install the BJ cartridge immediately after removing the cap and tape.
- Spilled ink can stain any surface; protect yourself and your work area.

6 With the label facing outwards, insert the BJ cartridge into the cartridge holder. Lower the blue cartridge lock lever until it locks into position.

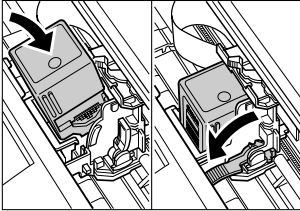

7 Press [Cartridge].

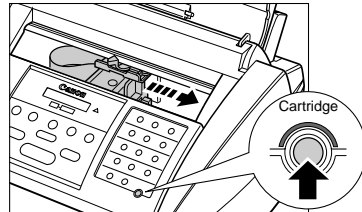

The cartridge holder moves to its home position on the right side of the fax and begins cleaning the BJ cartridge print head. This process takes about 40 seconds.



Caution

Do not try to manually move or stop the cartridge holder since this may damage the fax.

8 Close the printer cover.



Note

If you need to unplug the fax, wait until it is in standby mode (time and receive mode displayed on the LCD). Otherwise the cartridge holder may not be in its home position, causing the BJ cartridge to remain uncapped and dry out.

Troubleshooting

Paper feeding problems

Paper does not load.

The multi-purpose tray may contain too many sheets.

- Make sure the paper stack in the multi-purpose tray does not exceed the paper limit mark (▶). (see p. 1-11)

Paper may not be loaded correctly.

- Make sure the paper stack is loaded properly in the multi-purpose tray, and that the paper guide is adjusted correctly. (see p. 1-11)

Paper is loaded skewed. (Printing is skewed.)

Paper may not be loaded correctly.

- Make sure the right edge of the paper stack is aligned with the right side of the multi-purpose tray and the paper guide is aligned with the left edge of the stack. (see p. 1-11)
- Make sure the paper exit path is clear.

Multiple sheets load into the fax at the same time.

Paper may not be loaded correctly.

- Make sure the paper stack is loaded properly in the multi-purpose tray, and that the paper guide is adjusted correctly. (see p. 1-11)

Sheets of paper may be sticking together.

- Be sure to fan the paper stack before loading it in the multi-purpose tray. This keeps the sheets of paper from sticking together. (see p. 1-12)

The multi-purpose tray may contain too many sheets.

- Make sure the paper stack in the multi-purpose tray does not exceed the paper limit mark (P). (see p. 1-11)
- Do not exceed the maximum loading capacity of the multi-purpose tray. (see p. 4-2)
- Do not force the paper stack into the multi-purpose tray.

Different types of paper may be loaded in the multi-purpose tray.

- Load only one type of paper.
- Make sure you load paper that meets the paper requirements for the fax. (see pp. 1-11, 4-2)

Repeated paper jams occur.

The paper you are using may be causing the jams.

- Be sure to fan the paper stack before loading it in the multi-purpose tray. This keeps the sheets of paper from sticking together. (see p. 1-12)
- Check that the paper you are using and your printing environment (see pp. 1-11, S-1) are within the specifications of the fax. (see pp. 1-11, 4-2)

Faxing problems

Sending problems

❑ You cannot send a document.

The fax may have overheated.

- Unplug the fax and let it cool for several minutes. Then plug it back in and try sending again.

The fax may not be set for the type of telephone line in use (pulse/tone).

- Make sure the fax is set for the correct telephone line type. (see p. 1-13)

The document may not have been loaded correctly into the Automatic Document Feeder (ADF).

- Remove the document, stack it if necessary, and load it into the ADF correctly. (see p. 3-3)
- Make sure the operation panel is closed.

The one-touch speed dialling button or coded speed dialling code you entered may not be registered for the feature you want to use.

- Check the one-touch speed dialling button or coded speed dialling code and make sure it is registered correctly. (see Chapter 2)

You dialled or have been provided with an incorrect number.

- Dial the number again, or check that you have the correct number.

The receiving party's fax machine may be out of paper.

- Call the receiving party and ask them to make sure paper is loaded in their fax machine.

There may be other documents being sent from memory.

- Allow time for those documents to finish sending.

An error may have occurred during sending.

- Print an activity report and check for an error. (see pp. 8-7, 8-8)

The telephone line may not be working properly.

- Make sure there is a dial tone when you press [Hook] or when you lift the handset of any external devices connected to the fax. If there is no dial tone, contact your local telephone company.

The receiving fax machine may not be a G3 fax machine.

- Make sure the receiving fax machine is compatible with the fax (which is a G3 fax machine).

❑ Documents sent from the fax are spotted or dirty.

The receiving fax machine may not be working properly.

- Check the fax by making a copy (see p. 5-2). If the copy is clear, the problem may be in the receiving fax machine. If the copy is spotted or dirty, clean the scanner components. (see p. 9-5)

The document may not have been loaded correctly into the ADF.

- Remove the document, stack it if necessary, and load it into the ADF correctly. (see p. 3-3)

❑ **Cannot send using Error Correction Mode (ECM).**

The receiving party's fax machine may not support ECM.

- If the receiving party's fax machine does not support ECM, then the document is sent in normal mode without error checking.

ECM may be disabled.

- Make sure ECM is on. (see ECM TX, p. 8-4)

❑ **Errors occur frequently while sending.**

The telephone lines may be in poor condition, or you may have a bad connection.

- Lower the transmission speed. (see TX START SPEED, p. 8-6)

Receiving problems

❑ **Cannot receive a document automatically.**

The fax may not be set to receive automatically.

- For the fax to receive faxes automatically, the receive mode must be set to FAX ONLY MODE, FAX/TEL AUTO SW (Fax/Tel mode), or ANS.MACHINE MODE (see Chapter 7). If you have set ANS.MACHINE MODE, check that an answering machine is connected to the fax and that it is turned on with an outgoing message properly recorded. (see p. 7-9)

The fax may have a document stored in memory.

- Print or delete any documents stored in memory. (see pp. 6-13, 6-14)

An error may have occurred during reception.

- Check the LCD for an error message. (see p. 9-18)
- Print an activity report and check for an error. (see pp. 8-7, 8-8)

The multi-purpose tray may be empty.

- Make sure paper is loaded in the multi-purpose tray. (see p. 1-11)

The telephone line may not be connected properly.

- Make sure all line connections are secure. (see pp. 1-5, 1-6)

❑ The fax does not switch automatically between telephone and fax reception.

The fax may not be set to switch automatically between telephone and fax reception.

- For the fax to switch automatically, the receive mode must be set to FAX/TEL AUTO SW (Fax/Tel mode) or ANS.MACHINE MODE (see Chapter 7). If you have set ANS.MACHINE MODE, check that an answering machine is connected to the fax and that it is turned on with an outgoing message properly recorded. (see p. 7-9)

An error may have occurred during reception.

- Check the LCD for an error message. (see p. 9-18)
- Print an activity report and check for an error. (see pp. 8-7, 8-8)

The multi-purpose tray may be empty.

- Make sure paper is loaded in the multi-purpose tray. (see p. 1-11)

The sending fax machine may not send the CNG signal that tells the fax that the incoming signal is a fax.

- Some fax machines cannot send the CNG signal that tells your fax the incoming call is a fax. In such cases, you will have to receive the document manually. (see p. 7-7)

❑ Cannot receive a document manually.

You may have disconnected the call by pressing [Start] or dialling the remote receiving ID after hanging up the handset of the extension phone.

- Always press [Start] or dial the remote receiving ID before hanging up the handset, otherwise you will disconnect the call.

❑ Print quality is poor.

You may not be using the correct type of paper.

- Make sure you load paper that meets the paper requirements for the fax. (see pp. 1-11, 4-2)

The BJ cartridge print head may need cleaning.

- Clean the BJ cartridge print head if necessary. (see p. 9-8)

The sending fax machine may not be functioning properly.

- The sending fax machine usually determines the quality of the document. Call the sender and have them make sure the top cover and scanning glass of their fax machine are clean.

Error Correction Mode (ECM) may be disabled.

- Make sure ECM is on. (see ECM RX, p. 8-5)

❑ **Faxes do not print.**

The BJ cartridge may not be installed properly.

- Make sure the BJ cartridge is installed properly. (see p. 1-9)
- Be sure to remove the orange protective tape from the BJ cartridge before you install it. (see p. 1-9)

The BJ cartridge print head may need cleaning.

- Clean the BJ cartridge print head if necessary. (see p. 9-8)

The BJ cartridge may need to be replaced.

- Determine if the problem is with the BJ cartridge and replace if necessary. (see p. 9-8)

❑ **Fax images print blotched or uneven.**

The telephone lines may be in poor condition, or you may have a bad connection.

- Error Correction Mode (ECM) sending/receiving should eliminate such problems. However, if the telephone lines are in poor condition, you may have to try again.

The sending fax machine may not be functioning properly.

- The sending fax machine usually determines the quality of the document. Call the sender and have them make sure the top cover and scanning glass of their fax machine are clean.

❑ **Cannot receive using Error Correction Mode (ECM).**

The sending fax machine may not support ECM.

- If the sending fax machine does not support ECM, then the document is received in normal mode without error checking.

ECM may be disabled.

- Make sure ECM is on. (see ECM RX, p. 8-5)

❑ **Errors occur frequently while receiving.**

The telephone lines may be in poor condition, or you may have a bad connection.

- Lower the reception speed. (see RX START SPEED, p. 8-6)

The sending fax machine may not be functioning properly.

- Call the sender and have them check that their fax machine is functioning properly.

Copying problems

❑ The fax will not make a copy.

The BJ cartridge may need to be replaced.

- Determine if the problem is with the BJ cartridge and replace if necessary. (see p. 9-8)

The document may not have been loaded correctly into the Automatic Document Feeder (ADF).

- Remove the document, stack it if necessary, and load it into the ADF correctly. (see p. 3-3)
- Make sure the operation panel is closed.

The BJ cartridge may not be installed properly.

- Make sure the BJ cartridge is installed properly. (see p. 1-9)

The fax may not be operating properly.

- Print the nozzle check pattern. (see p. 9-7)

❑ MEMORY FULL appears on the LCD when making multiple copies.

The fax's memory is full.

- Print or delete any documents stored in memory (see pp. 6-13, 6-14) to free up space in the fax's memory, then start again.

The document you are copying may have too many graphics.

- If multiple pages are being copied, separate the pages into smaller stacks. If not, make the desired number of copies one at a time as needed.



For additional troubleshooting, see Print quality problems, p. 9-17.

Telephone problems

❑ You cannot dial.

The telephone line may not be connected properly.

- Make sure all line connections are secure. (see pp. 1-5, 1-6)

The power cord may not be plugged in securely.

- Check that the power cord is plugged securely into the fax and into the wall outlet (see p. 1-7). If the fax is plugged into a power strip, make sure the power strip is plugged in and turned on.

The fax may not be set for the type of telephone line in use (pulse/tone).

- Make sure the fax is set for the correct telephone line type. (see p. 1-13)

❑ The optional handset, telephone, or extension phone disconnects while you are talking.

The power cord may not be plugged in securely.

- Check that the power cord is plugged securely into the fax and into the wall outlet (see p. 1-7). If the fax is plugged into a power strip, make sure the power strip is plugged in and turned on.

❑ There is interference on the line.

A mobile phone or cordless phone may be in use near the fax.

- Make sure that mobile phones and cordless phones are not used near the fax.

Print quality problems

- ❑ **The print quality is not what you expect; print is not clear, is splashed, or blurred, has missing dots or white streaks.**

The paper you are using may not be supported by the fax.

- Make sure you are using the recommended paper. (see pp. 1-11, 4-2)

You may be printing on the wrong side of the paper.

- Some papers have a “right” side for printing. If the print quality is not as clear as you would like it to be, try turning the paper over and printing on the other side.

The nozzles on the BJ cartridge print head may be clogged.

- Clean the BJ cartridge print head if necessary. (see p. 9-8)

The BJ cartridge may not be installed properly.

- Make sure the BJ cartridge is installed properly. (see p. 1-9)

The BJ cartridge may need to be replaced.

- Determine if the problem is with the BJ cartridge and replace if necessary. (see p. 9-8)

The BJ cartridge print head may be damaged.

- Determine if the problem is with the BJ cartridge print head (see p. 9-8) and replace the BJ cartridge if necessary. (see p. 9-8)

General problems

- ❑ **The fax has no power.**

The power cord may not be plugged in securely.

- Check that the power cord is plugged securely into the fax and into the wall outlet (see p. 1-7). If the fax is plugged into a power strip, make sure the power strip is plugged in and turned on.

The power cord may not be supplying power.

- Check the power cord by substituting with another, or by using a voltmeter to test it for continuity.

- ❑ **The fax will not print reports.**

The BJ cartridge may need to be replaced.

- Determine if the problem is with the BJ cartridge and replace if necessary. (see p. 9-8)

- ❑ **Nothing appears on the LCD.**

The power cord may not be plugged in securely.

- Check that the power cord is plugged securely into the fax and into the wall outlet (see p. 1-7). If the fax is plugged into a power strip, make sure the power strip is plugged in and turned on. If the LCD remains blank, unplug the fax, wait five seconds, then plug it in again.

LCD messages

The following messages are displayed on the LCD when the fax is performing a function or encounters an error. The error code appears in the activity report. (see p. 8-8)

Message	Error Code	Cause	Action
AUTO REDIAL	–	The fax is waiting to redial the receiving number because the line was busy or the receiving party did not answer when you tried to send the document.	Wait for the fax to automatically redial the number. If you want to cancel automatic redialling, wait until the fax starts dialling the number, press [Stop] and then press [*] (see p. 6-10) or delete the document from memory. (see p. 6-14)
BLACK INK EMPTY (FAX-B180C only)	–	The Black BJ tank in the Colour BJ cartridge is empty or its ink may have dried out.	Clean the BJ cartridge print head (see p. 9-8). If the message remains in the LCD, replace the Black BJ tank. (see Printer Guide)
BUSY/NO SIGNAL	#018	The telephone number you dialled is busy. The fax number dialled was incorrect. The other party's fax machine is not working. The other party is not using a G3 machine. The touch tone/rotary pulse setting on your fax is incorrect. The receiving fax machine did not answer within 55 seconds (after all automatic redialling attempts).	Try sending the document at a later time. Check the fax number and dial again. Contact the other party and have them check their fax machine. Contact the other party and ask them to send or receive the document using a G3 machine. Set your fax to the setting that matches your telephone line. (see p. 1-13) Contact the receiving party and have them check their fax machine. You can try to send the document using manual sending via the handset (see p. 6-6). For an overseas call, add pauses to the registered number. (see p. 2-19)

Message	Error Code	Cause	Action
CARTRIDGE JAMMED	–	The cartridge holder cannot move. This is normally due to a paper jam.	Clear the paper jam or whatever is obstructing the cartridge holder and then press [Start] and start again. Do not attempt to move the cartridge holder manually.
CHANGE CARTRIDGE	–	You pressed [Cartridge] and the cartridge holder is moving to the centre of the fax. The BJ cartridge is empty or its ink may have dried out.	Wait until the cartridge holder stops, then replace the BJ cartridge (see p. 9-8). When you are finished, press [Cartridge] and close the printer cover. Wait for the fax to return to standby mode. Clean the BJ cartridge print head (see p. 9-8). If the message remains on the LCD, replace the BJ cartridge (see p. 9-8). The fax will then print automatically any documents received in memory.
CHECK DOCUMENT	#001	The document is jammed in the Automatic Document Feeder (ADF).	Remove the document you are trying to send or copy (see p. 9-2) and start again.
CHECK PAPER SIZE	–	The size of the paper in the multi-purpose tray and that specified in the PAPER SIZE setting are different.	Load the correct paper size or change the PAPER SIZE setting. (see p. 8-5)
CHECK PRINTER	–	There may be an obstruction that is not allowing the cartridge holder mechanism to move.	Check for any obstruction (paper clip, small object, etc.) and also that the orange protective cap and tape are removed from the BJ cartridge. Check also for a paper jam and clear the jam if necessary (see p. 9-3). Then press [Start] and start again.

Message	Error Code	Cause	Action
CHECK PRINTER (Continued)	–	The BJ cartridge may be defective.	Press [Start]. Reinstall the BJ cartridge (see p. 1-8) and start again. In either case, if the error does not clear, try unplugging the fax. Wait several minutes, then plug it back in. Also, try replacing the BJ cartridge with a new one. (see p. 9-8)
	–	The waste ink tank (which holds the ink expelled during print head cleaning) may be full.	Contact your local authorised Canon dealer or the Canon Help Desk to have the waste ink tank replaced immediately.
CLEAR PAPER JAM	–	There is a paper jam.	Clear the paper jam (see p. 9-3) and reload paper in the multi-purpose tray. Press [Start].
COLOUR INK EMPTY (FAX-B180C only)	–	The Colour BJ tank in the Colour BJ cartridge is empty or its ink may have dried out.	Clean the BJ cartridge print head (see p. 9-8). If the message remains in the LCD, replace the Colour BJ tank. (see Printer Guide)
DATA ERROR	–	An error has occurred and all one-touch speed dialling, coded speed dialling, and user data has been lost.	Press [Set], then re-register the data. (see Chapter 2)
DOC. TOO LONG	#003	The document is longer than 1 metre.	Use a copier to make a reduced copy of the document and then send the copy.
ECM RX	–	The fax is receiving a document using Error Correction Mode (ECM).	ECM receptions may take longer than normal receptions. Turn off ECM if you need to receive quickly, or if you know your local lines are in good condition. (see ECM RX, p. 8-5)

Message	Error Code	Cause	Action
ECM TX	–	The fax is sending a document using Error Correction Mode (ECM).	ECM transmissions may take longer than normal transmissions. Turn off ECM if you need to transmit quickly, or if you know your local lines are in good condition. (see ECM TX, p. 8-4)
LOAD PAPER	–	The multi-purpose tray is empty.	Load paper in the multi-purpose tray (see p. 1-12). Make sure the stack does not exceed the paper limit mark (▶). Then press [Start] and start again.
MEMORY FULL	#037	The fax's memory is full because it has received too many documents, or a very long or detailed document.	Print any documents stored in memory (see p. 6-13). Then start again.
		The fax's memory is full because you either tried to send or copy too many pages at once, or you tried to send or copy a very long or detailed document.	Send the document as two separate jobs. Free up space in the fax's memory by printing or deleting any documents in memory you no longer need. (see pp. 6-13, 6-14)
MEMORY USED <i>nn</i> %	–	Shows the percentage of memory currently in use.	If you need more space, wait for the fax to send any documents. Also, print or delete any documents in memory you no longer need. (see pp. 6-13, 6-14)
NO DATA	–	The one-touch speed dialling button or coded speed dialling code you entered has not been registered.	Register the one-touch speed dialling button or coded speed dialling code. (see pp. 2-12, 2-14)
NO RX PAPER	#012	The receiving party's fax machine is out of paper or its memory is full.	Contact the receiving party and have them load paper in their fax machine or free up space in their fax machine's memory.

Message	Error Code	Cause	Action
NOT AVAILABLE	–	In manual sending, you entered a speed dialling number under which a group is registered.	Use regular dialling, or enter a one-touch speed dialling button or coded speed dialling code that only has one fax/telephone number registered.
PUT IN CARTRIDGE	–	There is no BJ cartridge installed in the fax.	Install the BJ cartridge. (see p. 1-9)
REC'D IN MEMORY	–	The fax received the document in memory because paper or ink ran out, a paper jam occurred, or the incorrect BJ cartridge was installed.	Load paper in the multi-purpose tray (see p. 1-12), replace the BJ cartridge (see p. 9-8) or clear the paper jam (see p. 9-3).
SET DOCUMENT	–	The document is not set correctly or at all.	Set or re-set the document.
TX/RX CANCELLED	–	You pressed [Stop] to cancel the transmission.	If required, try sending again.
TX/RX NO. <i>nnnn</i>	–	When the fax sends or receives a document, it assigns it a unique identification number (<i>nnnn</i>).	Write the number down if you will need it later.
TX/RX NO. <i>nnnn</i> SCANNING P. <i>nnn</i> MEMORY FULL (Three messages toggle.)	–	The fax is sending a document and its memory is full.	The fax continues to send the document as memory becomes available.
WAIT COOLING	–	During printing, the BJ cartridge print head may have become too hot.	Allow the fax to cool down. The fax will resume printing when it has cooled down.

In case of a power failure

The user data settings and registered data for one-touch speed dialling, coded speed dialling and group dialling are saved during a power failure using a built-in battery. However, documents stored in the fax memory will be deleted. If a power failure occurs or the power is turned off, the fax will automatically print a memory clear report as soon as the power is turned on or the power is restored. This report includes a list of the documents that were stored in the memory at the time of power failure.

During a power failure

The following restrictions apply to the function of the fax during a power failure or while the power is turned off:

- You cannot use the fax to make telephone calls from the optional handset. Also, if your fax is connected to a telephone, you may not be able to make telephone calls.
- You cannot send, receive, or copy documents.
- You can receive voice calls only if the optional handset, a telephone, or an extension phone is connected to your fax.

Memory clear report

The memory clear report summarises the documents in memory.

TX/RX NO	MODE	CONNECTION	PGS.	SET TIME	ST. TIME
0023	B'CAST	[01] Canon CANADA [02] Canon OPTICS	3	27/12 16:03	
0024	TRANSMIT	* 32] Canon UK	1	27/12 16:08	
5009	MEMORY RX	[03] Canon EUROPA	1	27/12 16:20	----
0025	DELAYED TX	0297772911	1	27/12 16:43	23:42

If you experience a power failure, the documents in the fax memory will be lost.

As soon as power is restored and the fax is turned on again, the fax will automatically print out a list of documents that were stored in the memory at the time of the power failure.



If there is no paper in the multi-purpose tray when power is restored, the LCD displays LOAD PAPER. If this occurs, press [Resume] to return to standby mode. (The memory clear report will not be printed.)

Appendix

Options

Optional handset	A-2
Package contents	A-2
Attaching the handset to your fax	A-3
Maintaining your handset	A-4

Optional handset

An optional handset is available for connection to your fax. Contact your local authorised Canon dealer for more information on purchasing this option.

Package contents

Make sure your handset package includes the following items:

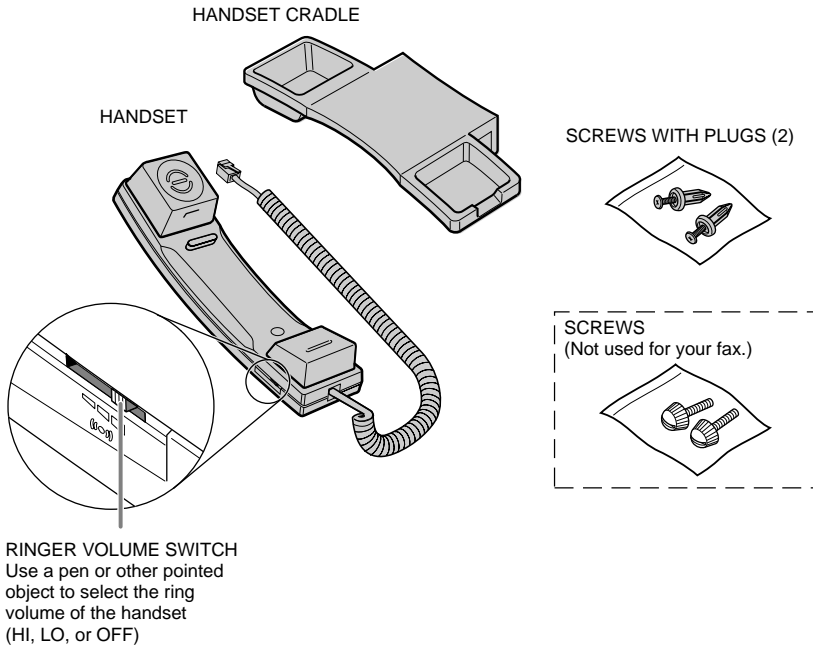

If anything is damaged or missing, notify your local authorised Canon dealer immediately.

Attaching the handset to your fax

Follow this procedure to attach the handset to your fax.

- 1** Use a ball point pen to remove the two covers on the left side of the fax.

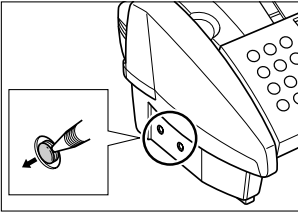

- 2** Remove the screws from the plugs and insert the plugs into the holes on the handset cradle. Then insert the plugs (with the handset cradle) into the holes on the fax.

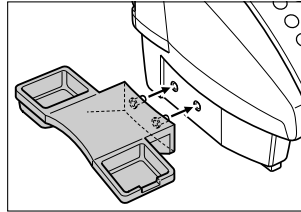

- If you have difficulty inserting the plugs, turn the fax so that the left side is facing you and the right side is against a wall. This will allow you to insert the plugs without the fax moving.

- 3** Use your finger to push the screws into the plugs.

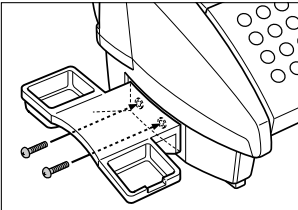

- If you have difficulty, use a cross-point screwdriver to push the screws all the way into the plugs. (Do not screw them in as the screws may break.)

- 4** Place the handset in its cradle and connect the line from the handset to the jack.

A

Options

Maintaining your handset

To maintain your handset in top working condition, be sure to follow these guidelines.

- Do not leave your handset exposed to direct sunlight.
- Do not install your handset in hot or humid conditions.
- Do not spray aerosol polishes on your handset since they may enter the holes on your handset and cause damage.
- Use a damp cloth to clean your handset.

Specifications

Scanning sheet size:	Width: Max. 216 mm Min. 205 mm Thickness: Max. 0.13 mm Min. 0.08 mm
Effective scanning size:	Width: 208 mm
Effective printing size:	Width: 203.2 mm
Transmission time:	G3 ECM MMR: Approx. 6 seconds*
Scanning line density:	Horizontal: 8.00 dots/mm Vertical Standard: 3.85 lines/mm Fine: 7.70 lines/mm
Recording method:	Bubble Jet printing
Paper tray capacity:	Maximum: 100 sheets (75 g/m ²) Maximum thickness of stacked paper: 10 mm
Paper type:	Plain cut sheet paper (A4/Letter/Legal) Paper weight: 64 g/m ² to 90 g/m ² Paper thickness: 0.08 mm to 0.13 mm
Image memory:	Up to 42 A4-size pages* (standard resolution)
Auto dial functions:	One-touch speed dialling (Registration for 12 numbers) Coded speed dialling (Registration for 100 numbers) Group dialling (Registration for 111 numbers)
Ink cartridge:	Canon BX-20 Black BJ cartridge – Cartridge yield: Approx. 1000 pages* Canon BC-21e Colour BJ cartridge (FAX-B180C only) – Cartridge yield: Approx. 80 page**
Power source:	200-240 V/50-60 Hz
Power consumption:	Standby: Approx. 7 W Operation: Approx. 17 W, maximum 40 W
Operating environment:	Temperature: 10°C to 32.5°C Humidity: 20% to 85 % RH
Dimensions:	367 mm (W) × 400 mm (D) × 277 mm (H) (including trays)
Weight:	Approx. 5.1 kg

Specifications are subject to change without notice.

* Based on the Canon FAX Standard Chart No.1, Standard mode.

** 7.5% coverage for each colour.

Index

- ▲ button 2-3, 8-2
- ▼ button 2-3, 8-2
- < button 2-3, 2-6, 2-7
- > button 2-3, 2-6, 2-7
- ☎ (extension phone) jack 1-5
- ☎ (optional handset) jack 1-5
- ☎ (telephone line) jack 1-5

A

- AC power cord, connecting 1-7
- Access password, changing 8-14
- Access type, registering 8-14
 - 1-14, 1-15
- ACTIVITY REPORT
 - description 8-8
 - printing 8-7
 - sample 8-8
 - setting 8-4
- ADF (*Automatic Document Feeder*) 2-2
 - adding pages in 3-4
 - jams in 9-2
 - loading documents in 3-3
- ALARM VOLUME setting 8-3
- ANS.MACHINE MODE
 - description 7-2, 7-9
 - setting 7-9
- Answering machine 1-5
 - connecting 1-5, 1-6
 - using fax with 7-9
- Attaching components 1-4
- AUTO PRINT setting 8-4
- AUTO REDIAL
 - message 9-18
 - setting 6-11, 8-4
- Automatic
 - dialling 2-18
 - Document Feeder (See ADF)
- Automatic redialling
 - cancelling 6-10
 - description 6-9
 - setting options for 6-10, 6-11

B

- BC-21e Colour BJ cartridge 1-8
 - BJ cartridge
 - BC-21e Colour 1-8
 - BX-20 Black 1-8
 - cleaning 9-8
 - guidelines 1-8
 - installing 1-8 to 1-10
 - print head (See Print head)
 - replacing 9-8 to 9-10
 - BLACK INK EMPTY message 9-18
 - Broadcasting, sequential 6-12
 - BUSY/NO SIGNAL message 9-18
 - Buttons 2-3, 2-4 (See also *individual button names*)
 - FAX-B160 2-4
 - FAX-B180C 2-4
 - numeric 2-3, 2-5
 - one-touch speed dialling 2-3
 - special function 2-3
 - BX-20 Black BJ cartridge 1-8
- ## C
- CALLING VOLUME setting 8-3
 - Cancelling
 - automatic redialling 6-10
 - delayed sending 6-15, 6-16
 - manual redialling 6-9
 - manual sending 6-8
 - memory sending 6-8
 - receiving 7-12
 - restriction setting 8-15
 - sending 6-8
 - Cartridge (See BJ cartridge)
 - Cartridge button 1-8 to 1-10, 2-3, 9-9
 - Cartridge holder 1-9, 1-10, 2-2
 - CARTRIDGE JAMMED message 9-19
 - CHANGE CARTRIDGE message 9-19
 - CHECK DOCUMENT message 9-19

- CHECK PAPER SIZE message 9-19
- CHECK PRINTER message 9-19, 9-20
- Cleaning
 - BJ cartridge print head 9-8
 - button 2-3, 9-7, 9-8
 - exterior of fax 9-4
 - interior of fax 9-4 to 9-6
 - periodic 9-4 to 9-10
 - print head 9-7, 9-8
 - scanner components 9-5, 9-6
- Clear button 2-3, 2-7
- CLEAR PAPER JAM message 9-20
- Coded dial button 2-4, 2-16, 2-18
- Coded speed dialling
 - description 2-14
 - list (See Coded speed dialling list)
 - registering numbers and names for 2-14
 - sending a document using 2-18
- Coded speed dialling list
 - description 8-9
 - printing 8-7
 - sample 8-9
- COLOUR INK EMPTY message 9-20
- Components
 - attaching 1-4
 - main 2-2
- Connecting
 - AC power cord 1-7
 - answering machine 1-5, 1-6
 - extension phone 1-5, 1-6
 - external devices 1-5, 1-6
 - optional handset 1-5
 - telephone 1-5
 - telephone line 1-5
- Connector, power cord 1-7
- Contrast, setting scanning 6-2, 6-3
- Copy button 2-4, 5-2
- Copying
 - documents 5-2
 - problems 9-16

Index

setting scanning contrast
6-2, 6-3

Cord, power 1-7

Correcting mistakes 2-7

Country, setting 1-7

Customer support vii

D

D.T. button 2-3, 2-19

DATA ERROR message 9-20

Data Registration button 2-3, 8-2

DATA REGISTRATION menu
8-2

DATE & TIME setting 2-9, 8-3

Date, setting 2-9

DATE SETUP setting 8-6

Delayed Sending 6-15, 6-16

- cancelling 6-16, 6-17
- sending other documents while
fax is set for 6-16

Deleting document from memory
6-14

Dial tone, confirming 2-19

Dialling

- automatic 2-18
- long-distance 2-19
- methods 6-4
- regular 6-4
- special 2-19
- through a switchboard 1-14,
1-15

DOC. MEMORY LIST

- description 6-13
- printing 8-7
- sample 8-10

DOC. TOO LONG message 9-20

Documentation 1-2

Documents

- adding pages in ADF 3-4
- adding pages when sending or
copying 3-4
- copying 5-2
- deleting from memory 6-14
- different ways to receive 7-2
- guide 2-2
- loading 3-3

- polling to receive 7-11
- printing document in memory
6-13
- printing list of documents in
memory 6-13
- problem 3-2
- problems with multipage 3-4
- receiving automatically 7-3
- receiving in memory when a
problem occurs 7-10
- receiving manually 7-7, 7-8
- receiving while performing other
tasks 7-10
- receiving with an answering
machine 7-9
- requirements for scanning 3-2
- scanned area 3-2
- sending 6-5 to 6-7
- sending to more than one location
6-12
- size 3-2
- support 2-2
- thickness 3-2
- type 3-2

E

ECM RX

- message 9-20
- setting 8-5

ECM TX

- message 9-21
- setting 8-4

ECONOMY PRT setting

 8-5

ERROR TX REPORT, sample

 8-11

Extension phone, connecting

 1-5, 1-6

External devices, connecting

 1-5, 1-6

F

Fax 1-2

- assembling 1-4
- cleaning 9-4 to 9-10
- locking the 8-13, 8-14
- main components 2-2

- making connections 1-5 to 1-7
- name, registering 2-10, 2-11
- number, registering 2-10, 2-11
- operation panel 2-2 to 2-4
- restricting use of 8-13 to 8-15
- testing 1-16
- unpacking 1-2, 1-3
- weight i x, S-1

FAX-B160

 2-3, 2-4

FAX-B180C

 2-3, 2-4

FAX Guide

- this guide vii

FAX ONLY MODE

- description 7-2
- setting 7-3

FAX/TEL AUTO SW (Fax/Tel mode)

- description 7-2, 7-4
- setting 7-3
- setting options for 7-4 to 7-6

Fax/Tel mode

- description 7-2, 7-4
- setting 7-3
- setting options for 7-4 to 7-6

Fax/Telephone number, registering

 2-10, 2-11

Faxing problems

 9-12 to 9-15

Function button

 2-3

- light 2-3

G

General problems

 9-17

Group dialling

- description 2-15
- list (*See* Group dialling list)
- registering numbers and names
for 2-15 to 2-17
- sending a document using 2-18

Group dialling list

- description 8-9
- printing 8-7
- sample 8-9

Guide

- document 2-2
- paper 2-2

Index

H

Handling and maintenance, safety instructions viii

Hook button 2-4, 6-6

I

Image Quality button 2-4, 5-2, 6-2

INCOMING RING setting 8-5

Installing, BJ cartridge 1-8 to 1-10

J

Jack

☎ (extension phone) 1-5

☎ (optional handset) 1-5

☎ (telephone line) 1-5

Jams

clearing 9-2, 9-3

in ADF 9-2

in multi-purpose tray 9-3

K

KEYPAD VOLUME setting 8-3

L

Language, setting 1-7

LCD 2-3

messages 9-18 to 9-22 (*See also individual message names*)

Letters, entering 2-5, 2-6

LINE MONITOR VOL setting 8-3

Line, telephone 1-5, 1-13

List (*See individual list names*)

LOAD PAPER message 9-21

Loading

documents 3-3

paper 1-11, 1-12

Location, safety instructions ix

LOCK PHONE setting 8-6

Long-distance dialling 2-19

Lowercase letter mode 2-5, 2-6

M

Main unit 1-2

MAN/AUTO SWITCH setting 8-5

MANUAL MODE

description 7-2, 7-7

receiving in 7-7, 7-8

setting 7-7

Manual redialling 6-9

cancelling 6-9

Manual sending 6-3, 6-6

cancelling 6-8

Memory

deleting document from 6-14

documents in 6-13, 6-14

printing document in 6-13

printing list of documents in 6-13

receiving when problem occurs 7-10

sending (*See Memory sending*)

MEMORY CLEAR REPORT

description 9-23

sample 9-23

MEMORY FULL message 9-21

Memory Reference button 2-3, 6-13, 6-14

MEMORY RX setting 8-5

Memory sending 6-3, 6-5

cancelling 6-8

MEMORY USED nn% message 9-21

Menu (*See also individual menu names*)

PRINTER SETTINGS 8-2, 8-5

REPORT SETTINGS 8-2, 8-4

RX (Reception) SETTINGS 8-2, 8-5

SYSTEM SETTINGS 8-2, 8-6

TX (Transmission) SETTINGS 8-2, 8-4

USER SETTINGS 8-2, 8-3

Messages

displayed during sending 6-7

LCD 9-18 to 9-22 (*See also individual message names*)

MID PAUSE SET setting 8-4

Mistakes, correcting 2-7

Modes, switching number and letter 2-6

Multi-purpose tray 2-2

capacity 4-2

jams in 9-3

loading paper in 1-12

MULTI TX/RX (Transaction) REPORT 8-12

N

NO DATA message 9-21

NO RX PAPER message 9-21

NOT AVAILABLE message 9-22

Nozzle check pattern

printing 9-7

Number mode 2-5, 2-6

Numbers, entering 2-5 to 2-7

Numeric buttons 2-3, 2-5

O

OFFHOOK ALARM setting 6-6, 8-3

One-touch speed dialling

buttons 2-3

description 2-12

list (*See One-touch speed dialling list*)

registering numbers and names for 2-12, 2-13

sending a document using 2-18

One-touch speed dialling list

description 8-9

printing 8-7

sample 8-9

Operation panel 2-2 to 2-4

Optional handset

connecting 1-5

Outside line access number, registering 1-14, 1-15

Index

P

Paper

- guide 2-2
- guidelines 1-11
- limit mark (*See* Paper limit mark)
- loading 1-11, 1-12
- loading in multi-purpose tray 1-12
- quantity 4-2
- requirements 4-2
- rest 2-2
- size 4-2
- thickness lever (*See* Paper thickness lever)
- weight 4-2

Paper feeding problems 9-11

Paper limit mark 1-11, 1-12

Paper rest 2-2

PAPER SIZE setting 8-5

Paper thickness lever 2-2

PASSWORD setting 8-6

Pause, entering 1-14

PBX

- ACCESS NUMBER setting 8-3
- ACCESS TYPE setting 8-3

Polling button 2-3, 7-11

Power cord 1-2, 1-7

Power failure

- during 9-23
- in case of 9-23

Power supply, safety instructions ix

Print head

- cleaning 9-8
- testing 9-7

Print quality problems 9-17

PRINT WITH IMAGE setting 8-4

Printable area 4-2

Printer cover 2-2

Printer cover tab 2-2

PRINTER SETTINGS

- menu 8-2
- menu list 8-5

Printing

1-TOUCH SPD DIAL LIST 8-7

ACTIVITY REPORT 8-7

CODED SPEED DIAL LIST 8-7

DOC. MEMORY LIST 8-7

document in memory 6-13

GROUP DIAL LIST 8-7

list of document in memory 6-13

nozzle check pattern 9-7

USER DATA LIST 8-7

Problem documents 3-2

Problems

- copying 9-16
- faxing 9-12 to 9-15
- general 9-17
- paper feeding 9-11
- print quality 9-17
- receiving 9-13 to 9-15
- receiving in memory when 7-10
- sending 9-12, 9-13
- telephone 9-16

PSSTN setting 8-3

PUT IN CARTRIDGE message 1-9, 9-22

Q

Quality

- adjusting 6-2, 6-3
- print problems 9-17

Quantity, paper 4-2

R

R button 1-14, 2-3

- registering 1-14, 1-15

R-KEY SETTING 1-14, 8-3

REC'D IN MEMORY message 9-22

Receive mode Chapter 7

Receive mode button 2-4, Chapter 7

Receiving (*See also individual receive modes*)

- cancelling 7-12
- in memory when problem occurs 7-10

methods 7-2

problems 9-13 to 9-15

while performing other tasks 7-10

with answering machine 7-9

REDIAL INTERVAL setting 6-11, 8-4

Redial/Pause button 2-4, 2-19, 6-9

REDIAL TIMES setting 6-11, 8-4

Redialling

- automatic 6-9 to 6-11
- manual 6-9

REDUCE DIMENSION setting 8-5

Registering

- access type 1-14, 1-15
- coded speed dialling numbers and names 2-14
- fax/telephone number 2-10, 2-11
- group dialling numbers and names 2-15 to 2-17
- name 2-10, 2-11
- one-touch speed dialling numbers and names 2-12, 2-13
- outside line access number 1-14, 1-15
- R button 1-14, 1-15
- sender information 2-8 to 2-11

Replacing BJ cartridge 9-8 to 9-10

Report button 2-3, 8-7

REPORT SETTINGS

- menu 8-2
- menu list 8-4

Resolution

- setting scanning 6-2

Restricting use of fax 8-13 to 8-15

RING COUNT setting 8-5

ROTARY PULSE setting 1-13, 8-3

RX CALL LEVEL setting 8-3

RX CONDITION

- description 8-5
- setting 7-14

Index

RX REDUCTION setting 8-5

RX (Reception) REPORT

description 8-12

setting 8-4

RX RESTRICTION

description 8-5

setting 7-13

RX SETTINGS

menu 8-2

menu list 8-5

RX START SPEED setting 8-6

S

Safety instructions

handling and maintenance viii

location ix

power supply ix

SCAN CONTRAST setting 8-3

Scanning

contrast, setting 6-2, 6-3

document requirements 3-2

resolution, setting 6-2

Sender information, registering
2-8 to 2-11

Sending

cancelling 6-8

delayed 6-15, 6-16

documents 6-5 to 6-7

manual 6-6

memory 6-3, 6-5

messages displayed during 6-7

methods 6-3

preparing for 6-2 to 6-4

problems 9-12, 9-13

sequential broadcasting 6-12

setting scanning contrast 6-2,
6-3

setting scanning resolution 6-2

to more than one location (*See*
Sequential broadcasting)

using coded speed dialling 2-18

using group dialling 2-18

using one-touch speed dialling
2-18

Sequential broadcasting 6-12

Set button 2-3, 8-2

Setting date and time 2-9

Setting language and country 1-7

Shipping materials, removing 1-3

Sorted list 8-9

Space button 2-3, 2-6, 2-7, 2-10,
2-13

Special

dialling 2-19

function buttons 2-3 (*See also*
individual button names)

Speed dialling

coded 2-14, 2-18

group dialling 2-15 to 2-18

lists 8-9

one-touch 2-12, 2-13, 2-18

printing lists 8-7

Start/Resume (Start) button 2-4

Stop button 2-4

Switchboard, dialling through
1-14, 1-15

Symbols, entering 2-5, 2-7

SYSTEM SETTINGS

menu 8-2

menu list 8-6

T

TEL LINE TYPE setting
1-13, 8-3

Telephone

connecting 1-5

problems 9-16

TELEPHONE # MARK setting
8-3

Telephone line 1-2

connecting 1-5

setting type 1-13

Telephone problems 9-16

Testing

BJ cartridge print head 9-7

fax 1-16

TIME OUT setting 8-4

Time, setting 2-9

Timer button 2-3, 6-15, 6-16

Tone/+ button 2-3, 2-19

TOUCH TONE setting 1-13, 8-3

Tray, multi-purpose 2-2

**TTI (Transmit Terminal
Identification)** 2-8

TTI position setting 8-3

TX (Transmission) REPORT

description 8-11

setting 8-4

TX SETTINGS

menu 8-2

menu list 8-4

TX START SPEED setting 8-6

TX TERMINAL ID setting 8-3

TX/RX CANCELLED message
9-22

TX/RX NO. nnnn message 9-22

**TX/RX NO. nnnn, SCANNING
P.nnn, MEMORY FULL
message** 9-22

U

UN/LOCK PHONE setting 8-6

UNIT NAME setting 8-3

UNIT TELEPHONE # setting
8-3

Unpacking 1-2, 1-3

Unsorted list 8-9

Uppercase letter mode 2-5, 2-6

USER SETTINGS

menu 8-2

menu list 8-3

USER'S DATA LIST

description 8-10

printing 8-7

sample 8-10

V

Volume

ALARM VOLUME setting 8-3

CALLING VOLUME setting
8-3

KEYPAD VOLUME setting
8-3

LINE MONITOR VOL setting
8-3

Index

VOLUME CONTROL setting
8-3

VOLUME CONTROL setting 8-
3

W

WAIT COOLING message 9-22

Warranty 1-2

Weight

document 3-2

fax ix, S-1

paper 4-2

Free Manuals Download Website

<http://myh66.com>

<http://usermanuals.us>

<http://www.somanuals.com>

<http://www.4manuals.cc>

<http://www.manual-lib.com>

<http://www.404manual.com>

<http://www.luxmanual.com>

<http://aubethermostatmanual.com>

Golf course search by state

<http://golfingnear.com>

Email search by domain

<http://emailbydomain.com>

Auto manuals search

<http://auto.somanuals.com>

TV manuals search

<http://tv.somanuals.com>