

Canon

FAX-L220/L295

User's Guide

IMPORTANT!

- **If you have purchased the FAX-L295 model, be sure to read Appendix B before reading the rest of this guide.**



This equipment conforms with the essential requirements of EC Directive 1999/5/EC.

We declare that this product conforms with the EMC requirements of EC Directive 1999/5/EC at nominal mains input 230V, 50Hz although the rated input of the product is 200-240V, 50/60Hz.

If you move to another EU country and are experiencing trouble please call the Canon Help Desk.
(For Europe Only)

Model Name

- H12251 (FAX-L220)
- H12250 (FAX-L295)

Copyright

Copyright © 2003 by Canon, Inc. All rights reserved. No part of this publication may be reproduced, transmitted, transcribed, stored in a retrieval system, or translated into any language or computer language in any form or by any means, electronic, mechanical, magnetic, optical, chemical, manual, or otherwise, without the prior written permission of Canon, Inc.

Trademarks

Canon is a registered trademark, and UHQ is a trademark of Canon Inc.

All other product and brand names are registered trademarks, trademarks or service marks of their respective owners.



As an ENERGY STAR® Partner, Canon has determined that the FAX-L295/L220 meets the ENERGY STAR® guidelines for energy efficiency.



Super G3 is a phrase used to describe the new generation of fax units that use ITU-T V.34 standard 33.6 Kbps* modems. Super G3 High Speed Fax units allow transmission time of approximately three seconds* per page which results in reduced telephone line charges.

* Approximately three seconds per page document transmission time based on Canon FAX Standard Chart No. 1 (Standard Mode) at 33.6 Kbps modem speed. The Public Switched Telephone Network (PSTN) currently supports 28.8 Kbps modem speeds or lower, depending on telephone line conditions.

Laser Safety Information

Laser radiation could be hazardous to the human body. For this reason, laser radiation emitted inside this unit is hermetically sealed within the protective housing and external cover. No radiation can leak from the machine in the normal operation of the product by the user.

This fax is classified as a Class 1 Laser Product under IEC 60825-1: 1993, EN 60825-1: 1994.

■ 200-240 V model

The label shown below is attached to the laser scan unit on the fax.



This fax has been classified under IEC 60825-1: 1993, EN60825-1: 1994 and conforms to the following classes:

CLASS 1 LASER PRODUCT

LASER KLASSE 1

APPAREIL A RAYONNEMENT LASER DE CLASSE 1

APPARECCHIO LASER DI CLASSE 1

PRODUCTO LASER DE CLASE 1

APARELHO A LASER DE CLASSE 1



Performance of procedures other than those specified in this guide may result in hazardous radiation exposure.

Contents

Chapter 1: Introduction

Type Conventions Used in This Guide.....	1-2
Customer Support	1-3
Important Safety Instructions.....	1-4

Chapter 2: Setting Up

Unpacking the FAX	2-2
Removing Shipping Materials.....	2-3
Assembling the FAX	2-4
Making Connections	2-5
Connecting the Telephone Line Cord and External Devices	2-5
Connecting the Power Cord	2-7
Setting the Language and Country.....	2-8
Main Components of the FAX.....	2-10
Operation Panel.....	2-11
Special Function Buttons.....	2-11
Installing the Toner Cartridge.....	2-12
Loading Paper	2-15
Testing the FAX.....	2-16

Chapter 3: Registering Information

Guidelines for Entering Numbers, Letters, and Symbols	3-2
Correcting a Mistake	3-4
Registering Sender Information.....	3-5
What is Sender Information?	3-5
Entering the Date and Time	3-6
Registering Your FAX Number and Name.....	3-6
Setting the Telephone Line Type.....	3-8
Dialling Through a Switchboard.....	3-9
Registering the R Button	3-9
Setting the Summer Time	3-11

Chapter 4: Document Handling

Document Requirements.....	4-2
Scanned Area of a Document.....	4-2
Loading Documents	4-3
Adding Pages to the Document in the ADF.....	4-4

Chapter 5: Paper Handling

Paper Requirements	5-2
Printable Area	5-3
Selecting Paper for Your FAX	5-3
Loading Paper	5-3
Selecting Face-Up or Face-Down Paper Delivery	5-4
Changing the Paper Size Setting	5-6
Adjusting the Toner Saver Setting	5-8

Chapter 6: Speed Dialling

What is Speed Dialling?	6-2
Speed Dialling Methods	6-2
Registering One-Touch Speed Dialling	6-3
Registering Coded Speed Dialling	6-7
Registering Group Dialling	6-11
Using Speed Dialling	6-14
Sending a Document With Speed Dialling	6-14
Making a Telephone Call With Speed Dialling	6-15
Dialling with the Directory	6-16
Printing Speed Dialling Lists	6-17

Chapter 7: Sending Faxes

Preparing to Send a Fax	7-2
Documents You Can Fax	7-2
Setting the Scanning Resolution	7-2
Setting the Scanning Contrast	7-3
Dialling Methods	7-4
Sending Methods	7-5
Memory Sending	7-5
Manual Sending Via the Handset	7-6
Cancelling Sending	7-8
Redialling When the Line is Busy	7-9
Manual Redialling	7-9
Cancelling Manual Redialling	7-9
Automatic Redialling	7-9
What is Automatic Redialling?	7-9
Cancelling Automatic Redialling	7-9
Setting the Options for Automatic Redialling	7-10
Sending the Same Document to Several Fax Numbers (Sequential Broadcasting)	7-12
Delayed Sending	7-14
Scanning a Document into Memory for Delayed Sending	7-14
Printing a Document Set for Delayed Sending	7-16
Deleting a Document Set for Delayed Sending	7-17

Chapter 8: Receiving Faxes

Receiving Methods	8-2
Receiving Faxes Automatically: FAX ONLY MODE	8-2
Setting FAX ONLY MODE	8-2
Receiving Both Faxes and Telephone Calls Automatically: Fax/Tel Mode	8-4
Setting Fax/Tel Mode	8-4
Setting the Options for Fax/Tel Mode	8-5
Receiving Faxes Manually: MANUAL MODE	8-7
Setting MANUAL MODE	8-7
Receiving a Fax Manually	8-7
Receiving With an Answering Machine: ANS.MACHINE MODE	8-9
Setting ANS.MACHINE MODE	8-9
Using the FAX With an Answering Machine	8-9
Receiving While Performing Other Tasks	8-10
Receiving Faxes in Memory When a Problem Occurs	8-10
Cancelling Receiving	8-11

Chapter 9: Special Features

Special Dialling	9-2
Entering Pauses in a Fax/Telephone Number	9-2
Switching Temporarily to Tone Dialling	9-3
Dialling Through a Switchboard	9-3
Documents Stored in Memory	9-4
Printing a List of Documents Stored in Memory	9-4
Printing a Document Stored in Memory	9-5
Sending a Document Stored in Memory	9-6
Deleting a Document Stored in Memory	9-8
Polling	9-9
What is Polling?	9-9
Polling Receiving	9-9
Polling Another Fax Machine	9-9
Cancelling Polling Receiving	9-11
Polling Sending	9-11
Setting Up the Polling Box	9-11
Scanning a Document into the Polling Box	9-14
Changing or Deleting the Polling Box Settings	9-14
Restricting Use of Your FAX	9-16
Enabling Restriction of Your FAX	9-16
Cancelling Restriction of Your FAX	9-17
Restricting Reception	9-19

Chapter 10: Copying	
Documents You Can Copy	10-2
Making Copies	10-2
Making a Quick Single Copy	10-3
Chapter 11: Reports and Lists	
Summary of Reports and Lists	11-2
ACTIVITY REPORT	11-3
TX (Transmission) REPORT	11-4
MULTI TX/RX (Transaction) REPORT	11-5
RX (Reception) REPORT	11-5
Chapter 12: Maintenance	
Periodic Cleaning	12-2
Cleaning the FAX's Exterior	12-2
Cleaning the FAX's Interior	12-3
Cleaning the Scanner Components	12-4
Replacing the Toner Cartridge	12-6
Chapter 13: Troubleshooting	
Clearing Jams	13-2
Jams in the ADF	13-2
Paper Jams	13-3
Jams in the Paper Delivery Slots	13-3
Jams Inside the Unit	13-3
LCD Messages	13-8
Paper Feeding Problems	13-13
Faxing Problems	13-13
Sending Problems	13-13
Receiving Problems	13-15
Copying Problems	13-17
Telephone Problems	13-18
Printing Problems	13-18
General Problems	13-20
If You Cannot Solve a Problem	13-21
If a Power Cut Occurs	13-22

Chapter 14: Summary of Settings	
Understanding the Menu System.....	14-2
Printing a List to Check the Current Settings.....	14-2
Accessing the Menus.....	14-3
USER SETTINGS Menu.....	14-4
REPORT SETTINGS Menu.....	14-5
TX (Transmission) SETTINGS Menu.....	14-6
RX (Reception) SETTINGS Menu.....	14-7
PRINTER SETTINGS Menu.....	14-8
POLLING BOX Menu.....	14-9
SYSTEM SETTINGS Menu.....	14-10
Appendix A: Specifications	
General Specifications.....	A-2
Facsimile.....	A-2
Copier.....	A-3
Telephone.....	A-3
Printer.....	A-3
Appendix B: FAX-L295 Instructions	
Introduction.....	B-2
Differences Between the FAX-L295 and FAX-L220.....	B-2
Using Your Documentation.....	B-2
Unpacking the FAX-L295.....	B-2
Connecting the FAX-L295 to Your PC.....	B-3
Print Media Requirements.....	B-4
Printable Area.....	B-4
Selecting Print Media.....	B-5
Loading Envelopes.....	B-5
Loading Transparencies.....	B-7
Appendix C: Options	
Optional Handset.....	C-2
Package Contents.....	C-2
Attaching the Handset to Your FAX.....	C-3
Maintaining Your Handset.....	C-4
Index	I-1

Chapter 1

Introduction

❑ Type Conventions Used in This Guide.....	1-2
❑ Customer Support	1-3
❑ Important Safety Instructions.....	1-4

Type Conventions Used in This Guide

Please read the list below of symbols, terms, and abbreviations used in this guide.



Cautions tell you how to avoid actions that could injure you or damage your FAX. In order to use your unit safely, always observe these cautions.



Notes provide advice on using your FAX more effectively, describe operating restrictions, and tell you how to avoid minor difficulties. Reading these is recommended to make the most of your unit and its functions.

(→ p. <i>n-m</i>)	A number preceded by an arrow and enclosed in parenthesis references a page number (p.) or page numbers (pp.) that contain more information on the topic of the previous sentence.
default	A setting that remains in effect unless you change it.
document or fax	The original sheet(s) of paper you send or receive with your FAX.
menu	A list of settings from which you select an item to set up or change. A menu has a title which appears in the LCD.
TX/RX NO.	Transaction number. When you send or receive a document, your FAX automatically assigns the document a unique transaction number. A transaction number is a four-digit number that will help you keep track of documents you send and receive.
TX	Denotes Sending.
RX	Denotes Receiving.
Ex:	Example of a message or setting displayed in the LCD.
ADF	Automatic Document Feeder. The device on your FAX that automatically feeds a document into the unit for faxing and copying.
LCD	Liquid Crystal Display. The display on the operation panel that displays messages and settings.
ECM	Error Correction Mode. The ability of your FAX to reduce system and line errors when sending to or receiving from a fax machine with ECM capability.
G3	Group 3. A system that uses encoding schemes to transmit image data while reducing the amount of data that needs to be transmitted, thus reducing transmission time.
ITU-TS	International Telecommunications Union-Telecommunications Sector. A committee created to set international standards for telecommunications.

In addition, this guide uses distinctive typefaces to identify buttons and information in the LCD:

- The buttons you press appear in this typeface: **Stop**.
- Information in the LCD appears in this typeface: USER SETTINGS.

Customer Support

Your FAX is designed with the latest technology to provide trouble-free operation. If you encounter a problem with the unit's operation, try to solve it by using the information in Chapter 13. If you cannot solve the problem or if you think your FAX needs servicing, contact your local authorised Canon dealer or the Canon help line.

Important Safety Instructions

Read these safety instructions thoroughly before using your FAX.



Except as specifically described in this guide, do not attempt to service the FAX yourself. Never attempt to disassemble the unit: opening and removing its interior covers will expose you to dangerous voltages and other risks. For all service, contact your local authorised Canon dealer or the Canon help line.

■ Handling and Maintenance

- Follow all warnings and instructions marked on the FAX.
- Do not subject the FAX to strong physical shocks or vibrations.
- Always unplug the FAX before moving or cleaning it.
- To avoid paper jams, never unplug the power cord, open the front cover, or add or remove paper in the multi-purpose tray while printing.
- When transporting the FAX, be sure to remove the toner cartridge from the unit. Place the toner cartridge in its original protective bag or wrap it in a thick cloth to prevent exposure to light.
- Always lift the FAX as shown below. Never lift it by any of its attachments.

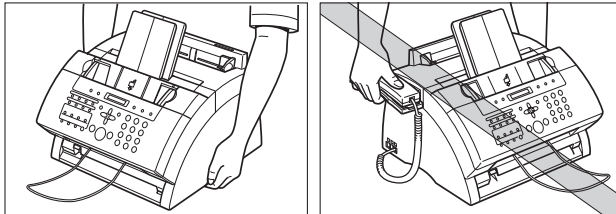

- Do not insert any objects into the slots or openings on the FAX since they may touch dangerous voltage points or short out parts. This could result in fire or electric shock.
- Do not allow small objects (such as pins, paper clips, or staples) to fall into the FAX. If something does fall into it, unplug the unit immediately and contact your local authorised Canon dealer or the Canon help line.
- To avoid spillage in or around the unit, do not eat or drink near it. If you spill liquid or if any substance falls into it, unplug the unit immediately and contact your local authorised Canon dealer or the Canon help line.
- Keep the FAX clean. Dust accumulation can prevent the unit from operating properly.

- Unplug the FAX from the wall outlet and contact your local authorised Canon dealer or the Canon help line in any of the following cases:
 - When the power cord or plug is damaged or frayed.
 - If liquid has spilled into the unit.
 - If the unit has been exposed to rain or water.
 - If the unit does not operate normally when you have followed the instructions in this guide. Adjust only those controls that are covered by the instructions in this guide. Improper adjustment of other controls may result in damage and may require extensive work by a qualified technician to restore the product to normal operation.
 - If the unit has been dropped or the cabinet has been damaged.
 - If the unit exhibits a distinct change in performance, indicating a need for servicing.

■ Location

- Place the FAX on a flat, stable, vibration-free surface that is strong enough to support its weight (approx. 10 kg).
- Place the FAX in a cool, dry, clean, well ventilated place.
 - Make sure the area is free from dust.
 - Make sure the location is not affected by extreme temperature changes, and always stays between 10°C and 32.5°C.
 - Make sure the area's relative humidity is always between 20% and 80%.
- Keep the FAX away from direct sunlight as this can damage it. If you have to place it near a window, install heavy curtains or blinds.
- Do not use the FAX near water. Make sure that no wet or humid objects come into contact with the unit.
- Do not use or store the FAX outdoors.
- Do not install the FAX near devices that contain magnets or generate magnetic fields, such as speakers.
- If possible, place the FAX near an existing telephone line outlet for easy connection of the telephone line cord, and to avoid the expense of installing a new outlet.
- Place the FAX near a standard 200-240 V AC (50-60 Hz) power outlet.
- To ensure reliable operation of the FAX and to protect it from overheating (which can cause it to operate abnormally and create a fire risk), do not block the exhaust vent. Never block or cover any openings on the unit by placing it on a bed, sofa, rug, or other similar surface. Do not place the unit in a cupboard or built-in installation, or near a radiator or other heat source unless proper ventilation is provided. Leave approximately 10 cm space around all sides of the unit. For the dimensions of the FAX, see p. A-2.

- Do not stack boxes or furniture around the power outlet. Keep the area free so you can reach the outlet quickly. If you notice anything unusual (smoke, strange odours, noises) around the FAX, unplug the unit immediately. Contact your local authorised Canon dealer or the Canon help line.
- Do not allow anything to rest on the power cord, and do not place the unit where the cord will be walked on. Make sure the cord is not knotted or kinked.

■ Power Supply

- During electrical storms, disconnect the power cord from the power outlet. (Please note that any documents stored in the FAX's memory will be deleted when you unplug the unit.)
- Whenever you unplug the FAX, wait at least five seconds before you plug it in again.
- Do not plug the FAX into an uninterruptible power supply (UPS).



**This product emits low level magnetic flux.
If you use a cardiac pacemaker and feel abnormalities, please move away from this product and consult your doctor.**

Chapter 2

Setting Up

❑ Unpacking the FAX	2-2
• Removing Shipping Materials	2-3
❑ Assembling the FAX.....	2-4
❑ Making Connections	2-5
• Connecting the Telephone Line Cord and External Devices.....	2-5
• Connecting the Power Cord.....	2-7
❑ Setting the Language and Country.....	2-8
❑ Main Components of the FAX.....	2-10
• Operation Panel	2-11
Special Function Buttons	2-11
❑ Installing the Toner Cartridge.....	2-12
❑ Loading Paper	2-15
❑ Testing the FAX.....	2-16

Unpacking the FAX

Before unpacking your FAX, be sure to choose a suitable location for it (→ p. 1-5).

Carefully remove all items from the box. You should have someone help you hold the box while you lift out the FAX and its protective packaging. Save the carton and packaging in case you need to transport the FAX in the future.

Make sure you have the following items:



MAIN UNIT

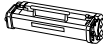

FX-3 TONER
CARTRIDGE



SUPPORT TRAYS



PAPER REST



MULTI-PURPOSE
TRAY COVER



DOCUMENT
SUPPORT

POWER CORD

TELEPHONE LINE CORD

DOCUMENTATION

PAPER LOADING WARNING LABEL

DESTINATION LABELS



-
- The actual items may differ in shape and quantity from the one shown above.
 - Please note that the items included with your FAX may vary depending on the country of purchase.
-

If any items are damaged or missing, notify your local authorised Canon dealer or the Canon help line immediately.



- Important! Save your sales receipt for proof of purchase in case your unit requires warranty service.
- If you have purchased the optional handset, see Appendix C for the items included.

Removing Shipping Materials

Follow this procedure to remove the shipping materials. Keep them in case you need to transport the unit in the future.

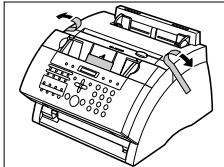

- 1 Remove all shipping tapes from the FAX.

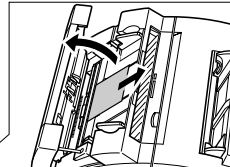

- 2 Use both hands to gently open the operation panel (it only opens partially). Then remove the protective sheet from the ADF. Close the operation panel by pressing it down from the centre until it locks into place.

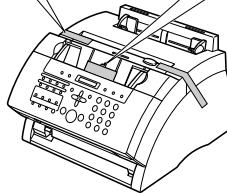

The actual shipping materials may differ in shape, quantity, and position from the ones shown above.

Assembling the FAX

Follow this procedure to assemble your FAX:

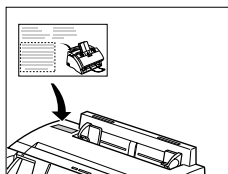

- 1** Attach the paper loading warning label to the left of the multi-purpose tray.

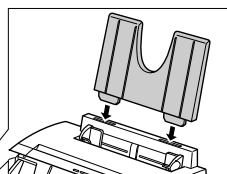

- 2** Insert the tabs on the paper rest into the slots on the unit.

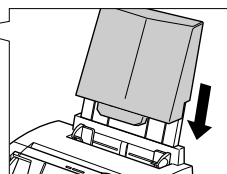

- 3** Slide the multi-purpose tray cover over the paper rest.

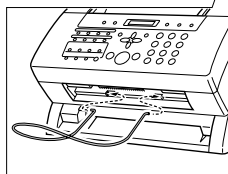

- 4** Insert the ends of the document support into the slots on the unit.

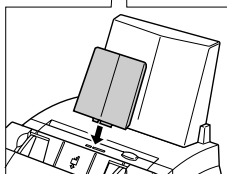

- 5** Insert the tabs on one of the support trays into the corresponding slots above the face-down delivery slot.

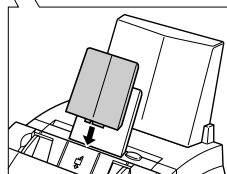

- 6** Insert the tabs on the other support tray into the corresponding slots above the ADF.



For details on attaching the optional handset to your FAX, see Appendix C.

Making Connections

Connecting the Telephone Line Cord and External Devices

Your FAX has three jacks on the side for connection of the following:

- Telephone line cord
- Optional handset or telephone
- Additional telephone, answering machine, or data modem

If you only have one telephone line and plan to use your FAX for receiving both faxes and voice calls, you will need to connect the optional handset, a telephone, or an answering machine to your unit.



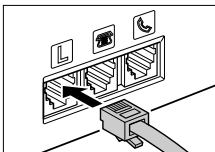
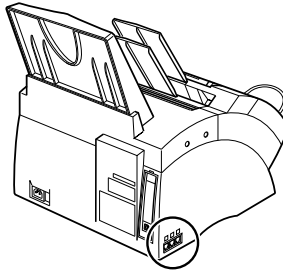

Be sure to connect any external device before using your FAX.

Follow this procedure to connect the telephone line cord and external device(s):

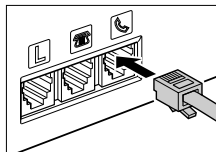

- 1** Connect the supplied telephone line cord to the  jack, then the other end to the telephone line jack on your wall.



- 2** Connect the optional handset or telephone cord to the  jack.

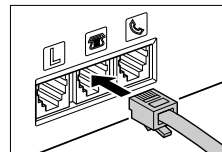

- 3** Connect the additional telephone, answering machine, or data modem cord to the  jack.



- Canon cannot guarantee that all answering machines will be compatible with your unit, due to varying specifications.
 - If you have connected an external device to your FAX, be sure to set the correct receive mode (→ Chapter 8).
 - To connect an additional telephone as well as an answering machine, connect the additional telephone to the answering machine, and then the answering machine to your FAX.
 - If you connect a data modem to your FAX and you use it extensively, or others access your PC frequently through the data modem, you may want a dedicated telephone line for your data modem.
-

Connecting the Power Cord

Before connecting the power cord, see Power Supply, p. 1-6.

Follow this procedure to connect the power cord:

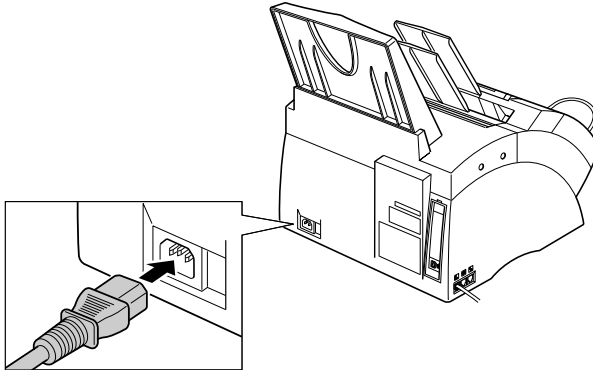

Connect the supplied power cord to the power cord connector. Then connect the other end into a properly grounded 200-240 V AC three-prong outlet.*

The FAX has no power switch, so its power is on as long as it is plugged in. Once connected, though, the unit still needs time to warm up before you can use it. Wait until the LCD no longer displays **PLEASE WAIT**.



- The FAX is equipped with a three-prong, grounding-type plug provided with a third (grounding) pin. This plug will only fit into a grounding-type outlet. This is a safety feature. If you are unable to insert the plug into your outlet, contact an electrician to replace the outlet. Do not defeat the safety purpose of the grounding-type plug by breaking off the third prong or using a 3-to-2 adaptor.*
- Do not plug the FAX into the same circuit as an appliance such as an air conditioner, electric typewriter, television, or copier. Such devices generate electrical noise that can interfere with your FAX's ability to send and receive faxes.

When you connect the power cord to an AC outlet for the first time, **DISPLAY LANGUAGE** will appear in the LCD display after **PLEASE WAIT**. In this case, set the language for the LCD display and the country** (→ p. 2-8).

* The shape of the plug and outlet vary depending on the country of purchase.

** The country selection feature is available for certain countries only.

Setting the Language and Country*

When you connect the power cord to an AC outlet for the first time, you need to select the language for the LCD display. For some countries, you also need to select the country where you are using the FAX machine. The FAX machine automatically switches the selectable settings and the default settings in the menus to suit the selected country.

Follow this procedure to set the language and country.

After connecting the power cord, the display changes from PLEASE WAIT to DISPLAY LANGUAGE.

PLEASE WAIT

DISPLAY LANGUAGE

1 Press **OK**.

Ex: ENGLISH

2 Press **▼** or **▲** to select the preferred language for the LCD display.

Ex: ENGLISH

3 Press **OK**.

Ex: DATA ENTRY OK

■ If COUNTRY SELECT does not appear after DATA ENTRY OK in step 3:

The FAX enters standby mode.

Ex: 15:00 FaxOnly

■ If COUNTRY SELECT appears after DATA ENTRY OK in step 3:

COUNTRY SELECT

4 Press **OK**.

Ex: UK

5 Press **▼** or **▲** to select the country where you are using the FAX.

Ex: SWITZERLAND

- If your country name does not appear, select OTHERS.

* The country selection feature is available for certain countries only.

- 6** Press **OK**.
The FAX enters standby mode.

DATA ENTRY OK

PUT IN CARTRIDGE

Ex: 15:00 FaxOnly

Once you have selected the language and country, these setting menus will not appear next time you connect the power cord.





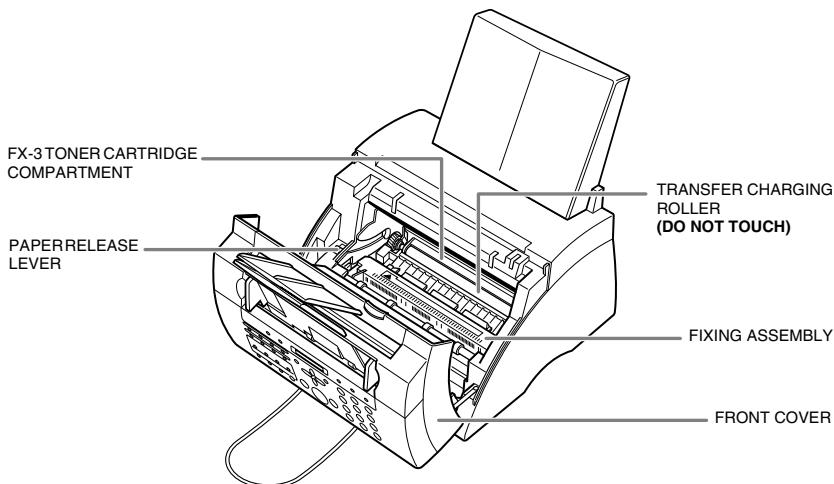
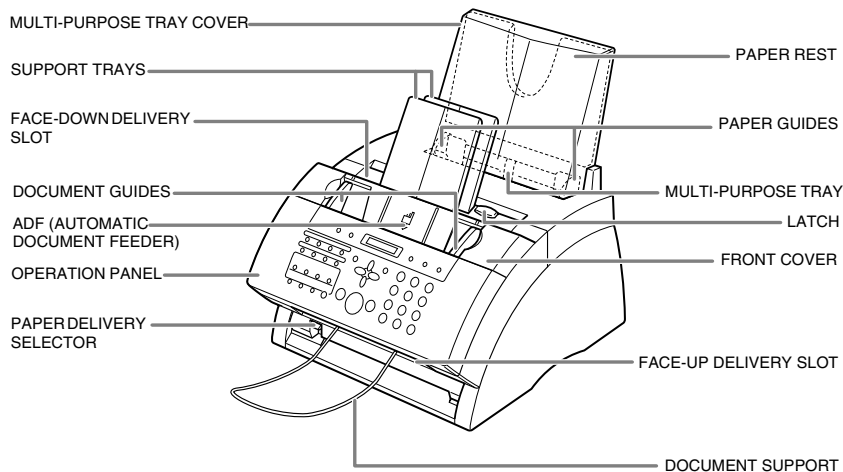

- To check the settings made by the country selection, you can print the **USER'S DATA LIST** (→ p. 14-2).
- You can change the language or country setting using the **SYSTEM SETTINGS** menu (→ p. 14-10).

Main Components of the FAX





Operation Panel

The language used for the Operation Panel varies depending on the country of purchase. The following illustration shows the Operation Panel in English.

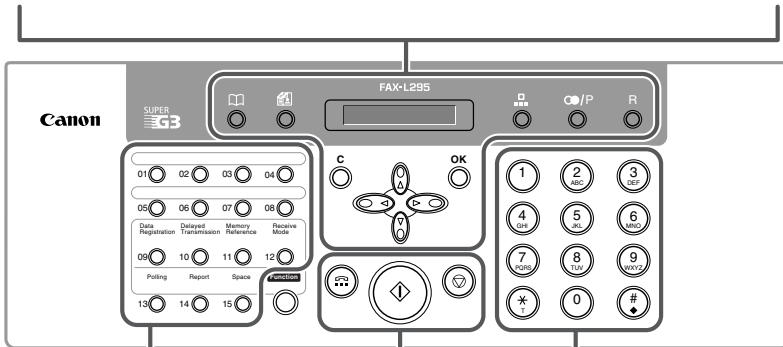
-  **Directory Button**
(→ p. 6-16)
-  **Resolution Button**
(→ pp. 7-2, 10-2)
- **LCD**
- **C (Clear) Button**
(→ p. 3-4)
- **◀, ▶, ▲, ▼ Buttons**
(→ pp. 3-4, 3-7)
- **OK Button**
(→ p. 3-6)
-  **Coded Dial Button**
(→ pp. 6-2, 6-7, 6-14)
-  **/P Redial/Pause Button** (→ pp. 7-9, 9-2)
- **R Button** (→ p. 3-9)



- **One-Touch Speed Dialling Buttons**
(→ pp. 6-2, 6-3, 6-15)
-  **Hook Button**
(→ pp. 6-15, 7-6)
-  **Start/Copy Button**
(→ pp. 10-2, 10-3)
-  **Stop Button**
(→ pp. 3-7, 10-3)
- **Numeric Button**
(→ p. 3-2)

Special Function Buttons

- **Data Registration Button** (→ p. 14-3)
- **Delayed Transmission Button** (→ pp. 7-14, 7-16, 7-17)
- **Polling Button** (→ pp. 9-10, 9-14)
- **Report Button** (→ pp. 6-17, 11-3, 14-2)

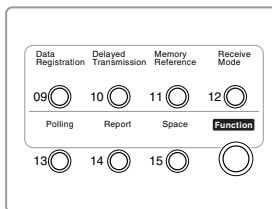

- **Memory Reference Button** (→ pp. 9-4, 9-5, 9-6, 9-8)
- **Receive Mode Button** (→ Chapter 8)
- **Space Button** (→ pp. 3-3, 3-4)
- **Function Button** (→ p. 3-6)

Installing the Toner Cartridge

This section describes how to install the toner cartridge in the FAX for the very first time. If you are replacing a used toner cartridge, see p. 12-6.

Before installing the toner cartridge, be sure to read the following:

- Use only FX-3 toner cartridges in your FAX.
- Keep the toner cartridge away from computer screens, disk drives, and floppy disks. The magnet inside the toner cartridge may harm these items.
- Do not store the toner cartridge in direct sunlight.
- Avoid locations subject to high temperature, high humidity, or rapid changes in temperature. Store the toner cartridge between 0°C and 35°C.
- Do not expose the toner cartridge to direct sunlight or bright light for longer than five minutes.
- Store the toner cartridge in its protective bag. Do not open the bag until you are ready to install the toner cartridge in the unit.
- Save the toner cartridge's protective bag in case you need to repack and transport the toner cartridge at a later date.
- Do not store the toner cartridge in a salty atmosphere or where there are corrosive gases such as from aerosol sprays.
- Do not remove the toner cartridge from the FAX unnecessarily.
- Do not open the drum protective shutter on the toner cartridge. Print quality may deteriorate if the drum surface is exposed to light or is damaged.

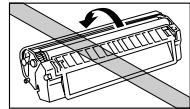

- Hold the toner cartridge as shown so that your hand is not touching the drum protective shutter.

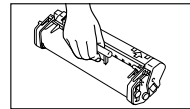

- Never touch the drum protective shutter. When holding the toner cartridge, avoid touching the drum protective shutter with your hands.

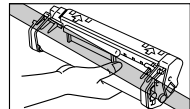

- Do not stand the toner cartridge on end, and do not turn it upside down. If toner becomes caked in the toner cartridge, it may prove impossible to free it even by shaking the toner cartridge.

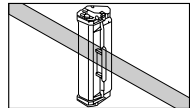

Do not place the toner cartridge in fire. Toner powder is flammable.

Follow this procedure to install the toner cartridge in the FAX:

- 1 Make sure the FAX is plugged in.
- 2 Lift the latch and open the front cover.

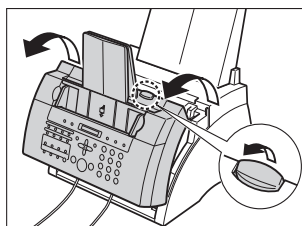

Do not open the front cover without lifting the latch since this may damage your unit.

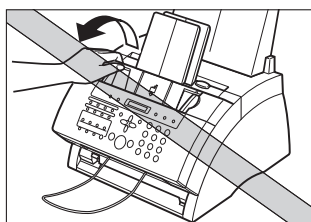

- 3 Remove the new FX-3 toner cartridge from its protective bag.
 - Save the protective bag in case you need to repack the toner cartridge at a later date.
- 4 Gently rock the toner cartridge from side to side a few times to distribute the toner evenly inside it.
 - Poor print quality may result if the toner is unequally distributed.

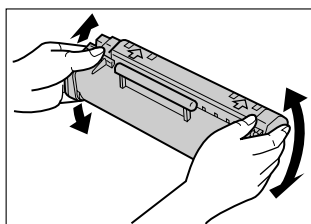

5 Place and support the toner cartridge on a flat, clean surface, then gently pull on the plastic tab to remove the plastic seal.

- Use a firm, even pull to avoid breaking the seal.

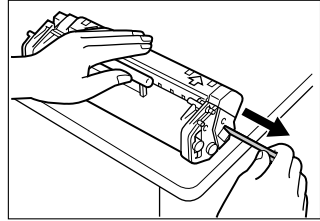

SIDE VIEW

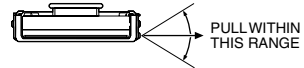

TOP VIEW

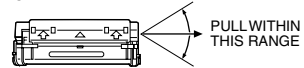

6 Hold the toner cartridge by its handle and insert it into the FAX as far as it will go, making sure that its tabs are aligned with the rails inside the unit.

- Always hold the toner cartridge by its handle.

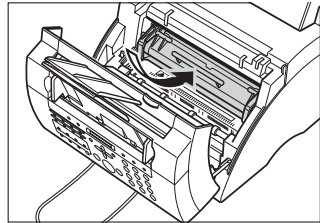

7 Use both hands to close the front cover.

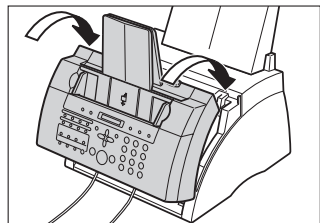

Loading Paper

This section explains how to load plain paper in the multi-purpose tray.

For complete details on paper requirements and selecting paper for your FAX, see Chapter 5.

Before loading paper, be sure to read the following:



The laser printing process uses high temperatures to fuse toner to the paper. Use paper that will not melt, vaporize, discolour, or emit dangerous fumes at temperatures near 170°C. For example, do not use vellum paper in a laser printer. Make sure any letterhead or coloured paper you use can withstand high temperatures.

- Your FAX supports regular copier paper, cotton bond paper, and typical letterhead paper. It does not require special paper. Use cut-sheet paper only, not paper that comes on a roll.
- Be sure to load paper of the correct size, weight, and quantity recommended for your FAX (→ Chapter 5).
- The multi-purpose tray is factory-set for loading A4-size paper, but you can change this setting to other paper sizes (→ p. 5-6).
- You can choose whether paper is delivered through the face-up or face-down delivery slot (→ p. 5-4). Choose according to the task you are performing.
- The face-down delivery slot can hold up to approximately 50 sheets of paper. To prevent paper jams, remove paper from this slot before the count reaches 50.
- Do not load paper while the FAX is printing.
- Do not leave paper stacked in the multi-purpose tray for long periods of time since it may bend or curl and cause problems.
- Certain environmental conditions, such as extreme temperatures or humidity, can cause some paper to misfeed in the multi-purpose tray. If you have trouble, feed one sheet at a time.
- Take care not to drop any foreign objects into the multi-purpose tray.
- Avoid mixing new stock with paper already loaded in the multi-purpose tray. Adding new stock without removing the paper already loaded will cause paper jams. If you must add new stock, remove the loaded paper and reload it together with the new stock.

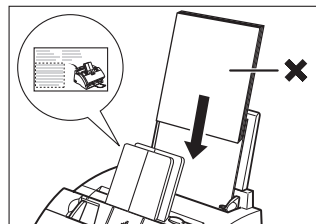

Follow this procedure to load a stack (maximum 10 mm stack height) of A4-size plain paper in the multi-purpose tray:

- 1 Remove the multi-purpose tray cover from the FAX. Prepare a stack of paper by tapping it on a flat surface to even its edges.

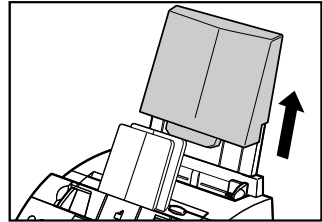

- 2 Open the paper guides to the approximate width of the stack.

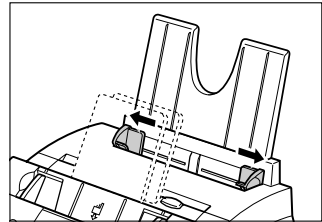

- 3 Insert the stack into the multi-purpose tray ① (print side facing you and top edge first), then adjust the paper guides to the width of the paper ②.
 - Make sure there are no gaps between the paper guides and the paper stack.

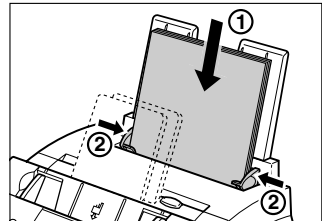

- 4 Replace the multi-purpose tray cover.
 - Be sure to replace this cover to prevent dust accumulating inside the unit.
- 5 Adjust the paper delivery selector if necessary (→ p. 5-4).

Your FAX is now ready to print.

Testing the FAX

Once you have assembled the FAX, installed the toner cartridge, and loaded paper, you can make sure the FAX is printing properly by making several copies of a document (→ p. 10-2). If you have problems in printing, see Chapter 13.

Chapter 3

Registering Information

❑ Guidelines for Entering Numbers, Letters, and Symbols	3-2
• Correcting a Mistake.....	3-4
❑ Registering Sender Information	3-5
• What is Sender Information?	3-5
• Entering the Date and Time	3-6
• Registering Your FAX Number and Name	3-6
❑ Setting the Telephone Line Type.....	3-8
❑ Dialling Through a Switchboard.....	3-9
• Registering the R Button	3-9
❑ Setting the Summer Time	3-11

Guidelines for Entering Numbers, Letters, and Symbols

When you come to a step that requires you to enter a name or number, refer to the table below to determine which numeric button to press for the character you want:

Button	Uppercase Letter Mode (:A)	Lowercase Letter Mode (:a)	Number Mode (:1)
①			1
②	ABCĂĂĂĂĂĂĂÆÇ	abcăăăăăăăăæç	2
③	DEFĐĚĚĚĚĚ	defďěěěěě	3
④	GHIÍÍÍÍ	ghiíííí	4
⑤	JKL	jkl	5
⑥	MNOŃŃŃŃŃŃŃ	mnoñññññññ	6
⑦	PQRSþ	pqrsþ	7
⑧	TUVÛÛÛÛÛ	tuvúúúúú	8
⑨	WXYZÝ	wxyzý	9
⑩			0
#	- . * # ! " , ; : ^ ` _ = / ' ? \$ @ % & + () [] { } < >		
*	Uppercase Letter Mode (:A) → Lowercase Letter Mode (:a) → Number Mode (:1)		



If you pause for more than 60 seconds between entering data, the unit will automatically return to standby mode.

■ Changing Between Number and Letter Modes

Press * to select number mode (:1), uppercase letter mode (:A), or lowercase letter mode (:a)

— :1
(Number mode)

— :A
(Uppercase letter mode)

— :a
(Lowercase letter mode)

■ Entering Letters

1 Press * to switch to uppercase letter mode (:A) or lowercase letter mode (:a).

Ex: — :A

2 Press the numeric button that contains the letter you want.

Ex: C :A

- Press repeatedly until the letter you want appears. Each button cycles through the letters it contains.
- If you are unsure which button to press for the letter you want, see p. 3-2.

3 Continue entering other letters using the numeric buttons.

Ex: CA :A

- If the next letter you want to enter is under a different numeric button, simply press that button until the letter you want appears.
-or-
If the next letter you want to enter is under the same numeric button you pressed in step 2, press ► to move the cursor to the right. Then press that same numeric button repeatedly until the letter you want appears.
- To enter a space, press **Function** then **Space**.

■ Entering Numbers

- 1 Press ***** to switch to number mode (: 1).
- 2 Press the numeric button that contains the number you want.
 - To enter a space, press **Function** then **Space**.
- 3 Continue entering other numbers using the numeric buttons.

— : 1

Ex: 1 : 1

Ex: 10 : 1

■ Entering Symbols

- 1 Press **#** repeatedly until the symbol you want appears.
- 2 If you want to enter another symbol, press **▶** to move the cursor to the right, then press **#** repeatedly until the symbol you want appears.

Ex: # : 1

Ex: # = : 1

Correcting a Mistake

You can delete an entire entry by pressing **C**. Alternatively, follow this procedure to correct individual characters:

- 1 Use **◀** or **▶** to move the cursor under the incorrect character.
- 2 Press the numeric button that contains the correct letter, to enter it over the incorrect character.
 - If you are unsure which button to press for the letter you want, see p. 3-2.
- 3 When you have finished making corrections, press **OK** to register your new entry.

Ex: CANEN : A

Ex: CANON : A

Registering Sender Information

What is Sender Information?

When you receive a fax, the name of the person or company who sent you the fax, their fax/telephone number, and the date and time of transmission may be printed in small type at the top of each page. This information is called the *Sender information* or the *Transmit Terminal Identification (TTI)*. Similarly, you can register your details in your FAX so that whenever you send a fax, the other party knows who sent it, and when it was sent. Below is an example of how your sender information would print on a fax sent from your unit:

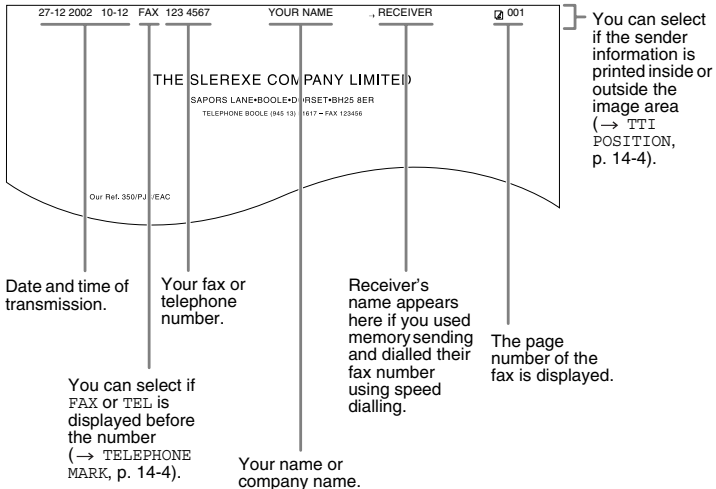

To enter the sender information in your FAX, follow the procedures on the following pages.

Entering the Date and Time

Follow this procedure to set the current date and time:

1 Press **Function**.

2 Press **Data Registration**.

DATA REGISTRATION

3 Press **OK** three times.

USER SETTINGS

- The date and time currently set for your FAX are displayed.

DATE & TIME

Ex: 20/12 2003 13:30

4 Use the numeric buttons to enter the correct day, month, year, and time in this order.*

Ex: 27/12 2003 15:00

- Enter only the last two digits of the year.
- Use the 24-hour format for the time (e.g. 1:00 p.m. as 13:00), and precede single digits with a zero.
- If you make a mistake, press **C** and re-enter the date and time.

5 Press **OK**.

DATA ENTRY OK

UNIT TELEPHONE #

6 Press **Stop** to return to standby mode.

Ex: 15:00 FaxOnly

Registering Your FAX Number and Name

Follow this procedure to register the fax/telephone number for your FAX, and your name or company name:

1 Press **Function**.

2 Press **Data Registration**.

DATA REGISTRATION

3 Press **OK** twice.

USER SETTINGS

DATE & TIME

* For certain countries, the date (day, month and year) is shown in a different order.

4 Use ▲ or ▼ to select UNIT TELEPHONE #.

UNIT TELEPHONE #

5 Press **OK**.

Ex: TEL=

6 Use the numeric buttons to enter your fax/telephone number (max. 20 digits, including spaces).

Ex: TEL= 123 4567

- To enter a space, press **Function** then **Space**. Spaces are optional but make the number easier to read.
- To enter a plus sign (+) before the number, press #.
- If you make a mistake, press **C** and re-enter the number.

7 Press **OK** twice.

DATA ENTRY OK

UNIT NAME

Ex: _ :A

8 Use the numeric buttons to enter your name or company name (max. 24 characters, including spaces).

Ex: CANON :A

- If you are unsure how to enter characters, see p. 3-2.
- If you make a mistake, press **C** and re-enter the name.

9 Press **OK**.

DATA ENTRY OK

TX TERMINAL ID

10 Press **Stop** to return to standby mode.

Ex: 15:00 FaxOnly



To check the sender information registered in your FAX, you can print the USER'S DATA LIST (→ p. 14-2).

Setting the Telephone Line Type

Before using your FAX, make sure it is set for the telephone line type of your telephone system. If you are unsure of your telephone line type, check with your local telephone company.

Follow this procedure if you need to change the telephone line type setting:

1 Press **Function**.

2 Press **Data Registration**.

DATA REGISTRATION

3 Press **OK** twice.

USER SETTINGS

DATE & TIME

4 Use ▼ or ▲ to select TEL LINE TYPE.

TEL LINE TYPE

5 Press **OK**.

Ex: TOUCH TONE

6 Use ▼ or ▲ to select the telephone line type setting you want.

- You can select from the following:
 - ROTARY PULSE* (For pulse dialling)
 - TOUCH TONE (For tone dialling)

7 Press **OK**.

R-KEY SETTING

8 Press **Stop** to return to standby mode.

Ex: 15:00 FaxOnly

*ROTARY PULSE is available for certain countries only.

Dialling Through a Switchboard

A PBX (Private Branch Exchange) is an on-site telephone switchboard. If your FAX is connected through a PBX or other telephone switching system, you have to dial the outside line access number first, and then the number of the party you are calling.

To facilitate this procedure, you can register the PBX access type and the outside line access number under the **R** button so that you only need to press this button before dialling the fax/telephone number you want to reach. See below for details.

Registering the R Button

Follow this procedure to register the PBX access type and outside line access number under the **R** button:

1 Press **Function**.

2 Press **Data Registration**.

DATA REGISTRATION

3 Press **OK** twice.

USER SETTINGS

DATE & TIME

4 Use ▼ or ▲ to select **R-KEY SETTING**.

R-KEY SETTING

5 Press **OK**.

Ex: PSTN

6 Use ▼ or ▲ to select **PBX**.

PBX

7 Press **OK**.

Ex: HOOKING

8 Use ▼ or ▲ to select the access type of your switching system.

- You can select from the following:
 - PREFIX
 - HOOKING

■ **If you selected HOOKING in step 8:**

9 Press **OK**.

REPORT SETTINGS

10 Press **Stop** to return to standby mode.

Ex: 15:00 FaxOnly

■ **If you selected PREFIX in step 8:**

9 Press **OK**.

10 Use the numeric buttons to enter the outside line access number (max. 19 digits).

Ex: 123456

11 Press **Redial/Pause** to enter a pause.

Ex: 123456P

12 Press **OK**.

REPORT SETTINGS

13 Press **Stop** to return to standby mode.

Ex: 15:00 FaxOnly

Setting the Summer Time*

Some countries adopt the summer time system that shifts the clock time ahead or back according to the change in seasons. You can select if the time information in your FAX changes to match your country's summer time system and set the day and time when the summer time begins and ends.

1 Press **Function**.

2 Press **Data Registration**.

DATA REGISTRATION

3 Press **OK**.

USER SETTINGS

4 Use ▼ or ▲ to select **SYSTEM SETTINGS**.

SYSTEM SETTINGS

5 Press **OK**.

UN/LOCK PHONE

6 Use ▼ or ▲ to select **SUMMER TIME**.

SUMMER TIME

7 Press **OK**.

Ex: ON

8 Use ▼ or ▲ to select the setting you want.

Ex: ON

- You can select from the following:
 - ON
Enables the summer time.
 - OFF
Disables the summer time.

■ **If you selected OFF in step 8:**

9 Press **OK**.

TEL REGISTRATION

10 Press **Stop** to return to standby mode.

Ex: 15:00 FaxOnly

*The Summer Time feature is available for certain countries only.

■ **If you selected ON in step 8:**

9 Press **OK** three times.

BEGIN DATE/TIME

MONTH

Ex: MARCH

10 Use ▼ or ▲ to select the month in which the summer time starts.

Ex: APRIL

11 Press **OK** twice.

WEEK

Ex: LAST WEEK

12 Use ▼ or ▲ to select the week in which the summer time starts.

Ex: FIRST WEEK

- You can select from the following:
 - FIRST WEEK
 - SECOND WEEK
 - THIRD WEEK
 - FOURTH WEEK
 - LAST WEEK (fourth or fifth week depending on the selected month)

13 Press **OK** twice.

DAY

Ex: SUNDAY

14 Use ▼ or ▲ to select the day of the week on which the summer time starts.

Ex: SUNDAY

15 Press **OK** twice.

TIME

Ex: 01:00

16 Use the numeric buttons to enter the time at which the summer time compensation is made.

Ex: 02:00

- Use the 24-hour format for the time (e.g., 2:00 p.m. as 14:00) and precede single digits with a zero.

17 Press **OK** three times.

END DATE/TIME

MONTH

Ex: OCTOBER

18 Use ▼ or ▲ and **OK** to select the month, week, day of the week, and time when the summer time ends, as in steps 10 to 16 for the BEGIN DATE/TIME settings. (e.g. OCTOBER LAST WEEK, SUNDAY and 03 : 00)

19 Press **OK**.

TEL REGISTRATION

20 Press **Stop** to return to standby mode.

Ex: 15 : 00 FaxOnly

Chapter 4

Document Handling

□ Document Requirements	4-2
• Scanned Area of a Document	4-2
□ Loading Documents	4-3
• Adding Pages to the Document in the ADF	4-4

Document Requirements

The documents you load in the ADF for sending and copying must meet the following requirements:

	One-page document	Multipage document of the same thickness and weight
Size (W × L)	Max. 216 mm × Approx. 1 m Min. 148 × 105 mm	Max. 216 × 355.6 mm Min. 148 × 105 mm
Quantity	1 sheet	Max. 30 A4- or letter-size sheets* Max. 10 legal-size sheets*
Thickness	0.06 to 0.23 mm	0.06 to 0.13 mm
Weight	35 to 240 g/m ²	40 to 90 g/m ²

■ Problem Documents

- To prevent document jams in the ADF, do not use any of the following:
 - Wrinkled or creased paper
 - Curled or rolled paper
 - Torn paper
 - Carbon paper or carbon-backed paper
 - Coated paper
 - Onion skin or thin paper
- Remove all fasteners (staples, paper clips, etc.) before loading the document in the ADF.
- Make sure any glue, ink, or correction fluid on the document is completely dry before loading it in the ADF.
- If you have a document that will not feed properly in the ADF, make a photocopy of the document and load the copy instead.
- If you will be sending a document that you have printed from your FAX, be sure to use face-down delivery when printing that document (→ p. 5-4).

Scanned Area of a Document

The shaded area shows the scanned area of a document. Make sure your document's text and graphics fall within this area.

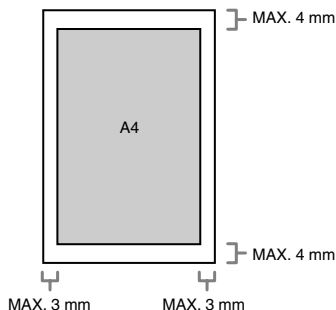

* 75 g/m² paper

Loading Documents

Follow this procedure to load documents in the ADF:

- 1 Adjust the document guides to the width of the document.

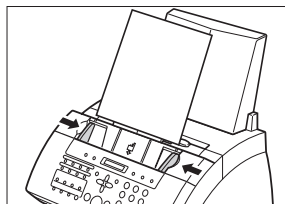

- 2 Gently insert the top of the document, face down, in the ADF until you hear a beep.

- Tap multipage documents on a flat surface to even the edges before inserting them in the ADF.

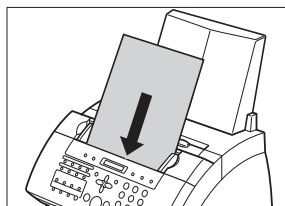

The document is now ready for scanning.



- For a multipage document, the pages are fed one by one from the bottom of the stack.
- Wait until all pages of your document have been scanned before starting a new job.

■ Problems With Multipage Documents

If you have trouble feeding multipage documents in the ADF, remove the stack and tap it on a flat surface to even the edges. Then “slant” the stack so that its front edge is bevelled, and insert the stack in the ADF.

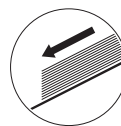
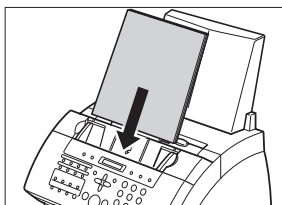
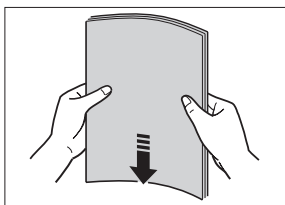

To avoid feeding problems, make sure the document meets the document requirements (→ p. 4-2).

Adding Pages to the Document in the ADF

If you need to add pages to your document in the ADF, wait until the last page starts feeding, then load up to 30 additional pages (10 legal size). The last and first page should overlap by about 2.5 cm.

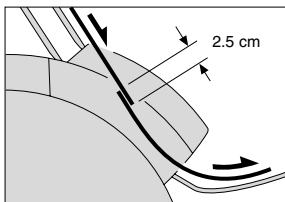

Chapter 5

Paper Handling

<input type="checkbox"/> Paper Requirements	5-2
• Printable Area	5-3
<input type="checkbox"/> Selecting Paper for Your FAX.....	5-3
<input type="checkbox"/> Loading Paper	5-3
<input type="checkbox"/> Selecting Face-Up or Face-Down Paper Delivery	5-4
<input type="checkbox"/> Changing the Paper Size Setting.....	5-6
<input type="checkbox"/> Adjusting the Toner Saver Setting.....	5-8

Paper Requirements

You can load the following paper in the multi-purpose tray:

Paper Size Setting	Size (W × L)	Weight	Quantity
	Min. 92.4 × 127 mm Max. 216 × 356 mm	64-90 g/m ² 1 sheet: 64-105 g/m ²	Max. stack height: 10 mm (Approx. 100 sheets of 75 g/m ² paper)
A4	210 × 297 mm/ (8.27 × 11.69 in.)		
LTR (Letter)	215.9 × 279.4 mm (8.5 × 11 in.)		
LGL (Legal)	215.9 × 355.6 mm (8.5 × 14 in.)		
CUSTOM1/LONG*	216 × 317 mm to 216 × 340 mm*		
CUSTOM2/SHORT*	216 × 254 mm to 216 × 285 mm*		

Once you have decided which paper you want to load, be sure to do the following:

- Check that your paper is compatible with the FAX (→ p. 5-3).
- Check that the paper size setting of the multi-purpose tray is set for the paper size you are loading (→ p. 5-6).
- Check that paper delivery is set correctly for the task you are performing (→ p. 5-4).
- Check that you have loaded the paper correctly in the multi-purpose tray (→ p. 2-15).

*For this setting, you may need to load fewer sheets.

Printable Area

The shaded area shows the printable area of A4-size paper.

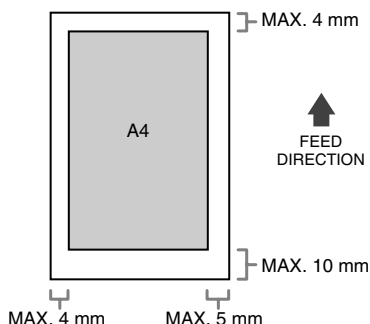

Selecting Paper for Your FAX

Follow these guidelines when selecting paper:

- To prevent paper jams in the multi-purpose tray, do not use any of the following:
 - Wrinkled or creased paper
 - Coated paper
 - Damp paper
 - Curled or rolled paper
 - Torn paper
 - Onion skin or very thin paper
- The following types of paper do not print well:
 - Highly textured paper
 - Shiny paper
 - Very smooth paper
- Make sure the paper is free from dust, lint, and oil stains.
- Be sure to test paper before purchasing large quantities.
- Store all paper wrapped and on a flat surface until ready to use. Keep opened packs in their original packaging, in a cool, dry location.
- Store paper at 18°C-24°C, 40%-60% relative humidity.

Loading Paper

For instructions on loading paper in the multi-purpose tray, see p. 2-15.

Selecting Face-Up or Face-Down Paper Delivery

■ Paper Path

Understanding how paper feeds through the FAX will help you determine which paper delivery slot is appropriate for the task you are performing.

First, the paper travels to the toner cartridge where a laser beam “draws” the print image on the drum, which in turn applies toner to the paper. The paper travels to the fixing assembly where the toner is “fixed” (fused) to the paper. The paper then exits the FAX through the face-up delivery slot (front of the unit) or the face-down delivery slot (top of the unit).

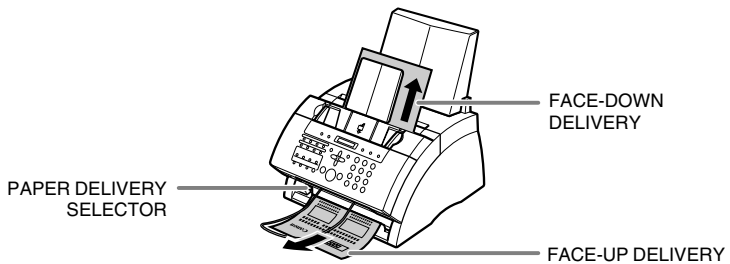

■ Selecting Paper Delivery

Before selecting paper delivery, be sure to take note of the following:

- Always set the paper delivery selector before printing (→ below).
- Changing paper delivery while the unit is printing will cause problems. Wait for the printout to exit the unit completely before changing paper delivery.
- The face-down delivery slot can hold up to approximately 50 sheets of paper. To prevent paper jams, remove paper from this slot before the count reaches 50.
- Make sure there is enough room for the paper to exit from the face-up delivery slot. Remove each sheet as it is delivered from this slot.
- Never pull the paper as it comes out of the unit.

Choose paper delivery according to the task you are performing.

Select face-up or face-down delivery with the paper delivery selector.

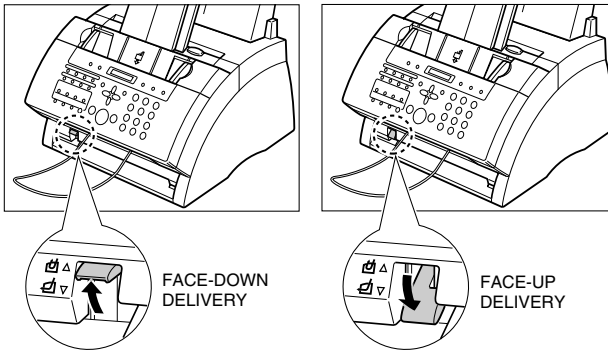

When using face-up delivery, you must remove each sheet as it is delivered. Failure to do this may cause jams in the face-up delivery slot and result in damage to your unit.



You can also use face-up delivery when copying or receiving a large number of pages. In this case, place the FAX near the edge of a table so that the pages can fall away from the unit and avoid blocking the face-up delivery slot. You may want to place a box below the FAX so that the pages can collect in it.

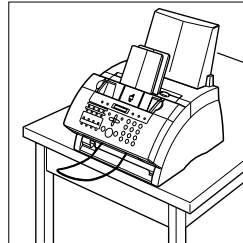

Changing the Paper Size Setting

The multi-purpose tray is factory-set for loading A4-size paper. If you want to load a different paper size (→ p. 5-2), follow this procedure to change the paper size setting:

1 Press **Function**.

2 Press **Data Registration**.

DATA REGISTRATION

3 Press **OK**.

USER SETTING

4 Use ▼ or ▲ to select **PRINTER SETTINGS**.

PRINTER SETTINGS

5 Press **OK**.

RX REDUCTION

6 Use ▼ or ▲ to select **PAPER SIZE**.

PAPER SIZE

7 Press **OK**.

Ex: A4

8 Use ▼ or ▲ to select the paper size you want for the multi-purpose tray.

- You can select from the following:
 - A4 (Default)
 - LTR
 - LGL
 - CUSTOM
- For details on the paper sizes above, see p. 5-2

■ **If you selected A4, LTR, or LGL in step 8:**

9 Press **OK**.

ECONOMY PRT

10 Press **Stop** to return to standby mode.

Ex: 15:00 FaxOnly

■ **If you selected CUSTOM in step 8:**

9 Press **OK**.

Ex: CUSTOM1/LONG

10 Use ▼ or ▲ to select the custom paper size setting.

- You can select from the following:
 - CUSTOM1/LONG (Default)
 - CUSTOM2/SHORT
- For details on the paper sizes above, see p. 5-2.

11 Press **OK**.

ECONOMY PRT

12 Press **Stop** to return to standby mode.

Ex: 15:00 FaxOnly

Adjusting the Toner Saver Setting

By enabling the toner saver setting, you can reduce toner consumption of the toner cartridge by approximately 30% to 40%. This will extend the toner cartridge life.



By enabling this setting, print quality will be reduced. For highest print quality, disable this setting.

Follow this procedure to enable or disable the toner saver setting:

1 Press **Function**.

2 Press **Data Registration**.

DATA REGISTRATION

3 Press **OK**.

USER SETTINGS

4 Use ▼ or ▲ to select **PRINTER SETTINGS**.

PRINTER SETTINGS

5 Press **OK**.

RX REDUCTION

6 Use ▼ or ▲ to select **ECONOMY PRT**.

ECONOMY PRT

7 Press **OK**.

Ex: OFF

8 Use ▼ or ▲ to select the setting you want.

- You can select from the following:
 - ON (Enable toner saving)
 - OFF (Disable toner saving)

9 Press **OK**.

TONER SUPPLY LOW

10 Press **Stop** to return to standby mode.

Ex: 15:00 FaxOnly

Chapter 6

Speed Dialling

❑ What is Speed Dialling?.....	6-2
• Speed Dialling Methods	6-2
❑ Registering One-Touch Speed Dialling	6-3
❑ Registering Coded Speed Dialling	6-7
❑ Registering Group Dialling	6-11
❑ Using Speed Dialling	6-14
• Sending a Document With Speed Dialling	6-14
• Making a Telephone Call With Speed Dialling.....	6-15
❑ Dialling with the Directory	6-16
❑ Printing Speed Dialling Lists	6-17

What is Speed Dialling?

Instead of having to dial a fax or telephone number using regular dialling (i.e. with the numeric buttons), you can simplify the dialling procedure by registering the fax/telephone number for speed dialling. This will reduce the number of buttons you need to press to dial the fax/telephone number, making it convenient for frequently dialled numbers.

Speed Dialling also allows you to register several fax numbers under one speed dialling button or code so that you can send a document to all those fax numbers in one operation.

See below for details on the different speed dialling methods.

Speed Dialling Methods

Your FAX offers the following speed dialling methods:

■ One-Touch Speed Dialling (p. 6-3)

Register a fax/telephone number under a one-touch speed dialling button so that you only have to press one button to dial that fax/telephone number.

There are 15 one-touch speed dialling buttons available for you to register fax/telephone numbers.

■ Coded Speed Dialling (p. 6-7)

Register a fax/telephone number under a coded speed dialling code so that you only have to press Coded Dial and enter the registered two-digit code (using the numeric buttons) to dial that fax/telephone number.

There are 100 codes available for you to register fax/telephone numbers.

■ Group Dialling (p. 6-11)

“Group” up to 114 fax numbers together, so you can send to those fax numbers in one quick operation. A group is registered under a one-touch speed dialling button or a coded speed dialling code.

Registering One-Touch Speed Dialling

By registering a fax/telephone number under a one-touch speed dialling button, you can simplify dialling of that number to the press of a single button.

When you register one-touch speed dialling, you will:

- assign one of the 15 one-touch speed dialling buttons for the fax/telephone number you want to register.
- register the fax/telephone number under that one-touch speed dialling button.
- register a name for the one-touch speed dialling button. This name appears in speed dialling lists, in reports, and at the top of the recipient's fax if you use memory sending (→ p. 7-5).
- set the transmission type for the fax number you have registered. You can set a subaddress and/or password if the other party's fax machine requires these settings.

Follow this procedure to register one-touch speed dialling:

1 Press **Function**.

2 Press **Data Registration**.

DATA REGISTRATION

3 Use ▼ or ▲ to select **TEL REGISTRATION**.

TEL REGISTRATION

4 Press **OK** twice.

1-TOUCH SPD DIAL

Ex: 01=

5 Use ▼ or ▲ to select the one-touch speed dialling button (01 to 15) under which you want to register the fax/telephone number.

Ex: 04=

- If a one-touch speed dialling button has already been registered, the number registered under that button appears.
- If a group is already registered under a one-touch speed dialling button, **GROUP DIAL** appears.

6 Press **OK** twice.

TELEPHONE NUMBER

Ex: TEL= _

7 Use the numeric buttons to enter the fax/telephone number you want to register (max. 120 digits, including spaces and pauses).

Ex:

- To enter a space, press **Function** then **Space**. Spaces are optional and are ignored during dialling.
- To enter a pause, press **Redial/Pause** (→ p. 9-2).
- To correct a mistake in the number, press ◀ to delete the rightmost digit. Alternatively, press **C** to delete the entire number.
- To cancel one-touch speed dialling for the button you selected, press **C** then **OK**. Press **Stop** to return to standby mode. The fax/telephone number and name registered under that button will be deleted.
- If you have already registered a number that you want to keep, ignore this step.

8 Press **OK** twice.

Ex:

9 Use the numeric buttons to enter a name for the one-touch speed dialling button (max. 16 characters, including spaces).

Ex:

- If you are unsure how to enter characters, see p. 3-2.
- If you have already registered a name that you want to keep, ignore this step.

10 Press **OK**.

11 This completes the basic one-touch speed dialling settings.

To continue registering other one-touch speed dialling buttons, press **Function** then **Data Registration** and repeat the procedure from step 5.

-or-

To end registering one-touch speed dialling buttons, press **Stop** to return to standby mode.

-or-

To register the transmission type for the current button you are registering, continue with the steps below.

Ex:

Ex:

12 Press **OK**.

Ex:

13 Use ▼ or ▲ to select **ON**.

14 Press **OK** twice.

Ex:

15 Use ▼ or ▲ to select the transmission type setting you want.

- You can select from the following:
 - **REGULAR TX**
Normal transmission. (Choose this setting if you previously set **PSWD/SUBADDRESS** and no longer want to send with this setting.)
 - **PSWD/SUBADDRESS**
Transmission with a subaddress and/or password. For details, see the following page.

■ **If you selected REGULAR TX in step 15:**

16 Press **OK**.

Ex:

17 Press **Stop** to return to standby mode.

Ex:

■ **If you selected PSWD/SUBADDRESS in step 15:**

The other party's fax machine may require an ITU-T standard subaddress and/or password to receive faxes. The subaddress/password you register here must match exactly the one(s) registered on the other party's fax machine. Contact the other party to check their settings.

When sending with a subaddress/password, the other party's fax machine receives the fax only if your subaddress/password matches theirs. Their fax machine then handles the received fax according to the feature they are using.

You also need to register a subaddress/password when polling a fax machine that requires these settings (→ p. 9-9).

Continue with the steps below to register a subaddress/password:

16 Press **OK** twice.

SUBADDRESS

17 If a subaddress is required, use the numeric buttons to enter it.

Ex: 1234

- If a subaddress is not required, ignore this step.
- If you have already registered a subaddress that you want to keep, ignore this step.

18 Press **OK** twice.

PASSWORD

19 If a password is required, use the numeric buttons to enter it.

Ex: 4321

- If a password is not required, ignore this step.
- If you have already registered a password that you want to keep, ignore this step.

20 Press **OK**.

Ex: 05=

21 To continue registering other one-touch speed dialling buttons, repeat the procedure from step 5.

Ex: 15:00 FaxOnly

-or-
Press **Stop** to return to standby mode.



- Use the destination labels provided with your FAX to label the one-touch speed dialling buttons. Stick the labels above each corresponding button.
- To check your entries, you can print a list of all the numbers and names registered for one-touch speed dialling (→ p. 6-17).

Registering Coded Speed Dialling

By registering a fax/telephone number under a coded speed dialling code, you can simplify dialling of that number to pressing **Coded Dial** and entering the registered two-digit code.

When you register coded speed dialling, you will:

- assign one of the 100 codes for the fax/telephone number you want to register.
- register the fax/telephone number under that coded speed dialling code.
- register a name for the coded speed dialling code. This name appears in speed dialling lists, in reports, and at the top of the recipient's fax if you use memory sending (→ p. 7-5).
- set the transmission type for the fax number you have registered. You can set a subaddress and/or password if the other party's fax machine requires these settings.

Follow this procedure to register coded speed dialling:

1 Press **Function**.

2 Press **Data Registration**.

DATA REGISTRATION

3 Use ▼ or ▲ to select **TEL REGISTRATION**.

TEL REGISTRATION

4 Press **OK**.

1-TOUCH SPD DIAL

5 Use ▼ or ▲ to select **CODED SPEED DIAL**.

CODED SPEED DIAL

6 Press **OK**.

Ex: *00=

7 Use ▼ or ▲ to select the coded speed dialling code (00 to 99) under which you want to register the fax/telephone number.

Ex: *01=

- Alternatively, press **Coded Dial** and use the numeric buttons to enter the code.
- If a coded speed dialling code has already been registered, the number registered under that code appears.
- If a group is already registered under a coded speed dialling code, **GROUP DIAL** appears.

8 Press **OK** twice.

TELEPHONE NUMBER

Ex: TEL= _

9 Use the numeric buttons to enter the fax/telephone number you want to register (max. 120 digits, including spaces and pauses).

Ex: TEL=3 3758 2111 _

- To enter a space, press **Function** then **Space**. Spaces are optional and are ignored during dialling.
- To enter a pause, press **Redial/Pause** (→ p. 9-2).
- To correct a mistake in the number, press **◀** to delete the rightmost digit. Alternatively, press **C** to delete the entire number.
- To cancel coded speed dialling for the code you selected, press **C** then **OK**. Press **Stop** to return to standby mode. The fax/telephone number and the name registered under that code will be deleted.
- If you have already registered a number that you want to keep, ignore this step.

10 Press **OK** twice.

DATA ENTRY OK

NAME

Ex: _ :A

11 Use the numeric buttons to enter a name for the coded speed dialling code (max. 16 characters, including spaces).

Ex: Canon Inc_ :a

- If you are unsure how to enter characters, see p. 3-2.
- If you have already registered a name that you want to keep, ignore this step.

12 Press **OK**.

DATA ENTRY OK

OPTIONAL SETTING

13 This completes the basic coded speed dialling settings.

To continue registering other coded speed dialling codes, press **Function** then **Data Registration** and repeat the procedure from step 7.

-or-

To end registering coded speed dialling codes, press **Stop** to return to standby mode.

-or-

To register the transmission type for the current code you are registering, continue with the steps below.

Ex: *02=

Ex: 15:00 FaxOnly

14 Press **OK**.

Ex: OFF

15 Use ▼ or ▲ to select ON.

ON

16 Press **OK** twice.

TX TYPE

Ex: REGULAR TX

17 Use ▼ or ▲ to select the transmission type setting you want.

- You can select from the following:
 - REGULAR TX
Normal transmission. (Choose this setting if you previously set PSWD/SUBADDRESS and no longer want to send with this setting.)
 - PSWD/SUBADDRESS
Transmission with a subaddress and/or password. For details, see the following page.

■ **If you selected REGULAR TX in step 17:**

18 Press **OK**.

Ex: *02=

19 Press **Stop** to return to standby mode.

Ex: 15:00 FaxOnly

■ **If you selected PSWD/SUBADDRESS in step 17:**

The other party's fax machine may require an ITU-T standard subaddress and/or password to receive faxes. The subaddress/password you register here must match exactly the one(s) registered on the other party's fax machine. Contact the other party to check their settings.

When sending with a subaddress/password, the other party's fax machine receives the fax only if your subaddress/password matches theirs. Their fax machine then handles the received fax according to the feature they are using.

You also need to register a subaddress/password when polling a fax machine that requires these settings (→ p. 9-9).

Continue with the steps below to register a subaddress/password:

18 Press **OK** twice.

SUBADDRESS

19 If a subaddress is required, use the numeric buttons to enter it.

Ex:

- If a subaddress is not required, ignore this step.
- If you have already registered a subaddress that you want to keep, ignore this step.

20 Press **OK** twice.

PASSWORD

21 If a password is required, use the numeric buttons to enter it.

Ex:

- If a password is not required, ignore this step.
- If you have already registered a password that you want to keep, ignore this step.

22 Press **OK**.

Ex:

23 To continue registering other coded speed dialling codes, repeat the procedure from step 7.

Ex:

-or-
Press **Stop** to return to standby mode.



To check your entries, you can print a list of all the numbers and names registered for coded speed dialling (→ p. 6-17). You may want to keep this list near your FAX to refer to it when dialling.

Registering Group Dialling

If you frequently send documents to the same group of fax numbers, you can “group” these numbers under a one-touch speed dialling button or coded speed dialling code. You can then send to all the fax numbers in the group in one quick and simple operation.

When you register group dialling, you will:

- assign a one-touch speed dialling button or a coded speed dialling code for the group of fax numbers you want to register.
- group up to 114 fax numbers under that button or code. The fax numbers must already be registered for one-touch or coded speed dialling (i.e. you cannot enter the fax numbers with the numeric buttons).
- register a name for the group. This name appears in speed dialling lists.

Follow this procedure to register group dialling:

1 Press **Function**.

2 Press **Data Registration**.

DATA REGISTRATION

3 Use ▼ or ▲ to select **TEL REGISTRATION**.

TEL REGISTRATION

4 Press **OK**.

1-TOUCH SPD DIAL

5 Use ▼ or ▲ to select **GROUP DIAL**.

GROUP DIAL

6 Press **OK**.

Ex: 01=1-TOUCH SPD

7 Select a one-touch speed dialling button or coded speed dialling code under which you want to register the group.

❑ **To register a group under a one-touch speed dialling button:**

Use ▼ or ▲ to select the one-touch speed dialling button (01 to 15) under which you want to register the group.

- If a one-touch speed dialling button has already been registered, 1-TOUCH SPD or GROUP DIAL appears.

Ex: 03=

❑ **To register a group under a coded speed dialling code:**

Press **Coded Dial**, then use the numeric buttons to enter the coded speed dialling code (00 to 99) under which you want to register the group.

Ex:

- If a coded speed dialling code has already been registered, CODED SPEED or GROUP DIAL appears.



If you wish to register a group under a button or code already registered for speed dialling, you must delete the previous information first (→ pp. 6-4, 6-8).

8 Press **OK** twice.

Ex:

9 Enter the one-touch and/or coded speed dialling numbers you want to register in the group.

❑ **To enter a fax number registered for one-touch speed dialling:**

Press the one-touch speed dialling button(s) assigned to the number(s) you want to register in the group.

Ex:

❑ **To enter a fax number registered for coded speed dialling:**

Press **Coded Dial**, then use the numeric buttons to enter the two-digit code assigned to the number you want to register in the group. Repeat for other codes.

Ex:

- The number registered under the button or code you enter appears.
- You can also enter groups registered under buttons or codes. In this case, GROUP DIAL appears.
- You cannot enter numbers not registered for one-touch or coded speed dialling (i.e. with the numeric buttons).

- To add fax numbers to a previously registered group, simply enter them as explained in this step.
- If you enter the wrong destination, or if you want to delete a destination already registered in a group, use ▼ or ▲ to select that entry, then press C.
- To cancel group dialling for the button or code you selected, press C until all entries are deleted, then press **OK**. Press **Stop** to return to standby mode. All fax numbers and the name of the group registered under that button or code will be deleted.

10 Press **OK** twice.

NAME

Ex: _ :A

11 Use the numeric buttons to enter a name for the group (max.16 characters, including spaces).

Ex: Canon GROUP 2_ :1

- If you are unsure how to enter characters, see p. 3-2.
- If you have already registered a name that you want to keep, ignore this step.

12 Press **OK**.

DATA ENTRY OK

Ex: 04=1-TOUCH SPD

13 To continue registering other groups, repeat the procedure from step 7.

-or-

Press **Stop** to return to standby mode.

Ex: 15:00 FaxOnly



- If you registered groups under one-touch speed dialling buttons, use the destination labels provided with your FAX to label the buttons. Stick the labels above each corresponding button.
- To check your entries, you can print a list of all the numbers and names registered for group dialling (→ p. 6-17). You may want to keep this list near your FAX to refer to it when dialling.

Using Speed Dialling

Once you have registered fax/telephone numbers for one-touch speed dialling (→ p. 6-3), coded speed dialling (→ p. 6-7), or group dialling (→ p. 6-11), you can begin to send documents or make telephone calls with speed dialling.

Sending a Document With Speed Dialling

Follow this procedure to send a document using one-touch speed dialling, coded speed dialling, or group dialling:

1 Load the document, face down in the ADF (→ p. 4-3).

- To adjust the resolution and contrast, see pp. 7-2, 7-3.
- You may be unable to send if the memory used (shown in the LCD) is close to 100%. To free up space in the FAX's memory: print, send, or delete any documents you no longer need to be stored in memory (→ p. 9-4).

Ex:

MEMORY USED 0%

(Currently used memory)

DOCUMENT READY

(Standby to scan)

2 Enter the one-touch speed dialling button or coded speed dialling code assigned to the fax number or group you want to send to.

One-touch speed dialling button:

Press the one-touch speed dialling button you want.

Coded speed dialling code:

Press **Coded Dial**, then use the numeric buttons to enter the two-digit code you want.

- If you make a mistake, press **Stop** and repeat this step.
- NO TEL # appears if no fax/telephone number or group is assigned to the speed dialling button or code you pressed.

3 Press **Start/Copy** to begin scanning for sending, or wait a few seconds for the FAX to begin scanning automatically.

- If you do not want the FAX to begin scanning automatically after a few seconds, disable the TIME OUT setting (→ p. 14-6).

Making a Telephone Call With Speed Dialling

Follow this procedure to dial a telephone number registered for one-touch or coded speed dialling on your FAX:

- 1** Make sure you have connected the optional handset or a telephone to the FAX (→ p. 2-5).
- 2** Press **Hook**.
 - You can also lift the handset instead of pressing **Hook**.
- 3** Enter the one-touch speed dialling button or coded speed dialling code assigned to the telephone number you want to dial.
 - One-touch speed dialling button:**
Press the one-touch speed dialling button you want.
 - Coded speed dialling code:**
Press **Coded Dial**, then use the numeric buttons to enter the two-digit code you want.
 - If you make a mistake, press **Hook** or hang up the handset and start again from step 2.
 - NO TEL # appears if no fax/telephone number is assigned to the speed dialling button or code you pressed.
 - NOT AVAILABLE appears if you entered a speed dialling button or code assigned to a group of fax numbers.
- 4** When you hear the other party answer the call, pick up the handset to start talking.
- 5** When you finished, simply hang up.

TEL=

Dialling with the Directory

If you forget under which of the one-touch speed dialling buttons, coded speed dialling codes, or groups that you registered a fax/telephone number, you can dial the correct number just knowing the other party's name, using the directory function.

Also, you can look up the fax/telephone number of the other party.

Follow this procedure to send a document with the directory function:

1 Load the document, face down in the ADF
(→ p. 4-3).

- To adjust the resolution and contrast, see pp. 7-2, 7-3.

2 Press **Directory**.

1ST LETT OF NAME

3 Use the numeric buttons to enter the first letter of the other party's name you are looking for.

04=Canon EUROPA

4 Press ▼ or ▲ to scroll through the names until the name you are looking for appears.

*01=Canon Inc.

- If you press ▼ when the last entry in the directory is displayed, the list returns to the first entry in the directory.
- A two-digit number appears next to the name registered under a one-touch speed dialling button. An asterisk (*) and a two-digit number appear next to the name registered under a coded speed dialling code.
- After the name appears, you can display the registered fax/telephone number by pressing ◀ or ▶ .

5 Press **Start/Copy** twice to begin scanning for sending, or wait a few seconds for the FAX to begin scanning automatically.

Printing Speed Dialling Lists

To check the fax/telephone numbers and names registered for speed dialling, you can print the speed dialling lists. You may want to keep these lists near your FAX to refer to them when dialling.

Follow this procedure to print speed dialling lists:

1 Press **Function**.

2 Press **Report**.

ACTIVITY REPORT

3 Use ▼ or ▲ to select **SPEED DIAL LIST**.

SPEED DIAL LIST

4 Press **OK**.

1-TOUCH LIST

5 Use ▼ or ▲ to select the list you want to print.

- You can select from the following:
 - 1-TOUCH LIST
 - CODED DIAL LIST
 - 1-TOUCH (DETAIL)
 - CODED (DETAIL)
 - GROUP DIAL LIST

■ If you selected **GROUP DIAL LIST** in step 5:

6 Press **OK**.

- The FAX prints the list.

■ If you selected a list other than **GROUP DIAL LIST** in step 5:

6 Press **OK**.

SORTED OUTPUT

YES= (*) NO= (#)

7 Select in what order you want the lists to be printed.

Press * to print the list with the destination names (CONNECTION ID on the reports) in alphabetical order (sorted).

-or-

Press # to print the list in code or button order (unsorted).

- The FAX prints the list.

Samples of the lists are shown on the following pages.

■ 1-TOUCH SPD DIAL LIST 1

27/12 2002 17:23 FAX 123 4567		CANON		001
27/12 2002 17:23 FAX 123 4567		CANON		001

*** 1-TOUCH SPD DIAL LIST 1 ***				

NO.	CONNECTION TEL	CONNECTION ID	TX TYPE	
[01] 905 7		Canon AUSTRALIA	REGULAR TX	
[03] GROU		Canon CANADA	REGULAR TX	
[04] 2 509		Canon GROUP 2	REGULAR TX	
[05] 1 432		Canon ITALIA	REGULAR TX	
[12] 2 887		Canon OPTICS	PSWD/SUBADD.	

IF YOU PRESS # IN STEP 7
(→ p. 6-17), THE DESTINATIONS ARE
LISTED IN BUTTON ORDER
(UNSORTED).

IF YOU PRESS * IN STEP 7
(→ p. 6-17), THE DESTINATIONS ARE
LISTED IN ALPHABETICAL ORDER
(SORTED).

■ 1-TOUCH SPD DIAL LIST 2 (Detailed List)

27/12 2002 17:23 FAX 123 4567		CANON		001
27/12 2002 17:23 FAX 123 4567		CANON		001

*** 1-TOUCH SPD DIAL LIST 2 ***				

[01] COI	[12] CONNECTION TEL	2 887 0166		
[03] COI	CONNECTION ID	Canon AUSTRALIA		
[04] COI	TX TYPE	REGULAR TX		
[05] COI	[01] CONNECTION TEL	905 795 1111		
[12] COI	CONNECTION ID	Canon CANADA		
TX	TX TYPE	REGULAR TX		
	[03] CONNECTION TEL	GROUP DIAL		
	CONNECTION ID	Canon GROUP 2		
	[04] CONNECTION TEL	2 50921		
	CONNECTION ID	Canon ITALIA		
	TX TYPE	REGULAR TX		
	[05] CONNECTION TEL	1 432 2060		
	CONNECTION ID	Canon OPTICS		
	TX TYPE	PSWD/SUBADD.		
	SUBADDRES	1323		

IF YOU PRESS # IN STEP 7
(→ p. 6-17), THE DESTINATIONS ARE
LISTED IN BUTTON ORDER
(UNSORTED).

IF YOU PRESS * IN STEP 7
(→ p. 6-17), THE DESTINATIONS ARE
LISTED IN ALPHABETICAL ORDER
(SORTED).

■ CODED SPEED DIAL LIST 1

27/12 2002 17:23 FAX 123 4567		CANON		001
27/12 2002 17:23 FAX 123 4567		CANON		001
***** *** CODED SPEED DIAL LIST 1 *** *****				
NO.	CONNECTION TEL	CONNECTION ID	TX TYPE	
[* 00]	2131 1250	Canon DEUTSCH.	REGULAR TX	
[* 01]	1 49 39 25 25	Canon FRANCE	REGULAR TX	
[* 02]	GROUP DIAL	Canon GROUP 1	REGULAR TX	
[* 03]	03 3758 2111	Canon TOKYO	REGULAR TX	
[* 21]	516p488 6700	Canon U.S.A.	REGULAR TX	
[* 32]	81 773 3173	Canon UK	PSWD/SUBADD.	

IF YOU PRESS # IN STEP 7
(→ p. 6-17), THE DESTINATIONS ARE
LISTED IN CODE ORDER
(UNSORTED).

IF YOU PRESS * IN STEP 7
(→ p. 6-17), THE DESTINATIONS ARE
LISTED IN ALPHABETICAL ORDER
(SORTED).

■ CODED SPEED DIAL LIST 2 (Detailed List)

27/12 2002 17:23 FAX 123 4567		CANON		001
27/12 2002 17:23 FAX 123 4567		CANON		001
***** *** CODED SPEED DIAL LIST 2 *** *****				
[* 00]	CONNECTION TEL	2131 1250	REGULAR TX	
[* 01]	CONNECTION ID	Canon DEUTSCH.	REGULAR TX	
[* 02]	TX TYPE	1 49 39 25 25	REGULAR TX	
[* 03]	CONNECTION TEL	GROUP DIAL	REGULAR TX	
[* 01]	CONNECTION ID	Canon FRANCE	REGULAR TX	
[* 21]	CONNECTION TEL	Canon GROUP 1	REGULAR TX	
[* 01]	CONNECTION ID	03 3758 2111	REGULAR TX	
[* 03]	CONNECTION TEL	Canon TOKYO	REGULAR TX	
[* 03]	CONNECTION ID	516p488 6700	REGULAR TX	
[* 32]	CONNECTION TEL	Canon U.S.A.	REGULAR TX	
[* 32]	CONNECTION ID	Canon U.S.A.	REGULAR TX	
[* 32]	TX TYPE	81 773 3173	REGULAR TX	
[* 32]	SUBADDRES	Canon UK	PSWD/SUBADD. 1323	

IF YOU PRESS # IN STEP 7
(→ p. 6-17), THE DESTINATIONS ARE
LISTED IN CODE ORDER
(UNSORTED).

IF YOU PRESS * IN STEP 7
(→ p. 6-17), THE DESTINATIONS ARE
LISTED IN ALPHABETICAL ORDER
(SORTED).

■ GROUP DIAL LIST

27/12 2002 17:23 FAX 123 4567		CANON		001	
***** *** GROUP DIAL LIST *** *****					
[03] Canon GROUP 2	[04] 2.50921				Canon ITALIA
	[*: 00] 2131 1250				Canon DEUTSCH.
	[*: 02] 1 49 39 25 25				Canon FRANCE
	[*: 32] 81 773 3173				Canon UK
[*: 21] Canon GROUP 1	[01] 905 795 1111				Canon CANADA
	[*: 03] 516p488 6700				Canon U.S.A.

Chapter 7

Sending Faxes

❑	Preparing to Send a Fax	7-2
	• Documents You Can Fax	7-2
	• Setting the Scanning Resolution	7-2
	• Setting the Scanning Contrast	7-3
	• Dialling Methods	7-4
❑	Sending Methods.....	7-5
	• Memory Sending	7-5
	• Manual Sending Via the Handset	7-6
❑	Cancelling Sending	7-8
❑	Redialling When the Line is Busy	7-9
	• Manual Redialling	7-9
	Cancelling Manual Redialling	7-9
	• Automatic Redialling	7-9
	What is Automatic Redialling?.....	7-9
	Cancelling Automatic Redialling	7-9
	Setting the Options for Automatic Redialling	7-10
❑	Sending the Same Document to Several Fax Numbers (Sequential Broadcasting).....	7-12
❑	Delayed Sending	7-14
	• Scanning a Document into Memory for Delayed Sending	7-14
	• Printing a Document Set for Delayed Sending	7-16
	• Deleting a Document Set for Delayed Sending.....	7-17

Preparing to Send a Fax

Documents You Can Fax

For information on the types of documents you can fax, their requirements, and details on loading documents, see Chapter 4.

Setting the Scanning Resolution

You can set the scanning resolution of documents you send. The higher the resolution the higher the output quality at the other end, but the slower the transmission speed. Adjust the scanning resolution according to the type of document you are sending.

If you are sending a document that requires some pages to be scanned at a different resolution from the others, you can change the resolution setting while the document is being scanned. However, please note that the new setting will only be effective from the next page scanned.

Follow this procedure to set the scanning resolution:

- 1 Press **Resolution** to select the resolution setting you want.

Ex:

FAX PHOTO

- You can select from the following:
 - FAX STANDARD
Suitable for most text-only documents.
 - FAX FINE
Suitable for fine-print documents.
 - FAX PHOTO
Suitable for documents that contain images such as photos. With this setting, areas of the document that contain photos are automatically scanned with 64 levels of grey, rather than just in black & white.
 - SUPER FINE
Suitable for documents that contain fine print and images. This setting is four times the resolution of the FAX STANDARD setting.
- 2 Continue with the operation you are performing.
 - If you do not proceed with any other operation, the LCD returns to standby mode after about 10 seconds.

Setting the Scanning Contrast

You can adjust the degree of contrast at which your document is scanned for sending and copying. Adjust according to how light or how dark your document is.

Follow this procedure to set the scanning contrast for sending and copying:

1 Press **Function**.

2 Press **Data Registration**.

DATA REGISTRATION

3 Press **OK** twice.

USER SETTINGS

DATE & TIME

4 Use ▼ or ▲ to select **SCAN CONTRAST**.

SCAN CONTRAST

5 Press **OK**.

Ex: STANDARD

6 Use ▼ or ▲ to select the scanning contrast you want.

- You can select from the following:
 - STANDARD
Suitable for most documents.
 - DARKER
Suitable for light documents.
 - LIGHTER
Suitable for dark documents.

7 Press **OK**.

OFFHOOK ALARM

8 Press **Stop** to return to standby mode.

Ex: 15:00 FaxOnly

Dialling Methods

There are several ways of dialling the fax number(s) you want to send to. They are as follows:

- **Regular Dialling**
Dial a fax number by using the numeric buttons, similar to dialling a telephone number.
- **One-Touch Speed Dialling**
Dial a fax number by pressing the one-touch speed dialling button (01 to 15) assigned to the fax number. For details on registering and using one-touch speed dialling, see pp. 6-3, 6-14.
- **Coded Speed Dialling**
Dial a fax number by pressing **Coded Dial** and entering the two-digit code (00 to 99) assigned to the fax number. For details on registering and using coded speed dialling, see pp. 6-7, 6-14.
- **Group Dialling**
Send a document to a predefined group of fax numbers registered for speed dialling. For details on registering groups and using group dialling, see pp. 6-11, 6-14.
- **Dialling with the Directory**
Look up the other party's name by using the directory function. For details on using the directory function, see p. 6-16.

Sending Methods

This section explains the two main sending methods: Memory sending and Manual sending via the handset.

Memory Sending

Memory sending is a quick and easy way to send a document. As the FAX scans the first page of a multipage document into its memory, it begins calling the other party and transmitting the information even as the remaining pages are being scanned.

Since the FAX is multitasking, you can even scan a document into memory while performing other tasks.

The FAX has enough memory to store up to approximately 448 pages* (FAX-L295) / 350 pages* (FAX-L220) (fewer if the document contains many graphics or particularly dense text).

Follow this procedure to send a document using memory sending:

- 1 Load the document, face down in the ADF (→ p. 4-3).
 - To adjust the resolution and contrast, see pp. 7-2, 7-3.
 - You may be unable to send if the memory used (shown in the LCD) is close to 100%. Use manual sending via the handset instead (→ p. 7-6).

Ex:

MEMORY USED 0%

(Currently used memory)

DOCUMENT READY

(Standby to scan)

- 2 Dial the other party's fax number.
 - For dialling methods, see p. 7-4.
 - If you enter the wrong number, press **Stop**, then enter the correct number.
 - If you are connected to a PBX and need to first dial an outside line access number ("9", for example), add a pause after that number by pressing **Redial/Pause** (→ p. 9-2).

Ex:

TEL= 9p7654321

* Based on Canon FAX Standard Chart No. 1, standard mode.

- 3 Press **Start/Copy** to begin scanning for sending, or if you used speed dialling, wait a few seconds for the FAX to begin scanning automatically.
 - If you do not want the FAX to begin scanning automatically after a few seconds, disable the TIME OUT setting (→ p. 14-6).
 - To cancel sending once dialling has started, press **Stop** then * (→ p. 7-8).
 - If the number you are calling is busy, the FAX redials the number automatically after a few minutes (→ p. 7-9).



- You can register up to 20 different sending operations for memory sending.
- The document is automatically deleted from memory after sending. This occurs even if an error prevents complete transmission of the document.

Manual Sending Via the Handset

Manual sending via the handset allows you to talk to the other party before sending a document. This method is useful if the other party must manually activate their fax machine to receive a fax.



For this mode, you need to connect the optional handset or a telephone to your FAX (→ p. 2-5).

Follow this procedure to send a document using manual sending via the handset:

- 1 Make sure you have connected the optional handset or a telephone to the FAX (→ p. 2-5).
- 2 Load the document, face down in the ADF (→ p. 4-3).
 - To adjust the resolution and contrast, see pp. 7-2, 7-3.
- 3 Press **Hook**.
 - You can also lift the handset instead of pressing **Hook**.

Ex:

MEMORY USED 0%

(Currently used memory)

DOCUMENT READY

(Standby to scan)

TEL=

4 Dial the other party's fax/telephone number.

Ex:

TEL=	7654321
------	---------

- For dialling methods, see p. 7-4.
- If you make a mistake during dialling, press **Hook** or hang up the handset and start again from step 3.

■ **If you hear a high-pitched signal instead of a voice:**

5 Press **Start/Copy** to begin sending the document.
If you picked up the handset to dial, press **Start/Copy** and hang up.

■ **If you hear a voice:**

- 5 Pick up the handset and start your conversation.
- If you pressed **Hook** instead of lifting the handset in step 3, you will hear the other party's voice but they will not be able to hear you through the speaker. Pick up the handset to talk to the other party.
- 6 When you are ready to send your document, ask the other party to press the start button on their fax machine.
- 7 When you hear the high-pitched signal of the other party's fax machine, press **Start/Copy** and hang up to begin sending the document.



-
- If using the handset, be sure to hang up after you press **Start/Copy** on the FAX, otherwise the call will be disconnected.
 - The FAX will alert you by beeping if the handset is not hung up properly. Make sure the handset is seated properly in its cradle. If you do not want the FAX to beep, disable the OFFHOOK ALARM setting (→ p. 14-4).
-

Canceling Sending

Follow this procedure if you want to stop sending a document before transmission is completed:

■ If you are sending a document using manual sending via the handset:

1 Press **Stop**.

- The transmission is cancelled.
- The FAX prints an ERROR TX REPORT (→ p. 11-4).

■ If you are sending a document using memory sending:

1 Press **Stop**.

- The FAX asks you to confirm that you want to cancel sending.

CANCEL? *YES #NO

YES= (*) NO= (#)

2 Press * to cancel sending.

- Sending is not cancelled until you press *.
- If you change your mind and want to continue sending, press #.
- To cancel transmission of a document waiting to be sent (e.g. delayed sending, between rediallings), you will have to delete it from memory (→ pp. 7-17, 9-8).
- The FAX prints an ERROR TX REPORT (→ p. 11-4).



When you cancel sending, you may need to open the operation panel to remove the document from the ADF (→ p. 13-2).

Redialling When the Line is Busy

There are two methods of redialling: *Manual redialling* and *Automatic redialling*. This section explains these two methods.

Manual Redialling

Press **Redial/Pause** to dial the last number you dialled with the numeric buttons. (This starts redialling regardless of whether automatic redialling is enabled.)

Cancelling Manual Redialling

To cancel manual redialling, press **Stop**.

Automatic Redialling

What is Automatic Redialling?

When you are sending a document using memory sending (→ p. 7-5) and the other party's line is busy, the FAX waits the specified time interval and then redials the number automatically. This is called *Automatic redialling*.

You will know that the FAX is waiting to redial when **AUTO REDIAL** and the transaction number (**TX/RX NO.**) are displayed in the LCD.

The automatic redialling options allow you to customise the number of times the FAX redials, as well as the time interval between redials. You can also disable automatic redialling if you prefer the FAX not to do so.

If all automatic redialling attempts are unsuccessful, the FAX cancels the transmission and prints an **ERROR TX REPORT** to notify you that the transmission was not completed (→ p. 11-4).

Cancelling Automatic Redialling

Automatic redialling cannot be cancelled with the **Stop** button while the FAX is waiting to redial. You can either wait until the FAX begins redialling and then follow the procedure below, or if you want to cancel while the FAX is waiting to redial, you will have to delete the document from memory (→ p. 9-8).

Follow this procedure to cancel automatic redialling when the FAX begins redialling:

- 1 Wait until the FAX begins redialling.

DIALLING

2 Press **Stop**.

- The FAX asks you to confirm that you want to cancel automatic redialling.

CANCEL? *YES #NO

YES= (*) NO= (#)

3 Press * to cancel redialling.

- Redialling is not cancelled until you press *.
- If you change your mind and want to continue redialling, press #.
- The FAX prints an ERROR TX REPORT (→ p. 11-4).

Setting the Options for Automatic Redialling

You can set the following options for automatic redialling:

- Whether the FAX redials automatically.
- The number of times the FAX attempts to redial.
- The time interval between redialling attempts.

Follow this procedure to adjust the automatic redialling options:

1 Press **Function**.

2 Press **Data Registration**.

DATA REGISTRATION

3 Press **OK**.

USER SETTINGS

4 Use ▼ or ▲ to select **TX SETTINGS**.

TX SETTINGS

5 Press **OK**.

ECM TX

6 Use ▼ or ▲ to select **AUTO REDIAL**.

AUTO REDIAL

7 Press **OK**.

Ex: ON

8 Use ▼ or ▲ to select the setting you want.

- You can select from the following:
 - ON
Enables automatic redialling.
 - OFF
Disables automatic redialling.

■ If you selected OFF in step 8:

9 Press **OK**.

TIME OUT

10 Press **Stop** to return to standby mode.

Ex: 15:00 FaxOnly

■ If you selected ON in step 8:

9 Press **OK** twice.

REDIAL TIMES

Ex: 2TIMES

10 Use the numeric buttons to enter the number of times you want the FAX to redial.

- You can select from 1 to 10 times.*

Ex: 5TIMES

11 Press **OK** twice.

REDIAL INTERVAL

Ex: 2MIN.

12 Use the numeric buttons to enter the time interval between redials.

- You can select from 2 to 99 minutes.*

Ex: 5MIN.

13 Press **OK**.

TIME OUT

14 Press **Stop** to return to standby mode.

Ex: 15:00 FaxOnly

* The selectable values vary depending on the country.

Sending the Same Document to Several Fax Numbers (Sequential Broadcasting)

This feature, also called *Sequential Broadcasting*, allows you to send the same document to several fax numbers in one operation. Simply load the document, enter the fax numbers, and the FAX will then scan the document into its memory and send the document to all the fax numbers you entered, one after the other.

You can send the same document to as many as 116 fax numbers using this feature. Please note, however, that the fax numbers you enter must be registered for one-touch or coded speed dialling (→ Chapter 6). You will only be able to enter one fax number using regular dialling (i.e. with the numeric buttons).



If you frequently send documents to the same group of fax numbers, you can register these numbers for group dialling instead. This will simplify dialling (→ p. 6-11).

Follow this procedure to send the same document to several fax numbers:

1 Load the document, face down in the ADF (→ p. 4-3).

- To adjust the resolution and contrast, see pp. 7-2, 7-3.
- You may be unable to send if the memory used (shown in the LCD) is close to 100%. To free up space in the FAX's memory: print, send, or delete any documents you no longer need to be stored in memory (→ p. 9-4).

Ex:

MEMORY USED 0%

(Currently used memory)

DOCUMENT READY

(Standby to scan)

2 Enter up to 116 fax numbers using any of the following methods:

- One-touch speed dialling:**
Press the one-touch speed dialling button(s) you want.
- Coded speed dialling:**
Press **Coded Dial**, then use the numeric buttons to enter the two-digit code you want. Repeat for other codes.
 - Be sure to press **Coded Dial** before each code.

Ex:

TEL=905 795 1111

Ex:

*01

Ex:

TEL=03 3758 2111

❑ **Regular dialling:**

Use the numeric buttons to enter the fax number you want, then press **OK**.

Ex:

TEL= 2 887 0166

- You can only enter one fax number this way.

❑ **Dialling with the directory:**

Look up the other party's name.



- You can enter the fax numbers in any order.
- If you enter a wrong destination, press **C**, then enter the correct destination.
- You must enter the second destination within five seconds of entering the first one. All subsequent destinations must be entered within 10 seconds. If you wait longer than these times, the FAX automatically begins scanning the document for sending. If you do not want the FAX to begin scanning automatically after a few seconds, disable the **TIME OUT** setting (→ p. 14-6).
- To review the destinations entered, use ▼ or ▲ to scroll through the numbers.

3 Press **Start/Copy** to begin scanning for sending, or wait a few seconds for the FAX to begin scanning automatically.

- The FAX will first send the document to the one-touch speed dialling destinations, then the coded speed dialling destinations, and finally to the destination dialled using regular dialling.
- If you do not want the FAX to begin scanning automatically after a few seconds, disable the **TIME OUT** setting (→ p. 14-6).
- To cancel sending once dialling has started, press **Stop** then *. Sending to all destinations you specified in step 2 will be cancelled. (You cannot cancel only one destination.)



- If a number is busy, the FAX will continue sending to the other destinations and then automatically redial the number that was busy.
- If the FAX's memory becomes full while scanning your document, **MEMORY FULL** will appear in the LCD. If this happens, remove the remainder of the document from the ADF (you may need to open the operation panel to do so), then divide the document into several sections and send each section separately.

Delayed Sending

Your FAX allows you to scan a document into its memory and send it automatically to as many as 116 fax numbers at a preset time within the next 24 hours. This is called Delayed sending or Timer sending. By using this feature, you can take advantage of lower long distance rates at night, for example.



To use delayed sending correctly, make sure the correct time is set on your FAX (→ p. 3-6).

Scanning a Document into Memory for Delayed Sending

Follow this procedure to scan a document into the FAX's memory for delayed sending:

- 1 Load the document, face down in the ADF (→ p. 4-3).
 - To adjust the resolution and contrast, see pp. 7-2, 7-3.
 - You may be unable to scan if the memory used (shown in the LCD) is close to 100%. To free up space in the FAX's memory: print, send, or delete any documents you no longer need to be stored in memory (→ p. 9-4).

Ex:

MEMORY USED 0%

(Currently used memory)

DOCUMENT READY

(Standby to scan)

- 2 Press **Function**.
- 3 Press **Delayed Transmission**.

REGISTER

- 4 Press **OK**.

Ex:

SET TIME	<u>15</u> :00
----------	---------------

- 5 Use the numeric buttons to enter the time at which you want to send the document.
 - Use the 24-hour format for the time (e.g. 11:30 p.m. as 23:30), and precede single digits with a zero.

Ex:

SET TIME	<u>22</u> :30
----------	---------------

- 6 Press **OK**.

SELECT LOCATIONS

TEL=

- 7 Enter up to 116 fax numbers you want to send to using any of the following methods:

One-touch speed dialling:

Press the one-touch speed dialling button(s) you want.

Ex:

Coded speed dialling:

Press **Coded Dial**, then use the numeric buttons to enter the two-digit code you want. Repeat for other codes.

Ex:

- Be sure to press **Coded Dial** before each code.

Ex:

Regular dialling:

Use the numeric buttons to enter the fax number you want, then press **OK**.

Ex:

- You can only enter one fax number this way.

Dialling with the directory

Look up the other party's name.



- If you enter the wrong destination, press **C**, then enter the correct destination.
- When you have entered multiple fax numbers, use ▼ or ▲ to scroll through the numbers to review the destinations.

- 8 Press **Start/Copy** to begin scanning the document into the FAX's memory.

- When the preset time is reached, the FAX sends the document to the destination(s) you specified in step 7.



- You can register up to 20 different delayed sending operations.
- If the FAX's memory becomes full while scanning your document, **MEMORY FULL** will appear in the LCD. If this happens, you will not be able to send the document at a preset time. Remove the remainder of the document from the ADF (you may need to open the operation panel to do so).
- Since the FAX is multitasking, you can perform other tasks even when your FAX is set for delayed sending.

Printing a Document Set for Delayed Sending

Follow this procedure to print a document stored in memory for delayed sending:



When you print a document stored in memory for delayed sending using the following procedure, the print is reduced to 90% of the original.

1 Press **Function**.

2 Press **Delayed Transmission**.

REGISTER

3 Use **▼** or **▲** to select **PRINT**.

PRINT

4 Press **OK**.

Ex: TX/RX NO. 0001

5 Use **▼** or **▲** to select the transaction number (TX/RX NO.) of the document you want to print.

Ex: TX/RX NO. #0003

- If you are unsure of the transaction number (TX/RX NO.), print the **DOC. MEMORY LIST** (→ p. 9-4).
- A “#” before the transaction number (TX/RX NO.) indicates that that document is being sent at that moment and can therefore not be selected.
- Use **◀** or **▶** to display details of the transaction (e.g. destination).

6 Press **OK**.

1ST PG ONLY?

YES= (*) NO= (#)

7 Press ***** to print the first page only, or press **#** to print all pages of the document.

- The **FAX** prints the document.

8 To continue printing other documents set for delayed sending, repeat the procedure from step 5.

-or-

Press **Stop** to return to standby mode.

Ex: 15:00 FaxOnly

Deleting a Document Set for Delayed Sending

Follow this procedure to delete a document stored in memory for delayed sending:

1 Press **Function**.

2 Press **Delayed Transmission**.

REGISTER

3 Use ▼ or ▲ to select **DELETE FILE**.

DELETE FILE

4 Press **OK**.

Ex: TX/RX NO. 001

5 Use ▼ or ▲ to select the transaction number (TX/RX NO.) of the document you want to delete.

Ex: TX/RX NO. #003

- If you are unsure of the transaction number (TX/RX NO.), print the DOC. MEMORY LIST (→ p. 9-4).
- A “#” before the transaction number (TX/RX NO.) indicates that that document is being sent at that moment. If you want to delete a document being sent, follow the instructions in the LCD.
- Use ◀ or ▶ to display details of the transaction (e.g. destination).

6 Press **OK**.

OK TO DELETE?

YES= (*) NO= (#)

7 Press * to delete the document.

- If you change your mind and want to keep the document in memory for delayed sending, press #.

ERASING END

8 To continue deleting other documents set for delayed sending, repeat the procedure from step 5.

-or-

Press **Stop** to return to standby mode.

Ex: 15:00 FaxOnly

Chapter 8

Receiving Faxes

❑	Receiving Methods	8-2
•	Receiving Faxes Automatically: FAX ONLY MODE	8-2
	Setting FAX ONLY MODE	8-2
•	Receiving Both Faxes and Telephone Calls Automatically:	
	Fax/Tel Mode	8-4
	Setting Fax/Tel Mode	8-4
	Setting the Options for Fax/Tel Mode	8-5
•	Receiving Faxes Manually: MANUAL MODE	8-7
	Setting MANUAL MODE	8-7
	Receiving a Fax Manually	8-7
•	Receiving With an Answering Machine: ANS.MACHINE MODE	8-9
	Setting ANS.MACHINE MODE	8-9
	Using the FAX With an Answering Machine	8-9
❑	Receiving While Performing Other Tasks	8-10
❑	Receiving Faxes in Memory When a Problem Occurs	8-10
❑	Cancelling Receiving	8-11

Receiving Methods

The FAX provides you with several modes for receiving faxes. To determine which mode best suits your requirements, refer to the table below:

Receive Mode	Main Use	Operation	Requirements	Details
FAX ONLY MODE	Fax	The FAX answers all calls as fax calls. It receives faxes automatically and disconnects voice calls.	Separate telephone line for fax use only.	p. 8-2
Fax/Tel Mode	Fax/Tel	The FAX automatically switches between fax and voice calls. It receives faxes automatically and rings for voice calls.	Optional handset or telephone connected to the FAX.	p. 8-4
MANUAL MODE	Tel	The FAX rings for every call, whether a fax call or a voice call. For a fax call, you have to manually activate reception of a fax.	Optional handset or telephone connected to the FAX.	p. 8-7
ANS . MACHINE MODE	Fax/Tel	The FAX receives documents automatically and the answering machine records voice messages.	Answering machine connected to the FAX.	p. 8-9

Once you have decided which mode is suitable for your needs, set the mode as described in this chapter. You can change the mode at any time.

Receiving Faxes Automatically: FAX ONLY MODE

If you have a separate telephone line for fax use only, connect your FAX to this line and set FAX ONLY MODE. Your FAX will answer all calls as fax calls.

Setting FAX ONLY MODE

- 1 Press **Function** then **Receive Mode**.
- 2 Use **▼** or **▲** to select FAX ONLY MODE then press **OK**.

FAX ONLY MODE

Ex: 15:00 FaxOnly

If FAX ONLY MODE does not appear in the LCD when you press **Receive Mode**, follow this procedure to set this mode:

- 1 Press **Function**.
- 2 Press **Data Registration**. DATA REGISTRATION
- 3 Press **OK**. USER SETTINGS
- 4 Use ▼ or ▲ to select RX SETTINGS. RX SETTINGS
- 5 Press **OK**. ECM RX
- 6 Use ▼ or ▲ to select RX MODE. RX MODE
- 7 Press **OK**. Ex: FAX/TEL AUTO SW
- 8 Use ▼ or ▲ to select FAX ONLY MODE. FAX ONLY MODE
- 9 Press **OK**. INCOMING RING
- 10 Press **Stop** to return to standby mode. Ex: 15:00 FaxOnly
- 11 Confirm that FaxOnly is displayed in the LCD. Ex: 15:00 FaxOnly
 - If FaxOnly is not displayed, follow steps 1 to 2 on page 8-2 to select FAX ONLY MODE. After a few seconds, the LCD returns to standby mode.

The FAX treats all incoming calls as fax calls. It receives faxes automatically and disconnects any voice calls.



The FAX does not ring when it receives a fax call. If you want to be alerted when a fax call is received, connect the optional handset or a telephone to the FAX, and enable the INCOMING RING setting (→ p. 14-7). You can also select the number of rings before the FAX answers (→ RING COUNT, p. 14-7).

Receiving Both Faxes and Telephone Calls Automatically: Fax/Tel Mode









Set this mode if you only have one telephone line for fax and telephone use and want your FAX to automatically switch between fax and voice calls.

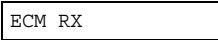
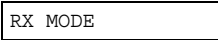

For this mode, you need to connect the optional handset or a telephone to your FAX (→ p. 2-5).

Setting Fax/Tel Mode

Follow this procedure to set the receive mode to FAX/TEL AUTO SW (Fax/Tel Mode):

- 1 Press **Function**.
- 2 Press **Data Registration**.

- 3 Press **OK**.

- 4 Use **▼** or **▲** to select RX SETTINGS.

- 5 Press **OK**.

- 6 Use **▼** or **▲** to select RX MODE.

- 7 Press **OK**.
Ex: 
- 8 Use **▼** or **▲** to select FAX/TEL AUTO SW.

- 9 Press **OK**.
 - To set the options for FAX/TEL AUTO SW (Fax/Tel Mode), see the following pages.
- 10 Press **Stop** to return to standby mode.
Ex: 
- 11 Confirm that FaxTel is displayed in the LCD.
 - If FaxTel is not displayed, follow steps 1 to 2 on page 8-2 to select Fax/Tel Mode. After a few seconds, the LCD returns to standby mode.

Setting the Options for Fax/Tel Mode

If you set Fax/Tel Mode, you can control precisely how the FAX handles incoming calls by adjusting the following settings:

- RING START TIME setting: Adjust the time the FAX takes to check whether a call is from a fax machine or from a telephone (default: 8 seconds).
- F/T RING TIME setting: Adjust the length of time the FAX rings when the call is from a telephone (default: 22 seconds).
- DEFAULT ACTION setting: Set whether the FAX switches to receive mode or disconnects the call after the ring time set in F/T RING TIME has elapsed (default: switches to receive mode).

■ What Happens When Fax/Tel Mode is Selected

When the FAX receives a call, it responds according to the type of call as follows:

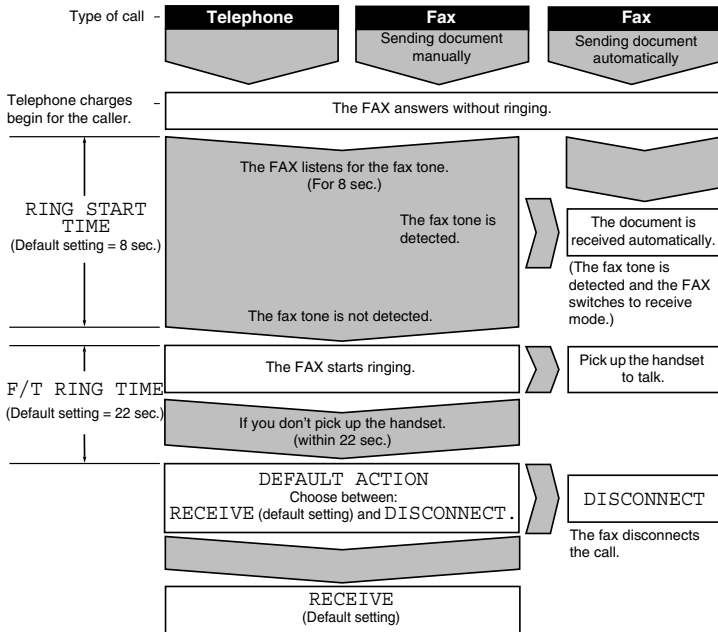

Not all fax machines are capable of sending a fax tone. For those cases if you set the DEFAULT ACTION to RECEIVE, the fax switches to receive mode automatically and starts receiving the document. If no document comes in, it disconnects the call after approximately 40 seconds.

Follow this procedure to set the Fax/Tel Mode options:

- 1 Follow steps 1 to 9 on page 8-4. RING START TIME

- 2 Press **OK**. Ex: 8SEC

- 3 Use the numeric buttons to enter the RING START TIME duration. Ex: 9SEC
 - You can select from 0 to 30 seconds.*
 - See the previous page for details on this setting.

- 4 Press **OK** twice. F/T RING TIME
Ex: 22SEC

- 5 Use the numeric buttons to enter the F/T RING TIME duration. Ex: 30SEC
 - You can select from 10 to 60 seconds.*
 - See the previous page for details on this setting.

- 6 Press **OK** twice. DEFAULT ACTION
Ex: RECEIVE

- 7 Use **▼** or **▲** to select the DEFAULT ACTION setting you want.
 - You can select from the following:
 - RECEIVE (Switch to receive mode)
 - DISCONNECT (Disconnect the call)**
 - See the previous page for details on this setting.

- 8 Press **OK**. INCOMING RING

- 9 Press **Stop** to return to standby mode. Ex: 15:00 FaxTel

* The selectable duration varies depending on the country.

** DISCONNECT is available for certain countries only.

Receiving Faxes Manually: MANUAL MODE

Set this mode if you only have one telephone line that you use mainly for voice calls, and only occasionally to receive faxes.

For this mode, you will need to connect the optional handset or a telephone to your FAX to be able to receive voice calls and also to manually activate reception of documents. You can activate reception directly from your FAX, or if your telephone is located away from your unit, you can dial the remote receiving ID on the telephone to activate reception (this is called Remote reception).

Setting MANUAL MODE

Follow this procedure to set the receive mode to MANUAL MODE:

- 1 Press **Function** then **Receive Mode**.
- 2 Use ▼ or ▲ to select MANUAL MODE then press **OK**.

MANUAL MODE

Ex:

15:00	Manual
-------	--------

Receiving a Fax Manually

Follow this procedure to receive a fax manually:

- 1 Make sure Manual is displayed in the LCD.
- 2 Make sure you have connected the optional handset or a telephone to the FAX (→ p. 2-5).
- 3 When you hear the optional handset or telephone ring, pick up the handset.

Ex:

15:00	Manual
-------	--------

■ **If you hear a beep tone or silence:**

- 4 Someone is trying to send you a fax. Press **Start/Copy** on your FAX and hang up to begin receiving the document.
- If you are using the telephone and it is located away from your unit, dial 25 (the default remote receiving ID) on your telephone and hang up.

■ **If you hear a voice:**

- 4 Start your conversation. If the caller wants to send a fax after talking to you, ask them to press the start button on their fax machine.
- 5 When you hear a beep, press **Start/Copy** on your FAX and hang up to begin receiving the document.
- If you are using the telephone and it is located away from your unit, dial 25 (the default remote receiving ID) on your telephone and hang up.



- If using the handset, be sure to hang up *after* you press **Start/Copy** on the FAX, otherwise the call will be disconnected.
 - The FAX will alert you by beeping if the handset is not hung up properly. Make sure the handset is seated properly in its cradle. If you do not want the FAX to beep, disable the OFFHOOK ALARM setting (→ p. 14-4).
 - If you cannot activate reception from the telephone, check that the REMOTE RX setting is enabled (→ p. 14-7).
 - You can change the remote receiving ID (→ REMOTE RX ID, p. 14-7), or disable remote receiving (→ REMOTE RX, p. 14-7).
 - If you have an answering machine connected to your FAX that can carry out remote-control operations (controlling your answering machine from a remote telephone), the security code for this function may be the same as the remote receiving ID of your FAX. If this is the case, make sure you change the FAX's remote receiving ID to make it distinct from the answering machine's security code (→ REMOTE RX ID, p. 14-7).
-

Receiving With an Answering Machine: ANS.MACHINE MODE

Connecting an answering machine to the FAX allows you to receive faxes and telephone messages while you are out.

In ANS.MACHINE MODE, the FAX allows the answering machine to answer incoming calls, then listens for the fax tone and automatically receives the fax if it detects this tone.

Setting ANS.MACHINE MODE



For this mode, you need to connect an answering machine or a telephone with an answering machine to your FAX (→ p. 2-5).

Follow this procedure to set the receive mode to ANS . MACHINE MODE:

- 1 Press **Function** then **Receive Mode**.
- 2 Use ▼ or ▲ to select ANS . MACHINE MODE then press **OK**.

ANS . MACHINE MODE

Ex:

15 : 00	AnsMode
---------	---------

Using the FAX With an Answering Machine

Follow these guidelines when using the FAX with an answering machine:

- Set the answering machine to answer on the first or second ring.
- When recording the outgoing message on the answering machine:
 - the entire message must be no longer than 15 seconds.
 - in the message, tell your callers how to send a fax. For example: “Hello. I can’t answer the phone right now, but please leave a message after the beep. If you would like to send a fax, press the start button on your fax machine after you finish your message. Thank you.”

Receiving While Performing Other Tasks

The FAX is a multitasking device so it can receive faxes and voice calls while you are performing other tasks.

If the FAX cannot print a received fax because it is performing another task that prevents it from doing so, it will receive the fax in memory. Then, as soon as it completes the other task, the FAX automatically prints the received fax from memory.

Receiving Faxes in Memory When a Problem Occurs

If the FAX encounters a problem when it is receiving a fax, it automatically stores the unprinted pages of the fax in memory. It then displays REC'D IN MEMORY as well as one or more messages in the LCD. For an explanation of the message(s) and details on the action to take, see p. 13-8.



- The FAX's memory can store up to approximately 448 pages * (FAX-L295) / 350 pages * (FAX-L220).
 - You can set the unit so that it does not store faxes in memory if a problem occurs during reception (→ MEMORY RX, p. 14-7).
 - Once the problem is solved and the unit prints the received fax, it will delete the fax from memory.
 - If the unit's memory becomes full while receiving a fax in memory, you will not be able to receive the remaining pages. Contact the other party and ask them to resend the remainder of the fax.
-

Cancelling Receiving

Follow this procedure if you want to stop receiving a fax before reception is completed:

1 Press **Stop**.

- The FAX asks you to confirm that you want to cancel receiving.

CANCEL? *YES #NO

YES= (*) NO= (#)

2 Press * to cancel receiving.

- Receiving is not cancelled until you press *.
- If you change your mind and want to continue receiving, press #.

TX/RX CANCELLED

Ex: TX/RX NO. 5003

* Based on Canon FAX Standard Chart No. 1, standard mode.

Chapter 9

Special Features

❑ Special Dialling	9-2
• Entering Pauses in a Fax/Telephone Number.....	9-2
• Switching Temporarily to Tone Dialling.....	9-3
• Dialling Through a Switchboard	9-3
❑ Documents Stored in Memory	9-4
• Printing a List of Documents Stored in Memory.....	9-4
• Printing a Document Stored in Memory.....	9-5
• Sending a Document Stored in Memory	9-6
• Deleting a Document Stored in Memory.....	9-8
❑ Polling	9-9
• What is Polling?.....	9-9
• Polling Receiving.....	9-9
Polling Another Fax Machine.....	9-9
Cancelling Polling Receiving	9-11
• Polling Sending.....	9-11
Setting Up the Polling Box	9-11
Scanning a Document into the Polling Box	9-14
Changing or Deleting the Polling Box Settings.....	9-14
❑ Restricting Use of Your FAX	9-16
• Enabling Restriction of Your FAX.....	9-16
• Cancelling Restriction of Your FAX.....	9-17
❑ Restricting Reception.....	9-19

Special Dialling

Entering Pauses in a Fax/Telephone Number

You may need to enter pauses in a fax/telephone number in the following situations:

- When you dial or register an overseas number. The length and position of the pause depends on the telephone system of your country.
- When your FAX is connected to a switchboard. For details, see p. 3-9.

Follow this procedure to enter pauses during regular dialling or when registering a number for speed dialling:

1 When you come to the step that requires you to enter the fax/telephone number, use the numeric buttons to enter the number up to where a pause is necessary.

Ex:

TEL=	00
------	----

- If you enter the wrong number, press **C**, then enter the correct number.

2 Press **Redial/Pause** to enter a pause.

Ex:

TEL=	00P
------	-----

- A pause entered within a number (P) is two seconds* long.
- For a longer pause, press **Redial/Pause** again for another two-second* pause. Alternatively, you can change the length of the pause (→ MID PAUSE SET, p. 14-6).

3 Continue entering the rest of the fax/telephone number with the numeric buttons.

Ex:

TEL=	00p811234
------	-----------

- If you enter the wrong number, press **C** and start again from step 1.

4 To enter a pause at the end of the number, press **Redial/Pause**.

Ex:

TEL=	00p811234P
------	------------

- A pause at the end of a number (P) is fixed to ten seconds.

5 Continue with the operation you are performing.

* The duration of a pause varies depending on the country.

Switching Temporarily to Tone Dialling

Many information services for banks, airline reservations, hotel reservations, etc., require tone dialling for their services. If your FAX is set for pulse dialling (→ p. 3-8), follow this procedure to set the unit temporarily for tone dialling:



To talk to the other party, you will need to connect the optional handset or a telephone to your FAX (→ p. 2-5).

1 Press **Hook**.

- You can also lift the handset instead of pressing **Hook**.

TEL=

2 Use the numeric buttons to dial the telephone number of the information service.

- The FAX connects using the pulses required by your telephone line.

Ex:

TEL= 7654321

3 When the recorded message of the information service answers, press **T**(*) to switch to tone dialling.

- When **T**(*) is pressed, T is displayed in the LCD.
- If you pressed **Hook** in step 1, you can pick up the handset if you need to talk to the other party.

Ex:

TEL= 7654321T

4 Use the numeric buttons to enter the numbers requested by the information service.

- Numbers entered after pressing **T**(*) will be dialled using tone dialling.

Ex:

TEL= 7654321T*34

5 When you have finished, press **Hook** to disconnect the call.

- If you used the handset, hang up to disconnect the call.
- Tone dialling is cancelled when you disconnect the call.

Dialling Through a Switchboard

For details on dialling through a switchboard, see p. 3-9.

Documents Stored in Memory

This section describes how to perform different operations with documents stored in memory. You will find instructions for printing a list of documents in memory, as well as procedures for printing, sending, and deleting documents stored in memory.

Printing a List of Documents Stored in Memory

The FAX can print a list of documents stored in memory, along with the transaction number (TX/RX NO.) of each document. Once you know the transaction number of a document in memory, you can print it, send it, or delete it. These procedures are described on the following pages.

Follow this procedure to print a list of documents stored in memory:

1 Press **Function**.

2 Press **Memory Reference**.

DOC. MEMORY LIST

3 Press **OK**.

- The FAX prints the DOC. MEMORY LIST.

PRINTING REPORT

TX/RX NO		MODE	CONNECTION TEL/ID	PGS.	SET TIME	ST. TIME
0046	0047	TRANSMIT B'CAST	[* 01] Canon TOKYO [01] Canon CANADA	3 1	27/12 21:24 27/12 21:36	
0048		DEL SQ BDCST	[* 02] Canon FRANCE [04] Canon ITALIA	1	27/12 21:39	23:00 23:00
0049	0050	DELAYED TX B'CAST	[* 03] Canon U.S.A. [05] Canon OPTICS [03] Canon GROUP 2	2 1	27/12 21:45 27/12 21:49	23:00 23:00

Printing a Document Stored in Memory

Follow this procedure to print a document stored in memory:



When you print a document stored in memory using the following procedure, the print is reduced to 90% of the original.

1 Press **Function**.

2 Press **Memory Reference**.

DOC. MEMORY LIST

3 Use ▼ or ▲ to select **PRINT DOCUMENT**.

PRINT DOCUMENT

4 Press **OK**.

Ex: TX/RX NO. 0001

5 Use ▼ or ▲ to select the transaction number (TX/RX NO.) of the document you want to print.

Ex: TX/RX NO. #0003

- If you are unsure of the transaction number (TX/RX NO.), print the **DOC. MEMORY LIST** (→ p. 9-4).
- A “#” before the transaction number (TX/RX NO.) indicates that that document is being sent at that moment and can therefore not be selected.
- Use ◀ or ▶ to display details of the transaction (e.g. destination).

6 Press **OK**.

1ST PG ONLY?

YES= (*) NO= (#)

7 Press * to print the first page only, or press # to print all pages of the document.

- The **FAX** prints the document.

8 To continue printing other documents in memory, repeat the procedure from step 5.
-or-

Press **Stop** to return to standby mode.

Ex: 15:00 FaxOnly

Sending a Document Stored in Memory

Follow this procedure to send a document received in memory:

1 Press **Function**.

2 Press **Memory Reference**.

DOC. MEMORY LIST

3 Use ▼ or ▲ to select RESEND DOCUMENT.

RESEND DOCUMENT

4 Press **OK**.

Ex: TX/RX NO. 001

5 Use ▼ or ▲ to select the transaction number (TX/RX NO.) of the document you want to send.

Ex: TX/RX NO. #5003

- If you are unsure of the transaction number (TX/RX NO.), print the DOC. MEMORY LIST (→ p. 9-4).
- A “#” before the transaction number (TX/RX NO.) indicates that that document is being sent or printed at that moment, and can therefore not be selected.
- Use ◀ or ▶ to display details of the transaction (e.g. destination).

6 Press **OK**.

SELECT LOCATIONS

TEL=

7 Enter up to 116 fax numbers you want to send to using any of the following methods:

One-touch speed dialling:

Press the one-touch speed dialling button(s) you want.

Ex: TEL=905 795 1111

Coded speed dialling:

Press **Coded Dial**, then use the numeric buttons to enter the two-digit code you want. Repeat for other codes.

Ex: *01

- Be sure to press **Coded Dial** before each code.

Ex: TEL=03 3758 2111

❑ **Regular dialling:**

Use the numeric buttons to enter the fax number you want, then press **OK**.

Ex:

TEL= 2 887 0166

- You can only enter one fax number this way.



- If you enter a wrong destination, press **C**, then enter the correct destination.
 - To review the destinations entered, use ▼ or ▲ to scroll through the numbers.
-

8 Press **OK** to begin sending.

- To cancel sending once dialling has started, press **Stop** then *. Sending to all the destinations you specified in step 7 will be cancelled. (You cannot cancel only one destination.)

Deleting a Document Stored in Memory

Follow this procedure to delete a document stored in memory:

1 Press **Function**.

2 Press **Memory Reference**.

DOC. MEMORY LIST

3 Use ▼ or ▲ to select **DELETE DOCUMENT**.

DELETE DOCUMENT

4 Press **OK**.

Ex: TX/RX NO. 0001

5 Use ▼ or ▲ to select the transaction number (TX/RX NO.) of the document you want to delete.

Ex: TX/RX NO. #0003

- If you are unsure of the transaction number (TX/RX NO.), print the **DOC. MEMORY LIST** (→ p. 9-4).
- A “#” before the transaction number (TX/RX NO.) indicates that that document is being sent at that moment. If you want to delete a document being sent, follow the instructions in the LCD.
- Use ◀ or ▶ to display details of the transaction (e.g. destination).

6 Press **OK**.

- If you are deleting a document stored in the polling box (→ p. 9-11), enter the password that restricts access to the polling box settings, then press **OK**.

OK TO DELETE

YES= (*) NO= (#)

7 Press * to delete the document.

- If you change your mind and want to keep the document in memory, press #.

ERASING END

8 To continue deleting other documents in memory, repeat the procedure from step 5.
-or-
Press **Stop** to return to standby mode.

Ex: 15:00 FaxOnly

Polling

What is Polling?

In normal faxing, a fax machine sends a document to another fax machine. With polling, a fax machine calls another fax machine and requests that a document be sent to it; in other words, it “polls” that fax machine.

Your FAX has the capability of functioning in both roles; it can poll another fax machine to retrieve a document from it (polling receiving), or it can hold a document in its polling box so that other fax machines can poll your FAX and retrieve your document (polling sending).

Polling Receiving

In polling receiving, your FAX calls another fax machine and requests it sends the document it is holding.

You may find polling receiving convenient in the following situations:

- When you want to retrieve a document from an establishment, such as bank or information service.
- When you want to retrieve a document from another fax machine at your convenience.
- When you want to bear the transmission cost of receiving a document.

Polling Another Fax Machine

Before polling another fax machine, be sure to read the following:

- The FAX can only poll fax machines that support polling.
- The document you want to retrieve must be ready to be polled on the other party's fax machine. If necessary, call the other party to check.
- Call the other party and check if you require a subaddress and/or password to retrieve the document from their fax machine. If you do, take note of them and register them together with the fax number for speed dialling (→ Chapter 6). You can only poll with a subaddress/password by using speed dialling. If you do not require a subaddress/password, you can retrieve the document without having to enter these numbers.
- If the other party is using a Canon fax machine and their unit does not support subaddress/password transactions, ask them to set the polling ID on their fax machine to 255 or 11111111 binary.
- You can poll several fax machines in one operation. Each polling operation can retrieve documents from as many as 116 fax numbers.
- The subaddress/password must be an ITU-T standard subaddress/password.

Follow this procedure to poll one or several fax machine(s):

1 Press **Function**.

2 Press **Polling**.

POLLING TX

3 Use ▼ or ▲ to select POLLING RX.

POLLING RX

4 Press **OK**.

5 Enter up to 116 fax numbers you want to poll using any of the following methods:

One-touch speed dialling:

Press the one-touch speed dialling button(s) you want.

Ex: TEL=905 795 1111

Coded speed dialling:

Press **Coded Dial**, then use the numeric buttons to enter the two-digit code you want. Repeat for other codes.

Ex: *01

- Be sure to press **Coded Dial** before each code.

Ex: TEL=03 3758 2111

Regular dialling:

Use the numeric buttons to enter the fax number you want, then press **OK**.

Ex: TEL= 2 887 0166

- You can only enter one fax number this way.

Dialling with the directory

Look up the other party's name.



- If you enter a wrong destination, press **C**, then enter the correct destination.
- You cannot enter a subaddress/password with regular dialling. If you need to enter a subaddress/password for polling, register them together with the fax number for speed dialling (→ Chapter 6).
- To review the destinations entered, use ▼ or ▲ to scroll through the numbers.

6 Press **Start/Copy** to begin polling the fax machine(s).

Canceling Polling Receiving

To cancel polling receiving, follow the same procedure as for cancelling receiving (→ p. 8-11).

Polling Sending

In polling sending, your FAX holds a document in its polling box so that other fax machines can retrieve it.

You may find polling sending convenient in the following situations:

- A company department might store a document in the FAX so that other departments can retrieve it if they require that document.
- When you want the other party to retrieve a document from your FAX at their convenience.
- When you want the other party to bear the transmission cost of receiving a document from your FAX.

Setting Up the Polling Box

This section explains how to set up the FAX's polling box so that you can scan a document into it for other fax machines to retrieve it.

Before setting up the polling box, be sure to read the following:

- You can set an ITU-T standard password for the polling box to restrict being polled only by fax machines that have this exact password (see the instructions that follow). Make sure you contact the other party to inform them of your password. Do not set a password if the other party's fax machine does not support password transactions.
- Your FAX can be set to hold the document in its polling box until it is polled by one fax machine, or it can be set to continue to hold it so that several fax machines can retrieve the document (see below for details).

Follow this procedure to set up the polling box:

1 Press **Function**.

2 Press **Data Registration**.

DATA REGISTRATION

3 Press **OK**.

USER SETTINGS

4 Use ▼ or ▲ to select **POLLING BOX**.

POLLING BOX

5 Press **OK** three times.

SETUP FILE

FILE NAME

_ :A

6 Use the numeric buttons to enter a name for the polling box (max. 24 characters, including spaces).

Ex: Canon Dpt . 1_ :1

- If you are unsure how to enter characters, see p. 3-2.

7 Press **OK** twice.

DATA ENTRY OK

PASSWORD

PASSWORD _

8 Use the numeric buttons to enter a four-digit password.

Ex: PASSWORD 1234

- This password prevents unauthorised access to the polling box settings. You will need to enter this password whenever you want to change or delete the polling box settings. If you do not want to enter a password, ignore this step.

9 Press **OK** twice.

TX PASSWORD

10 Use the numeric buttons to enter a password (max. 20 digits, including *, #, and spaces).

Ex: #123456

- The fax machine(s) that will be polling your FAX must have this password registered to be able to retrieve the document.
- If you do not want to register a password, ignore this step.

11 Press **OK** twice.

ERASE AFTER TX

Ex:

ON

12 Use ▼ or ▲ to select if the document remains in the FAX's memory after it is polled.

- You can select from the following:
 - ON
The document in the polling box is deleted after it is retrieved by one fax machine.
 - OFF
The document in the polling box remains in the polling box so that it can be retrieved by an unlimited number of fax machines.

13 Press **OK**.

CHANGE DATA

14 Press **Stop** to return to standby mode.

Ex:

15:00

FaxOnly

Once you have set up the polling box, you are ready to scan into it the document you want other fax machines to retrieve.

Scanning a Document into the Polling Box

Follow this procedure to store a document in the polling box so that other fax machines can retrieve it:



You need to set up the polling box before you can scan a document into the polling box (→ p. 9-11).

- 1 Load the document, face down in the ADF (→ p. 4-3).
 - To adjust the resolution and contrast, see pp. 7-2, 7-3.
 - You may be unable to scan if the memory used (shown in the LCD) is close to 100%. To free up space in the FAX's memory: print, send, or delete any documents you no longer need to be stored in memory (→ p. 9-4).

Ex:

MEMORY USED 0%

(Currently used memory)

DOCUMENT READY

(Standby to scan)

2 Press **Function**.

3 Press **Polling**.

POLLING TX

4 Press **OK**.

- The FAX scans the document into the polling box.

When another fax machine polls your FAX, the following conditions apply:

- If you registered a password for the polling box, the other party's fax machine must request the document with this exact same password.
- If you have not registered a password for the polling box, but the other fax machine requests the document from your FAX with a password, the document cannot be retrieved.

Changing or Deleting the Polling Box Settings

Follow this procedure to change or delete the polling box settings:



You will be unable to delete the polling box settings if you have scanned a document into the polling box (see above). Delete the document from memory first before following the procedure below (→ p. 9-8).

1 Press **Function**.

2 Press **Data Registration**.

DATA REGISTRATION

3 Press **OK**.

USER SETTINGS

4 Use ▼ or ▲ to select **POLLING BOX**.

POLLING BOX

5 Press **OK**.

SETUP FILE

6 Use ▼ or ▲ to select the setting you want.

- You can select from the following:
 - **CHANGE DATA**
Select this setting if you want to change the polling box settings.
 - **DELETE FILE**
Select this setting if you want to delete the polling box settings.

■ If you selected **CHANGE DATA** in step 6:

7 Press **OK**.

FILE NAME

- If you registered a password to prevent unauthorised access to the polling box settings, use the numeric buttons to enter it, then press **OK**.

8 Press **OK**.

Ex: Canon Dpt. 1 :A

9 To change the polling box settings, follow the procedure from step 6 on p. 9-12.

■ If you selected **DELETE FILE** in step 6:

7 Press **OK**.

FILE DELETED

- If you registered a password to prevent unauthorised access to the polling box settings, use the numeric buttons to enter it, then press **OK**.
- The polling box settings are deleted.

SYSTEM SETTINGS

8 Press **Stop** to return to standby mode.

Ex: 15:00 FaxOnly

Restricting Use of Your FAX

By enabling this feature, you can prevent unauthorised use of your FAX to make calls and send faxes.

Enabling Restriction of Your FAX

Follow this procedure to enable restriction of your FAX:

1 Press **Function**.

2 Press **Data Registration**.

DATA REGISTRATION

3 Press **OK**.

USER SETTINGS

4 Use ▼ or ▲ to select **SYSTEM SETTINGS**.

SYSTEM SETTINGS

5 Press **OK** three times.

UN/LOCK PHONE

LOCK PHONE

Ex: OFF

6 Use ▼ or ▲ to select **ON**.

ON

7 Press **OK** twice.

PASSWORD

Ex: PASSWORD _

8 Use the numeric buttons to enter a four-digit password.

Ex: PASSWORD 1234

- This password prevents unauthorised access to the **LOCK PHONE** setting that enables or disables restriction of your FAX. If you do not want to enter a password, ignore this step.

9 Press **OK**.

RX RESTRICTION

10 Press **Stop** to return to standby mode.

Ex:

15:00	FaxOnly
-------	---------

Restriction of your FAX is now enabled. No one can make calls or send faxes. (This setting does not restrict incoming calls or faxes.)

Canceling Restriction of Your FAX

Follow this procedure to cancel restriction of your FAX:

1 Press **Function**.

2 Press **Data Registration**.

DATA REGISTRATION

3 Press **OK**.

USER SETTINGS

4 Use ▼ or ▲ to select **SYSTEM SETTINGS**.

SYSTEM SETTINGS

5 Press **OK** twice.

UN/LOCK PHONE

PASSWORD _

6 Use the numeric buttons to enter the four-digit password you registered when you enabled restriction.

PASSWORD

- If you did not register a password, ignore this step.

7 Press **OK** twice.

LOCK PHONE

Ex:

ON

8 Use ▼ or ▲ to select **OFF**.

OFF

9 Press **OK**.

PASSWORD

10 Press **Stop** to return to standby mode.

Ex: 15:00 FaxOnly

Restriction of your FAX is now disabled. Anyone can make calls or send faxes.

Restricting Reception

By enabling this feature, you can restrict reception of faxes to only the numbers registered for speed dialling on your FAX. This feature is useful to prevent reception of unsolicited faxes (e.g. junk mail).

Follow this procedure to enable or disable receiving restriction:

1 Press **Function**.

2 Press **Data Registration**.

DATA REGISTRATION

3 Press **OK**.

USER SETTINGS

4 Use ▼ or ▲ to select **SYSTEM SETTINGS**.

SYSTEM SETTINGS

5 Press **OK**.

UN/LOCK PHONE

6 Use ▼ or ▲ to select **RX RESTRICTION**.

RX RESTRICTION

7 Press **OK**.

Ex: OFF

8 Use ▼ or ▲ to select the setting you want.

- You can select from the following:
 - ON (Enable restriction)
 - OFF (Disable restriction)

■ If you selected ON in step 8:

9 Press **OK** twice.

RX CONDITION

Ex: REGISTERED SENDER

10 Use ▼ or ▲ to select the restriction type setting you want.

- You can select from the following:
 - REGISTERED SENDER
To allow reception from the numbers registered for speed dialling.
 - WITH SENDER INFO
To allow reception only when the caller gives its telephone number.

11 Press **OK**.

DATE SETUP

12 Press **Stop** to return to standby mode.

Ex:

15:00 FaxOnly

■ **If you selected OFF in step 8:**

9 Press **OK**.

DATE SETUP

10 Press **Stop** to return to standby mode.

Ex:

15:00 FaxOnly

Chapter 10

Copying

❑ Documents You Can Copy	10-2
❑ Making Copies	10-2
❑ Making a Quick Single Copy.....	10-3

Documents You Can Copy

For information on the types of documents you can copy, their requirements, and details on loading documents, see Chapter 4.

Making Copies

Follow this procedure to make copies:

1 Adjust the paper delivery selector if necessary (→ p. 5-4).

2 Load the document, face down in the ADF (→ p. 4-3).

- To adjust the contrast, see p. 7-3.

Ex:

MEMORY USED 0%

(Currently used memory)

DOCUMENT READY

(Standby to scan)

3 Press **Start/Copy**.

COPY	100%	01
------	------	----

4 Press **Resolution** to select the resolution setting you want.

Ex:

PHOTO

- You can select from the following:
 - TEXT
Suitable for most text documents.
 - PHOTO
Suitable for documents that contain photographs.

5 To make a reduced copy of your document, use ▼ or ▲ to select the reduction percentage you want.

Ex:

COPY	80%	01
------	-----	----

- You can select from the following:
 - 70%
 - 80%
 - 90%
 - 100%

- 6** If you want to make multiple copies, use the numeric buttons to enter the number of copies.

Ex:

COPY	80%	05
------	-----	----

- You can make up to 99 copies.



The FAX copies at 400 × 300 dpi for single copies, and at 200 × 300 dpi for multiple copies. For best quality output, make one copy at a time.

- 7** Press **Start/Copy** to begin copying.

COPYING

- To cancel copying, press **Stop**. You may then need to open the operation panel to remove the document from the ADF (→ p. 13-2).



You will be unable to make multiple copies if MEMORY FULL appears in the LCD. Print, send, or delete any documents stored in memory to free up space in the FAX's memory (→ p. 9-4), then start again. Also, if you are copying multiple pages with many graphics, separate the pages into smaller stacks or make the desired number of copies one at a time as needed.

Making a Quick Single Copy

Follow this procedure if you want to make a quick single copy of a document without adjusting the resolution, contrast, or size:

- 1** Load the document, face down in the ADF (→ p. 4-3).

Ex:

MEMORY USED 0%

(Currently used memory)

DOCUMENT READY

(Standby to scan)

- 2** Press **Start/Copy** twice to begin copying.

COPY	100%	01
------	------	----

- To cancel copying, press **Stop**. You may then need to open the operation panel to remove the document from the ADF (→ p. 13-2).

COPYING

Chapter 11

Reports and Lists

❑ Summary of Reports and Lists.....	11-2
❑ ACTIVITY REPORT	11-3
❑ TX (Transmission) REPORT.....	11-4
• MULTI TX/RX (Transaction) REPORT.....	11-5
❑ RX (Reception) REPORT.....	11-5

Summary of Reports and Lists

The table below shows the lists and reports that can be printed from your FAX. Refer to the pages indicated for more details.

Report or List	Description	Details
USER'S DATA LIST	Lists the current settings of your FAX and the registered sender information.	p. 14-2
ACTIVITY REPORT	Shows recent facsimile transactions performed by your FAX. You can enable or disable automatic printing of this report after every 20 transactions. You can also manually set the FAX to print it.	p. 11-3 p. 14-5
TX (Transmission) REPORT	Prints after transmission of a document. You can enable or disable this feature, or set the FAX to print a report only when an error occurs. You can also set the FAX to print the first page of the document under the report to remind you of the contents of the document.	p. 11-4 p. 14-5
RX (Reception) REPORT	Prints after reception of a document. You can enable or disable this feature, or set the FAX to print a report only when an error occurs.	p. 11-5 p. 14-5
MULTI TX/RX (Transaction) REPORT	Prints after sending the same document to several fax numbers, or after polling multiple fax numbers in one operation.	p. 11-5
DOC. MEMORY LIST	Lists the documents currently stored in the FAX's memory.	p. 9-4
MEMORY CLEAR REPORT	Prints automatically when power is restored to the FAX after a power cut. Lists the documents deleted from memory.	p. 13-22
1-TOUCH SPD DIAL LIST 1 1-TOUCH SPD DIAL LIST 2	Lists the numbers and names registered under one-touch speed dialling buttons.	p. 6-18
CODED SPEED DIAL LIST 1 CODED SPEED DIAL LIST 2	Lists the numbers and names registered under coded speed dialling codes.	p. 6-19
GROUP DIAL LIST	Lists groups registered under one-touch speed dialling buttons and coded speed dialling codes.	p. 6-20

ACTIVITY REPORT

The FAX is factory-set to automatically print an ACTIVITY REPORT after every 20 transactions. If you want to print an ACTIVITY REPORT before it is automatically printed, follow this procedure:

1 Press **Function**.

2 Press **Report**.

ACTIVITY REPORT

3 Press **OK**.

PRINTING REPORT

- The FAX prints an ACTIVITY REPORT.

Transactions in an ACTIVITY REPORT are listed chronologically.

27/12 2002 15:00 FAX 123 4567		CANON		001	
***** *** ACTIVITY REPORT *** *****					
ST. TIME	CONNECTION TEL	CONNECTION ID	NO.	MODE	PGS. RESULT
* 27/12 13:43	905 795 1111	Canon CANADA	5001	AUTO RX	ECM 1 OK 00'33
* 27/12 13:45	905 795 1111	Canon CANADA	0001	POLLING RX	ECM 0 OK 00'00
					0 STOP
* 27/12 13:51	03 3758 2111	Canon TOKYO	0002	B'CAST	ECM 3 OK 01'18
* 27/12 13:53	2 887 0166	Canon AUSTRALIA	0002	B'CAST	ECM 3 OK 01'18
* 27/12 14:10	905 795 1111	Canon CANADA	5002	AUTO RX	ECM 1 OK 00'18
* 27/12 14:16	2 887 0166	Canon AUSTRALIA	5003	AUTO RX	ECM 4 OK 03'59
* 27/12 14:27	20 545 8545	Canon EUROPA	0003	DELAYED TX	ECM 1 OK 01'20
27/12 14:30	20 545 8545	Canon EUROPA	0004	DEL SQ BDCST	ECM 1 OK 00'36
27/12 14:31	03 3758 2111	Canon TOKYO	0004	DEL SQ BDCST	ECM 1 OK 00'36
27/12 14:57	2 887 0166	Canon AUSTRALIA	0005	TRANSMIT	ECM 3 OK 01'25
					0 STOP
27/12 14:59	1 432 2060	CANON OPTICS	0006	TRANSMIT	0 OK 00'01
					0 #018

INDICATES AN ENTRY THAT HAS APPEARED ON A PREVIOUS REPORT.

TRANSACTION (TX/RX) NUMBER

TRANSACTION MODE

ERROR CORRECTION MODE TRANSACTION

ERROR PAGE

ERROR CODE (→ p. 13-8)

Stop PRESSED DURING TRANSACTION

TRANSACTION DURATION



- If you prefer the FAX not to print an ACTIVITY REPORT after every 20 transactions, disable the ACTIVITY REPORT setting (→ p. 14-5).
- Please note that only one transaction number (TX/RX NO.) is assigned when you send a document to several fax numbers in one operation.

TX (Transmission) REPORT

The FAX is factory-set to print a TX (transmission) REPORT only when an error occurs during sending. To change this setting, see TX REPORT, p. 14-5.

If you set the FAX to print a report, a TX REPORT or an ERROR TX REPORT similar to the ones below, will be printed depending on the setting you select.

27/12 2002 14:52 FAX 123 4567 CANON 001

*** TX REPORT ***

TRANSMISSION OK

TX/RX NO 0003
CONNECTION TEL 1 432 2060
SUBADDRESS

27/12 2002 14:59 FAX 123 4567 CANON 001

*** ERROR TX REPORT ***

TX FUNCTION WAS NOT COMPLETED

TX/RX NO 0004
CONNECTION TEL 20 545 8545
SUBADDRESS
CONNECTION ID Canon EUROPA
ST.TIME 27/12 14:59
USAGE T 00'18
PGS. SENT 1
RESULT NG

●

THE SLEREXE COMPANY LIMITED
SAPORS LANE-BOOLE-DORSET-BH25 8ER
TELEPHONE BOOLE (945 13) 51617 - FAX 123456

Our Ref. 350/PJC/EAC

27 December, 2002

Dr. P. N. Cundall,
Mining Surveys Ltd.,
Holroyd Road,
Reading
Berks.

OK: TRANSMISSION SUCCESSFUL
NG: SOME OR NO PAGES SENT

NUMBER OF PAGES SENT
TRANSMISSION DURATION
TRANSMISSION TIME

IF YOU ENABLE THE PRINT WITH IMAGE SETTING (→ p. 14-5), THE FIRST PAGE OF THE FAX WILL PRINT ON THE REPORT TO REMIND YOU OF THE CONTENTS OF THE FAX.

MULTI TX/RX (Transaction) REPORT

A MULTI TX/RX (transaction) REPORT similar to the one below, is printed when you send the same document to several fax numbers, or when you poll multiple fax numbers in one operation.

27/12 2002 17:23 FAX 123 4567	CANON	001
***** *** MULTI TX/RX REPORT *** *****		
TX/RX NO	0054	
PGS	1	
TX/RX INCOMPLETE		
TRANSACTION OK	[01] 905 795 1111	Canon CANADA
	[* 01] 03 3758 2111	Canon TOKYO
	[* 02] 1 49 39 25 25	Canon FRANCE
ERROR INFORMATION		

RX (Reception) REPORT

The FAX is factory-set not to print an RX (reception) REPORT even if an error occurs during reception. To change this setting, see RX REPORT, p. 14-5.

If you set the FAX to print a report, an RX REPORT similar to the one below, will be printed.

27/12 2002 15:02 FAX 123 4567	CANON	001
***** *** RX REPORT *** *****		
RECEPTION OK		
TX/RX NO	5004	905 795 1111
CONNECTION TEL		
SUBADDRESS		
CONNECTION ID	Canon CANADA	
ST.TIME	27/12 14:59	
USAGE T	01'59	
PGS.	4	
RESULT	OK	

OK: TRANSMISSION SUCCESSFUL
NG: SOME OR NO PAGES RECEIVED

NUMBER OF PAGES RECEIVED
RECEPTION DURATION
RECEPTION TIME

Chapter 12

Maintenance

❑	Periodic Cleaning	12-2
	• Cleaning the FAX's Exterior	12-2
	• Cleaning the FAX's Interior	12-3
	• Cleaning the Scanner Components	12-4
❑	Replacing the Toner Cartridge	12-6

Periodic Cleaning

This section describes the necessary cleaning procedures for your FAX. Please note the following before cleaning your unit:

- Be sure to disconnect the power cord before cleaning the FAX. Since documents in memory are erased when the power is disconnected, print or send any documents stored in memory before disconnecting the power cord (→ p. 9-4).
- Do not use tissue paper, paper towels, or similar materials for cleaning; they can stick to the components or generate static charges.



Never use volatile liquids such as thinners, benzene, acetone, or any other chemical cleaner to clean the interior of the FAX; these can damage the unit's components.

Cleaning the FAX's Exterior

Follow this procedure to clean the FAX's outer casing:

- 1** Disconnect the power cord from the FAX.
- 2** Wipe the FAX's exterior with a clean, soft, lint-free cloth moistened with water or diluted dishwashing detergent solution.
- 3** When you finished, reconnect the power cord.

Cleaning the FAX's Interior

To prevent toner powder and paper dust from accumulating inside the FAX and affecting print quality, clean the unit's print area periodically.

Follow this procedure to clean inside the FAX:

- 1 Disconnect the power cord from the FAX.
- 2 Lift the latch and open the front cover.



Do not open the front cover without lifting the latch since this may damage your unit.

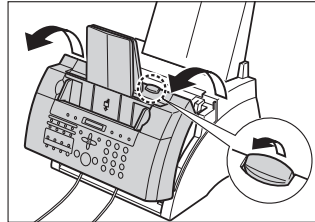

- 3 Hold the toner cartridge by its handle and remove it from the FAX.
 - To avoid exposing the toner cartridge to light, place it in its protective bag or wrap it in a thick cloth.

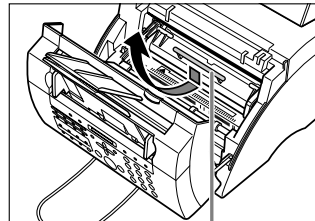

HANDLE

- 4 Use a clean, soft, dry, lint-free cloth to remove any toner or paper debris from the unit's interior (shaded area in the illustration).



• The fixing assembly becomes extremely hot when the unit is in use. Be very careful not to touch it so as to avoid injury.
• Be careful not to touch the black transfer charging roller since this adversely affects print quality.

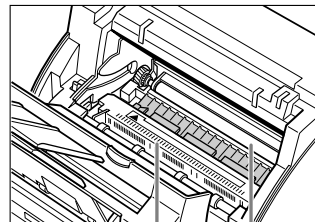

DO NOT TOUCH THE
FIXING ASSEMBLY

DO NOT TOUCH THE BLACK
TRANSFER CHARGING ROLLER

- 5 When you are finished, reinsert the toner cartridge. Hold the toner cartridge by its handle and insert it into the FAX as far as it will go, making sure that its tabs are aligned with the rails inside the unit.
 - Always hold the toner cartridge by its handle.

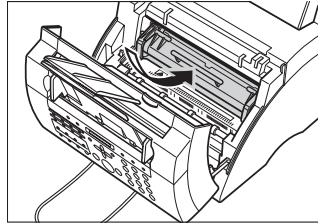

- 6 Use both hands to close the front cover.

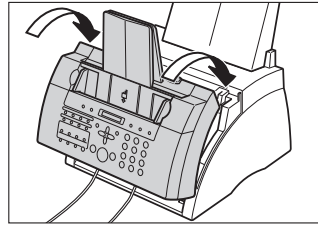

- 7 Reconnect the power cord.

Cleaning the Scanner Components

Follow this procedure to periodically check and clean the scanner components:

- 1 Disconnect the power cord from the FAX.
- 2 Use both hands to gently open the operation panel.
 - It only opens partially.
- 3 While holding the operation panel open, clean these components:
 - Separation guide and separation roller:** Wipe with a clean, soft, dry, lint-free cloth.
 - White sheet and scanning glass:** Wipe with a clean, soft, lint-free cloth moistened with water, then wipe with a clean, soft, dry, lint-free cloth.

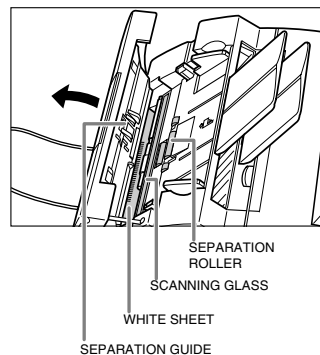



- If the scanner components are dirty, the documents you send or copy will also be dirty.
- Be sure to use a soft cloth to avoid scratching the components.
- Do not use tissue paper, paper towels, or similar materials for cleaning; they can stick to the components or generate static charges.

4 Clean the underside of the operation panel (shaded area in the illustration).

- Dirt and dust particles that collect on the underside of the operation panel affect the quality of the documents you copy or send.

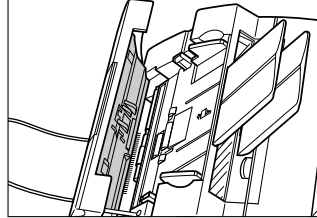

5 Use a clean, soft, dry, lint-free cloth to wipe any paper dust from the areas surrounding the separation roller (shaded area in the illustration).

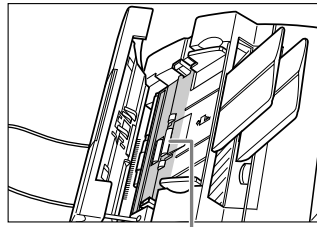

SEPARATION
ROLLER

6 When you are finished, close the operation panel by pressing it down from the centre.

- Be sure to close the operation panel until it locks into place, or the unit will not function properly.

7 Reconnect the power cord.

Replacing the Toner Cartridge

The only component of your FAX you will need to replace is the FX-3 toner cartridge. Although Canon manufactures many different toner cartridges, the FX-3 toner cartridge is the only one designed for use with your FAX. To purchase this toner cartridge, contact your local authorised Canon dealer or the Canon help line.

When CHANGE CARTRIDGE appears in the LCD, you may need to replace the toner cartridge. However, it may also indicate that the toner inside the toner cartridge is simply unevenly distributed. Before replacing the toner cartridge, follow this procedure to distribute the toner evenly:

- 1 Remove the toner cartridge from the FAX (→ steps 1 to 4, below).
- 2 Gently rock the toner cartridge from side to side a few times to distribute the toner evenly inside it.
 - Poor print quality may result if the toner is unequally distributed.

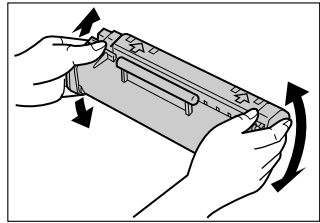

- 3 Reinsert the toner cartridge into the FAX (→ steps 8 and 9, p. 12-8).

If after following the procedure above, CHANGE CARTRIDGE remains in the LCD or print quality does not improve, follow this procedure to replace the toner cartridge:

- 1 Remove any documents and printouts from the FAX.
- 2 Make sure the FAX is plugged in.
- 3 Lift the latch and open the front cover.



Do not open the front cover without lifting the latch since this may damage your unit.

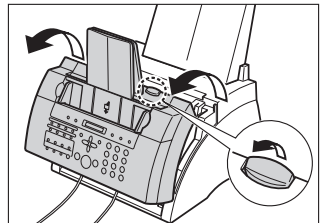

- 4** Hold the toner cartridge by its handle and remove it from the FAX.
- Discard the old toner cartridge immediately according to the local laws and regulations for disposal of consumables. To recycle your used toner cartridge, simply follow the instructions included with your new FX-3 toner cartridge.

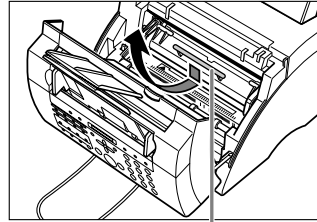

HANDLE

- 5** Remove the new FX-3 toner cartridge from its protective bag.
- Save the protective bag in case you need to repack the toner cartridge at a later date.
- 6** Gently rock the toner cartridge from side to side a few times to distribute the toner evenly inside it.
- Poor print quality may result if the toner is unequally distributed.

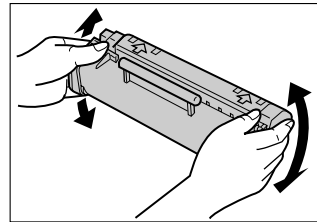

- 7** Place and support the toner cartridge on a flat, clean surface, then gently pull on the plastic tab to remove the plastic seal.
- Use a firm, even pull to avoid breaking the seal.

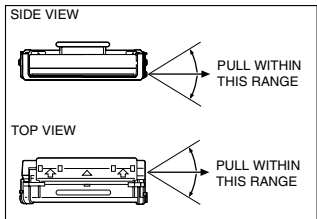
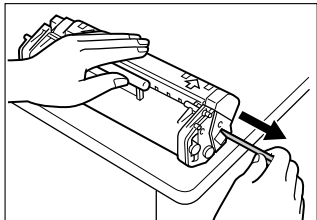

- 8** Hold the toner cartridge by its handle and insert it into the FAX as far as it will go, making sure that its tabs are aligned with the rails inside the unit.
- Always hold the toner cartridge by its handle.

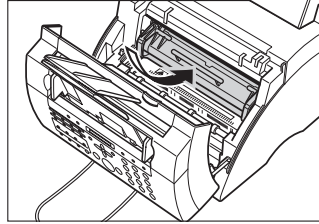

- 9** Use both hands to close the front cover.

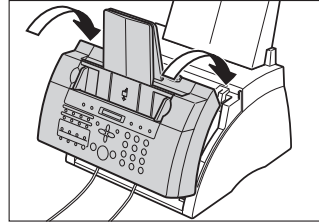

Chapter 13

Troubleshooting

❑ Clearing Jams	13-2
• Jams in the ADF	13-2
• Paper Jams	13-3
Jams in the Paper Delivery Slots	13-3
Jams Inside the Unit	13-3
❑ LCD Messages	13-8
❑ Paper Feeding Problems.....	13-13
❑ Faxing Problems	13-13
• Sending Problems	13-13
• Receiving Problems	13-15
❑ Copying Problems.....	13-17
❑ Telephone Problems.....	13-18
❑ Printing Problems.....	13-18
❑ General Problems.....	13-20
❑ If You Cannot Solve a Problem.....	13-21
❑ If a Power Cut Occurs.....	13-22

Clearing Jams

Jams in the ADF

When a document jams or misfeeds in the ADF, the LCD displays **CHECK DOCUMENT**.

Follow this procedure to clear the document jam:



You do not need to unplug the FAX when clearing document jams.

- 1 Press **Stop**.
- 2 Use both hands to gently open the operation panel.
 - It only opens partially.
 - Do not try to pull the document out without opening the operation panel since you may tear or smudge the document.

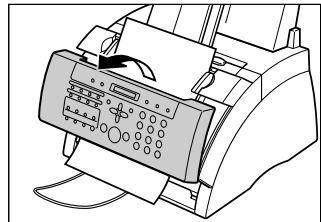

- 3 While holding the operation panel open, remove the document.
 - Pull it gently in either direction.
 - If a multipage document is loaded, remove the entire document from the ADF.

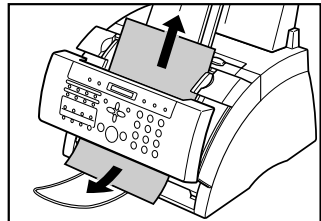

If the paper does not pull out easily, do not force it. Contact your local authorised Canon dealer or the Canon help line.

- 4 When you are finished, close the operation panel by pressing it down from the centre.
 - Be sure to close the operation panel until it locks into place, or the unit will not function properly.

Paper Jams

When paper jams in the FAX, the LCD displays CLEAR PAPER JAM. Try clearing the jam by following the procedure in *Jams in the Paper Delivery Slots* below. If this does not clear the jam, follow the procedure in *Jams Inside the Unit*.

Jams in the Paper Delivery Slots

Follow this procedure to clear a paper jam in the paper delivery slots:



You do not need to unplug the FAX when clearing paper jams.

- 1** Gently pull any jammed paper out of the unit as shown.
- 2** Remove the paper stack from the multi-purpose tray and reload it (→ p. 2-15).

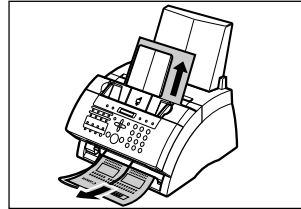

If the paper jam occurred while a fax was being received into the FAX's memory, that fax will print automatically when the jam is cleared.

Jams Inside the Unit

Follow this procedure to clear a paper jam inside the unit:



You do not need to unplug the FAX when clearing paper jams.

- 1** Lift the latch and open the front cover.



Do not open the front cover without lifting the latch since this may damage your unit.

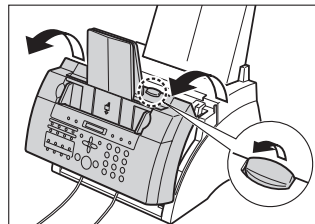

- 2 Hold the toner cartridge by its handle and remove it from the FAX.
- To avoid exposing the toner cartridge to light, place it in its protective bag or wrap it in a thick cloth.

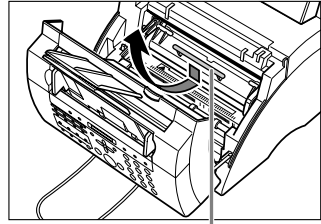

HANDLE

- 3 Move the paper release lever back.

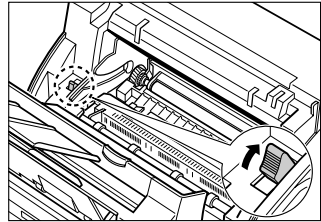

- The fixing assembly becomes extremely hot when the unit is in use. Be very careful not to touch it so as to avoid injury.
- Be careful not to touch the transfer charging roller since this adversely affects print quality.

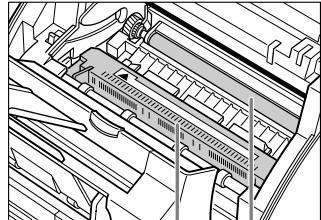

DO NOT TOUCH THE
FIXING ASSEMBLY

DO NOT TOUCH THE BLACK
TRANSFER CHARGING ROLLER

- 4** Locate the paper jam and clear it as explained on the following pages.

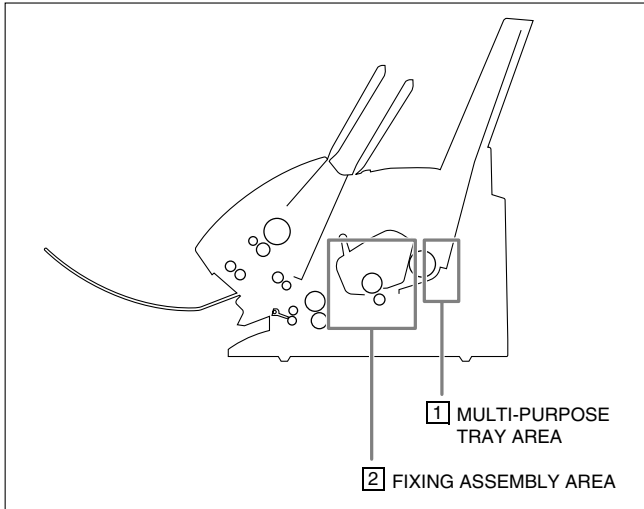

1 Multi-purpose tray area: Hold the unit steady and carefully pull the jammed paper straight out from the unit.

- Do this carefully to prevent tearing the jammed paper. If you do tear it, be sure to remove any torn pieces from the unit since these will cause paper to jam again.
- The toner on the paper will not have been fixed to the paper yet, so remove the jammed paper carefully to avoid soiling the inside of the unit. Loose toner powder inside the unit may adversely affect print quality.
- Loose toner powder can soil any surface; protect yourself and your work area. Remove immediately any toner powder from yourself or your clothing with cold water.

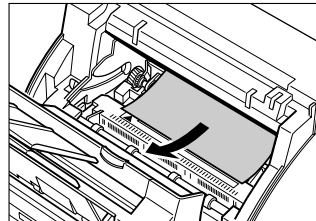

2 Fixing assembly area:
Top edge of the jammed paper in the fixing assembly:

Push the jammed paper back ①, then pull it carefully towards you to remove it ②.



The fixing assembly becomes extremely hot when the unit is in use. Be very careful not to touch it so as to avoid injury.

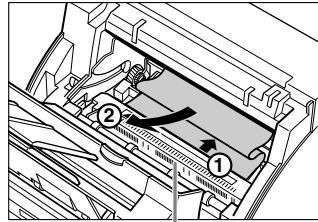

DO NOT TOUCH THE FIXING ASSEMBLY

Top edge of the jammed paper has passed through the fixing assembly:
Pass the jammed paper under the roller.

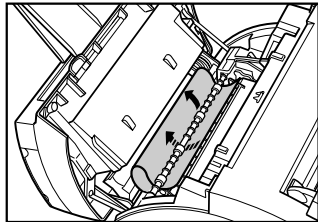

Use both hands to carefully pull out the jammed paper.

- Do this carefully to prevent tearing the jammed paper. If you do tear it, be sure to remove any torn pieces from the unit since these will cause paper to jam again.

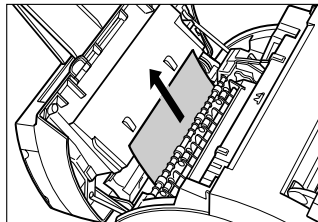

5 When you finished, reinsert the toner cartridge. Hold the toner cartridge by its handle and insert it into the FAX as far as it will go, making sure that its tabs are aligned with the rails inside the unit.

- Always hold the toner cartridge by its handle.

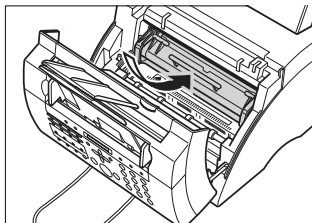

6 Move the paper release lever forward.

7 Use both hands to close the front cover.

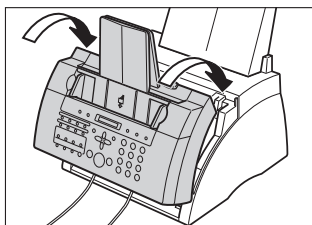

8 Reload paper in the multi-purpose tray (→ p. 2-15).



If you are experiencing repeated paper jams, it may be due to the paper you are using:

- Tap the paper on a flat surface before stacking it in the multi-purpose tray.
- Check that the paper you are using meets the requirements for your unit (→ p. 5-2).
- Make sure you have completely removed any scraps of paper from inside the FAX. Not doing so will cause paper to jam again.

LCD Messages

The following messages are displayed in the LCD when the FAX is performing a task, or when it encounters an error. The error code appears in the ACTIVITY REPORT (→ p. 11-3).

Message	Error Code	Cause	Action
AUTO REDIAL	—	The unit is waiting to redial the other party's fax number because the line was busy or the other party did not answer when you tried to send the document.	Wait for the unit to automatically redial the fax number (→ p. 7-9).
BUSY/NO SIGNAL	#018	The fax/telephone number you dialled is busy.	Try sending the document at a later time.
		The fax number dialled was incorrect.	Check the fax number and dial again.
		The other party's fax machine is not working.	Contact the other party and have them check their fax machine.
		The other party is not using a G3 fax machine.	Contact the other party to check that they are using a G3 fax machine.
		The telephone line type setting on your unit is incorrect.	Set your unit for your telephone line type (→ p. 3-8).
		The receiving fax machine did not answer within 55 seconds (after all automatic redialling attempts).	Contact the other party and have them check their fax machine. You can try to send the document using manual sending via the handset (→ p. 7-6). For an overseas call, add pauses to the registered number (→ p. 9-2).
CHANGE CARTRIDGE	—	The toner inside the toner cartridge may be unevenly distributed.	Redistribute the toner inside the toner cartridge (→ p. 12-6). If the message remains, replace the toner cartridge (→ p. 12-6).
		The toner cartridge is empty.	Replace the toner cartridge (→ p. 12-6).

Message	Error Code	Cause	Action
CHECK COVER	—	The front cover is open.	Close the front cover.
CHECK DOCUMENT	#001	A document is jammed in the ADF.	Clear the document jam (→ p. 13-2). Then start again.
CHECK PAPER SIZE	—	The size of the paper in the multi-purpose tray and that specified in the PAPER SIZE setting are different.	Load the correct paper size (→ p. 2-15) or change the PAPER SIZE setting (→ p. 5-6) to match the size of the paper loaded in the multi-purpose tray.
CHECK POLLING ID	#021	No subaddress and/or password has been entered on your unit, or the subaddress and/or password do not match the settings on the other party's fax machine.	Make sure the subaddress and/or password match the settings on the other party's fax machine (→ p. 9-9).
	#008	No subaddress and/or password has been entered on the other party's machine, or the subaddress and/or password do not match the settings on your unit.	Contact the other party to enter the correct subaddress and/or password.
CHECK PRINTER	—	The toner cartridge may be defective.	Reinstall the toner cartridge (→ p. 2-12). If the message remains in the LCD, replace the toner cartridge (→ p. 12-6).
		The unit is connected to an uninterruptible power supply (UPS).	Make sure the unit is plugged into an AC outlet. In either case, if the error does not clear, try unplugging the unit. Wait five seconds, then plug it back in. If the message remains in the LCD, contact your local authorised Canon dealer or the Canon help line.

Message	Error Code	Cause	Action
CHK SUBADDR/PSWD	#083/12	You attempted to send a document or poll another fax machine with the incorrect subaddress and/or password.	Contact the other party to check their settings. Change your settings if necessary (→ pp. 6-3, 6-7, 9-9).
CLEAR PAPER JAM	—	There is a paper jam.	Clear the paper jam (→ p. 13-3), then reload paper in the multi-purpose tray (→ p. 2-15).
DOC. TOO LONG	#003	The document is longer than 1 metre.	Use a copier to make a reduced copy of the document and then send the copy.
ECM RX	—	The unit is receiving a fax using Error Correction Mode (ECM).	Receiving with ECM may take longer than normal receptions. Turn off ECM if you need to receive quickly, or if you know your local lines are in good condition (→ ECM RX, p. 14-7).
ECM TX	—	The unit is sending a fax using Error Correction Mode (ECM).	Sending with ECM may take longer than normal transmissions. Turn off ECM if you need to transmit quickly, or if you know your local lines are in good condition (→ ECM TX, p. 14-6).
LOAD PAPER	—	The multi-purpose tray is empty.	Load paper in the multi-purpose tray (→ p. 2-15), then press Stop .
MEMORY FULL	#037	The unit's memory is full because it has received too many documents, or a very long or detailed document.	Print any documents stored in memory (→ p. 9-5). Then start again.
		The unit's memory is full because you tried to send or copy too many pages at once, or a very long or detailed document.	Divide the document and send or copy each part separately. To free up space in the unit's memory, print, send, or delete any documents in memory you no longer need (→ p. 9-4).

Message	Error Code	Cause	Action
MEMORY USED <i>nn</i> %	—	Shows the percentage of memory currently in use.	If you need more space, wait for the unit to send any faxes. Also, print, send, or delete any documents in memory you no longer need (→ p. 9-4).
NO RX PAPER	#012	The other party's fax machine is out of paper or its memory is full.	Contact the other party and have them load paper in their fax machine or free up space in their fax machine's memory.
NO TEL #	#022	The one-touch speed dialling button or coded speed dialling code you entered has not been registered.	Register the one-touch speed dialling button or coded speed dialling code (→ Chapter 6).
NOT AVAILABLE	—	You entered an invalid number.	Enter a valid number.
PSWD POLL REJECT	#084	You attempted to poll a fax machine with a password, but the other party has not set a password or their fax machine does not support polling with a password.	Contact the other party to check their settings. If their fax machine does not support polling with a password, delete the password you have registered (→ pp. 6-3, 6-7, 6-9).
PSWD TX REJECTED	#081	You attempted to send a document with a password, but the other party's fax machine does not support reception with a password.	Contact the other party to check their settings. If their fax machine does not support reception with a password, delete the password you have registered (→ pp. 6-3, 6-7).

Message	Error Code	Cause	Action
REC'D IN MEMORY	—	The unit received the fax in memory because paper or toner ran out, or a paper jam occurred during reception.	Load paper in the multi-purpose tray (→ p. 2-15), replace the toner cartridge (→ p. 12-6), or clear the paper jam (→ p. 13-3).
SELECT POL REJCT	#082	You attempted to poll a fax machine with a subaddress, but the other party has not set a subaddress or their fax machine does not support polling with a subaddress.	Contact the other party to check their settings. If their fax machine does not support polling with a subaddress, delete the subaddress you have registered (→ pp. 6-3, 6-7, 9-9).
SUBADD TX REJECT	#080	You attempted to send a document with a subaddress, but the other party's fax machine does not support reception with a subaddress.	Contact the other party to check their settings. If their fax machine does not support reception with a subaddress, delete the subaddress you have registered (→ pp. 6-3, 6-7).
TX/RX CANCELLED	—	You pressed Stop to cancel a transaction.	—
TX/RX NO. <i>nnnn</i>	—	The number shown (<i>nnnn</i>) is a unique identification number assigned to the document you are sending or receiving.	This number appears in reports so you can identify transactions. Write the number down if you will need it later.
TX/RX NO. <i>nnnn</i> SCANNING P. <i>nnn</i> MEMORY FULL (Three messages toggle.)	—	The unit is sending a document and its memory is full.	The unit continues to send the document as memory becomes available.

Paper Feeding Problems

■ Paper does not feed properly.

The multi-purpose tray may contain too many sheets.

- Make sure you load the correct quantity (→ p. 5-2).

The paper may not be loaded correctly.

- Make sure the paper stack is loaded correctly in the multi-purpose tray (→ p. 2-15).

■ Multiple sheets feed together into the FAX.

The paper may not be loaded correctly.

- Make sure the paper stack is loaded correctly in the multi-purpose tray (→ p. 2-15).

The multi-purpose tray may contain too many sheets.

- Make sure you load the correct quantity (→ p. 5-2).

Different types of paper may be loaded in the multi-purpose tray.

- Load only one type of paper.
- Make sure you load paper that meets the requirements for the FAX (→ p. 5-2).
- Let the paper run out before refilling the multi-purpose tray. Avoid mixing new stock with paper already loaded.

■ Repeated paper jams occur.

The paper you are using may be causing the jams.

- Make sure you load paper that meets the requirements for the FAX (→ p. 5-2).

Faxing Problems

Sending Problems

■ Cannot send a fax.

The FAX may not be set for the correct telephone line type.

- Make sure the FAX is set for the correct telephone line type (→ p. 3-8).

The document may not be loaded correctly.

- Make sure the document is loaded correctly in the ADF (→ p. 4-3).
- Make sure the operation panel is closed.

The one-touch speed dialling button or coded speed dialling code you entered may not be registered correctly.

- Check that the speed dialling settings are registered correctly (→ Chapter 6).

You dialled or have been provided with an incorrect number.

- Dial the number again, or check that you have the correct number.

The other party's fax machine may be out of paper.

- Contact the other party and ask them to make sure paper is loaded in their fax machine.

There may be other documents being sent from memory.

- Allow time for those documents to finish sending.

An error may have occurred during sending.

- Print an ACTIVITY REPORT and check for an error code (→ p. 11-3).

The telephone line may not be working properly.

- Make sure there is a dial tone when you press Hook or when you lift the handset of any external device connected to the FAX. If there is no dial tone, contact your local telephone company.

The receiving fax machine may not be a G3 fax machine.

- Make sure the receiving fax machine is compatible with your FAX (which is a G3 fax machine).

The subaddress and/or password are incorrect.

- If you registered a subaddress/password under a speed dialling button or code, make sure they match the other party's settings.

■ **Faxes sent from the FAX are spotted or dirty.**

The receiving fax machine may not be working properly.

- Check the FAX by making a copy (→ p. 10-2). If the copy is clear, the problem may be in the receiving fax machine. If the copy is spotted or dirty, clean the scanner components (→ p. 12-4).

The document may not be loaded correctly.

- Make sure the document is loaded correctly in the ADF (→ p. 4-3).

■ **Cannot send using Error Correction Mode (ECM).**

The other party's fax machine may not support ECM.

- If this is the case, the document is sent without ECM.

ECM may be disabled.

- Make sure ECM on your FAX is enabled (→ ECM TX, p. 14-6).
- Contact the other party to check if ECM on their fax machine is enabled.

■ **Errors occur frequently while sending.**

The telephone lines may be in poor condition, or you may have a bad connection.

- Lower the transmission speed (→ TX START SPEED, p. 14-10).



If none of these solutions solve the problem, unplug the FAX and wait for at least five seconds. Then plug it back in and try sending again. If you still cannot send, contact your local authorised Canon dealer or the Canon help line.

Receiving Problems

■ **Cannot receive a fax automatically.**

The FAX may not be set to receive automatically.

- For the FAX to receive faxes automatically, the receive mode must be set to FAX ONLY MODE, Fax/Tel Mode, ANS.MACHINE MODE, or NET SWITCH* (→ Chapter 8). If you have set ANS.MACHINE MODE, confirm that an answering machine is connected to the FAX and that it is turned on with an outgoing message properly recorded (→ p. 8-9).

The FAX may have a document stored in memory, leaving little or no memory available.

- Print, send, or delete any documents stored in memory (→ p. 9-4).

An error may have occurred during reception.

- Check the LCD for an error message (→ p. 13-8).
- Print an ACTIVITY REPORT and check for an error code (→ p. 11-3).

The multi-purpose tray may be empty.

- Make sure paper is loaded in the multi-purpose tray (→ p. 2-15).

The telephone line cord may not be connected properly.

- Make sure it is connected properly (→ p. 2-5).

■ **No automatic switching between telephone and fax calls.**

The FAX may not be set to switch automatically between telephone and fax calls.

- For the FAX to switch automatically, the receive mode must be set to Fax/Tel Mode, ANS.MACHINE MODE, or NET SWITCH*. If you have set ANS.MACHINE MODE, confirm that an answering machine is connected to the FAX and that it is turned on with an outgoing message properly recorded (→ p. 8-9).

The FAX may have a document stored in memory, leaving little or no memory available.

- Print, send, or delete any documents stored in memory (→ p. 9-4).

* NET SWITCH is available for certain countries only.

An error may have occurred during reception.

- Check the LCD for an error message (→ p. 13-8).
- Print an **ACTIVITY REPORT** and check for an error code (→ p. 11-3).

The multi-purpose tray may be empty.

- Make sure paper is loaded in the multi-purpose tray (→ p. 2-15).

The other party's fax machine may not send the CNG signal that tells your FAX that the incoming call is a fax call.

- Some fax machines cannot send this signal. In such cases, you will have to receive the fax manually (→ p. 8-7).

■ **Cannot receive a document manually.**

You may have disconnected the call by pressing Start/Copy or dialling the remote receiving ID after hanging up.

- Always press **Start/Copy** or dial the remote receiving ID before hanging up. Otherwise you will disconnect the call (→ p. 8-7).

■ **Print quality is poor.**

You may not be using the correct paper type.

- Make sure you load paper that meets the requirements for the FAX (→ p. 5-2).

The other party's fax machine may not be functioning properly.

- The sending fax machine usually determines the fax's quality. Contact the other party and have them check that the scanning components of their fax machine are clean.

Error Correction Mode (ECM) may be disabled.

- Make sure ECM is on (→ ECM RX, p. 14-7).

■ **Faxes do not print.**

The toner cartridge may not be installed properly.

- Make sure the toner cartridge is installed properly (→ p. 2-12).

The toner cartridge may need to be replaced.

- Replace the toner cartridge (→ p. 12-6).

■ **Received faxes print blotched or unevenly.**

The telephone lines may be in poor condition, or you may have a bad connection.

- Error Correction Mode (ECM) sending/receiving should eliminate such problems. However, if the telephone lines are in poor condition, you may have to try again.

The other party's fax machine may not be functioning properly.

- The sending fax machine usually determines the fax's quality. Contact the other party and have them check that the scanning components of their fax machine are clean.

Toner may be low or unevenly distributed.

- Redistribute the toner inside the toner cartridge (→ p. 12-6). If the problem persists, replace the toner cartridge (→ p. 12-6).

■ Cannot receive using Error Correction Mode (ECM).**The other party's fax machine may not support ECM.**

- If this is the case, the document is received without ECM.

ECM may be disabled.

- Make sure ECM on your FAX is enabled (→ ECM RX, p. 14-7).
- Contact the other party to check if ECM on their fax machine is enabled.

■ Errors occur frequently while receiving.**The telephone lines may be in poor condition, or you may have a bad connection.**

- Lower the reception speed (→ RX START SPEED, p. 14-11).

The other party's fax machine may not be functioning properly.

- Contact the other party and have them check that their fax machine is functioning properly.

Copying Problems

■ Cannot make copies.**The document may not be loaded correctly.**

- Make sure the document is loaded correctly in the ADF (→ p. 4-3).
- Make sure the operation panel is closed.

The document may not meet the requirements for the FAX.

- Make sure you load documents that meet the requirements for the FAX (→ p. 4-2).

■ MEMORY FULL appears in the LCD when making multiple copies.**The FAX's memory is full.**

- Print, send, or delete any documents stored in memory (→ p. 9-4) to free up space in the FAX's memory, then start again.

The document you are copying may have too many graphics.

- If multiple pages are being copied, separate the pages into smaller stacks. If not, make the desired number of copies one at a time as needed.



For additional troubleshooting, see *Printing Problems*, p. 13-18.

Telephone Problems

■ Cannot dial.

The telephone line cord may not be connected properly.

- Make sure it is connected properly (→ p. 2-5).

The power cord may not be plugged in securely.

- Check that the power cord is plugged securely into the FAX and into the wall outlet (→ p. 2-7). If the unit is plugged into a power strip, make sure the power strip is plugged in and turned on.

The FAX may not be set for the correct telephone line type.

- Make sure the FAX is set for the correct telephone line type (→ p. 3-8).

■ Optional handset or telephone disconnects while you are talking.

The power cord may not be plugged in securely.

- Check that the power cord is plugged securely into the FAX and into the wall outlet (→ p. 2-7). If the unit is plugged into a power strip, make sure the power strip is plugged in and turned on.

The optional handset or telephone cord may be defective.

- Check the cord by substituting with another cord.

Printing Problems

■ Alarm light is lit and the FAX beeps while printing.

The FAX may have a paper jam.

- Clear the paper jam (→ p. 13-3).
- If the FAX has no paper jam, unplug the unit and wait 5 seconds, then plug it back in. If the Alarm light remains lit, contact your local authorised Canon dealer or the Canon help line.

■ Nothing prints.

The power cord may not be plugged in securely.

- Check that the power cord is plugged securely into the FAX and into the wall outlet (→ p. 2-7). If the unit is plugged into a power strip, make sure the power strip is plugged in and turned on.

You may not have removed the plastic seal from the toner cartridge.

- Make sure you install the toner cartridge properly (→ p. 2-12).

The toner cartridge may need to be replaced.

- Replace the toner cartridge (→ p. 12-6).

■ Printout does not match paper size.**The paper may not be loaded correctly.**

- Make sure the paper stack is loaded correctly in the multi-purpose tray (→ p. 2-15).

■ Printout is skewed.**The paper may not be loaded correctly.**

- Make sure the paper stack is loaded correctly in the multi-purpose tray (→ p. 2-15).
- Make sure the paper delivery slots are clear.

■ Paper jams occur.**You may not be using the correct paper delivery slot.**

- Select the correct paper delivery slot (→ p. 5-4).

■ Printout is not clear.**You may not be using the correct paper type.**

- Make sure you load paper that meets the requirements for the FAX (→ p. 5-2).

You may be printing on the wrong side of the paper.

- Some papers have a “right” side for printing. If the print quality is not as clear as you would like it to be, try turning the paper over and printing on the other side.

■ Printout has vertical white streaks.**Toner may be low or unevenly distributed.**

- Redistribute the toner inside the toner cartridge (→ p. 12-6). If the problem persists, replace the toner cartridge (→ p. 12-6).

General Problems

■ **FAX has no power.**

The power cord may not be plugged in securely.

- Check that the power cord is plugged securely into the FAX and into the wall outlet (→ p. 2-7). If the unit is plugged into a power strip, make sure the power strip is plugged in and turned on.

The power cord may not be supplying power.

- Check the power cord by substituting with another, or by using a voltmeter to test it for continuity.

■ **Nothing appears in the LCD.**

The power cord may not be plugged in securely.

- Check that the power cord is plugged securely into the FAX and into the wall outlet (→ p. 2-7). If the unit is plugged into a power strip, make sure the power strip is plugged in and turned on. If the LCD remains blank, unplug the unit and wait five seconds, then plug it back in. If the LCD still remains blank, contact your local authorised Canon dealer or the Canon help line.

If You Cannot Solve a Problem

If you cannot solve the problem after having referred to the information in this chapter, contact your local authorised Canon dealer or the Canon help line.

Canon's support personnel are trained in the technical support of Canon's products and will be able to help you with your problem.



Attempting to repair the FAX yourself may void the limited warranty.



If the FAX makes strange noises, emits smoke or strange smells, unplug it immediately and contact your local authorised Canon dealer or the Canon help line. Do not attempt to disassemble or repair the unit yourself.

If you need to contact Canon directly, make sure you have the following information:

- **Product name**
FAX-L220 or FAX-L295
- **Serial number**
The serial number is on the label located at the back of the unit.

<div style="display: flex; justify-content: space-between;"> Canon HXXXXX </div> <hr style="border: 0; border-top: 1px solid black; margin: 5px 0;"/> <div style="display: flex; justify-content: space-between;"> NO. XXX XXXXXXXXX </div>
--

- **Place of purchase**
- **Nature of problem**
- **Steps you have taken to solve the problem and the results**

If a Power Cut Occurs

If power is suddenly lost due to a power cut or accidental unplugging, a built-in battery retains the FAX's settings. However, any documents stored in memory will be lost.

During a power cut, functions are limited as follows:

- You cannot make telephone calls from the optional handset. Also, depending on the telephone, you may not be able to make telephone calls.
- You cannot send, receive, or copy documents.
- You can receive telephone calls from the optional handset or telephone connected to your unit.

When power is restored, the FAX automatically prints a MEMORY CLEAR REPORT that lists the documents that were deleted from memory as a result of the power cut.

27/12 2002 16:48 FAX 123 4567		CANON		001	
***** *** MEMORY CLEAR REPORT *** *****					
MEMORY FILES DELETED					
TX/RX NO	MODE	CONNECTION TEL/ID	PGS.	SET TIME	ST. TIME
0046	TRANSMIT	{ 01} Canon TOKYO	3	27/12 16:03	
0047	B'CAST	{ 01} Canon CANADA	1	27/12 16:08	
		{ 02} Canon FRANCE			
0048	DEL SQ BDCST	{ 03} Canon ITALIA	1	27/12 16:15	20:00
		{ 04} Canon U.S.A.			20:00
0049	DELAYED TX	{ 08} Canon OPTICS	2	27/12 16:36	22:00



If the toner cartridge is empty or there is no paper in the multi-purpose tray when power is restored, the LCD displays CHANGE CARTRIDGE or LOAD PAPER. In these cases, the MEMORY CLEAR REPORT will not be printed even after the toner cartridge is replaced or paper is loaded.

Chapter 14

Summary of Settings

❑ Understanding the Menu System.....	14-2
• Printing a List to Check the Current Settings	14-2
• Accessing the Menus	14-3
❑ USER SETTINGS Menu	14-4
❑ REPORT SETTINGS Menu	14-5
❑ TX (Transmission) SETTINGS Menu	14-6
❑ RX (Reception) SETTINGS Menu	14-7
❑ PRINTER SETTINGS Menu.....	14-8
❑ POLLING BOX Menu	14-9
❑ SYSTEM SETTINGS Menu.....	14-10

Understanding the Menu System

The FAX menu system allows you to customise the way your unit operates. It consists of seven menus, each containing settings that control different functions of your FAX.

Before adjusting any settings, you may want to print the USER'S DATA LIST to check the current settings (→ below).

Printing a List to Check the Current Settings

You can print the USER'S DATA LIST to check the current settings of your FAX as well as the registered sender information (→ p. 3-5).

Follow this procedure to print the USER'S DATA LIST:

1 Press **Function**.

2 Press **Report**.

ACTIVITY REPORT

3 Use ▼ or ▲ to select **USER DATA LIST**.

USER DATA LIST

4 Press **OK**.

- The FAX prints the USER'S DATA LIST.

PRINTING REPORT

The sender information is shown at the beginning of the list. The current settings of the FAX are listed after this.

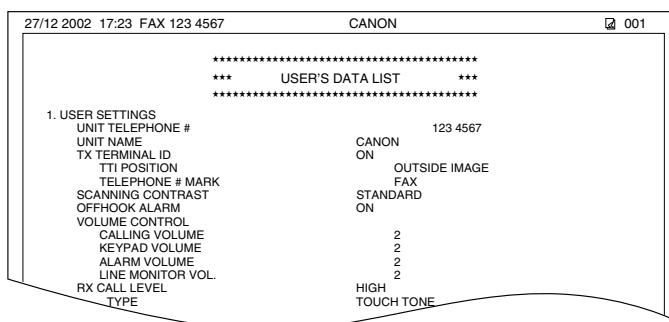

Accessing the Menus

Follow this procedure to access the different menus:

1 Press **Function**.

2 Press **Data Registration**.

DATA REGISTRATION

3 Press **OK**.

USER SETTINGS

4 Use ▼ or ▲ to select the menu you want.

- You can select from the following:
 - USER SETTINGS (→ p. 14-4)
 - REPORT SETTINGS (→ p. 14-5)
 - TX SETTINGS (→ p. 14-6)
 - RX SETTINGS (→ p. 14-7)
 - PRINTER SETTINGS (→ p. 14-8)
 - POLLING BOX (→ p. 14-9)
 - SYSTEM SETTINGS (→ p. 14-10)

5 Press **OK** to access the settings under the menu you selected.

Ex: ECM RX

6 Refer to the appropriate table (→ following pages) and use these guidelines to select and register settings:

- Use ▼ or ▲ to scroll through the settings.
- To register a setting or access sub-settings, press **OK**.
- To return to a previous level, press **Function** then **Data Registration**.
 - For your settings to be registered, be sure to press **OK** after making a selection or entering information.
 - If at any stage you wish to return to standby mode, press **Stop**.
 - If you pause for more than 60 seconds while accessing a menu, the unit will automatically return to standby mode.

7 When you are finished, press **Stop** to return to standby mode.

Ex: 15:00 FaxOnly

USER SETTINGS Menu

For details on accessing the settings below, see p. 14-3.

The selectable settings and the default settings vary depending on the country where you have purchased the FAX. The values shown here are average values.

Setting	Description	Sub-Settings
DATE & TIME	Sets the current date and time (→ p. 3-6).	–
UNIT TELEPHONE #	Enters the fax/telephone number you want to appear at the top of each fax page you send (→ p. 3-6).	–
UNIT NAME	Enters the name or company name you want to appear at the top of each fax page you send (→ p. 3-6).	–
TX TERMINAL ID	Enables/disables printing of the sender information (→ p. 3-5).	ON OFF
TTI POSITION	Selects whether the sender information is positioned inside or outside the image area (→ p. 3-5).	OUTSIDE IMAGE INSIDE IMAGE
TELEPHONE # MARK	Selects the prefix for the unit number (→ p. 3-5).	FAX TEL
SCAN CONTRAST	Selects the scanning contrast (→ p. 7-3).	STANDARD DARKER LIGHTER
OFFHOOK ALARM	Enables/disables the off hook alarm that alerts you that the handset is not seated properly in its cradle.	ON OFF
VOLUME CONTROL	Sets the volume of the FAX sounds.	–
CALLING VOLUME	Selects the ring volume when the FAX detects a voice call.	1/2/3
KEYPAD VOLUME	Selects the keypad touch beep volume.	0 (off) / 1/2/3
ALARM VOLUME	Selects the error alarm volume.	0 (off) / 1/2/3
LINE MONITOR VOL	Selects the line monitor volume (sound during dialling).	0 (off) / 1/2/3
RX CALL LEVEL	Selects the ring type for incoming calls.	HIGH STANDARD
TEL LINE TYPE	Selects the telephone line type setting for your FAX (→ p. 3-8).	TOUCH TONE ROTARY PULSE
R-KEY SETTING	Enables dialling through a switchboard. If you select PBX, you can select additional sub-settings (→ p. 3-9).	PSTN PBX

REPORT SETTINGS Menu

For details on accessing the settings below, see p. 14-3.

The selectable settings and the default settings vary depending on the country where you have purchased the FAX. The values shown here are average values.

Setting	Description	Sub-Settings
TX REPORT	Enables/disables automatic printing of a TX (transmission) REPORT (→ p. 11-4). PRINT ERROR ONLY: Prints a report only when a transmission error occurs. OUTPUT YES: Prints a report every time you send a document. OUTPUT NO: No report is printed.	PRINT ERROR ONLY OUTPUT YES OUTPUT NO
PRINT WITH IMAGE	If you select PRINT ERROR ONLY or OUTPUT YES above, this setting enables/disables printing of the first page of the fax under the report.	ON OFF
RX REPORT	Enables/disables automatic printing of an RX (reception) REPORT (→ p. 11-5). OUTPUT NO: No report is printed. PRINT ERROR ONLY: Prints a report only when a reception error occurs. OUTPUT YES: Prints a report every time you receive a document.	OUTPUT NO PRINT ERROR ONLY OUTPUT YES
ACTIVITY REPORT	Enables/disables automatic printing of an ACTIVITY REPORT after every 20 transactions (→ p. 11-3).	AUTO PRINT ON AUTO PRINT OFF

TX (Transmission) SETTINGS Menu

For details on accessing the settings below, see p. 14-3.

The selectable settings and the default settings vary depending on the country where you have purchased the FAX. The values shown here are average values.

Setting	Description	Sub-Settings
ECM TX	Enables/disables Error Correction Mode (ECM) during transmission.	ON OFF
MID PAUSE SET	Selects the length of a pause entered within a fax/telephone number with the Redial/Pause button.	2 SEC (1 to 15)
AUTO REDIAL	Enables/disables automatic redialling if the other party's line is busy on the first attempt (→ p. 7-9).	ON OFF
REDIAL TIMES	Selects the number of redial attempts.	2 TIMES (1 to 10)
REDIAL INTERVAL	Selects the time interval between redial attempts.	2 MIN. (2 to 99)
TIME OUT	Enables/disables automatic scanning of documents after the fax number is entered. ON: Scanning begins automatically five seconds after entering the fax number (10 seconds if sending to multiple fax numbers). OFF: Scanning does not start automatically. (You need to press Start/Copy to begin scanning.)	ON OFF

RX (Reception) SETTINGS Menu

For details on accessing the settings below, see p. 14-3.

The selectable settings and the default settings vary depending on the country where you have purchased the FAX. The values shown here are average values.

Setting	Description	Sub-Settings
ECM RX	Enables/disables Error Correction Mode (ECM) during reception.	ON OFF
RX MODE	Selects the receive mode (→ Chapter 8). If you select FAX/TEL AUTO SW, you can select additional sub-settings (→ p. 8-4).	FAX ONLY MODE NET SWITCH* FAX/TEL AUTO SW
INCOMING RING	When the RX MODE setting is set to FAX ONLY MODE or FAX/TEL AUTO SW, this setting enables/disables ringing when the FAX receives a call.**	OFF ON
RING COUNT	Selects the number of rings before the FAX begins receiving.	2 TIMES (1 to 99)
MAN/AUTO SWITCH	When the receive mode is set to MANUAL MODE, this setting determines if the FAX switches to fax receive mode after it rings for a specified time.	OFF ON
F/T RING TIME	If you select ON above, this setting selects the length of time the FAX rings before switching to fax receive mode.	15 SEC (1 to 99)
REMOTE RX	Enables/disables remote receiving.	ON OFF
REMOTE RX ID	If you select ON above, this setting selects the remote receiving ID.	25 (00 to 99)
MEMORY RX	Enables/disables reception of a document in the FAX's memory when a problem occurs during reception.	ON OFF
RX PAGE FOOTER	Enables/disables printing of the reception date and time, page number, and transaction number (TX/RX NO.) at the bottom of each received fax page.	OFF ON

* This setting is available for certain countries only.

** Even if you have set INCOMING RING to ON, ringing will only occur if you have connected the optional handset or a telephone to your unit.

PRINTER SETTINGS Menu

For details on accessing the settings below, see p. 14-3.

The selectable settings and the default settings vary depending on the country where you have purchased the FAX. The values shown here are average values.

Setting	Description	Sub-Settings
RX REDUCTION	Enables/disables reduction of faxes to fit on the paper loaded in the multi-purpose tray. If you select ON, you can select the direction of the reduction.	ON OFF VERTICAL ONLY HORIZ & VERTICAL
PAPER SIZE	Selects the size of the paper loaded in the multi-purpose tray (→ p. 5-6). If you select CUSTOM, you can select additional sub-settings (→ p. 5-6).	A4 LTR LGL CUSTOM
ECONOMY PRT	Enables/disables economy printing (→ p. 5-8).	OFF ON
TONER SUPPLY LOW	Selects whether the FAX continues printing when toner level is low (CHANGE CARTRIDGE displayed in the LCD). RX TO MEMORY: Stops printing and received faxes are stored in memory. KEEP PRINTING: Continues printing even when toner level is low. Select this setting when you do not have a new toner cartridge available and need to print any faxes received in memory.	RX TO MEMORY KEEP PRINTING

POLLING BOX Menu

For details on accessing the settings below, see p. 14-3.

The selectable settings and the default settings vary depending on the country where you have purchased the FAX. The values shown here are average values.

Setting	Description	Sub-Settings
SETUP FILE	Sets up the polling box to hold a document to be polled (→ p. 9-11).	-
FILE NAME	Enters the name for the polling box.	-
PASSWORD	Enters a password to restrict access to the polling box settings.	0000 to 9999
TX PASSWORD	Enters a standard ITU-T password.	-
ERASE AFTER TX	Selects whether the document is deleted from memory once it is polled, or continues to be stored in memory. ON: Document is deleted from memory after it is polled. OFF: Document remains in memory after it is polled.	ON OFF
CHANGE DATA	Changes the polling box settings (→ p. 9-14).	-
PASSWORD	Enters the password (if registered) to access the polling box settings.	-
DELETE FILE	Deletes the polling box settings (→ p. 9-14).	-
PASSWORD	Enters the password (if registered) to access the polling box settings.	-

SYSTEM SETTINGS Menu

For details on accessing the settings below, see p. 14-3.

The selectable settings and the default settings vary depending on the country where you have purchased the FAX. The values shown here are average values.

Setting	Description	Sub-Settings
UN/LOCK PHONE	Enables/disables restriction of the FAX (→ p. 9-16).	–
LOCK PHONE	Enables/disables restriction of the FAX to make calls and send faxes.	OFF ON
PASSWORD	Enters a password to restrict access to the LOCK PHONE setting.	0000 to 9999
RX RESTRICTION	Restricts reception of faxes to the numbers registered for speed dialling on your FAX (→ p. 9-19). If you select ON, you can select additional sub-settings.	OFF ON
DATE SETUP	Selects the date format displayed in the LCD and printed on the faxes you send.	DD/MM YYYY YYYY MM/DD MM/DD/YYYY
DISPLAY LANGUAGE	Selects the language of the LCD messages, settings, and reports.	ENGLISH FRENCH SPANISH GERMAN ITALIAN DUTCH FINNISH PORTUGUESE NORWEGIAN SWEDISH DANISH SLOVENE CZECH HUNGARIAN RUSSIAN
TX START SPEED	Selects the speed at which the FAX starts transmitting.	33600bps 14400bps 9600bps 7200bps 4800bps 2400bps

Setting	Description	Sub-Settings
RX START SPEED	Selects the speed at which the FAX starts receiving.	33600bps 14400bps 9600bps 7200bps 4800bps 2400bps
COUNTRY SELECT*	Selects the country where you are using the FAX to automatically switch the selectable settings and the default settings to suit the selected country (→ p. 2-8).	UK GERMANY FRANCE ITALY SPAIN HOLLAND DENMARK NORWAY SWEDEN FINLAND AUSTRIA BELGIUM SWITZERLAND PORTUGAL IRELAND GREECE LUXEMBOURG HUNGARY CZECH RUSSIA SLOVENIA SOUTH AFRICA OTHERS
SUMMER TIME*	Sets the summer time (→ p. 3-11). If you select ON, you can select additional sub-settings.	OFF ON

* This setting is available for certain countries only.

Appendix A Specifications

<input type="checkbox"/> General Specifications	A-2
<input type="checkbox"/> Facsimile	A-2
<input type="checkbox"/> Copier.....	A-3
<input type="checkbox"/> Telephone.....	A-3
<input type="checkbox"/> Printer.....	A-3

General Specifications

Power Source

- 200-240 V
- 50/60 Hz

Power Consumption

- Maximum: 500 W
- Standby: Approx. 3.5 W

Weight

Approx. 10 kg (With components attached)

Dimensions

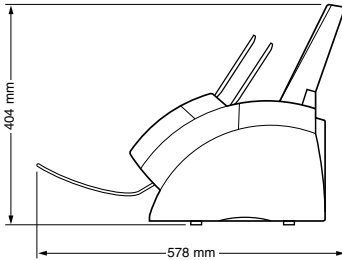
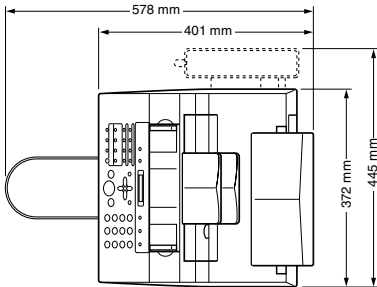

Environmental Conditions

- Temperature: 10°C-32.5°C
- Humidity: 20%-80% RH

Liquid Crystal Display (LCD)

16 × 1

Display Languages

English/French/Spanish/German/Italian/Dutch/
Finnish/Portuguese/Norwegian/Swedish/Danish/
Slovene/Czech/Hungarian/Russian

Applicable Standards

- Electrical Safety: CE*, GS**
- Radiation: CISPR Pub 22 Class B
- Other: PTT, Energy Star compliant, CE Marking

ADF Capacity

→ p. 4-2

Multi-Purpose Tray Capacity

→ p. 5-2

Printable Area

→ p. 5-3

Scanned Area

→ p. 4-2

Facsimile

Applicable Line

Public Switched Telephone Network (PSTN)

Compatibility

G3

Data Compressing System

MH, MR, MMR

Modem Type

Fax modem

Modem Speed

33600/31200/28800/26400/24000/21600/19200/
16800/14400/12000/9600/7200/4800/2400 bps
Automatic fallback

Transmission Speed

Approx. 3 seconds/page*** at 33.6 Kbps, ECM-MMR,
transmitting from memory

Scanning Image Processing

- Ultra High Quality (UHQ™) image enhancement
- Halftones: 64 levels of grey
- Density adjustment 3 levels

Transmission/Reception Memory

FAX-L295: Approx. 448 pages***
FAX-L220: Approx. 350 pages***

Fax Scanning Speed

Approx. 7.7 seconds/page***

* This standard is applicable for Europe only.

** This standard is not applicable for Australia.

*** Based on Canon FAX Standard Chart No. 1, standard mode.

Fax Resolution

- FAX STANDARD: 8 pels/mm × 3.85 lines/mm
- FAX FINE: 8 pels/mm × 7.7 lines/mm
- FAX PHOTO: 8 pels/mm × 7.7 lines/mm with halftones
- SUPER FINE: 8 pels/mm × 15.4 lines/mm

Dialling

- Automatic dialling
- One-touch speed dialling (15 destinations)
- Coded speed dialling (100 destinations)
- Group dialling (Max. 114 destinations)
- Regular dialling (with numeric buttons)
- Automatic redialling
- Manual redialling
- Pause button
- Redial button

Networking

- Sequential broadcasting (Max. 116 destinations)
- Automatic reception
- Automatic Fax/Tel switchover
- Delayed transmission (Max. 116 destinations)
- Polling transmission
- Polling reception
- Remote reception by telephone (Default ID: 25)
- Non-ring reception
- ECM deactivation
- Network switch*
- ACTIVITY REPORT (after every 20 transactions)
- Non-delivery report
- TTI (Transmit Terminal Identification)

Copier**Scanning Resolution**

- Direct Copy: 400 × 300 dpi
- Memory Copy: 200 × 300 dpi

Printing Resolution

600 × 600 dpi

Reduction

70%, 80%, 90%

Copy Speed

Approx. 6 pages/minute

No. of Copies

Max. 99 copies

Telephone**Connection**

- Optional handset/telephone*
- Additional telephone/answering machine (CNG detecting signal)/data modem

Printer**Printing Method**

Laser beam printing

Paper Handling

Automatic feed

Paper Size and Weight

→ p. 5-2

Recommended Paper

→ p. 5-3

Print Speed**

Approx. 6 pages/minute

Print Width

Max. 206 mm

Resolution

600 × 600 dpi

Printing Cartridge

FX-3 toner cartridge

Toner Saver

Approx. 30% to 40% reduction in toner consumption

* This feature is available for certain countries only.

** Based on Canon FAX Standard Chart No. 1, standard mode.

Appendix B

FAX-L295 Instructions

❑ Introduction.....	B-2
❑ Differences Between the FAX-L295 and FAX-L220.....	B-2
❑ Using Your Documentation	B-2
❑ Unpacking the FAX-L295	B-2
❑ Connecting the FAX-L295 to Your PC	B-3
❑ Print Media Requirements	B-4
• Printable Area	B-4
❑ Selecting Print Media.....	B-5
❑ Loading Envelopes.....	B-5
❑ Loading Transparencies	B-7

Introduction

This Appendix provides information relevant only to purchasers of the FAX-L295 model. Please be sure to read this section before reading the rest of this guide.

Differences Between the FAX-L295 and FAX-L220

In addition to the FAX-L220 features, the FAX-L295 also has the following features:

- Connectivity to your PC for printing
- Increased memory for storing up to 448 fax pages*
- Support of a wider range of print media

Using Your Documentation

Your FAX-L295 includes the following documentation:

- **This guide:** Provides detailed information on how to set up, operate, maintain, and troubleshoot your FAX.
- **Printer Driver Guide:** This guide, included in the CD-ROM, describes how to use your FAX to print from within your PC's Windows® environment.

Unpacking the FAX-L295

Unpack your FAX as described on page 2-2. The items included are exactly the same as for the FAX-L220, except that your unit also includes the software necessary for connecting it to your PC.

Check that you have all items. If any are damaged or missing, notify your local authorised Canon dealer or the Canon help line immediately.



In addition to the items shipped with your FAX, you will need to purchase a printer cable to connect your FAX to a PC (→ p. B-3).

* Based on Canon FAX Standard Chart No. 1, standard mode.

Connecting the FAX-L295 to Your PC

To connect your FAX to a PC, you will need to purchase a printer cable that matches the interface connector on your PC:

- A USB cable no longer than 5 metres

You can purchase the cable from your local authorised Canon dealer.

Follow this procedure to connect the USB cable:

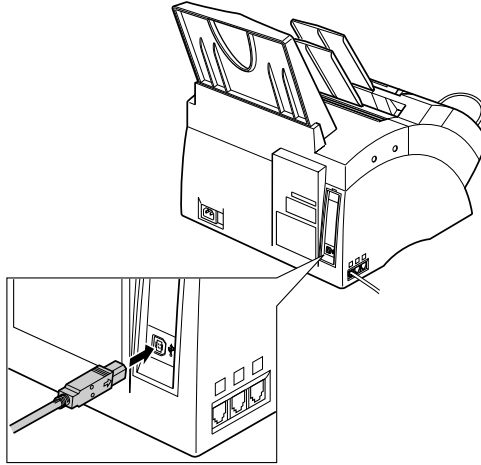

Connect the USB cable to the FAX and PC during software installation to ensure proper operation of the printer driver (→ *Printer Driver Guide*).



Make sure your PC is running Microsoft Windows[®] 98/Me or Windows[®] 2000/XP, preinstalled by a computer manufacturer on purchase. (The USB port operation also needs to be assured by the manufacturer.)

Print Media Requirements

In addition to the paper listed in Chapter 5, you can also load the following print media in the multi-purpose tray:

Print Media	Size	Quantity
Envelopes	European DL (220 × 110 mm/ 8.66 × 4.33 in.)	7 envelopes
	U.S. Commercial No. 10 (241.3 × 104.1 mm/ 9.5 × 4.1 in.)	7 envelopes
Transparencies	A4, Letter	1 sheet

Please refer to Chapter 5 for full details on paper handling, loading paper, and selecting paper delivery.

Printable Area

The shaded area shows the printable area of European DL-size envelopes.



For the printable area of paper, see Chapter 5.

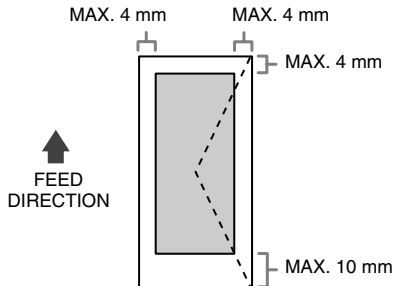

Selecting Print Media

Follow these guidelines when selecting envelopes and transparencies:



For paper guidelines, see Chapter 5.

■ Envelopes

- Use standard envelopes with diagonal seams and flaps.
- To prevent jams in the multi-purpose tray, do not use the following:
 - Envelopes with windows, holes, perforations, cutouts, and double flaps
 - Envelopes made with special coated paper or deeply embossed paper
 - Envelopes with peel-off sealing strips
 - Envelopes with letters enclosed
- You may be able to load other size envelopes than those listed on the previous page. However, Canon cannot guarantee consistent performance on these.



When printing on envelopes, be sure to use face-up delivery (→ p. 5-4).

■ Transparencies

- Use only special laser printer transparencies.



- When printing on transparencies, be sure to use face-up delivery (→ p. 5-4).
- To prevent the transparency from curling, remove it as soon as it exits the FAX and place it on a flat surface to cool.

Loading Envelopes

Follow this procedure to load up to 7 envelopes in the multi-purpose tray:

1 Prepare the envelopes.

- ❑ Arrange the stack of envelopes on a firm, clean surface, and press down firmly on the edges to make the folds crisp.
 - Press all the way around the envelopes to remove any curls and expel air from inside the envelopes. Also, press firmly on the area that corresponds to the edges of the back flap.

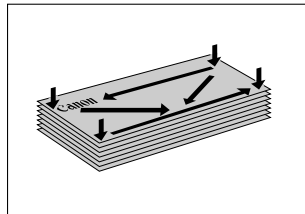

- ❑ Remove any curling from the envelopes by holding the edges diagonally and bending them gently.

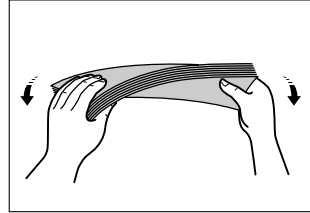

- ❑ Run a pen or other rounded object along the back flaps to flatten them.
 - The flaps should not bulge more than 5 mm.

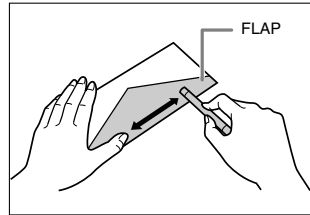

- 2 Remove the multi-purpose tray cover from the FAX.

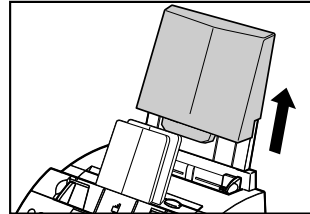

- 3 Insert the stack into the multi-purpose tray ① (print side facing you), then adjust the paper guides to the width of the stack ②.

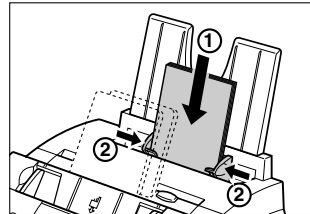

- 4 Replace the multi-purpose tray cover.
 - Be sure to replace this cover to prevent dust accumulating inside the unit.
- 5 Adjust the paper delivery selector to  (face-up delivery). For details, see p. 5-4.

The FAX is now ready to print.

Loading Transparencies

Load transparencies in the multi-purpose tray as for paper. For details, see p. 2-15.

Appendix C

Options

- Optional Handset..... C-2
 - Package Contents..... C-2
 - Attaching the Handset to Your FAX C-3
 - Maintaining Your Handset C-4

Optional Handset*

An optional handset is available in certain countries for connection to your FAX. Contact your local authorised Canon dealer for more information on purchasing this option.



Please note that the shape of your handset may differ from the one shown in this section. However, both handsets have exactly the same functions and performance.

Package Contents

Make sure your handset package includes the following items:

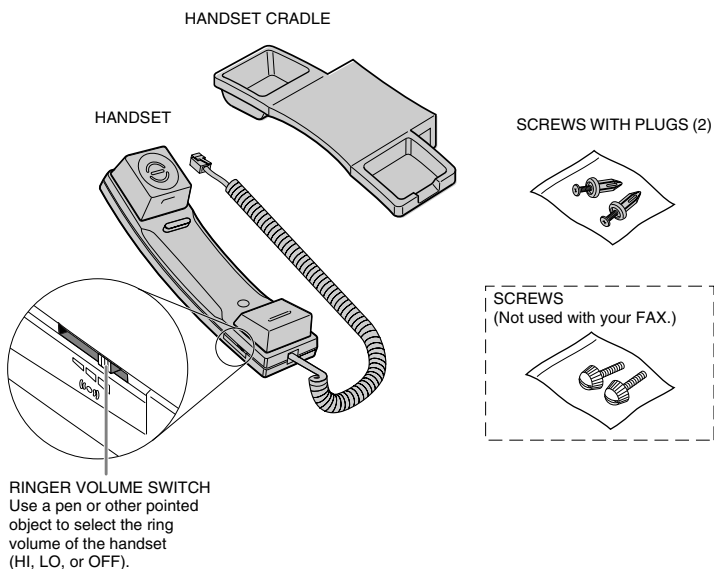

If any items are damaged or missing, notify your local authorised Canon dealer or the Canon help line immediately.

* The optional handset is available for certain countries only.

Attaching the Handset to Your FAX

Follow this procedure to attach the handset to your FAX:

- 1 Use a screwdriver to remove the two covers on the left side of the unit.

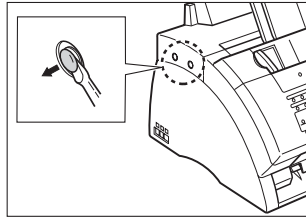

- 2 Remove the screws from the plugs and insert the plugs into the holes on the handset cradle.

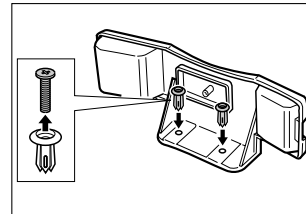

- 3 Insert the plugs (with the handset cradle) into the holes on the unit.
 - If you have difficulty inserting the plugs, turn the unit so that the left side is facing you and the right side is against a wall. You can now insert the plugs without the unit moving.

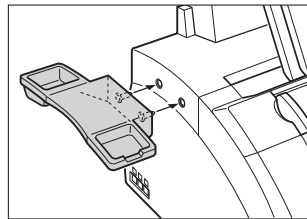

- 4 Use your finger to push the screws into the plugs.
 - If you have *difficulty*, use a cross-point screwdriver to *push* the screws all the way into the plugs. (Do not screw them in as the screws may break.)
 - Make sure you support the unit when inserting the screws.

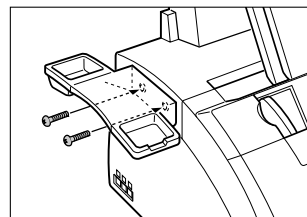

- 5 Place the handset in its cradle and connect the handset cord to the  jack.

Maintaining Your Handset

To maintain your handset in top working condition, be sure to follow these guidelines:

- Do not leave your handset exposed to direct sunlight.
- Do not install your handset in hot or humid conditions.
- Do not spray aerosol polishes on your handset since they may enter the holes on your handset and cause damage.
- Use a damp cloth to clean your handset.

- ▼ button 2-11, 14-3
- ◀ button 2-11, 3-4
- ▶ button 2-11, 3-4
- ▲ button 2-11, 14-3
- (→ p. n-nn), definition 1-2
- 1-TOUCH SPD DIAL LIST 1
 - description 11-2
 - printing 6-17
 - sample 6-18
- 1-TOUCH SPD DIAL LIST 2
 - description 11-2
 - printing 6-17
 - sample 6-18
- A**
- A4 setting 5-2, 5-6, 14-8
- ACTIVITY REPORT
 - description 11-2
 - printing 11-3
 - sample 11-3
 - setting 14-5
- ADF 2-10
 - adding pages in 4-4
 - capacity 4-2
 - definition 1-2
 - jams in 13-2
- ALARM VOLUME setting 14-4
- ANS.MACHINE MODE
 - description 8-2
 - setting 8-9
- Answering machine
 - connecting 2-5, 2-6
 - using with FAX 8-9
- Area
 - printable 5-3
 - scanned of document 4-2
- Assembling, FAX 2-4
- AUTO REDIAL
 - message 13-8
 - setting 7-10, 14-6
- Automatic Document Feeder. *See* ADF
- Automatic redialling
 - cancelling 7-9, 7-10
 - definition 7-9
 - setting options for 7-10, 7-11

B

- Broadcasting, sequential 7-12, 7-13
- BUSY/NO SIGNAL message 13-8

C

- C (Clear) button 2-11, 3-4
- CALLING VOLUME setting 14-4
- Cancelling
 - polling receiving 9-11
 - receiving 8-11
 - redialling 7-9, 7-10
 - restriction of your FAX 9-17, 9-18
 - sending 7-8

- Cartridge. *See* Toner cartridge

- CHANGE CARTRIDGE message 12-6, 13-8
- CHANGE DATA setting 9-15, 14-9
- CHECK COVER message 13-9
- CHECK DOCUMENT message 13-2, 13-9
- CHECK PAPER SIZE message 13-9
- CHECK POLLING ID message 13-9
- CHECK PRINTER message 13-9
- CHK SUBADDR/PSWD message 13-10

Cleaning

- FAX's exterior 12-2
- FAX's interior 12-3, 12-4
- scanner components 12-4, 12-5
- CLEAR PAPER JAM message 13-3, 13-10
- Coded Dial button 2-11, 6-2, 6-14
- CODED SPEED DIAL LIST 1

- description 11-2
- printing 6-17
- sample 6-19

CODED SPEED DIAL LIST 2

- description 11-2
- printing 6-17
- sample 6-19
- Coded speed dialling 6-2, 7-4
 - making telephone call with 6-15
 - registering 6-7 to 6-10
 - sending with 6-14

- Components, FAX 2-10, 2-11. *See also individual component names*

Connecting

- answering machine 2-5, 2-6
- data modem 2-5, 2-6
- external device 2-5, 2-6
- handset 2-5
- power cord 2-7
- telephone 2-5, 2-6
- telephone line cord 2-5

- Contrast 7-3
- Conventions, type 1-2, 1-3
- Copying 10-2, 10-3
 - document requirements 4-2
 - problems 13-17
 - quick 10-3
- Cord
 - answering machine 2-5, 2-6
 - data modem 2-5, 2-6
 - power 2-2, 2-7
 - telephone 2-5, 2-6
 - telephone line 2-2, 2-7
- Correcting mistake 3-4
- COUNTRY SELECT setting 2-8, 14-11
- Cover
 - front 2-10
 - multi-purpose tray 2-2, 2-4, 2-10
- CUSTOM setting 5-6, 14-8
- CUSTOM1/LONG setting 5-2, 5-7
- CUSTOM2/SHORT setting 5-2, 5-7
- Customer support 1-3

D

- Data
 - modem, connecting 2-5, 2-6
 - Registration button 2-11, 14-3
- Date, entering 3-6
- DATE & TIME setting 3-6, 14-4
- DATE SETUP setting 14-10
- Default, definition 1-2
- DEFAULT ACTION setting 8-5, 8-6
- Delayed sending
 - deleting document set for 7-17
 - printing document set for 7-16
 - scanning a document into memory for 7-14, 7-15
 - Transmission button 2-11, 7-14, 7-16, 7-17
- DELETE FILE setting 9-15, 14-9
- Deleting
 - document in memory 9-8
 - document set for delayed sending 7-17
 - polling box settings 9-14, 9-15
- Delivery, paper. *See* Paper delivery
- Destination labels 2-2, 6-6, 6-13
- Dialling
 - coded speed dialling. *See* Coded speed dialling
 - methods 7-4
 - regular 7-4
 - special 9-2, 9-3
 - switching temporarily to tone 9-3
 - through switchboard 3-9, 3-10
- Directory 6-16
- DISPLAY LANGUAGE setting 2-8, 14-10
- DOC. MEMORY LIST
 - description 11-2
 - printing 9-4
 - sample 9-4
 - setting 9-4

- DOC. TOO LONG message 13-10
- Document
 - adding pages in ADF 4-4
 - definition 1-2
 - guide 2-10
 - loading 4-3, 4-4
 - problem 4-2
 - problems with multipage 4-3
 - quantity 4-2
 - requirements 4-2
 - scanned area 4-2
 - size 4-2
 - support 2-2, 2-4, 2-10
 - thickness 4-2
 - weight 4-2
- Documentation 2-2

E

- ECM, definition 1-2
- ECM RX
 - message 13-10
 - setting 14-7
- ECM TX
 - message 13-10
 - setting 14-6
- ECONOMY PRT setting 5-8, 14-8
- ERASE AFTER TX setting 9-13, 14-9
- ERROR TX REPORT, sample 11-4
- Ex., definition 1-2
- External device
 - connecting 2-5, 2-6

F

- F/T RING TIME setting 8-5, 8-6, 14-7
- Face-down delivery 5-4, 5-5
 - slot 2-10, 5-4
- Face-up delivery 5-4, 5-5
 - slot 2-10, 5-4
- Fax, definition 1-2
- FAX 2-2
 - assembling 2-4
 - cleaning 12-2 to 12-5
 - clearing jams 13-2 to 13-7
 - components 2-10, 2-11. *See also individual component names*
 - connecting 2-5 to 2-7
 - name, registering 3-6, 3-7
 - number, registering 3-6, 3-7
 - restricting use 9-16 to 9-18
 - testing 2-16
 - unpacking 2-2, 2-3
- FAX ONLY MODE
 - description 8-2
 - setting 8-2, 8-3, 14-7
- FAX/TEL AUTO SW setting 8-4, 14-7

Fax/Tel Mode
description 8-2
setting 8-4
setting options for 8-5, 8-6
FaxAbility. *See* Telecom FaxAbility
FaxStream™ Duet. *See* Telstra FaxStream™ Duet
FILE NAME setting 9-12, 14-9
Fixing assembly 2-10
Front cover 2-10
Function Button 2-11, 3-6
FX-3. *See* Toner cartridge

G

G3, definition 1-2
GROUP DIAL LIST
description 11-2
printing 6-17
sample 6-20
Group dialling 6-2, 7-4
registering 6-11 to 6-13
sending with 6-14
Guide
document 2-10
paper 2-10

H

Handling, safety instructions 1-4, 1-5
Handset
connecting 2-5
sending manually via 7-6, 7-7
Hook Button 2-11, 6-15, 7-6, 9-3
HOOKING setting 3-9, 3-10
HORIZ & VERTICAL setting 14-8

I

INCOMING RING setting 14-7
INSIDE IMAGE setting 14-4
Installing, toner cartridge 2-12 to 2-14
ITU-TS, definition 1-2

J

Jack 2-5, 2-6
Jams
clearing 13-2 to 13-7
in ADF 13-2
in paper delivery slots 13-3
inside unit 13-3 to 13-7
paper 13-3 to 13-7

K

KEEP PRINTING setting 14-8
KEYPAD VOLUME setting 14-4

L

Label
destination 2-2, 6-6, 6-13
paper loading warning 2-2, 2-4

Latch 2-10
LCD 2-11
definition 1-2
messages 13-8 to 13-12. *See also individual message names*
Letter mode
lowercase 3-2, 3-3
uppercase 3-2, 3-3
Letters, entering 3-2, 3-3
Lever, paper release 2-10, 13-4
LGL setting 5-2, 5-6, 14-8
LINE MONITOR VOL setting 14-4
Lists. *See also individual list names*
summary 11-2
LOAD PAPER message 13-10
Loading
document 4-3, 4-4
paper 2-15, 2-16
Location, safety instructions 1-5, 1-6
LOCK PHONE setting 9-16, 9-17, 14-10
Lowercase letter mode 3-2, 3-3
LTR setting 5-2, 5-6, 14-8

M

Maintenance, safety instructions 1-4, 1-5
MAN/AUTO SWITCH setting 14-7
MANUAL MODE
description 8-2
setting 8-7, 8-8
Manual redialling 7-9
cancelling 7-9
Manual sending via the handset 7-6, 7-7
cancelling 7-8
Manual setting. *See* MANUAL MODE
Memory
deleting document in 9-8
documents in 9-4 to 9-8
printing document in 9-5
printing list of documents in 9-4
receiving when problem occurs 8-10
Reference button 2-11, 9-4, 9-5, 9-6, 9-8
scanning a document for delayed sending into 7-14, 7-15
sending. *See* Memory sending
sending document in 9-6, 9-7
MEMORY CLEAR REPORT 13-22
description 11-2
sample 13-22
MEMORY FULL message 13-10
MEMORY RX setting 14-7
Memory sending 7-5, 7-6
cancelling 7-8
MEMORY USED nn% message 13-11
Menu. *See also individual menu names*
accessing 14-3
definition 1-2
system, understanding 14-2, 14-3

Messages. *See* LCD messages
MID PAUSE SET setting 14-6
Mistake, correcting 3-4
MULTI TX/RX (Transaction) REPORT 11-5
 description 11-2
 sample 11-5
MULTI TX/RX REPORT. *See* MULTI TX/RX
 (Transaction) REPORT
Multi-purpose tray 2-10
 capacity 5-2
 cover 2-2, 2-4, 2-10

N

NO RX PAPER message 13-11
NO TEL # message 13-11
NOT AVAILABLE message 13-11
Number
 entering 3-2, 3-3, 3-4
 mode 3-2, 3-3, 3-4
Numeric buttons 2-11, 3-2

O

OFFHOOK ALARM setting 14-4
Ok button 2-11, 14-3
One-touch speed dialling 6-2, 7-4
 buttons 2-11, 6-2, 6-14
 making telephone call with 6-15
 registering 6-3 to 6-6
 sending with 6-14
Operation panel 2-10, 2-11
Optional handset. *See* Handset
OUTPUT NO setting 14-5
OUTPUT YES setting 14-5
OUTSIDE IMAGE setting 14-4

P

Paper
 delivery. *See* Paper delivery
 feeding problems 13-13
 guide 2-10
 jams 13-3 to 13-7
 loading 2-15 to 2-16
 loading warning label 2-2, 2-4
 path 5-4
 printable area 5-3
 quantity 5-2
 release lever 2-10, 13-4
 requirements 5-2, 5-3
 rest 2-2, 2-4, 2-10
 selecting 5-3
 size setting 5-2, 5-6, 5-7
 weight 5-2

Paper delivery
 face-down 5-4, 5-5
 face-up 5-4, 5-5
 selecting 5-4, 5-5
 selector 2-10, 5-5
 slot, jams in 13-3
PAPER SIZE setting 5-6, 14-8
Password
 for polling box, setting 9-11 to 9-13
 for polling receiving 9-9
 registering for coded speed dialling 6-7 to 6-10
 registering for one-touch speed dialling 6-3 to 6-6
PASSWORD setting 9-12, 9-16, 9-17, 14-9, 14-10
Pause, entering 9-2
PBX
 definition 3-9
 setting 3-9, 14-4
Polling
 another fax machine 9-9, 9-10
 box. *See* Polling box
 button 2-11, 9-10, 9-14
 definition 9-9
 receiving. *See* Polling receiving
 sending. *See* Polling sending
Polling box
 changing settings 9-14, 9-15
 deleting settings 9-14, 9-15
 scanning document into 9-14
 setting up 9-11 to 9-13
POLLING BOX
 menu 14-3, 14-9
 setting 9-11 to 9-15
Polling receiving
 cancelling 9-11
 polling another fax machine 9-9, 9-10
Polling sending
 changing polling box settings 9-14, 9-15
 deleting polling box settings 9-14, 9-15
 scanning document into polling box 9-14
 setting up polling box 9-11 to 9-13
Power
 cord 2-2, 2-7
 cut 13-22
 supply, safety instructions 1-6
 switch 2-7
PREFIX setting 3-9, 3-10
PRINT ERROR ONLY setting 14-5
PRINT WITH IMAGE setting 14-5
PRINTER SETTINGS menu 14-3, 14-8
Printing
 area 5-3
 document in memory 9-5
 document set for delayed sending 7-16
 lists. *See individual list names*
 problems 13-18, 13-19
 reports. *See individual report names*

Problems

- cannot solve 13-21
- copying 13-17
- document 4-2
- general 13-20
- multipage document 4-3
- paper feeding 13-13
- printing 13-18, 13-19
- receiving 13-15 to 13-17
- receiving into memory when 8-10
- sending 13-13 to 13-15
- telephone 13-18

PSTN setting 3-9, 14-4

PSWD POLL REJECT message 13-11

PSWD TX REJECTED message 13-11

Pulse dialling

- setting for 3-8
- switching temporarily to tone dialling 9-3

Q

Quantity

- document 4-2
- paper 5-2

R

R button 2-11

- registering 3-9, 3-10

REC'D IN MEMORY message 8-10, 13-12

Receive Mode button 2-11

Receiving. *See also individual receive modes*

- cancelling 8-11
- in memory when problem occurs 8-10
- methods 8-2
- polling. *See* Polling receiving
- problems 13-15 to 13-17
- remote, definition 8-7
- restricting 9-19
- while performing other tasks 8-10

Reception report. *See* RX (Reception) REPORT

REDIAL INTERVAL setting 7-11, 14-6

REDIAL TIMES setting 7-11, 14-6

Redial/Pause button 2-11, 7-9, 9-2

Redialling 7-9 to 7-11

Remote reception, definition 8-7

REMOTE RX ID setting 14-7

REMOTE RX setting 14-7

Replacing

- toner cartridge 12-6 to 12-8

Report button 2-11, 6-17, 11-3, 14-2

REPORT SETTINGS menu 14-3, 14-5

Reports. *See also individual report names*

- summary 11-2

Resolution

- button 2-11, 7-2, 10-2
- copying, setting 10-2
- sending, setting 7-2

Rest, paper 2-2, 2-4, 2-10

Restricting

- reception 9-19, 9-20
- use of FAX 9-16 to 9-18

RING COUNT setting 14-7

RING START TIME setting 8-5, 8-6

R-KEY SETTING 3-9, 14-4

Roller, transfer charging 2-10

ROTARY PULSE setting 3-8, 14-4

RX, definition 1-2

RX (Reception) REPORT 11-5

- description 11-2
- sample 11-5

RX (Reception) SETTINGS menu 14-3, 14-7

RX CALL LEVEL setting 14-4

RX MODE setting 8-3, 8-4, 14-7

RX PAGE FOOTER setting 14-7

RX REDUCTION setting 14-8

RX REPORT. *See also* RX (Reception) REPORT setting 14-5

RX RESTRICTION setting 9-19, 14-10

RX SETTINGS menu. *See* RX (Reception) SETTINGS menu

RX START SPEED setting 14-10

RX TO MEMORY setting 14-8

S

Safety instructions 1-4 to 1-6

Saving, toner consumption 5-8

SCAN CONTRAST setting 7-3, 14-4

Scanner components, cleaning 12-4, 12-5

Scanning

- contrast, copying 7-3
- contrast, sending 7-3
- document area 4-2
- document for delayed sending into memory 7-14, 7-15
- resolution, copying 10-2
- resolution, sending 7-2

SELECT POL REJECT message 13-12

Selector, paper delivery 2-10, 5-5

Sender information

- definition 3-5
- registering 3-5 to 3-7
- sample 3-5

Sending

- at preset time. *See* Delayed sending
 - cancelling 7-8
 - delayed. *See* Delayed sending
 - document in memory 9-6, 9-7
 - document requirements 4-2
 - manual via the handset 7-6, 7-7
 - memory 7-5, 7-6
 - methods 7-5 to 7-7
 - polling. *See* Polling sending
 - problems 13-13 to 13-15
 - same document to several fax numbers 7-12, 7-13
 - timer. *See* Delayed sending
 - with coded speed dialling 6-14
 - with group dialling 6-14
 - with one-touch speed dialling 6-14
 - with speed dialling 6-14
- Sequential broadcasting 7-12, 7-13
- Serial number, FAX 13-21
- Settings. *See also individual setting names*
printing list of 14-2
- SETUP FILE setting 9-12, 14-9
- Shipping materials, removing 2-4
- Size
- document 4-2
 - paper 5-2, 5-6, 5-7
- Space button 2-11, 3-3, 3-4
- Special function buttons 2-11. *See also individual button names*
- Speed dialling. *See also individual speed dialling methods*
definition 6-2
- lists. *See* Speed dialling lists
 - making telephone call with 6-15
 - methods 6-2
 - sending document with 6-14
 - using 6-14, 6-15
- Speed dialling lists. *See also individual list names*
printing 6-17 to 6-20
- samples 6-18 to 6-20
- Start/Copy button 2-11, 10-2, 10-3
- Stop button 2-11, 14-3
- SUBADD TX REJECT message 13-12
- Subaddress
- for polling receiving 9-9
 - registering for coded speed dialling 6-7 to 6-10
 - registering for one-touch speed dialling 6-3 to 6-6
- SUMMER TIME setting 3-11, 14-11
- Support
- customer 1-3
 - document 2-2, 2-4, 2-10
 - tray 2-2, 2-4, 2-10
- Switchboard, dialling through 3-9, 3-10
- Symbols, entering 3-2, 3-4
- SYSTEM SETTINGS menu 14-3, 14-10

T

- T(✕) button 9-3
- TEL LINE TYPE setting 3-8, 14-4
- Telephone
- connecting 2-5, 2-6
 - making call with speed dialling 6-15
 - problems 13-18
- TELEPHONE # MARK setting 14-4
- Telephone line
- cord 2-2, 2-5
 - type, setting 3-8
- Testing FAX 2-16
- Thickness, document 4-2
- Time
- entering 3-6
 - sending at preset. *See* Delayed sending
- TIME OUT setting 14-6
- Timer sending. *See* Delayed sending
- Tone dialling
- setting for 3-8
 - switching temporarily to 9-3
- Toner cartridge 2-2
- compartment 2-10
 - installing 2-12 to 2-14
 - replacing 12-6 to 12-8
- Toner saver setting 5-8
- TONER SUPPLY LOW setting 14-8
- TOUCH TONE setting 3-8, 14-4
- Transfer charging roller 2-10
- Transmission report. *See* TX (Transmission) REPORT
- Tray
- multi-purpose 2-10
 - multi-purpose, cover 2-2, 2-4, 2-10
 - support 2-2, 2-4, 2-10
- TTI POSITION setting 14-4
- TX, definition 1-2
- TX (Transmission) REPORT 11-4
- description 11-2
 - sample 11-4
- TX (Transmission) SETTINGS menu 14-3, 14-6
- TX PASSWORD setting 9-12, 14-9
- TX REPORT. *See also* TX (Transmission) REPORT
setting 14-5
- TX SETTINGS menu. *See* TX (Transmission) SETTINGS
menu
- TX START SPEED setting 14-10
- TX TERMINAL ID setting 14-4
- TX/RX CANCELLED message 13-12
- TX/RX NO., definition 1-2
- TX/RX NO. nnnn message 13-12
- TX/RX NO. nnnn, SCANNING P.nnn, MEMORY FULL
message 13-12
- Type conventions 1-2, 1-3

U

UN/LOCK PHONE setting 9-16, 9-17, 14-10

UNIT NAME setting 3-7, 14-4

UNIT TELEPHONE # setting 3-7, 14-4

Unpacking FAX 2-2, 2-3

Uppercase letter mode 3-2, 3-3

USER SETTINGS menu 14-3, 14-4

USER'S DATA LIST

description 11-2

printing 14-2

sample 14-2

User's Guide, type conventions 1-2, 1-3

V

VERTICAL ONLY setting 14-8

Volume

ALARM VOLUME setting 14-4

CALLING VOLUME setting 14-4

KEYPAD VOLUME setting 14-4

LINE MONITOR VOL setting 14-4

VOLUME CONTROL setting 14-4

W

Weight

document 4-2

paper 5-2

unit 1-5

Free Manuals Download Website

<http://myh66.com>

<http://usermanuals.us>

<http://www.somanuals.com>

<http://www.4manuals.cc>

<http://www.manual-lib.com>

<http://www.404manual.com>

<http://www.luxmanual.com>

<http://aubethermostatmanual.com>

Golf course search by state

<http://golfingnear.com>

Email search by domain

<http://emailbydomain.com>

Auto manuals search

<http://auto.somanuals.com>

TV manuals search

<http://tv.somanuals.com>