

# Canon

# FAX-L380S/L390

## User's Guide



**SUPER**  
**GB**

Please read this guide before operating this equipment.  
After you finish reading this guide, store it in a safe place  
for future reference.

Download from [www.Somanuals.com](http://www.Somanuals.com). All Manuals Search And Download.

ENG

# FAX-L380S/L390 User's Guide



## About the Manuals for the Machine

The manuals for this machine are divided as follows. Please refer to them for detailed information.  
The manuals supplied with optional equipment are included in the list below.



Guides with this symbol are book manuals.



Guides with this symbol are PDF manuals included on the accompanying CD-ROM.

- **Setting up the Machine**
- **Installing CARPS**
- **Feature Overviews**
- **Maintenance and Troubleshooting**

**Starter Guide**



- **Setting up the Machine**
- **Document and Paper Handling**
- **Sending and Receiving Faxes**
- **Speed Dialling**
- **Making Copies**
- **Maintenance**
- **Troubleshooting**
- **The Menu System**

**User's Guide  
(This Document)**



- **Installing CARPS Software**
- **Printer Properties**
- **Troubleshooting Printer Driver Issues**

**Software Guide**



• To view the manual in PDF format, Adobe Reader/Adobe Acrobat Reader is required. If Adobe Reader/Adobe Acrobat Reader is not installed on your system, please download it from the Adobe Systems Incorporated website.

• Considerable effort has been made to make sure that the manuals for the machine are free of inaccuracies and omissions. However, as we are constantly improving our products, please refer to the latest manuals for details.

## **IMPORTANT!**

**Appendix C describes important information exclusively for specified countries. If you find your country name in Appendix C, be sure to read it.**



This equipment conforms to the essential requirements of EC Directive 1999/5/EC.

We declare that this product conforms to the EMC requirements of EC Directive 1999/5/EC at nominal mains input 230 V, 50Hz although the rated input of the product is 200–240 V, 50/60Hz. This equipment has been tested in a typical system to comply with the technical requirements of EMC Directive. Use of shielded cable is required to comply with the technical requirements of EMC Directive.

If you move to another EU country and are experiencing trouble please call the Canon Help Desk.

(For Europe Only)

### **Model Name**

H12425 (FAX-L380S)

H12425 (FAX-L390)

## **Copyright**

Copyright © 2005 by Canon Inc. All rights reserved. No part of this publication may be reproduced, transmitted, transcribed, stored in a retrieval system, or translated into any language or computer language in any form or by any means, electronic, mechanical, magnetic, optical, chemical, manual, or otherwise, without the prior written permission of Canon Inc.

## Trademarks

Canon® is a registered trademark, and UHQ™ is a trademark of Canon Inc.

IBM® is a registered trademark.

Microsoft® and Windows® are registered trademarks of Microsoft Corporation.

Other brand and product names may be trademarks or registered trademarks of their respective companies.



As an ENERGY STAR® Partner, Canon has determined that this product meets the ENERGY STAR® guidelines for energy efficiency. The International ENERGY STAR® Office Equipment Program is an international program that promotes energy saving through the use of computers and other office equipment. The program backs the development and dissemination of products with functions that effectively reduce energy consumption. It is an open system in which business proprietors can participate voluntarily. The targeted products are office equipment such as computers, displays, printers, facsimiles, and copiers. Their standards and logos are uniform among participating nations.



Super G3 is a phrase used to describe the new generation of fax machines that use ITU-T V.34 standard 33.6Kbps\* modems. Super G3 High Speed Fax machines allow transmission time of approx. 3 seconds\* per page which results in reduced telephone line charges.

\* Approx. 3 seconds per page fax data transmission time based on Canon FAX Standard Chart No.1, (Standard Mode) at 33.6Kbps modem speed. The Public Switched Telephone Network (PSTN) currently supports 28.8Kbps modem speeds or lower, depending on telephone line conditions.

# Safety Information

## Laser Safety Information

Laser radiation could be hazardous to the human body. For this reason, laser radiation emitted inside this product is hermetically sealed within the protective housing and external cover. No radiation can leak from the product in the normal operation of the product by the user.

This product is classified as a Class 1 Laser Product under IEC 60825-1: 1993 and EN 60825-1: 1994.

### 200V-240V model

The label shown below is attached to the laser scan machine on the product.

	<b>DANGER</b> - Invisible laser radiation when open. AVOID DIRECT EXPOSURE TO BEAM.
	<b>CAUTION</b> - CLASS 3B, INVISIBLE LASER RADIATION WHEN OPEN. AVOID EXPOSURE TO THE BEAM.
<b>ATTENTION</b> - RAYONNEMENT LASER INVISIBLE DE CLASSE 3B. EN CAS D'OUVERTURE ÉVITEZ L'EXPOSITION AU FAISCEAU.	
<b>VORSICHT</b> - UNSICHTBARE LASERSTRAHLUNG KLASSE 3B. WENN ABDECKUNG GEÖFFNET, NICHT DEM STRAHL AUSSETZEN.	
<b>PRECAUCIÓN</b> - RADIACIÓN LÁSER INVISIBLE DE CLASE 3B PRESENTE AL ABRIR. EVITE LA EXPOSICIÓN AL HAZ.	
<b>VARNING</b> - KLAS 3B OSYNLIG LASERSTRÅLNING NÄR DENNA DEL ÄR ÖPPNAD. STRÅLEN ÄR FARLIG.	
<b>VAROITUS</b> - LUOKAN 3B NÄKYMÄTTÖMÄLLE LASER-SÄTELYÄ AVATTUNA. VÄLTÄ ALTISTUMISTA SÄTEELLE.	
<b>주의</b> - 엘리펀 등급 3B 비가시 레이저 방사선이 방출됩니다. 광선에 노출을 피하십시오.	
<b>注意</b> - ここを開くとクラス3B不可視レーザー放射が出ます。 ビームに身をさらさないこと。	

RU5-8126

This product has been classified under IEC 60825-1: 1993 and EN60825-1: 1994, and conforms to the following classes:

CLASS 1 LASER PRODUCT  
LASER KLASSE 1  
APPAREIL A RAYONNEMENT LASER DE  
CLASSE 1  
APPARECCHIO LASER DI CLASSE 1  
PRODUCTO LASER DE CLASE 1  
APARELHO A LASER DE CLASSE 1

PERFORMANCE OF PROCEDURES OTHER THAN  
THOSE SPECIFIED IN THIS GUIDE MAY RESULT IN  
HAZARDOUS RADIATION EXPOSURE.



# Contents

## Chapter 1

### Introducing FAX-L380S/L390

---

<b>Welcome</b> .....	1-1
<b>The Main Features of the Machine</b> .....	1-2
Plain Paper Fax Features .....	1-2
Printer Features .....	1-3
Copier Features .....	1-3
Telephone Features* .....	1-3
<b>Using the Machine With the Printer Driver</b> .....	1-4
System Requirements .....	1-4
<b>Using Your Documentation</b> .....	1-5
Type Conventions Used in This Guide .....	1-5
Illustrations Used in This Guide .....	1-5
<b>Safety Instructions</b> .....	1-6
Customer Support .....	1-7

## Chapter 2

### Setting Up Your Machine

---

<b>Choosing a Location for Your Machine</b> .....	2-1
<b>Unpacking Your Machine</b> .....	2-2
Do You Have Everything? .....	2-2
Removing Shipping Materials .....	2-3
Replaceable Parts .....	2-4
<b>Assembling the Machine</b> .....	2-5
Attaching Components .....	2-5
Document Output Tray .....	2-5
Output Tray .....	2-5
Installing the Paper Cassette* .....	2-6
<b>Making Connections</b> .....	2-7
Connecting the Machine to Your PC .....	2-7
Connecting the Telephone Line .....	2-8
Connecting the Power Cord .....	2-8
<b>Setting the Display Language and Country*</b> .....	2-10
<b>Getting Acquainted With Your Machine</b> .....	2-11
Front View .....	2-11
Rear View .....	2-13
The Operation Panel .....	2-14
Special Function Buttons (One-Touch Speed Dial Panel Open) .....	2-15
<b>Energy Saver Mode</b> .....	2-16
Setting the Energy Saver Mode Manually .....	2-16
Restoring from the Energy Saver Mode .....	2-16
<b>The Toner Cartridge</b> .....	2-17
Handling and Storing Cartridges .....	2-17
Installing/Replacing the Toner Cartridge .....	2-18
<b>Loading Recording Paper</b> .....	2-21
Loading Paper in the Cassette .....	2-22
Testing the Machine .....	2-23

## Chapter 3

## Registering Information in the Machine

---

<b>Guidelines for Entering Information</b> . . . . .	<b>3-1</b>
Entering Numbers, Letters, and Symbols . . . . .	3-1
<b>Personalizing Your Machine</b> . . . . .	<b>3-3</b>
Identifying Your Documents . . . . .	3-3
Entering the Date and Time . . . . .	3-3
Registering Your Fax Number and Name . . . . .	3-4
Setting the Telephone Line Type . . . . .	3-5
Setting the Summer Time* . . . . .	3-5

## Chapter 4

## Paper Handling

---

<b>Print Media Requirements</b> . . . . .	<b>4-1</b>
Printing Areas . . . . .	4-2
<b>Loading Paper</b> . . . . .	<b>4-3</b>
Loading Paper in the Cassette . . . . .	4-3
Loading Envelopes in the Cassette . . . . .	4-5
Loading Paper in the Multi-Purpose Feeder . . . . .	4-8
Loading an Envelope in the Multi-Purpose Feeder . . . . .	4-9
Orientation of the Document and the Paper Loading . . . . .	4-11
<b>Selecting the Paper Output Area</b> . . . . .	<b>4-12</b>
Paper Type and Paper Output Area . . . . .	4-12
Face Down Paper Output Area . . . . .	4-13
Face Up Paper Output Area . . . . .	4-13

## Chapter 5

## Speed Dialing

---

<b>Speed Dialing Methods</b> . . . . .	<b>5-1</b>
<b>One-Touch Speed Dialing</b> . . . . .	<b>5-2</b>
Storing Numbers for One-Touch Speed Dialing . . . . .	5-2
Changing or Deleting a Number/Name Stored Under a One-Touch Speed Dial Button . . . . .	5-3
Using One-Touch Speed Dialing . . . . .	5-4
<b>Coded Speed Dialing</b> . . . . .	<b>5-5</b>
Storing Numbers for Coded Speed Dialing . . . . .	5-5
Changing or Deleting a Number/Name Stored under a Coded Speed Dialing Code . . . . .	5-6
Using Coded Speed Dialing . . . . .	5-7
<b>Group Dialing</b> . . . . .	<b>5-9</b>
Creating Groups for Group Dialing . . . . .	5-9
Changing or Deleting a Number/Name Stored under a Group Dialing . . . . .	5-10
Using Group Dialing . . . . .	5-12
<b>Directory Dialing</b> . . . . .	<b>5-13</b>

## Chapter 6

## Sending Faxes

---

<b>Preparing to Send a Fax</b> . . . . .	<b>6-1</b>
Document Requirements . . . . .	6-1
Scanning Area . . . . .	6-2
Loading Documents in the ADF . . . . .	6-3
Adjusting the Resolution and Contrast . . . . .	6-4
Adjusting the Image Quality (Resolution) . . . . .	6-4
Adjusting the Exposure (Density) . . . . .	6-5
Sending Methods . . . . .	6-6
Memory Sending . . . . .	6-6
Manual Sending Via the Handset* . . . . .	6-6
Dialing Methods . . . . .	6-7
<b>Sending Documents</b> . . . . .	<b>6-8</b>
Memory Sending . . . . .	6-8
Manual Sending Via the Handset* . . . . .	6-9

<b>Canceling Sending</b> .....	<b>6-10</b>
Canceling Memory Sending .....	6-10
While Documents Are Being Scanned Using the ADF .....	6-10
After All Documents Are Scanned .....	6-10
<b>Redialing</b> .....	<b>6-11</b>
Manual Redialing .....	6-11
Automatic Redialing With Memory Sending .....	6-11
Canceling Automatic Redialing .....	6-11
Setting Up Automatic Redialing* .....	6-11
<b>Sequential Broadcasting</b> .....	<b>6-13</b>
Sending a Document to More Than One Destination .....	6-13
Sending a Document Using Group Dialing .....	6-14
<b>Delayed Sending</b> .....	<b>6-15</b>

## Chapter 7      **Receiving Faxes**

---

<b>Different Ways to Receive a Fax</b> .....	<b>7-1</b>
Setting the Receive Mode .....	7-2
Receiving Faxes and Phone Calls Automatically:	
FaxTel Mode .....	7-2
Setting the Options for FaxTel Mode .....	7-2
What Happens When FaxTel Mode is Selected .....	7-3
Receiving Faxes Manually: Manual Mode .....	7-4
Receiving Faxes Automatically: FaxOnly Mode .....	7-5
Using an Answering Machine: AnsMode .....	7-5
Using the Machine With an Answering Machine .....	7-5
<b>Receiving Faxes in Memory When a Problem Occurs</b> .....	<b>7-6</b>
Receiving While Performing Other Tasks .....	7-7
Canceling an Incoming Fax .....	7-7

## Chapter 8      **Setting Up and Using Polling**

---

<b>What's Polling?</b> .....	<b>8-1</b>
Before You Use Polling Receiving .....	8-1
<b>Polling Other Fax Machines to Receive Documents</b> .....	<b>8-2</b>
Requesting Another Fax to Send a Document .....	8-2
<b>Setting Up Polling Sending</b> .....	<b>8-3</b>
Setting Up a Polling Box .....	8-3
Scanning a Document into the Memory for Polling Sending .....	8-4
Changing the Polling Box Settings .....	8-5
Deleting a Polling Box .....	8-6

## Chapter 9      **Restricting the Use of the Machine**

---

<b>Setting and Using the System Administrator's ID and Password</b> .....	<b>9-1</b>
Setting the System Administrator's ID and Password .....	9-2
Changing/Canceling the System Administrator's ID and Password .....	9-2
<b>Restricting Machine Operation (Department ID Management)</b> .....	<b>9-4</b>
Setting Operation Restrictions .....	9-4
Turning Restrictions OFF or ON .....	9-7
Operating the Machine with Restrictions ON .....	9-8
Checking and Clearing the Counter Information .....	9-9

## Chapter 10     **Special Features**

---

<b>Special Dialing</b> .....	<b>10-1</b>
Dialing Through a Switchboard .....	10-1
Registering the Access Type and Outside Line Access Number Under the R button .....	10-1
Dialing Long Distance .....	10-2
How to Enter Pauses .....	10-2
Using Tone Dialing On a Pulse Line .....	10-3



<b>Restricting Use of the Machine</b> .....	<b>10-4</b>
Enabling Restriction of Your Machine .....	10-4
Canceling Restriction of Your Machine .....	10-5
<b>Using Memory Lock</b> .....	<b>10-6</b>
Turning Memory Lock ON and Setting the Password .....	10-6
Turning Memory Lock OFF and Printing Documents .....	10-7

---

## Chapter 11      Making Copies

<b>Making Copies</b> .....	<b>11-1</b>
<b>Specifying the Paper Size and Type (Common for Cassette and Multi-Purpose Feeder)</b> .....	<b>11-2</b>
Specifying the Paper Size .....	11-2
Specifying the Paper Type .....	11-3
<b>Setting Enlarging/Reducing</b> .....	<b>11-4</b>
Enlarging/Reducing Using Preset Copy Ratios .....	11-4
Enlarging/Reducing Using Custom Copy Ratios .....	11-5
<b>Improving Copied Image</b> .....	<b>11-6</b>
Adjusting the Image Quality (Resolution) .....	11-6
Adjusting the Exposure (Density) .....	11-6
Adjusting Automatically .....	11-6
Adjusting Manually .....	11-7
<b>Special Features</b> .....	<b>11-8</b>
Collate Copy .....	11-8
Reserve Copy .....	11-9
Confirming the Copy Job You Reserved .....	11-10
Deleting the Copy Job You Reserved .....	11-10

---

## Chapter 12      System Monitor

<b>Checking the Status of Copy, Fax, Print and Report Jobs</b> .....	<b>12-1</b>
Confirming Transmission Status .....	12-1
Confirming Transmission Results and Sending Reservation .....	12-2
Deleting a Fax Job .....	12-2
Confirming and Deleting a Copy Job .....	12-3
Confirming and Deleting a Print Job .....	12-3
Confirming and Deleting a Report Job .....	12-4

---

## Chapter 13      Reports and Lists

<b>Activity Report</b> .....	<b>13-1</b>
Department ID Report .....	13-2
<b>Transmission (TX) Reports</b> .....	<b>13-3</b>
Error TX Report .....	13-3
TX Report .....	13-4
Multi TX/RX Report .....	13-4
<b>Reception (RX) Report</b> .....	<b>13-5</b>
<b>Memory Clear Report</b> .....	<b>13-6</b>
<b>Speed Dialing Lists</b> .....	<b>13-7</b>
One-Touch Speed Dial List .....	13-8
Coded Speed Dial List .....	13-9
Group Dial List .....	13-10
<b>User's Data List</b> .....	<b>13-11</b>
<b>Department Information List</b> .....	<b>13-13</b>
<b>Document Memory List</b> .....	<b>13-14</b>
<b>Cancel Report Printing</b> .....	<b>13-15</b>

---

## Chapter 14      Troubleshooting

---

<b>Clearing Jams</b> .....	14-1
Removing Jammed Paper from Inside the Machine .....	14-1
Removing Jammed Paper from the ADF .....	14-7
<b>LCD Messages</b> .....	14-8
<b>Error Codes</b> .....	14-11
<b>Paper Feeding Problems</b> .....	14-12
<b>Faxing Problems</b> .....	14-15
Sending Problems .....	14-15
Receiving Problems .....	14-17
<b>Telephone Problems</b> .....	14-20
<b>Copying Problems</b> .....	14-21
<b>Print Quality Problems</b> .....	14-22
<b>Printing Problems</b> .....	14-24
<b>If You Cannot Solve the Problem</b> .....	14-25

---

## Chapter 15      Maintaining Your Machine

---

<b>Cleaning the Machine</b> .....	15-1
Cleaning the Machine's Exterior .....	15-2
Cleaning the ADF Area .....	15-2
<b>Transporting the machine</b> .....	15-5

---

## Chapter 16      The Menu System

---

<b>Accessing the Menu</b> .....	16-1
<b>Menu Descriptions</b> .....	16-2
1. PAPER SETTINGS .....	16-2
2. COMMON SETTINGS .....	16-3
3. COPY SETTINGS .....	16-5
4. FAX SETTINGS .....	16-6
5. ADD. REGISTRATION .....	16-14
6. PRINTER SETTINGS .....	16-14
7. TIMER SETTINGS .....	16-15
8. SYSTEM SETTINGS .....	16-16
9. PRINT LISTS .....	16-18

---

## Appendix A      Specifications

---

<b>General</b> .....	A-1
<b>Plain Paper Fax</b> .....	A-2
<b>Copier</b> .....	A-4
<b>Telephone</b> .....	A-4
<b>Printer</b> .....	A-5
Printable Area: Papers .....	A-6
Printable Area: Envelopes .....	A-7
<b>Document Sizes</b> .....	A-8
<b>Printer Driver</b> .....	A-9

---

## Appendix B      Attaching the Optional Handset to the Machine

---

<b>Handset</b> .....	B-1
Attaching the Handset to Your Machine .....	B-2
Adjusting the Ringer Volume Switch .....	B-4
Maintaining Your Handset .....	B-4

## Appendix C Country-Specific Features

---

<b>United Kingdom</b> .....	<b>C-1</b>
Connecting External Device .....	C-1
Ringer Equivalence Number (R.E.N.) .....	C-1
<b>Germany</b> .....	<b>C-2</b>
Applicable Standards .....	C-2
Connecting the Telephone Line Cord .....	C-2
Connecting a Telephone .....	C-3
Connecting an Answering Machine .....	C-3
Customer Support .....	C-3

## Glossary

---

## Index

---

# 1

## CHAPTER

# Introducing FAX-L380S/L390

This chapter introduces you to the main features of the machine. It also explains how to get the most out of the documentation that comes with the machine, and gives important safety instructions.

## Welcome

Thank you for purchasing the new Canon FAX-L380S/L390 models. We are sure that your machine will meet your printing and copying needs easily and conveniently, as well as your fax and phone requirements.

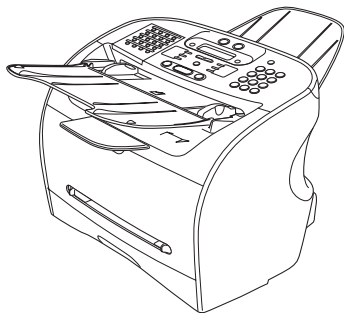

FAX-L380S



FAX-L390

# The Main Features of the Machine

The machine is a multifunction system for your home or small office, and combines a plain paper fax machine, a printer, a copier, and a telephone\* into a single, convenient desktop machine.

The machine's multitasking ability enables you to perform multiple operations simultaneously. For example, you can print a document or make copies at the same time you are sending a fax.

The compact size of the machine makes it ideal for desktop use, and allows you to use it in places where other machines may not fit.

## Plain Paper Fax Features

### ■ UHQ™ Image Processing System

The machine uses Canon's Ultra High Quality Image Processing System to provide enhanced definition in faxed photos.

### ■ Error Correction Mode (ECM)

The machine's Error Correction Mode (ECM) reduces transmission errors while communicating with another ECM-capable machine.

### ■ Automatic switching between fax and voice calls\*

The machine can automatically distinguish between fax and voice calls, so that you can receive both through a single phone line.

### ■ Answering machine connection

You can connect an answering machine to receive telephone messages while you are away.

### ■ Transmission speed

The machine uses G3 data encoding methods that increase transmission speed to approx. 3 seconds\*\* per page.

### ■ Memory sending/receiving

The machine can store up to 510\*\* fax pages of A4-size in its memory, and can receive faxes while printing.

### ■ Reduced-size printing

The machine automatically scales received faxes to fit the size of the paper loaded in the machine.

### ■ Automatic dialing and broadcasting

For easier faxing, the machine provides One-Touch Speed Dialing, Coded Speed Dialing, and Group Dialing methods for automatic dialing. It also allows you to broadcast or send a fax at a preset time to as many as 141 locations (210 locations for the FAX-L390 model).

\* With optional handset or other telephone connected. This feature is available for certain countries only.

\*\* Based on Canon FAX Standard Chart No.1, standard mode.

## Printer Features

### ■ Excellent print quality

The machine offers 1,200 dpi enhanced × 600 dpi laser beam printing, providing you with high resolution text and graphics.

### ■ Simple maintenance

The Cartridge T Starter and the regular Cartridge T for the machine contain both the toner and drum, making installation and replacement simple.

### ■ Economy toner-saving printing

The machine includes an economy printing mode which allows you to reduce toner consumption by approx. 30%.

## Copier Features

### ■ Up to 99 copies

The machine can make up to 99 copies of a document at a time, at a rate of up to 18 copies per minute.

### ■ Resolution

The machine scans documents at 300 × 300 dpi. Printing resolution is 1,200 dpi enhanced × 600 dpi.

### ■ Copy enlargement/reduction

The machine can reduce or enlarge copies in the range between 50% and 200% of their original size.

### ■ Collate copy

The machine can sort copies in page order. It is convenient when you make multiple copies of a multiple page document.

## Telephone Features\*

### ■ Automatic dialing

The machine's three automatic dialing methods (One-Touch Speed Dialing, Coded Speed Dialing, and Group Dialing) can be used to store phone and fax numbers for easy and efficient calling.

### ■ Connection for the optional handset, an answering machine, or a telephone

Connecting the optional handset or a telephone to the machine allows you to use it to make and receive normal telephone calls. In addition, connecting an answering machine allows you to receive faxes and phone messages while you are away from your desk.

\* This feature is available for certain countries only.

# Using the Machine With the Printer Driver

The printer driver that is included with your machine allows you to use the machine's printing function directly from your PC.

- Use the machine as the default printer for Windows applications
- For more information on using the printer driver with your machine, refer to the *Software Guide* also stored on the CD-ROM.

## System Requirements

The printer driver for Windows 98/Me/2000/XP can be used in the following system environments.

### ■ Operating System

Windows 98, Windows Me, Windows 2000, or Windows XP (x86 architecture).

### ■ Computer

Any computer on which Windows 98, Windows Me, Windows 2000, or Windows XP runs properly.

### ■ Hardware Environment

Using the CARPS software requires following computer environment:

- IBM or IBM-compatible PC
- CD-ROM drive or network environment with the access to the CD-ROM
- PC equipped with a USB port and the USB class driver installed

OS	CPU	RAM	Available free disk space
Windows 98	Intel Pentium® 90 MHz or greater	32 MB or greater**	115 MB or greater****
Windows Me	Intel Pentium® 150 MHz or greater	32 MB or greater**	115 MB or greater****
Windows 2000* Professional	Intel Pentium® 133 MHz or greater, or compatible micro processors (up to 2 processors are supported)	64 MB or greater***	500 MB or greater
Windows XP*	Pentium® Family 300 MHz or greater	64 MB or greater***	500 MB or greater

\* Logon as a user account with Administrators' rights is recommended.

\*\*64 MB or greater is recommended.

\*\*\*128 MB or greater is recommended.

\*\*\*\*200 MB or greater is recommended.

# Using Your Documentation

Your machine includes the following documentation to help you learn how to use your machine:

- *Starter Guide*

This *Guide* provides basic information on how to set up and use the machine.

- *User's Guide (this Guide)*

This *Guide* provides detailed information on how to use and troubleshoot your machine.

- *Software Guide*

This *Guide* (stored in the CD-ROM) describes how to use the machine to print from your PC.

## Type Conventions Used in This Guide

This *Guide* follows the conventions below to emphasize certain information that will help you use your machine correctly and safely:



### CAUTION

Cautions tell you how to avoid actions that could injure you or damage your machine.



### NOTE

Notes provide advice for using your machine more effectively, describe operating restrictions, and tell how to avoid minor operating difficulties.

In addition, this *Guide* uses brackets to show button and switch names on the machine, such as [Start], and [OK]. Text that appears in the machine's display is shown in capital letters, such as: <RECEPTION OK>.

Also, Appendix C describes the country specific features.

## Illustrations Used in This Guide

Unless otherwise mentioned, illustrations used in this guide are those taken when no optional equipment is attached to FAX-L380S.

When there is any difference between FAX-L380S and FAX-L390, it is clearly indicated in the text, e.g., "Only for the FAX-L380S model."



# Safety Instructions

1

Introducing FAX-L380S/L390

Read these safety instructions thoroughly before using your machine, and keep them handy in case you need to refer to them later.



## CAUTION

**Except as specifically described in this *User's Guide*, do not attempt to service the machine yourself. Never attempt to disassemble the machine: opening and removing its interior covers will expose you to dangerous voltages and other risks. For all service, contact your local authorized Canon dealer or the Canon help line.**

- Always follow all warnings and instructions marked on the machine.
- Use the machine only on a sturdy, stable, level surface. If the machine falls, it could be seriously damaged.
- Do not use the machine near water. If you spill liquid on or into the machine, unplug it immediately and call your local authorized Canon dealer or the Canon help line.
- The back of the machine includes slots and openings for ventilation. To keep the machine from overheating (which can cause it to operate abnormally and create a fire risk), take care not to block or cover these openings. Do not operate the machine on a bed, sofa, rug, or other similar soft surface, or near a radiator or other heat source. Do not place the machine in a closet or cabinet or on shelves unless adequate ventilation is available. See "Choosing a Location for Your Machine," on p. 2-1 for guidelines on how much space the machine needs for ventilation.
- Operate the machine only from the type of power source indicated on the machine's label. If you are unsure of the type of power available from your wall outlets, contact your local power company.
- Make sure the total amperage used by all devices plugged into the wall outlet does not exceed the ampere rating of the outlet's circuit breaker.
- Do not allow anything to rest on the power cord and do not place the machine where the cord will be walked on. Make sure the cord is not knotted or kinked.
- Do not insert object of any kind into the slots or openings on the machine's cabinet, as they could touch dangerous voltage points or short out parts, and result in fire or electric shock.
- Do not allow small objects (such as pins, paper clips, or staples) to fall into the machine. If something does fall into it, unplug the machine immediately and call your local authorized Canon dealer or the Canon help line.
- Do not plug the power cord into an uninterruptible power supply (UPS).
- Always unplug the machine before moving or cleaning it.
- Whenever you unplug the machine, wait at least 5 seconds before you plug it back in.
- Keep the machine away from direct sunlight, as this can damage it. If you have to place it near a window, install heavy curtains or blinds.
- Do not expose the machine to extreme temperature fluctuations. Install the machine in a place with temperatures between 10° and 32.5°C.
- Always unplug the machine during thunderstorms.
- Before you transport the machine, remove the toner cartridge.

- Always lift the machine as shown below. Never lift it by its paper cassette or other supports.

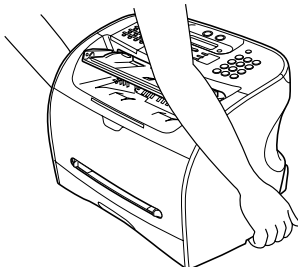

## CAUTION

Unplug the machine and contact your local authorized Canon dealer or the Canon help line in any of these situations:

- If the power cord or plug is damaged or frayed.
- If liquid spills into the machine, or if it is otherwise exposed to rain or liquids.
- If you notice smoke, unusual noises or odor coming from it.
- If the machine does not operate normally when you follow the operating instructions. Adjust only those controls that are covered by the operating instructions in this *User's Guide*, or you can damage the machine and require extensive repair work.
- If the machine is dropped or its cabinet damaged.
- If the machine begins performing poorly, and you cannot correct the problem by following the procedures in Chapter 14, "Troubleshooting."
- This product emits low level electromagnetic waves. If you use a cardiac pacemaker and feel abnormalities, please move away from this product and consult your doctor.

## Customer Support

Your machine is designed with the latest technology to provide trouble-free operation. If you encounter a problem with the machine's operation, try to solve it by using the information in Chapter 14.

If you cannot solve the problem or if you think your machine needs servicing, contact your local authorized Canon dealer or the Canon help line.

# 2

## CHAPTER

# Setting Up Your Machine

This chapter tells you how to unpack, assemble, and connect your machine, install the toner cartridge, and load paper — everything you need to know to get your machine ready to use.

## Choosing a Location for Your Machine

Before unpacking your machine, follow these guidelines to choose an appropriate location for the machine.



### CAUTION

Please review the information provided in “Safety Instructions,” on p. 1-6, to make sure you are installing your machine for safe use.

- Put the machine in a cool, dry, clean, well ventilated place:
  - Make sure the area is free from dust.
  - Make sure the location is not affected by extreme temperature fluctuations, and remains between 10° and 32.5°C.
  - Make sure the area's relative humidity is always between 20% and 80%.
- Keep the machine away from direct sunlight.
- If possible, place the machine near an existing telephone outlet, to allow for an easy connection of the telephone line to the machine.
- Place the machine near an electrical wall outlet that provides 200 to 240-volt AC (50 to 60 Hz) power.
- Place the machine near the PC you will be connecting it to. Make sure you can reach it easily, as you will be using the machine as a printer, fax machine, copier, and telephone.
- Do not plug the machine into the same circuit as an appliance such as an air conditioner, electric typewriter, television, or copier. Such devices generate electrical noise that can interfere with your machine's ability to send or receive faxes.
- Set the machine on a flat, stable, vibration-free surface that is strong enough to support its weight (about 11 kg (12.1 kg for the FAX-L390 model)).

# Unpacking Your Machine

Follow the directions below to unpack your machine properly, and to make sure you have all of its components and documentation.

## Do You Have Everything?

As you unpack the machine, save the carton and packing material in case you want to move or ship the machine in the future.

Carefully remove all items from the box. You should have someone help by holding the box while you lift the machine and its protective packaging out of the carton.

Make sure you have the following items:

FAX-L380S



MAIN UNIT

FAX-L390

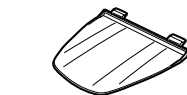
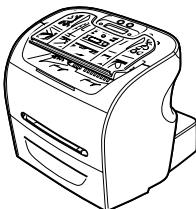

DOCUMENT OUTPUT TRAY



OUTPUT TRAY

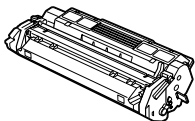

CARTRIDGE T STARTER

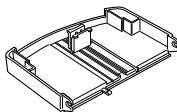

CASSETTE EXTENSION\*

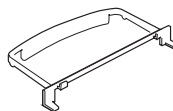

EXTENSION COVER\*

POWER CORD

TELEPHONE LINE CORD

DOCUMENTATION

DESTINATION LABELS

CD-ROM

ONE-TOUCH SHEET

If any of the above items are damaged or missing, notify your local authorized Canon dealer immediately.

\*Only for the FAX-L380S model



## NOTE

- The actual items may differ in shape and quantity from the ones shown on p. 2-2.
- Note that the items included with your machine may vary depending on the country of purchase.
- Important! Save your sales receipt for proof of purchase in case your machine requires warranty service.
- If you have purchased the optional handset, see Appendix B for the items included.
- In addition to the items shipped with your machine, if you wish to use the machine as a printer, you will need a USB cable, which you can purchase from your Canon dealer. For best results, use a cable that is no more than 5 meters long.

## Removing Shipping Materials

In order to protect your machine during shipping, the machine has been packed with protective material that you must remove before using. Follow these steps:



## NOTE

The actual shipping materials may differ in shape, quantity, and position from the ones shown in the illustrations below.

- 1** Remove all pieces of shipping tape from the exterior of the machine.
- 2** Open the document feeder tray.
- 3** Open the operation panel by grasping it at the center and gently pulling it up. Remove protective sheet from the Automatic Document Feeder (ADF), then gently close the operation panel by pressing it down until it clicks.

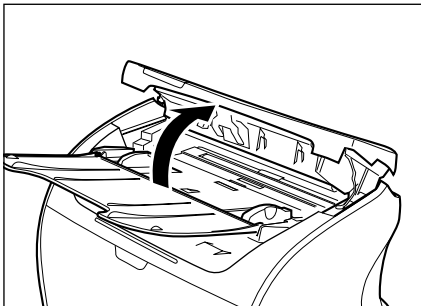

## Replaceable Parts

The only component of the machine that needs regular service or replacement is the Cartridge T. The Cartridge T Starter comes with your machine but you should purchase the regular Cartridge T for replacement.

Although Canon manufactures many types of toner cartridges, the Cartridge T is the only one designed to be used with your machine. The Cartridge T can be purchased at any Canon authorized dealer.

# Assembling the Machine

Use the following instructions to assemble the main unit and its components. To see how the machine will look fully assembled, see "Getting Acquainted With Your Machine," on p. 2-11.

## Attaching Components



### NOTE

*Make sure the tabs are inserted into the slot completely.*

### **Document Output Tray**

Insert the tabs into the slots on the back of the machine.

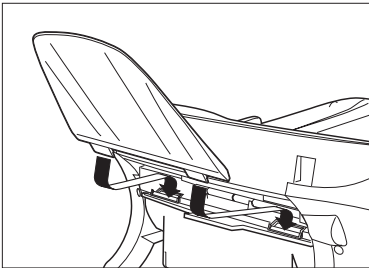

### **Output Tray**

Insert the tray into the corresponding slots.

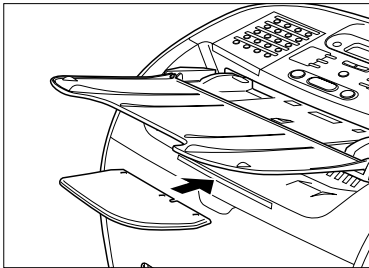

## Installing the Paper Cassette\*

**1** Pull out the paper cassette.

**2** Attach the cassette extension to the cassette.

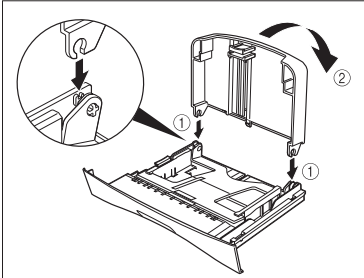

**3** Attach the extension cover on the back of the machine.

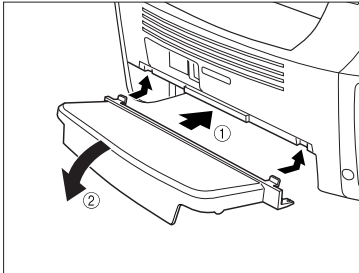

**4** Insert the paper cassette into the machine.

\*Installing the paper cassette is necessary to the FAX-L380S model only.



# Making Connections

 **NOTE**

- The use of the jacks may differ in certain countries. See Appendix C, "Country-Specific Features." for details.
- Be sure to connect any external device before using your machine.
- Canon cannot guarantee that all answering machines will be compatible with your machine, due to varying specifications.
- If you have connected an external device to your machine, be sure to set the correct receive mode. (See Chapter 7, "Receiving Faxes.")
- To connect an extension phone as well as an answering machine, connect the extension phone to the answering machine, and then the answering machine to your machine.
- If you connect a data modem to your machine and you use it extensively, or others access your PC frequently through the data modem, you may want a dedicated telephone line for your data modem.

## Connecting the Machine to Your PC

Your machine has a USB port that allows you to connect it to a PC. To do this, you need to purchase a USB cable from your dealer.

 **NOTE**

*For best results, use a cable that is 5 meters in length or shorter.*

Connect the machine to your computer as follows:

- 1** Make sure the computer is turned off and the machine is unplugged.
- 2** Connect the USB cable to your machine and PC during software installation to ensure the proper operation of the printer driver. (See the *Software Guide*.)

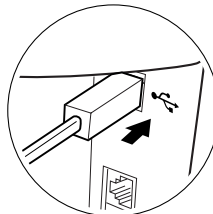
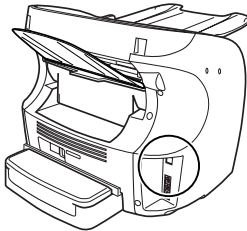

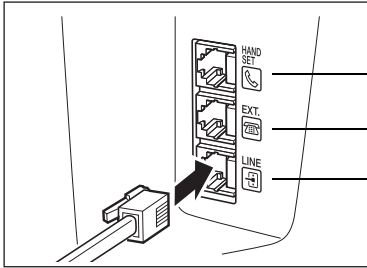

## Connecting the Telephone Line

Connect the telephone line to the jack on the left side of the machine:



Connect the optional handset to .

Connect an extension phone or answering machine to .

Connect the supplied telephone line to .

Connect the other end of line to a wall telephone jack.

If you connect an answering machine to the machine, be sure to read your answering machine's manual.

### NOTE

You can also connect the extension phone to the jack marked  if you have not connected the optional handset.

## Connecting the Power Cord

### CAUTION

Follow these guidelines when connecting your machine to a power source:

- The machine is intended for domestic use only and requires 200-240 V AC. Do not use it outside the country where it was purchased.
- Use only the power cord that came with the machine. Using a longer cord or extension cord can cause the machine to malfunction.
- Unplug the machine only by pulling on the plug itself. Never pull on the cord.
- Do not plug the machine into an outlet shared with an appliance such as an air conditioner, computer, electric typewriter, or copier. These devices generate electrical noise, which can interfere with the operation of the machine.
- Make sure nothing is laying on the power cord, and that the cord cannot be walked on or tripped over.
- Do not overload the electrical outlet. Make sure the total amperage used by all the machines plugged into the outlet does not exceed the ampere rating of the outlet's circuit breaker.
- Do not plug the machine into an uninterruptible power supply (UPS).

Connect the power cord as follows:

- 1 Plug the supplied power cord into the power connector on the back of the machine.

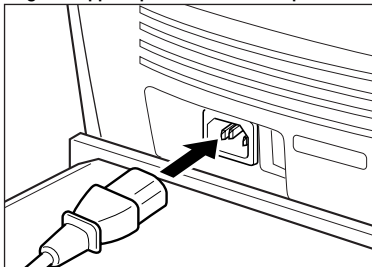

- 2 Plug the other end of the power cord into the outlet.



#### NOTE

*The machine has no power switch, so its power is on as long as it is plugged in. Once connected, though, the machine still needs to warm up before you can use it.*

While the machine is warming up, the message <PLEASE WAIT> appears in the LCD display:

```
PLEASE WAIT
```

When you connect the power cord to an AC outlet for the first time after purchase, <DISPLAY LANGUAGE> will appear in the LCD display after <PLEASE WAIT>. In this case, set the language for the LCD display, and the country\*. (See "Setting the Display Language and Country\*," on p. 2-10.)

The Fax standby mode appears:

```
31/12 2005 SAT 15:11  
FaxOnly STANDARD
```



#### NOTE

*If the toner cartridge has not been installed yet, the message <INSTALL CARTRIDGE> appears in the LCD display, and the Alarm indicator flashes. In this case, install the toner cartridge. (See "Installing/Replacing the Toner Cartridge," on p. 2-18.)*

\* The country selection feature is available for certain countries only.

# Setting the Display Language and Country\*

When you connect the power cord to an AC outlet for the first time, you need to select the language for the LCD display. For some countries, you also need to select the country where you are using the machine. The machine automatically switches the selectable settings and the default settings in the menus to suit the selected country.

Follow these steps to set the display language and country.

After connecting the power cord, the display changes from <PLEASE WAIT> to the <DISPLAY LANGUAGE> menu.

- 1** Use [**◀(-)**] or [**▶(+)**] to select the preferred language for the LCD display → press [OK].

DISPLAY LANGUAGE < ENGLISH >	→	COUNTRY SELECT UK
---------------------------------	---	----------------------

If <COUNTRY SELECT> does not appear after <DATA ENTRY OK> is displayed:

Setting is completed and the machine enters the Fax standby mode.

If <COUNTRY SELECT> appears after <DATA ENTRY OK> is displayed:

Go to step 2.

- 2** Use [**◀(-)**] or [**▶(+)**] to select the country where you are using the machine → press [OK].

COUNTRY SELECT UK	→	31/12 2005 SAT 15:11 FaxOnly STANDARD
----------------------	---	--

If your country name does not appear, select <OTHERS>.

Once you have selected the language and country, these setting menus will not appear next time you connect the power cord.

- To check the settings made by the country selection, you can print the USER'S DATA LIST. (See "User's Data List" on p. 13-11.)
- You can change the display language or country setting using the <SYSTEM SETTINGS> menu in the <FAX SETTINGS> menu. (See Chapter 16, "The Menu System.")

\* The country selection feature is available for certain countries only.

# Getting Acquainted With Your Machine

Before using your machine, look over the diagrams on these pages to become familiar with the machine's components.

## Front View

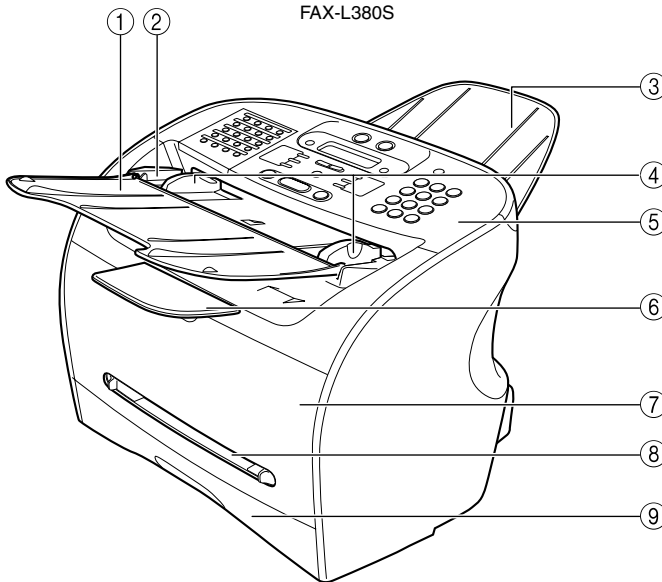

- ① **Document feeder tray**  
Place documents.
- ② **ADF (Automatic Document Feeder)**  
Holds documents and feeds them automatically into the scanning machine.
- ③ **Document output tray**  
Documents come out here.
- ④ **Slide guides**  
Adjust to the width of documents.
- ⑤ **Operation panel**  
Controls the machine.
- ⑥ **Output tray**  
Outputs printouts.
- ⑦ **Printer cover**  
Open it when you install the cartridge, or remove jammed paper.
- ⑧ **Multi-purpose feeder**  
Used when printing paper one by one manually.
- ⑨ **Cassette**  
Holds the paper supply.

FAX-L390

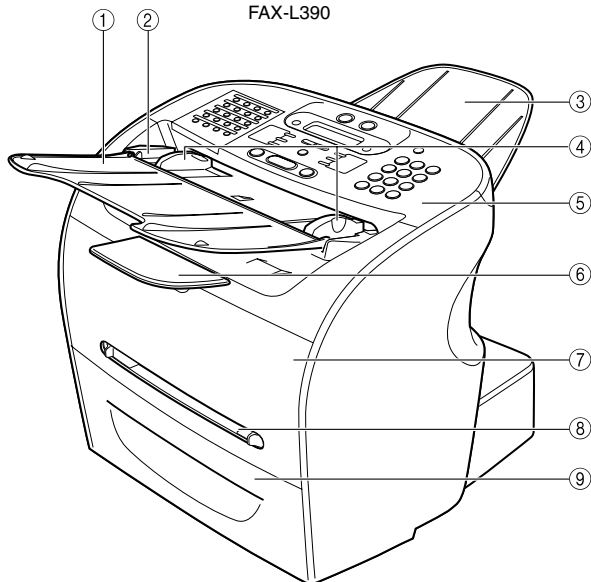

- ① **Document feeder tray**  
Place documents.
- ② **ADF (Automatic Document Feeder)**  
Holds documents and feeds them automatically into the scanning machine.
- ③ **Document output tray**  
Documents come out here.
- ④ **Slide guides**  
Adjust to the width of documents.
- ⑤ **Operation panel**  
Controls the machine.
- ⑥ **Output tray**  
Outputs printouts.
- ⑦ **Printer cover**  
Open it when you install the cartridge, or remove jammed paper.
- ⑧ **Multi-purpose feeder**  
Used when printing paper one by one manually.
- ⑨ **Cassette**  
Holds the paper supply.

## Rear View

FAX-L380S

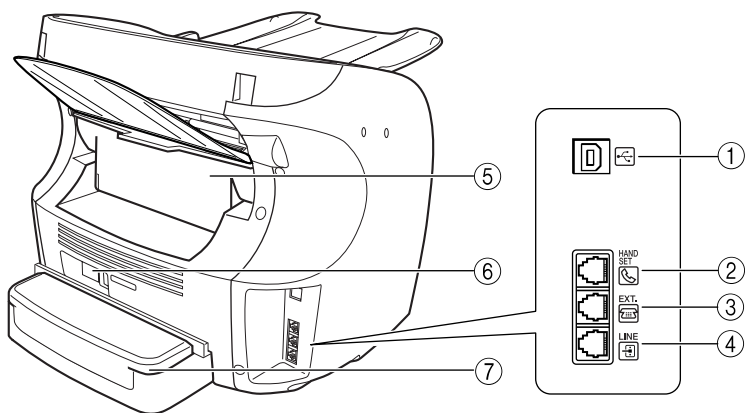

FAX-L390

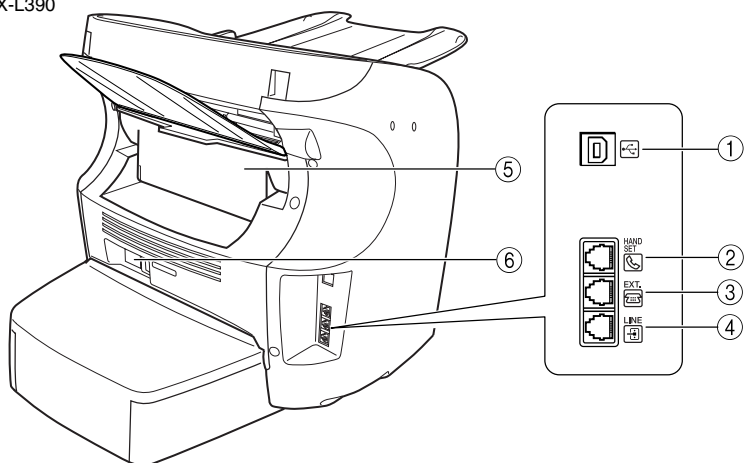

- ① **USB port**  
Connect the USB (Universal Serial Bus) cable.
- ② **Handset jack**  
Connect the handset (optional).
- ③ **Extension phone jack**  
Connect an extension phone.
- ④ **Telephone line jack**  
Connect the telephone cable.

- ⑤ **Rear cover**  
Open it when you output paper face up, or remove jammed paper.
- ⑥ **Power socket**  
Connect the power cord.
- ⑦ **Extension cover**  
Protects paper supply in the cassette from dirt and dust.

2

Setting Up Your Machine

# The Operation Panel

2

Setting Up Your Machine

FAX-L380S

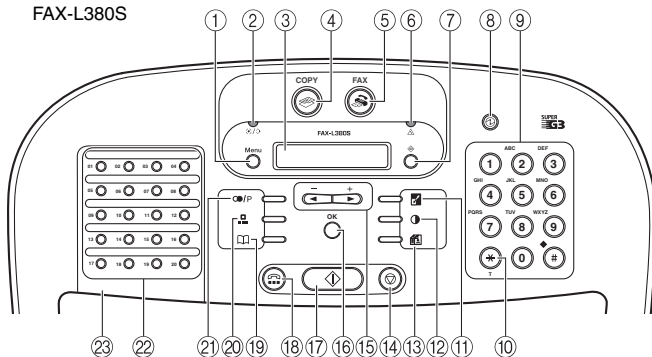

FAX-L390

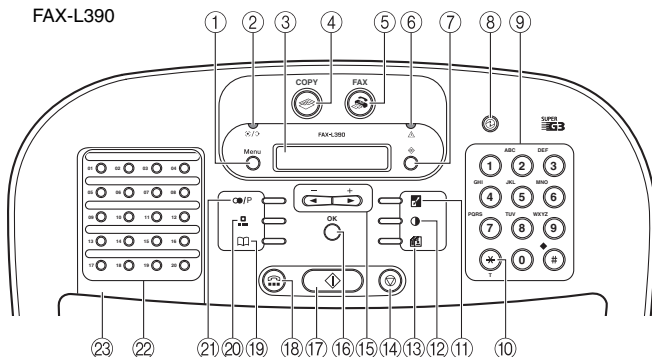

- ① **Menu button**  
Use this button to customize the operation of the machine.
- ② **⊗/⊃ In Use/Memory indicator**  
Lights when the telephone line is used or a document has been received in memory.
- ③ **LCD display**  
The LCD display shows messages and prompts while you use the machine.
- ④ **☰ COPY button**  
Use this button to switch standby display to Copy mode.
- ⑤ **☰ FAX button**  
Use this button to switch standby display to Fax mode.
- ⑥ **⚠ Alarm indicator**  
This indicator flashes when an error occurs, or when the machine is out of paper or toner.
- ⑦ **◆ System Monitor button**  
Use this button to check the status of copy, fax, print and report jobs.
- ⑧ **⊕ Energy Saver button**  
Use this button to set or cancel the energy saver mode manually. The button lights green when the energy saver mode is enabled.
- ⑨ **Numeric buttons**  
Use these buttons to enter numbers and names when registering information, and to dial fax/telephone numbers.
- ⑩ **Tone button**  
Use this button to use tone dialing temporarily when your machine is set for pulse dialing.
- ⑪ **☰ Enlarge/Reduce button**  
Use this button to set an enlargement or reduction ratio of a copy.
- ⑫ **⊕ Exposure button**  
Use this button to adjust the copy exposure.
- ⑬ **☰ Image Quality button**  
Use this button to select the resolution the machine will use for the document you want to fax, or copy.



- ⑭ **Stop/Reset button**  
Use this button to cancel sending or receiving faxes and other operations, and bring back the standby display in the LCD.
- ⑮ **◀(-), ▶(+)** buttons  
Use this button to scroll through the selections.
- ⑯ **OK button**  
Use this button to determine the contents you set or register.
- ⑰ **Start button**  
Use this button to begin faxing, or copying.
- ⑱ **Hook button**  
Use this button to dial, even with the optional handset still in the handset cradle.

- ⑲ **Directory button**  
Use this button to look up fax/telephone numbers registered for speed dialing.
- ⑳ **Coded Dial button**  
Use this button to dial a fax/telephone number that you have registered for Coded Speed Dialing.
- ㉑ **Redial/Pause button**  
Use this button to redial the last number that was dialed using the numeric buttons, or to enter pauses in a fax number.
- ㉒ **One-Touch Speed Dial buttons**  
Use these buttons for One-Touch Speed Dialing.
- ㉓ **One-Touch Speed Dial panel**  
Open this panel to access the registration buttons.

## Special Function Buttons (One-Touch Speed Dial Panel Open)

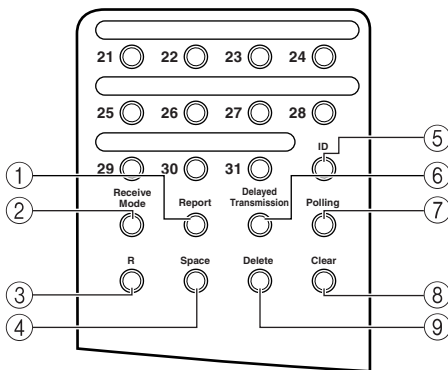

- ① **Report button**  
Use this button to print activity reports.
- ② **Receive Mode button**  
Use this button to select the receive mode for receiving faxes.
- ③ **R button**  
Use this button to dial an outside line access number when the machine is connected through a switchboard (PBX).
- ④ **Space button**  
Use this button to enter a space between letters and numbers when you are registering information.

- ⑤ **ID button**  
Use this button to enter the Department ID.
- ⑥ **Delayed Transmission button**  
Use this button to register a time for delayed sending.
- ⑦ **Polling button**  
Use this button to set a document for polling sending, and to poll the other fax to receive a document.
- ⑧ **Clear button**  
Use this button to clear an entire entry during information registration.
- ⑨ **Delete button**  
Use this button to delete characters one by one.

# Energy Saver Mode

The machine provides an energy saver function. When no operations are performed for about 5 minutes, the machine automatically enters the energy saver mode.



## NOTE

- The time until the machine enters the energy saver mode can be specified in a range of 3 minutes to 30 minutes. You can also turn off the energy saver function. (See Chapter 16, "The Menu System.")
- The energy saver function does not activate when the machine is in the following status:
  - When printing out copies, faxes or other pages
  - When sending or receiving faxes
  - While a copy job is saved in memory or when the reserve copy or other functions are operating, or when the In Use/Memory indicator lights up
  - When paper jams occur
  - When an error code appears and the Alarm indicator flashes
  - When no paper is loaded in the cassette

## Setting the Energy Saver Mode Manually

**1**

Press [Energy Saver].

The LCD is turned off and [Energy Saver] lights up.



## NOTE

Right after the machine is restored from the energy saver mode, or right after copying finishes, wait about 2 seconds before pressing [Energy Saver].

## Restoring from the Energy Saver Mode

**1**

Press [Energy Saver].

[Energy Saver] goes off and the machine enters standby mode.



## NOTE

The machine can be restored from the energy saver mode immediately. However, it may vary according to room temperature and circumstances.

# The Toner Cartridge

## Handling and Storing Cartridges

- Do not open the drum protective shutter on the cartridge. If the drum surface is exposed to light and damaged, print quality may deteriorate.

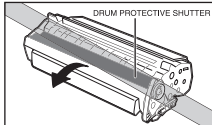

- Do not stand the cartridge on end, and do not turn it upside down. If toner becomes caked in the cartridge, it may prove impossible to free it even by shaking the cartridge.

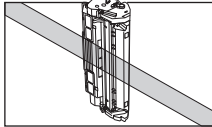

- Keep the cartridge away from computer screens, disk drives, and floppy disks. The magnet inside the cartridge may harm these items.

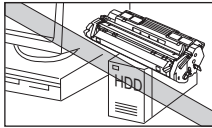

- Never touch the drum protective shutter. When holding the cartridge, avoid touching the drum protective shutter with your hands.

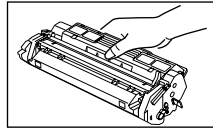
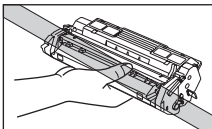

- Do not expose the cartridge to direct sunlight or bright light for longer than 5 minutes.
- Do not store the cartridge in direct sunlight.
- Avoid locations subject to high temperature, high humidity, or rapid changes in temperature. Store the cartridge between 0° and 35°C.
- Hold the cartridge as shown so that your hand is not touching the drum's protective shutter.
- Store the cartridge in its protective bag. Do not open the bag until you are ready to install the cartridge in the machine.
- Save the protective bag. You may need to repack and transport the cartridge at a later date.
- Do not store the cartridge in salty air or where there are corrosive gases such as from aerosol sprays.
- Do not remove the cartridge from the machine unless necessary.
- Be sure to remove the toner cartridge from the machine when disposing of the machine.

**CAUTION**

**DO NOT PLACE THE CARTRIDGE IN FIRE. TONER POWDER IS FLAMMABLE.**

## Installing/Replacing the Toner Cartridge

The machine uses the Canon Cartridge T. The procedure on the next page explains how to install the cartridge for the first time, and how to replace it when the toner runs out.

When the message <REPLACE CARTRIDGE> appears, the toner in the cartridge may simply be unevenly distributed. Before replacing the cartridge, follow the instructions on p. 2-19 to evenly distribute the toner. If the message remains displayed or the print quality is low, after doing this replace the cartridge as described below.

**NOTE**

*Canon makes numerous cartridges. However, the Canon genuine Cartridge T Starter and the Canon genuine regular Cartridge T are the only one which Canon recommends you to use with your machine. The Canon genuine Cartridge T Starter that comes with your machine can yield approx. 2,500 page of printouts (based on 5% coverage of a A4-size page), while the Canon genuine Cartridge T you purchase can yield approx. 3,500 page of printouts (based on 5% coverage of a A4-size page). But the Canon genuine Cartridge T Starter is identical to the Canon genuine regular Cartridge T otherwise.*

- 1** Remove any documents and/or printed pages from the machine.
- 2** Make sure the machine is plugged in.
- 3** Remove the cartridge from the bag. Keep the bag in a safe place for future use.

- 4** Gently rock the cartridge several times to evenly distribute the toner inside.

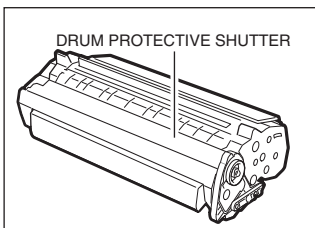
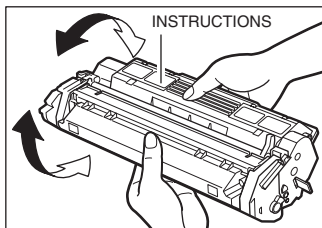

 **NOTE**

Always hold the cartridge as shown so that the side with the instructions is facing upward. Do not forcefully move or push the protective shutter of the drum in any way.

- 5** Hold the cartridge on a flat stable surface with one hand, and break the tab and pull out the seal completely with the other hand.

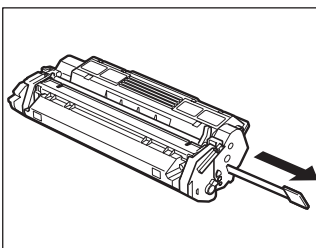
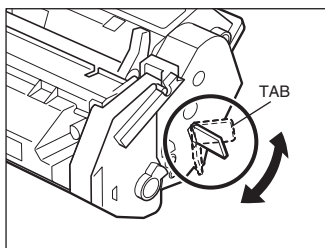

- 6** Open the printer cover.

 **NOTE**

If you are replacing the old cartridge with the new one, remove the old cartridge from the machine. Then, discard the old toner cartridge immediately according to the local laws and regulations for disposal of consumables.

- 7** Hold the cartridge and position the arrow mark on the cartridge towards the inside of the machine as shown below.

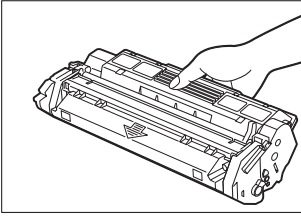

- 8** Align the projections **(A)** on both sides of the cartridge to the guides **(B)** in the machine and slide the cartridge completely into the machine.

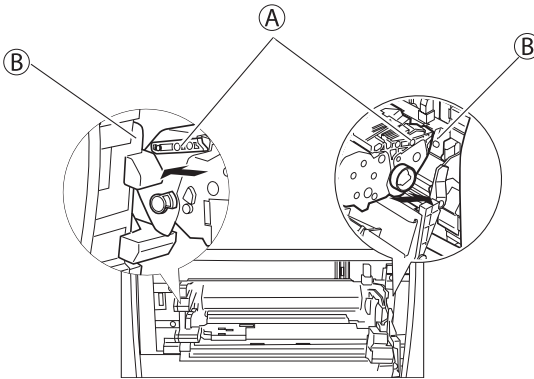

- 9** Close the printer cover.

# Loading Recording Paper

When the message <SUPPLY REC. PAPER> appears in the LCD display, you need to add paper to the paper cassette. Here are a few tips you should follow when you load paper into the paper cassette.

- Be sure to load paper of the correct size, weight, and quantity recommended for your machine. (See Chapter 4, "Paper Handling.")
- Stack the paper so that the top and bottom edges and sides are straight and even before placing it in the paper cassette.
- Do not print on both sides of the paper. Doing so may cause several sheets to feed into the machine at the same time.
- Let the paper run out before you refill the paper cassette.
- Avoid mixing new stock with paper already loaded in the paper cassette. When adding new stock to the cassette, be sure to remove the remaining paper in the cassette and reload it together with the new stock. Failure to do so may cause paper jams.



## NOTE

- Do not use damp, curled, wrinkled, or torn paper as these can cause paper jams or poor print quality.
- Highly textured, extremely smooth or shiny paper does not print well.
- The laser printing process uses high temperatures to fuse toner to the paper. Use paper that will not melt, vaporize, discolor, or emit dangerous fumes at temperatures near 170°C. For example, do not use vellum paper in a laser printer. Make sure any letterhead or colored paper you use can withstand high temperatures.
- Make sure the paper is free of dust, lint, and oil stains.
- To keep the paper from curling, do not open paper packs until you are ready to use the paper. Store unused paper from opened packs in a cool, dry location in the original packaging.
- Your machine is factory-set to use A4-size paper in the paper cassette.  
If you wish to use different sized paper, you must change the setting using the <PAPER SETTINGS> menu. See p. 16-2 for more details.
- Refer to Chapter 4, "Paper Handling," for more details on the types of media you can load in the paper cassette.



## CAUTION

**Do not load paper in the multi-purpose feeder when the machine is printing.**

# Loading Paper in the Cassette

- 1 Pull out the cassette completely.

## CAUTION

Be sure to completely remove the paper cassette from the machine and place on a flat surface before performing the following steps. Failure to do so, may cause the machine tip over, and result in personal injury.

2

Setting Up Your Machine

- 2 Adjust the length slide guide to match the paper size.

FAX-L380S

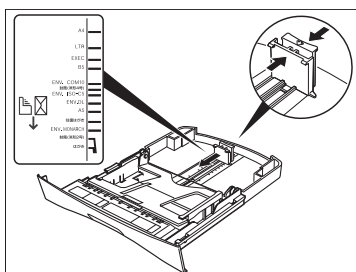

FAX-L390

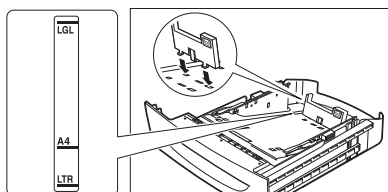

For the FAX-L390 model, be sure to properly attach the stopper of the paper size rear guide for the correct paper size by inserting the tabs into the matching slots on the paper cassette.

- 3 Adjust the width slide guides or paper width guides to match the paper size.

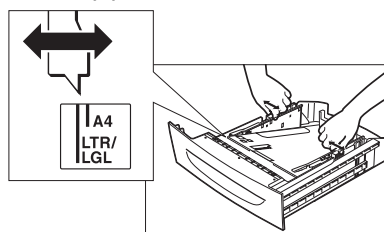
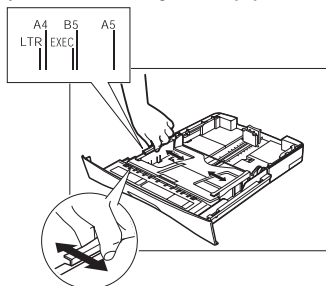



- 4** Load the paper into the cassette. Make sure the paper stack sits below the hooks for the FAX-L380S model.

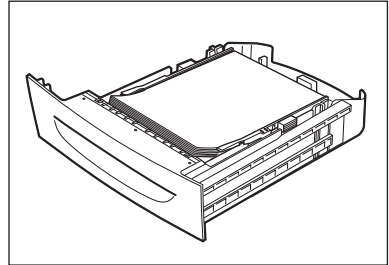
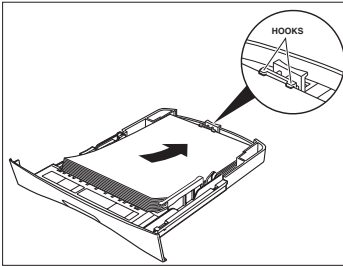

- 5** Even out the edges of the paper stack.

Make sure the height of the paper stack does not exceed the load limit mark.

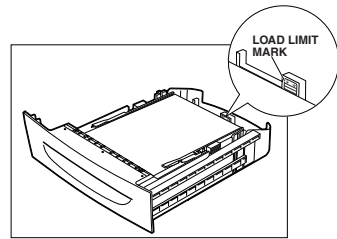
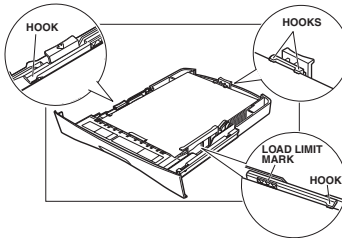

- 6** Insert the cassette into the machine as far as it will go.

 **NOTE**

*If you do not completely insert the cassette into the machine, paper jams may occur.*

## Testing the Machine

After you have assembled your machine, installed the toner cartridge, loaded plain paper in the paper cassette, you can make sure the machine is printing properly by making several copies of a document. For instructions, see Chapter 11, “Making Copies.”

Note the following:

- If the printed sheets are curled as they exit the machine, remove them from the output slot immediately to avoid paper jams.
- Make sure your text or graphics fall within the printable area.

# Registering Information in the Machine

# 3

## CHAPTER

This chapter describes how to enter information in your machine.

## Guidelines for Entering Information

The following section explains how to enter user information into the machine.



### NOTE

*If you pause while entering information and do not make an entry for more than a specified period of time, the machine returns to standby mode and loses all information you had entered up to that point. You will then have to start again. The time until the machine returns to the standby mode can be specified in a range of 1 to 9 minutes. You can also turn off the AUTO CLEAR function. (See Chapter 16, "The Menu System.")*

## Entering Numbers, Letters, and Symbols

Each numeric button has a number and a group of uppercase and lowercase letters assigned to it. Use the chart below to determine which numeric button to press for each character.



### NOTE

*The characters that appear when you press the numeric buttons differ depending on the display language you select. For details on selecting the display language, see "Setting the Display Language and Country," on p. 2-10.*

Button	Uppercase	Lowercase
1	@ . - _ /	@ . - _ /
2	ABC	abc
3	DEF	def
4	GHI	ghi
5	JKL	jkl
6	MNO	mno
7	PQRS	pqrs
8	TUV	tuv
9	WXYZ	wxyz
0		
*	↶ Uppercase → Lowercase → Number ↷	
#	- . * # ! " , ; : ^ ` _ = /   ' ? \$ @ % & + \ ^ ( ) [ ] { } < >	

Follow this procedure when you come to a step that requires you to enter a name or number.

- 1** Press [~~\*~~] to switch to the uppercase letter mode (:A), lowercase letter mode (:a), or the number mode (:1).

You can see what mode you are in by the character indicated on the top right corner of the LCD display.



- 2** Use the numeric buttons to enter the letter or number.

Press the button repeatedly until the letter or number you want appears.

● **To enter two letters or symbols that are under the same button:**

- Press the numeric button → [▶(+)] → press the same numeric button again.  
For example, to enter <DD> you would press [3] → [▶(+)] → [3].

● **To enter a space:**

- Press [Space] under the One-Touch Speed Dial panel.

● **To delete a character:**

- Press [Delete] under the One-Touch Speed Dial panel.

● **To delete an entire entry:**

- Press [Clear] under the One-Touch Speed Dial panel.

# Personalizing Your Machine

## Identifying Your Documents

When sending documents, you can have your fax number, your name, and the current date and time printed out by the receiving fax. This information is called your TTI (Transmit Terminal Identification) and appears at the top of the faxed document in small type.

By identifying the documents you send, the receiving party can recognize your fax messages at a glance. Here is a sample document with the identifying information:

THE DATE AND TIME YOU SENT THE DOCUMENT	31/12 2005 10:12
YOUR FAX/ TELEPHONE NUMBER	FAX 123xxxx
YOUR NAME OR COMPANY NAME	CANON EUROPA
THE NAME OF THE PARTY WHO IS RECEIVING THE FAX*	CANON U.K.
THE PAGE NUMBER	001/001

**THE SLEREXE COMPANY LIMITED**  
SAPORS LANE • BOOLE • DORSET • BH25 8ER  
TELEPHONE BOOLE (0 15 13) 51617 • FAX 123456

Our Ref. 350/PJC/EAC

\* When using speed dialing, the top line also includes the name registered under the speed dialing button or code you entered.

## Entering the Date and Time

Follow this procedure to enter the date and time:

- 1 Press [Menu].
- 2 Press [◀(-)] or [▶(+)] to select <7.TIMER SETTINGS> → press [OK] twice.

- 3** Use the numeric buttons to enter the date (month/day/year) and time (in 24-hour format) → press [OK].

DATE/TIME SETTING 31/12 '05 15:10	→	TIMER SETTINGS 2.AUTO CLEAR
--------------------------------------	---	--------------------------------

Enter only the last 2 digits of the year.

- 4** Press [Stop/Reset] to return to standby mode.

## Registering Your Fax Number and Name

Follow this procedure to register your fax/telephone number and name:

- 1** Press [Menu].
- 2** Press [◀(-)] or [▶(+)] to select <4.FAX SETTINGS> → press [OK] four times.
- 3** Use the numeric buttons to enter your fax/telephone number (Max. 20 digits, including spaces) → press [OK].

USER TEL NO. 123xxxxxxxxxx	→	TEL LINE SETTINGS 2.TEL LINE TYPE
-------------------------------	---	--------------------------------------

For details on how to enter or delete numbers, see "Entering Numbers, Letters, and Symbols," on p. 3-1.

- 4** Press [Menu] → [◀(-)] or [▶(+)] to select <2.UNIT NAME> → press [OK].
- 5** Use the numeric buttons to enter your name (Max. 24 characters, including spaces) → press [OK].

Canon : A	→	USER SETTINGS 3.TX TERMINAL ID
-----------	---	-----------------------------------

For details on how to enter or delete characters, see "Entering Numbers, Letters, and Symbols," on p. 3-1.

- 6** Press [Stop/Reset] to return to standby mode.

## Setting the Telephone Line Type

Use this procedure if you need to change the telephone line setting.

If you are unsure which setting to use, contact your local telephone company.

Follow this procedure to set the telephone line type:

- 1** Press [Menu].
- 2** Press [◀(-)] or [▶(+)] to select <4.FAX SETTINGS> → press [OK] three times.
- 3** Press [◀(-)] or [▶(+)] to select <2.TEL LINE TYPE> → press [OK].
- 4** Press [◀(-)] or [▶(+)] to select the telephone line type → press [OK].



You can select from the following:

- <TOUCH TONE> for tone dialing
- <ROTARY PULSE> for pulse dialing

- 5** Press [Stop/Reset] to return to standby mode.

## Setting the Summer Time\*

Some countries adopt the summer time system that shifts the clock time ahead or back according to the change in seasons. You can select if the time information in your machine changes to match your country's summer time system and set the day and time when the summer time begins and ends.

- 1** Press [Menu].
- 2** Press [◀(-)] or [▶(+)] to select <7.TIMER SETTINGS> → press [OK].
- 3** Press [◀(-)] or [▶(+)] to select <5.SUMMER TIME> → press [OK].
- 4** Press [◀(-)] or [▶(+)] to select <ON> to enable the summer time setting or <OFF> to disable it → press [OK].  
If you selected <ON>, go to step 5.  
If you selected <OFF>, go to step 12.

\* The Summer Time feature is available for certain countries only.

**5** Press [OK] twice.

**6** Press [◀(-)] or [▶(+)] to select the month in which the summer time starts → press [OK] twice.

MONTH	→	WEEK
APRIL		FIRST WEEK

**7** Press [◀(-)] or [▶(+)] to select the week in which the summer time starts → press [OK] twice.

You can select from the following:

- <FIRST WEEK>
- <SECOND WEEK>
- <THIRD WEEK>
- <FOURTH WEEK>
- <LAST WEEK> (fourth or fifth week depending on the selected month)

WEEK	→	DAY
SECOND WEEK		SUNDAY

**8** Press [◀(-)] or [▶(+)] to select the day of the week on which the summer time starts → press [OK] twice.

DAY	→	TIME
SUNDAY		02:00

**9** Use the numeric buttons to enter the time at which the summer time compensation is made → press [OK] three times.

Use the 24-hour format for the time (e.g., 2:00 p.m. as 14:00) and precede single digits with a zero.

TIME	→	MONTH
02:00		OCTOBER

**10** Press [◀(-)] or [▶(+)] and [OK] to select the month, week, day of the week, and time when the summer time ends, as in steps 6 to 9 for the <1.BEGIN DATE/TIME> settings. (e.g. OCTOBER LAST WEEK, SUNDAY and 03:00)

**11** Press [OK].

**12** Press [Stop/Reset] to return to standby mode.

# Paper Handling

# 4

## CHAPTER

This chapter describes how to select and prepare the print media for the different functions your machine can perform.

## Print Media Requirements

For high-quality printing, we recommend using paper and transparencies recommended by Canon. Some types of paper available at office supply stores may not be suitable for the machine. If you have any questions about paper and transparencies, contact your local authorized Canon dealer or the Canon help line.

### ■ Paper Storage

In order to prevent paper jams, do the following:

- To prevent moisture buildup, store remaining paper wrapped tightly in its original package. Store paper in a dry location, out of direct sunlight.
- To prevent curling, store paper flat, not upright.
- If the paper is curled, uncurl it before loading it in the cassette or multi-purpose feeder. Failure to do so will cause paper creases and a paper jam.

### ■ Unacceptable Paper

Do not print on the following types of paper stock. Doing so may result in paper jams.

- Severely curled or wrinkled paper
- Transparencies designed for full-color copiers or printers
- Paper which has already been copied using a digital full-color copier (Do not print on the reverse side.)
- Paper which has been printed on using a thermal transfer printer (Do not print on the reverse side.)



### IMPORTANT

*Never attempt to print on full-color transparencies. Doing so may result in product malfunction.*



## ■ Acceptable Paper

	Cassette	Multi-Purpose Feeder
Paper Size	FAX-L380S: A4, B5, A5, LTR, EXECUTIVE Envelope (COM10, MONARCH, DL, ISO-C5) Free Size: 216 mm × 356 mm [Max.]/76 mm × 127 mm [Min.] FAX-L390: A4, LTR	A4, B5, A5, LTR, LGL, EXECUTIVE Envelope (COM10, MONARCH, DL, ISO-C5) Free Size: 216 mm × 356 mm [Max.]/76 mm × 127 mm [Min.]
Paper Weight	64 g/m <sup>2</sup> to 128 g/m <sup>2</sup>	
Paper Type	FAX-L380S: Plain paper, Plain paper L, Heavy paper, Heavy paper H, Transparency FAX-L390: Plain paper, Plain paper L	Plain paper, Plain paper L, Heavy paper, Heavy paper H, Transparency



### IMPORTANT

*You cannot use multi-purpose feeder for FAX.*



### NOTE

- The printing speed may become slower than usual depending on the paper size, the paper type, and the number of sheets you specify. This is because the machine's safety function works to prevent the failure due to heat.
- Some types of paper may not feed properly into the cassette or the multi-purpose feeder.

## Printing Areas

Please note that the term "printing area" represents both the recommended area for optimum print quality and the entire area where the machine can technically print from your computer.

**Printing area (light shade):** Canon recommends that you print within this area.

### ■ Paper

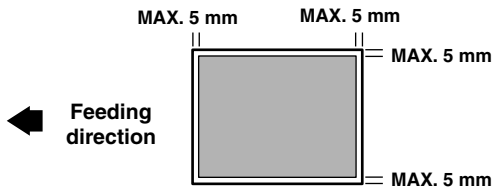

### ■ Envelope

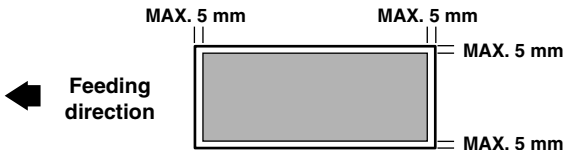

### NOTE

*Copying areas are a little larger than printing areas.*

# Loading Paper

This section describes how to load paper in the cassette and the multi-purpose feeder.

## CAUTION

- When loading paper, take care not to cut your hands on the edges of the paper.
- Be sure to completely remove the paper cassette from the machine and place on a flat surface before performing the following steps. Failure to do so, may cause the machine tip over, and result in personal injury.

## NOTE

- The paper in the multi-purpose feeder is fed prior to the paper in the cassette.
- The cassette holds up to approx. 250 sheets (FAX-L380S)/500 sheets (FAX-L390) of 64 g/m<sup>2</sup> paper or approx. 20 envelopes\*.

\*Only for the FAX-L380S model.

## Loading Paper in the Cassette

**1** Pull out the cassette completely.

**2** Pinch and slide the length slide guide to fit the size of the paper stack you want to load.

For the FAX-L390 model, attach the stopper of the paper size rear guide for the desired paper size by inserting the tabs into the matching slots on the paper cassette.

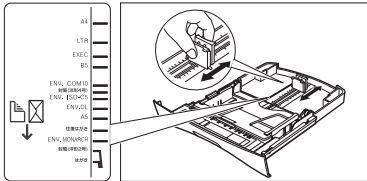

FAX-L380S

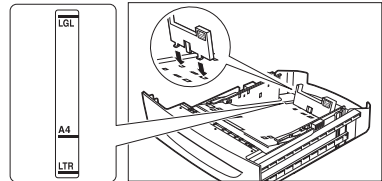

FAX-L390

## IMPORTANT

- If the slide guides (FAX-L380S) are not adjusted correctly for the size of the paper, the quality of your printouts may be adversely affected.
- For the FAX-L390 model, be sure to properly attach the stopper of the paper size rear guide for the correct paper size.

- 3** Adjust the width slide guides or paper width guides to match the paper size.

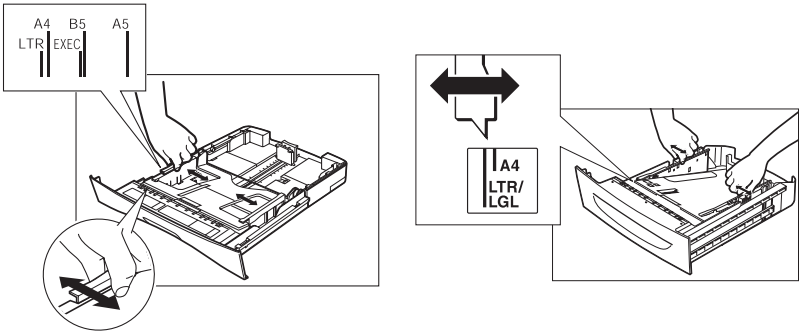

- 4** Fan the paper stack first, then tap the edges on a flat surface to even the stack.

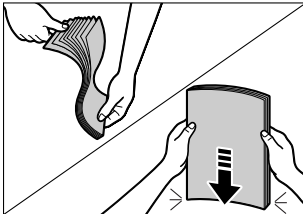

- 5** Load the paper stack in the cassette with the print side down.

When you load paper with a logo on, position the paper with the print side down (logo side) and load it so that the top of the paper feeds first in the cassette.

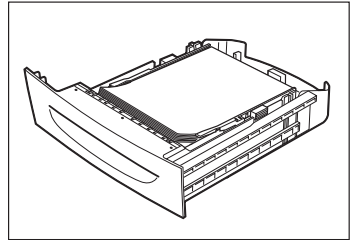
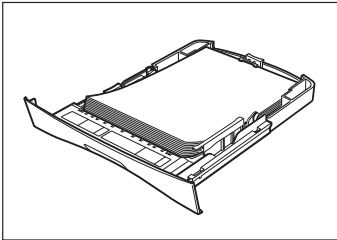

Make sure the paper stack does not exceed the load limit mark.

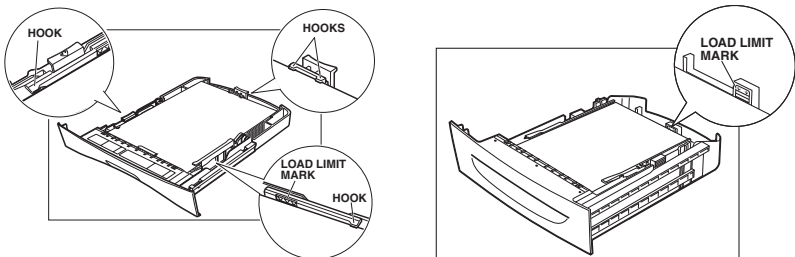

## 6 Insert the cassette into the machine.



### NOTE

If you do not completely insert the cassette into the machine, paper jams may occur.

## 7 Specify the paper size and type.

- Press [Menu] → [OK].
- Press [◀(-)] or [▶(+)] to select <1.CASSETTE> → press [OK] twice.
- Press [◀(-)] or [▶(+)] to select the appropriate paper size → press [OK] twice.
- Press [◀(-)] or [▶(+)] to select the appropriate paper type → press [OK].
- Press [Stop/Reset] to return to standby mode.



### IMPORTANT

- Do not load different size and type of paper at the same time.
- Do not load extra paper when there is still paper left in the cassette. If you load extra paper while printing, remove the loaded paper first. Then put it together with the extra paper and tap the edges. After that, reload it in the cassette.



### NOTE

- Select <ENVELOPE> for envelopes. For details on loading envelopes in the cassette, see "Loading Envelopes in the Cassette," on p. 4-5.
- For information on how to use non-standard size paper, see "Loading Paper in the Multi-Purpose Feeder," on p. 4-8, or "Loading an Envelope in the Multi-Purpose Feeder," on p. 4-9.

\*Only for the FAX-L380S model.

## Loading Envelopes in the Cassette



### NOTE

- Loading Envelopes in the Cassette is only for the FAX-L380S model.
- Load an envelope in the multi-purpose feeder when you use the FAX-L390 model. For details on loading an envelope in the multi-purpose feeder, see "Loading an Envelope in the Multi-Purpose Feeder," on p. 4-9.

## 1 Arrange the stack of envelopes on a firm, clean surface, and press down firmly on the edges to make the folds crisp.

Press all the way around the envelopes to remove any curls and expel air from inside the envelopes. Also, press firmly on the area that corresponds to the edges of the back flap.

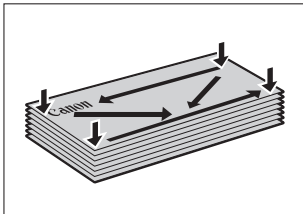

- 2** Remove any curling from the envelopes by holding the edges diagonally and bending them gently.

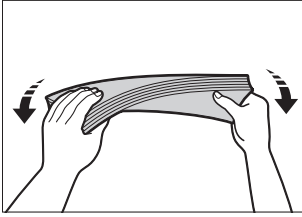

- 3** Run a pen or other rounded object along the back flaps to flatten them.

The flaps should not bulge more than 5 mm.

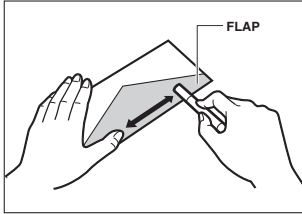

- 4** Tap the edges on a flat surface to even the envelopes.

- 5** Pull out the cassette completely.

- 6** Pinch and slide the length slide guide to fit the size of the envelopes you want to load.

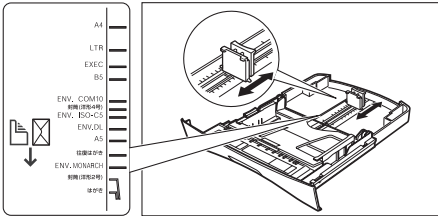

## IMPORTANT

*If the slide guides are not adjusted correctly for the size of the envelopes, the quality of your printouts may be adversely affected.*

## 7 Load the envelopes with the print side down and the right edge (i.e., closer to the stamp) first.

If the envelope to be loaded has a flap on the short edge, this edge must enter the machine first. Not loading it this way will result in a paper jam.

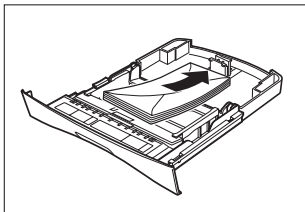

## 8 Pinch and slide the width slide guides to fit the envelopes.

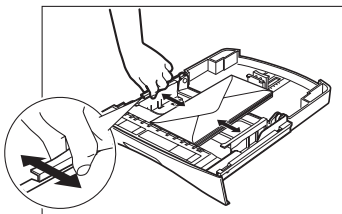

Make sure the envelopes do not exceed the load limit mark.

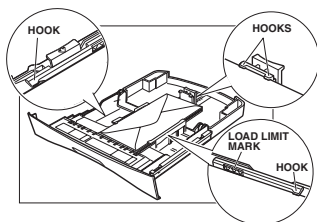

## 9 Insert the cassette into the machine.



### NOTE

*If you do not completely insert the cassette into the machine, paper jams may occur.*

## 10 Specify the paper size and type.

- Press [Menu] → [OK].
- Press [◀(-)] or [▶(+)] to select <1.CASSETTE> → press [OK] twice.
- Press [◀(-)] or [▶(+)] to select <ENVELOPE> → press [OK].
- Press [◀(-)] or [▶(+)] to select the appropriate envelope type → press [OK] twice.
- Press [◀(-)] or [▶(+)] to select <HEAVY PAPER> or <HEAVY PAPER H> → press [OK].
- Press [Stop/Reset] to return to standby mode.

# Loading Paper in the Multi-Purpose Feeder

Use the multi-purpose feeder when you want to copy or print on the different paper which is in the cassette. Load paper one by one in the multi-purpose feeder.

## NOTE

*The paper in the multi-purpose feeder is fed prior to the paper in the cassette.*

- 1** Slide the slide guides to fit the size of the paper you want to load.

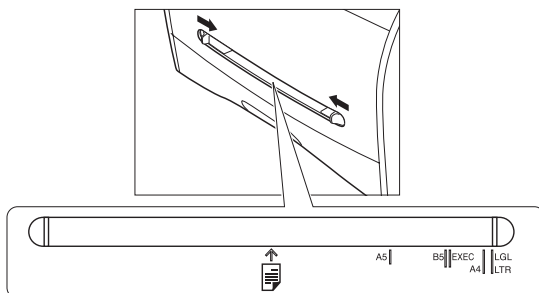

## IMPORTANT

*If the slide guides are not adjusted correctly for the size of the paper, the quality of your printouts may be adversely affected.*

- 2** Insert the paper straightly into the multi-purpose feeder with the print side up.

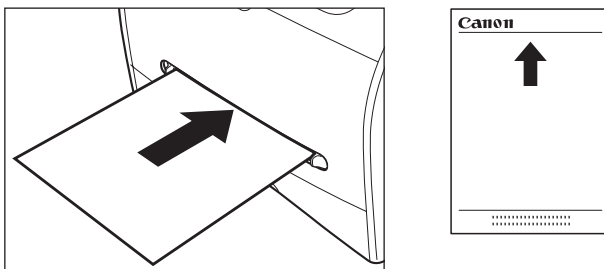

## NOTE

*When you load paper with a logo on it, position the paper with the print side up (logo side) and insert it so that the top of the paper feeds first in the multi-purpose feeder.*

### 3 Specify the paper size.

- Press [Menu] → press [OK].
- Press [◀(-)] or [▶(+)] to select <2.MP TRAY> → press [OK] twice.
- Press [◀(-)] or [▶(+)] to select the appropriate paper size → press [OK] twice.



#### NOTE

- Select <ENVELOPE> for envelopes. For details on loading an envelope in the multi-purpose feeder, see "Loading an Envelope in the Multi-Purpose Feeder," on p. 4-9.
- When <FREESIZE> is selected, you can specify vertical and horizontal sizes of the paper in the following ranges:
  - <VERTICAL SIZE>: 127 mm to 356 mm
  - <HORIZONTAL SIZE>: 76 mm to 216 mm

### 4 Specify the paper type.

- Press [◀(-)] or [▶(+)] to select the appropriate paper type → press [OK].
- Press [Stop/Reset] to return to standby mode.

## Loading an Envelope in the Multi-Purpose Feeder

Use the multi-purpose feeder when you want to copy or print an envelope one by one.



#### IMPORTANT

*The recommended envelopes are COM10, MONARCH, DL, and ISO-C5. Using other envelopes may affect the quality of the printout.*



#### NOTE

*The envelope in the multi-purpose feeder is fed prior to the paper in the cassette.*

### 1 Slide the slide guides to fit the size of the envelope you want to load.

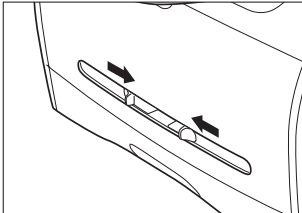



## IMPORTANT

If the slide guides are not adjusted correctly for the size of the envelope, the quality of your printouts may be adversely affected.

### 2 Insert the envelope straightly in the multi-purpose feeder with the print side up and the right edge (i.e., closer to the stamp) first.

If the envelope to be loaded has a flap on the short edge, this edge must enter the machine first. Not loading it this way will result in a paper jam.

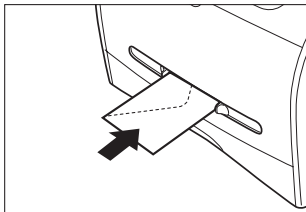

### 3 Specify the paper size.

- Press [Menu] → press [OK].
- Press [◀(-)] or [▶(+)] to select <2.MP TRAY> → press [OK] twice.
- Press [◀(-)] or [▶(+)] to select <ENVELOPE> → press [OK].
- Press [◀(-)] or [▶(+)] to select the appropriate envelope type → press [OK] twice.

### NOTE

You can select <FREESIZE> instead of <ENVELOPE> as the paper size. When <FREESIZE> is selected, you can specify vertical and horizontal sizes of the envelope in the following ranges:

- <VERTICAL SIZE>: 127 mm to 356 mm
- <HORIZONTAL SIZE>: 76 mm to 216 mm

### 4 Specify the paper type.

- Press [◀(-)] or [▶(+)] to select <HEAVY PAPER> or <HEAVY PAPER H> → press [OK].
- Press [Stop/Reset] to return to standby mode.

## Orientation of the Document and the Paper Loading

When you load a document in the ADF, the orientation of the document and the orientation of the paper in the cassette or in the multi-purpose feeder are as shown below.

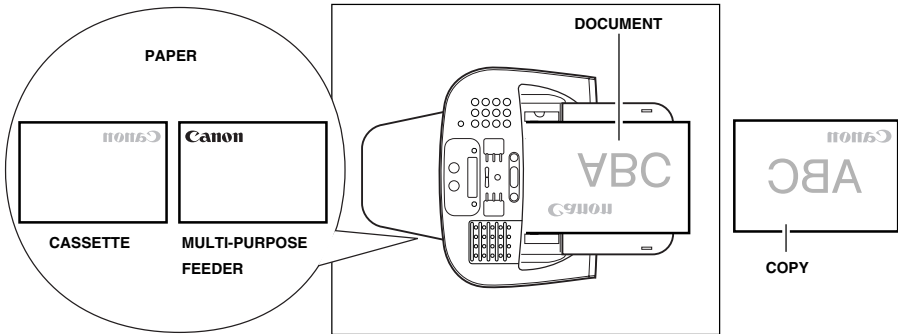

# Selecting the Paper Output Area

Face down paper output delivers paper with the printed side down on the output tray. Face up paper output delivers paper with the printed side up out of the face up paper output. Select the area depending on your purpose by opening or closing the rear cover.

Open the rear cover for face up paper output, or close the rear cover for face down paper output.

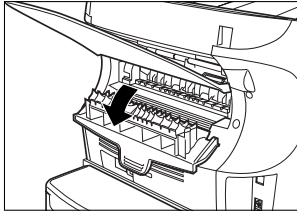

## IMPORTANT

*Do not open or close the rear cover while copying and printing.*

## Paper Type and Paper Output Area

Select the suitable paper output area depending on the paper type and your purpose.

Paper Type	Paper Output Area	The Number of Output Sheets
Plain Paper L	face up	1 sheet
	face down	approx. 50 sheets (64 g/m <sup>2</sup> )
Plain Paper	face up	1 sheet
	face down	approx. 50 sheets (64 g/m <sup>2</sup> to 90 g/m <sup>2</sup> )
Heavy Paper	face up	1 sheet
	face down	approx. 30 sheets (91 g/m <sup>2</sup> to 105 g/m <sup>2</sup> )
Heavy Paper H	face up	1 sheet
	face down	approx. 30 sheets (106 g/m <sup>2</sup> to 128 g/m <sup>2</sup> )
Transparencies	face up	1 sheet
	face down	approx. 10 sheets

## Face Down Paper Output Area

The paper is delivered with the printed side down on the output tray.  
Paper is stacked in printed order.

Close the rear cover.

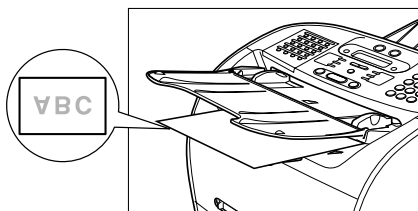

### IMPORTANT

- Do not place the delivered paper back on the output tray. Doing so may result in paper jams.
- Do not place objects other than paper on the output tray. Doing so may result in paper jams.
- It is recommended to fold up the document feeder when printing many pages.

## Face Up Paper Output Area

The paper is delivered with the printed side up out of the face up paper output on the back side of the machine. This way is convenient for printing on transparencies, envelopes, or labels which tend to curl, because the paper is delivered straight through out of the machine.

Open the rear cover.

- Remove the delivered paper one by one.

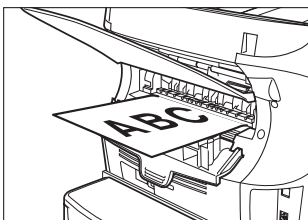

### IMPORTANT

- Do not pull the paper forcibly.
- The machine has no face up output tray. Remove the delivered paper with your hand.
- Do not place an object in front of the face up paper output to prevent a paper jam.

# Speed Dialing

# 5

## CHAPTER

This chapter describes how to register and use the speed dialing features of the machine.

## Speed Dialing Methods

---

In addition to regular dialing, the machine provides several ways to dial fax/telephone numbers automatically.

### ■ One-Touch Speed Dialing

Dial a fax/telephone number by pressing the One-Touch Speed Dial button that the number is assigned to.

### ■ Coded Speed Dialing

Dial a fax/telephone number by pressing [Coded Dial] followed by a two-digit code (a three-digit code for the FAX-L390 model) assigned to that number.

### ■ Group Dialing

Send a document to a pre-defined group of fax numbers. (The numbers must already be stored as One-Touch Speed Dialing numbers or Coded Speed Dialing numbers.)

### ■ Directory Dialing

Dial a fax/telephone number by pressing [Directory] and entering the first letter of the other party's name. In this manner you can search for the fax/telephone number registered for One-Touch Speed Dialing.

The following pages describe how to register numbers for speed dialing. You will also find instructions for changing numbers and names registered under speed dialing buttons and codes, and how to use speed dialing.

# One-Touch Speed Dialing

## Storing Numbers for One-Touch Speed Dialing

Your machine can store up to 31 fax numbers under One-Touch Speed Dial buttons. Follow this procedure to store One-Touch Speed Dialing numbers and names.

- 1** Press [Menu].
- 2** Use [◀(-)] or [▶(+)] to select <5.ADD. REGISTRATION> → press [OK] twice.
- 3** Press [◀(-)], [▶(+)], or the One-Touch Speed Dial button to select a One-Touch Speed Dial button under which you want to register a fax/telephone number between 01 and 31 → press [OK] twice.
  - If a number is already stored under the button you select, that number appears.
  - If the button you select is registered for Group Dialing, <GROUP DIAL> appears.

- 4** Use the numeric buttons to enter the telephone number (Max. 120 digits, including spaces and pauses) → press [OK] twice.

TEL NUMBER ENTRY	→	: A
TEL = 1 2 3 x x x x _		_

- For details on how to enter or delete numbers, see "Entering Numbers, Letters, and Symbols," on p. 3-1.
- Open the One-Touch Speed Dial panel → press [Space] to enter spaces between numbers (spaces are optional and are ignored during dialing).
- To enter a pause in the number, press [Redial/Pause] one or more times.

- 5** Use the numeric buttons to enter the name you want to store (Max. 16 letters, including spaces) → press [OK].

For details on how to enter or delete letters, see "Entering Numbers, Letters, and Symbols," on p. 3-1.

- 6** To continue registering numbers, repeat steps 3 to 5.

-or-

If you have finished registering numbers, press [Stop/Reset] to return to standby mode.

- 7** After you register a number for One-Touch Speed Dialing, it is recommended to write the name of the other party on a destination label and stick it on the One-Touch Speed Dial panel above the number of the One-Touch Speed Dial button where the number is registered.

# Changing or Deleting a Number/Name Stored Under a One-Touch Speed Dial Button

Follow these steps if you want to change a number and/or name registered under a One-Touch Speed Dial button, or if you want to delete all information stored under a button.

**1** Follow steps 1 and 2 of “Storing Numbers for One-Touch Speed Dialing.” (See p.5-2.)

**2** Use [◀(-)], [▶(+)], or the One-Touch Speed Dial button to select the One-Touch Speed Dial button you want to change or delete → press [OK] twice.

- To delete a number:

**3** Open One-Touch Speed Dial panel → press [Clear] to delete the number → press [OK].

TEL NUMBER ENTRY TEL=	→	1-TOUCH SPD DIAL 2 . NAME
--------------------------	---	------------------------------

- When you delete a number, the name registered for that number is also deleted.

**4** Press [Stop/Reset] to return to standby mode.

- To change the number and/or name:

**3** Open One-Touch Speed Dial panel → press [Clear] to delete the previous entry.

**4** Press the numeric buttons to enter the new number → press [OK] twice.

TEL NUMBER ENTRY TEL=124xxxx_	→	Canon Europa_ : a
----------------------------------	---	-------------------

- For details on how to enter or delete numbers, see “Entering Numbers, Letters, and Symbols,” on p. 3-1.
- If you want to delete a digit, press [◀(-)] or [▶(+)] to move the cursor under the digit you want to delete → press [Delete].
- If you only want to change the name, press [OK] twice after step 2 → open One-Touch Speed Dial panel → go to step 5.
- If you want to keep the same name, go to step 7.

**5** Press [Clear] to delete the previous entry.

**6** Press the numeric buttons to enter the new name → press [OK].

For details on how to enter or delete letters, see "Entering Numbers, Letters, and Symbols," on p. 3-1.

**7** To change additional numbers and/or names, repeat steps 2 to 6.

-or-

If you have finished changing numbers and/or names, press [Stop/Reset] to return to standby mode.

## Using One-Touch Speed Dialing

Once you have registered your numbers under One-Touch Speed Dial buttons, you can use them to send documents as follows:

**1** Load the document in the ADF.

For details on the types of documents you can fax, their requirements, and how to load documents, see "Document Requirements," on p. 6-1, and "Loading Documents in the ADF" on p. 6-3.

**2** Press [FAX].

If you are already in the Fax standby mode, you can skip this step.

**3** Adjust any necessary settings for your document.

- Press [Image Quality] to select the fax resolution. (See "Adjusting the Image Quality (Resolution)," on p. 6-4.)
- Press [Exposure] to select the scan density. (See "Adjusting the Exposure (Density)," on p. 6-5.)

**4** Press the One-Touch Speed Dial button assigned to the number to which you wish to fax.

TEL=	123xxxx
04	Canon U.K.

- The name registered under that One-Touch Speed Dial button is displayed. If no name is registered, the number registered under that button will be displayed.
- If you mistakenly press the wrong One-Touch Speed Dial button, press [Stop/Reset] → press the correct button.
- If no fax number is assigned to the One-Touch Speed Dial button you press, the LCD displays <NOT REGISTERED>. If this happens, make sure you press the correct button and that the number you want to dial is registered under that button.

**5** Press [Start].

- If you do not press [Start] within 5 seconds of pressing the One-Touch Speed Dial button, the machine will begin sending automatically. If you do not want the machine to send automatically, you need to change the <TIME OUT> setting. See p.16-9 for more details.
- If an error occurs during sending, the machine will print an error report. If this happens, try sending the fax again. See "Faxing Problems," on p. 14-15 for details about errors.

 **NOTE**

*You can also use One-Touch Speed Dialing to send a document to more than one location at a time. For details, see "Group Dialing," on p. 5-9, and "Sequential Broadcasting," on p. 6-13.*



# Coded Speed Dialing

## Storing Numbers for Coded Speed Dialing

You can store up to 100 numbers (169 numbers for the FAX-L390 model) for Coded Speed Dialing. Follow this procedure to store Coded Speed Dialing numbers and names.

- 1** Press [Menu].
- 2** Press [◀(-)] or [▶(+)] to select <5.ADD. REGISTRATION> → press [OK].
- 3** Press [◀(-)] or [▶(+)] to select <2.CODED SPD DIAL> → press [OK].
- 4** Press [◀(-)] or [▶(+)] to select a two-digit code (00-99)\* → press [OK] twice.
  - You can also select a code by pressing [Coded Dial] and entering the two-digit code\* with the numeric buttons.
  - If a number is already registered under the code you select, that number is displayed.
  - If the code you select is registered for group dialing, <GROUP DIAL> appears.

\*Select or enter a three-digit code (000 to 168) for the FAX-L390 model.

- 5** Use the numeric buttons to enter the telephone number (Max. 120 digits, including spaces and pauses) → press [OK] twice.

TEL NUMBER ENTRY TEL = 4 5 6 x x x x _	→	: A
---	---	-----

- For details on how to enter or delete numbers, see "Entering Numbers, Letters, and Symbols," on p. 3-1.
- Open the One-Touch Speed Dial panel → press [Space] to enter spaces between numbers (spaces are optional and are ignored during dialing).
- To enter a pause in the number, press [Redial/Pause] one or more times.

- 6** Use the numeric buttons to enter the name you want to store (Max. 16 letters, including spaces) → press [OK].

FAX-L380S Canon OPTICS	: A	→	CODED SPD DIAL *03 =
---------------------------	-----	---	-------------------------

FAX-L390 Canon OPTICS	: A	→	CODED SPD DIAL *003 =
--------------------------	-----	---	--------------------------

For details on how to enter or delete letters, see "Entering Numbers, Letters, and Symbols," on p. 3-1.

- 7** To continue registering numbers, repeat steps 4 to 6.

-or-

If you have finished registering numbers, press [Stop/Reset] to return to standby mode.

# Changing or Deleting a Number/Name Stored under a Coded Speed Dialing Code

Follow these steps if you want to change the number and/or name registered under a Coded Speed Dialing code, or if you want to delete all information stored under a code.

**1** Follow steps 1 to 3 of "Storing Numbers for Coded Speed Dialing." (See p.5-5.)

**2** Press [**◀(-)**] or [**▶(+)**] to select the code (00-99)\* you want to change or delete → press [**OK**] twice.

You can also select a code by pressing [Coded Dial] and entering the two-digit code\* with the numeric buttons.

\*Select or enter a three-digit code (000 to 168) for the FAX-L390 model.

- To delete a number:

**3** Open One-Touch Speed Dial panel → press [Clear] to delete the number → press [**OK**].



When you delete a number, the name registered for that number is also deleted.

**4** Press [Stop/Reset] to return to standby mode.

- To change the number and/or name:

**3** Open One-Touch Speed Dial panel → press [Clear] to delete the previous entry.

**4** Press the numeric buttons to enter the new number → press [**OK**] twice.



- For details on how to enter or delete numbers, see "Entering Numbers, Letters, and Symbols," on p. 3-1.
- If you want to delete a digit, press [**◀(-)**] or [**▶(+)**] to move the cursor under the digit you want to delete → press [Delete].
- If you only want to change the name, press [**OK**] twice after step 2 → open One-Touch Speed Dial panel → go to step 5.
- If you want to keep the same name, go to step 7.

**5** Press [Clear] to delete the previous entry.

## 6 Press the numeric buttons to enter the new name → press [OK].

FAX-L380S

Canon ITALIA	:A	→	CODED SPD DIAL *03=
--------------	----	---	------------------------

FAX-L390

Canon ITALIA	:A	→	CODED SPD DIAL *003=
--------------	----	---	-------------------------

For details on how to enter or delete letters, see "Entering Numbers, Letters, and Symbols," on p. 3-1.

## 7 To change additional numbers and/or names, repeat steps 2 to 6.

-or-

If you have finished changing numbers and/or names, press [Stop/Reset] to return to standby mode.

# Using Coded Speed Dialing

5

Speed Dialing

Once you have registered your numbers under Coded Speed Dialing codes, you can send documents as follows:

### 1 Load the document in the ADF.

For details on the types of documents you can fax, their requirements, and how to load documents, see "Document Requirements," on p. 6-1, and "Loading Documents in the ADF," on p. 6-3.

### 2 Press [FAX].

If you are already in the Fax standby mode, you can skip this step.

### 3 Adjust any necessary settings for your document.

- Press [Image Quality] to select the fax resolution. (See "Adjusting the Image Quality (Resolution)," on p. 6-4.)
- Press [Exposure] to select the scan density. (See "Adjusting the Exposure (Density)," on p. 6-5.)

### 4 Press [Coded Dial] → use the numeric buttons to enter the two-digit code\* assigned to the number to which you wish to fax.

\*Enter a three-digit code for the FAX-L390 model.

FAX-L380S

TEL= *	→	TEL= 456xxxx *04 Canon CANADA
-----------	---	----------------------------------

FAX-L390

TEL= *	→	TEL= 456xxxx *004 Canon CANADA
-----------	---	-----------------------------------

- The name registered under that Coded Speed Dialing code is displayed. If no name is registered, the number registered under that code will be displayed.
- If you mistakenly enter the wrong code, press [Stop/Reset] → [Coded Dial] → enter the correct code.
- If no fax number is assigned to the Coded Speed Dialing code you press, the LCD displays <NOT REGISTERED>. If this happens, make sure you enter the correct code and that the number you want to dial is registered under that code.

**5** Press [Start].

- If you do not press [Start] within 5 seconds of entering the Coded Speed Dialing code, the machine will begin sending automatically. If you do not want the machine to send automatically, you need to change the <TIME OUT> setting. See p.16-9 for more details.
- If an error occurs during sending, the machine will print an error report. If this happens, try sending the fax again. See "Faxing Problems," on p. 14-15 for details about errors.

**NOTE**

*You can also use Coded Speed Dialing to send a document to more than one location at a time. For details, see "Group Dialing," on p. 5-9, and "Sequential Broadcasting," on p. 6-13.*

# Group Dialing

Group dialing allows you to store as many as 130 numbers (199 numbers for the FAX-L390 model) under One-Touch Speed Dial buttons or Coded Speed Dialing codes.

## Creating Groups for Group Dialing

The numbers you register in a group must already be stored under One-Touch Speed Dial buttons or Coded Speed Dialing codes. Each group is stored under a One-Touch Speed Dial button or a Coded Speed Dialing code. Create groups for group dialing as follows:

**1** Press [Menu].

**2** Use [◀(-)] or [▶(+)] to select <5.ADD REGISTRATION> → press [OK].

**3** Use [◀(-)] or [▶(+)] to select <3.GROUP DIAL> → press [OK].

- To register a group under a One-Touch Speed Dial button:

**4** Use [◀(-)], [▶(+)], or the One-Touch Speed Dial button to select an unused One-Touch Speed Dial button (01 to 31) → press [OK] twice.

If a group or number is already registered under the button you select, <GROUP DIAL> or <1-TOUCH SPD DIAL> is displayed.

- To register a group under a Coded Speed Dialing code:

**4** Press [Coded Dial] → use the numeric buttons to enter an unused two-digit code (00-99)\* → press [OK] twice.

\*Enter a three-digit code (000 to 168) for the FAX-L390 model.

FAX-L380S  
GROUP DIAL  
\*21= → TEL =

FAX-L390  
GROUP DIAL  
\*021= → TEL =

- If a group or number is already registered under the code you select, <GROUP DIAL> or <CODED SPD DIAL> is displayed.
- To continue storing under a Coded Speed Dialing code, you can use [◀(-)] or [▶(+)] also.

 **NOTE**

- Each One-Touch Speed Dial button or Coded Speed Dialing code can store either a name and number for speed dialing, or a group. Be careful not to override speed dialing numbers and names when creating groups.
- If you wish to register a group under a One-Touch Speed Dial button or Coded Speed Dialing code already registered for speed dialing, or if you want to re-enter a group, you must delete the previous information first. See p. 5-3 for more details.

**5 Select the speed dialing numbers you want to register in the group → press [OK] twice.**

- To enter in the group a number stored under a One-Touch Speed Dial button, press the desired One-Touch Speed Dial button(s).
- To enter a number stored under a Coded Speed Dialing code, press [Coded Dial] → enter the two-digit code\* for the number using the numeric buttons. For multiple entries, press [Coded Dial] between each entry.

\*Enter a three-digit code for the FAX-L390 model.

 **NOTE**

- You cannot register numbers in the groups that have not been registered for One-Touch or Coded Speed Dialing.
- You can review the numbers registered under the group by pressing [◀(-)] or [▶(+)].

**6 Enter the name using the numeric buttons for the group (Max. 16 letters, including spaces) → press [OK].**

FAX-L380S

UK GROUP	: A	→	GROUP DIAL *22=
----------	-----	---	--------------------

FAX-L390

UK GROUP	: A	→	GROUP DIAL *022=
----------	-----	---	---------------------

For details on how to enter or delete letters, see "Entering Numbers, Letters, and Symbols," on p. 3-1.

**7 To enter additional groups, repeat steps 4 to 6.**

-or-

If you have finished registering groups, press [Stop/Reset] to return to standby mode.

## Changing or Deleting a Number/Name Stored under a Group Dialing

Follow these steps if you want to change or delete the number/name registered under a Group Dialing.

**1 Follow steps 1 to 3 of "Creating Groups for Group Dialing" (See p. 5-9.)**

- **To delete a number and a name:**

**2 Press [◀(-)] or [▶(+)] to select the number you want to delete → press [OK] twice.**
**3 Open One-Touch Speed Dial panel → press [Clear] to delete the numbers registered under the group.**

Press [◀(-)] or [▶(+)] to select the numbers you want to delete.

**4** Press [OK] twice.

**5** If you delete all the numbers registered under the group, press [Clear] to delete the name → press [OK].

**6** Press [Stop/Reset] to return to standby mode.

- To change the number and/or name:

**2** Press [◀(-)] or [▶(+)] to select the number you want to change → press [OK] twice.

**3** Press [Clear] to delete the numbers registered under the group.

**4** Select the speed dialing numbers you want to register in the group → press [OK] twice.

- To enter in the group a number stored under a One-Touch Speed Dial button, press the desired One-Touch Speed Dial button(s).
- To enter a number stored under a Coded Speed Dialing code, press [Coded Dial] → enter the two-digit code\* for the number using the numeric buttons. For multiple entries, press [Coded Dial] between each entry.

\*Enter a three-digit code for the FAX-L390 model.



#### NOTE

- You cannot register numbers in the groups that have not been registered for One-Touch or Coded Speed Dialing.
- You can review the numbers registered under the group by pressing [◀(-)] or [▶(+)].

**5** Press [Clear] to delete the name.

**6** Press the numeric buttons to enter the new name → press [OK].

For details on how to enter or delete letters, see "Entering Numbers, Letters, and Symbols," on p. 3-1.

**7** To change additional groups, repeat steps 2 to 6.

-or-

If you have finished registering groups, press [Stop/Reset] to return to standby mode.

# Using Group Dialing

To send a document to a group of numbers, follow these instructions.

## 1 Load the document in the ADF.

For details on the types of documents you can fax, their requirements, and how to load documents, see "Document Requirements," on p. 6-1, and "Loading Documents in the ADF" on p. 6-3.

## 2 Press [FAX].

If you are already in the Fax standby mode, you can skip this step.

## 3 Adjust any necessary settings for your document.

- Press [Image Quality] to select the fax resolution. (See "Adjusting the Image Quality (Resolution)," on p. 6-4.)
- Press [Exposure] to select the scan density. (See "Adjusting the Exposure (Density)," on p. 6-5.)

## 4 Enter the group(s) stored under a One-Touch Speed Dial button(s) and/or Coded Speed Dialing code(s).

FAX-L380S

TEL=GROUP DIAL  
03 Canon GROUP

TEL=GROUP DIAL  
\*21 UK GROUP

FAX-L390

TEL=GROUP DIAL  
03 Canon GROUP

TEL=GROUP DIAL  
\*021 UK GROUP

- If you make a mistake when selecting a group, press [Stop/Reset] → start again.
- The name registered under that One-Touch Speed Dial button or Coded Speed Dialing code is displayed.
- If you press a One-Touch Speed Dial button or Coded Speed Dialing code that has no group (or fax number) registered under it, the LCD displays <NOT REGISTERED>. Make sure you press the correct One-Touch Speed Dial button or enter the correct Coded Speed Dialing code, and that the group you want has been registered correctly under that button or code.
- After entering the first One-Touch Speed Dial button or Coded Speed Dialing code, you have 5 seconds to enter another speed dialing button or code before the machine begins sending automatically. If you have entered more than one speed dialing button or code, the machine waits for 10 seconds before it begins sending. If you do not want the machine to send automatically, you need to change the <TIME OUT> setting. See p.16-9 for more details.

## 5 Press [Start].

The machine then scans the document into memory, and begins dialing the numbers in the groups.



# Directory Dialing

Directory dialing allows you to look up the other party's name you registered and retrieve the number for dialing. This feature is convenient when you know the other party's name but can not recall the One-Touch Speed Dial button, the code for Coded Speed Dialing, or Group Dialing where the number is registered.

## 1 Press [FAX].

If you are already in the Fax standby mode, you can skip this step.

## 2 Press [Directory].



<NOT REGISTERED> appears if there are no numbers registered, and the display returns to dial entry mode.

## 3 Press a numeric button to enter the first letter of the name of the party you are searching for.

For example, if you want to search for a name that starts with the letter "H", press [4 (GHI)] twice.

## 4 Press [OK].

- Entries starting with the letter you entered are displayed.
- If there is no entry that starts with the letter you entered, entries that start with the next letter will be displayed.

## 5 Press [◀(-)] or [▶(+)] to display the other names.

- Pressing [▶(+)] displays the names of other parties in alphabetical order.  
Pressing [◀(-)] displays them in reverse order.
- When you reach the last name, the display returns to the first name.

## 6 Press [OK].

The other party's fax number and name, or <GROUP DIAL> and the group's name appear.

# Sending Faxes

# 6

## CHAPTER

This chapter describes how to use your machine to send faxes.

## Preparing to Send a Fax

### Document Requirements

The documents you load into the machine must meet the following requirements.

When loading a multi-page document:

Size:	Max.: 216 × 356 mm
(W × L)	Min.: 148 × 105 mm
Quantity:	Up to 50 A4-size, 50 LTR-size, or 20 LGL-size sheets (1 sheet for sizes other than these)
Thickness:	0.07–0.13 mm (For sheets thicker than this, load 1 sheet at a time)
	All sheets should be of the same thickness.
Weight:	50–105 g/m <sup>2</sup>
	All sheets should be of the same weight.

When loading a single-page document:

Size:	Max.: 216 mm × approx. 1 m
(W x L)	Min.: 148 × 105 mm
Quantity	1 sheet
Thickness	0.06 – 0.23 mm
Weight:	50 – 240 g/m <sup>2</sup>

**■ Problem documents**

- To prevent paper jams in the Automatic Document Feeder (ADF), do not use any of the following paper in the machine:



WRINKLED OR  
CREASED PAPER



CURLED OR  
ROLLED PAPER



TORN PAPER

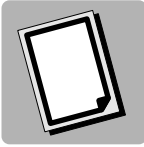

CARBON PAPER OR  
CARBON-BACKED  
PAPER

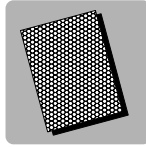

COATED PAPER

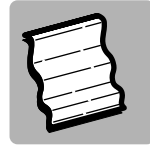

ONION SKIN OR  
THIN PAPER

- Remove all staples, paper clips, or any other fasteners before loading the document into the Automatic Document Feeder (ADF).
- Make sure any glue, ink, or correction fluid on the paper is completely dry before loading the document into the Automatic Document Feeder (ADF).
- If you have a document that will not feed into the machine properly, make a photocopy of the document, then load the copy instead.

**Scanning Area**

The margins shown in the illustration below are outside the machine's scanning area. Make sure your document's text and graphics do not extend into these margins.

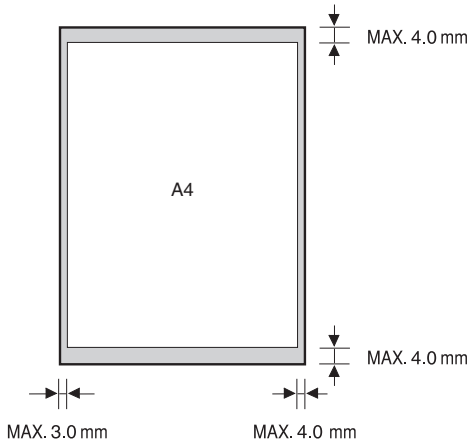

# Loading Documents in the ADF

- 1** Fan the edges that will feed into the machine first, then tap the edges of multiple page documents on a flat surface to even the stack.

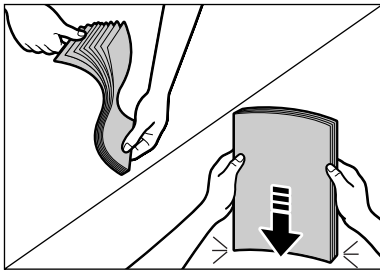

- 2** Adjust the document guides to the width of the document.

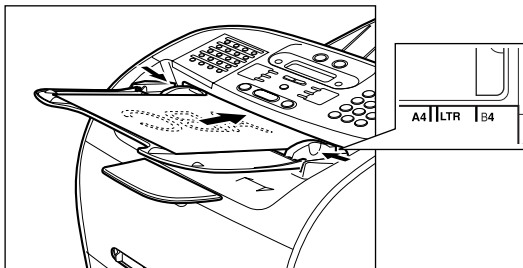

- 3** Load the document in the ADF.

The document is now ready for scanning.



## NOTE

- For multiple page documents, the pages are fed one by one from the top of the stack (from the first page).
- Wait until all pages of your document have been scanned before starting a new job.
- 50 sheets of A4-size documents can be set in the ADF. If more than 50 sheets of A4-size documents are set in the ADF, paper jams may occur.

## ● Trouble With Multipage Documents

- If you have any trouble in feeding a multipage document, do the following:

**1** Remove the stack and tap it on a flat surface to even the edges.

**2** Gently insert the stack into the Automatic Document Feeder (ADF) until it stops.

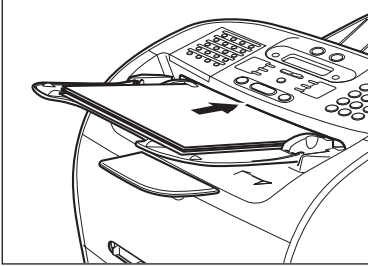

### NOTE

- If you have further trouble with page jams while feeding, see "Removing Jammed Paper from the ADF," on p. 14-7.
- Wait until all pages of your document have been scanned completely before starting a new job.

## Adjusting the Resolution and Contrast

### ***Adjusting the Image Quality (Resolution)***

Canon's Ultra High Quality (UHQ™) imaging technology enables you to send faxes with a print quality that is very close to that of the original document. The machine also lets you adjust the resolution it uses in sending faxes to best suit your particular document.

The machine has 5 resolution settings:

- <STANDARD> is adequate for most text documents.
- <FINE> is suitable for documents with fine print (smaller than the print in this sentence).
- <PHOTO> is for documents that contain photographs. With this setting, areas of the document that contain photos are automatically scanned with 256 levels of gray, rather than just two (black and white). This gives a much better reproduction of the photos, though transmission time is longer.
- <SUPER FINE> is for documents that contain fine print and images (much smaller than the print in this sentence), and its resolution is four times of <STANDARD>.
- <ULTRA FINE> is for documents that contain fine print and images (much smaller than the print in this sentence), and its resolution is eight times of <STANDARD>.

### NOTE

*Fax transmission time will vary depending on what resolution setting is set.*

Set the resolution as follows:

---

**1** Press [FAX].

If you are already in the Fax standby mode, you can skip this step.

**2** Press [Image Quality].

The LCD display shows the current resolution setting.

**3** Press [Image Quality] repeatedly until the resolution you want is displayed → press [OK].



**4** Continue the operation you wish to complete.

If you do not proceed with any other operation, the LCD display returns to standby mode.

## Adjusting the Exposure (Density)

You can adjust the lightness/darkness of the document pages before you scan for sending.

You can select the scanning density from the following:

- <LIGHT> for documents with dark text or color.
- <STANDARD> for normal printed or written text.
- <DARK> for documents with light text or color.

---

**1** Press [FAX].

If you are already in the Fax standby mode, you can skip this step.

**2** Press [Exposure].

The LCD display shows the current exposure setting.

**3** Press [Exposure] repeatedly until the scanning density you want is displayed → press [OK].

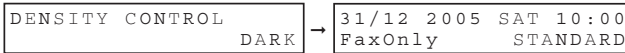

**4** Continue the operation you wish to complete.

If you do not proceed with any other operation, the LCD display returns to standby mode.

 **NOTE**

- You can set the scanning density so that the desired scanning density such as STANDARD is automatically returned after the <AUTO CLEAR> function activates or documents are scanned. Since <SCAN DENSITY> of <FAX DEFAULT> is set to 'OFF' in the factory default setting, the scanning density set using [Exposure] will remain unchanged. (See Chapter 16, "The Menu System.")
- You can set the level of each scanning density (LIGHT/STANDARD/DARK) in the <DENSITY CONTROL> of the Menu. (See Chapter 16, "The Menu System.")

## Sending Methods

### 6

#### Sending Faxes

### **Memory Sending**

To use memory sending, you load the document, dial the fax number → press [Start]. See p. 6-8 for more details on memory sending.

Since the machine is multitasking, you can even scan a document into the memory while sending a document, receiving a document, or printing a report.

### **Manual Sending Via the Handset\***

Use manual sending via the handset if you want to speak with the other party before sending a fax to them. With manual sending via the handset, dial and converse normally, and when they are ready to receive your fax, press [Start] to begin sending. See p. 6-9 for more details on manual sending via the handset.

For manual sending via the handset, you need to have the optional handset or a telephone connected to your machine.

\* With optional handset or other telephone connected. This feature is available for certain countries only.

## Dialing Methods

There are several ways of dialing the number of the party you want to send to:

### ■ Regular Dialing

Use the numeric buttons to dial the recipient's fax number.

### ■ One-Touch Speed Dialing

Press the One-Touch Speed Dial button (1 to 31) under which you have registered the number you want to send to. See Chapter 5, "Speed Dialing," for details on registering and using One-Touch Speed Dialing.

### ■ Coded Speed Dialing

Press [Coded Dial] → enter the two-digit code (00-99)\* under which you have registered the number you want to send to. See Chapter 5, "Speed Dialing," for details on registering and using Coded Speed Dialing.

\*Enter a three-digit code (000 to 168) for the FAX-L390 model.

### ■ Group Dialing

Send a document to a pre-defined group of fax numbers. (The numbers must already be stored as One-Touch Speed Dialing numbers or Coded Speed Dialing numbers.) See Chapter 5, "Speed Dialing," for details on registering and using Group Dialing.

### ■ Directory Dialing

Press [Directory] → enter the first letter of the other party's name and retrieve the number for dialing. See Chapter 5, "Speed Dialing," for details on how to use Directory Dialing.



# Sending Documents

This section describes the different ways to send faxes with the machine.

## Memory Sending

You should normally use memory sending to send documents efficiently. If <MEMORY FULL> is displayed, the machine cannot scan the documents. In this case, wait for the machine to send any faxes stored in the memory, then scan the documents.



### NOTE

*You can register a new fax job while the machine is waiting to redial the other party's number automatically. For details on how to set the machine to redial automatically, see "Automatic Redialing With Memory Sending," on p. 6-11.*

Follow this procedure for memory sending:

### 1 Load the document in the ADF.

For details on the types of documents you can fax, their requirements, and how to load documents, see "Document Requirements," on p. 6-1, and "Loading Documents in the ADF," on p. 6-3.

### 2 Press [FAX].

If you are already in the Fax standby mode, you can skip this step.

### 3 Adjust any necessary settings for your document.

- Press [Image Quality] to select the fax resolution. (See "Adjusting the Image Quality (Resolution)," on p. 6-4.)
- Press [Exposure] to select the scan density. (See "Adjusting the Exposure (Density)," on p. 6-5.)

### 4 Dial the other party's fax/telephone number.

For details on the different dialing methods, see "Dialing Methods," on p. 6-7.

### 5 Press [Start].



### NOTE

*To cancel memory sending, press [Stop/Reset]. (See Chapter 12, "System Monitor.")*

## Manual Sending Via the Handset\*

Use manual sending when you want to talk to the other party before sending a document, or if the other party does not have a fax machine that can receive automatically.



### NOTE

*You will need to connect a telephone to the machine if you want to talk to the other party before sending a document.*

\* With optional handset or other telephone connected. This feature is available for certain countries only.

Follow this procedure for manual sending:

---

### **1** Load the document in the ADF.

For details on the types of documents you can fax, their requirements, and how to load documents, see "Document Requirements," on p. 6-1, and "Loading Documents in the ADF," on p. 6-3.

### **2** Press [FAX].

If you are already in the Fax standby mode, you can skip this step.

### **3** Adjust any necessary settings for your document.

- Press [Image Quality] to select the fax resolution. (See "Adjusting the Image Quality (Resolution)," on p. 6-4.)
- Press [Exposure] to select the scan density. (See "Adjusting the Exposure (Density)," on p. 6-5.)

### **4** Pick up the handset.

### **5** Dial the other party's fax/telephone number.

For details on the different dialing methods, see "Dialing Methods," on p. 6-7.

### **6** Talk through the handset to the other party.

If you hear a high-pitched signal instead of the other party's voice, go to step 8.

### **7** Ask the other party to set their fax machine to receive faxes.

### **8** When you hear a high-pitched signal, press [Start] → hang up the handset.



### NOTE

*To cancel manual sending, press [Stop/Reset].*

# Canceling Sending

## Canceling Memory Sending

### *While Documents Are Being Scanned Using the ADF*

**1** Press [Stop/Reset].  
Scanning is canceled.

**2** Remove the document from the ADF.  
For details on how to remove documents, see "Removing Jammed Paper from the ADF," on p. 14-7.

### *After All Documents Are Scanned*

**1** While documents are being sent, press [Stop/Reset].  
The machine asks you to confirm that you want to cancel.

CANCEL DURING TX/RX?
< YES NO >

**2** Press [◀(-)] to cancel sending.

- If you change your mind and want to continue sending, press [▶(+)] for <NO>.
- The machine prints an ERROR TX REPORT if a transmission report is set to print automatically. (See "1.TX REPORT," on p. 16-7.)

# Redialing

## Manual Redialing

To redial the last number dialed with the numeric buttons, press [Redial/Pause].

To cancel manual redialing, press [Stop/Reset] → [◀(-)].

## Automatic Redialing With Memory Sending

With memory sending, you can set the machine to automatically dial the fax number again if the receiving fax machine does not answer or if the line is busy. You can also control how many times the machine will redial the number and how long it will wait between dialing attempts. See "Setting Up Automatic Redialing\*," on p. 6-11.

### Canceling Automatic Redialing

If you press [Stop/Reset] when waiting to redial, the LCD displays standby mode but you are still in automatic redialing. To cancel redialing while the machine is waiting to redial, follow the procedure described in "Deleting a Fax Job," on p. 12-2. To cancel while the machine is redialing, do the following:

- Wait until the machine begins redialing.
- Press [Stop/Reset] → [◀(-)].



#### NOTE

*The machine can print a list of document stored in memory (DOCUMENT MEMORY LIST), along with the transaction number of each document. The document waiting to be sent using automatic redialing will be listed as <TRANSMIT>. To print the list, see "Document Memory List," on p. 13-14.*

### Setting Up Automatic Redialing\*

You can set up the following options for automatic redialing:

- Whether or not the machine redials automatically
- The number of times the machine attempts redialing
- The time interval between redialing attempts

\*The default settings for the auto redial feature vary depending on the country. For details, see Appendix C, "Country-Specific Features."

Follow the procedure below to adjust the automatic redialing settings.

- 1** Press [Menu].
- 2** Press [◀(-)] or [▶(+)] to select <4.FAX SETTINGS> → press [OK].
- 3** Press [◀(-)] or [▶(+)] to select <3.TX SETTINGS> → press [OK].
- 4** Press [◀(-)] or [▶(+)] to select <3.AUTO REDIAL> → press [OK].
- 5** Press [◀(-)] or [▶(+)] to select <ON> to enable automatic redialing or <OFF> to disable it → press [OK].
  - If you selected <ON>: Go to step 6.
  - If you selected <OFF>: Go to step 8.

AUTO REDIAL ON	→	AUTO REDIAL 1.REDIAL TIMES
-------------------	---	-------------------------------

- 6** Press [OK] again → use [◀(-)], [▶(+)], or the numeric buttons to enter the number of times you want the machine to redial → press [OK] twice.

REDIAL TIMES 02TIMES	→	REDIAL INTERVAL 02MIN.
-------------------------	---	---------------------------

- 7** Press [◀(-)], [▶(+)], or the numeric buttons to select the time interval between redialings → press [OK].

REDIAL INTERVAL 02MIN.	→	TX SETTINGS 4.TIME OUT
---------------------------	---	---------------------------

- 8** Press [Stop/Reset] to return to standby mode.

# Sequential Broadcasting

## Sending a Document to More Than One Destination

The machine's sequential broadcasting feature allows you to send a fax to a sequence of up to 141 fax numbers (210 fax numbers for the FAX-L390 model), using any combination of dialing methods as follows:

- One-Touch Speed Dialing: up to 31 destinations
- Coded Speed Dialing: up to 100 destinations (169 destinations for the FAX-L390 model)
- Regular dialing and redialing: 10 destinations  
(with the numeric buttons or [Redial/Pause])

You can enter the One-Touch Speed Dialing and Coded Speed Dialing destinations in any order. You can also include one destination that you dial manually using the numeric buttons or [Redial/Pause]. Be sure to press [OK] after your entry with the numeric keys.

To send a fax to more than one location, do the following:

---

### **1** Load the document in the ADF.

For details on the types of documents you can fax, their requirements, and how to load documents, see "Document Requirements," on p. 6-1, and "Loading Documents in the ADF," on p. 6-3.

### **2** Press [FAX].

If you are already in the Fax standby mode, you can skip this step.

### **3** Adjust any necessary settings for your document.

- Press [Image Quality] to select the fax resolution. (See "Adjusting the Image Quality (Resolution)," on p. 6-4.)
- Press [Exposure] to select the scan density. (See "Adjusting the Exposure (Density)," on p. 6-5.)

#### 4 Enter up to 141 destinations (210 destinations for the FAX-L390 model) using any of the following methods:

##### ● One-Touch Speed Dialing:

- Press the desired One-Touch Speed Dial button(s).

##### ● Coded Speed Dialing:

- Press [Coded Dial] → enter the two-digit code (00-99)\* using the numeric buttons.
  - \*Enter a three-digit code (000 to 168) for the FAX-L390 model.
  - Be sure to press [Coded Dial] before each code.

##### ● Directory Dialing:

- Press [Directory] → enter the first letter of the name of the party you are searching for.

##### ● Regular Dialing:

- Enter the number using the numeric buttons or [Redial/Pause].
  - Be sure to press [OK] after your entry with the numeric keys.

#### NOTE

- If you make a mistake on regular dialing, open One-Touch Speed Dial panel → press [Delete] or [◀(-)] to delete the last digit, or press [Clear] to delete an entire entry when you use the numeric buttons.
- After entering the first One-Touch Speed Dial button or Coded Speed Dialing code, you have 5 seconds to enter another speed dialing button or code before the machine begins sending automatically. If you have entered more than one speed dialing button or code, the machine waits for 10 seconds before it begins sending. If you do not want the machine to send automatically, you need to change the <TIME OUT> setting. See p. 16-9 for more details.
- If you want to review the numbers you entered, use the [◀(-)] or [▶(+)] to scroll through the numbers.

#### 5 Press [Start].

The machine then scans the document into memory, and begins sending it to the destinations in numerical order, starting with the One-Touch Speed Dialing numbers, then the Coded Speed Dialing numbers, and finally the numbers dialed with the numeric buttons or [Redial/Pause].

#### NOTE

- If the machine memory becomes full while scanning your document, <MEMORY FULL> appears in the LCD display. If this happens, remove the remainder of the document from the Automatic Document Feeder (ADF). Then divide the document into several sections and send each section separately.
- Only one broadcasting job will be active at any given time.
- To cancel sending, press [Stop/Reset] → follow the instructions in the LCD display. When you press [Stop/Reset], sending to all recipients will be canceled. You cannot cancel sending to only one recipient. (See Chapter 12, "System Monitor.")

## Sending a Document Using Group Dialing

If you frequently send faxes to the same group of people, you can create a "group." Groups are stored under One-Touch Speed Dial buttons or Coded Speed Dialing codes. See Chapter 5, "Speed Dialing," for details on registering numbers under groups and using Group Dialing.

# Delayed Sending

Your machine allows you to scan a document into its memory and send it automatically at a preset time. By using this feature, you can take advantage of lower long distance rates at night, for example. You can set up to 141 destinations (210 destinations for the FAX-L390 model) and up to 20 reservations for delayed sending.

## 1 Load the document in the ADF.

For details on the types of documents you can fax, their requirements, and how to load documents, see "Document Requirements," on p. 6-1, and "Loading Documents in the ADF," on p. 6-3.

## 2 Press [FAX].

If you are already in the Fax standby mode, you can skip this step.

## 3 Adjust any necessary settings for your document.

- Press [Image Quality] to select the fax resolution. (See "Adjusting the Image Quality (Resolution)," on p. 6-4.)
- Press [Exposure] to select the scan density. (See "Adjusting the Exposure (Density)," on p. 6-5.)

## 4 Open One-Touch Speed Dial panel → press [Delayed Transmission].

## 5 Use the numeric buttons to enter the time at which you want to send the document → press [OK].

DELAYED TX TX TIME SETTING 10:00	→	TEL =
-------------------------------------	---	-------

Enter the time using the 24-hour clock system. Precede single digits with a zero.

Example:

9:30 a.m. = 09:30

4:30 p.m. = 16:30



## 6 Enter the destination(s) using any of the following 4 methods.

### ● One-Touch Speed Dialing:

- Press the desired One-Touch Speed Dial button(s).

### ● Coded Speed Dialing:

- Press [Coded Dial] → enter the two-digit code (00-99)\* using the numeric buttons.  
\*Enter a three-digit code (000 to 168) for the FAX-L390 model.
  - Be sure to press [Coded Dial] before each code.

### ● Directory Dialing:

- Press [Directory] → enter the first letter of the name of the party you are searching for.

### ● Regular Dialing:

- Enter the number using the numeric buttons or [Redial/Pause].
  - You can enter 10 numbers.
  - Be sure to press [OK] after your entry with the numeric buttons.

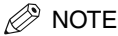

### NOTE

*If you make a mistake on regular dialing, open One-Touch Speed Dial panel → press [Delete] or [◀(-)] to delete the last digit, or press [Clear] to delete an entire entry when you use the numeric buttons.*

## 7 Press [Start].

The machine scans the document into memory.

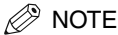

### NOTE

- If the machine memory becomes full while scanning your document, <MEMORY FULL> appears in the LCD display. If this happens, you cannot send the document at a delayed time.
- You can only register one preset sending operation at a time.
- The machine is a multitasking machine, so you can send, receive, print, and copy other documents even when you have set the machine for delayed sending.
- To print, copy, or send other documents after setting the machine for delayed sending, simply follow the procedures described in this User's Guide.
- To cancel a delayed sending, see "Deleting a Fax Job," on p. 12-2.
- The machine can print a list of document stored in memory (DOCUMENT MEMORY LIST), along with the transaction number of each document. The document to be sent using delayed sending will be listed as <DELAYED TX> or <DEL SQ BDCST>. To print the list, see "Document Memory List," on p. 13-14.

When the set time comes, the machine dials and sends the document.

# Receiving Faxes

# 7

## CHAPTER

This chapter describes how to use your machine to receive faxes.

## Different Ways to Receive a Fax

The machine provides you with 4 different modes for receiving faxes. To decide which mode will best suit your requirements, consider how you want to use the machine:

Receive Mode	Main Use	Operation	Requirements
FaxOnly*	Fax	Answers all calls as fax calls. It receives faxes automatically and disconnects voice calls.	Separate telephone line for fax use only.
FaxTel	Fax/Tel	Automatically switches between fax calls and voice calls. Receives faxes automatically and rings for voice calls. To set the details see p. 7-2.	Telephone connected to the machine.
Manual	Tel	Rings for every call, whether it is a fax call or a voice call. For a fax call, you have to manually activate reception of the fax.	Telephone connected to the machine.
AnsMode	Fax/Tel	Receives faxes automatically and routes voice calls to the answering machine.	Answering machine connected to the machine.

\* Factory default setting

You can confirm which receive mode is set by checking the standby display. The receive mode is displayed in the lower left of the LCD.

## Setting the Receive Mode

Set the machine receive mode as follows:

**1** **Open One-Touch Speed Dial panel → press [Receive Mode].**

The LCD display shows the current receive mode setting.

**2** **If you want to change the receive mode, press [Receive Mode] repeatedly until the mode you want appears → press [OK].**

Each time you press [Receive Mode], the receive mode changes in the following order:

FaxOnly → Manual → AnsMode → FaxTel → FaxOnly → ...

## Receiving Faxes and Phone Calls Automatically: FaxTel Mode

Set this mode if you want your machine to automatically switch between voice and fax calls.

You can control precisely how your machine handles incoming calls by adjusting the settings below.

### *Setting the Options for FaxTel Mode*

■ **RING START TIME**

When a call comes in, the machine checks to see if it is a person wishing to speak to you or a fax machine trying to send a document. If your machine does not have enough time to detect the fax tone, it assumes the call is from a telephone. Use the <RING START TIME> setting to increase the time the machine takes to check whether a call is from a fax machine or a telephone. You can select a time between 0 and 30 seconds; the default is 8 seconds.

■ **F/T RING TIME**

When your machine is set to receive both fax and telephone calls automatically, the telephone rings to alert you to pick up the handset if the call is from a person. If you do not pick up the handset within a certain amount of time, the telephone stops ringing. Use this option to change the number of times the machine rings, from 10 to 60 seconds. The default is 22 seconds.

■ **F/T SWITCH ACTION**

Not all fax machines are capable of sending a fax tone (the CNG tone that warns the receiving fax machine that a fax is coming). For those cases the machine may think that the call coming in is a voice call and rings to alert you of the call (the amount of time it is going to ring is determined by the <F/T RING TIME> setting above). If you do not answer the call, one of two things can happen:

1. If you set the <F/T SWITCH ACTION> to 'RECEIVE', the machine will switch to fax receive mode automatically at that point and start to receive the document. If no document comes in, it disconnects the call after approx. 40 seconds. The factory default setting is 'RECEIVE'.
2. If you set the <F/T SWITCH ACTION> to 'DISCONNECT', the machine will disconnect the phone call immediately freeing up your phone line at this point.

# What Happens When FaxTel Mode is Selected

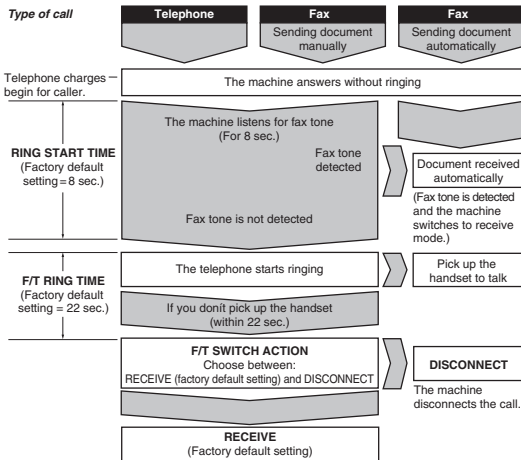

Not all fax machines are capable of sending a fax tone. For those cases if you set the <F/T SWITCH ACTION> to RECEIVE, the machine switches to receive mode automatically and starts receiving the document. If no document comes in, it disconnects after approx. 40 seconds.

Set the FaxTel Mode options as follows:

- 1 Press [Menu].
- 2 Press [◀(-)] or [▶(+)] to select <4.FAX SETTINGS> → press [OK].
- 3 Press [◀(-)] or [▶(+)] to select <4.RX SETTINGS> → press [OK].
- 4 Press [◀(-)] or [▶(+)] to select <2.FAX/TEL OPT. SET> → press [OK] twice.
- 5 Press [◀(-)] or [▶(+)] to set the time the machine waits before ringing when it receives a call → press [OK] twice.



You can use the numeric buttons instead of using [◀(-)] or [▶(+)] to set the time.

- 6** Press [**◀(-)**] or [**▶(+)**] to set the time the machine rings while waiting for someone to pick up the handset → press [**OK**] twice.

F/T RING TIME 030SEC	→	F/T SWITCH ACTION RECEIVE
-------------------------	---	------------------------------

You can use the numeric buttons instead of using [**◀(-)**] or [**▶(+)**] to set the time.

- 7** Press [**◀(-)**] or [**▶(+)**] to select **<RECEIVE>** or **<DISCONNECT>** → press [**OK**].

F/T SWITCH ACTION DISCONNECT	→	RX SETTINGS 3.INCOMING RING
---------------------------------	---	--------------------------------

This setting tells the machine what to do if no one picks up the handset within the specified ring time set in step 6.

- 8** Press [**Stop/Reset**] to return to standby mode.

 **NOTE**

*The default settings and selectable settings vary depending on the current country selection.*

## Receiving Faxes Manually: Manual Mode

To use this mode, you must have the optional handset or a telephone connected to the machine. In Manual Mode, the machine rings every time it receives a call, whether the call is from a telephone or a fax machine.

 **NOTE**

*Make sure the **<REMOTE RX>** setting in the **<RX SETTINGS>** menu is enabled. See p. 16-11 for details.*

If you use your machine with Manual Mode, answer incoming calls as follows:

- 1** When the optional handset or the telephone rings, pick up the receiver.

● **If you hear a person's voice:**

- Start your conversation. If the caller wants to send a document after talking to you, ask them to press the start button on their fax machine. When you hear a beep, press [**Start**] to begin receiving the document, then hang up.

● **If you hear a slow beep or silence:**

- A fax machine is trying to send you a document.  
Press [**Start**] on the machine, then hang up.  
-or-  
Enter the two-digit ID code from the telephone, then hang up.

- The machine then begins receiving the document. (This is particularly convenient if your telephone is located away from the machine.)
- If you do not hang up after pressing [Start] or the two-digit ID code, the machine beeps intermittently after you receive the document. (You can turn the beeping off by disabling the <OFFHOOK ALARM> in the <USER SETTINGS> menu. See p. 16-7 for details.)



## NOTE

*If you have an answering machine connected to your machine that can carry out remote-control operations (controlling your answering machine from a remote telephone), the security code for this function may be the same as the two-digit ID code described above. If so, make sure you change the machine two-digit ID code to make it distinct from the answering machine's security code. See p. 16-11 for details on changing the code (<REMOTE RX ID> setting).*

## Receiving Faxes Automatically: FaxOnly Mode

When the machine is set up for a dedicated line, set FaxOnly Mode to automatically receive documents whenever a call comes over the fax line.

- The machine assumes all incoming calls are from fax machines sending documents. It receives the documents automatically and disconnects all voice calls.
- In FaxOnly Mode, you can control whether or not the machine rings when it receives a fax call. To set this option from the machine operation panel, see p. 16-10 (<INCOMING RING> setting).

## Using an Answering Machine: AnsMode

Connecting an answering machine to the machine allows you to receive faxes and phone messages while you are out of the office.



## NOTE

*Canon does not recommend using an "answering service" (like those offered by local telephone companies that provide voice mail) on the telephone line you are connecting to the machine. If you do subscribe to an answering service, you may want to dedicate a separate line for fax communication only and connect that line to the machine.*

### **Using the Machine With an Answering Machine**

Follow these guidelines when using the machine with an answering machine:

- Set the answering machine to answer on the first or second ring.
- If the machine runs out of paper or toner in AnsMode, it receives all faxes into memory. The faxes then print automatically when you add paper or replace the toner cartridge.
- When recording the outgoing message on the answering machine:
  - The entire message must be no more than 15 seconds long.
  - In the message, tell your callers how to send a fax. For example:

"Hello. I can't answer the phone right now. If you would like to send a fax, press the start button on your fax machine. Thank you."

# Receiving Faxes in Memory When a Problem Occurs

The machine will automatically receive incoming faxes into its memory if it encounters a problem that prevents it from printing normally. The LCD will display <RECEIVED IN MEMORY> and a message showing the problem. See below the error messages, their cause and the action you need to take to correct the problem.



## NOTE

- The machine memory can store up to approx. 510 A4-size pages\*.
- Once the pages are printed, they are deleted from memory.
- If the memory becomes full, you will not be able to receive the remaining pages. Contact the other party and ask them to resend the remaining pages of the fax.

If the machine receives a document into its memory, the LCD displays one of the following messages. These messages show the action you must take to correct the problem.

**Cause:** The toner cartridge ran out of toner or is not installed properly.

**Action:** Make sure the cartridge is installed properly, and install a new one if necessary. See “Installing/Replacing the Toner Cartridge,” on p. 2-18.

REPLACE CARTRIDGE

**Cause:** The machine ran out of paper.

**Action:** Add paper to the paper cassette/the multi-purpose feeder. See “Loading Recording Paper,” on p. 2-21.

SUPPLY REC. PAPER

**Cause:** A paper jam occurred.

**Action:** Clear the jam. See “Clearing Jams,” on p. 14-1.

REC. PAPER JAM

OPEN PRINTER COVER

**Cause:** Over capacity on the output tray.

**Action:** Take out sheets from output tray and clear the paper jam. See “Clearing Jams,” on p. 14-1.

Once you have corrected the problem, the machine automatically prints the documents stored in memory.

\* Based on Canon FAX Standard Chart No.1, standard mode

## Receiving While Performing Other Tasks

Since the machine is a multitasking device, it can receive faxes and phone calls while you are entering your user information, making copies, or printing.

If you receive a fax while you are making copies or printing, the machine stores the incoming fax in memory. Then, as soon as you finish making copies or printing, the machine automatically prints the fax. If you are entering registration information, the fax is printed as soon as it is received, and does not go into memory.

## Canceling an Incoming Fax

To cancel an incoming fax, follow this procedure:

- 1 Press [Stop/Reset].

CANCEL	DURING	TX/RX?
< YES		NO >

- 2 Press [◀(-)] to [Stop/Reset] receiving, or [▶(+)] to resume receiving the fax.



# 8

## CHAPTER

# Setting Up and Using Polling

This chapter shows you how to set up and use polling sending and receiving. Polling is useful when the sending party cannot be in the office at the same time.

## What's Polling?

Polling means a fax calls another fax and requests the other fax to send a document that it is holding. Unlike normal sending and receiving, in polling the receiver always calls the sender. This is called polling to receive a document. The sender sends the document in response to the polling by a telephone call from the receiver.



### NOTE

*Your fax can be set up to function in both roles. Your fax can poll to receive a document, or it can be polled to send a document that it is holding.*

## Before You Use Polling Receiving

Before you try to set up polling, note the following points:

- With one operation you can poll several faxes. You can dial up to 141 telephone numbers (210 telephone numbers for the FAX-L390 model) and poll those faxes to receive documents that they are holding.
- If the other party is using a Canon fax machine which has the Polling ID function, ask them to set the Polling ID of their fax machine to 255 (1111 1111 binary number). For details on the Polling ID, see the other party's fax machine manual. In all other cases the Polling ID is not a concern.

# Polling Other Fax Machines to Receive Documents

The machine polling feature allows you to request a document to be faxed to you from another fax machine. The sender only needs to make sure the document is on his fax machine and ready to be sent: when your machine polls that machine, the document is sent automatically. The machine can poll any fax machine that supports polling.

## Requesting Another Fax to Send a Document

### 1 Press [FAX].

If you are already in the Fax standby mode, you can skip this step.

### 2 Open One-Touch Speed Dial panel → press [Polling].

### 3 Use [◀(-)] or [▶(+)] to select <2.POLLING RX> → press [OK].

POLLING 2 . POLLING RX	→	TEL =
---------------------------	---	-------

### 4 Enter the destination(s) using any of the following 4 methods.

#### ● One-Touch Speed Dialing:

- Press the desired One-Touch Speed Dial button(s).

#### ● Coded Speed Dialing:

- Press [Coded Dial] → enter the two-digit code (00-99)\* using the numeric buttons.  
\*Enter a three-digit code (000 to 168) for the FAX-L390 model.  
Be sure to press [Coded Dial] before each code.

#### ● Directory Dialing:

- Press [Directory] → enter the first letter of the name of the party you are searching for.

#### ● Regular Dialing:

- Enter the number using the numeric buttons or [Redial/Pause].
  - You can enter 10 numbers.
  - Be sure to press [OK] after your entry with the numeric buttons.



### NOTE

If you make a mistake, open One-Touch Speed Dial panel → [Delete] to delete the last number, or press [Clear] to delete all numbers you entered when you use the numeric buttons.

### 5 Press [OK].

# Setting Up Polling Sending

This section shows you how to set up your fax to store and hold a document until it is polled by another fax to send it.

## Setting Up a Polling Box

Before you can use polling sending, you must create a polling box with the <POLLING BOX> of the Menu. The polling box holds the document in the memory until the other party prompts (polls) your fax to send the document, or until you delete the document (see p. 8-6).

- 1** Press [Menu].
- 2** Press [◀(-)] or [▶(+)] to select <4.FAX SETTINGS> → press [OK].
- 3** Press [◀(-)] or [▶(+)] to select <6.POLLING BOX> → press [OK].
- 4** Press [◀(-)] or [▶(+)] to select <1.SETUP FILE> → press [OK].
- 5** Press [◀(-)] or [▶(+)] to select <1.FILE NAME> → press [OK].
- 6** Enter a file name for the polling box (up to 24 characters including spaces) using the numeric buttons → press [OK].

CANON TOKYO	: A	→	SETUP FILE 2 . PASSWORD
-------------	-----	---	----------------------------

- For details on how to enter or delete letters, see "Entering Numbers, Letters, and Symbols," on p. 3-1.
- The message <DATA ENTRY OK> appears on the LCD display for a few seconds.

- 7** Press [◀(-)] or [▶(+)] to select <2.PASSWORD> → press [OK].

If you do not want to set a password, go to step 9.

- 8** Enter a password (up to 7 digits) using the numeric buttons → press [OK].

PASSWORD	<u>1</u> 2 3 4 5 6 7	→	SETUP FILE 3 . ERASE AFTER TX
----------	----------------------	---	----------------------------------

 **NOTE**

- This password protects your polling box settings from unauthorized access. To change these settings later, you will have to enter this password.
- For details on how to enter or delete numbers, see "Entering Numbers, Letters, and Symbols," on p. 3-1.

**9** Press [**◀(-)**] or [**▶(+)**] to select **<3.ERASE AFTER TX>** → press [**OK**].

SETUP FILE 3 .ERASE AFTER TX	→	ERASE AFTER TX ON
---------------------------------	---	----------------------

**10** Press [**◀(-)**] or [**▶(+)**] to select **<ON>** or **<OFF>** → press [**OK**].

- **<ON>**:The document in the polling box is erased after it is sent in response to a polling request from another fax machine.
- **<OFF>**:The document in the polling box is not erased after it is sent. Select this setting if you expect that the document will be polled by more than one fax machine.

ERASE AFTER TX OFF	→	POLLING BOX 2 .CHANGE DATA
-----------------------	---	-------------------------------

**11** Press [**Stop/Reset**] to return to standby mode.

## Scanning a Document into the Memory for Polling Sending

8

Setting Up and Using Polling

Follow this procedure to store a document in the polling box. The document remains in the polling box so that other fax machines can poll it. To use polling sending, you have to previously create a polling box.

**1** Load the document in the ADF.

For details on the types of documents you can fax, their requirements, and how to load documents, see "Document Requirements," on p. 6-1, and "Loading Documents in the ADF" on p. 6-3.

**2** Press [**FAX**].

If you are already in the Fax standby mode, you can skip this step.

**3** Adjust any necessary settings for your document.

- Press [**Image Quality**] to select the fax resolution. (See "Adjusting the Image Quality (Resolution)," on p. 6-4.)
- Press [**Exposure**] to select the scan density. (See "Adjusting the Exposure (Density)," on p. 6-5.)

**4** Open One-Touch Speed Dial panel → press [**Polling**].

**5** Press [**OK**].

The document is scanned into the polling box.

## Changing the Polling Box Settings

Follow this procedure to change the settings of a polling box.

- 1** Press [Menu].
- 2** Press [◀(-)] or [▶(+)] to select <4.FAX SETTINGS> → press [OK].
- 3** Press [◀(-)] or [▶(+)] to select <6.POLLING BOX> → press [OK].
- 4** Press [◀(-)] or [▶(+)] to select <2.CHANGE DATA> → press [OK].
- 5** Enter the password (up to 7 digits) using the numeric buttons → press [OK].

If you have not previously set a password, skip this step, and go to step 6.

CHANGE DATA PASSWORD       *****	→	CHANGE DATA 1.FILE NAME
-------------------------------------	---	----------------------------

For details on how to enter or delete numbers, see "Entering Numbers, Letters, and Symbols," on p. 3-1.

- 6** Press [◀(-)] or [▶(+)] to display the setting you want to change → press [OK].

To change the settings for an item, follow the same procedure you used for the initial setup of the polling box. (See "Setting Up a Polling Box," on p. 8-3.)



### NOTE

- To change the password, you have to first enter the old password (it is not displayed as you enter it) → press [OK] → enter a new password (it is displayed as you enter it) → press [OK].
- If you forget your password, your machine will require service to disable this feature.

- 7** When you are finished making changes, press [Stop/Reset] to return to standby mode.

## Deleting a Polling Box

Follow this procedure to cancel a polling box.

### NOTE

*You cannot cancel a polling box when the polling box is holding a document for polling sending.*

- 1** Press [Menu].
- 2** Press [◀(-)] or [▶(+)] to select <4.FAX SETTINGS> → press [OK].
- 3** Press [◀(-)] or [▶(+)] to select <6.POLLING BOX> → press [OK].
- 4** Press [◀(-)] or [▶(+)] to select <3.DELETE FILE> → press [OK].
- 5** Enter the password (up to 7 digits) using the numeric buttons → press [OK].

If you have not previously set a password, skip this step, and go to step 6.

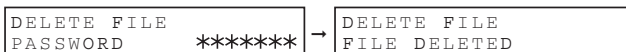

For details on how to enter or delete numbers, see “Entering Numbers, Letters, and Symbols,” on p. 3-1.

The polling box is deleted.

### NOTE

*If there is any document stored in the polling box, you cannot delete the polling box and the message <CANNOT DELETE> appears on the LCD display. If you want to delete the polling box, delete the document stored in the polling box first, then perform the procedure described above. For details on how to delete documents stored in memory, see “Deleting a Fax Job,” on p. 12-2.*

- 6** Press [Stop/Reset] to return to standby mode.

# Restricting the Use of the Machine

# 9

## CHAPTER

This chapter describes how to protect the machine from unauthorized access. Some of these features also enable you to keep track of fax transactions and copy (printing) based on division numbers that you can assign to individuals or sections inside your company.

## Setting and Using the System Administrator's ID and Password

---

The system administrator's ID and password protect all the settings in the SYSTEM SETTINGS menu. You need to enter the System Administrator's ID and password when you are using Department ID management and want to operate the machine as the System Administrator. In this case, you do not need to enter the System Administrator's password when accessing the SYSTEM SETTINGS menu. Otherwise, you need to enter the System Administrator's password every time you enter the SYSTEM SETTINGS menu.



### IMPORTANT

*If you fail to create and safeguard the System Administrator's ID and password, anyone can open the System Settings menu and change or disable the settings.*



### NOTE

*The user restrictions registered in your machine will be printed at the end of the USER'S DATA LIST. (See "User's Data List," on p. 13-11.)*

## Setting the System Administrator's ID and Password

Follow this procedure to set the System Administrator's ID and password.

- 1 Press [Menu].
- 2 Press [◀(-)] or [▶(+)] until <8.SYSTEM SETTINGS> appears → press [OK] three times.
- 3 Enter a System Administrator's ID of up to seven digits (from 1 to 9999999) using the numeric keys → press [OK].

SYS. ADMIN. ID 1 2 3 4 5 6 7	→	SYS. ADMIN. INFO 2 . SYSTEM PASSWORD
---------------------------------	---	---

- 4 Press [OK].
- 5 Enter a System Administrator's password of up to seven digits (from 1 to 9999999) using the numeric keys → press [OK].

SYSTEM PASSWORD
-----------------

- 6 Record the System Administrator's ID and password, and store it in a safe location.

### NOTE

*You need to enter the System Administrator's ID and password when you are using Department ID management and want to operate the machine as the System Administrator. In this case, you do not need to enter the System Administrator's password when accessing the <SYSTEM SETTINGS> menu. Otherwise, you need to enter the System Administrator's password every time you enter the <SYSTEM SETTINGS> menu.*

- 7 Press [Stop/Reset] to return to standby mode.

## Changing/Canceling the System Administrator's ID and Password

Follow this procedure to change or cancel the System Administrator's ID and password.

- 1 Press [Menu].
- 2 Press [◀(-)] or [▶(+)] until <8.SYSTEM SETTINGS> appears → press [OK].

SYSTEM SETTINGS PASSWORD    _
----------------------------------



- 3** Enter the current System Administrator's password using the numeric keys → press [OK] three times.  
The password you entered is displayed with asterisks.

```
SYSTEM SETTINGS
PASSWORD      *****
```

 → 

```
SYS. ADMIN. ID
              1234567
```

The current password is displayed.

- 4** Open One-Touch Speed Dial panel.

- 5** Press [Clear] to cancel or change the System Administrator's ID.

If you are canceling the System Administrator's ID, press [OK] → Proceed to step 7.

```
SYS. ADMIN. INFO
2. SYSTEM PASSWORD
```



#### NOTE

*When you cancel the System Administrator's ID, the system password is also canceled.*

- 6** Enter a new System Administrator's ID and password of up to seven digits (from 1 to 9999999) using the numeric keys → press [OK].

For details about entering the System Administrator's ID and password, refer to steps 5 to 7 of "Setting the System Administrator's ID and Password," on p. 9-2.

The new password is displayed as you enter it.

```
SYSTEM PASSWORD
              7654321
```

 → 

```
SYSTEM SETTINGS
2. DEPT. ID MANAGEMNT
```

- 7** Press [Stop/Reset] to return to standby mode.

# Restricting Machine Operation (Department ID Management)

This section describes how to restrict the operations of the machine. By storing a Department ID and Password for each department, you can set the machine so that its functions can be used only after the correct password has been entered. This is called "Department ID Management." Department IDs and Passwords can be stored. This function allows you to check the print totals and fax scan totals for each department, for management purposes.



## NOTE

*The user restrictions registered in your machine will be printed at the end of the USER'S DATA LIST. (See "User's Data List," on p. 13-11.)*

## Setting Operation Restrictions

You can create up to 100 Department IDs and passwords to restrict sending operations on the machine. Follow this procedure to restrict the access to all of these features:

- Sending documents
- Copying documents, and manually printing fax reports and documents received/stored in memory

**1**

Press [Menu].

**2**

Press [◀(-)] or [▶(+)] until the <8.SYSTEM SETTINGS> appears → press [OK].

The display for entering the System Administrator's password appears if you set the Department ID management. (See "Setting and Using the System Administrator's ID and Password," on p. 9-1.)



## NOTE

*If you forget your password, your machine will require service to disable this feature.*

- 3** If the prompt <PASSWORD> is displayed, enter the System Administrator's password using the numeric keys → press [OK].

```
SYSTEM SETTINGS
PASSWORD      *****
```

- 4** Press [◀(-)] or [▶(+)] until <2.DEPT. ID MANAGEMNT> appears → press [OK].

- 5** Press [◀(-)] or [▶(+)] to display <ON> → press [OK] twice.

- 6** Press [◀(-)] or [▶(+)] to select the number to which the department will be designated → press [OK].

- 7** Enter the Department ID of up to seven digits using the numeric keys → press [OK].

```
DEPT. ID ENTRY      DEPT. ID SETUP
1 2 3 4 5 6 7      1 . PASSWORD
```



#### NOTE

- You can set the Department ID from 1 to 9999999. If you set the Department ID as '111', it will be shown as <0000111>. When you are requested to enter the Department ID, however, it is sufficient to enter '111'.
- You can delete the numbers you entered by pressing [Clear].

- 8** Press [◀(-)] or [▶(+)] until <1. PASSWORD> appears → press [OK].

- 9** Enter the password for the department of up to seven digits using the numeric keys → press [OK].

```
PASSWORD           DEPT. ID SETUP
1 2 3 4 5 6 7      2 . COPY LIMITS
```



#### NOTE

- If you do not want to enter a password so you can use only the Department ID for transactions, just press [OK] → proceed to the next step.
- If you set only the Department ID, you have to enter only the Department ID when you operate the machine.

- 10** Press [OK].

- 11** Enter the maximum number of pages that can be copied or printed by the registered department using the numeric keys → press [OK].

```
COPY LIMITS
1 0 0 0 0 0
```



#### NOTE

- You can set the copy limit from 0 to 999999.
- If you set the copy limit to 0, no copying operation can be performed by the department.

**12** If you want to set the transmission limits, press [◀(-)] or [▶(+)] until <3. TX LIMITS> appears → press [OK].

**13** Enter the maximum number of pages that can be sent by the registered department using the numeric keys → press [OK].

TX LIMITS	1 0 0 0 0 0
-----------	-------------

 **NOTE**

- You can set the TX limit from 0 to 999999.
- If you set the TX limit to 0, no transmission can be performed by the department.

**14** Repeat steps 7 to 12 to set restrictions for other Department IDs and passwords.

**15** When you are finished, press [Stop/Reset] to return to standby mode.

 **NOTE**

*To operate the machine with restrictions 'ON', see "Operating the Machine with Restrictions ON," on p. 9-8.*

# Turning Restrictions OFF or ON

Follow this procedure to turn 'OFF' or 'ON' the printing, copying and sending restrictions temporarily without changing the Department ID Management settings.

**1** Press [Menu].

**2** Press [◀(-)] or [▶(+)] until <8.SYSTEM SETTINGS> appears → press [OK].

**3** If the prompt <PASSWORD> is displayed, enter the System Administrator's password using the numeric keys → press [OK].

```
SYSTEM SETTINGS
PASSWORD      *****)***)
```

**4** Press [◀(-)] or [▶(+)] until <2.DEPT. ID MANAGEMNT> appears → press [OK].

**5** Press [◀(-)] or [▶(+)] to display <ON> → press [OK].

**6** Press [◀(-)] or [▶(+)] until <3.RESTRICTIONS> appears → press [OK].

**7** Select the feature you want to turn 'OFF' or 'ON'.

● **To turn 'OFF' or 'ON' restricted printing:**

- Press [◀(-)] or [▶(+)] until <1. RESTRICT PRINTING> appears → press [OK].
- Press [◀(-)] or [▶(+)] to display <OFF> or <ON> → press [OK].



**NOTE**

*This setting turns 'OFF' or 'ON' the restriction for printing fax reports and documents stored in memory, and copying function.*

● **To turn 'OFF' or 'ON' restricted sending:**

- Press [◀(-)] or [▶(+)] until <2.RESTRICT TX> appears → press [OK].
- Press [◀(-)] or [▶(+)] to display <OFF> or <ON> → press [OK].

**8** Press [Stop/Reset] to return to standby mode.

# Operating the Machine with Restrictions ON

This section describes how to operate the machine with the operation restriction features set up and turned 'ON'.

**1** If you see the message <ENTER DEPT. ID> when the machine is in standby mode, the restriction is turned 'ON'. Enter the Department ID using the numeric keys → press [OK].

**2** If the message <DEPT. ID PASSWORD> is displayed, enter the Department password using the numeric keys → press [OK].

DEPT. ID PASSWORD *****	→	31/12 2005 SAT 15:11 FaxOnly STANDARD
----------------------------	---	--

**3** Continue operating the machine.

 **NOTE**

*To return to standby mode with the message <ENTER DEPT. ID>, press [ID].*

# Checking and Clearing the Counter Information

This section describes how to check and clear the counter information for each department.

**1** Press [Menu].

**2** Press [◀(-)] or [▶(+)] until <8.SYSTEM SETTINGS> appears → press [OK].

**3** If the prompt <PASSWORD> is displayed, enter the System Administrator's password using the numeric keys → press [OK].

```
SYSTEM SETTINGS
PASSWORD      *****)***)
```

**4** Press [◀(-)] or [▶(+)] until <2.DEPT. ID MANAGEMNT> appears → press [OK].

**5** Press [◀(-)] or [▶(+)] to display <ON> → press [OK].

```
DEPT. ID MANAGEMNT
ON
```

**6** Press [◀(-)] or [▶(+)] until <2.COUNT MANAGEMENT> appears → press [OK] twice.

● **To check the print counter:**

Press [◀(-)] or [▶(+)] until <1.PRINT COUNT> appears → press [OK].

```
Department ID
PRINT COUNT  1111111
0000001 / 1000000
Number of    Limit
Printed Pages
```



**NOTE**

If you have not set the TX limit, nothing will be displayed as "Limit." (See "Setting Operation Restrictions," on p. 9-4.)

Press [◀(-)] or [▶(+)] to scroll through the Department IDs.

● **To check the transmission counter:**

Press [◀(-)] or [▶(+)] until <2.SEND COUNT> appears → press [OK].

```
Department ID
SEND COUNT  1111111
0000001 / 1000000
Number of    Limit
Printed Pages
```

 **NOTE**

If you have not set the TX limit, nothing will be displayed as "Limit." (See "Setting Operation Restrictions," on p. 9-4.)

- Press [◀(-)] or [▶(+)] to scroll through the Department IDs.

**7** To reset the counter, press [Menu] twice → press [◀(-)] or [▶(+)] until <2.COUNT RESET> appears → press [OK].

**8** Press [◀(-)] or [▶(+)] to display <ON> or <OFF> → press [OK].

To reset the counter, select <1.ON>.

If you do not want to reset the counter, select <OFF>.

COUNT RESET
1 . ON

**9** Press [Stop/Reset] to return to standby mode.



# Special Features

# 10

## CHAPTER

This chapter describes the special features of the machine.

## Special Dialing

This section explains special dialing features, such as dialing through a switchboard and dialing international numbers.

### Dialing Through a Switchboard

A PBX (Private Branch Exchange) is an on-site telephone switchboard. If your machine is connected through a PBX or other telephone switching system, you have to dial the outside line access number first, and then dial the number of the party you are calling.

You can register the type of access and the outside line access number under [R], so that you only have to press [R] before dialing the number you wish to reach. Follow the instructions below to register [R].

#### ***Registering the Access Type and Outside Line Access Number Under the R button***

- 1** Press [Menu].
- 2** Press [◀(-)] or [▶(+)] to select <4.FAX SETTINGS> → press [OK] twice.
- 3** Press [◀(-)] or [▶(+)] to select <6.R-KEY SETTING> → press [OK].

- 4** Press [◀(-)] or [▶(+)] to select <PBX> → press [OK].

R - KEY SETTING PBX	→	PBX HOOKING
------------------------	---	----------------

- 5** Press [◀(-)] or [▶(+)] to select the access type of your switching system → press [OK].

- If you selected <HOOKING>, go to step 8:

If you selected <PREFIX>, go to step 6:

- 6** Press the numeric buttons to enter the outside line access number.

P R E F I X 1 2 3 4 5 6
----------------------------

For details on how to enter or delete numbers, see "Entering Numbers, Letters, and Symbols," on p. 3-1.

- 7** Press [Redial/Pause] to enter a pause → press [OK].

P R E F I X 1 2 3 4 5 6 P	→	F A X S E T T I N G S 2 . R E P O R T S E T T I N G S
------------------------------	---	--

#### NOTE

If you select <PREFIX>, you can set a number up to 20 digits long, including the "P" at the end.

- 8** Press [Stop/Reset] to return to standby mode.

## Dialing Long Distance

When you register a long distance number, you may have to insert a pause either within or after the number. For long distance dialing, the location and length of the pause may differ depending on the telephone system.

### ***How to Enter Pauses***

Use this procedure to enter pauses within or at the end of numbers.

- 1** During dialing registration, when you come to a step that asks you to enter a number for dialing, use the numeric buttons to enter the number.

- 2 To enter a pause within a number, press [Redial/Pause].**
- To enter a pause at the end of a number, press [Redial/Pause] → press [OK].
  - A pause entered within a number (p) is 4 seconds long.
  - If necessary, you can adjust the length of a pause within a number. See p. 16-8 (<PAUSE TIME> setting) for more details.
  - To make a longer pause within a number, press [Redial/Pause] again. Each pause adds 2 seconds to the length of the pause.
  - A pause at the end of a number (P) is fixed to 10 seconds.

## Using Tone Dialing On a Pulse Line

Even if you have a pulse line, the machine enables you to use tone dialing once you have connected to the number you are calling. This allows you to take advantage of many services that require tones, such as selecting options from telephone “touch-line” services.

---

**1 Press [FAX].**

If you are already in the Fax standby mode, you can skip this step.

**2 Lift the handset if you have installed the optional handset.**

-or-

Press [Hook].

The In Use/Memory indicator blinks green and you will hear the dial tone.

**3 Dial the telephone number using the numeric buttons.**

The machine connects using the pulses required by your phone line.

**4 Press [\*] to switch to tone dialing.**

- When [\*] is pressed, <T> is displayed in the LCD.
- Numbers entered after pressing [\*] will be dialed using tone dialing.

**5 When you have finished, hang up the handset.**

-or-

Press [Hook].

# Restricting Use of the Machine

If you do not want unauthorized people to be able to make calls, set the <LOCK PHONE> feature to 'ON'. Calls are restricted when you make calls using the handset or [Hook].

## Enabling Restriction of Your Machine

Follow this procedure to enable restriction of your machine.

- 1** Press [Menu].
- 2** Press [◀(-)] or [▶(+)] to select <4.FAX SETTINGS> → press [OK].
- 3** Press [◀(-)] or [▶(+)] to select <7.SYSTEM SETTINGS> → press [OK].
- 4** Press [◀(-)] or [▶(+)] to select <3.LOCK PHONE> → press [OK].
- 5** Press [◀(-)] or [▶(+)] to select <ON> → press [OK].

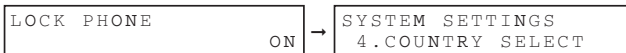

### NOTE

*The display contents differ depending on the country.*

- 6** Press [Stop/Reset] to return to standby mode.  
Restriction of the machine is now enabled. No one can make calls. (This setting does not restrict incoming calls or faxes.)

# Canceling Restriction of Your Machine

Follow this procedure to cancel restriction of your machine.

**1** Follow steps 1 to 4 of “Enabling Restriction of Your Machine,” on p. 10-4.

**2** Press [◀(-)] or [▶(+)] to select <OFF> → press [OK].



## NOTE

*The display contents differ depending on the country.*

**3** Press [Stop/Reset] to return to standby mode.

Restriction of the machine is now disabled. Anyone can make calls.

# Using Memory Lock

Normally, a document prints as soon as you receive it. However, there may be occasions when you want the machine to store all documents in memory until you are ready to print them. Locking the machine to receive and store all documents in memory is called "Memory Lock."

You may want to turn Memory Lock 'ON' when the machine is left unattended at night, or over long holidays, to prevent a large volume of printed documents from collecting in the paper output trays. After you return to the office, you can review the contents of the memory, and enter the memory lock password to print all of the documents stored in memory.

## Turning Memory Lock ON and Setting the Password

After Memory Lock is turned 'ON', the machine automatically enters the Memory Lock mode. The documents received when the machine is in the Memory Lock mode are stored in memory until you unlock the memory with a password and print them.

Follow this procedure to turn the Memory Lock 'ON', and define the password.

- 1** Press [Menu].
- 2** Press [◀(-)] or [▶(+)] to select <4.FAX SETTINGS> → press [OK].
- 3** Press [◀(-)] or [▶(+)] to select <7.SYSTEM SETTINGS> → press [OK].
- 4** Press [◀(-)] or [▶(+)] to select <1.MEMORY LOCK RX> → press [OK].
- 5** Press [◀(-)] or [▶(+)] to select <ON> → press [OK].
- 6** Press [◀(-)] or [▶(+)] to display the desired Memory Lock setting → press [OK].

The MEMORY LOCK RX menu includes the following items:

Setting	Description
1.MEM LOCK PASSWORD	0 to 9999999  This password protects the Memory Lock settings. Setting a password is recommended. You must use this password to unlock the memory so you can print documents stored in memory.  Use the numeric buttons to enter a password (up to seven digits) → press [OK].
2.REPORT	Sets the machine to print reports. This setting affects only reports that print automatically, such as an Activity Report.
<b>OUTPUT NO</b>	No report prints while in the Memory Lock mode.
OUTPUT YES	A report prints while the machine is in the Memory Lock mode.

The factory default setting is in **bold** face.

- 7** Press [Stop/Reset] to return to standby mode.

## Turning Memory Lock OFF and Printing Documents

Follow this procedure to turn the Memory Lock 'OFF' and print the documents received in memory.

- 1** When the Memory Lock mode is 'ON', the message <MEMORY LOCK RX> is displayed on the LCD.

- 2** Follow the steps 1 to 5 of "Turning Memory Lock ON and Setting the Password" on p. 10-6 to turn the Memory Lock 'OFF'.

If you have not set the memory lock password (see step 6 in "Turning Memory Lock ON and Setting the Password" on p. 10-6), the LCD display shows <2.FAX DEFAULT>. The setting is completed and the documents received in memory are printed.

- 3** If a memory lock password has been set, enter the memory lock password using the numeric keys → press [OK].

When you press [OK], all the documents received in memory while the machine was in the Memory Lock mode are printed. The memory lock mode is deactivated.

If you forget your password, your machine will require service to disable this feature.

# Making Copies

This chapter describes how to make copies with your machine.

## Making Copies

One of the machine's convenient features is its ability to make up to 99 high-quality copies of a document. To make copies, do the following:

---

**1 Load the document in the ADF.**

For details on how to place or load documents, see "Loading Documents in the ADF" on p. 6-3.

**2 Press [COPY].**

If you are already in the Copy standby mode, you can skip this step.

**3 Use the numeric buttons to enter the number of copies.**

You can set up to 99 copies.

**4 Adjust any necessary settings for your document.**

- Press [Image Quality] to select the scanning resolution. (See "Adjusting the Image Quality (Resolution)," on p.11-6.)
- Press [Exposure] to select the scanning exposure. (See "Adjusting the Exposure (Density)," on p.11-6.)
- Press [Enlarge/Reduce] to select the copy ratio. (See "Setting Enlarging/Reducing," on p.11-4.)

**5 Press [Start].**



**NOTE**

*To cancel copying, press [Stop/Reset].*



# Specifying the Paper Size and Type (Common for Cassette and Multi-Purpose Feeder)

## NOTE

- When making copies on A4-size paper after having continuously copied on paper smaller than A4-size paper, the copies may be dirty. To prevent copies from being dirty, wait about 1 minute before making copies.
- The paper in the multi-purpose feeder is fed prior to the paper in the cassette.
- The settings changed in the Menu do not return automatically to the settings you set previously. Change to the previous settings again if necessary.
- When making copies of a small size or heavy paper\*, etc., the copy speed may be slightly slower than usual.  
\* The paper type should be selected in the Menu.
- If you intend to make a copy and print with a thermal transfer printer using the same sheet of paper, make the copy first. Failure to do so may make copies dirty or cause a paper jam.
- When copying onto transparencies, remove each transparency from the output tray as it is output.

## Specifying the Paper Size

At the factory, the paper size has already been set to <A4>. Normally, you can make copies in this setting. When making copies on other sizes of paper, you need to specify the paper size according to the following.

11

Making Copies

- 1** Press [Menu].
  - 2** Press [◀(-)] or [▶(+)] to select <1. PAPER SETTINGS> → press [OK].
  - 3** Press [◀(-)] or [▶(+)] to select <1. CASSETTE> or <2. MP TRAY> → press [OK].
  - 4** Press [◀(-)] or [▶(+)] to select <1. PAPER SIZE> → press [OK].
  - 5** Press [◀(-)] or [▶(+)] to select the appropriate paper size (A4, B5\*, A5\*, LTR, EXECUTIV\* or ENVELOPE\* for the paper cassette, A4, B5, A5, LTR, LGL, EXECUTIV, ENVELOPE or FREESIZE for the multi-purpose feeder) → press [OK].  
\*Only for the FAX-L380S model.
- When <ENVELOPE> is selected:
    - Press [◀(-)] or [▶(+)] to select the appropriate envelope type (DL, ISO-C5, COM10, or MONARCH) → press [OK].

● **When <FREE SIZE> is selected:**

- Press [◀(-)] or [▶(+)] to select <VERTICAL SIZE> or <HORIZONTAL SIZE> → press [OK].
- Use the numeric buttons, or press [◀(-)] or [▶(+)] to specify vertical and horizontal sizes of the paper in millimeters (mm).  
Available setting range in <VERTICAL SIZE>: 127 mm to 356 mm  
Available setting range in <HORIZONTAL SIZE>: 76 mm to 216 mm
- Press [OK].  
Repeat the steps above to specify both vertical and horizontal sizes of the paper.

**6** Press [Stop/Reset] to return to standby mode.

## Specifying the Paper Type

<PLAIN PAPER> is selected as the default paper type. When making copies on paper other than plain paper, you can specify the paper type according to the following. Specifying the paper type can prevent poor copy quality, or the printout not being printed correctly.

**1** Press [Menu].

**2** Press [◀(-)] or [▶(+)] to select <1. PAPER SETTINGS> → press [OK].

**3** Press [◀(-)] or [▶(+)] to select <1. CASSETTE> or <2. MP TRAY> → press [OK].

**4** Press [◀(-)] or [▶(+)] to select <2. PAPER TYPE> → press [OK].

**5** Press [◀(-)] or [▶(+)] to select the appropriate paper type (PLAIN PAPER, PLAIN PAPER L, HEAVY PAPER\*, HEAVY PAPER H\*, or TRANSPARENCY\*) → press [OK].

For the FAX L390 model, \* marked paper types are available only for the multi-purpose feeder.

**6** Press [Stop/Reset] to return to standby mode.

# Setting Enlarging/Reducing

You can enlarge or reduce the copy size using preset copy ratios or using custom copy ratios.

## Enlarging/Reducing Using Preset Copy Ratios

### 1 Press [COPY].

If you are already in the Copy standby mode, you can skip this step.

### 2 Press [Enlarge/Reduce].

PRESET RATIO
- 100% +

### 3 Press [◀(-)] or [▶(+)] to select the copy ratio → press [OK].

PRESET RATIO	70%	A4	01
- 70% A4→A5 +	□□■□	TEXT	

You can select from the following:

- 200% MAX.
- 141% A5 → A4
- 100%
- 70% A4 → A5
- 50% MIN.



#### NOTE

- If the <PAPER SIZE GROUP> setting of <COPY SETTINGS> menu in the Menu is set to 'INCH' or 'AB', the preset copy ratios will be as follows:  
INCH: 50%, 64%, 78%, 100%, 129% and 200%;  
AB: 50%, 70%, 81%, 86%, 100%, 115%, 141% and 200%.
- To reset the copy ratio, press [Enlarge/Reduce] several times to display <DIRECT 100%> ratio → press [OK].

# Enlarging/Reducing Using Custom Copy Ratios

## 1 Press [COPY].

If you are already in the Copy standby mode, you can skip this step.

## 2 Press [Enlarge/Reduce] twice.

ZOOM	50	-	200%
-		100%	+

## 3 Use the numeric buttons to enter the copy ratio → press [OK].

ZOOM	50	-	200%
-		80%	+

 → 

80%	A4
□□■□	TEXT
	01

- You can enter the copy ratio from 50% to 200%, selectable in 1% increments.
- Even after entering the copy ratio, you can use [◀(-)] or [▶(+)] to adjust the copy ratio. To increase the copy ratio, press [▶(+)]. To decrease the copy ratio, press [◀(-)].



### NOTE

To reset the copy ratio, press [Enlarge/Reduce] several times to display <DIRECT 100%> ratio → press [OK].

# Improving Copied Image

## Adjusting the Image Quality (Resolution)

You can adjust image quality to the appropriate level best suited for a document with text or photos. 3 modes are available for adjusting the image quality.

### 1 Press [COPY].

If you are already in the Copy standby mode, you can skip this step.

### 2 Press [Image Quality] repeatedly until the image quality you want appears.

You can select from the following:

- <TEXT> for text-only documents
- <TEXT/PHOTO> for documents with text and photographs
- <PHOTO> for photographs

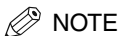

#### NOTE

Copy exposure automatically changes to manual mode when <TEXT/PHOTO> or <PHOTO> is set.

11

Making Copies

## Adjusting the Exposure (Density)

You can adjust the copy exposure automatically or manually according to how light or dark your document is.

### Adjusting Automatically

### 1 Press [COPY].

If you are already in the Copy standby mode, you can skip this step.

### 2 Press [Exposure] to select the auto mode → press [OK].



The copy exposure is adjusted automatically.

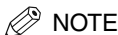

#### NOTE

Image quality mode automatically changes to <TEXT> when <AUTO EXPOSURE> is set.

## Adjusting Manually

### 1 Press [COPY].

If you are already in the Copy standby mode, you can skip this step.

### 2 Press [Exposure] twice to select the manual mode.

### 3 Press [◀(-)] or [▶(+)] to adjust the copy exposure → press [OK].

For a lighter copy exposure, press [◀(-)].

For a darker copy exposure, press [▶(+)].



### NOTE

*When setting the exposure lighter, the indicator moves to the left. When setting the exposure darker, the indicator moves to the right.*

# Special Features

The machine can perform the Collate Copy and Reserve Copy.

## Collate Copy

The collate copy allows you to sort copies in page order. It is convenient when you make multiple copies of multiple page documents. To use this feature, you need to set <AUTO SORT> to 'ON' in the <COPY SETTINGS> menu. (See p. 16-5.)

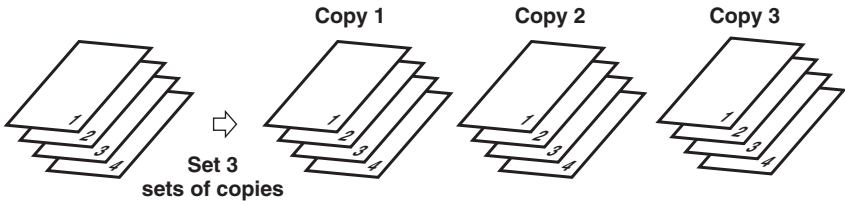

Follow the procedure below to set the Collate Copy function to 'ON':

11

Making Copies

- 1** Press [Menu].
- 2** Press [◀(-)] or [▶(+)] to select <3.COPY SETTINGS> → press [OK].
- 3** Press [◀(-)] or [▶(+)] to select <5.AUTO SORT> → press [OK].
- 4** Press [◀(-)] or [▶(+)] to select <ON> → press [OK].
- 5** Press [Stop/Reset] to return to standby mode.

The Collate Copy function is set to 'ON'. To perform copying, follow the procedure described in "Making Copies," on p. 11-1.

# Reserve Copy

This feature allows you to reserve the next job while the machine is printing out a current job.

---

## 1 Load the document to be reserved in the ADF.

For details on how to load documents, see "Loading Documents in the ADF," on p. 6-3.

## 2 Use the numeric buttons to enter the number of copies.

You can set up to 99 copies.

## 3 Adjust any necessary settings for your document.

- Press [Image Quality] to select the scanning resolution. (See "Adjusting the Image Quality (Resolution)," on p.11-6.)
- Press [Exposure] to select the scanning exposure. (See "Adjusting the Exposure (Density)," on p. 11-6.)
- Press [Enlarge/Reduce] to select the copy ratio. (See "Setting Enlarging/Reducing," on p. 11-4.)

## 4 Press [Start].

The machine begins scanning.



### NOTE

- After printing of the current copy job is complete, the next copy job begins.
- If the memory becomes full while scanning, <MEMORY FULL> appears in the LCD. When the ADF is used for scanning, the document being scanned stops in the ADF.  
All of the scanned documents will be erased if <MEMORY FULL> appears, so divide the document and copy each part separately, or select a lower image quality mode and make copies again.
- If the available memory decreases, <PLEASE WAIT> and <MAKING SPACE IN MEM> are displayed alternatively. If memory space becomes available, the scanning begins again automatically. Also, check that the cassette is not empty.



## Confirming the Copy Job You Reserved

- 1 Press [Stop/Reset] while the machine is printing out.

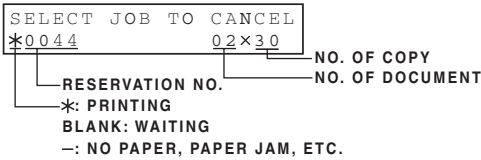

- 2 Press [◀(-)] or [▶(+)] to confirm the reservation number and number of documents.

### NOTE

To finish confirming, press [Stop/Reset].

## Deleting the Copy Job You Reserved

- 1 Press [Stop/Reset] while the machine is printing out.

- 2 Press [◀(-)] or [▶(+)] to display the job to be deleted → press [OK].

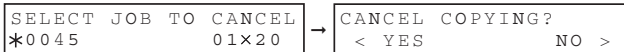

- 3 Press [◀(-)] for <YES>.

The reserved copy job is deleted.

### NOTE

- To cancel deleting the copy job, press [▶(+)] for <NO>.
- Once the copy job is deleted, the job can not be restored.

# System Monitor

## Checking the Status of Copy, Fax, Print and Report Jobs

Use [System Monitor] to confirm and delete the jobs.

When using [System Monitor], the LCD displays the jobs in the following order in each mode.

In Copy mode,

- COPY STATUS

- FAX MONITOR

- PRINT STATUS

- REPORT STATUS

In Fax mode,

- FAX MONITOR

- COPY STATUS

- PRINT STATUS

- REPORT STATUS

### Confirming Transmission Status

Follow the procedure below to confirm the sending or receiving status.

- 1 Press [System Monitor] repeatedly until <FAX MONITOR> is displayed → press [OK].

FAX MONITOR 1 .RX /TX STATUS	→	16 : 50 0056 TX 123xxxx
---------------------------------	---	----------------------------



#### NOTE

- To return to standby mode, press [Stop/Reset].
- If you perform the procedure above when the machine is not sending or receiving faxes, <NO CURRENT RX/TX JOB> appears, and the display returns to the display shown in step 1.
- The transaction number and <TX/RX> in the LCD mean the following:
  - <0001> to <4999>: A sent document (TX)
  - <5001> to <9999>: A received document (RX)

## Confirming Transmission Results and Sending Reservation

Follow the procedure below to confirm the sending or receiving results and sending reservation (automatic redialing and delayed sending).

**1** Press [System Monitor] repeatedly until <FAX MONITOR> is displayed.

**2** Press [◀(-)] or [▶(+)] to select <2.TX/RX RESULT> → press [OK].

The sending result and reservation can be confirmed by checking the sending time, <TX/RX NO.> or fax number.

**3** Press [◀(-)] or [▶(+)] to confirm the sending result and reservation.

```
15:34 0010 TX STNDBY
[ 01 ] CANON USA
```

### NOTE

- To return to standby mode, press [Stop/Reset].
- If you perform the procedure above when there is no sending reservation and transmission jobs, <NO DOC. STORED> will appear, and the display will return to the display shown in step 2.

## Deleting a Fax Job

Follow the procedure below to delete the documents waiting to be sent by automatic redialing or delayed sending.

**1** Press [System Monitor] repeatedly until <FAX MONITOR> is displayed.

**2** Press [◀(-)] or [▶(+)] to select <3.DELETE DOCUMENT> → press [OK].

**3** Use the numeric buttons to enter the transmission number of the fax job you want to delete → press [OK].

```
TX RX NO.    0055 → OK TO DELETE?
                  < YES          NO >
```

### NOTE

You can check the transmission number of the reserved fax job by printing the DOCUMENT MEMORY LIST. (See p. 13-14.)

**4** If you want to delete the fax job, press [◀ (-)] for <YES>.

If you change your mind and do not want to delete the fax job, press [▶ (+)] for <NO>.

## Confirming and Deleting a Copy Job

- 1 Press [System Monitor] repeatedly until <COPY STATUS> is displayed.



### NOTE

If there is no job, <NO COPY JOBS EXIST> is displayed.

- 2 Press [◀(-)] or [▶(+)] to confirm the job number, and the quantity of copies.

```
COPY STATUS
0003          03x02
```

- 3 If you want to delete the copy job, press [OK].

```
CANCEL COPYING?
< YES          NO >
```

- 4 If you decide to delete the job, press [◀(-)] for <YES>.



### NOTE

To cancel deleting the job, press [▶(+)] for <NO>.  
Once the job is deleted, the job cannot be restored.

## Confirming and Deleting a Print Job

- 1 Press [System Monitor] three times.



### NOTE

If there is no job, <NO PRINT JOBS EXIST> is displayed.

- 2 Press [◀(-)] or [▶(+)] to confirm the file name.

```
PRINT STATUS
-----
|
FILE NAME
```

- 3 If you want to delete the print job, press [OK].

```
CANCEL PRINTING?
< YES          NO >
```

**4** If you decide to delete the print job, press [◀(-)] for <YES>.

 **NOTE**

- To cancel deleting the job, press [▶(+)] for <NO>. Once the job is deleted, the job cannot be restored.
- The LCD can display characters in ASCII cord. Using characters other than those in ASCII cord may have the LCD display garbled characters.

## Confirming and Deleting a Report Job

**1** Press [System Monitor] four times.

 **NOTE**

*If there is no job, <NO REPORT JOBS EXIST> is displayed.*

**2** If there is one report job and if you want to delete it, press [OK].

```
CANCEL REPORT?
< YES          NO >
```

**3** If you decide to delete the job, press [◀(-)] for <YES>.

**4** If there are multiple report jobs, press [◀(-)] or [▶(+)] to select the job you want to delete.

```
REPORT STATUS
02 USER DATA LIST
```

**5** Press [OK].

```
CANCEL REPORT?
< YES          NO >
```

**6** If you decide to delete the job, press [◀(-)] for <YES>.

 **NOTE**

*To cancel deleting the job, press [▶(+)] for <NO>. Once the job is deleted, the job cannot be restored.*

# 13

## CHAPTER

# Reports and Lists

This chapter describes how to print reports and lists.

## Activity Report

The Activity Report is printed out automatically by the machine after every 20 transactions. This report lists the details of the documents you have sent or received so that you can keep track of the transaction operations your machine has performed.

- Machine prints sending and receiving transactions together in the same report.
- When sending a document to many locations (Broadcast), the transaction number will be the same for each transmission in the group.

You can also print the Activity Report manually if you want to check the report before the 20 transactions are completed. Follow this procedure to print the Activity Report.

### 1 Press [FAX].

If you are already in the Fax standby mode, you can skip this step.

### 2 Open One-Touch Speed Dial panel → press [Report].

```
REPORT
1.ACTIVITY REPORT
```

### 3 Press [OK].

The machine prints the ACTIVITY REPORT and the LCD returns to standby mode.

ST. TIME	DESTINATION TEL./ID	NO.	MODE	PCS.	RESULT
012/31 08:28	ADAM BOOK.CPA 732 2233	0007	TRANSMIT ECM	1	OK 00'06
012/31 08:40	HELZEB.ING. 1 213 978 3314	5005	AUTO.RX ECM	1	NG 00'20
				1	STOP
012/31 09:08	SLLOUS 1 213 978 3314	0008	TRANSMIT	2	NG 00'00
				0	80995
12/31 09:34	ADAM BOOK.CPA 732 2233	0009	TRANSMIT	1	OK 00'18
	3333				

IF MARKED WITH AN # IT ALREADY HAS BEEN PRINTED OUT.

TRANSACTION NUMBER

ERROR CODE

# Department ID Report

If you set up Department ID Management, and the activity report feature is turned ON, transactions are listed by department in the Department ID report shown below. (See Chapter 9, "Restricting the Use of the Machine.")

31/12 2005 09:58 FAX 123xxxx WORLD ESTATE,INC. 0001						
***** *** ACTIVITY REPORT *** *****						
DEPT. ID:0001111						
ST. TIME	DESTINATION TEL/ID	NO.	MODE	PCS.	RESULT	
451/12 08:28	ADAM BOOK.CPA 732 2233	0007	TRANSMIT	ECM	1	OK 00'06
451/12 08:49	BELZER.INC. 1 213 978 3314	5005	AUTO RX	ECM	1	NG 00'20 1 5708
DEPT. ID:0002222						
ST. TIME	DESTINATION TEL/ID	NO.	MODE	PCS.	RESULT	
451/12 09:08	R.LOUIS 1 213 978 3314	0008	TRANSMIT		2	NG 00'00 0 #995
DEPT. ID:0000000						
ST. TIME	DESTINATION TEL/ID	NO.	MODE	PCS.	RESULT	
31/12 09:34	ADAM BOOK.CPA 732 2233	0009	TRANSMIT		1	OK 00'18

DEPARTMENT ID

IF MARKED WITH AN 8 IT ALREADY HAS BEEN PRINTED OUT.

TRANSACTION NUMBER

THE TRANSACTION MADE WHILE DEPARTMENT ID MANAGEMENT IS OFF IS DEVIDED INTO DEPT. ID:0000000

ERROR CODE

# Transmission (TX) Reports

The machine normally prints a report only when an error occurs during sending (ERROR TX REPORT). However, you can set the machine to print a report every time you send a document (TX REPORT).

If you send a document using memory, you can also select whether the first page of the document is printed with the report. See "1.TX REPORT" in the <REPORT SETTINGS> menu on p. 16-7 for details on setting these options.

- ST. TIME**        Represents the time the last attempt was made to transmit a document.
- TIME USE**       Represents the amount of time it took during the last attempt to transmit. Please note that the usage time does not reflect the total usage time used to transmit all pages of the document when "retry" occurs. By printing an ACTIVITY REPORT and matching the transaction number of the TX REPORT with a transaction number in the ACTIVITY REPORT you can find out exactly how many attempts were made to send the document, how many pages were sent in each attempt as well as the usage time for each attempt.
- PAGES SENT**    Represents the number of pages that were successfully transmitted.
- RESULT**         **OK** means that all pages were transmitted either during the first attempt or after the first or second retry.  
**NG** means that either some or no pages were transmitted after 2 retries.

## Error TX Report

```
31/12 2005 10:32 FAX 123xxxx          WORLD ESTATE,INC.          ☐ 001

*****
*** ERROR TX REPORT ***
*****

TX FUNCTION WAS NOT COMPLETED

TX/RX NO           0006
DEPT. ID           000111
DESTINATION TEL #  1 213 978 3314
DESTINATION ID    JOHN BARRISTER
ST. TIME          31/12 10:30
TIME USE          00'00
PAGES SENT        0
RESULT            NG          STOP
```

DEPT ID is listed only while the department ID management is ON.



# TX Report

WHEN YOU  
SET THE FAX  
TO PRINT  
THE FIRST  
PAGE OF THE  
DOCUMENT

31/12 2005 09:49 FAX 123xxxx	WORLD ESTATE,INC.	001
***** *** TX REPORT *** *****		
TRANSMISSION OK		
TX/RX NO	0006	
DEPT. ID	0001111	
DESTINATION TEL #	20 545 8545	
DESTINATION ID	JOHN BARRISTER	
ST. TIME	31 /12 09:48	
TIME USE	00'16	
PAGES SENT	1	
RESULT	OK	
<b>THE SLEREXE COMPANY LIMITED</b> SAPORS LANE•BOOLE•DORSET•BH25 8ER TELEPHONE BOOLE (945 13) 51617 – FAX 123456		
Our Ref. 350/PJC/EAC		December 27, 2005
Dr. P. N. Cundall, Mining Surveys Ltd., Holroyd Road, Reading, Berks.		

DEPT ID is listed only while the department ID management is ON.

# Multi TX/RX Report

If you used sequential broadcasting to send a document, the MULTI TX/RX REPORT is printed.

31/12 2005 09:58 FAX 123xxxx	WORLD ESTATE,INC.	001
***** *** MULTI TX/RX REPORT *** *****		
TX/RX NO	0013	
PGS.	1	
DEPT. ID	0001111	
TX/RX INCOMPLETE	-----	
TRANSACTION OK		
	[ 01]732 2233	JOHN BARRISTER
	[ 03]1 914 438 3619	SEYMOUR GREEN
ERROR INFORMATION	-----	

If you set your machine to print activity reports (TX REPORT or RX REPORT) and then use sequential broadcasting or polling reception with multiple parties, multi-activity report will be printed instead of the activity report (Sending or Receiving). See <REPORT SETTINGS>, on p. 16-7.

DEPT ID is listed only while the department ID management is ON.

13

Reports and Lists

# Reception (RX) Report

Normally the machine does not print a reception report (RX REPORT) unless you set it to do so.

You can set the machine to print the RX REPORT every time you receive a document or only if an error occurs during receiving. See p. 16-8 for details on setting this option.

31/12 2005 09:58 FAX 123xxxx	WORLD ESTATE,INC.	001
***** *** RX REPORT *** *****		
RECEPTION OK		
TX/RX NO	5008	
DESTINATION TEL #	1 213 978 3314	
DESTINATION ID		
ST. TIME	31/12 09:07	
TIME USE	00'17	
PGS.	1	
RESULT	OK	

# Memory Clear Report

If you experience a power failure, all documents stored in memory can be saved for up to approx. 1 hour. If power is not restored to the fax within 1 hour, the documents in memory will be lost. If this time limit has elapsed before power is restored to the fax, as soon as power is restored a list of documents deleted from the memory as a result of the power failure is printed automatically.

31/12 2005 10:32 FAX 123xxxx		WORLD ESTATE,INC.			001	
***** *** MEMORY CLEAR REPORT *** ***** MEMORY FILES DELETED						
TX/RX NO	MODE	DESTINATION TEL/ID	PGS.	SET TIME	ST. TIME	
0001	DELAYED TX	[ 01] ADAM BOOKS.CPA	1	30/12 10:07	23:30	
0002	TRANSMIT	[ 02] JOHN BARRISTER	3	30/12 10:26		

 **NOTE**

*If there are one or more documents in the image memory when the power is cut off, the machine will print the Memory Clear Report when the power is restored unless the machine is running out of paper or toner.*

# Speed Dialing Lists

Your machine can print speed dialing lists. These lists allow you to review the numbers and names registered under One-Touch Speed Dial buttons and Coded Speed Dialing codes (including Group Dialing numbers).

Follow this procedure to print the lists.

- 1** Press [Menu].
- 2** Press [◀(-)] or [▶(+)] to select <9.PRINT LISTS> → press [OK].
- 3** Press [◀(-)] or [▶(+)] to select <2.SPEED DIAL LIST> → press [OK].
- 4** Press [◀(-)] or [▶(+)] to select the list you want to print → press [OK].

You can select from the following:

- <1-TOUCH LIST>
- <CODED DIAL LIST>
- <GROUP DIAL LIST>

If you selected <1-TOUCH LIST> or <CODED DIAL LIST>, press [◀(-)] or [▶(+)] to select <SORT> or <NO SORT> depending on what order you want the destinations to be printed:

Select <1.NO SORT> to print the list in key number order → press [OK].

-or-

Select <2.SORT> to print the list with the names of the destinations in alphabetical order → press [OK].

The machine prints the list and the LCD returns to standby mode.



## NOTE

*You can also print the list using [Report]. Open One-Touch Speed Dial panel → press [Report] → select <2.SPEED DIAL LIST> → press [◀(-)] or [▶(+)] to select a report you want to print out → press [OK].*

# One-Touch Speed Dial List

NOT SORTED

31/12 2005 10:32 FAX 123xxxx		WORLD ESTATE,INC.	001
***** *** 1-TOUCH LIST *** *****			
NO.	DESTINATION TEL #	DESTINATION ID	
[ 01]	1 914 438 3619	SEYMOUR GREEN	
[ 02]	722 2655	ROBERT STUART	
[ 03]	1 516 911 4411	NATALIE SMITH	
[ 06]	761 1298	JOHN BARRISTER	
[ 08]	732 2233	ADAM BOOKS.CPA	

SORTED

31/12 2005 10:32 FAX 123xxxx		WORLD ESTATE,INC.	001
***** *** 1-TOUCH LIST *** *****			
NO.	DESTINATION TEL #	DESTINATION ID	
[ 08]	732 2233	ADAM BOOKS.CPA	
[ 06]	761 1298	JOHN BARRISTER	
[ 03]	1 516 911 4411	NATALIE SMITH	
[ 02]	722 2655	ROBERT STUART	
[ 01]	1 914 438 3619	SEYMOUR GREEN	

# Coded Speed Dial List

FAX-L380S

NOT SORTED

31/12 2005 10:32 FAX 123xxxx		WORLD ESTATE,INC.	001
***** *** CODED DIAL LIST *** *****			
NO.	DESTINATION TEL #	DESTINATION ID	
[* 01]	555 1234	BILL	
[* 02]	1 914 438 3619	SEYMOUR GREEN	
[* 03]	1 516 911 4411	NATALIE SMITH	
[* 04]	1 617222322	HUNT INVESTMENTS	
[* 08]	732 2233	ADAM BOOKS.CPA	

SORTED

31/12 2005 10:32 FAX 123xxxx		WORLD ESTATE,INC.	001
***** *** CODED DIAL LIST *** *****			
NO.	DESTINATION TEL #	DESTINATION ID	
[* 08]	732 2233	ADAM BOOKS.CPA	
[* 01]	555 1234	BILL	
[* 04]	1 617222322	HUNT INVESTMENTS	
[* 03]	1 516 911 4411	NATALIE SMITH	
[* 02]	1 914 438 3619	SEYMOUR GREEN	

FAX-L390

NOT SORTED

31/12 2005 10:32 FAX 123xxxx		WORLD ESTATE,INC.	001
***** *** CODED DIAL LIST *** *****			
NO.	DESTINATION TEL #	DESTINATION ID	
[* 001]	555 1234	BILL	
[* 002]	1 914 438 3619	SEYMOUR GREEN	
[* 003]	1 516 911 4411	NATALIE SMITH	
[* 004]	1 617222322	HUNT INVESTMENTS	
[* 008]	732 2233	ADAM BOOKS.CPA	

SORTED

31/12 2005 10:32 FAX 123xxxx		WORLD ESTATE,INC.	001
***** *** CODED DIAL LIST *** *****			
NO.	DESTINATION TEL #	DESTINATION ID	
[* 008]	732 2233	ADAM BOOKS.CPA	
[* 001]	555 1234	BILL	
[* 004]	1 617222322	HUNT INVESTMENTS	
[* 003]	1 516 911 4411	NATALIE SMITH	
[* 002]	1 914 438 3619	SEYMOUR GREEN	

# Group Dial List

FAX-L380S

31/12 2005	13:36	FAX	123xxxx	WORLD ESTATE,INC.	001
***** *** GROUP DIAL TEL # LIST *** *****					
[ 05]	CANON GROUP	[*	01]	225 7823	CANON NY
		[*	10]	233 7766	CANON CA
		[	01]	876 2398	CANON TX
		[	02]	613 9076	CANON CA

FAX-L390

31/12 2005	13:36	FAX	123xxxx	WORLD ESTATE,INC.	001
***** *** GROUP DIAL TEL # LIST *** *****					
[ 05]	CANON GROUP	[* 001]	225 7823	CANON NY	
		[* 010]	233 7766	CANON CA	
		[ 01]	876 2398	CANON TX	
		[ 02]	613 9076	CANON CA	

# User's Data List

You can print a list of the data registered in your machine. This list is useful when you want to review the user data information you may have entered (such as your name and number, the date and time) and all other settings currently selected.

Follow this procedure to print the USER'S DATA LIST.

**1** Press [Menu].

**2** Press [◀(-)] or [▶(+)] to select <9. PRINT LISTS> → press [OK] twice.

The machine prints the USER'S DATA LIST and the LCD returns to standby mode.



## NOTE

- The LCD returns to standby mode and the USER'S DATA LIST is printed.
- You can also print the USER'S DATA LIST using [Report]. Open One-Touch Speed Dial panel → press [Report] → press [◀(-)] or [▶(+)] to select <1.USER DATA> → press [OK].

31/12 2005 13:36 FAX 123xxxx	WORLD ESTATE,INC.	001
***** *** USER'S DATA LIST *** *****		
1.PAPER SETTINGS		
CASSETTE		
PAPER SIZE	A4	
PAPER TYPE	PLAIN PAPER	
MP TRAY		
PAPER SIZE	A4	
7.SYSTEM SETTINGS		
SYS. ADMIN. INFO		
DEPT. ID MANAGEMNT	OFF	
TOTAL MEMORY 8.240MB		
MAIN	----	ECab-01-02
MAIN2	----	WLD-02-01
ECONT	----	0027



 **NOTE**

When you set the System Administrator's ID and password, System Administrator's ID, contents of the department ID management settings are printed on the USER'S DATA LIST.

31/12 2005	13:36	FAX	123xxxx	WORLD ESTATE,INC.	001
***** *** USER'S DATA LIST *** *****					
1.PAPER SETTINGS					
CASSETTE					
PAPER SIZE			A4		
PAPER TYPE			PLAIN PAPER		
MP TRAY					
PAPER SIZE			A4		
7.SYSTEM SETTINGS					
SYS. ADMIN. INFO					
SYS. ADMIN. ID					
DEPT. ID MANAGEMNT			ON		
DEPT. ID		COPY LIMITS		TX LIMITS	
0001234		001000		001000	
0002222		002000		002000	
RESTRICTIONS					
RESTRICT PRINTING			OFF		
RESTRICT TX			OFF		
TOTAL MEMORY				8.240MB	
MAIN		----		ECab-01-02	
MAIN2		----		WLD-02-01	
ECONT		----		0027	

# Department Information List

When you set the department ID management, you can check the print count and send count by printing the DEPT. INFO LIST.

- 1** Press [Menu].
- 2** Press [◀(-)] or [▶(+)] to select <9. PRINT LISTS> → press [OK].
- 3** Press [◀(-)] or [▶(+)] to select <3. DEPT. INFO LIST> → press [OK].
- 4** Enter the system password.  
The machine prints the DEPT. INFO LIST and the LCD returns to standby mode.

31/12 2005 17:15 FAX 123xxxx		WORLD ESTATE,INC.		001	
***** *** DEPT. INFO LIST *** *****					
DEPT. ID	PRINT COUNT	COPY LIMITS	SEND COUNT	TX LIMITS	
0001234	10		25		
0002222	1		14		
0003333	5		2		

# Document Memory List

The machine can print a list of documents stored in memory, along with the transaction number (TX/RX NO.) of each document.

## 1 Press [FAX].

If you are already in the Fax standby mode, you can skip this step.

## 2 Open One-Touch Speed Dial panel → press [Report].

Press [◀(-)] or [▶(+)] to select <4.DOC. MEMORY LIST> → press [OK].

The machine prints the DOCUMENT MEMORY LIST and the LCD returns to standby mode.

### NOTE

Once you know the transaction number of a document stored in memory, you can delete it. (See "Deleting a Fax Job," on p. 12-2.)

31/12 2005 17:15 FAX 123xxxx		WORLD ESTATE,INC.			001	
***** *** DOCUMENT MEMORY LIST *** *****						
TX/RX NO	MODE	DESTINATION TEL/ID	PGS.	SET TIME	ST. TIME	
0046	DELAYED TX	[ 01] Canon TOKYO	1	31/12 10:07	23:30	
0047	TRANSMIT	[ 02] Canon ITALIA	3	31/12 10:26		

# Cancel Report Printing

You can cancel report printing using the CANCEL REPORT item from the REPORT menu.

- 1** Press [Menu].
  - 2** Press [◀(-)] or [▶(+)] to select <9.PRINT LISTS> → press [OK].
  - 3** Press [◀(-)] or [▶(+)] to select <4.CANCEL REPORT> → press [OK].
  - 4** Press [◀(-)] or [▶(+)] to select <YES> → press [OK].  
Printing is canceled.  
If you do not want to cancel the report, press [◀(-)] or [▶(+)] to select <NO> → press [OK].
- **If there are multiple jobs:**
    - Press [◀(-)] or [▶(+)] to select the report you want to cancel → press [OK].
    - Press [◀(-)] or [▶(+)] to select <YES> → press [OK].



## NOTE

*If you want to cancel multiple jobs, select one job at a time, and cancel them one by one.*

# Troubleshooting

This chapter describes the problems you might encounter when using the machine and their remedies. It also explains what to do if you cannot solve the problem by yourself.

## Clearing Jams

This section describes how to remove jammed paper.

### Removing Jammed Paper from Inside the Machine

When print media jams inside the machine, the LCD displays <REC. PAPER JAM> and <OPEN PRINTER COVER>.



#### CAUTION

**There are some areas inside the machine and cartridge which are subject to high voltages and high temperatures. Take adequate precaution when performing internal inspections to avoid burns or electrical shock.**



#### NOTE

*When removing jammed paper from inside the machine, take care not to allow the toner on the jammed paper to come into contact with your hands or clothing. If they become dirty, wash them immediately with cold water. Washing with warm water will set the toner, and make it impossible to remove the toner stains.*

- 1 Open the printer cover. If there is any paper left in the cassette or on the output tray, remove it first.

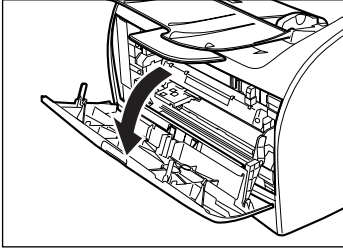

- 2 Remove the cartridge.

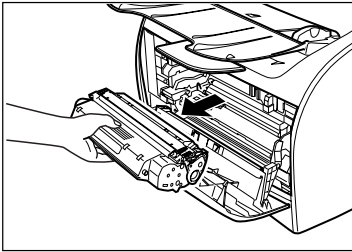

 **IMPORTANT**

- Remove watches and any bracelets or rings when touching the inside of the machine. These items might be damaged if they come into contact with the parts inside the machine.
- When removing the jammed paper, do not touch the transfer roller (shaded part) as its surface is very delicate and susceptible to finger oil and scratches, which may lead to print deterioration.
- To avoid possible damage to the printer, do not touch the pins near the left end of the transfer roller.

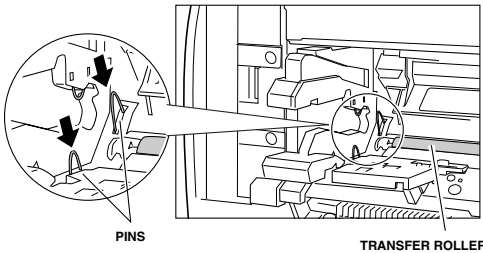

 **NOTE**

*Do not expose the cartridge to light for more than 5 minutes. If necessary, put the cartridge in its original protective bag or wrap it with a thick cloth to prevent exposure to light.*

- 3** Open the rear cover and push down the green paper release levers on both sides of the face up paper output.

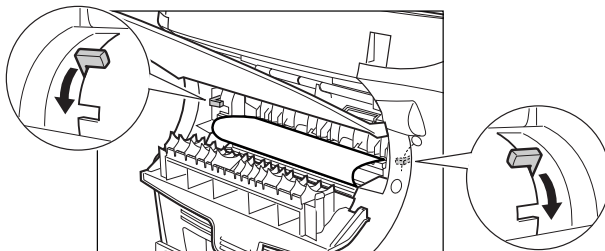

- 4** Hold both sides of the jammed paper and carefully move it inward, then gently pull it out.

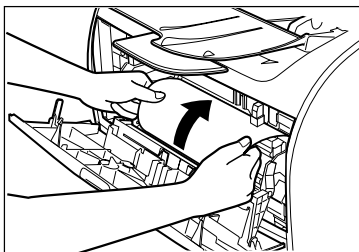

- 5** Roll the leading end of the paper outwards so that the printed surface is on the inside of the roll, then gently pull the rolled up paper out of the machine.

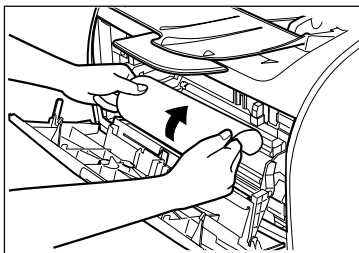

- 6** If the leading edge of the paper is visible but has not entered the imaging area (marked with yellow label), pull the paper forwards and roll it inwards.

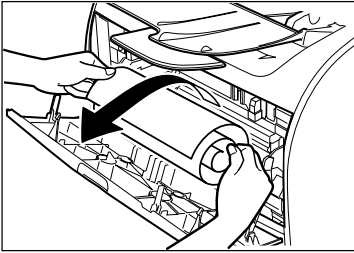

If the leading edge of the paper has already entered the imaging area, gently pull out the paper at the face up paper output rollers until the edge of the paper appears.



### IMPORTANT

- Do not pull the jammed paper forward from the cassette. It may cause a malfunction.

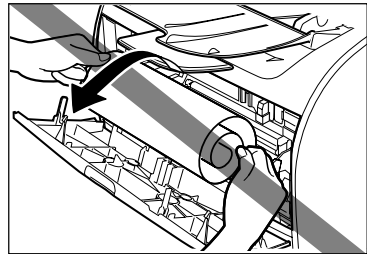
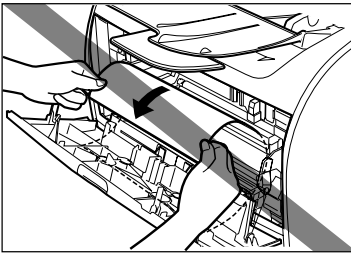

- Do not pull the jammed paper upward; the toner on the paper will stain the printer and cause a permanent reduction in print quality.

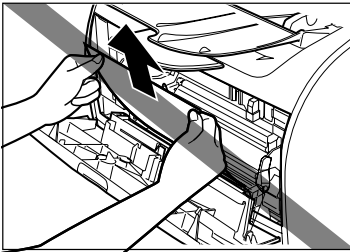



- 7** Gently pull the jammed paper between the output rollers until the leading edge emerges from the machine.

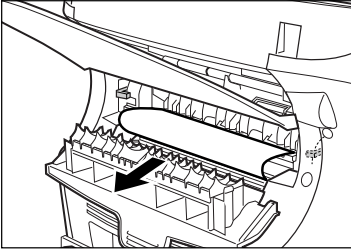

- 8** Carefully pull the jammed paper straight out through the rollers.

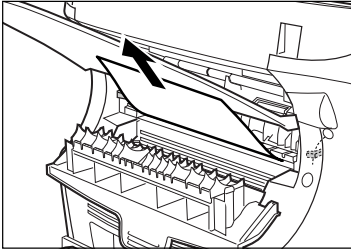

If the jammed paper is badly folded, similar to the folds of an accordion, ease the jammed paper loose and then pull it out of the machine.

- 9** Push the paper release levers back to their original position and close the rear cover.

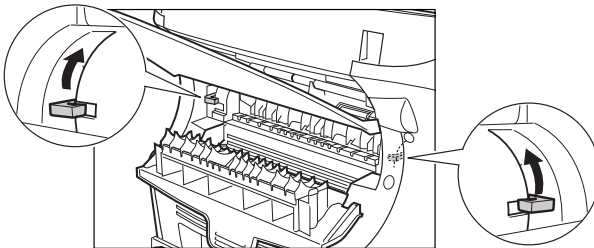

 **IMPORTANT**

- Be sure to push the paper release levers back to their original position. If the levers are left pushed down, the paper jam error will not be resolved.
- Never push down the paper release levers while printing. This could result in damage to the fixing assembly.

## 10 Insert the cartridge back into the machine, then close the printer cover.

For details, see "Installing/Replacing the Toner Cartridge," on p. 2-18.

## IMPORTANT

*After you replace the cartridge and close the printer cover, the machine should be ready for operating. If the machine returns to the ready state for operating, troubleshooting has been successful. If the machine does not return to the ready state for operating, confirm that the paper release levers are pushed back to their original position, and check to see that jammed paper is not left in the machine.*

- If paper jam occurs when using the cassette:

**1** Pull out the cassette completely.

**2** Hold both sides of the jammed paper and pull it out from the machine at a downward angle.

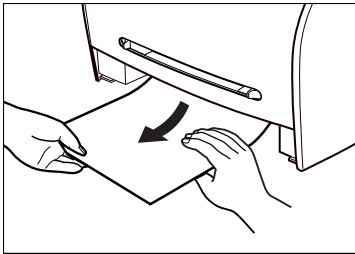

**3** Insert the cassette to the machine.

**4** Open and close the printer cover to clear the error message and reset the machine.

- If paper jam occurs when using the multi-purpose feeder:

**1** Hold both sides of the jammed paper and pull it out from the multi-purpose feeder.

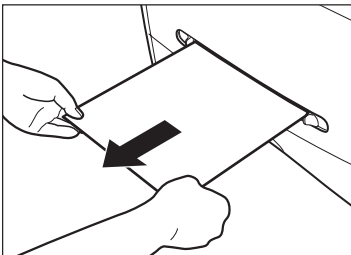

**2** Open and close the printer cover to clear the error message and reset the machine.

## Removing Jammed Paper from the ADF

When the document jams in the ADF, the LCD displays <CHECK DOCUMENT>.

- 1** Widen the slide guides until they stop, and remove the paper so as not to be caught by the slide guides. Open the ADF and gently remove the jammed paper from the ADF.

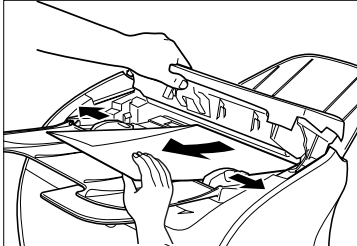

### NOTE

*After removing jammed paper, even edges of the document before loading it in the ADF again.*

# LCD Messages

The following messages are displayed in the LCD when the machine performs a function or if it encounters an error.

Message	Cause	Action
CHANGE PAPERSIZE	When the machine prints the reports or lists, the paper size setting is set to a size other than <LTR>, or <A4>.	Set the paper size setting to <LTR>, or <A4> and load paper of the same size. For the TX report or RX report, the machine automatically prints the reports or lists which was stored in the memory.
CHECK DOCUMENT	There is a paper jam in the ADF.	Remove the document in the ADF. (See p. 14-7.) Make sure that the document is not too long or too short. (See p. 6-1.) Then reset the machine by opening the printer cover and then closing it.
	The ADF roller rotates without feeding documents.	Fan the edge that will feed into the machine first, then tap the edge of multiple page documents on a flat surface to even the stack.
	The document has stopped in the ADF because you pressed [Stop/Reset] while scanning.	Remove the document in the ADF. (See p. 14-7.)
CHECK PRINTER	An abnormality has occurred in the printer.	Reset the machine by opening the printer cover and then closing it. If the message remains, unplug the machine from the power supply and call your service representative.
DOCUMENT TOO LONG	The document is longer than 356 mm for multi-page document, 1 m for one-page document, or is not feeding correctly.	Reduce the length of the document to within 356 mm or 1 m.
	There is a paper jam in the ADF.	Remove the document you are trying to copy in the ADF. (See p. 14-7.) Make sure that the document is not too long or too short. (See p. 6-1.) Then reset the machine by opening the printer cover and then closing it.
HANG UP PHONE	The handset is not placed in the handset cradle correctly.	Replace the handset correctly.
INCORRECT PAPER SIZE	The size of the paper in the cassette or multi-purpose feeder is different from that of the paper specified in the <PAPER SIZE> setting of the Menu.	Load the correct paper size or change the <PAPER SIZE> setting of the Menu. (See p. 16-2.) Then reset the machine by opening the printer cover and then closing it.
INSTALL CARTRIDGE	The cartridge is not installed or not installed correctly.	Install the cartridge correctly. (See p. 2-18.)

Message	Cause	Action
MEM IN USE nn %	Shows the percentage of memory currently in use. This message is displayed when you set the document in ADF.	Wait for the machine to send any faxes in memory. Also, print or delete any documents in memory you no longer need.
MEMORY FULL	The memory is full because collate copy was set when a large document is loaded.	Divide the document and copy each part separately.
NOT REGISTERED	The One-Touch Speed Dial button or Coded Speed dialing code you entered has not been registered.	Register the One-Touch Speed Dial button or Coded Speed Dialing code. (See pages 5-2 and 5-5.)
PRINTER DATA ERROR	Abnormality has occurred in the data transmission between the machine and computer.	Use [System Monitor] to delete the current print job or the final print job (if multiple jobs are being printed). Then you can shift to the next job. If you use <PRINTER RESET> of the Menu, all the print jobs are deleted. (See p.16-15.)
REC. PAPER JAM	There is a paper jam.	Clear the paper jam (See pages 14-1 to 14-7.) and reload paper in the cassette or multi-purpose feeder. Then reset the machine by opening the printer cover and then closing it.
RECEIVED IN MEMORY	The machine received the fax in memory because paper or toner ran out, a paper jam occurred, or incorrect paper size was loaded.	Load correct paper size in the cassette, replace the cartridge, or clear the paper jam. (See p.7-6.)
REMOVE MP PAPER	Paper is loaded in the multi-purpose feeder when the machine receives a fax or prints a report or list.	Remove the paper from the multi-purpose feeder. If the machine receives the fax then paper is loaded in the multi-purpose feeder, the received document will be stored in memory.
REPLACE CARTRIDGE	The toner cartridge ran out of toner or is not installed properly.	Make sure the toner in the cartridge is evenly distributed or the cartridge is installed properly. After doing this, if the message remains displayed or the print quality is low, replace the cartridge. (See p. 2-18.)
SCANNING ↓ MAKING SPACE IN MEM ↓ PLEASE WAIT	Memory is getting low during scanning because the document has many graphics or photos.	When memory space becomes available as printing continues, the scanning resumes automatically. Then reset the machine by opening the printer cover and then closing it.
START AGAIN	The paper in the cassette has run out, the toner has run out, paper jams have occurred, or the paper size setting is wrong while the report is printing.	After loading paper in the cassette, replacing the cartridge, clearing jams, or specifying the correct paper size, print the report again.
SUPPLY REC. PAPER CASSETTE	No paper is loaded in the cassette.	Load paper in the cassette. (See p. 2-21 to 2-23.) Make sure the paper stack in the cassette does not exceed the capacity of the cassette. If you load paper while making copies, do not load a different paper size.

Message	Cause	Action
SYSTEM ERROR Exxx*	An error of some kind has occurred in the machine.	Unplug the machine from the power supply and wait for approx. 3 minutes to 5 minutes, then plug it in again. If this does not solve the problem, unplug the machine and call your service representative.
TX/RX NO. nnnn**	When the machine sends or receives a fax, it assigns a unique identification number (nnnn).	Write down the number for future reference.

\* xxx stands for a number.

\*\* The identification number does not appear in the standby mode. It appears when scanning documents, operating [System Monitor], receiving faxes in Manual mode or memory, or after transmission is completed.

# Error Codes

Errors in reports are recorded as error code numbers because there is not enough space to print a detailed description of the error in the report. When errors are recorded in reports, note the error code number, and check it against the table below to learn more about what caused the error and how to remedy it.

Numbers	Cause	Action
#0001	There may be a document jam.	Clear the jam.
#0003	A document longer than 30 cm is being sent from the feeder. Data is too large and taking too long to send a document. It's taking too long to receive a page.	Divide the document into pages and resend from the platen glass. Reduce the scan resolution and resend. Contact the other party and have them reduce the scan resolution or split the document into segments and resend.
#0005	The other fax machine did not respond within 35 seconds. The other party may not be using a G3 fax machine.	Send the document again. Contact the other party and have them check their fax machine. If you are making an overseas call, add a pause to the number. Check with the other party and send the document to a G3 fax machine. If the other party does not have a G3 fax machine, try sending your document using a transmission mode the other party's fax machine supports.
#0009	No paper is loaded in the cassette or the cassette is not set properly.	Load paper in the cassette or set the cassette properly.
#0011	If you are polling a fax machine to receive a document, the other party has not set the document correctly on the machine.	Contact the other party and request that the document be set correctly for polling on their machine.
#0012	The other fax machine has run out of paper and its memory is full.	Contact the other party and tell them to refill the paper cassette.
#0018	The other fax did not respond to redialing. The document was not sent because the other fax machine was busy and did not respond within 55 seconds.	Wait for a while and try again. If you still cannot send the document, contact the other party and have them check if their fax machine is turned on. If the line is busy, wait more and try again.
#0022	The settings for the one-touch speed dialing keys or coded speed dialing codes you are using to dial the other party have been deleted.	Reset the one-touch or coded speed dialing settings.
#0034	You sent a confidential document to another fax machine, but it was rejected.	Contact the other party and confirm the settings of the other party's confidential mailbox.
#0037	The memory is full.	Print out the faxes received in the memory.
#0995	A waiting fax job has been canceled.	Resend the fax if needed.

# Paper Feeding Problems

---

Paper does not feed correctly.

---

**Q** Does the cassette or multi-purpose feeder contain an appropriate quantity of sheets?

**A** Make sure the paper stack in the cassette or the paper in the multi-purpose feeder does not exceed the capacity of the cassette or multi-purpose feeder. (See "Loading Paper," on p. 4-3.)

**Q** Is paper loaded correctly?

**A** Make sure the paper stack in the cassette or the paper in the multi-purpose feeder is loaded properly, and that the slide guides are adjusted correctly. (See "Loading Paper," on p. 4-3.)

**Q** Is the cassette inserted into the machine correctly?

**A** Push the cassette into the machine as far as it will go, and make sure the cassette is not tilted or inserted at an angle.

---

Paper feeds skewed. (Printing is skewed.)

---

**Q** Is paper loaded correctly?

**A** Make sure the paper stack in the cassette or the paper in the multi-purpose feeder is loaded properly, and that the slide guides are adjusted correctly. (See "Loading Paper," on p. 4-3.)

**A** Make sure the paper exit path is clear.

---

Multiple sheets feed into the machine at the same time.

---

**Q** Is paper loaded correctly?

**A** Make sure the paper stack in the cassette or the paper in the multi-purpose feeder is loaded properly, and that the slide guides are adjusted correctly. (See "Loading Paper," on p. 4-3.)

**Q** Have you fanned the paper stack before loading it in the cassette?

**A** Be sure to fan the paper stack before loading it in the cassette. This keeps the sheets of paper from sticking together.



**Q** Does the cassette or multi-purpose feeder contain an appropriate quantity of sheets?

**A** Make sure the paper stack in the cassette or the paper in the multi-purpose feeder does not exceed the capacity of the cassette or multi-purpose feeder. (See "Loading Paper," on p. 4-3.)

**A** Do not force the paper stack into the cassette or the paper into the multi-purpose feeder.

**A** Load paper one by one in the multi-purpose feeder.

**Q** Is only one type of paper loaded in the cassette or multi-purpose feeder?

**A** Load only one type of paper.

**A** Make sure you load paper that meets the paper requirements for the machine. (See Chapter 4, "Paper Handling.")

---

Transparencies do not feed correctly.

---

**Q** Are the transparencies loaded correctly?

**A** Make sure the transparencies in the cassette\* or the transparency in the multi-purpose feeder is loaded properly, and that the slide guides are adjusted correctly. (See "Loading Paper," on p. 4-3.)

**Q** Is the proper transparency loaded in the multi-purpose feeder?

**A** Do not use any transparencies designed for color copiers. They will cause a paper jam. Please use transparencies recommended by Canon.  
\*Only for the FAX-L380S

---

Paper feeds curled.

---

**Q** Is the proper paper loaded?

**A** Check if the proper paper is loaded in the cassette or multi-purpose feeder. (See Chapter 4, "Paper Handling.")

---

Paper stacked roughly.

---

**Q** Is the proper paper loaded?

**A** Check if the proper paper is loaded in the cassette or multi-purpose feeder. (See Chapter 4, "Paper Handling.")

**A** Check if the appropriate paper type is selected in <PAPER TYPE> in <PAPER SETTINGS> of the Menu. (See "Loading Paper," on p. 4-3.)

---

Repeated paper jams occur.

---

**Q** Is the proper paper loaded?

**A** Check that the size, thickness and type of the paper you are using. (See "Print Media Requirements," on p. 4-1.)

**Q** Is the proper paper loaded correctly?

**A** Be sure to fan the paper stack before loading it in the cassette. This keeps the sheets of paper from sticking together.

**Q** Is the output tray free of obstructions?

**A** Do not place the delivered paper back on the output tray. (See "Face Down Paper Output Area," on p. 4-13.)

**A** Do not place objects other than paper on the output tray. (See "Face Down Paper Output Area," on p. 4-13.)

**Q** Is the machine installed in a proper location?

**A** Check that the machine is installed in the proper location. (For information about specifications of the machine, see Appendix A, "Specifications." For safety warnings and cautions, see "Choosing a Location for Your Machine," on p. 2-1.)

---

Envelopes do not feed correctly.

---

**Q** Are the envelopes loaded correctly?

**A** Make sure the envelopes are loaded correctly. (See "Loading Envelopes in the Cassette," on p. 4-5, or "Loading an Envelope in the Multi-Purpose Feeder," on p. 4-9.) Do not load more than 20 envelopes in the cassette\*. Load an envelope one by one in the multi-purpose feeder.

**Q** Is the proper envelope loaded?

**A** Load the recommended envelopes (COM10, MONARCH, DL, or ISO-C5) in the cassette\* or multi-purpose feeder. (See "Loading Envelopes in the Cassette," on p. 4-5, or "Loading an Envelope in the Multi-Purpose Feeder," on p. 4-9.)  
\*Only for the FAX-L380S model.

# Faxing Problems

## Sending Problems

---

You cannot send a fax.

---

**Q** Is the machine overheated?

**A** Unplug the machine and let it cool for approximate 3 minutes to 5 minutes. Then plug in the machine and try sending again.

**Q** Did you connect the power cord to the machine just now?

**A** Wait for a while. After connecting the power cord, the machine cannot scan documents immediately.

**Q** Is the machine set for the correct telephone line type (pulse/tone)?

**A** Make sure the machine is set for the correct telephone line type. (See "Setting the Telephone Line Type," on p. 3-5.)

**Q** Is the document loaded?

**A** Remove the document, stack it if necessary, and load it in the ADF correctly.

**Q** Is the One-Touch Speed Dial button or Coded Speed Dialing code you entered registered for the feature you want to use?

**A** Check the One-Touch Speed Dial button or Coded Speed Dialing code and make sure it is registered correctly. (See Chapter 5, "Speed Dialing.")

**Q** Did you dial a correct number? Or have you been provided with an incorrect number?

**A** Dial the number again, or check that you have the correct number.

**Q** Does the other party's fax machine have enough paper?

**A** Call the other party and ask them to make sure paper is loaded in their fax machine.

**Q** Did an error occur during sending?

**A** Print an ACTIVITY REPORT and check for an error. (See "Activity Report," on p. 13-1.)

**Q** Is the telephone line working properly?

**A** Make sure there is a dial tone when you pick up the handset of the telephone connected to the machine. If there is no dial tone, contact your local telephone company.

**Q** Is the receiving fax machine a G3 fax machine?

**A** Make sure the receiving fax machine is compatible with the machine (which is a G3 fax machine).

**Q** The other party's telephone may be busy or the other party's fax machine may be turned off. Is <BUSY/NO SIGNAL> shown on the ERROR TX REPORT?

**A** The fax/telephone number you dialed is busy. Try sending the document later.

**A** The other party's fax machine is not working. Contact the other party and have them check their fax machine.

**Q** Did the receiving fax machine answer within 55 seconds (after all automatic redialing attempts)?

**A** Contact the other party and have them check their fax machine. For an overseas call, add pauses to the registered number. (See "Dialing Long Distance," on p. 10-2.)

**Q** Is the In Use/Memory indicator lighting?

**A** The In Use/Memory indicator may light, which means the extension phone is busy. Please wait until the extension phone becomes free.

---

Faxes sent from the machine are spotted or dirty.

---

**Q** Is the machine (sending fax machine) working properly?

**A** Check the machine by making a copy. For more information, see Chapter 11, "Making Copies." If the copy is clear, the problem may be in the receiving fax machine. If the copy is spotted or dirty, clean the scanning area in the machine. For more information, see Chapter 15, "Maintaining Your Machine."

**Q** Is the document loaded?

**A** Remove the document, stack it if necessary, and load it in the ADF correctly. (See "Loading Documents in the ADF," on p. 6-3.)

---

Cannot send using ECM (Error Correction Mode).

---

**Q** Does the receiving fax machine support ECM?

**A** If the receiving fax machine does not support ECM, the document is sent in the normal mode without error checking.

---

Errors occur frequently while sending.

---

**Q** Are the telephone lines in proper condition? Or do you have a good connection?

**A** Lower the transmission speed. (See "3.TX START SPEED," on p. 16-6.)

## Receiving Problems

---

Cannot receive a fax automatically.

---

**Q** Is the machine set to receive automatically?

**A** For the machine to receive faxes automatically, the receive mode must be set to <FaxOnly> mode, <FaxTel> mode, or <AnsMode>. (See Chapter 7, "Receiving Faxes.") If you have set <AnsMode>, confirm that an answering machine is connected to the machine and that it is turned on with an outgoing message properly recorded.  
If you set <3. MAN/AUTO SWITCH> to <ON> in <FAX SETTINGS> of the Menu, the machine will receive faxes automatically even when the receive mode is set to <Manual> mode. (See "4.MAN/AUTO SWITCH," on p. 16-10.)

**Q** Is the memory full?

**A** Wait for the machine to finish any fax or print jobs stored in the memory or delete them from the memory. (See p. 12-2) Then ask the other party to resend the fax.

**Q** Did an error occur during reception?

**A** Print an ACTIVITY REPORT and check for an error. (See "Activity Report," on p. 13-1.) You can also check the RX REPORT when it is printed automatically. (See "Reception (RX) Report," on p. 13-5.)

**Q** Is the telephone line connected properly?

**A** Make sure all line connections are secure. (See "Connecting the Telephone Line," on p. 2-8.)

---

The machine does not switch automatically between telephone and fax receptions.

---

**Q** Is the machine set to switch automatically between telephone and fax receptions?

**A** For the machine to switch automatically, the receive mode must be set to <AnsMode>. (See Chapter 7, "Receiving Faxes.")  
Confirm that an answering machine is connected to the machine and that it is turned on with an outgoing message properly recorded.

**Q** Are you answering the call on a telephone connected to the machine?

**A** Answer calls using the optional handset or a telephone connected to the unit.

**Q** Is the sending fax machine able to send the CNG signal that tells the machine that the incoming signal is a fax?

**A** Some fax machines cannot send the CNG signal that tells the machine the incoming call is a fax. In such cases, you will have to receive the fax manually. (See "Receiving Faxes Manually: Manual Mode," on p.7-4.)

---

Cannot receive a document manually.

---

**Q** Is the machine set to receive manually?

**A** For the machine to receive faxes manually, the receive mode must be set to <Manual> mode. (See Chapter 7, "Receiving Faxes.")

**Q** Did you press [Start] after hanging up the handset?

**A** Always press [Start] before hanging up the handset. Otherwise you will disconnect the call.

---

Print quality is poor.

---

**Q** Are you using the correct type of paper?

**A** Make sure you load paper that meets the paper requirements for the machine. For more information, see Chapter 11, "Making Copies."

**Q** Is the sending fax machine functioning properly?

**A** The sending fax machine usually determines the fax's quality. Call the sender and have them make sure the scanning glass of their fax machine is clean.

---

Faxes do not print.

---

**Q** Is the cartridge installed properly?

**A** Make sure the cartridge is installed properly. For more information, see "Installing/Replacing the Toner Cartridge," on p. 2-18.

**Q** Is any toner left in the cartridge?

**A** Replace the cartridge with a new one. For more information, see "Installing/Replacing the Toner Cartridge," on p. 2-18.

**A** Select <KEEP PRINTING> in <TONER SUPPLY LOW> in <FAX SETTINGS> of the Menu. With this setting, the machine will not store documents in the memory even if the toner has run out. (See "2.TONER SUPPLY LOW," on p. 16-11.)

**Q** Is the correct paper loaded in the cassette?

**A** Make sure paper is loaded in the cassette. For more information, see Chapter 4, "Paper Handling."

**A** Load the correct paper size or change <PAPER SIZE> in <PAPER SETTINGS> of the Menu. For more information see Chapter 4, "Paper Handling," or Chapter 11, "Making Copies."

---

Faxed images are blotched or uneven.

---

**Q** Are the telephone lines in proper condition? Or do you have a good connection?

**A** ECM (Error Correction Mode) for sending/receiving should eliminate such problems. However, if the telephone lines are in poor condition, you may have to try again. Then call the sender to resend the document.

**Q** Is the sending fax machine functioning properly?

**A** The sending fax machine usually determines the fax's quality. Call the sender and have them make sure the scanning glass of their fax machine is clean.

---

Cannot receive a fax using ECM (Error Correction Mode).

---

**Q** Does the sending fax machine support ECM?

**A** If the sending fax machine does not support ECM, the document is received in the normal mode without error checking.

---

Errors occur frequently while receiving.

---

**Q** Is the sending fax machine functioning properly?

**A** Call the sender and have them check that their fax machine is functioning properly.

# Telephone Problems

---

---

You cannot dial.

---

**Q** Is the telephone line connected properly?

**A** Make sure all line connections are secure. (See "Connecting the Telephone Line," on p. 2-8.)

**Q** Is the machine set for the correct telephone line type (pulse/tone)?

**A** Make sure the machine is set for the correct telephone line type. (See "Setting the Telephone Line Type," on p.3-5.)

---

The telephone disconnects while you are talking.

---

**Q** Is the telephone line connected in securely?

**A** Check that the telephone cables are connected securely to the jacks on the machine, the telephone jack on your wall and the jack on your telephone. (See "Connecting the Telephone Line," on p. 2-8.)



# Copying Problems

---

The machine will not make a copy.

---

**Q** Is the cartridge installed correctly?

**A** Make sure the cartridge is installed correctly. (See "Installing/Replacing the Toner Cartridge," on p. 2-18.)

**Q** Is the sealing tape removed from the cartridge?

**A** Remove the sealing tape from the cartridge. (See "Installing/Replacing the Toner Cartridge," on p. 2-18.)

**Q** Is the cassette inserted completely into the machine?

**A** Insert the cassette as far as it will go. (See "Loading Paper in the Cassette," on p. 2-22.)

**Q** Did you connect the power cord to the machine just now?

**A** Wait for a while. After connecting the power cord, the machine cannot scan documents immediately.

**Q** Is the document loaded correctly?

**A** Remove the document, stack it if necessary, and load it in the ADF correctly. (See "Loading Documents in the ADF," on p. 6-3.)

**A** Make sure the ADF is closed.

---

If the documents have black streaks or appear dirty after you feed them in the ADF.

---

**Q** Are the scanning glass and rollers of the ADF clean?

**A** Clean the scanning glass and rollers of the ADF. (See "Cleaning the ADF Area," on p. 15-2.)



## NOTE

*For additional troubleshooting, see "Print Quality Problems," on p. 14-22.*

# Print Quality Problems

---

The print quality is not what you expect; print is not clear, has missing dots or white streaks.

---

**Q** Are the size, thickness and type of the paper you are using within the specifications of the machine?

**A** Check that the paper you are using is supported by the specifications of the machine. (See "Print Media Requirements," on p. 4-1.)

**Q** Is the cartridge installed correctly?

**A** Make sure the cartridge is installed correctly. (See "Installing/Replacing the Toner Cartridge," on p. 2-18.)

**Q** Is any toner left in the cartridge?

**A** Replace the cartridge if necessary. (See "Installing/Replacing the Toner Cartridge," on p. 2-18.)

**Q** Is the exposure adjusted correctly?

**A** Adjust the exposure correctly using [Exposure]. (See "Adjusting the Exposure (Density)," on p. 11-6.)

---

Copies are dirty.

---

**Q** Is the scanning glass or the scanning glass cover clean?

**A** Clean the scanning glass or the scanning glass cover. (See "Cleaning the ADF Area," on p. 15-2.)

**Q** Is the cartridge free of damage?

**A** If there is a scratch on the cartridge, replace with a new one. (See "Installing/Replacing the Toner Cartridge," on p. 2-18.)

**Q** Is the machine adjusted to room temperature? If not, condensation might build up inside the machine.

**A** Allow at least 2 hours for the machine to adjust to room temperature before attempting to use it.

**Q** Is the machine installed in a stable location?

**A** Install the machine in a proper location. (See "Choosing a Location for Your Machine," on p. 2-1.)

---

Copies are too dark or too light.

---

**Q** Is the exposure adjusted correctly?

**A** Adjust the exposure correctly using [Exposure]. (See "Adjusting the Exposure (Density)," on p. 11-6.)

**Q** Is the machine in the toner saver mode?

**A** Set <TONER SAVER MODE> to "OFF" in <COMMON SETTINGS> of the Menu. (See "5.TONER SAVER MODE," on p. 16-4.)

---

The printouts are partly missing or shaded when you make copies on heavy paper.

---

**Q** Is the paper type set correctly?

**A** Select <HEAVY PAPER> or <HEAVY PAPER H> in <PAPER TYPE> in <PAPER SETTINGS> of the Menu. (See "Loading Paper," on p. 4-3.)

---

The printouts are missing when you make copies on rough paper.

---

**Q** Is the paper type set correctly?

**A** Select <TRANSPARENCY> in <PAPER TYPE> in <PAPER SETTINGS> of the Menu. (See "Loading Paper," on p. 4-3.)

---

The edges of copies are dirty when you make copies.

---

**Q** Is the paper size set correctly?

**A** Specify the appropriate paper size in <PAPER SIZE> in <PAPER SETTINGS> of the Menu. (See "Loading Paper," on p. 4-3.)

**Q** Is <FREESIZE> selected for the paper size?

**A** Specify the appropriate size in <VERTICAL SIZE> or <HORIZONTAL SIZE> in <FREESIZE> in <PAPER SETTINGS> of the Menu. (See "Specifying the Paper Size," on p. 11-2.)

# Printing Problems

---

The Alarm indicator comes on.

---

**Q** Does the machine feed paper correctly, or is there paper in the cassette or multi-purpose feeder?

**A** Clear the paper jam, or load paper in the cassette or multi-purpose feeder. (For instructions on clearing paper jam, see "Clearing Jams," on p. 14-1. For instructions on loading paper, see "Loading Paper," on p. 4-3.)

**A** If the machine has no paper jam, or paper is loaded in the cassette or multi-purpose feeder, unplug the machine and wait approx. 3 minutes to 5 minutes, then plug it in again. If the problem is fixed, the Alarm indicator will turn off, and the LCD will return to the standby mode. If the Alarm indicator remains flash, unplug the machine, and contact your local authorized Canon dealer or the Canon help line.

---

Printout does not match paper size.

---

**Q** Is the paper stack loaded and aligned correctly in the cassette, or is paper loaded in the multi-purpose feeder correctly?

**A** Make sure the paper is loaded and aligned correctly in the cassette or the paper is loaded correctly in the multi-purpose feeder. (See "Loading Paper," on p. 4-3.)

**Q** Is the appropriate paper size set through the operation panel?

**A** Specify the appropriate paper size in <PAPER SIZE> in <PAPER SETTINGS> of the Menu. (See "Loading Paper in the Cassette," on p. 4-3.)

# If You Cannot Solve the Problem

If you have a problem with your machine and cannot solve it using the information in this chapter, contact your local authorized Canon dealer or the Canon help line.



## CAUTION

If the machine makes strange noises, emits smoke or strange smells, unplug it immediately and contact your local authorized Canon dealer or the Canon help line. Do not attempt to disassemble or repair the machine yourself.



## NOTE

Attempting to repair the machine yourself may void the limited warranty.

Before contacting your local authorized Canon dealer or the Canon help line, make sure you have the following information about your machine:

- The machine's name: FAX-L380S/L390
- The machine serial number (on a label on the back of the machine)

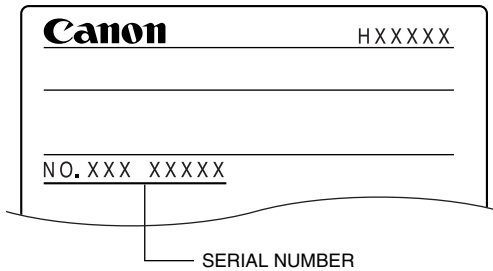

- Where you purchased the machine
- A detailed description of the problem
- The steps you have taken to solve the problem, and the results

# Maintaining Your Machine

# 15

## CHAPTER

Your machine requires no maintenance other than periodic cleaning, and replacing of the toner cartridge as needed.

## Cleaning the Machine

Clean your machine regularly to keep it in good operating condition.



### NOTE

*Follow these precautions whenever you clean the machine:*

- *When cleaning the machine's exterior or the scanning glass, be sure to disconnect the power cord before cleaning the machine.*
- *When the power cord is disconnected, any documents stored in memory will be erased if you leave the machine unplugged for 1 hour or more. Be sure to plug the machine in after cleaning to avoid this happening. If <RECEIVED IN MEMORY> appears in the LCD display, follow steps on p. 7-6 to print out the document.*
- *If you disconnect the machine while it is waiting to send a document, you will have to set the machine to send your document again once you finish cleaning the machine. However, when you have set a document for delayed transmission, the machine holds the document in its memory for about 1 hour.*
- *Do not use tissue paper, paper towels, or similar materials for cleaning; they can stick to the components or generate static charges.*
- *Never use volatile liquids such as thinner, benzene, acetone, or any other chemical cleaner to clean the interior of the machine; these can damage the machine's components.*

## Cleaning the Machine's Exterior

- 1 Disconnect the power cord.
- 2 Wipe the machine's exterior with a clean, soft, lint-free cloth moistened with water or diluted dishwashing detergent solution.



### CAUTION

Never use thinner, benzene, alcohol, or any other organic solvent to clean the machine, as these can damage the machine's surface.

- 3 Plug the power cord back in.

## Cleaning the ADF Area

Black lines may appear in printouts when the ADF is used to feed documents.

This is caused by paste, ink, correction fluid, or other foreign matters in the read area of the ADF. Use a clean soft cloth to wipe the read area clean. Take particular care to clean at the locations where the black lines are appearing on printouts.

If you have trouble getting the glass clean, wipe with a cloth moistened with water or a mild neutral detergent, and then wipe the glass dry with another cloth.

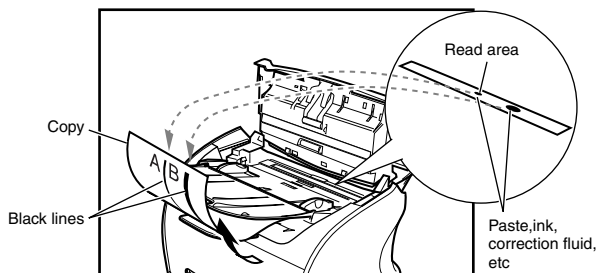

### IMPORTANT

*Paste, ink, correction fluid, and other foreign matter can soil the scanning glass when you send a document through the ADF while the paste, ink, or correction fluid on the original is still wet. This is what causes black lines on copies. Whenever you load a document in the ADF, always check to make sure that any paste, ink, or correction fluid that is on the document is completely dry.*



### NOTE

*When you unplug the machine, any documents stored in memory will be erased if you leave the machine unplugged for 1 hour or more. Be sure to plug in the machine after cleaning to avoid this happening.*

**1** Disconnect the power cord.

**2** Open the operation panel by gently pulling it up.

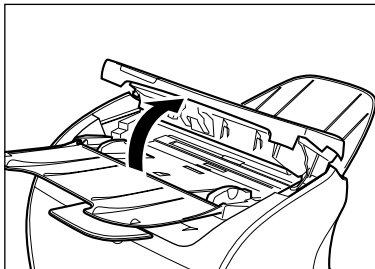

**3** Use a soft, dry, clean cloth to clean the scanning glass and rollers (shaded areas).

- If the document scanning glass and rollers are dirty, the documents you send or print will also be dirty.
- Clean with a soft cloth that will not scratch the glass or rollers.
- Use a soft, dry, clean cloth to wipe up paper dust around the rollers.

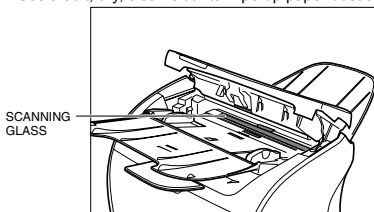

**4** Clean the shaded areas of the operation panel and the machine.

Dirt and dust particles that collect on the underside of the operation panel also affect the quality of documents you copy and send.

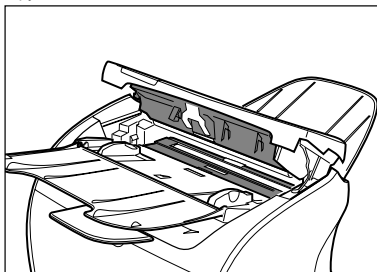



**5** When you finished, close the operation panel by pressing it down from the center.



**NOTE**

*Be sure to close the operation panel until it locks into place. Otherwise the machine will not function properly.*

**6** Plug the power cord back in.

# Transporting the machine

---

Be sure to disconnect the power cord before transporting the machine. If the machine is likely to be subjected to vibration (e.g., when transporting over long distances), the following precautions should be taken. If you do not follow these precautions, the machine may be damaged or the quality of your printouts may be adversely affected.

---

- 1** Disconnect the power cord.
- 2** If the machine is connected to a telephone or your computer, remove the telephone line or printer cable.
- 3** Open the printer cover.
- 4** Grip the end of the cartridge, and remove it from the machine. In order to avoid direct sunlight, place the cartridge in the protective bag that the cartridge came in when you purchased it.
- 5** Close the printer cover.
- 6** Pull out the cassette completely, and remove the extension cover from the machine.
- 7** Detach the cassette extension from the cassette.
- 8** Insert the cassette in the machine.
- 9** Remove the output tray and document output tray.

# The Menu System

The Menu allows you to specify or register various settings. This chapter explains the procedure to access the menus and their contents.

## Accessing the Menu

**1** Press [Menu].

**2** Press [◀(-)] or [▶(+)] to select the menu you want to change → press [OK].

ADDITIONAL FUNCTIONS 3. COPY SETTINGS	→	COPY SETTINGS 1. STD. IMAGEQUALITY
--	---	---------------------------------------

**3** Press [◀(-)] or [▶(+)] to select the submenu you want to change → press [OK].

COPY SETTINGS 2. STANDARD EXPOSURE	→	STANDARD EXPOSURE MANUAL
---------------------------------------	---	-----------------------------



### NOTE

- For details on submenus, see "Menu Descriptions," on p. 16-2.
- After selecting the item or value with [◀(-)] or [▶(+)], press [OK] to enter the setting.
- If you press [Stop/Reset] before [OK] is pressed, the item you have selected will not be registered.
- Press [Stop/Reset] to exit from the Menu.
- If you press [Menu], the display returns to the previous screen.

# Menu Descriptions

## 1. PAPER SETTINGS

Name	Descriptions
1.CASSETTE	
1.PAPER SIZE	Sets the paper size for the paper cassette. FAX-L380S: <b>A4</b> , B5, A5, LTR, EXECUTIV, ENVELOPE (You can select from COM10, MONARCH, DL, or ISO-C5.) FAX-L390: <b>A4</b> , LTR
2.PAPER TYPE	Sets the paper type to be used in the paper cassette. FAX-L380S: <b>PLAIN PAPER</b> , TRANSPARENCY, PLAIN PAPER L, HEAVY PAPER, HEAVY PAPER H FAX-L390: <b>PLAIN PAPER</b> , PLAIN PAPER L
2.MP TRAY	
1.PAPER SIZE	Sets the paper size for the multi-purpose feeder. <b>A4</b> , B5, A5, LTR, LGL, EXECUTIV, ENVELOPE (You can select from DL, ISO-C5, COM10, or MONARCH), FREESIZE (Horizontal and vertical size can be specified in millimeters.)
2.PAPER TYPE	Sets the paper type to be used on the multi-purpose feeder. <b>PLAIN PAPER</b> , TRANSPARENCY, PLAIN PAPER L, HEAVY PAPER, HEAVY PAPER H

(The factory default setting is in **bold** face.)

## 2. COMMON SETTINGS

Name	Descriptions
1.DEFAULT SETTINGS	Selects which mode is displayed in the LCD when the power cord is connected, or the AUTO CLEAR function activates.
COPY	The Copy mode is selected.
<b>FAX</b>	The Fax mode is selected.
2.SW AFTER AUTO CLR	Selects whether the machine switches to the mode you set in <DEFAULT SETTINGS> after the AUTO CLEAR function activates.
<b>DEFAULT MODE</b>	The machine automatically switches to the mode you set in <DEFAULT SETTINGS> after the AUTO CLEAR function activates.
CURRENT MODE	The machine does not automatically switch to the mode you set in <DEFAULT SETTINGS> even after the AUTO CLEAR function activates.
3.VOLUME CONTROL	Adjusts the volume of the machine.
1.KEYPAD VOLUME	Adjusts the keypad volume.
<b>ON</b>	1 to 3
OFF	The volume is turned off.
2.ALARM VOLUME	Adjusts the alarm volume.
<b>ON</b>	1 to 3
OFF	The volume is turned off.
3.TX DONE TONE	Adjusts the volume of the done tone sounded when the machine has finished sending faxes.
ON	1 to 3
<b>ERROR ONLY</b>	1 to 3
OFF	The volume is turned off.

(The factory default setting is in **bold** face.)

Name	Descriptions
4.RX DONE TONE	Adjusts the volume of the done tone sounded when the machine has finished receiving faxes.
ON	1 to 3
<b>ERROR ONLY</b>	1 to 3
OFF	The volume is turned off.
5.PRINTING END TONE	Adjusts the volume of the done tone sounded when the machine has finished printing.
ON	1 to 3
<b>ERROR ONLY</b>	1 to 3
OFF	The volume is turned off.
6.SCANNING END TONE	Adjusts the volume of the done tone sounded when the machine finished scanning.
ON	1 to 3
<b>ERROR ONLY</b>	1 to 3
OFF	The volume is turned off.
7.LINE MONITOR VOL.	Adjusts the line monitor volume.
<b>ON</b>	1 to 3 (2)
OFF	The volume is turned off.
4.PRINT EXPOSURE	Adjusts the exposure to one of 5 levels. ( <b>center</b> )
5.TONER SAVER MODE	Sets the toner saver mode.
ON	The toner saver mode is turned on.
<b>OFF</b>	The toner saver mode is turned off.
6.DISPLAY LANGUAGE	Select the message language. <b>ENGLISH</b> , FRENCH, SPANISH, GERMAN, ITALIAN, DUTCH, FINNISH, PORTUGUESE, NORWEGIAN, SWEDISH, DANISH, SLOVENE, CZECH, HUNGARIAN, RUSSIAN

(The factory default setting is in **bold** face.)

### 3. COPY SETTINGS

Name	Descriptions
1.STD. IMAGEQUALITY	Select the document type. <b>TEXT ORIGINAL</b> : Character mode TEXT/PHOTO*1: Text/photo mode PHOTO*1: Photo mode
2.STANDARD EXPOSURE	Select the auto or manual mode of exposure setting.
AUTO*2	The exposure is adjusted automatically.
<b>MANUAL</b>	The exposure is adjusted manually. The exposure can be adjusted in 9 steps. <b>(center)</b>
3.STD ZOOM RATIO	Selects the copy ratio 050% to 200%. <b>(100%)</b>
4.STANDARD COPY QTY	Select the copy quantity. 01 to 99 <b>(01)</b>
5.AUTO SORT	Set the auto sort.
ON	The auto sort function is turned on.
<b>OFF</b>	The auto sort function is turned off.
6.PAPER SIZE GROUP	The paper size group can be selected. If the paper size group is changed, the preset copy ratios will change.
INCH	Preset copy ratios:50%, 64%, 78%, 100%, 129%, 200%
<b>A</b>	Preset copy ratios:50%, 70%, 100%, 141%, 200%
AB	Preset copy ratios:50%, 70%, 81%, 86%, 100%, 115%, 141%, 200%
7.SHARPNESS	Black and white of an image can be sharpened. When you want to make characters and lines clear, select a big number. When you make copies of photographs, select a small number. 1 to 9 <b>(5)</b>

(The factory default setting is in **bold** face.)

\*1 STANDARD EXPOSURE automatically changes to MANUAL when TEXT/PHOTO or PHOTO is selected.

\*2 STD. IMAGEQUALITY automatically changes to TEXT ORIGINAL when AUTO is selected.

## 4. FAX SETTINGS

Name	Descriptions
1.USER SETTINGS	Specifies the basic operation settings in the Fax mode.
1.TEL LINE SETTINGS	Specifies the telephone line settings.
1.USER TEL NO.	Your telephone and fax number can be registered within 20 digits, including spaces.
2.TEL LINE TYPE	Selects the telephone line type.
<b>TOUCH TONE</b>	The telephone line is set for touch tone dialing.
<b>ROTARY PULSE</b>	The telephone line is set for rotary pulse dialing.
3.TX START SPEED	Sets the transmission speed for all documents you send. <b>33600bps/14400bps/9600bps/7200bps/4800bps/2400bps</b>
4.RX START SPEED	Sets the transmission speed for all documents you receive. <b>33600bps/14400bps/9600bps/7200bps/4800bps/2400bps</b>
2.UNIT NAME	You can register your name or your company name within 24 characters, including spaces.
3.TX TERMINAL ID	Prints your ID (Transmitting Terminal ID) on each page you transmit.
<b>ON</b>	After you turn the terminal ID on, you can do the following settings.
1.TTI POSITION	<b>OUTSIDE IMAGE:</b> Terminal ID is printed outside the image border. <b>INSIDE IMAGE:</b> Terminal ID is printed inside the image border.
2.TEL NUMBER MARK	Selects the prefix for the identification header number. <b>FAX, TEL</b>
OFF	No terminal ID is printed on the pages you send.

(The factory default setting is in **bold** face.)



Name	Descriptions
4.DENSITY CONTROL	Adjusts the scanning density.
1.LIGHT	Sets for dark documents. <b>(3)</b>
2.STANDARD	Sets for standard documents. <b>(5)</b>
3.DARK	Sets for light documents. <b>(7)</b>
5.OFFHOOK ALARM	Enables/disables the offhook alarm that alerts you when the handset is not in the handset cradle.
<b>ON</b>	After reception, the offhook alarm sounds when the handset is left off the hook.
OFF	No offhook alarm.
6.R-KEY SETTING	Sets how the fax connects to PBX. If your fax machine is not connected through a PBX, you can ignore these settings.
<b>PSTN</b>	The fax is connected to the outside line.
PBX	The fax is connected through a PBX. Select one of the following settings, depending on the type of PBX in service. Two settings are available: <b>HOOKING</b> PREFIX If you select PREFIX, you can set a number up to 20 digits long, including the "P" at the end.
2.REPORT SETTINGS	Sets the report setting.
1.TX REPORT	Enables/disables automatic printing of a transmission report.
OUTPUT NO	No report is printed.
<b>PRINT ERROR ONLY</b>	Prints a report only when a transmission error occurs.
REPORT WITH TX IMAGE	Enables/disables printing of the first page of the fax under the report.
ON	Prints the first page.
<b>OFF</b>	No first page is printed.

(The factory default setting is in **bold** face.)

Name	Descriptions
OUTPUT YES	Prints a report every time you send a document.
REPORT WITH TX IMAGE	Enables/disables printing of the first page of the fax under the report.
ON	Prints the first page.
OFF	No first page is printed.
2.RX REPORT	Enables/disables automatic printing of a reception report.
OUTPUT NO	No report is printed.
PRINT ERROR ONLY	Prints a report only when a reception error occurs.
OUTPUT YES	Prints a report every time you receive a document.
3.ACTIVITY REPORT	Enables/disables automatic printing of an ACTIVITY REPORT after every 20 transactions.
ON	Prints the ACTIVITY REPORT.
OFF	No ACTIVITY REPORT is printed.
3.TX SETTINGS	Sets the transmission functions.
1.ECM TX	ECM (Error Correction Mode) transmission is turned on or off.
ON	All transmissions are conducted with ECM if the other party's fax supports ECM.
OFF	ECM is turned off.
2.PAUSE TIME	Sets the length of the pause you insert into a dialing sequence. 01 to 15SEC ( <b>04 SEC</b> )

(The factory default setting is in **bold** face.)

Name	Descriptions
3.AUTO REDIAL	Sets whether to perform automatic redial when the other line is busy or no answer.
<b>ON</b>	Customizes the redial operation.
1.REDIAL TIMES	Sets the number of retries. 01 to 10TIMES ( <b>02 TIMES</b> )
2.REDIAL INTERVAL	Sets period of time between redialings. 02 to 99MIN. ( <b>02 MIN.</b> )
OFF	After the first attempt at dialing fails, redialing is not attempted.
4.TIME OUT	Enables/disables automatic scanning of documents after the fax number is entered by using speed dialing.
<b>ON</b>	Scanning begins automatically in 5 or 10 seconds after you enter the phone number.
OFF	Press [Start] to scan document. Otherwise, AUTO CLEAR function activates and the LCD returns to standby mode after 2 minutes.
4.RX SETTINGS	Sets the reception functions.
1.ECM RX	ECM (Error Correction Mode) reception is turned on or off.
<b>ON</b>	All receptions are conducted with ECM if the other party's fax supports ECM.
OFF	ECM is turned off.
2.FAX/TEL OPT. SET	When FaxTel has been set, the optional settings are available.
1.RING START TIME	Sets the duration that the machine listens for a fax tone before starting to ring. 00 to 30SEC ( <b>08 SEC</b> )

(The factory default setting is in **bold** face.)

Name	Descriptions
2.F/T RING TIME	Sets the length of time the machine rings to alert you of an incoming call. 010 to 060SEC ( <b>022 SEC</b> )
3.F/T SWITCH ACTION	Selects the action taken after the F/T RING TIME expires.
<b>RECEIVE</b>	The machine switches to the fax receive mode automatically at this point and starts to receive the document.
DISCONNECT	The machine disconnects the call.
3.INCOMING RING	Sets whether the machine rings when it receives a call when the machine is set to FaxOnly.
<b>OFF</b>	The machine does not ring when it receives a fax. (In Energy Saver mode, the fax may ring one or two times.)
ON	The machine rings when it receives a fax if a telephone is connected.
RING COUNT	Sets the number of incoming rings before the machine answers. 01 to 99TIMES ( <b>02TIMES</b> )
4.MAN/AUTO SWITCH	Sets whether the machine switches to document receive mode after ringing for a specified length of time in the manual receive mode.
<b>OFF</b>	The machine keeps ringing until someone answers the call manually with a connected extension telephone.
ON	The machine switches to document receive mode after ringing for a specified time.
F/T RING TIME	Sets the length of time to elapse before the machine switches to the document receiving. 01 to 99SEC ( <b>15SEC</b> )

(The factory default setting is in **bold** face.)

Name	Descriptions
5.REMOTE RX	Enables/disables remote receiving.
<b>ON</b>	The machine enables remote receiving.
REMOTE RX ID	You can dial code on the remote extension to start receiving a document. A combination of two characters using [0] to [9], [*] and [#] is possible. <b>(25)</b>
OFF	The machine disables remote receiving.
5.PRINTER SETTINGS	Sets the print functions.
1.RX REDUCTION	Receives images at a reduced size.
<b>ON</b>	Image reduction is turned on.
1.RX REDUCTION	<b>AUTO SELECTION:</b> Reducing size is set automatically. <b>FIXED REDUCTION:</b> Reducing size is preset. 97%, 95%, <b>90%</b> , 75%
2.SELECT REDUCE DIR	<b>VERTICAL ONLY:</b> Reduction is performed in the vertical direction only. <b>HORIZ &amp; VERTICAL:</b> Reduction is performed in the horizontal and vertical direction.
OFF	Image reduction is turned off.
2.TONER SUPPLY LOW	Allows you to set how the machine responds when the toner supply is low.
<b>RX TO MEMORY</b>	The machine receives all documents in memory.
KEEP PRINTING	The keep printing function is turned on. With this setting, the machine will not store documents in memory if the toner has run out. Re-set to RX TO MEMORY after replacing the cartridge with a new one.

(The factory default setting is in **bold** face.)

Name	Descriptions
6.POLLING BOX	Sets the functions of SETUP FILE, CHANGE DATA and DELETE FILE.
1.SETUP FILE	Registers a polling box.
1.FILE NAME	Enters a name for poling box (Max. 24 characters, including spaces).
2.PASSWORD	Enters a password to protect the polling box settings (Max. 7 characters).
3.ERASE AFTER TX	Tells the machine how to handle a document after it is polled and sent. <b>ON, OFF</b>
2.CHANGE DATA	Changes the settings of the polling box.
1.FILE NAME	Changes the file name.
2.PASSWORD	Changes the password.
3.ERASE AFTER TX	Changes the ERASE AFTER TX setting.
3.DELETE FILE	Deletes the polling box and all of its settings.
7.SYSTEM SETTINGS	Sets the functions of MEMORY LOCK RX, FAX DEFAULT, LOCK PHONE and COUNTRY SELECT.
1.MEMORY LOCK RX	Sets the Memory Lock functions.
<b>OFF</b>	Prints a document as soon as the machine receives it.
ON	Receives and stores all documents in memory. They will not be printed out unless the Memory Lock password is entered.
1.MEM LOCK PASSWORD	0 to 9999999 This password protects the Memory Lock settings. Setting a password is recommended. You must use this password to unlock the memory so you can print documents stored in memory. Use the numeric buttons to enter a password (up to seven digits).
2.REPORT	Sets the machine to print reports. This setting affects only reports that print automatically, such as an Activity Report.

(The factory default setting is in **bold face**.)

Name	Descriptions
<b>OUTPUT NO</b>	No report prints while in the Memory Lock mode.
OUTPUT YES	A report prints while the machine is in the Memory Lock mode.
2.FAX DEFAULT	Sets the FAX DEFAULT functions.
1.RESOLUTION	Sets the fax resolution.
<b>OFF</b>	The setting of resolution set using [Image Quality] remains even after the AUTO CLEAR function activates.
STANDARD	Suitable for most text-only documents.
FINE	Suitable for fine-print documents.
PHOTO	Suitable for documents that contain photographs.
SUPER FINE	Suitable for documents that contain fine print and images. (The resolution is four times that of STANDARD)
ULTRA FINE	Suitable for documents that contain fine print and images. (The resolution is eight times that of STANDARD)
2.SCAN DENSITY	Sets the machine's standard scanning density. <b>OFF</b> , LIGHT, STANDARD, DARK
3.LOCK PHONE	Sets the LOCK PHONE functions.
<b>OFF</b>	Outgoing voice call is operational.
ON	Outgoing voice call is not operational.
4.COUNTRY SELECT*	Selects the country where you are using your machine. <b>UK</b> /GERMANY/FRANCE/ITALY/SPAIN/ HOLLAND/ DENMARK/NORWAY/SWEDEN/FINLAND/ AUSTRIA/ BELGIUM/SWITZERLAND/PORTUGAL/ IRELAND/ GREECE/LUXEMBOURG/HUNGARY/CZECH/ RUSSIA/SLOVENIA/SOUTH AFRICA/ OTHERS

(The factory default setting is in **bold** face.)

\* This setting is only available for some countries.

## 5. ADD. REGISTRATION

Name	Descriptions
1.1-TOUCH SPD DIAL	Registers the information on One-Touch Speed Dialing. Up to 31 destinations can be registered.
1-TOUCH SPD DIAL	Selects a One-Touch Speed Dial button.
1.TEL NUMBER ENTRY	Registers the other party's telephone number (Max. 120 digits, including spaces).
2.NAME	Registers the other party's name (Max. 16 characters, including spaces).
2.CODED SPD DIAL	Registers the information on Coded Speed Dialing.
CODED SPD DIAL	Selects a Coded Speed Dialing code.
1.TEL NUMBER ENTRY	Registers the other party's telephone number (Max. 120 digits, including spaces).
2.NAME	Registers the other party's name (Max. 16 characters, including spaces).
3.GROUP DIAL	Registers the information on Group Dialing.
1.TEL NUMBER ENTRY	Registers the other party's telephone numbers by specifying the One-Touch Speed Dial buttons or Coded Speed Dialing codes.
2.NAME	Registers the group's name (Max. 16 characters, including spaces).

(The factory default setting is in **bold** face.)

## 6. PRINTER SETTINGS

Name	Descriptions
1.PRESET PRINT QTY	Sets the standard number of pages of the printer function. 01 to 99 ( <b>01</b> )
2.AUTO ERROR SKIP	Sets either printing with skipping an error automatically, or without skipping an error.

(The factory default setting is in **bold** face.)



Name	Descriptions
<b>ON</b>	The auto error skip is on. The error is skipped and shifted to the next job automatically without indicating an error code.
OFF	The auto error skip is off. Skip the error and shift to the next job manually.
3.ERROR TIME OUT	Sets the length of time before the machine returns an error when no data is received from the computer.
<b>ON</b>	The error time out is on. Sets time out period 005SEC to 300SEC. ( <b>015SEC</b> )
OFF	The error time out is off.
4.PRINTER RESET	Cancels the job currently being received and the job already received.

(The factory default setting is in **bold** face.)

## 7. TIMER SETTINGS

Name	Descriptions
1.DATE/TIME SETTING	Enter the current date and time.
2.AUTO CLEAR	Sets the auto clear function. If the machine remains idle for a certain period of time, the display returns to the standby mode.
<b>ON</b>	The auto clear function is turned on. 1MIN. to 9MIN. ( <b>2MIN.</b> )
OFF	The auto clear function is turned off.
3.ENERGY SAVER	Sets the energy saver mode.
<b>ON</b>	The energy saver mode is set. 03MIN. to 30MIN. ( <b>05MIN.</b> )
OFF	The energy saver mode is turned off.
4.DATE SETUP	Set the format for the DATE & TIME settings menu and how the date is displayed in the LCD. <b>DD/MM YYYY, YYYY MM/DD, MM/DD/YYYY</b>

(The factory default setting is in **bold** face.)

Name	Descriptions
5.SUMMER TIME	Sets the summer time.
<b>OFF</b>	The summer time setting is disabled.
<b>ON</b>	The summer time setting is enabled.
1.BEGIN DATE/TIME	Sets the MONTH, WEEK, DAY and TIME when the summer time starts.
2.END DATE/TIME	Sets the MONTH, WEEK, DAY and TIME when the summer time ends.

(The factory default setting is in **bold face**.)

## 8. SYSTEM SETTINGS

Name	Descriptions
SYSTEM SETTINGS PASSWORD	Enter the system password protecting the system settings. (You do not have to do this if the system settings are not yet password protected.)
1.SYS. ADMIN. INFO	Set the System Administrator's ID and password to protect the system settings. You cannot use '0' for the System Administrator's ID. If you set the System Administrator's ID to 0, the registered System Administrator's ID is deleted.
1.SYS. ADMIN. ID.	1-9999999
2.SYSTEM PASSWORD	1-9999999
2.DEPT. ID MANAGEMNT	Set restrictions for sending and printing with Department IDs and passwords.
<b>OFF</b>	Department ID management function is turned 'OFF'.
ON	Department ID management function is turned 'ON'. Set how the use of the machine will be restricted.

(The factory default setting is in **bold face**.)

Name	Descriptions
1.DEPT. ID ENTRY	Set the Department ID number from 00 to 99, and enter the Department ID from 1 to 9999999. You cannot set the Department ID and password to 0.
1.PASSWORD	1-9999999
2.COPY LIMITS	0-999999
3.TX LIMITS	0-999999
2.COUNT MANAGEMENT	
1.COUNT INFORMATION	Display the counter information for each department.
1.PRINT COUNT	
2.SEND COUNT	
2.COUNT RESET	Reset the counter.
1. <b>ON</b>	
2. OFF	
3.RESTRICTIONS	Prints out a list of items set or registered in the Menu.
1.RESTRICT PRINTING <b>OFF</b> ON	Set the printing limits 'ON' or 'OFF'. If RESTRICT PRINTING is turned 'ON', the printing operations, such as printing reports manually, or documents stored in memory, are counted in the COPY LIMITS function.
2.RESTRICT TX <b>OFF</b> ON	Set the sending restriction 'ON' or 'OFF'. If RESTRICT TX is turned 'ON', the sending operations are counted in the TX LIMITS function.

(The factory default setting is in **bold** face.)

## 9. PRINT LISTS

Name	Descriptions
1.USER DATA	Prints out a list of items set or registered in the Menu.
2.SPEED DIAL LIST	Prints the list of the fax/telephone numbers registered for One-Touch Speed Dial buttons, Coded Speed Dialing codes or group dialing.
1.1-TOUCH LIST	Prints the One-touch List.
1.NO SORT	The printout of the list is not sorted.
2.SORT	The printout of the list is sorted.
2.CODED DIAL LIST	Prints the Coded Dial List.
1.NO SORT	The printout of the list is not sorted.
2.SORT	The printout of the list is sorted.
3.GROUP DIAL LIST	Prints the Group Dial List.
3.DEPT. INFO LIST	Prints out the DEPT. INFO LIST. When DEPT. ID is set, enter the DEPT. ID to print the DEPT. INFO LIST.
4.CANCEL REPORT	Cancels printout of the report. Select report you want to cancel the printout.
REPORT STATUS	Displays the report status and allows you to select the report job to be canceled. Select a job → press [OK].
CANCEL REPORT? YES	The printout of the list is canceled.
CANCEL REPORT? NO	The printout of the list is not canceled.

(The factory default setting is in **bold** face.)

# Specifications

# A

## APPENDIX

The specifications for the machine are listed in this section.

## General

Applicable line:	Public Switched Telephone Network
Compatibility:	G3
Data compression system:	MH, MR, MMR, JBIG
Modem type:	FAX modem
Modem speed:	33600, 31200, 28800, 26400, 24000, 21600, 19200, 16800, 14400, 12000, 9600, 7200, 4800, 2400 bps (automatic fallback)
Transmission speed:	Approx. 3 seconds/page* (transmitting from memory)
Transmission/reception memory	Approx. 8 MB, DRAM, JBIG storage Approx. 510 pages** LCD displays memory used
Liquid crystal display:	20 × 2
Display languages:	ENGLISH, FRENCH, SPANISH, GERMAN, ITALIAN, DUTCH, FINNISH, PORTUGUESE, NORWEGIAN, SWEDISH, DANISH, SLOVENE, CZECH, HUNGARIAN, RUSSIAN
Power source:	200–240 V/ 50/60 Hz
Power consumption:	Maximum: Approx. 800 W Minimum: Approx. 10 W Energy Saver Mode: 7 W
Dimensions (W × D × H):	FAX-L380S: 438 × 401 × 336 mm FAX-L390: 441 × 466 × 392 mm (main machine only, no trays, no optional handset)
Weight:	Approx. 11 kg (12.1 kg for the FAX-L390 model)
Environmental requirements:	Temperature: 10°–32.5°C Humidity: 20–80% RH Electrical safety: GS, EN60950, FIMKO Radiation: CISPR Pub 22, Class B
Applicable standards:	PTT Energy Star compliant CE Marking
PC Interface:	USB Interface

\* Based on Canon FAX Standard Chart No.1, JBIG, standard mode

\*\* Based on Canon FAX Standard Chart No.1, standard mode

# Plain Paper Fax

Automatic document feeder capacity:	50 A4- or LTR-size sheets 20 LGL-size sheets 1 sheet for sizes other than A4-, LTR, or LGL-size sheets.
Document size:	Multi-page document: Max.: 216 × 356 mm/ Min.: 148 × 105 mm One-page document: Max.: 216 mm × approx. 1 m/ Min.: 148 × 105 mm
Document thickness:	Multi-page document: 0.07 – 0.13 mm One-page document: 0.06 – 0.23 mm
Document weight:	Multi-page document: 50 – 105 g/m <sup>2</sup> One-page document: 50 – 240 g/m <sup>2</sup>
Transmission time:	Approx. 3 seconds** (G3 JBIG)
Resolution:	Standard mode: 8 pels/mm × 3.85 lines/mm Fine mode: 8 pels/mm × 7.7 lines/mm Photo mode: 8 pels/mm × 7.7 lines/mm Super fine mode: 8 pels/mm × 15.4 lines/mm Ultra fine mode: 16 pels/mm × 15.4 lines/mm
Scanning image processing:	Ultra-High-Quality Image Processing System (UHQ™) Halftones: 256 levels of gray 9 density adjustment levels
Recording method:	Laser Beam printing
Fax printing speed:	Approx. 18 pages/minute**
Dialing:	Automatic dialing: – One-Touch Speed Dialing (31 locations) – Coded Speed Dialing (100 locations (FAX-L380S)/169 locations (FAX-L390)) – Group Dialing (130 locations (FAX-L380S)/199 locations (FAX-L390)) Regular 10-button dialing (with numeric buttons) Automatic redialing Manual redialing Pause button
Networking:	Delayed transmission (up to 141 locations (FAX-L380S)/210 locations (FAX-L390) at a single pre-set time) Sequential broadcast (up to 141 locations (FAX-L380S)/210 locations (FAX-L390)) Automatic receiving Non-ring reception Deactivate ECM
Report/reference:	Activity report (up to 20 transactions) Non-delivery report TTI (Transmit Terminal Identification)
Toner saver:	Economy mode for printing received faxes decreases toner consumption by approx. 30%.

\* Based on 75 g/m<sup>2</sup> paper

\*\* Based on Canon FAX Standard Chart No.1, A4, standard mode

# Copier

---

Resolution:	300 × 300 dpi
Default size:	100%
Zoom:	50-200%
Multiple copies:	Up to 99 copies of a document

# Telephone

---

- Automatic FAX/TEL switchover
- Answering machine connection (CNG detecting signal)
- Telephone connection
- Optional handset connection\*
- Remote reception by telephone (Default reception ID: 25)
- Tone button
- Redial/Pause button

\* This feature is available for certain countries only.



# Printer

Printing method:	Laser beam printing
Printing resolution:	1,200 dpi enhanced × 600 dpi
Paper handling:	Automatic feed
Acceptable recording paper stock	Cassette Feeding: 64 g/m <sup>2</sup> to 128 g/m <sup>2</sup> ; Multi-Purpose Feeder: 64 g/m <sup>2</sup> to 128 g/m <sup>2</sup> Plain paper, colored paper, recycled paper (including 100% recycled paper), transparencies, envelopes, and heavy paper (up to 128 g/m <sup>2</sup> )
Envelope sizes:	European DL envelope (220 × 110 mm) U.S. Commercial No. 10 envelope (9.5 × 4.1 in.)
Printing width:	Maximum 206 mm (A4)
Paper Feeding System	Cassette Feeding: 250 sheets (FAX-L380S)/500 sheets (FAX-L390) of 64 g/m <sup>2</sup> Multi-Purpose Feeder: 1 sheet
Printing Cartridge	The Canon genuine Cartridge T Starter (Yield: Approx. 2,500 page of printouts based on 5% coverage of a A4-size page) The Canon genuine Cartridge T (Yield: Approx. 3,500 page of printouts based on 5% coverage of a A4-size page)

## Printable Area: Papers

The shaded area in the following figure shows the printable area for papers.

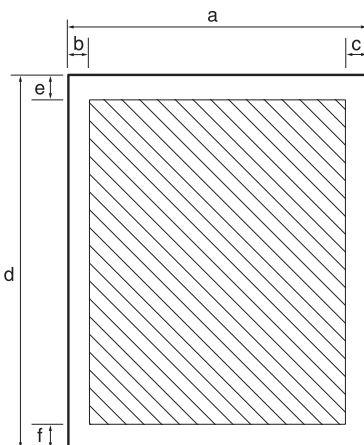

### ■ Printable area:

	A4-size	LTR-size	LGL-size
a:	210 mm	8.5"	8.5"
b:	Max. 5.0 mm	Max. 0.2"	Max. 0.2"
c:	Max. 5.0 mm	Max. 0.2"	Max. 0.2"
d:	297 mm	11.0"	14.0"
e:	Max. 5.0 mm	Max. 0.2"	Max. 0.2"
f:	Max. 5.0 mm	Max. 0.2"	Max. 0.2"

# Printable Area: Envelopes

The shaded portion in the following figure shows the printable area for envelopes.

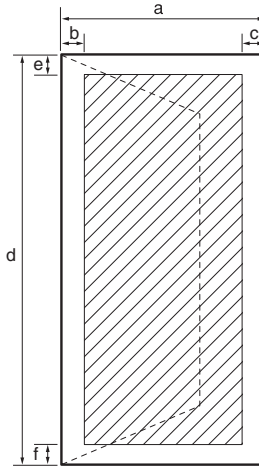

## ■ Printable area:

### European DL

a:	110 mm
b:	Max. 5.0 mm
c:	Max. 5.0 mm
d:	220 mm
e:	Max. 5.0 mm
f:	Max. 5.0 mm

### U.S. Commercial No. 10

	4.1"
	Max. 0.2"
	Max. 0.2"
	9.5"
	Max. 0.2"
	Max. 0.2"



## CAUTION

For some envelope types, the edges of the envelope can not be printed on.

# Document Sizes

The following illustrations show the largest and smallest documents you can feed into the machine.

## Maximum Document Size

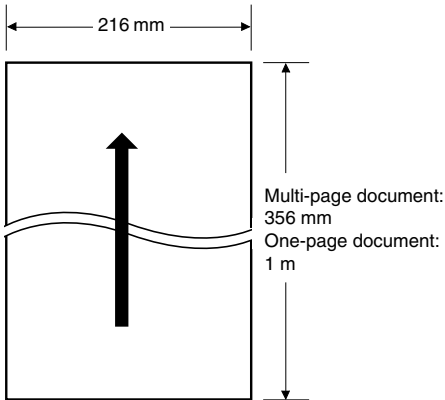

## Minimum Document Size

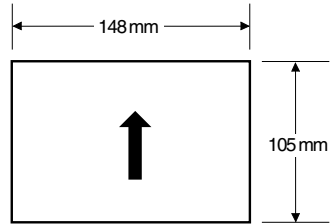

The figure below shows how much of a A4-, LTR-, or LGL-size document the machine scans when faxing or scanning.

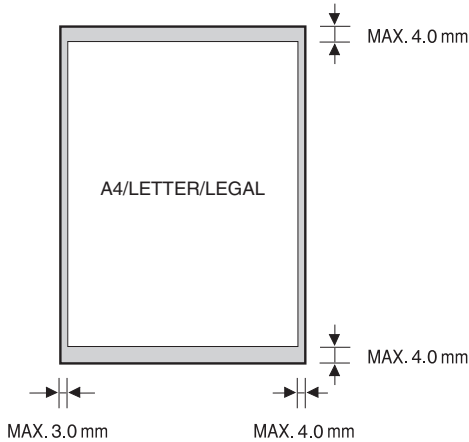

The margin at each edge is outside the machine's scanning area.

# Printer Driver

---

System requirements:

IBM or compatible computer with the following Pentium processor:  
Microsoft Windows® 98, Windows® Me, Windows® 2000, or  
Windows® XP

–Windows® 98: A 90-megahertz (MHz) Pentium processor or higher/At  
least 32 MB of RAM and 115 MB of available hard disk space

–Windows® Me: A 150-MHz Pentium processor or higher/At least 32 MB of  
RAM and 115 MB of available hard disk space

–Windows® 2000: A 133-MHz Pentium processor or higher/At least 64 MB  
of RAM (Windows® 2000 Professional), or 128 MB of RAM (Windows®  
2000 Server) and 500 MB of available hard disk space

–Windows® XP: A 300-MHz Pentium processor or higher/At least 64 MB of  
RAM and 500 MB of available hard disk space

256-color SVGA monitor or greater

USB Port

USB cable no longer than 5 meters

CD-ROM Drive, or access to one over a network connection

# Attaching the Optional Handset to the Machine

# B

## APPENDIX

This section describes how to attach the optional handset to your machine.

## Handset

The optional handset is available in certain countries. Contact your local authorized Canon dealer for more information on purchasing this option.



### NOTE

*Please note that the shape of your handset may differ from the one shown in this section. However, both handsets have exactly the same functions and performance.*

Make sure you have the following items. If anything is damaged or missing, notify your Canon dealer immediately.

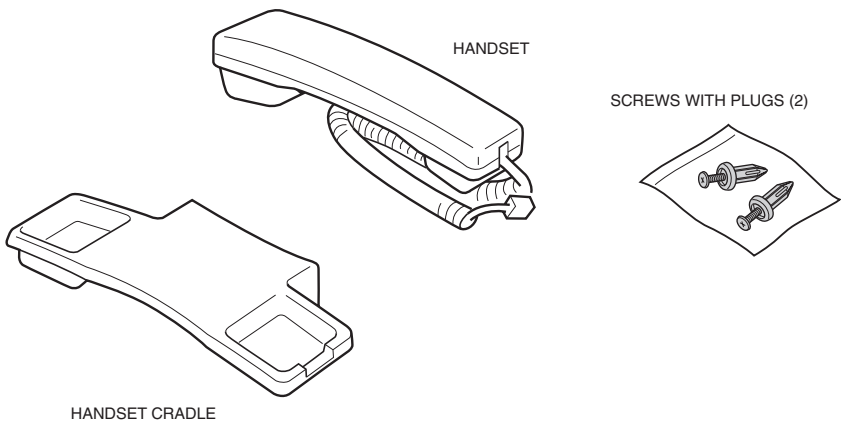

# Attaching the Handset to Your Machine

To attach the handset to your machine, follow these steps:

- 1** Remove the screws from the plugs and insert the plugs into the holes on the handset cradle.

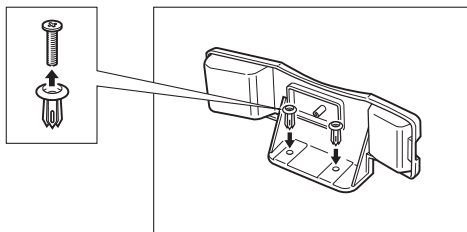

- 2** Insert the plugs with the handset cradle in the holes on the machine.

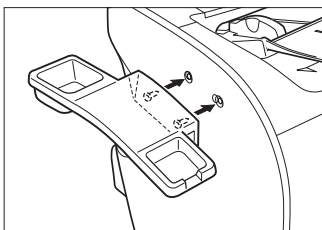

 **NOTE**

*If you have difficulty inserting the plugs, turn the machine so that the left side is facing you and the right side is placed against a wall. This will allow you to insert the plugs without the machine moving.*

- 3** Insert the screws into the plugs and push them in with your finger.

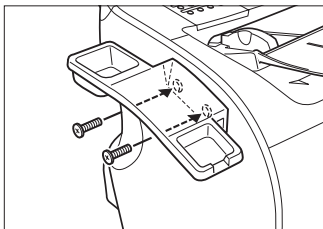

- 4** Connect the handset cord to the input jack marked  at the back of the machine.

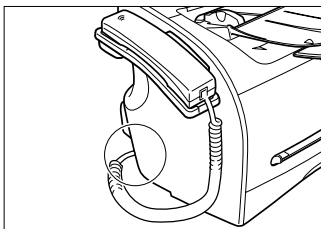
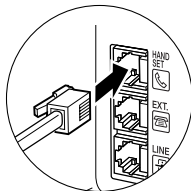

 **CAUTION**

When carrying the machine, do not lift it by the handset cradle as it may break.

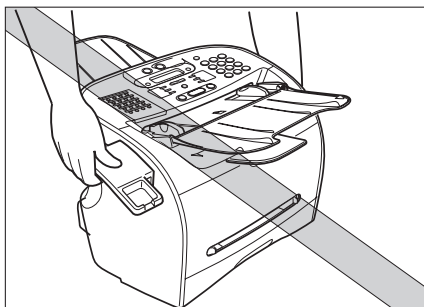



## Adjusting the Ringer Volume Switch

The ringer volume switch allows you to select the ring volume of the handset for incoming calls. Use a pen or other pointed object to adjust the switch to high or low.

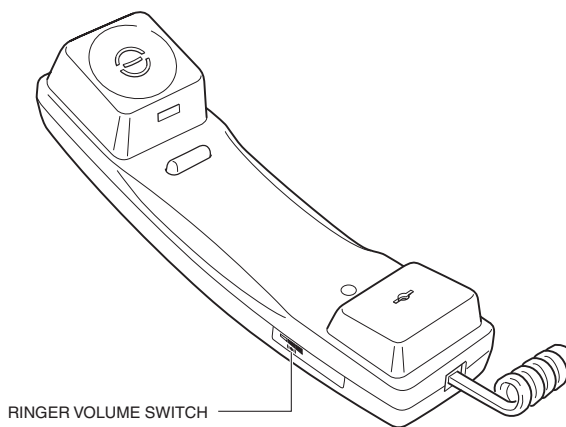

The type of handsets you can connect is different depending on the area you use your machine.

## Maintaining Your Handset

Follow these guidelines to maintain your handset in top working condition.

- Do not leave your handset exposed to direct sunlight.
- Do not install your handset in hot or humid conditions.
- Do not spray aerosol polishes on your handset as they may enter the holes on your handset and cause damage.
- Use a damp cloth to clean your handset.

# Country-Specific Features

# C

## APPENDIX

## United Kingdom

### Connecting External Device

If the connectors of the external devices cannot be connected to the jacks on the machine, you will need to purchase one or more B.T. adaptors to connect them as follows:

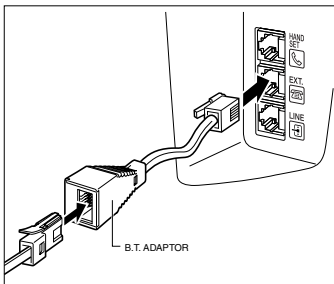

Connect the telephone cord to the B.T. adaptor. Then connect the B.T. adaptor to the  jack.

-or- Connect the additional telephone, answering machine or data modem cord to the B.T adaptor. Then connect the B.T. adaptor to the  jack.

### Ringer Equivalence Number (R.E.N.)

Your British Telecom line has a maximum R.E.N. capacity of 4. Your FAX has an R.E.N. value of 1 (unless otherwise stated), and so does the optional handset. You can therefore use additional equipment with a total R.E.N. value of up to 2. If the R.E.N. value exceeds 4, the ringer volume will be reduced and one or more of the connected equipment may not function.

# Germany

This product is designed for use for residential, commercial and light-industrial purposes.

## Applicable Standards

Electrical Safety: CE, GS

Radiation: CISPR Pub 22 Class B

Other: Energy Star compliant, CE Marking, Telefax Standard (DTS)

## Connecting the Telephone Line Cord

Follow the procedure below to connect the telephone line cord.

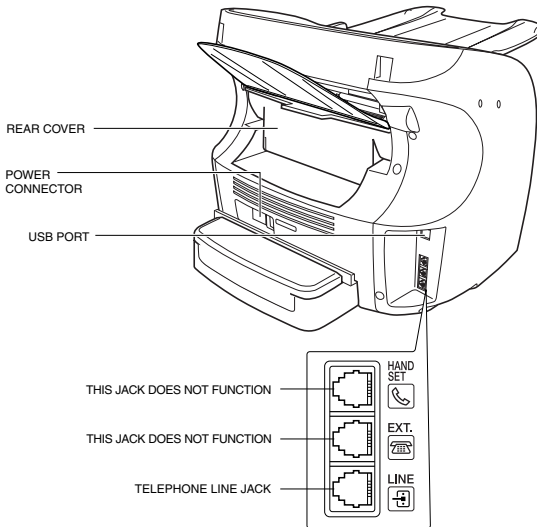

Connect one end of the supplied telephone line cord to the  jack, then the other end to the telephone line jack on the wall.

### NOTE

*To reduce the risk of electrical shock, first connect the telephone line cord to the machine, then connect it to the telephone line jack on the wall.*

Use the TAE-cable to connect the machine to the analogue switch point.

## Connecting a Telephone

You can connect both the machine and a telephone to the same telephone line jack on the wall using a single telephone line cord.

Purchase a telephone licensed in Germany. For the telephone connection, you need a TAE connection box with NF-code. Connect the telephone to the F-code jack and the machine to the N-code jack of the connection box.

## Connecting an Answering Machine

By connecting an answering machine to the same telephone line jack on the wall as the FAX, you can not only receive documents from another fax, but also receive voice calls.

- If you use an answering machine which does not correspond to DIN44015, compatibility problems may occur with your machine.
- Purchase an answering machine licensed in Germany.
- To connect an answering machine with a telephone integrated, you need a TAE connection box with NF-code. Connect the answering machine to the F-code jack and the machine to the N-code jack of the connection box.
- To connect an answering machine without a telephone integrated, use a connection box with NFN-code.



### NOTE

- *Canon cannot guarantee that all answering machines will be compatible with your machine, due to varying specifications.*
- *If you have connected an external device to your machine, be sure to set the correct receive mode (See Chapter 7).*
- *If you want to connect your machine through a PBX, read the information on p. 10-1.*

## Customer Support

If you cannot solve the problem or if you think your machine needs servicing, contact to the following phone numbers or URLs.

Canon Hotline 0180-5006022

<http://www.canon.de>



# Glossary

## A

### AC

*Alternating current.* The type of electrical current available from a wall outlet.

### Activity report

A journal of the machine's fax transactions, both sent and received.

### Application program

Software prepared for a specific function or set of functions. Developers who make application programs include drivers that support different types of printers.

### ASCII

Acronym for American Standard Code for Information Interchange. A set of definitions for the bit composition of characters and symbols. ASCII defines 128 symbols using 7 binary bits and 1 parity bit.

### Auto FAX/TEL switching

See *FAX/TEL switching*.

### Automatic dialing

Dialing fax or telephone numbers by pressing one or three buttons. To use automatic dialing, you must register the numbers in the machine's memory. See also *One-Touch Speed Dialing*, *Coded Speed Dialing*, and *Group Dialing*.

### Automatic Document Feeder (ADF)

The device included in the machine that feeds the document being faxed, copied, or scanned into the machine.

### Automatic image reduction

The machine can print the date, time, company name, and a fax number at the top of the faxes it receives. To prevent this information from crowding the faxed image on the page and possibly lengthening the fax, the machine automatically reduces the size of the image on the page.

### Automatic redialing

When the receiving fax machine is busy or does not answer, or when an error occurs while sending, the machine waits a specified time and then automatically redials the number. If the receiving fax is still busy or does not answer, the machine waits the specified time and dials again. If the fax still does not go through, the machine prints an error TX report.

## B

### bps

*Bits per second.* Refers to the speed with which a fax machine sends and receives data.

### Broadcasting

Transmitting documents to more than one location (through the machine's memory).

## C

### CCITT/ITU-T

Formerly known as CCITT, Consultative Committee for International Telegraph and Telephone. CCITT has been replaced by the International Telecommunications Union-Telecommunications sector (ITU-T), a committee created to set international standards for telecommunications.

### CNG

Calling Tone. This is a signal sent by fax machines to identify the call as an incoming document. When the receiving fax detects this signal, it automatically starts to receive the fax transmission. The majority of fax machines in use today can send and detect CNG signals.

### Coded Speed Dialing

An automatic dialing method that allows you to dial a fax or telephone number by pressing [Coded Dial] and a two-digit code (a three-digit code for the FAX-L390 model) using the numeric buttons.

### Cursor

The underline symbol you see on the LCD display when you register numbers and names in the machine. Press [◀(-)] or [▶(+)] to move the cursor.

## D

### Delayed sending

The ability to send a document at a preset time in the future. You do not have to be in your office to use delayed sending to one or more destinations. (You can set up only one delayed transmission at a time on the machine.)

### Dialing methods

Ways of pressing one or more buttons to access a number to connect to an outside party or fax machine. Dialing methods include One-Touch, Coded Speed Dialing, Group Dialing, Directory Dialing, and regular dialing with the numeric buttons.

### Document

The sheet of paper containing the data that you send to, or receive from a machine.

### dpi

*Dots per inch.* A machine of measurement for indicating a machine's resolution. Your machine produces a resolution of 1,200 dpi enhanced × 600 dpi.

### Dual access (Multitasking)

Enables the machine to receive a fax, even if it is copying or printing a document. Also enables you to load other faxes into memory, make copies, print out reports, print documents or register information while the machine sends a fax from memory.

# E

## ECM

*Error Correction Mode.* The ability of your machine to reduce system and line errors when sending or receiving from another fax with ECM capability. ECM is most effective in areas where the telephone lines are in poor condition or there is frequent interference on the line. Do not use ECM if you need to send a document quickly and you are sure the other party can read your transmission without it (turning off ECM also turns off MMR).

## Extension

A telephone connected to the machine that is used in place of the handset. You can use the extension telephone to activate incoming reception of documents manually.

# F

## FAX/TEL switching

This option allows you to set the machine to automatically detect whether a call is from a fax or telephone. If the call is from another fax, the transmission is automatically received. If the call is from a telephone, the machine rings to let you know, so you can pick up the handset. With this feature, one telephone line can be shared by both the telephone and the fax.

## FINE

The resolution setting for documents with very small characters and lines.

# G

## G3, Group 3 fax machine

Defined by CCITT/ITU-T. Uses encoding schemes to transmit image data while reducing the amount of data that needs to be transmitted, thus reducing transmission time. G3 fax machines can transmit one page in less than one minute. Encoding schemes for G3 fax machines are Modified Huffman (MH), Modified READ (MR), and Modified Modified READ (MMR).

## Grayscale

Representing color in black and white as a result of different intensities of color. Different colors and intensities of colors appear as different shades of gray.

## Group Dialing

A dialing method that enables you to dial registered One-Touch Speed Dialing or Coded Speed Dialing numbers together as a group. This means that you can press just one or a few buttons to enter numbers when sending the same document to many destinations.

# H

## Halftone

Using this method, the machine produces shades of gray by mapping dots to be printed.

# I

## **Interface**

The connection between two devices that makes it possible for them to communicate with each other. The machine features a USB interface, which makes it compatible with IBM and similar personal computers.

## **Interface cable**

The cable used to create the interface between a printer and a computer.

## **Interface port**

The machine comes with one USB port, located on the back of the machine. You attach the cable that connects your computer and machine to this port.

# J

## **Jack**

The telephone receptacles on your wall or on your machine used to connect the machine to the telephone line, answering machine, handset, or telephone.

# M

## **Manual receiving**

A method of receiving faxes in which you answer all incoming calls using the optional handset. If you hear a slow beep it indicates an incoming fax transmission from another machine. Just press [Start] to receive the incoming fax.

## **Manual redialing**

When you use regular dialing, you can redial a number manually simply by pressing [Redial/Pause] on the operation panel. The last number called is the number redialed.

## **Memory broadcast**

Allows you to send a scanned fax to two or more destinations at once, using a combination of One-Touch Speed Dialing, Coded Speed Dialing, and regular dialing.

## **Memory sending**

Scans a document into memory before the machine dials the number(s) and sends it. This method allows you to retrieve your original document immediately after scanning.

## **Modem**

A device that converts (MODulates) digital data for transmission over telephone lines. At the receiving end, this device converts the modulated data (DEModulates) to digital format that the computer understands.

# N

## **Noise**

A term applied to a variety of problems that impair the operation of telephone lines used for faxing.

## **Numeric buttons**

The round, numbered buttons on the operation panel marked the same as a standard telephone keypad. Press them to perform regular dialing. You also use the numeric buttons to enter numbers and letters when you register numbers and names, and for entering Coded Speed Dialing codes.



# O

## One-Touch Speed Dialing

An automatic dialing method that allows you to dial a fax or telephone number by pressing a single One-Touch Speed Dial button. The machine can store up to 31 numbers for One-Touch Speed Dialing.

## One-Touch Speed Dial buttons

The buttons numbered 01 to 31 on the operation panel, each of which may be registered as a fax or telephone number. Once a number is registered, you press one button to dial the entire number.

# P

## Paper feed

Refers to guiding a sheet of paper into the machine's paper path.

## Pause

A timing entry required for registering certain long distance numbers and for dialing out through some telephone systems or switchboards. Pressing [Redial/Pause] enters a pause between digits of a telephone number.

## Photo

The document setting you use for sending or copying documents with intermediate tones, such as photographs.

## Polling

One fax machine requesting another to send a document. The receiving party calls the fax machine holding the document to be sent, and requests that it be sent.

## Printable area

The area of a sheet of paper on which a printer can reproduce text or graphics (the printing area is smaller than the paper). On this machine, the printing area varies depending on the type of paper being used.

## Printer driver

The printer driver allows you to use the machine as a printer for your PC with Windows 98, Windows Me, Windows 2000, or Windows XP installed. To use the machine as a printer, install the supplied printer driver in your PC.

## Pulse

See *Rotary pulse*.

# R

## RAM

*Random Access Memory*. Memory that is used for temporary storage of information such as: documents you want to print, scanned and received documents, and downloaded fonts.

## Receive mode

The button that controls how the machine receives fax and telephone calls.

## Receiving

Receiving transmission is also defined as RX or Reception. The machine can be customized to receive fax documents in many ways:

- Receive fax documents only (FaxOnly Mode)
- Receive both telephone calls and fax documents on the same line (FaxTel Mode)
- Receive telephone calls and fax documents manually (Manual Mode)
- Receive fax documents automatically and route voice calls to the answering machine (AnsMode)

**Reception**

See *Receiving*.

**Redialing-automatic**

See *Automatic Redialing*.

**Redialing-manual**

See *Manual Redialing*.

**Reduction mode**

The machine's automatic feature that slightly reduces the received image to allow room at the top of the page for the sender's ID information. You can also reduce the size of large incoming documents using the <RX REDUCTION> option.

**Registering**

A process by which you place fax or telephone numbers and names in the machine's memory for automatic dialing so that you can save time dialing frequently called destinations.

**Regular dialing**

Pressing the individual numeric buttons to dial a fax or telephone number.

**Remote receiving ID**

The two-digit code that enables you to manually activate fax reception using a telephone that is connected to the machine.

**Remote reception**

Activating fax reception by answering a telephone that is connected to the machine, but that is not located near the machine. You need to dial a remote receiving ID number to start remote reception.

**Report**

A document printed by the machine and containing information about the faxes it has sent or received.

**Resolution**

The density of dots for any given output device. Expressed in terms of dots per inch (dpi). Low resolution causes font characters and graphics to have a jagged appearance. Higher resolution means smoother curves and angles as well as a better match to traditional typeface designs. Resolution values are represented by horizontal data and vertical data, for example, 360 × 360 dpi. This machine produces output with 1,200 dpi enhanced × 600 dpi precision.

**Rotary pulse**

A telephone dialing system where a dial is rotated to send pulses to the telephone switching system. When you pulse dial, you hear clicks. When you touch-tone dial, the most common dialing system, you hear tones. Rotary pulse dialing requires certain setting adjustments.

**RX**

See *Receiving*.

**S****Scanning contrast**

A setting that darkens or lightens the scanning of documents.

**Sender ID**

Information printed at the top of a fax (also called TTI or Transmit Terminal ID):

- Date and time the fax was sent
- Sender's fax/phone number
- Sender's name
- Your name or company name
- Page number

**Sending**

A fax document that has been scanned by a fax machine and sent over telephone lines, in the form of electrical pulses, to another fax machine. Also called TX or Transmit.

**Sending speed**

The rate at which faxes are transmitted through the phone line. See also *bps* (bits per seconds).

**STANDARD**

A document setting for sending normal typewritten or printed documents containing only text and no drawings, photographs, or illustrations.

**Standby**

The mode in which the machine is on and ready to use.

**T****Timed sending**

See *Delayed sending*.

**Tone**

A button that allows you to temporarily switch to touch-tone from pulse dialing. In some countries, on-line data services may require that you use tone dialing.

**Tone/pulse setting**

The ability to set the machine to match the telephone dialing system your telephone line uses: touch-tone or rotary pulse.

**Toner**

A black, resin coated powder contained in the toner cartridge. The machine applies the toner to the surface of the photosensitive drum inside the machine via an electrophotographic mechanism.

**Toner saver**

You can enable or disable economy printing (toner saving feature). By enabling the TONER SAVER MODE setting, toner consumption can be decreased by approx. 30%, resulting in a longer effective cartridge life.

**Transaction number**

A unique number assigned to each fax document sent (TX NO.) or received (RX NO.) by the machine and used to identify that particular fax document.

**Transmit**

See *Sending*.

**TTI**

*Transmit Terminal ID. See Sender ID.*

**TX**

See *Sending*.

**U****UHQ™ (Ultra High Quality)**

An exclusive Canon digital image processing system that incorporates 256 shades of gray along with a special edge enhancement feature which ensures that text and photos are transmitted with ultimate clarity.

# Index

## Numerics

◀(-), ▶(+) buttons, 2-15

## A

Activity Report, 13-1  
ADD. REGISTRATION, 16-14  
ADF (Automatic Document Feeder), 2-11, 2-12  
Alarm indicator, 2-14  
AnsMode, 7-1, 7-5  
Answering machine  
    using, 7-5  
Attaching components  
    document output tray, 2-5  
    output tray, 2-5

## B

B.T. adaptor, C-1  
Broadcasting, 6-13

## C

Canceling  
    automatic redialing, 6-11  
    incoming fax, 7-7  
    memory sending, 6-10  
    restriction, 10-5  
Cartridge T, 2-4  
Cassette, 2-11, 2-12  
    loading envelopes, 4-5  
    loading paper, 2-22, 4-3  
CD-ROM, 2-2  
CHANGE PAPERSIZE message, 14-8  
CHECK DOCUMENT message, 14-8  
CHECK PRINTER message, 14-8  
Clear button, 2-15  
Coded Dial button, 2-15  
Coded Speed Dial List, 13-9

Coded Speed Dialing, 5-1, 6-7  
    changing or deleting numbers, 5-6  
    storing numbers, 5-5  
    using, 5-7  
Collate copy, 1-3, 11-8  
COMMON SETTINGS, 16-3  
Connection  
    power cord, 2-8  
    telephone line, 2-8  
    USB port, 2-7  
COPY button, 2-14  
COPY SETTINGS, 16-5  
COPY STATUS, 12-1  
Copying, 11-1  
    enlarging/reducing, 11-4  
    specifying the paper size, 11-2  
    specifying the paper type, 11-3  
Counter Information, 9-9  
Country  
    setting, 2-10  
Custom copy ratio, 11-5

## D

Delayed sending, 6-15  
Delayed Transmission button, 2-15  
Delete button, 2-15  
Department ID Report, 13-2  
Department Information List, 13-13  
Destination labels, 2-2  
Directory button, 2-15  
Directory Dialing, 5-1, 6-7  
    using, 5-13  
Display language  
    setting, 2-10  
Document  
    loading in the ADF, 6-3  
    requirements, 6-1  
    scanning area, 6-2  
Document feeder tray, 2-11, 2-12  
Document Memory List, 13-14  
Document output tray, 2-11, 2-12  
    attaching, 2-5  
DOCUMENT TOO LONG, 14-8

**E**

- Energy Saver button, 2-14
- Energy saver mode
  - restoring from, 2-16
  - setting manually, 2-16
- Enlarge/Reduce button, 2-14
- Entering
  - date and time, 3-3
  - method, 3-1
  - numbers for Coded Speed Dialing, 5-5
  - numbers for Group Dialing, 5-9
  - numbers for One-Touch Speed Dialing, 5-2
  - your fax number and name, 3-4
- Envelope
  - loading in the cassette, 4-5
  - loading in the multi-purpose feeder, 4-9
- Error Codes, 14-11
- Error Correction Mode (ECM), 1-2
- Error TX Report, 13-3
- Exposure button, 2-14
- Extension cover, 2-13
- Extension phone jack, 2-13

**F**

- F/T RING TIME, 7-2
- F/T SWITCH ACTION, 7-2
- FAX button, 2-14
- FAX MONITOR, 12-1
- FAX SETTINGS, 16-6
- FaxOnly Mode, 7-1, 7-5
- FaxTel Mode, 7-1, 7-2, 7-3
  - setting options, 7-2
- Front view, 2-11

**G**

- Group Dial List, 13-10
- Group Dialing, 5-1, 6-7
  - changing or deleting numbers, 5-10
  - storing numbers, 5-9
  - using, 5-12, 6-14

**H**

- Handset, B-1
  - manual sending, 6-6, 6-9
- Handset jack, 2-13
- HANG UP PHONE, 14-8
- Hook button, 2-15

**I**

- ID button, 2-15
- Image Quality button, 2-14
- In Use/Memory indicator, 2-14
- INCORRECT PAPER SIZE message, 14-8
- INSTALL CARTRIDGE message, 14-8

**L**

- LCD display, 2-14
- LCD Messages, 14-8
- Long distance dialing, 10-2

**M**

- Maintenance
  - cleaning, 15-1
  - handset, B-4
- MAKING SPACE IN MEM message, 14-9
- Manual Mode, 7-1, 7-4
- Manual sending, 6-6, 6-9
- MEM IN USE nn % message, 14-9
- Memory Clear Report, 13-6
- MEMORY FULL message, 14-9
- Memory Lock, 10-6
  - password, 10-6
- Memory receiving, 7-6
- Memory sending, 6-6, 6-8
  - canceling, 6-10
  - redialing automatically, 6-11
- Menu button, 2-14
- Menu System, 16-1
- Multi TX/RX Report, 13-4
- Multi-purpose feeder, 2-11, 2-12
  - loading envelope, 4-9
  - loading paper, 4-8
- Multitasking, 7-7

**N**

- NOT REGISTERED message, 14-9
- Numeric buttons, 2-14

**O**

- OK button, 2-15
- One-Touch Speed Dial buttons, 2-15
- One-Touch Speed Dial List, 13-8
- One-Touch Speed Dial panel, 2-15

One-Touch Speed Dialing, 5-1, 6-7  
    changing or deleting numbers, 5-3  
    storing numbers, 5-2  
    using, 5-4  
Operation panel, 2-11, 2-12, 2-14  
Orientation, 4-11  
Output tray, 2-11, 2-12

## P

Paper cassette  
    installing, 2-6  
Paper jam  
    clearing, 14-1  
Paper output area  
    face down, 4-13  
    face up, 4-13  
    guidelines, 4-12  
    selecting, 4-12  
PAPER SETTINGS, 16-2  
PBX, 10-1  
Polling  
    receiving, 8-2  
    sending, 8-3  
Polling box  
    changing settings, 8-5  
    deleting, 8-6  
    scanning document into the memory, 8-4  
    setting up, 8-3  
Polling button, 2-15  
Power Cord, 2-2  
    connecting, 2-8  
Power socket, 2-13  
Preset copy ratio, 11-4  
PRINT LISTS, 16-18  
PRINT STATUS, 12-1  
Printer cover, 2-11, 2-12  
PRINTER DATA ERROR message, 14-9  
Printer driver, 1-4  
PRINTER SETTINGS, 16-14

## R

R button, 2-15  
Rear cover, 2-13  
Rear view, 2-13  
REC. PAPER JAM message, 7-6, 14-9  
Receive mode  
    AnsMode, 7-1  
    FaxOnly, 7-1  
    FaxTel, 7-1  
    Manual, 7-1  
    setting, 7-2  
Receive Mode button, 2-15  
RECEIVED IN MEMORY message, 14-9

Recording paper  
    loading in the cassette, 2-22, 4-3  
    loading in the multi-purpose feeder, 4-8  
    printing areas, 4-2  
    requirements, 4-1  
Redial/Pause button, 2-15  
Redialing  
    automatically, 6-11  
    canceling, 6-11  
    manually, 6-11  
    setting up, 6-11  
Regular Dialing, 6-7  
Removing Jammed Paper from the ADF, 14-7  
REPLACE CARTRIDGE message, 14-9  
Report button, 2-15  
REPORT STATUS, 12-1  
Reserve copy, 11-9  
Restriction  
    canceling, 10-5  
    enabling, 10-4  
    operating, 9-8  
    setting, 9-4  
    turning, 9-7  
RING START TIME, 7-2  
Ringer Equivalence Number (R.E.N.), C-1  
Ringer Volume Switch, B-4  
RX Report, 13-5

## S

Safety instructions, 1-6  
Scanning density  
    adjusting to copy, 11-6  
    adjusting to fax, 6-5  
Scanning resolution  
    adjusting to copy, 11-6  
    adjusting to fax, 6-4  
Setting  
    display language and country, 2-10  
    receive mode, 7-2  
    scanning density (fax), 6-5  
    scanning resolution (fax), 6-4  
    summer time, 3-5  
    telephone line type, 3-5  
Shipping Materials  
    removing, 2-3  
Slide guides, 2-11, 2-12  
Space button, 2-15  
Specifications, A-1  
Speed Dialing Lists, 13-7  
START AGAIN message, 14-9  
Start button, 2-15  
Stop/Reset button, 2-15  
Summer time  
    setting, 3-5  
SUPPLY REC. PAPER message, 7-6, 14-9  
Switchboard, 10-1

System Administrator's ID  
    changing/cancelling, 9-2  
    setting, 9-2  
SYSTEM ERROR, 14-10  
System Monitor button, 2-14  
SYSTEM SETTINGS, 16-16

## T

Telephone line  
    connecting, 2-8  
Telephone Line Cord, 2-2  
Telephone line jack, 2-13  
Telephone line type  
    setting, 3-5  
TIMER SETTINGS, 16-15  
Tone button, 2-14  
Tone dialing, 10-3  
Toner cartridge  
    handling and storing, 2-17  
    installing and replacing, 2-18  
Transfer roller, 14-2  
Transporting, 15-5  
TTI, 3-3  
TX Report, 13-4  
TX/RX NO. nnnn\*\*, 14-10

## U

Unpacking, 2-2  
USB port, 2-13  
    connecting, 2-7  
User's Data List, 13-11

# Canon

## **CANON INC.**

30-2, Shimomaruko 3-chome, Ohta-ku, Tokyo 146-8501, Japan

## **CANON U.S.A., INC.**

One Canon Plaza, Lake Success, NY 11042, U.S.A.

## **CANON CANADA INC.**

6390 Dixie Road Mississauga, Ontario L5T 1P7, Canada

## **CANON EUROPA N.V.**

Bovenkerkerweg 59-61 1185 XB EG Amstelveen, The Netherlands

## **CANON FRANCE S.A.S.**

17, quai du Président Paul Doumer 92414 Courbevoie Cedex, France

## **CANON COMMUNICATION & IMAGE FRANCE S.A.S.**

12, rue de l'Industrie 92414 Courbevoie Cedex, France

## **CANON (U.K.) LTD.**

Woodhatch, Reigate, Surrey, RH2 8BF, United Kingdom

## **CANON DEUTSCHLAND GmbH**

Europark Fichtenhain A10, 47807 Krefeld, Germany

## **CANON ITALIA S.p.A.**

Via Milano, 8 20097 San Donato Milanese (MI) Italy

## **CANON LATIN AMERICA, INC.**

703 Waterford Way Suite 400, Miami, Florida 33126 U.S.A.

## **CANON AUSTRALIA PTY. LTD**

1 Thomas Holt Drive, North Ryde, Sydney, N.S.W. 2113, Australia

## **CANON CHINA CO., LTD**

15F, North Tower, Beijing Kerry Centre, 1 Guang Hua Road, Chao Yang District, 100020, Beijing, China

## **CANON SINGAPORE PTE. LTD.**

1 HarbourFront Avenue #04-01 Keppel Bay Tower, Singapore 098632

## **CANON HONGKONG CO., LTD**

19/F., The Metropolis Tower, 10 Metropolis Drive, Hunghom, Kowloon, Hong Kong

**230V**



## Free Manuals Download Website

<http://myh66.com>

<http://usermanuals.us>

<http://www.somanuals.com>

<http://www.4manuals.cc>

<http://www.manual-lib.com>

<http://www.404manual.com>

<http://www.luxmanual.com>

<http://aubethermostatmanual.com>

Golf course search by state

<http://golfingnear.com>

Email search by domain

<http://emailbydomain.com>

Auto manuals search

<http://auto.somanuals.com>

TV manuals search

<http://tv.somanuals.com>