

Canon

PC-D320/PC-D340/FAX-L400

Quick Reference Guide



Please read this guide before operating this equipment.
After you finish reading this guide, store it in a safe place for future reference.

Download from www.Somanuals.com. All Manuals Search And Download.

ENG

Using Your Documentation

Your machine includes the following documentation. This documentation has been designed so that you can easily use your machine to suit your particular needs.

Setting Up the Machine
Installing CARPS Software.....



Set-up Guide

Document and Paper Handling
Printing with CARPS Software.....
Making Copies
Maintenance



Quick Reference Guide

Document and Paper Handling
Printing with CARPS Software.....
Making Copies
Maintenance



User's Guide



Sending and Receiving Faxes
Speed Dialling
Troubleshooting Fax Issues.....



Facsimile Guide

Only for the FAX-L400 model

Installing CARPS Software.....
Printer Properties
Troubleshooting Printer Driver Issues



Software Guide



• Documentation is included on the CD-ROM in PDF form.



NOTE

• The machine shown in this guide is the FAX-L400 model.

Copyright

Copyright ©2003 by Canon, Inc. All rights reserved. No part of this publication may be reproduced, transmitted, transcribed, stored in a retrieval system, or translated into any language or computer language in any form or by any means, electronic, mechanical, magnetic, optical, chemical, manual, or otherwise, without the prior written permission of Canon, Inc.



Trademarks

Canon is a registered trademark and UHQ™ is a trademark of Canon, Inc.

As an ENERGY STAR® Partner, Canon Inc. has determined that this product meets the ENERGY STAR® guidelines for energy efficiency.

Contents

Chapter 1: Introduction

Customer Support	1-1
Important Safety Instructions	1-1
Main Components of the Machine	1-4
Operation Panel	1-7
Energy Saver Mode	1-9
Setting the Energy Saver Mode Manually	1-9
Restoring from the Energy Saver Mode	1-9

Chapter 2: Paper Handling

Print Media Requirements	2-1
Loading Paper	2-2
Loading Paper in the Cassette	2-2

Chapter 3: Document Handling

Documents You Can Copy	3-1
Setting Up Documents	3-2
Placing a Document on the Platen Glass	3-2
Loading Documents in the ADF (Only for the PC-D340/FAX-L400 Models)	3-3

Chapter 4: Basic Printing from Your Computer

Before Printing	4-1
Printing from the CARPS Software (Ex. Windows 98)	4-2
Cancelling Printing	4-2
Changing Print Settings	4-3

Chapter 5: Making Copies

Documents You Can Copy	5-1
Copying Documents	5-1
Cancelling the Copy Job	5-2
Basic Copying Functions	5-3
Making Multiple Copies	5-3
Specifying the Paper Size and Type (Common for Cassette and Multi-purpose Tray)	5-3
Setting Enlarging/Reducing	5-5
Setting the Image Quality	5-7
Adjusting the Copy Exposure	5-8
Special Features	5-9

Chapter 6: System Monitor

Checking the Status of Copy, Fax, Print and Report Jobs6-1

Chapter 7: Maintenance

Periodic Cleaning7-1
 Cleaning the Exterior7-1
 Cleaning the Scanning Area7-1
When to Replace the Cartridge7-3
 Copy Yield7-4
 Handling and Storing the Cartridge7-4
Replacing the Cartridge7-6

Chapter 8: Setting the Additional Functions

Understanding the “Additional Functions”8-1
 Accessing the Additional Functions8-1
 Menu Descriptions8-2

Appendix: Specifications A-1

Index I-1

Type Conventions Used in This Guide

Please read the list below of symbols, terms, and abbreviations used in this guide.



- Indicates a warning concerning operations that may lead to death or injury to persons if not performed correctly. In order to use the machine safely, always pay attention to these warnings.



- Indicates a caution concerning operations that may lead to injury to persons or damage to property if not performed correctly. In order to use the machine safely, always pay attention to these cautions.



- Indicates an operational warning or restriction. Be certain to read these items to operate the machine correctly, and to avoid damage to the machine.



- Indicates a note for operation or an additional explanation. Reading these is highly recommended.

(→ p. n-nn)	A number preceded by an arrow and enclosed in parenthesis refers to a page number in this guide which contains more information on the topic of the previous sentence.
→ <i>Set-up Guide</i>	Refer to the Set-up Guide for details on the topic of the previous sentence.
→ <i>User's Guide</i>	Refer to the User's Guide for details on the topic of the previous sentence.
→ <i>Facsimile Guide*</i>	Refer to the Facsimile Guide for details on the topic of the previous sentence.
→ <i>Software Guide</i>	Refer to the Software Guide for details on the topic of the previous sentence.
machine	The word "machine" refers to the PC-D320/PC-D340/FAX-L400 models.
default	A setting that remains in effect unless you change it.
document	The original sheet(s) of paper you copy, with the machine.
menu	A list of settings from which you select an item to set up or change. A menu has a title which appears in the LCD. Available menus and the display differ depending on the machine type. This guide shows the display of the FAX-L400 model as an example.

In addition, this guide uses distinctive typefaces to identify keys and information in the LCD:

- The keys you press appear in this typeface: **Stop/Reset**.
- Information in the LCD appears in this typeface: COPY SETTINGS.

*Only for the FAX-L400 model

Legal Limitation on Usage of Your Product and the Use of Images

Using your product to scan, print or otherwise reproduce certain documents, and the use of such images as scanned, printed or otherwise reproduced by your product, may be prohibited by law and may result in criminal and/or civil liability. A non-exhaustive list of these documents is set forth below. This list is intended to be a guide only. If you are uncertain about the legality of using your product to scan, print or otherwise reproduce any particular document, and/or of the use of the images scanned, printed or otherwise reproduced, you should consult in advance with your legal advisor for guidance.

- Paper Money
- Traveller's Cheques
- Money Orders
- Food Stamps
- Certificates of Deposit
- Passports
- Postage Stamps (cancelled or uncanceled)
- Immigration Papers
- Identifying Badges or Insignias
- Internal Revenue Stamps (cancelled or uncanceled)
- Selective Service or Draft Papers
- Bonds or Other Certificates of Indebtedness
- Cheques or Drafts Issued by Governmental Agencies
- Stock Certificates
- Motor Vehicle Licenses and Certificates of Title
- Copyrighted Works/Works of Art without Permission of Copyright Owner

Introduction

Customer Support

Your machine is designed with the latest technology to provide trouble-free operation. If you encounter a problem with the machine's operation, → *User's Guide*. If you can not solve the problem or if you think your machine needs servicing, contact your local authorized Canon dealer or the Canon help desk.

Important Safety Instructions

Read these safety instructions thoroughly before using your machine, and keep them handy in case you need to refer to them later.



For cardiac pacemaker users

- **This product and the cartridge emit low level magnetic flux. If you use a cardiac pacemaker and feel abnormalities, please stay away from this product and the cartridge, and consult your doctor.**



- **Do not disassemble or modify. There are high-temperature and high-voltage components inside the machine which may result in a fire or electrical shock.**
- **Follow all warnings and instructions marked on the machine.**

Location



- **Do not place the machine near alcohol, paint thinner or other inflammable substances. If inflammable substances come into contact with electrical parts inside the machine, it may result in a fire or electrical shock.**



- **Do not block or cover the ventilation port or any openings on the machine with objects, as this may result in a fire.**
- **Place the machine on a flat, stable, vibration-free surface that is strong enough to support its weight (approx. 14.5 kg PC-D320, 16.0 kg PC-D340, 16.1 kg FAX-L400).**

- Make sure the area is free from dust.
- Avoid poorly ventilated locations.
During use, the machine generates ozone. However, the amount of ozone generated is not enough to affect the human body. Nevertheless, if the machine is used for a prolonged period of time in a poorly ventilated room, or when making a large quantity of prints, be sure to ventilate the room to make the working environment as comfortable as possible.
- Do not install the machine near devices that contain magnets or generate magnetic fields, such as speakers.
- Make sure the machine is approximately 10 cm away from walls and other equipment for proper ventilation.

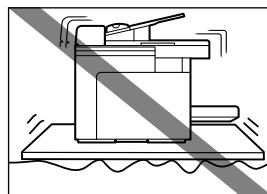
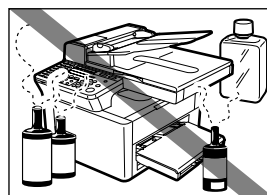

- Make sure the location is not affected by extreme temperature changes, and always stays between 15°C and 27°C.
- Make sure the relative humidity of the area is between 20% and 80%.
- Keep the machine away from direct sunlight.
- Do not use or store the machine outdoors.

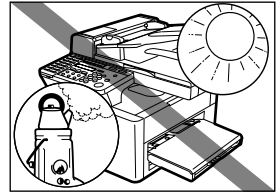

■ Power Supply



- **Do not damage or modify the power cord and power plug. Also do not place heavy objects on the power cord, pull on it, or extensively bend it. These actions may cause electrical damage and result in a fire or electrical shock.**

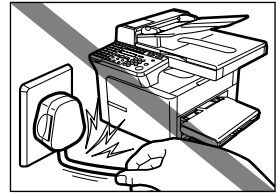

- **Do not insert or unplug the power plug with wet hands, as this may result in electrical shock.**

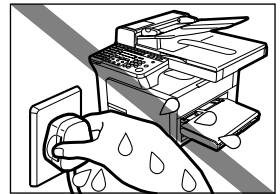

- **During electrical storms, disconnect the telephone line and unplug the power cord from the power outlet. Electrical storms may cause damage to the machine and result in a fire or electrical shock.**

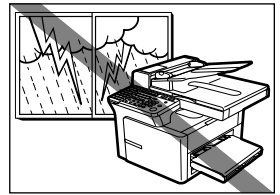

- If dust accumulates around the plug of the power cord when it is connected to a power outlet, unplug the machine and wipe the plug with a clean, dry cloth.
- Do not plug the machine into the same circuit with appliances such as an air conditioner, television or copier. These devices generate an electrical noise, and may interfere with your machine's operation.

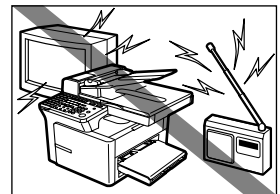

- Plug the machine into a standard 220V-240V AC power outlet. Operate the machine only from the type of power source indicated on the machine's label. If you are not sure of the type of power available, consult your local power company.
- Use only the power cord that came with the machine.
- Unplug the machine in the following conditions:
 - When the power cord or plug is damaged or frayed.
 - If liquid has spilled into the machine.
 - If the machine has been exposed to rain or water.
 - If the machine does not operate normally when you have followed the instructions in the guides included with your machine. Adjust only those controls that are covered by the instructions in the guides since improper adjustment of other controls may result in damage and will often require extensive work by a qualified technician to restore the product to normal operation.
 - If the machine has been dropped or damaged.
 - If the machine exhibits a distinct change in performance, indicating a need for servicing.

■ Handling



- Do not drop paper clips, staples, or other metal objects inside the machine. Also do not spill water, liquid or inflammable substances inside the machine. If these items come into contact with high-voltage parts inside of the machine, it may result in a fire or electrical shock. If these items are dropped or spilled in the machine, unplug the power cord immediately with dry hands. Then, contact your service representative.

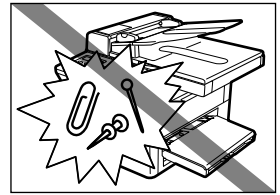

- Do not use any highly flammable spray near the machine. If gas from a spray comes into contact with the electrical components inside the machine, it will result in a fire.

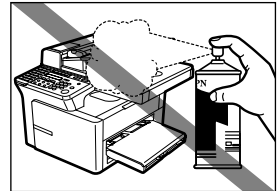

- Close the ADF or the platen glass cover gently to avoid catching your hand. Failing to do so may result in personal injury.

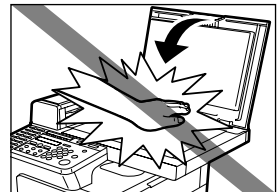

- Do not press down hard on the platen glass cover when using the platen glass to scan a thick book. This may damage the platen glass and/or result in personal injury.

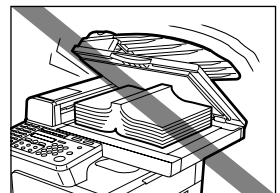

- Do not subject the machine to strong physical shock or vibration.
- Unplug the machine before moving it.
- Do not lift the machine by any of its attachments.
- If the machine exhibits a distinct change in performance, this indicates a need for servicing.

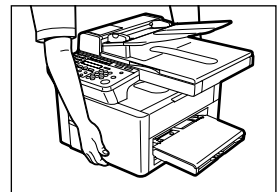

■ Maintenance



- Do not place the cartridge in fire. Toner powder is flammable.

- Keep the machine clean. Dust accumulation may prevent the machine from operating properly.



- Do not service the machine yourself except as specifically described in this guide. If further servicing is required, contact your service representative.

Main Components of the Machine

This section describes the main components of the machine.

■ FAX-L400

Left Side View

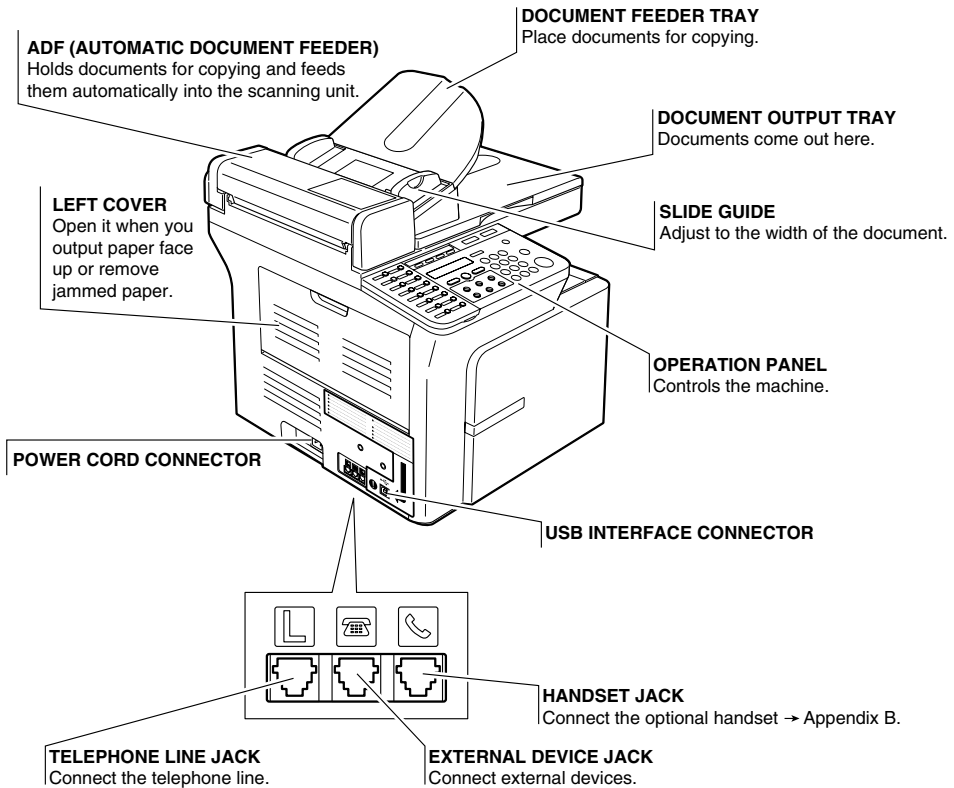

Right Side View

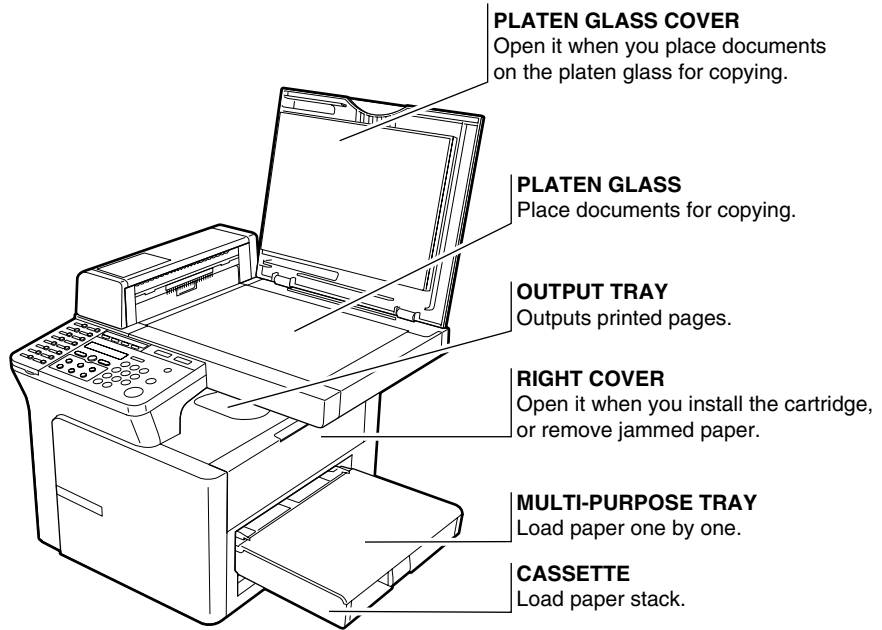

■ PC-D340

ADF (AUTOMATIC DOCUMENT FEEDER)

Holds documents for copying and feeds them automatically into the scanning unit.

DOCUMENT FEEDER TRAY

Place documents for copying.

DOCUMENT OUTPUT TRAY

Documents come out here.

LEFT COVER

Open it when you output paper face up or remove jammed paper.

OPERATION PANEL

Controls the machine.

POWER CORD CONNECTOR

USB INTERFACE CONNECTOR

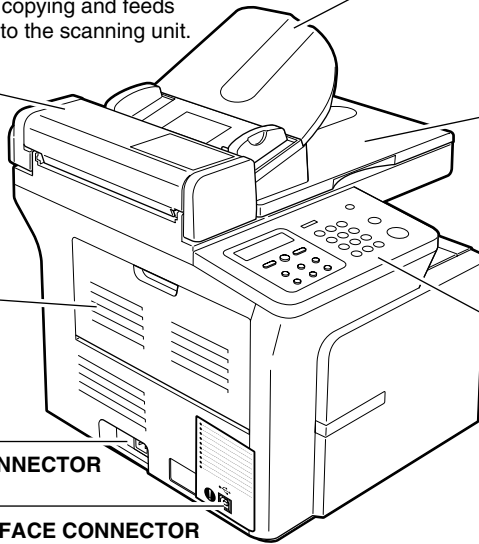

■ PC-D320

OPERATION PANEL

Controls the machine.

PLATEN GLASS COVER

Open it when you place documents on the platen glass for copying.

OUTPUT TRAY

Outputs printed pages.

RIGHT COVER

Open it when you install the cartridge or remove jammed paper.

MULTI-PURPOSE TRAY

Load paper one by one.

CASSETTE

Load paper stack.

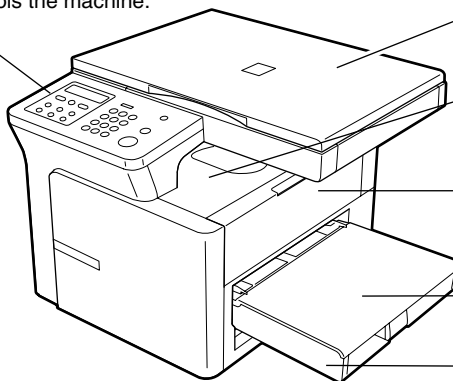

Operation Panel

This section describes keys used when making copies and setting the Additional Functions.
For buttons not described here → *Facsimile Guide*.

■ FAX-L400

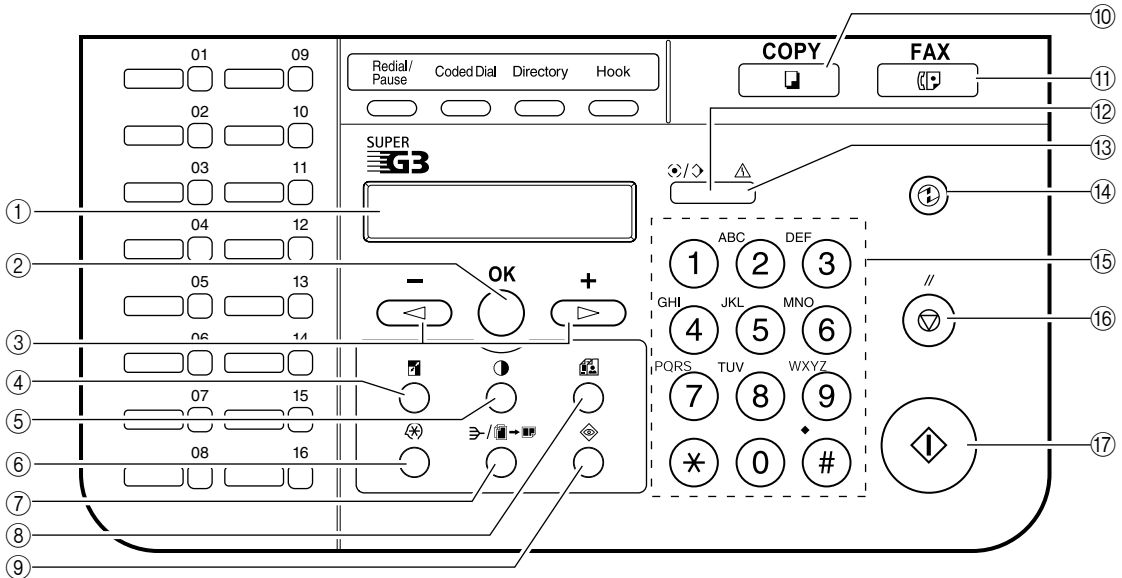

- ① **LCD**
Displays messages and prompts during operation. Also displays selections, text, and numbers when specifying settings.
- ② **OK key**
Determines the contents you set or register. Also, if the document being scanned stops in the ADF, pressing this key makes the document come out automatically.
- ③ **◀ (-), ▶ (+) keys**
Scroll through the selections so you can see other settings.
- ④ **Enlarge/Reduce key**
Sets an enlargement or reduction ratio of the copy.
- ⑤ **Exposure key**
Adjusts the copy exposure.
- ⑥ **Additional Functions key**
Customizes the way your machine operates.
- ⑦ **Collate/2 on 1 key**
Sorts copies in order of pages or reduces two A4-size documents to fit on a single A4-size sheet.
- ⑧ **Image Quality key**
Adjusts the quality of copy image.
- ⑨ **System Monitor key**
Checks the status of copy, fax, print and report jobs.
- ⑩ **COPY key**
Switches standby display to Copy mode.

- ⑪ **FAX key**
Switches standby display to Fax mode.
- ⑫ **In Use/Memory indicator**
Lights green during copying or when the copy job is stored in memory.
- ⑬ **Alarm indicator**
Flashes orange when the machine has a problem such as a paper jam. (The error message is displayed in the LCD.)
- ⑭ **Energy Saver key**
Sets or cancels the energy saver mode manually. The key lights green when the energy saver mode is set, and goes off when the mode is cancelled.
- ⑮ **Numeric keys**
Enter copy quantity and other numerical values.
- ⑯ **Stop/Reset key**
Cancels copying and other operations, and returns to standby display. Also, this key is used to confirm the copy job you reserved.
- ⑰ **Start key**
Starts copying.

■ PC-D340/PC-D320

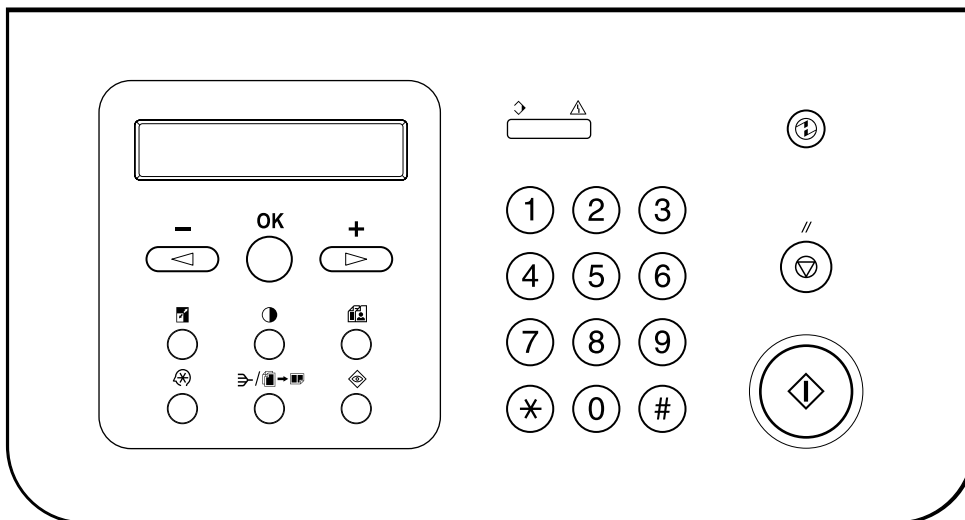

Energy Saver Mode

This machine provides an energy saver function. When no operations are performed for about 5 minutes, the machine automatically enters the energy saver mode.



NOTE

- The time until the machine enters the energy saver mode can be specified in a range of 3 minutes to 30 minutes. You can also turn off the energy saver function. (→ p. 8-4)
 - The energy saver function does not activate when the machine is in the following status:
 - When printing out copies, faxes* or other pages
 - When sending or receiving faxes*
 - While a copy job is saved in memory or when the reserve copy or other functions are operating, or when the In Use/Memory indicator lights up*
 - When paper jams occur
 - When an error code appears and the Alarm indicator flashes
 - When no paper is loaded in the cassette or multi-purpose tray
 - When **PRESS OK KEY** is displayed
- *Only for the FAX-L400 model

Setting the Energy Saver Mode Manually

1 Press **Energy Saver**.

- The LCD is turned off and the Energy Saver key lights up.



NOTE

- Right after the machine is restored from the energy saver mode, or right after copying finishes, wait about 2 seconds before pressing **Energy Saver**.

Restoring from the Energy Saver Mode

1 Press **Energy Saver**.

- The Energy Saver key goes off and the machine enters standby mode.



NOTE

- The machine can be restored from the energy saver mode immediately. However, it may vary according to room temperature and circumstances.

Paper Handling

Print Media Requirements

For high-quality copies, we recommend using paper and transparencies recommended by Canon. Some types of paper available at office supply stores may not be suitable for this machine. If you have any questions about paper and transparencies, contact your local authorized Canon dealer or the Canon help desk.

Paper Storage

In order to prevent paper jams, follow the procedure below:

- To prevent moisture buildup, store remaining paper wrapped tightly in its original package. Store paper in a dry location, out of direct sunlight.
- To prevent curling, store paper flat, not upright.
- After copying, do not leave paper in the multi-purpose tray.

Unacceptable Paper

Do not copy on the following types of copy stock; doing so will result in paper jams.

- Severely curled or wrinkled paper
 - Transparencies for full-colour copiers or printers
 - Paper which has already been copied using a digital full-colour copier (Do not copy on the reverse side.)
 - Paper which has been printed on using a thermal transfer printer (Do not copy on the reverse side.)
-  • Never attempt to make copies on full-colour transparencies. Doing so may result in copier malfunction.

IMPORTANT

Acceptable Paper

	Cassette/Multi-purpose Tray
Paper size	A4, B5, A5, LTR, LGL, EXECUTIVE, Envelope : COM10, MONARCH, DL, ISO-C5 Free Size : 216 mm × 356 mm [max.] / 76.2 mm × 127 mm [min.]
Paper weight	64 g/m ² to 128 g/m ²
Type of paper	– Plain paper (64 g/m ² to 90 g/m ²) – Transparencies – Special paper 1 (91 g/m ² to 128 g/m ²) :Thick paper – Special paper 2 :Rough paper



NOTE

- The printing speed may be gradually slower than usual depending on the paper size, the paper type and the number of sheets you specify.
This is because safety function works to prevent the failure due to the heat.

Loading Paper

This section describes how to load paper in the cassette.



CAUTION

- When loading paper, take care not to cut your hands on the edges of the paper.



NOTE

- The cassette holds up to approximately 250 sheets of 64 g/m².

■ Loading Paper in the Cassette

- 1 Fan the paper stack first, then tap the edges on a flat surface to even the stack.

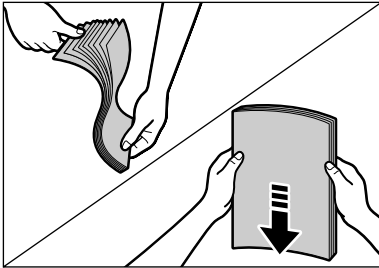

- 2 Remove the multi-purpose tray.

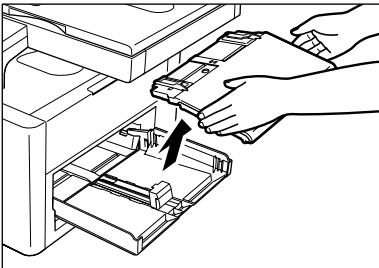

- 3 Load the paper stack in the cassette.

- Insert the paper stack into the cassette as far as it will go.
- When you insert paper with a logo on, position the paper with the print side up (logo side) and load it so that the top of the paper feeds first in the cassette.

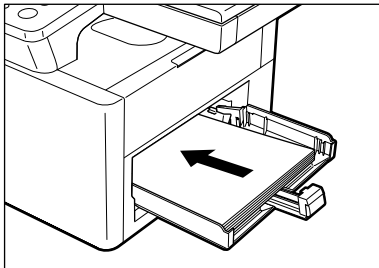

4 Adjust the slide guides to fit the size of the paper stack.

- Adjust the slide guides so that there is no space between the slide guides and the edge of the paper stack.

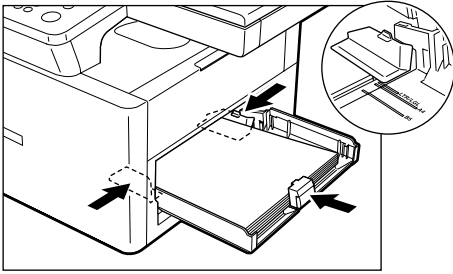
**5** When loading paper other than A4-size, specify the paper size.

Press **Additional Functions**, then

select:

PAPER SETTINGS

PAPER SIZE

Use ◀ (-) or ▶ (+) to select the appropriate paper size (A4, B5, A5, LTR, LGL, EXECUTIVE, ENVELOPE, FREE SIZE).

- For details, see “Specifying the Paper Size and Type (Common for Cassette and Multi-purpose Tray)”.
(→ p. 5-3)



IMPORTANT

- Do not load different kinds of paper at the same time.
- Do not load extra paper when there is still paper left in the cassette.
- If you load extra paper while making copies, remove the loaded paper first. Then put it together with the extra paper and tap the edges. After that, reload it in the cassette.



NOTE

- For information on loading envelopes in the cassette, and details on how to use the multi-purpose tray
→ *User's Guide*.

Chapter 3

Document Handling

Documents You Can Copy

The documents placed on the platen glass or loaded into the ADF must meet the requirements shown in the table below.

	Platen Glass	ADF
Type of document	<ul style="list-style-type: none">– Plain paper– Thick documents– Photographs– Small documents (e.g. index cards)– Special types of paper (e.g. tracing paper^{*1}, transparencies^{*1}, etc.)– Book	<ul style="list-style-type: none">– Plain paper (Multiple page documents of the same size, thickness, and weight or one page documents.)
Size (W × L)	Max. 216 mm × 297 mm A4 : 210 mm × 297 mm	Max. 216 mm × 356 mm Min. 148 mm × 105 mm
Quantity	1 sheet	Max. 50 A4-size sheets ^{*2}
Weight	Max. 2 kg	64 g/m ² to 105 g/m ²

^{*1} When copying a transparent document such as tracing paper or transparencies, place a plain piece of white paper behind the document.

^{*2} 80 g/m² paper

Setting Up Documents

For scanning, place your documents on the platen glass or load them into the ADF. Where you set up your documents depends on the size and type of documents you have. (→ p. 3-1)

■ Placing a Document on the Platen Glass

- 1 Open the platen glass cover.
- 2 Place your document face down on the platen glass. Align the document with the appropriate paper size marks.

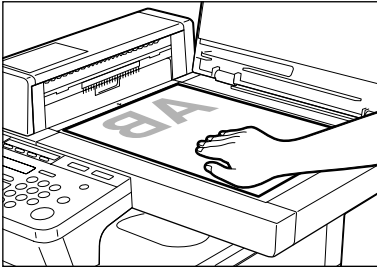

- 3 Gently lower the platen glass cover.
 - The document is now ready for scanning.

Positioning Documents

Use the size indicators on the left side of the platen glass to position a document.

- If your document conforms to a standard paper size (e.g., A4 or A5), align the document between the appropriate paper size marks.
- If you do not know the size of your document, or if your document does not match any of the paper size marks, align the centre of your document with the → mark.

■ Loading Documents in the ADF (Only for the PC-D340/FAX-L400 Models)

- 1 Make sure there is no document on the platen glass.
- 2 Fan the edges that will feed into the machine first, then tap the edges of multiple page documents on a flat surface to even the stack.
- 3 Adjust the slide guides to the width of the document.

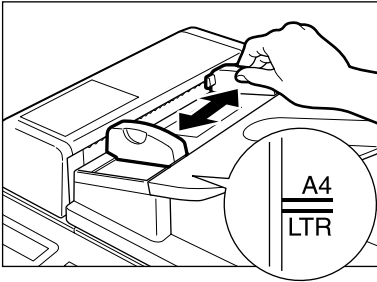

- 4 Load the documents face up in the ADF.

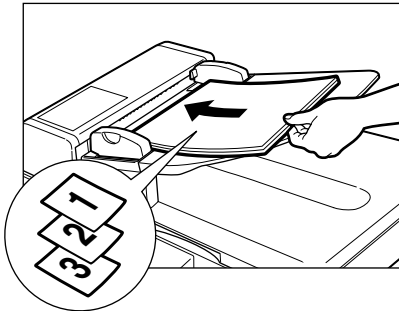

DOCUMENT READY

- The document is now ready for scanning.



NOTE

- For multiple page documents, the pages are fed one by one from the top of the stack (from the first page).
- Wait until all pages of your document have been scanned before starting a new job.
- 50 sheets of A4-size (80 g/m²) documents can be set in the ADF. If more than 50 sheets of A4-size documents are set in the ADF, paper jams may occur.

Chapter 4

Basic Printing from Your Computer

Before Printing

Before printing, CARPS software must be installed in your computer.

- If not, please see *Set-up Guide*.

Check if the machine is selected as the default printer.

- You can check if your machine is set as the default printer when you open the **Print** dialog box in an application and your machine is selected in the printer box (see below for details).

Follow this procedure if it is not selected.

- 1 On the Windows desktop, click **[Start]**, point to **[Settings]**, then click **[Printers]**.
- 2 In the **Printers** window, click the machine icon.
- 3 On the File menu, click **[Set as Default]** or **[Set as Default Printer]**.

Printing from the CARPS Software (Ex. Windows 98)

- 1 With your document open in the Windows 98 application, click the **[Print]** command.
- 2 In the **Print** dialog box, make sure your machine is selected in the printer box. If not, select your machine from the printer name drop-down list.
- 3 Click **[OK]** to print your document.

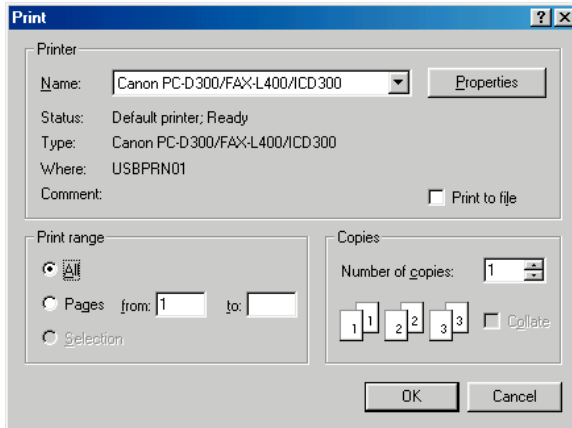

■ Cancelling Printing

- 1 If you want to cancel printing before clicking **[OK]**, click **[Cancel]** in the **Print** dialog box.
- 2 If printing has already begun, follow this procedure to cancel printing from Windows 98. On the Windows 98 desktop, click **[Start]**, point to **[Settings]**, then click **[Printers]**.
- 3 In the **Printers** window, double-click the machine icon, right click the print job, then click **[Cancel Printing]**.

■ Changing Print Settings

Your machine is initially installed using factory-predefined settings, enabling you to print immediately. These settings determine what your documents will look when printed. You can change these print settings to suit the document you are printing. Unless you save your settings as a profile, your settings are available only for the current print job. For details on print profiles → *Software Guide*.

- 1 With your document open in the Windows 98 application, click the **[Print]** command.
- 2 In the **Print** dialog box, click **[Properties]**.
- 3 In the **Properties** dialog box, define your settings on the appropriate tabs or dialog boxes.
 - If you are dissatisfied with your changes on a particular tab and want to revert to the default settings, click **[Restore Defaults]**.
- 4 To accept your changes and close the dialog box, click **[OK]**.
 - To cancel your changes and close the dialog box, click **[Cancel]**.

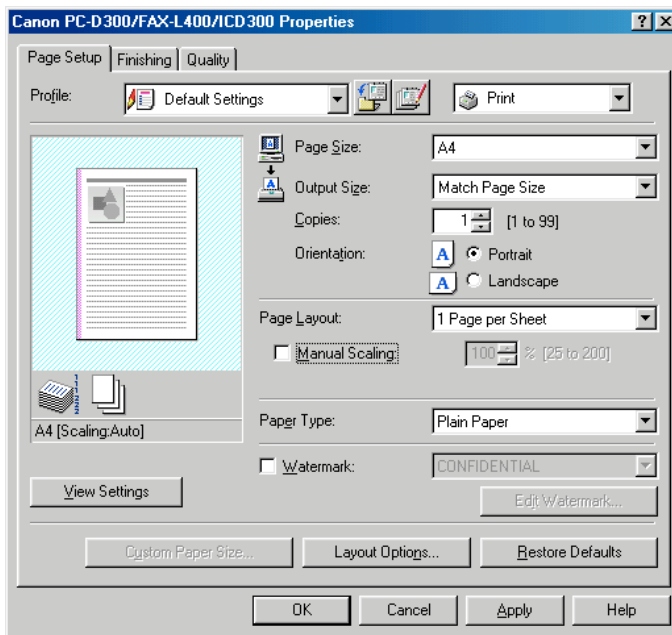

■ More Information

For detailed information on all printing features → *Software Guide*.

Chapter 5

Making Copies

Documents You Can Copy

For information on the types of documents you can copy, their requirements, and details on setting up documents → Chapter 3.

Copying Documents

1 Press **COPY** to set Copy mode.



NOTE

- For the PC-D320/PC-D340 models, this operation is not required.

Ex:

100%	TEXT	A4	01

2 Prepare the document and load it face up in the ADF or place it face down on the platen glass.

3 Set copy features if you wish. You can set the features below.

- Copy quantity (→ p. 5-3)
- Enlarging/Reducing (→ p. 5-5)
- Image quality (→ p. 5-7)
- Exposure (→ p. 5-8)
- Collate (→ *User's Guide*)
- 2 on 1 (→ *User's Guide*)



NOTE

- Please note that you can not change settings during copying.

4 Press **Start** to begin copying.

Ex:

SCANNING
COPY NO. 0001

- If the paper in the cassette or multi-purpose tray runs out during copying, the LCD displays **SUPPLY REC. PAPER**. Load paper in the cassette or multi-purpose tray. When paper is loaded, the machine automatically resumes copying.



- If you load paper while making copies, do not load a different paper size.
- You can reserve the next copy job while the machine is outputting copies. (→ *User's Guide*)
- After the machine finishes copying, the settings will remain. However, if you press **Stop/Reset** or no key is pressed for 2 minutes, they will be reset to the default settings (The time until the machine enters the **AUTO CLEAR** mode can be specified. (→ p. 8-4))
- The capacity of the output tray is 50 sheets (80 g/m²) of paper. To prevent paper jams, remove paper from the output tray before the count reaches 50.

■ Cancelling the Copy Job

■ While Scanning Documents in the ADF (Only for the PC-D340/FAX-L400 Models)

1 Press **Stop/Reset**.

STOP KEY PRESSED
PRESS OK KEY

2 Press **OK**.

- The document that has stopped in the ADF will come out.

■ After Scanning Documents

1 Press **Stop/Reset**.

CANCEL COPYING?
<YES NO>

2 Press **◀ (-)** for YES.

Basic Copying Functions

Making Multiple Copies

You can make multiple copies.

- 1 Use the numeric keys to enter the number of copies you want.



- The LCD displays the number of copies you entered.
- You can set up to 99 copies.



- You can reserve the next copy job while the machine is outputting copies. (→ *User's Guide*)
- The LCD keeps on displaying the specified number of copies until you change it or the auto clear function activates.

When the auto clear function activates, the LCD returns to the standby display and the number of copies returns to 01 (default setting).

Specifying the Paper Size and Type (Common for Cassette and Multi-purpose Tray)



- When making copies on A4-size paper after having continuously copied on paper smaller than A4-size paper, the copies may be dirty. To prevent copies from being dirty, wait about one minute before making copies.
- The paper in the multi-purpose tray is copied prior to the paper in the cassette.
- The settings changed in the Additional Functions are not returned automatically to the settings you set previously. Change to the previous settings again if necessary.
- When making copies of a small size or thick paper*, etc., the copy speed may be slightly slower than usual.
 - * The paper type should be selected in the Additional Functions.
- If you intend to make a copy and print with a thermal transfer printer on one sheet of paper, make the copy first. Failure to do so may make copies dirty or cause a paper jam.
- When copying onto transparencies, remove each transparency from the output tray as it is output.

■ Specifying the Paper Size

At the factory, the paper size has already been set to A4. Normally, you can make copies in this setting. However, when the copy images or the back of the paper are dirty, you can prevent the paper from getting dirty by specifying the paper size according to the following.



NOTE

- To set the Additional Functions, see “Accessing the Additional Functions”. (→ p. 8-1)

– To specify the paper size: Press **Additional Functions**, then select:

PAPER SETTINGS

PAPER SIZE

Then Use ◀ (–) or ▶ (+) to choose the appropriate paper size from A4, B5, A5, LTR, LGL, EXECUTIVE, ENVELOPE or FREE SIZE.

If you select ENVELOPE, Use ◀ (–) or ▶ (+) to choose the type of envelopes (COM10, MONARCH, DL, ISO-C5).

* When FREESIZE is selected, specify the horizontal and vertical size of the paper in millimetres (mm).

Available setting range in horizontal size : 127 mm to 356 mm

Available setting range in vertical size : 76 mm to 216 mm

■ Specifying the Paper Type

PLAIN PAPER is selected as the default paper type. When making copies on paper other than plain paper, you can specify the paper type according to the following. Specifying the paper type can prevent poor copy quality, or the copy image not being printed correctly.



NOTE

- To set the Additional Functions, see “Accessing the Additional Functions”. (→ p. 8-1)

Press **Additional Functions**, then select:

PAPER SETTINGS

PAPER TYPE

Then choose the paper type from the following.

– PLAIN PAPER

– TRANSPARENCY

– SPECIAL PAPER 1 (91 g/m² to 128 g/m²) : Thick paper

– SPECIAL PAPER 2 : Rough paper

■ Setting Enlarging/Reducing

You can enlarge or reduce the copy size using preset copy ratios or using custom copy ratios.

■ Enlarging/Reducing Using Preset Copy Ratios

1 Press **Enlarge/Reduce**.

Ex:

PRESET RATIO
- 100% +

2 Use ◀ (-) or ▶ (+) to select the copy ratio.

Ex:

PRESET RATIO
- 70% A4→A5 +

• You can select from the following:

- 200% MAX.
- 141% A5 → A4
- 100%
- 70% A4 → A5
- 50% MIN.

3 Press **OK**.

Ex:

70%	A4	01
□□■●	TEXT	



NOTE

- If the PAPER SIZE GROUP of COPY SETTINGS in the Additional Functions is set to INCH or AB, the preset copy ratios will be as follows:
INCH: 50%, 64%, 78%, 100%, 129% and 200%;
AB: 50%, 70%, 81%, 86%, 100%, 115%, 141% and 200%.
- Enlarging or reducing using preset copy ratio is not available with the 2 on 1 copy function.
- To reset the copy ratio, press **Enlarge/Reduce** several times to display DIRECT 100% ratio, then press **OK**.

■ Enlarging/Reducing Using Custom Copy Ratios

1 Press **Enlarge/Reduce** twice.

Ex:

ZOOM	50-200%	
-	100%	+

2 Use the numeric keys to enter the copy ratio.

Ex:

ZOOM	50-200%	
-	80%	+

- You can enter the copy ratio from 50% to 200%, selectable in 1% increments.
- Even after entering the copy ratio, you can use ◀ (-) or ▶ (+) to adjust the copy ratio. To increase the copy ratio, press ▶ (+). To decrease the copy ratio, press ◀ (-).

3 Press **OK**.

Ex:

80%	A4	01
□□■□●	TEXT	



NOTE

- Enlarging or reducing using custom copy ratio is not available with the 2 on 1 copy function.
- To reset the copy ratio, press **Enlarge/Reduce** several times to display DIRECT 100% ratio, then press **OK**.

■ Setting the Image Quality

You can adjust image quality to the appropriate level best suited for a document with text or photos. Three modes are available for adjusting image quality.

1 Press **Image Quality** to select the image quality.

Ex: 

Each time **Image Quality** is pressed, the image quality mode changes as follows:



– **TEXT**

Suitable for making copies from text originals. Good copies can be made from even blueprints or faint pencil-drawn originals.

– **TEXT/PHOTO**

Suitable for making copies from originals containing both text and photos, or photo originals containing half-tones (i.e. printed photos).

– **PHOTO**

Suitable for making copies from photos printed on photographic paper.



NOTE

- Copy exposure automatically changes to manual mode when **TEXT/PHOTO** or **PHOTO** is set.
- To sharpen the black and white contrast of an image, adjust the image as follows:

Press **Additional Functions**, then

select :

COPY SETTINGS

SHARPNESS (→ p. 8-3)

■ Adjusting the Copy Exposure

You can adjust the copy exposure automatically or manually according to how light or dark your document is.

■ Adjusting Automatically

- 1 Press **Exposure** to select the auto mode.

Ex:

DENSITY
AUTO EXPOSURE

- 2 Press **OK**.

Ex:

100%	A4	01
□ A ●	TEXT	

- The copy exposure is adjusted automatically.



NOTE

- Image quality mode automatically changes to **TEXT** when **AUTO EXPOSURE** is set.

■ Adjusting Manually

- 1 Press **Exposure** twice to select the manual mode.

Ex:

DENSITY
-LT □□□□□■□□□□ DK+

- 2 Use ◀ (-) or ▶ (+) to adjust the copy exposure.

- For a lighter copy exposure, press ◀ (-). For a darker copy exposure, press ▶ (+).

Ex:

DENSITY
-LT □□□□□■□□□□ DK+

- 3 Press **OK**.

Ex:

100%	A4	01
□□□■●	TEXT	



NOTE

- When setting the exposure lighter, the indicator moves to the left. When setting the exposure darker, the indicator moves to the right.

Special Features

The machine has the following SPECIAL COPY features. These features allow you to sort copies in page order and create special copies easily. For detailed information on these features → *User's Guide*.

- Collate Copy
Sorts copies in page order.
- 2 on 1
Reduces two A4-size documents to fit on a single A4-size paper.
- Reserve Copy
Reserves the next job while the machine is printing out.

Chapter 6

System Monitor

Checking the Status of Copy, Fax, Print and Report Jobs

Use System Monitor to confirm and delete the jobs.

When using System Monitor, the LCD displays the jobs in the following order in each mode.

In Copy mode,	In Fax mode,
- COPY STATUS	- FAX MONITOR
- FAX MONITOR	- COPY STATUS
- PRINT STATUS	- PRINT STATUS
- REPORT STATUS	- REPORT STATUS

- For FAX MONITOR → *Facsimile Guide*.

■ Confirming and Deleting a Copy Job

- 1 Press **System Monitor**.

Ex:

COPY STATUS
*0002 06×01



- If there is no job, NO COPY JOBS EXIST is displayed.

NOTE

- 2 Press **◀ (-)** or **▶ (+)** to confirm the job number, and the quantity of copies.

Ex:

COPY STATUS
0003 03×02

- 3 If you want to delete the copy job, press **OK**.

CANCEL COPYING?
<YES NO>

- 4 If you decide to delete the job, press **◀ (-)** for YES.



- To cancel deleting the job, press **▶ (+)** for NO.

NOTE

Once the job is deleted, the job can not be restored.

■ Confirming and Deleting a Print Job

1 Press **System Monitor** three times.

Ex:

PRINT STATUS

File name



NOTE

- If there is no job, NO PRINT JOBS EXIST is displayed.

2 Press **◀ (-)** or **▶ (+)** to confirm the file name.

Ex:

PRINT STATUS

3 If you want to delete the print job, press **OK**.

CANCEL PRINTING?
<YES NO>

4 If you decide to delete the print job, press **◀ (-)** for YES.



NOTE

- To cancel deleting the job, press **▶ (+)** for NO. Once the job is deleted, the job can not be restored.
- The LCD can display characters in ASCII cord. Using characters other than those in ASCII cord may have the LCD display garbled characters.

■ Confirming and Deleting a Report Job

1 Press **System Monitor** four times.

Ex:

REPORT STATUS *00 USER DATA LIST



NOTE

- If there is no job, NO REPORT JOBS EXIST is displayed.

2 If there is one report job and if you want to delete it, press **OK**.

CANCEL REPORT? <YES NO>

3 If you decide to delete the job, press **◀ (-)** for YES.

4 If there are multiple report jobs, press **◀ (-)** or **▶ (+)** to select the job you want to delete.

Ex:

REPORT STATUS 02 USER DATA LIST

5 Then press **OK**.

CANCEL REPORT? <YES NO>

6 If you decide to delete the job, press **◀ (-)** for YES.



NOTE

- To cancel deleting the job, press **▶ (+)** for NO.
Once the job is deleted, the job can not be restored.

Periodic Cleaning

Your machine requires little periodic maintenance. This section describes the necessary cleaning procedures for your machine.



- When cleaning the machine's exterior or the platen glass, be sure to disconnect the power cord before cleaning the machine.
- For the model with the fax function, print any received faxes stored in memory before disconnecting the power cord, since documents in memory are backed up only for about 1 hour when the power cord is disconnected. (→ *Facsimile Guide*)
- Do not use tissue paper, paper towels, or similar materials for cleaning; they can stick to the components or generate static charges. Use a soft cloth to avoid scratching the components.
- Never use volatile liquids such as thinner, benzene, acetone, or any other chemical cleaner to clean the interior of the machine; these can damage the machine's components.

Cleaning the Exterior

Wipe the machine's exterior with a clean, soft, lint-free cloth moistened with water or diluted dishwashing detergent solution.

Cleaning the Scanning Area

Wipe the scanning area (shaded area) with a clean, soft, lint-free cloth moistened with water, then wipe with a clean, soft, dry, lint-free cloth.

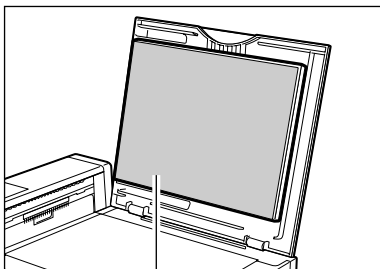

Platen glass cover

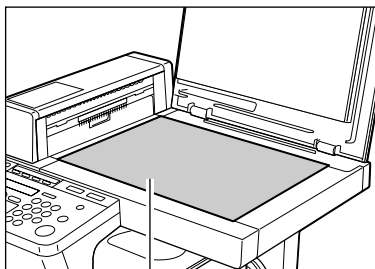

Platen glass

■ Cleaning the Read Area of the Platen Glass (Only for the PC-D340/FAX-L400 Models)

Black lines may appear in copies when the ADF is used to feed documents.

This is caused by paste, ink, correction fluid, or other foreign matters in the read area of the platen glass (shaded area). Use a clean soft cloth to wipe the read area clean. Take particular care to clean at the locations where the black lines are appearing on copies.

If you have trouble getting the glass clean, wipe with a cloth moistened with water or a mild neutral detergent, and then wipe the glass dry with another cloth.

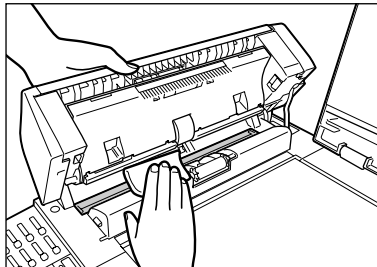
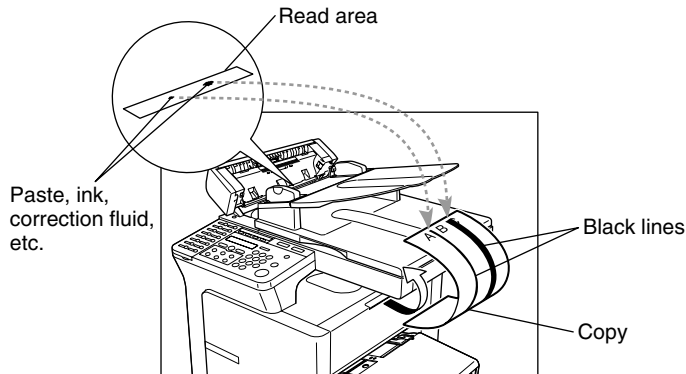

- Paste, ink, correction fluid, and other foreign matter can soil the platen glass when you send a document through the ADF while the paste, ink, or correction fluid on the original is still wet. This is what causes black lines on copies. Whenever you load a document in the ADF, always check to make sure that any paste, ink, or correction fluid that is on the document is completely dry.

When to Replace the Cartridge

The cartridge is a consumable item and should be replaced when the toner runs out. The following guidelines will help you to determine when to replace the cartridge.

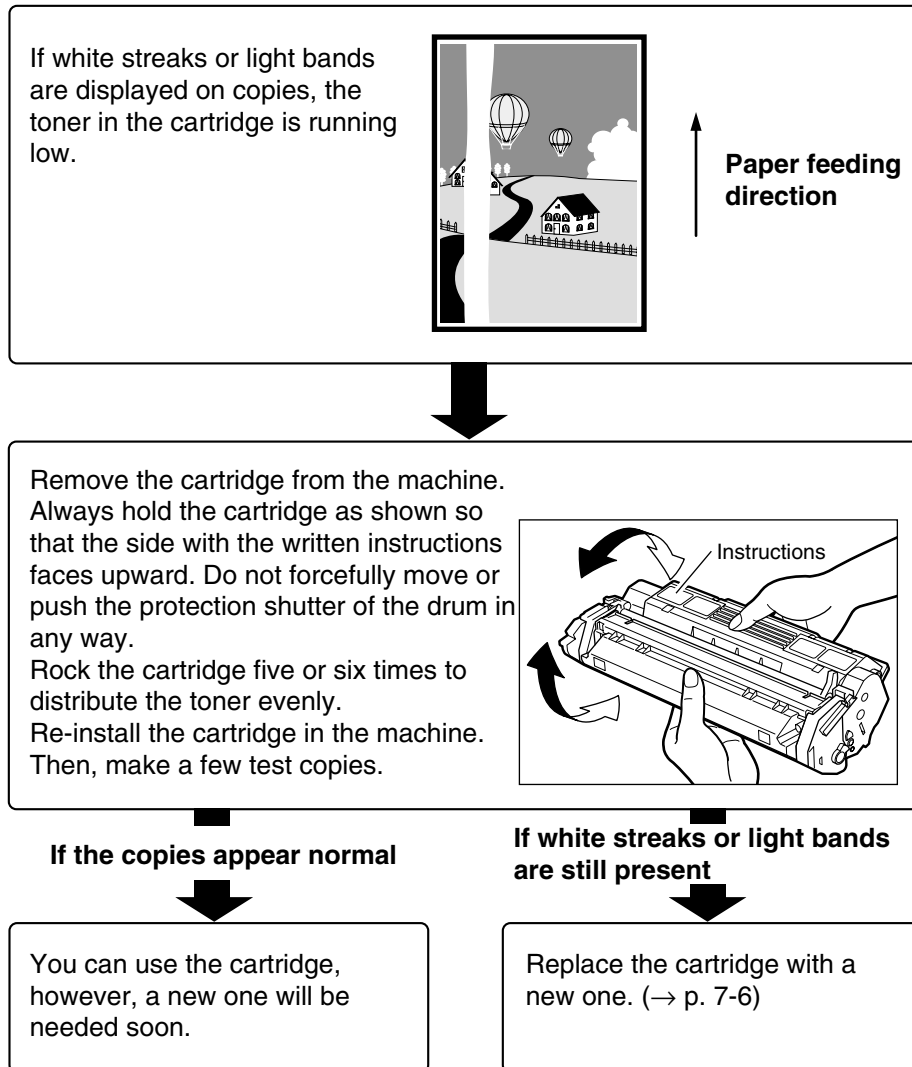

■ Copy Yield

This section describes the approximate number of copies that can be made per cartridge.

Approximate Copy Yield

Canon Cartridge T : Approx. 3500 copies (A4 at 5% dot coverage*).

* The term “A4 at 5% dot coverage” denotes an original on which the area covered with black ink is 5% of the total area of an A4-size sheet.

- The actual number of copies that can be made per cartridge depends in part on the copy exposure setting, room temperature and humidity.
- If you copy a large number of originals which contain heavy print or many photographs, toner consumption will increase, and white streaks will appear on copies sooner than indicated above. Toner consumption will also increase if you copy with the ADF left open.
- Small-sized originals and originals with less print will use less toner. However, although you may be able to use the cartridge longer than indicated above, dark bands might appear on copies.

■ Handling and Storing the Cartridge

This section describes the precautions to ensure optimum copy quality.

Handling Precautions



WARNING

- Do not throw cartridge into open flames, as this may cause the toner to ignite and result in burns or a fire.
- The cartridge emits low level magnetic flux. If you use a cardiac pacemaker and feel abnormalities, please move away from the cartridge, and consult your doctor.



IMPORTANT

- Never attempt to disassemble the cartridge or open the protective shutter of the drum.



NOTE

- If the machine is brought from the cold outdoors into a warm room, or if the room is rapidly heated, condensation may form inside the machine. This can adversely effect the quality of your copy images (e.g., copies are completely black). When the machine is exposed to such conditions, allow at least two hours for the machine to adjust to room temperature before attempting to use it.
- Always hold the cartridge as shown so that the side with the instructions faces upward. Do not forcefully move or push the protective shutter of the drum in any way.

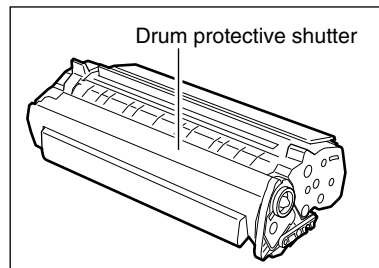
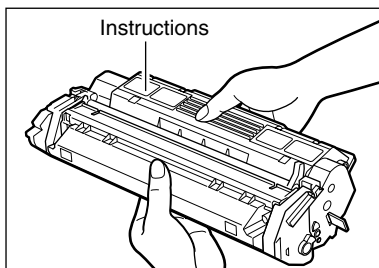

Storage Precautions



- Do not store cartridges or copy paper in places exposed to open flames, as this may cause the toner or copy paper to ignite and resulting in burns or a fire.



- Keep cartridges and other consumables out of the reach of children. If the contents of these items are ingested, consult a physician immediately.



- Place the cartridge in its protective bag so that the side with the written instructions is facing upward. Then, place the bagged cartridge into its shipping box. Store the unused cartridge out of direct sunlight.
- For partially used/opened cartridges, place the cartridge in its protective bag so that the side with the written instructions is facing upward. Then place the bagged cartridge into its shipping box and store it away from direct sunlight.
- Avoid storing the cartridge in front of heaters and humidifiers, etc. Store it in a location where the temperature does not exceed 40°C.
- The recommended storage conditions are as follows:
Temperature 15°C to 27°C
Relative Humidity 20% to 80%.
- Do not stand the cartridge on end or turn it upside down.

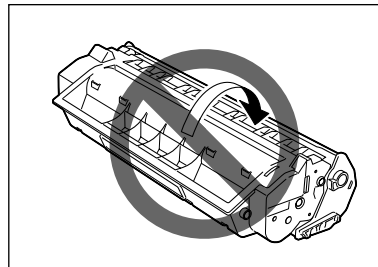
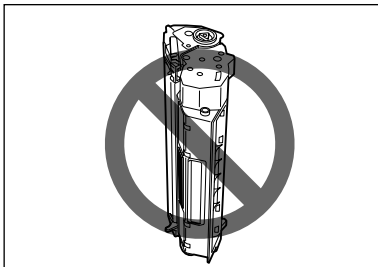

Storing Partially Used Cartridges

If you remove a cartridge from the machine, store the cartridge as described below.

Place the cartridge in its protective bag so that the side with the written instructions is facing upward. Then, place the cartridge into its shipping box. Be sure to securely close the lid of the shipping box.

If you do not have the protective bag or shipping box for the cartridge, store the cartridge in a dark location.

Recycling Used Cartridges

In order to make effective use of the earth's natural resources and protect the environment, we urge you to recycle used cartridges. Do our part by returning used cartridges to the place of purchase.

Replacing the Cartridge

This section describes how to remove the used cartridge and replace it with a new one. Before replacing the cartridge, be sure to read the section “When to Replace the Cartridge”. (→ p. 7-3)

- 1 Open the right cover.

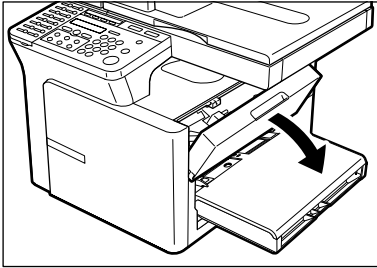

- 2 Remove the cartridge from the machine.

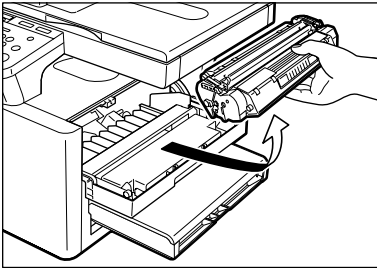

- 3 Remove the new cartridge from its protective bag.



NOTE

- Save the protective bag. You may need it later when you remove the cartridge from the machine.

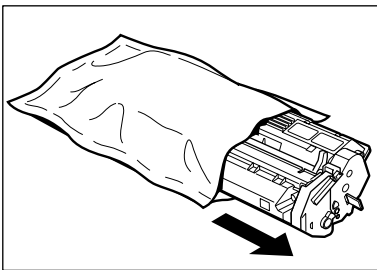

- 4** Rock the cartridge five or six times to distribute the toner evenly.

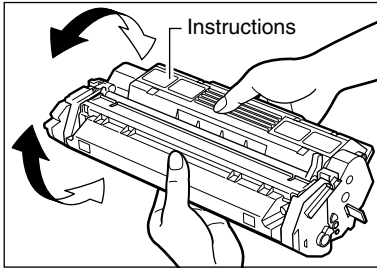

- 5** Place the cartridge on a flat and stable surface. Grip the sealing tape tab and snap it in the direction as shown below. Make sure that the tab itself is detached from the cartridge.

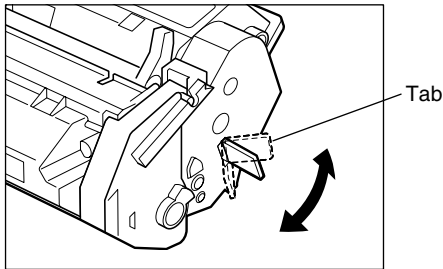

- 6** While grasping the cartridge with one hand, firmly and slowly pull the sealing tape tab with the other hand to remove the sealing tape completely. Throw the tape away.

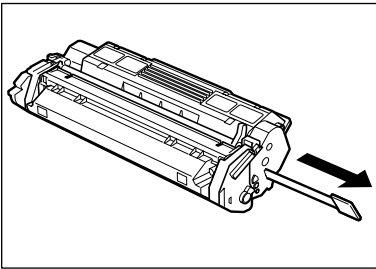

IMPORTANT

- To avoid breaking the tape, do not pull the tape out at an upward or downward angle.



- 7** Hold the cartridge and position the arrow mark on the cartridge towards the inside of the machine shown below.

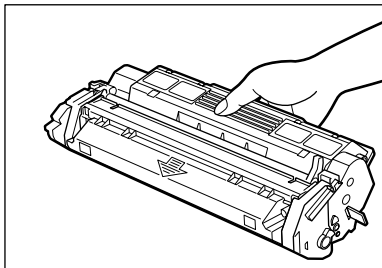

- 8** Align the projections **(A)** on both sides of the cartridge to the guides **(B)** in the machine (location **①**) and gently slide the cartridge into the machine until the right cover slightly rises up (location **②**).

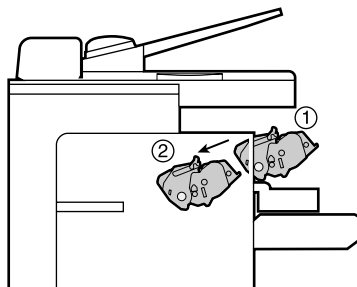
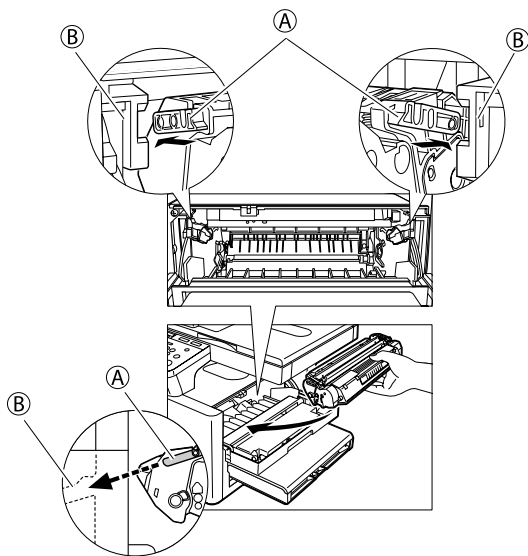

IMPORTANT

- The right cover moves simultaneously with the action of the cartridge. Do not push the cartridge farther than the location **②**. Doing so will result in catching your hand in the right cover.

9 Close the right cover and the cartridge will be set in place (location ③).

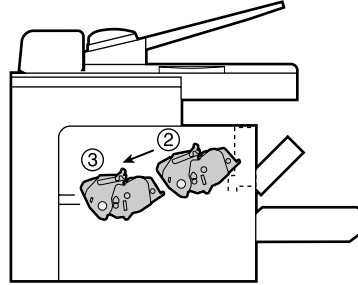
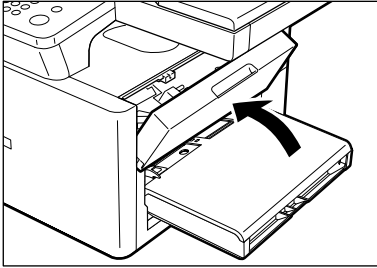

NOTE

- If the LCD displays **INSTALL CARTRIDGE**, reset the machine by opening the right cover and then closing it.

Chapter 8

Setting the Additional Functions

Understanding the “Additional Functions”

The menus of the Additional Functions can allow you to specify or register various settings. This chapter explains the procedure to access the menus, and the contents of the menus related to the common settings and the copy functions.



- To specify or register the settings of the fax function → *Facsimile Guide*.

NOTE

■ Accessing the Additional Functions

1 Press **Additional Functions**.

2 Press ◀ (-) or ▶ (+) to select the menu you want to change → press **OK**.

Ex:

ADDITIONAL FUNCTIONS 3.COPY SETTINGS	→	COPY SETTINGS 1.STD. IMAGEQUALITY
-----------------------------------------	---	--------------------------------------

3 Use ◀ (-) or ▶ (+) to select the sub menu you want to change.

Ex:

COPY SETTINGS 2.STANDARD EXPOSURE

4 Press **OK**.

Ex:

STANDARD EXPOSURE MANUAL



NOTE

- Details for sub menus → pp. 8-2 to 8-5.
- After selecting the item or value with ◀ (-) or ▶ (+), press **OK** to enter the setting.
- If you press **Stop/Reset** before **OK** is pressed, the item you have selected will not be registered.
- Press **Stop/Reset** to exit from Additional Functions.
- If you press **Additional Functions**, the display returns to the previous screen.

■ Menu Descriptions

PAPER SETTINGS

Action	Descriptions
PAPER SIZE	Selects the paper size. A4 , B5, A5, LTR, LGL, EXECUTIV, ENVELOPE (COM10, MONARCH, DL, ISO-C5), FREESIZE (Horizontal and vertical size can be specified in millimetres.)
PAPER TYPE	Select the paper type. PLAIN PAPER , TRANSPARENCY, SPECIAL PAPER 1, SPECIAL PAPER 2

COMMON SETTINGS

Action	Descriptions
PRINT EXPOSURE	The exposure can be adjusted to one of five levels. (centre)
TONER SAVER MODE	Sets the toner saver mode.
ON	The toner saver mode is turned on.
OFF	The toner saver mode is turned off.
DISPLAY LANGUAGE	Select the message language. ENGLISH , FRENCH, SPANISH, GERMAN, ITALIAN, DUTCH, FINNISH, PORTUGUESE, NORWEGIAN, SWEDISH, DANISH, SLOVENE, CZECH, HUNGARIAN, RUSSIAN

(The factory default setting is in **bold** face.)



- For the FAX-L400 model, **DEFAULT SETTINGS**, **SW AFTER AUTO CLR** and **VOLUME CONTROL** are also displayed. (→ *Facsimile Guide*)

COPY SETTINGS

Action	Descriptions
STD. IMAGEQUALITY	Select the document type. TEXT ORIGINAL : Character mode TEXT/PHOTO* ¹ : Text/photo mode PHOTO* ¹ : Photo mode
STANDARD EXPOSURE	Select the auto or manual mode of exposure setting.
AUTO* ²	The exposure is adjusted automatically.
MANUAL	The exposure is adjusted manually. The exposure can be adjusted in 9 steps. (centre)
STD ZOOM RATIO	Selects the copy ratio 050% to 200%. (100%)
STANDARD COPY QTY	Select the copy quantity. 01 to 99 (01)
AUTO SORT	Set the auto sort.
ON	The auto sort function is turned on.
OFF	The auto sort function is turned off.
PAPER SIZE GROUP	The paper size group can be selected. If the paper size group is changed, the preset copy ratios, 2 on 1 copy ratio and 2 on 1 paper size will change.
INCH	Preset copy ratios: 50%, 64%, 78%, 100%, 129%, 200% 2 on 1 copy ratio: 64%, LTR size
A	Preset copy ratios: 50%, 70%, 100%, 141%, 200% 2 on 1 copy ratio: 70%, A4 size
AB	Preset copy ratios: 50%, 70%, 81%, 86%, 100%, 115%, 141%, 200% 2 on 1 copy ratio: 70%, A4 size
SHARPNESS	Black and white of an image can be sharpened. When you want to make characters and lines clear, select a big number. When you make copies of photographs, select a small number. 1 to 9 (5)

(The factory default setting is in **bold** face.)

*¹ STANDARD EXPOSURE automatically changes to MANUAL when TEXT/PHOTO or PHOTO is selected.

*² STD. IMAGEQUALITY automatically changes to TEXT ORIGINAL when AUTO is selected.



NOTE

- FAX SETTINGS (Only for the FAX-L400 model) for details → *Facsimile Guide*.
- ADD. REGISTRATION (Only for the FAX-L400 model) for details → *Facsimile Guide*.

PRINTER SETTINGS

Action	Descriptions
PRESET PRINT QTY	Sets the standard number of pages of the printer function. 01 to 99 (01)
AUTO ERROR SKIP	Sets either printing with skipping an error automatically, or without skipping an error.
ON	The auto error skip is on. The error is skipped and shifted to the next job automatically without indicating an error code.
OFF	The auto error skip is off. Skip the error and shift to the next job manually.
ERROR TIME OUT	Sets the length of time before the machine returns an error when no data is received from the computer.
ON	The error time out is on. Sets time out period 005SEC to 300SEC. (015SEC)
OFF	The error time out is off.
PRINTER RESET	Cancels the job currently being received and the job already received.

TIMER SETTINGS

Action	Descriptions
DATE/TIME SETTING	Enter the current date and time.
AUTO CLEAR	Sets the auto clear function. If the machine remains idle for a certain period of time, the display returns to the standby mode.
ON	The auto clear function is turned on. 1MIN. to 9MIN. (2MIN.)
OFF	The auto clear function is turned off.
ENERGY SAVER	The energy saver mode can be set.
ON	The energy saver mode is set. 03MIN. to 30MIN. (05MIN.)
OFF	The energy saver mode is turned off.
DATE SETUP	Set the format for the DATE & TIME settings menu and how the date is displayed in the LCD. DD/MM YYYY, YYYY MM/DD, MM/DD/YYYY

(The factory default setting is in **bold** face.)

PRINT LISTS

Action	Descriptions
USER DATA	Prints out a list of items set or registered in the Additional Functions.
CANCEL REPORT	Cancels printout of the report. Select report you want to cancel the printout.
CANCEL REPORT?	
YES	The printout of the list is cancelled.
NO	The printout of the list is not cancelled.



NOTE

- For the FAX-L400 model, SPEED DIAL LIST is also displayed. (→ *Facsimile Guide*)

Appendix:

Specifications

Type:	Personal Desktop
Platen:	Stationary Automatic Document Feeder: 50 sheets (A4-size, 80 g/m ²)
Photoconductive Material:	Organic Photosensitive Conductor
Copying System:	Indirect Electrostatic Transfer System
Developing System:	Toner Projection System
Fixing System:	Canon's RAPID Fusing System™
Resolution:	Approx. 1200 dpi × 600 dpi
Number of Tones:	256
Acceptable Originals:	Up to Legal size Sheets, books, and three-dimensional objects (up to 2 kg)
Acceptable Copy Stock:	Cassette Feeding: 64 g/m ² to 128 g/m ² Multi-purpose Tray: 64 g/m ² to 128 g/m ² Plain paper, coloured paper, recycled paper, transparencies, envelopes and heavy paper (up to 128 g/m ²)
Copy Sizes:	Legal (A4 to 76.2 mm × 127 mm)
Non-image Area:	paper: 2 mm at each edge Envelope: 10 mm at each edge
Warm-up Time:	1 sec. (at room temperature of 20°C)
First Copy Time:	Platen glass: 11 sec. ADF: 14 sec. { A4-size, direct, Manual Exposure Control, Cassette Feeding (except just after being restored from energy saver mode) }
Copy Speed:	Direct: A4 14 cpm
Magnification:	1:1±1.0%, 1:2.000, 1:1.294, 1:0.786, 1:0.647, 1:0.500 Zoom: 0.500 - 2.000 in 1% increments
Paper Feeding System:	Cassette Feeding 250 sheets of 64 g/m ² Multi-purpose Tray: 10 sheets of 64 g/m ²
Multiple Copies:	1- 99
Power Requirements:	220V-240V, 50 Hz [Power requirements differ depending on the country in which you purchased the copier.]
Power Consumption:	FAX-L400: Approx. 0.67 kw (max.) PC-D340: Approx. 0.67 kw (max.) PC-D320: Approx. 0.67 kw (max.)
Dimensions (W × D × H):	FAX-L400: 543 mm × 457 mm × 453 mm PC-D340: 543 mm × 457 mm × 453 mm PC-D320: 543 mm × 446 mm × 347 mm
Installation Space (W × D):	625 mm × 457 mm [with the cassette and multi-purpose tray attached]
Weight:	FAX-L400: Approx. 16.1 kg (including cartridge) PC-D340: Approx. 16.0 kg (including cartridge) PC-D320: Approx. 14.5 kg (including cartridge)

Features are subject to change without notice due to product improvements.

For high-quality copies, we recommended using paper and transparencies recommended by Canon. Some types of paper available at office supply stores may not be suitable for this copier. If you have any questions about paper and transparencies, consult your dealer or Canon Customer Relations.

- ◀ (-), ▶ (+) key1-7
- 2 on 1
 - copy5-9
 - key1-7
- A**
- Additional Functions
 - accessing8-1
 - key1-7, 8-1
 - understanding8-1
- ADF (Automatic Document Feeder)
 - capacity3-3
 - loading documents in3-3
- Alarm indicator1-8
- AUTO CLEAR setting5-2, 8-4
- AUTO ERROR SKIP setting8-4
- AUTO SORT setting8-3
- C**
- CANCEL REPORT setting8-5
- CARPS software4-1
- Cartridge
 - handling7-4
 - replacing7-3, 7-6
 - storage7-5
- Cassette1-5, 2-2
- Cleaning
 - machine's exterior7-1
 - periodic7-1
 - scanning area7-1
- Collate
 - copy5-9
 - key1-7
- COMMON SETTINGS8-2
- Convention, typevi
- COPY key1-7
- COPY SETTINGS8-3
- Copy yield7-4
- Copying
 - adjusting the copy exposure5-8
 - document requirements3-1
 - paper requirements2-1
 - setting enlarging/reducing5-5
 - setting the image quality5-7
- Customer support1-1
- D**
- DATE SETUP setting8-4
- DATE/TIME SETTING setting8-4
- DISPLAY LANGUAGE setting8-2
- Document
 - guides1-4
 - loading3-3
 - output tray1-5
 - positioning3-2
 - quantity3-1
 - requirements3-1
 - size3-1
 - type3-1
 - weight3-1
- Document feed
 - ADF3-3
 - feeder tray1-4
 - platen glass1-5, 3-2

E	
Energy Saver key	1-8
ENERGY SAVER setting	1-9, 8-4
Enlarge/Reduce	
key	1-7
setting	5-5
ERROR TIME OUT setting	8-4
Exposure	
automatically	5-8
key	1-7
manually	5-8
External device jack	1-4
F	
FAX key	1-8
Feeder	1-4
G	
Guides	
document	1-4, 3-3
H	
Handling, safety instructions	1-3
Handset jack	1-4
I	
Image Quality key	1-7, 5-7
Image Quality, setting	5-7
Indicator	
alarm	1-8
in use/memory	1-8
In Use/Memory indicator	1-8

L	
LCD	1-7
Left cover	1-4
Loading	
documents in the ADF	3-3
Loading paper	
in the cassette	2-2
Location, safety instructions	1-1
M	
Maintenance, safety instructions	1-3
Menu descriptions	8-2
Multi-purpose tray	1-5
Multiple copies	5-3
N	
Numeric keys	1-8
O	
OK key	1-7
Operation panel	1-7
Output tray	1-5
P	
Paper	
cassette	1-5
jam	2-1
loading	2-2
requirements	2-1
PAPER SETTINGS	8-2
PAPER SIZE GROUP setting	8-3
PAPER SIZE setting	8-2
PAPER TYPE setting	8-2
Plain paper	2-1

Platen	
glass.....	1-5
glass cover.....	1-5
Positioning documents.....	3-2
Power cord connector	1-4
Power supply, safety instructions	1-2
PRESET PRINT QTY setting	8-4
PRINTER RESET setting.....	8-4
PRINTER SETTINGS.....	8-4
Preset Reduction/Enlargement.....	5-5
PRINT EXPOSURE setting	8-2
Printing	
from your computer	4-2
PRINT LISTS	8-5
Print media	
requirements.....	2-1
size	2-1
type.....	2-1
weight.....	2-1
Q	
Quantity	
document.....	3-1
setting.....	5-3
R	
Reduction/Enlargement	5-5
Replacing	
cartridge.....	7-3, 7-6
Reserve Copy.....	5-9
Right cover.....	1-5, 7-6

S

Safety instructions	
handling.....	1-3
location.....	1-1
maintenance	1-3
power supply.....	1-2
SHARPNESS setting.....	8-3
Size	
document.....	3-1
indicators.....	3-2
print media	2-1
Slide guides	
ADF	1-4, 3-3
STANDARD COPY QTY setting	8-3
STANDARD EXPOSURE setting	8-3
Start key	1-8, 5-2
STD ZOOM RATIO setting	8-3
STD. IMAGEQUALITY setting	8-3
Stop/Reset key.....	1-8, 5-2
System Monitor	
key.....	1-7
use	6-1
T	
TIMER SETTINGS	8-4
Toner in the cartridge.....	7-3
TONER SAVER MODE setting.....	8-2
Transparencies.....	2-1, 3-1
Tray	
multi-purpose	1-5
output	1-5
Telephone line jack.....	1-4

U

USER DATA setting	8-5
USB interface connector.....	1-4

W

Weight	
document.....	3-1
machine	A-1
print media	2-1

Z

Zoom.....	5-6
-----------	-----

Canon

CANON INC.

30-2, Shimomaruko 3-chome, Ohta-ku, Tokyo 146-8501, Japan

CANON U.S.A., INC.

One Canon Plaza, Lake Success, NY 11042, U.S.A.

CANON CANADA INC.

6390 Dixie Road Mississauga, Ontario L5T 1P7, Canada

CANON EUROPA N.V.

Bovenkerkerweg 59-61 P.O. Box 2262, 1180 EG Amstelveen, The Netherlands

CANON FRANCE S.A.

17, quai du Président Paul Doumer 92414 Courbevoie Cedex, France

CANON COMMUNICATION & IMAGE FRANCE S.A.

(Pour les utilisateurs de l'imprimante laser uniquement)

102, avenue de Général de Gaulle 92257 La Garenne-Colombes Cedex, France

CANON (U.K.) LTD.

Woodhatch, Reigate, Surrey, RH2 8BF, United Kingdom

CANON DEUTSCHLAND GmbH

Europark Fichtenhain A10, 47807 Krefeld, Germany

CANON ITALIA S.p.A.

Palazzo L Strada 6 20089 Milanofiori Rozzano (MI) Italy

CANON LATIN AMERICA, INC.

703 Waterford Way Suite 400 Miami, Florida 33126 U.S.A.

CANON AUSTRALIA PTY. LTD

1 Thomas Holt Drive, North Ryde, Sydney, N.S.W. 2113, Australia

CANON SINGAPORE PTE. LTD.

79 Anson Road #09-01/06, Singapore 079906

CANON HONGKONG CO., LTD

9/F, The Hong Kong Club Building, 3A Chater Road, Central, Hong Kong

**230V
UK**

Free Manuals Download Website

<http://myh66.com>

<http://usermanuals.us>

<http://www.somanuals.com>

<http://www.4manuals.cc>

<http://www.manual-lib.com>

<http://www.404manual.com>

<http://www.luxmanual.com>

<http://aubethermostatmanual.com>

Golf course search by state

<http://golfingnear.com>

Email search by domain

<http://emailbydomain.com>

Auto manuals search

<http://auto.somanuals.com>

TV manuals search

<http://tv.somanuals.com>