

# REALiS

SX7 SX6 SX60 X700



LCOS Projectors Engineered For Superior Color and Detail

**Canon**  
*image*ANYWARE



# The Difference is in The Details

Canon's REALiS brand projectors feature LCOS (liquid crystal on silicon) technology, recently described by a leading trade magazine as "sort of a 'best of breed' combination of LCD and DLP technologies." LCOS technology produces lattice-free seamless images, and unlike LCD has no "screen door effect" to mute color and detail. LCOS technology has been highly coveted for providing exceptional color, intricate details,

easy-to-read type (as small as 7 pt.) and "HD images that jump out at the viewer in breathtaking quality," making it the ideal projector for demanding uses and applications. These include medical image presentations, display of CAD engineering drawings and blueprints, faithful color reproduction of professional photography, as well as countless uses for business, higher education and government.

## REALiS LCOS Projectors vs. Transmissive LCD Projectors

The surface area of each pixel in Transmissive LCD projectors is small, creating an overall grid-like lattice effect ("screen door effect"), which results in muted colors and text that appears faint and uneven. REALiS LCOS projectors have minimal gaps between the pixels, creating color-rich, detailed images, and text that appears dark and crisp. The advantages are easy to see:

### Display of Fine Lines

Display of fine lines: CAD images, blueprints, and fine lines are reproduced smoothly and accurately with REALiS high-resolution projectors.



### Display of Color and Detail

REALiS SXGA+ models can be presented with exceptional color and intricate detail.



### Display of Small Text

By using more pixels for each letter, REALiS projectors can display easy-to-read type, as small as 7 pt. often illegible on LCD-based XGA projectors.



### Display of Fine Grained Objects

REALiS lattice-free images ensures smooth, crisp displays of fine grained objects, including metallic surfaces, typically dulled by LCD projectors.



### LCOS vs. DLP

LCOS Technology displays even subtle color gradation and tones of black and grey, which enhance visual accuracy, while DLP has a limited grey scale.

# Canon's LCOS Projectors: What's Behind "Color-So-Real?"

## The Secret is AISYS-Enhanced LCOS Technology

Canon's proprietary AISYS optical system enhances LCOS technology to achieve crisp, color-rich, intricately-detailed images by efficiently utilizing and equalizing light from the projector lamp. This unique technology effectively boosts the performance functions of brightness and contrast to optimize image quality, in a more compact housing that

maximizes affordability. New Optical elements were incorporated into the illumination optical system to enhance uniformity of light. The Polarizing Beam Splitters (PBS) in the color separation and recombination system were redesigned for more precise light control resulting in a new standard in bright, beautiful, high-contrast projected images.

### Engineered for Superior Color \*

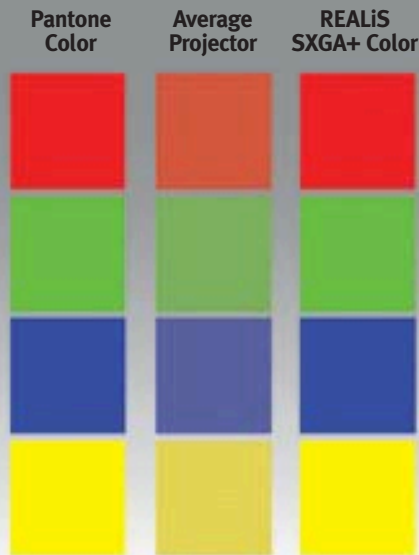

\* Simulated image

### Advantages of the AISYS Optical System

- Seamless image
- High Contrast
- Compact Size
- High Definition
- Accurate Color Reproduction
- Brightness

LCOS Reflective LCD Panels  
(Liquid Crystal On Silicon)

**Color Separation/Recombination System**  
Newly developed optical PBS for color separation with a new layout boosts the brightness of the projected image

**PBS: Polarization Beam Splitter**

**Illumination Optical System**  
Creates highly uniform light

**Projection Lamp**

**Projection Lens**

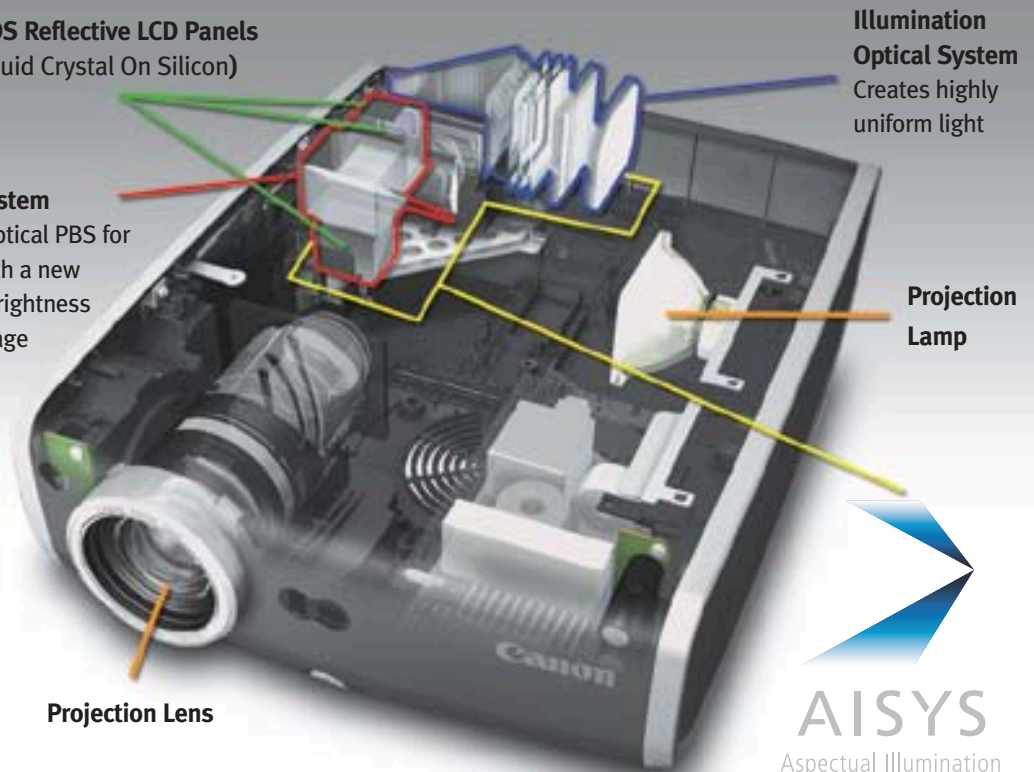

## Professional Photography

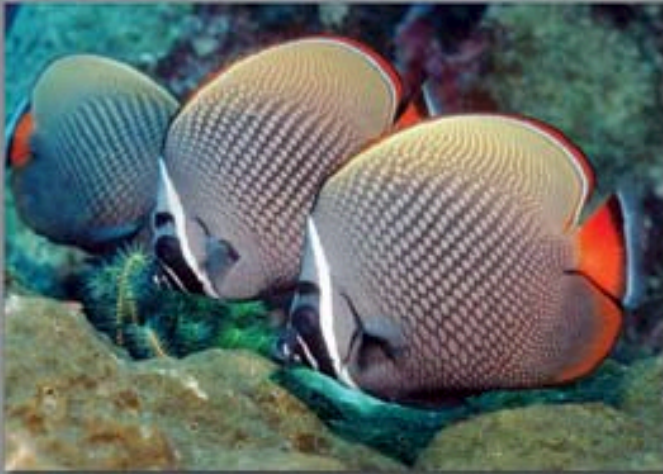

Color coded models recommended for this application.

## Medical Imaging

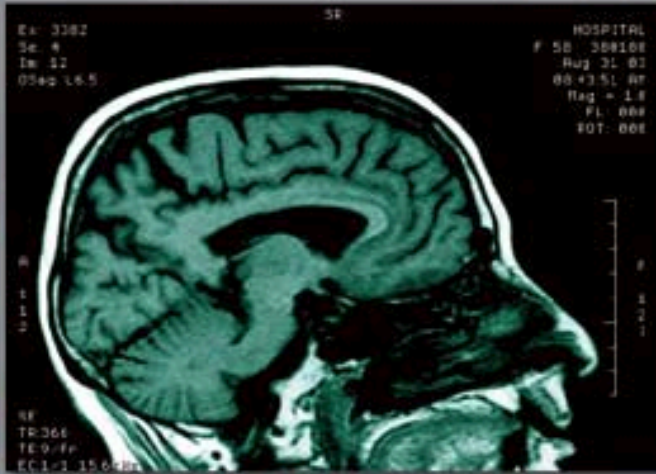

## Engineering Design



### REALiS SX7

**HD  
ready**

- SXGA+ (1400 x1050)
- LCOS and AISYS Improved
- 1.7x Powered Zoom Lens
- 4000 ANSI Lumens
- 1000:1 Contrast Ratio
- Adobe RGB Color Match System
- Auto Set-up



### REALiS SX6

**HD  
ready**

- SXGA+ (1400x1050)
- LCOS and AISYS Improved
- 1.7x Powered Zoom Lens
- 3500 ANSI Lumens
- 1000:1 Contrast Ratio
- Adobe RGB Color Match System
- Auto Set-up

## Higher Education



## Government



## Business



### REALiS SX60

**HD  
ready**

- SXGA+ (1400x1050)
- LCOS and AISYS Improved
- 1.7x Powered Zoom Lens
- 2500 ANSI Lumens
- 1000:1/2000:1 Contrast Ratio
- Home Cinema Mode
- Auto Set-up
- Screen Aspect Modes
- HDCP Compliant

### REALiS X700

- XGA (1024 x768)
- LCOS and AISYS Improved
- 1.7x Powered Zoom Lens
- 4000 ANSI Lumens
- 1000:1 Contrast Ratio

# Engineered for Precise Color and Detail.

# The REALiS Advantage

Canon's two new LCOS Multimedia Projectors, the REALiS SX7 and REALiS X700 join the REALiS SX6 and REALiS SX60 offering an impressive line-up of high and super-high (SXGA+) resolution projectors. Whether the projectors are being used by medical or engineering professionals displaying intricately-detailed, color-rich images; professional photographers or graphic artists needing to precisely match Adobe RGB color; business people or educators presenting charts and images in stunning detail; government or security users requiring exacting imagery; or even discerning home theatre enthusiasts, Canon's new REALiS Multimedia Projector line provides the features and performance to exceed their quality expectations.

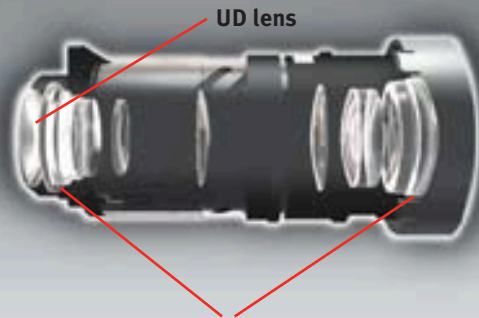

UD lens

Two high-precision double-sided aspherical lenses

## Genuine Canon Optics 1.7x Power Zoom Lens

Canon's SX7, SX6, SX60 and X700 are equipped with a 1.7X Powered Zoom Lens. The lens configuration is a six-group assembly with 12 elements and four moving groups, featuring one UD lens and two high-precision double-sided aspherical lenses.

## Throw Distance

The 1.7x Ultra-Wide Powered Zoom Lens has the widest zoom range of any of Canon's projector lenses, giving you a diagonal screen size range of 40" (at a very short distance of 3.9') to 100" at 9.8' and up to 300" maximum. (See chart page 11.)

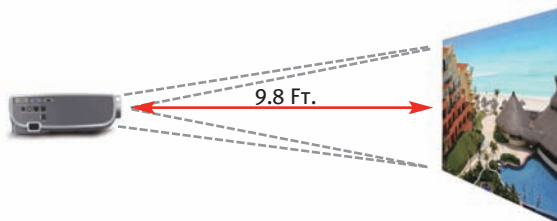

Placement for projection on a 100-inch screen.

## Auto Set-up



Press Auto Set, and within seconds your input source is connected, distortion corrected, focus sharpened and color balanced.



## Auto Keystone

Automatically calculates the angle of the projector and corrects for image distortion. Vertical ( $\pm 20^\circ$ ).

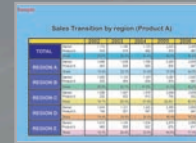

## Auto Focus

An infrared sensor on the front of the unit measures the distance to the screen and adjusts the focus in as quickly as one second.



## Auto Screen Color

Automatically adjusts the color balance according to the projection surface's color.

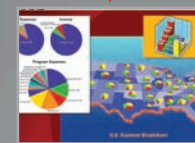

## Auto Input

Automatically detects the image signal from the input terminal, identifies it as the input signal and selects it for display.

Input Signal	Terminal
Digital PC	DVI-I
Digital Video	DVI-I
Analog PC	DVI-I, Mini D-sub 15
Component	Mini D-sub 15
SCART	Mini D-sub 15
Video	RCA signal
S-Video	Mini DIN4

## Super-High (SXGA+) Resolution

(SXGA+ models only)

SXGA+ can project 3.1 times the display area of SVGA and 1.9 times the area of XGA to clearly display large amounts of detailed information, such as simultaneous projection of multiple PC windows (SX7, SX6, SX60).

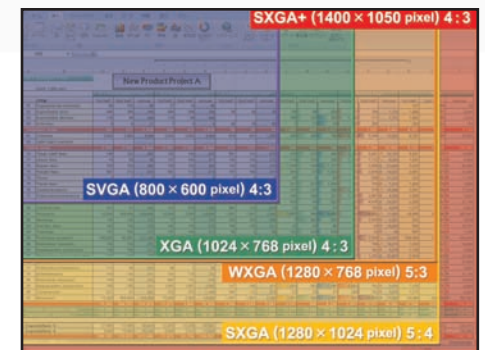



## Off and Go

All REALiS models are equipped with an internal charging system to run the fan. This makes it possible to unplug the projector right after using it, while the internal charging system keeps the fan running.

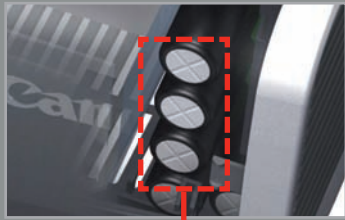

Internal charging system for cooling fan.



When presentation is finished, the unit can be unplugged immediately.

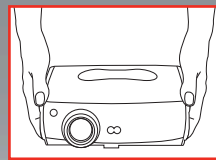
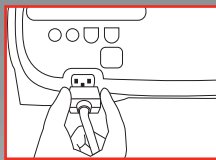
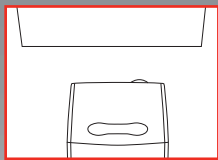

## Direct Power On

All REALiS models can be switched on and off from a central control terminal without actually pressing the buttons on the main unit, permitting remote operation when the projector is mounted overhead. It is also possible to control the power supply by simply connecting or disconnecting the power cable.



When Direct Power setting is 'On', the projector starts up automatically when power is supplied and is ready to display images in approx. 20 seconds.



## AC Projector Lamp

The REALiS SX7 and X700 models feature a newly engineered AC Lamp that effectively boosts the purity of the projected reds and greens (see chart at right) and provides superior color and longer life. This results in noticeably more vivid images and greater overall value.

### Enhanced purity of reds and greens

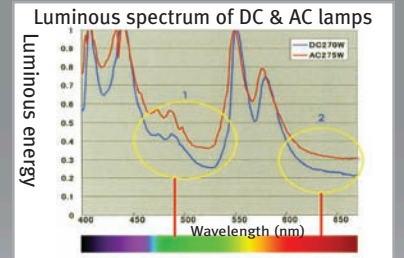

# Feature-Rich Technology Engineered For Excellence.

## Audio input & output

**SX7** **X700**

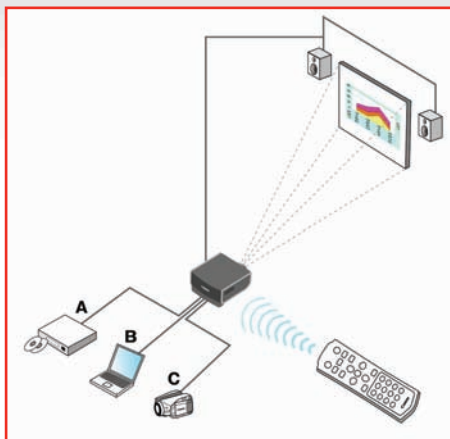

Audio input source switches automatically to match the image signal input source. Audio output terminals permit connection to external audio devices making it easy to control sound levels from the projector's remote control unit.

## Compatible with a variety of image input signals, including HDTV

**SX7** **X700**

**SX6** **SX60**

Monitor output

Analog RGB input/  
Component input

Digital RGB input/  
Analog RGB input (DVI-I)

Stereo audio input

Stereo audio output

Service port

S-Video input

Video terminal

USB port



Monitor output

Analog RGB input/  
Component input

Digital RGB input/  
Analog RGB input (DVI-I)

Stereo audio input

Video input

S-Video terminal

Service port

USB port



## Incredibly True Color: Display “Superior” and Highly Accurate Adobe RGB and sRGB Color

REALiS SX7 and SX6 have been engineered to project HD-quality color with exceptional accuracy and detail in Adobe RGB and sRGB modes, using a sophisticated Canon color management technology initially developed for printers. REALiS SX7, SX6 and SX60 display expanded color space

using proprietary color filters incorporated in the AISYS optical system. The SX6 filter enables 100% support of sRGB (SX7 requires no filter) and virtually accurate reproduction of Adobe RGB. The SX60 Cinema filter makes it possible to display the original colors of the film before conversion to video.

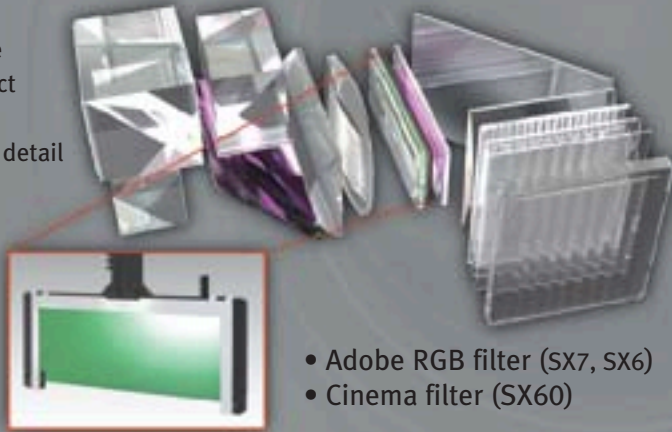

- Adobe RGB filter (SX7, SX6)
- Cinema filter (SX60)

## Home Cinema Mode

The SX60 multimedia projector is equipped with a home cinema filter making it ideal for this application.



## Crisp Blacks Create Rich Shadow Detail

Precise control prevents excess light leakage, producing rich, detailed gradation even in shadowed portions of projected images. And the crisp blacks produced by the LCOS reflective panels create images with realistic depth and dimension.

Conventional Home Use Projector



SX60



## Screen Aspect Modes

Now anyone who owns a 4:3 or 16:9 screen can enjoy the spectacular HD-like quality of Canon’s REALiS projectors by picking the aspect mode to match your screen ratio.

### 16:9 Screen Aspect Mode

4:3 content



Watch 4:3 content on a 16:9 screen

16:9 content



Watch 16:9 content on a 16:9 screen

### 16:9 Digital Image Shift

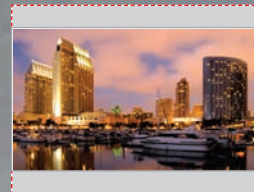

Before Shift

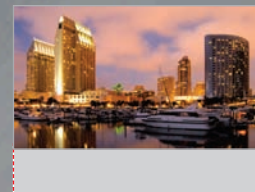

Digital Image Shift UP

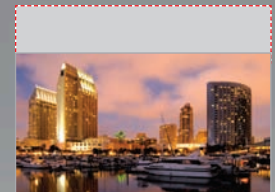

Digital Image Shift DOWN

## Dynamic Gamma

When dynamic gamma is ‘On’ gamma is automatically adjusted to optimum values. When projecting moving images with rapid shifts in brightness, each frame is displayed with optimum contrast balance to prevent washed-out whites and blocked-up blacks.

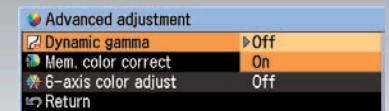

In bright scenes, gamma is adjusted according to the brightness, automatically compensating for washed-out areas and reproducing gradation in the bright sections.

In scenes containing dark areas, gamma is adjusted for the entire image, including dark sections, minimizing blocked-up shadows.





## Image Modes

Select the image mode to suit the characteristics of the content: “Presentation” mode for briefings and conferences, “Adobe RGB” or “sRGB” when color reproduction is critical, etc.

- Standard** Prioritizes reproduction of white, closely matching the image characteristics of the original
- Presentation** Produces a bright, high-contrast display for ease of viewing text and numerical data
- Movie** Suitable for displaying theatrical content; image quality emphasizes gradations in dark areas
- Movie & Photo** For display of video and digital camera images; clearly defines gradations and improves color reproduction
- Adobe RGB**  
**sRGB** Reproduces colors in the appropriate color space for accurate projection of content produced in specific standardized formats
- Home Cinema** Controls brightness while enhancing contrast to a ratio of 2000:1; for display of theatrical content in pitch-dark rooms

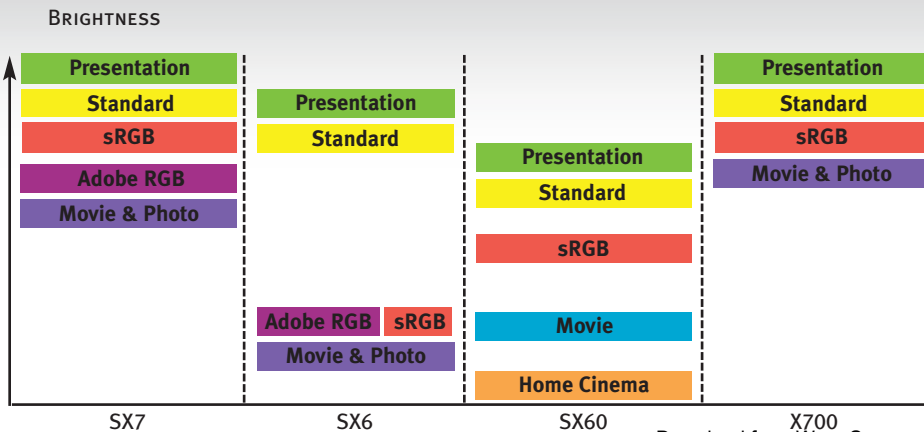

## 6-Axis Color Adjustments

A 6-Axis Color Adjustment function has been incorporated to meet the demands of professionals with demanding color requirements. Both hue and saturation can be adjusted on independent RGB and CMYK color axes.

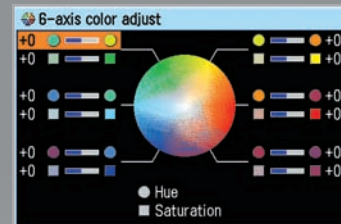

**More orange in the sunset**

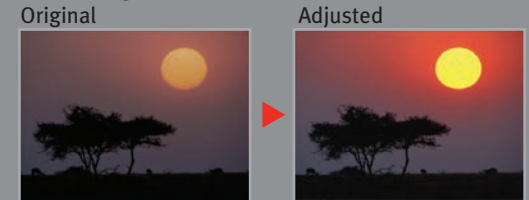

**A bluer sky**

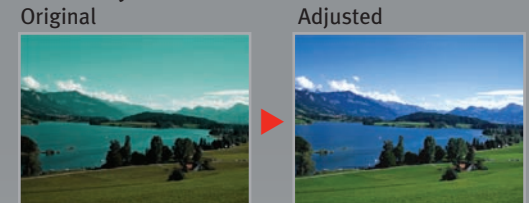

## Adobe RGB Color Match System

A special RGB color filter on the SX7 and SX6 enables virtually accurate Adobe RGB color as well as sRGB, (SX7 requires no filter for sRGB) which is ideal for professional photography, design, publishing and printing.

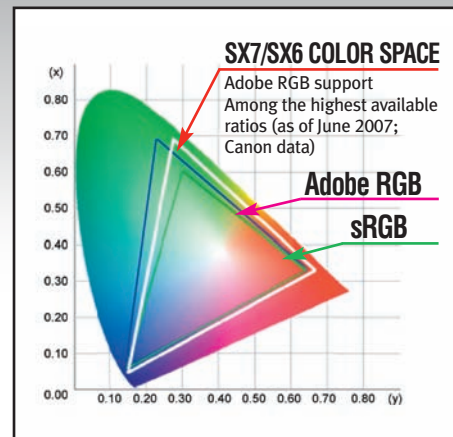

REALiS projectors produce scanless, grid-free images for realistic reproduction of colors and textures in photos.



## Quiet Operation

In a projector, heat is generated by its projection lamp and power-supply circuits. The cooling system required to dissipate this heat is one of the main reasons why projectors tend to be noisy. For all our REALiS models, ventilation vents, cooling fan, and layout of the optical array have been engineered with noise prevention in mind, resulting in exceptionally quiet operation.

- ▶ Vents designed for efficient cooling
- ▶ In-line layout for unobstructed ventilation
- ▶ Large fan operates at lower speed

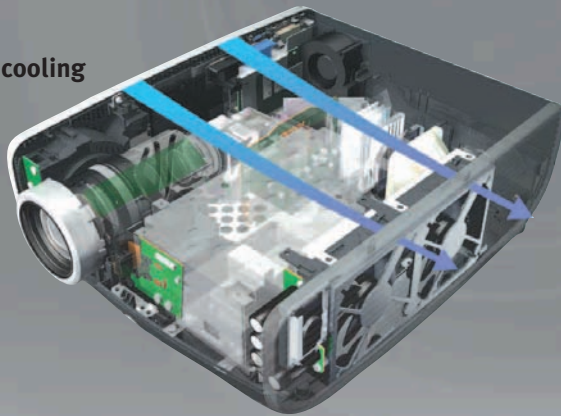

## LED Illumination

LEDs on all REALiS models indicate the projector's connections and operational status at a glance. When several image input devices are connected, a LED indicates which image signal is selected as the input. The LED illumination on the operation panel flashes to indicate start-up, end of presentation, and other user commands.

Input terminals



LED indicates connector responding to image signal.

Operations panel



LEDs flash to indicate/confirm specific operations.

Download from [Www.Somanuals.com](http://Www.Somanuals.com). All Manuals Search And Download.

## Convenient Remote Control functions for sophisticated presentations

### Digital Zoom

Enlarges a selected single area of the screen, such as specific data in a graph; images can be enlarged a maximum of 12x\*.

\* Resolution of the enlarged section is reduced.

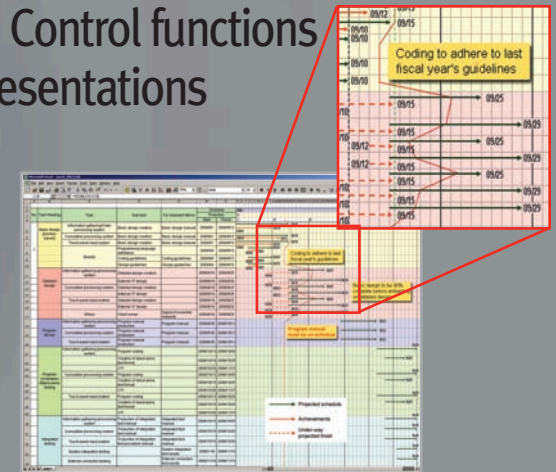

### Spot

Highlights a portion of the image on the screen; the spotlight can be made larger or smaller and moved anywhere on the screen.



### Freeze

Freeze-frame function lets you freeze the on-screen display for pauses in the presentation, such as changing PC connections or checking the subsequent image file.



## Guide Functions

All REALiS models display guide messages in an on-screen window, providing feedback on invalid operations and set-up tips. The same window also introduces auto set-up and Off & Go functions when power is switched on or off.

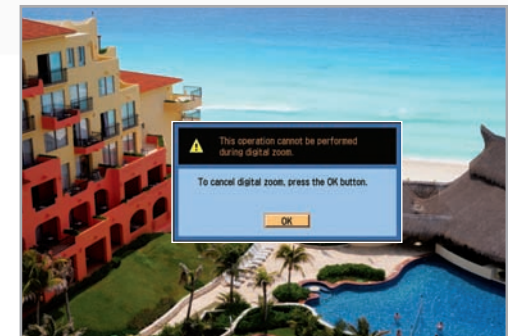

# Canon Throw Distance Chart

## 4:3 Aspect Ratio

SX7, SX6, SX60, X700	40"	80"	100"	150"	200"	300"
Projector Screen Size	40"	80"	100"	150"	200"	300"
Screen Size – horizontally	2'8"	5'4"	6'8"	10'0"	13'4"	20'0"
Projection distance (shortest to longest)	3'11" – 6'5"	7'9" – 12'11"	9'8" – 16'2"	14'7" – 24'4"	19'6" – 29'6"	29'4" – 29'6"

## 16:9 Aspect Ratio

SX7, SX6, SX60, X700	40"	80"	100"	150"	200"	300"
Projector Screen Size	40"	80"	100"	150"	200"	300"
Screen Size – horizontally	2'11"	5'10"	7'3"	10'11"	14'6"	N/A
Projection distance (shortest to longest)	4'2" – 7'0"	8'5" – 14'1"	10'7" – 17'8"	15'11" – 26'6"	21'3" – 29'6"	N/A



For complete Throw Distance information, please visit [www.canonprojectors.com](http://www.canonprojectors.com)

# Network Projector Management

The optional network adapter makes it possible to operate the projector from a networked PC. Multiple projectors can be managed remotely as well. In the event of a malfunction, an alert can be sent to the computer. This feature also makes it possible to operate ceiling-mounted units or other remote installations from a single PC screen.

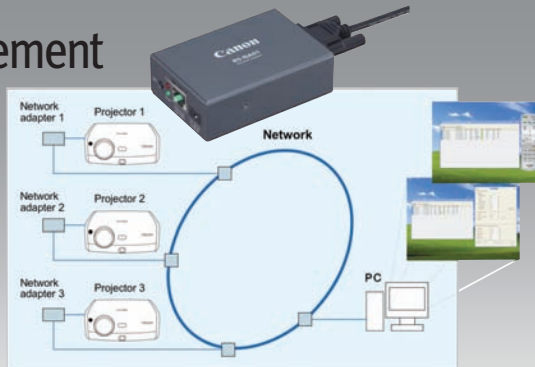

# Kit Contents

Remote Control



USB Cable



Soft Case



Component Video Adapter Cable



Computer Cable (DVI-VGA)



Power Cord



# Unique Website Lets You Compare Quality



Visit "Where Are The Details," [www.usa.canon.com/details](http://www.usa.canon.com/details).

- **COMPARE RESOLUTION:** Compare XGA, SXGA+ and REALiS SXGA+ with LCOS by market, in single frame and side-by-side interactive screens.
- **REALiS TECHNOLOGY:** Discover the many REALiS features with our 360 degree interactive presentation. View specs on each product.
- **WHO NEEDS REALiS?:** A market-specific drop-down menu lets you discover why REALiS is ideal for your particular application.
- **REALiS ADVANTAGE:** Read about and see a video which explains AISYS, Canon's proprietary technology that enhances LCOS technology.

# Optional Accessories

Replacement Lamp



RS-LP04 (SX7, X700)  
RS-LP02 (SX6, X600)  
RS-LP03 (SX60)

Ceiling Mount



RS-CL06 (SX7, SX6, SX60, X700)

Ceiling Plate



RS-CL02

Ceiling Pipe



RS-CL03 (14.17 in.)  
RS-CL04 (21.65 in.)  
RS-CL05 (29.92 in.)

Network Adapter



RS-NA01

RS-232C Cable RS-CA01



# Product Specifications

Product		REALiS SX7	REALiS SX6	REALiS SX60	REALiS X700	
Basics	Imaging Device	0.7" Reflective LCD panels (LCoS) x3				
	Aspect Ratio	4:3				
	Native Resolution	SXGA+	SXGA+	SXGA+	XGA	
	Brightness	4000 ANSI Lumens	3500 ANSI Lumens	2500 ANSI Lumens	4000 ANSI Lumens	
	Uniformity	88%	88%	88%	88%	
	Contrast	1000:1	1000:1	1000:1 2000:1 (Home Cinema Mode)	1000:1	
Keystone	Vertical	+/- 20 degrees (Auto/Manual)				
	Horizontal	+/- 20 degrees (Manual)				
Optics	Projection Lens	F1.85 - 2.5, f=21.7 - 35.8 mm				
	Lens Shift	9:1, Fixed				
	Zoom	1.7x Powered , 12x Digital				
	Focus	Powered (Auto/Manual)				
	Screen Size	40" - 300"				
	Projection Distance Coverage	3.9 - 29.5ft (1.2 - 9m) / 100": 9.8 - 16.1ft (3.0 - 4.9m)				
	Throw Ratio	1.46 – 2.43:1				
Image Adjustments	Color Mode	Adobe RGB, sRGB, Presentation, Standard, Movie & Photo	Adobe RGB, sRGB, Presentation, Standard, Movie & Photo	sRGB, Presentation, Standard, Movie, Home Cinema	sRGB, Presentation, Standard, Movie	
	Color Adjust	Dynamic Gamma, 6-axis (RGBCMY) Color Adjustment				
	Wall Correction	Auto/Manual				
	Mounting Tilt Angle	Ceiling/Rear/Ceiling and Rear Adjusting feet up to 10 degrees				
Input Signals	Analog PC Input	UXGA/SXGA+ WXGA/SXGA/XGA/SVGA/VGA				
	Digital PC Input	SXGA+ WXGA/SXGA/XGA SVGA/VGA				
	Scanning Frequency	H:15 - 100 kHz, V: 50 - 100 Hz, Dot clock: 170 MHz				
	Video/S-Video Input	NTSC/PAL/SECAM/NTSC4.43/PAL-M/PAL-N				
	Component Input	1080i/1035i/720p/575p/480p/575i/480i				
	Digital Video Input	1080i/1035i/720p/575p/480p				
Terminal	Input	DVI-I 29pin	Digital PC input/Analog PC input/Digital Video input			
		D-Sub 15pin	Analog PC input /Component input/SCART input			
		RCA	Video input			
		Mini DIN 4pin	S-Video input			
	Output	Stereo Mini Jack	Stereo audio input x3	Stereo audio input x1	Stereo audio input x1	Stereo audio input x3
		D-sub 15pin	Analog PC output			
		Stereo Mini Jack	Stereo audio input x1	N/A	N/A	Stereo audio input x1
Built-In Speaker	1W (Mono)					
Control Terminal Network	RS-232 YES (Optional Network Adapter)					
Lamp	Type	275W NSH (AC)	270W NSH (DC)	180W NSH (DC)	275W NSH (AC)	
	Lamp Life (Quiet/Normal)	3000/2000 Hours	2000/1500 Hours	4000/2500 Hours	3000/2000 Hours	
Remote Control	Sensor	Wireless Infrared, Front/Back				
	Mouse Control	USB				
Ratings	Fan Noise (Normal/Quiet)	35/31dB	35/31dB	30/27dB	35/31dB	
	Power	Consumption (Normal/Stand-by)	360W/290W/7W	355W/290W/7W	250W/225W/7W	360W/290W/7W
		Voltage	AC 100 to 240V, 50/60Hz			
	Temperature	Operating	41 to 95 F (5 to 35 C)			
		Storage	104 to -22 F (60 to -30 C), 5%RH ~ 90%RH			
	Dimensions (W x D x H)	10.5 x 13.2 x 4.5 in. (266 x 336 x 114 mm)				
	Weight	10.6 lbs (4.8 kg)	10.4 lbs (4.7 kg)	10.1 lbs (4.6 kg)	10.6 lbs (4.8 kg)	

## TRIPLE P PROGRAM



Canon's Projector Protection Program, also known as "Triple P," is a service program that provides a loaner projector of equal or greater quality in the event that your projector needs to be repaired.

- Free to any buyer within their first year of new product warranty
- Canon Customer Support Center toll free hotline: 1-800-828-4040
- Customer Service Hours: 8 a.m. to Midnight, Monday to Friday  
10 a.m. to 8 p.m., Saturday
- For next business day delivery of loaner, Customer Activation Form must be received by Canon Customer Support Center by 3 p.m. EST (Monday to Friday)
- Customer must provide a valid credit card as security for the loaner unit
- Delivery not available on Saturday and Sunday
- Program available for products purchased and utilized in the U.S.A. only
- Applies to Canon SXGA+ and XGA resolution products only
- Loaner unit based on availability
- Program subject to change at any time without any given notice

**1-800-OK-CANON**

[www.canonprojectors.com](http://www.canonprojectors.com)

Canon U.S.A., Inc.  
One Canon Plaza  
Lake Success, NY 11042, U.S.A.

Canon Canada Inc.  
6390 Dixie Road, Mississauga  
Ontario L5T 1P7 Canada

Canon Mexicana, S. DE R.L. DE C.V.  
Blvd. M. A. Camacho No. 138, Piso PB  
15, 16 y 17, Col. Lomas de Chapultepec,  
C.P. 11000 México, D.F. México

Canon Latin America, Inc.  
703 Waterford Way, Suite 400  
Miami, FL 33126, U.S.A.

\*Systems Contractor News, October 2005 in Realis SX50 review.

Errors and omissions excepted. Weight and dimensions are approximate. Specifications subject to change without notice. Projected images simulated.

**Canon**  
image*ANYWARE*

©2007 Canon U.S.A., Inc. All rights reserved. Canon and REALiS are registered trademarks of Canon Inc. in the United States and may also be a registered trademark or trademarks in other countries. IMAGE*ANYWARE* is a trademark of Canon. Projection images simulated.

## Free Manuals Download Website

<http://myh66.com>

<http://usermanuals.us>

<http://www.somanuals.com>

<http://www.4manuals.cc>

<http://www.manual-lib.com>

<http://www.404manual.com>

<http://www.luxmanual.com>

<http://aubethermostatmanual.com>

Golf course search by state

<http://golfingnear.com>

Email search by domain

<http://emailbydomain.com>

Auto manuals search

<http://auto.somanuals.com>

TV manuals search

<http://tv.somanuals.com>