

Canon

MULTIMEDIA PROJECTOR

LV-7255

User's Manual



E
English

Important Information

Safety Cautions

Precautions

Please read this manual carefully before using your Canon LV-7255 projector and keep the manual handy for future reference. Your serial number is located on the bottom of your projector. Record it here:

CAUTION



To turn off main power, be sure to remove the plug from power outlet.
The power outlet socket should be installed as near to the equipment as possible, and should be easily accessible.

CAUTION



TO PREVENT SHOCK, DO NOT OPEN THE CABINET.
NO USER-SERVICEABLE PARTS INSIDE.
REFER SERVICING TO QUALIFIED SERVICE PERSONNEL.



This symbol warns the user that uninsulated voltage within the unit may be sufficient to cause electrical shock. Therefore, it is dangerous to make any kind of contact with any part inside of the unit.



This symbol alerts the user that important information concerning the operation and maintenance of this unit has been provided.
The information should be read carefully to avoid problems.

WARNING: TO PREVENT FIRE OR SHOCK, DO NOT EXPOSE THIS UNIT TO RAIN OR MOISTURE.
DO NOT USE THIS UNIT'S PLUG WITH AN EXTENSION CORD OR IN AN OUTLET UNLESS ALL THE PRONGS CAN BE FULLY INSERTED.
DO NOT OPEN THE CABINET. THERE ARE HIGH-VOLTAGE COMPONENTS INSIDE. ALL SERVICING MUST BE DONE BY QUALIFIED SERVICE PERSONNEL.

Acoustic Noise Information Ordinance-3. GSGV (for Germany only):

The sound pressure level is less than 70 dB (A) according to ISO 3744 or ISO 7779.

CAUTION



Avoid displaying stationary images for a prolonged period of time.
Doing so can result in these images being temporarily sustained on the surface of the LCD panel.
If this should happen, continue to use your projector. The static background from previous images will disappear.

CAUTION



Do not put the projector on its side when the lamp is turned on.
Doing so may cause damage to the projector.

WARNING TO CALIFORNIA RESIDENTS:

Handling the cables supplied with this product, will expose you to lead, a chemical known to the State of California to cause birth defects or other reproductive harm. Wash hands after handling.

NOTE FOR CUSTOMERS IN THE US

(Hg) LAMP(S) INSIDE THIS PRODUCT CONTAIN MERCURY AND MUST BE RE-CYCLED OR DISPOSED OF ACCORDING TO LOCAL, STATE OR FEDERAL LAWS.

Federal Communication Commission Notice

Multimedia Projector, Model : LV-7255

This device complies with Part 15 of the FCC Rules. Operation is subject to the following two conditions:

(1) This device may not cause harmful interference, and (2) this device must accept any interference received, including interference that may cause undesired operation.

Note : This equipment has been tested and found to comply with the limits for a Class B digital device, pursuant to part 15 of the FCC Rules. These limits are designed to provide reasonable protection against harmful interference in a residential installation. This equipment generates, uses and can radiate radio frequency energy and, if not installed and used in accordance with the instructions, may cause harmful interference to radio communications. However, there is no guarantee that interference will not occur in a particular installation. If this equipment does cause harmful interference to radio or television reception, which can be determined by turning the equipment off and on, the user is encouraged to try to correct the interference by one or more of the following measures :

- Reorient or relocate the receiving antenna.
- Increase the separation between the equipment and receiver.
- Connect the equipment into an outlet on a circuit different from that to which the receiver is connected.
- Consult the dealer or an experienced radio/TV technician for help.

The cable with the ferrite core provided with the projector must be used with this equipment in order to comply with Class B limits in Subpart B of Part 15 of the FCC rules.

Use of shielded cable is required to comply with class B limits in Subpart B of Part 15 of FCC Rules. Do not make any changes or modifications to the equipment unless otherwise specified in the instructions. If such changes or modifications should be made, you could be required to stop operation of the equipment.

Canon U.S.A., Inc.
One Canon Plaza, Lake Success, NY 11042, U.S.A.
Tel No. (516)328-5600

Canadian Radio Interference Regulations

This Class B digital apparatus complies with Canadian ICES-003.

Réglementation canadienne sur les interférences radio

Cet appareil numérique de la classe B est conforme à la norme NMB-003 du Canada.



European Union (and EEA) only.

This symbol indicates that this product is not to be disposed of with your household waste, according to the WEEE Directive (2002/96/EC) and your national law. This product should be handed over to a designated collection point, e.g., on an authorized one-for-one basis when you buy a new similar product or to an authorized collection site for recycling waste electrical and electronic equipment (EEE). Improper handling of this type of waste could have a possible negative impact on the environment and human health due to potentially hazardous substances that are generally associated with EEE. At the same time, your cooperation in the correct disposal of this product will contribute to the effective usage of natural resources. For more information about where you can drop off your waste equipment for recycling, please contact your local city office, waste authority, approved WEEE scheme or your household waste disposal service.

Your cooperation in the correct disposal of this product will contribute to the effective usage of natural resources and will avoid incurring administrative sanctions according to art. 50 and following of Italian legislative decree 22/97.

For more information regarding return and recycling of WEEE products, please visit

www.canon-europe.com/environment.

(EEA: Norway, Iceland and Liechtenstein)



LAMP HANDLING PRECAUTIONS

This projector uses a high-pressure mercury lamp which must be handled carefully and properly as mentioned below.

- A lamp may explode with a loud sound or burn out due to a shock, scratch, or expiration of lifetime.
- The lamp life may differ from lamp to lamp and according to the environment of use. There is not guarantee of the same lifetime for each lamp. Some lamps may fail or terminate their life in a shorter period of time than other similar lamps.
- A lamp gradually becomes darker with time of use.
- If the projector indicates that the lamp should be replaced (i.e., the LAMP indicator blinks red rapidly), chances of explosion become higher. Replace the lamp with a new one immediately.
- Always keep your face away from the exhaust vent so that you do not suffer from the gas and broken shards of the lamp.



IF A LAMP EXPLODES

If a lamp explodes, the gas and broken shards may scatter inside the projector and they may come out of the exhaust vent. The gas contains toxic mercury.

Open windows and doors for ventilation.

If you inhale the gas or the shards of the broken lamp enter your eyes or mouth, consult the doctor immediately.

If a lamp explodes, its shards may scatter inside the projector. Ask the Canon service representative to clean and check the inside of the projector and replace the lamp.



DISPOSAL OF WASTE LAMP

Dispose of the mercury lamp of the projector according to the local regulation just like the fluorescent lamp.

Lamp Replacement

- To replace the lamp, follow all instructions provided on page 50.
- Be sure to replace the lamp when the message [**Replace with the new lamp.**] appears. If you continue to use the lamp after the lamp has reached the end of its usable life, the lamp bulb may shatter, and pieces of glass may be scattered in the lamp case. Do not touch them as the pieces of glass may cause injury. If this happens, contact your dealer for lamp replacement.



CAUTION

When removing the lamp from a ceiling-mounted projector, make sure that no one is under the projector. Glass fragments could fall if the lamp has been burned out.

For UK only: In UK, a BS approved power cord with moulded plug has a Black (five Amps) fuse installed for use with this equipment. If a power cord is not supplied with this equipment please contact your supplier.

Important Safeguards

These safety instructions are to ensure the long life of your projector and to prevent fire and shock. Please read them carefully and heed all warnings.

Installation

- Do not place the projector in the following conditions:
 - on an unstable cart, stand, or table.
 - near water, baths or damp rooms.
 - in direct sunlight, near heaters or heat radiating appliances.
 - in a dusty, smoky or steamy environment.
 - on a sheet of paper or cloth, rugs or carpets.
- If you wish to have the projector installed on the ceiling:
 - Do not attempt to install the projector yourself.
 - The projector must be installed by qualified technicians in order to ensure proper operation and reduce the risk of bodily injury.
 - In addition, the ceiling must be strong enough to support the projector and the installation must be in accordance with any local building codes.
 - Please consult your dealer for more information.

Do Not Use in the Following Environments

Do not install the projector in a humid or dusty place or a place where there is much oily smoke or cigarette smoke. Optical parts such as a lens and mirror are stained, resulting in poor picture.

Do not use the projector in a place where the temperature becomes very high or low.

Operating temperature: +5°C to +35°C Storage temperature: -10°C to +50°C

Place the projector in a horizontal position

The tilt angle of the projector should not exceed 10 degrees, nor should the projector be installed in any way other than the desktop and ceiling mount, otherwise lamp life could decrease dramatically.



Fire and Shock Precautions

- Ensure that there is sufficient ventilation and that vents are unobstructed to prevent the build-up of heat inside projector. Allow at least 1 m (3.3') of space between your projector and a wall.
- Do not try to touch the ventilation outlet on the left front (when seen from the front) as it can become heated the projector is turned on and immediately after the projector is turned off.
- Prevent foreign objects such as paper clips and bits of paper from falling into your projector. Do not attempt retrieve any objects that might fall into your projector. Do not insert any metal objects such as a wire or screwdriver into your project. If something should fall into your projector, disconnect it immediately and have the object removed by a qualified service personnel.
- Do not place any objects on top of the projector.
- Do not touch the power plug during a thunderstorm. Doing so can cause electrical shock or fire.
- The projector is designed to operate on a power supply of 100-240V AC 50/60 Hz. Ensure that your power fits this requirement before attempting to use your projector.

- Do not look into the lens while the projector is on. Serious damage to your eyes could result.
- Keep any items such as magnifying glass out of the light path of the projector. The light being projected from the lens is extensive, therefore any kind of abnormal objects that can redirect light coming out of the lens, can cause unpredictable outcome such as fire or injury to the eyes.
- Do not cover the lens with the black lens cap or equivalent while the projector is on. Doing so can lead to melting the cap and possibly burning your hands due to the heat emitted from the light output.
- Do not place any objects, which are easily affected by heat, in front of the projector lens or a projector exhaust. Doing so could lead to the object melting or getting your hands burned from the heat that is emitted from the output and exhaust.
- Handle the power cable carefully. A damaged or frayed power cable can cause electric shock or fire.
 - Do not use any power cables than the supplied one.
 - Do not bend or tug the power cable excessively.
 - Do not place the power cable under the projector, or any heavy object.
 - Do not cover the power cable with other soft materials such as rugs.
 - Do not heat the power cable
 - Do not handle the power plug with wet hands.
- Turn off the projector, unplug the power cable and have the object removed by a qualified service personnel under the following conditions:
 - When the power cable or plug is damaged or frayed.
 - If liquid has been spilled into the projector, or if it has been exposed to rain or water.
 - If the projector does not operate normally when you follow the instructions described in this user's manual.
 - If the projector has been dropped or the cabinet has been damaged.
 - If the projector exhibits a distinct change in performance, indicating a need for service.
 - If the projector is not to be used for an extended period of time.
- Disconnect the power cable and any other cables before carrying the projector
- Turn off the projector and unplug the power cable before cleaning the cabinet or replacing the lamp.

CAUTION

- Do not try to touch the ventilation outlet on the left side (when seen from the front) as it can become heated while the projector is turned on.
- Do not use the tilt-foot for purposes other than originally intended. Misuses such as gripping the tilt-foot or hanging on the wall can cause damage to the projector.
- Select [High] in Fan mode if you continue to use the projector for consecutive days. (From the menu, select [Advanced settings] → [Fan mode] → [High].) Fan noise increases noticeably in High mode.
- Select [High] in Fan mode if you use the projector at a high altitude or under low atmospheric pressure.
- Do not unplug the power cord from the wall outlet under any one of the following circumstances. Doing so can cause damage to the projector:
 - * While the Hour Glass icon appears.
 - * While the cooling fans are running. (The cooling fans continue to work for 30 seconds after the projector is turned off).
 - * While the lamp is lighted.

CARRYING/TRANSPORTING THE PROJECTOR

This projector is a precision machine. Do not give a strong shock to the projector or turn it down. Thoroughly read "Use Caution When Carrying or Transporting the Projector" below and install the lens cap before carrying the projector. When transporting the projector by train or airplane, use a highly crashworthy transport case.

Use Caution When Carrying or Transporting the Projector

The carrying bag is intended for protection from dust and scratches on the surface of the cabinet, and it is not designed to protect the projector from external shocks. When carrying the projector with it put in the carrying bag, do not give a shock to it, drop it, or place anything on it.

Do not transport the projector through a courier or transport service with the carrying bag. The projector can damage.



Remote Control Precautions

- Handle the remote control carefully.
- If the remote control gets wet, wipe it dry immediately.
- Avoid excessive heat and humidity.
- Do not heat, take apart, or throw batteries into fire.
- If you will not be using the remote control for a long time, remove the batteries.
- Ensure that you have the batteries' polarity (+/-) aligned correctly.
- Do not use new and old batteries together, or use different types of batteries together.
- Dispose of used batteries according to your local regulations.

Table of Contents

Important Information	i
1. Introduction	1
① What's in the Box?	1
② Introduction to the Projector	2
③ Part Names of the Projector	4
Top Features	6
Terminal Panel Features	7
④ Part Names of the Remote Control	8
Battery Installation	10
Remote Control Precautions	10
Operating Range for Wireless Remote Control	10
2. Installation and Connections	11
① Setting Up the Screen and the Projector	12
Selecting a Location	12
Throw Distance and Screen Size	12
② Making Connections	14
Enabling the computer's external display	14
Connecting Your PC or Macintosh Computer	14
To connect Scart output (RGB)	15
Connecting an External Monitor	16
Connecting Your DVD Player with Component Output	17
Connecting Your VCR or Laser Disc Player	18
Connecting the Supplied Power Cord	19
3. Projecting an Image (Basic Operation)	20
① Turning on the Projector	20
Note on Startup Screen (Menu Language Select screen)	21
② Selecting a Source	22
③ Adjusting the Picture Size and Position	23
④ Correcting Keystone Distortion	25
⑤ Automatically Optimizing on RGB Image	27
⑥ Turning Up or Down Volume	27
⑦ Turning off the Projector	28
⑧ After Use	28

4. Convenient Features	29
1 Turning Off the Image and Sound	29
2 Freezing a Picture	29
3 Enlarging and Moving a Picture	29
4 Using the Remote Mouse Receiver	30
5 Preventing the Unauthorized Use of the Projector	32
5. Using On-Screen Menu	34
1 Using the Menus	34
2 Menu Elements	36
3 List of Menu Items	37
4 Menu Descriptions & Functions [Image adjustment]	39
5 Menu Descriptions & Functions [Display settings]	41
6 Menu Descriptions & Functions [Setup]	42
7 Menu Descriptions & Functions [Advanced settings]	44
8 Menu Descriptions & Functions [Information]	46
9 Menu Descriptions & Functions [Factory default]	47
6. Maintenance	48
1 Cleaning or Replacing the Filter	48
2 Cleaning the Cabinet and the Lens	49
3 Replacing the Lamp	50
7. Appendix	53
1 Troubleshooting	53
2 Specifications	56
3 Cabinet Dimensions	58
4 Pin Assignments of D-Sub ANALOG Input Connector	59
5 Compatible Input Signal List	60
6 Relationship between Screen Size and Projection Distance	61
7 PC Control Codes and Cable Connection	62
8 Troubleshooting Check List	63

1. Introduction

① What's in the Box?

Make sure your box contains everything listed. If any pieces are missing, contact your dealer. Please save the original box and packing materials if you ever need to ship your projector.

Projector

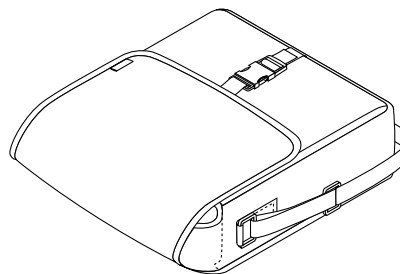
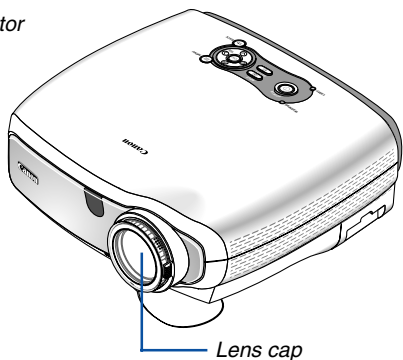

Soft case

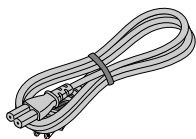

AC power cord
(4.5 m / 14.8')

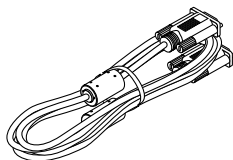

VGA cable
(1.8 m / 5.9')
[7N520052]

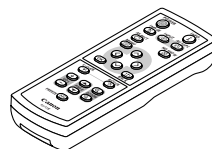

Remote control

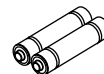

Batteries (AAA × 2)

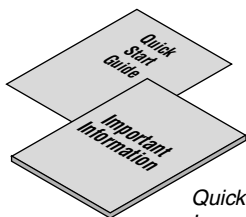

Quick Start Guide
Important Information

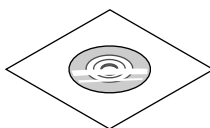

CD-ROM
User's manual

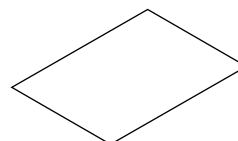

Warranty

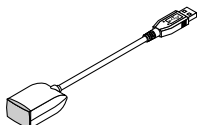

Remote mouse receiver
(10 cm / 0.3')
[7N900562]

2 Introduction to the Projector

This section introduces you to your new projector and describes the features and controls.

Congratulations on Your Purchase of The Projector

The LV-7255 is one of the very best projectors available today. The projector enables you to project precise images up to 300 inches across (measured diagonally) from your PC or Macintosh computer (desktop or notebook), VCR, DVD player, document camera, or a laser disc player.

You can use the projector on a tabletop or cart, from behind a screen, or permanently mounted on a ceiling*¹. The remote control can be used wirelessly.

*¹ Do not attempt to mount the projector on a ceiling yourself.

The projector must be installed by qualified technicians in order to ensure proper operation and reduce the risk of bodily injury.

In addition, the ceiling must be strong enough to support the projector and the installation must be in accordance with any local building codes. Please consult your dealer for more information.

Features you'll enjoy:

- Auto vertical keystone correction
- Built-in Screen color presets provide for adaptive color correction when projecting onto non-white screen material
- Quick Start & Quick Shutoff
The quick start & quick shutoff function means you can set up or put away the projector without delay. Nine seconds after turning on the power, the projector is ready to display PC or video images. When you're finished, the fans stop in 30 seconds after turning off the power, so you can put away the projector quickly after the conference or class.
- Low level operation noise
- Short focal length lens
- 200W lamp (150W Quiet mode)
- Direct keys for source selection
- New Color Management system
- New menu design improves operation
- Safety protect by Password function
Password feature prevents the projector from being used by unauthorized individuals. Password prevents unauthorized individuals from changing projector settings or adjustments.
- You can use the supplied wireless remote control and remote mouse receiver to operate your PC mouse wireless from across the room. The remote mouse receiver supports almost any PC using a USB connection.
- You can control the projector with a PC or control system using the PC Control port.
- The contemporary cabinet design is light, compact, easy to carry, and complements any office, boardroom or auditorium.

About this user's manual

The fastest way to get started is to take your time and do everything right the first time. Take a few minutes now to review the user's manual. This may save you time later on. At the beginning of each section of the manual you'll find an overview. If the section doesn't apply, you can skip it.

- IBM is a trademark or registered trademark of International Business Machines Corporation.
- Mac and PowerBook are trademarks of Apple Computer, Inc., registered in the U.S. and other countries.
- Windows, Windows 98, Windows Me, Windows XP or Windows 2000 are trademarks or registered trademarks of Microsoft Corporation.
- Other product and company names mentioned in this user's manual may be the trademarks or registered trademarks of their respective holders.

3 Part Names of the Projector

Front/Top

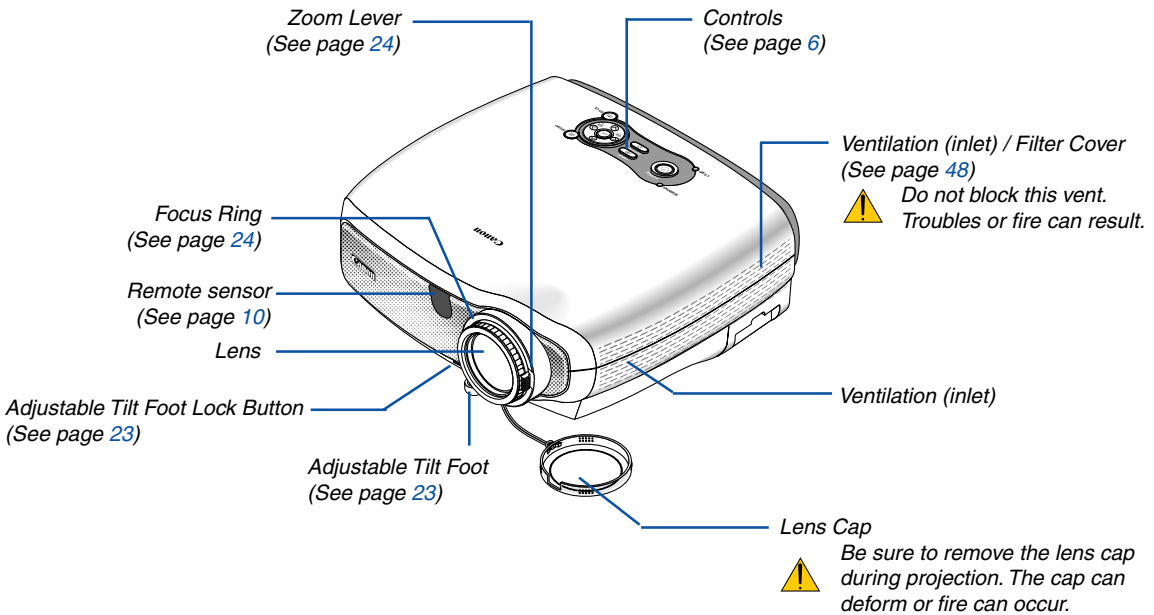

* This security slot supports the MicroSaver® Security System. MicroSaver® is a registered trademark of Kensington Microware Inc. The logo is trademarked and owned by Kensington Microware Inc.

Rear

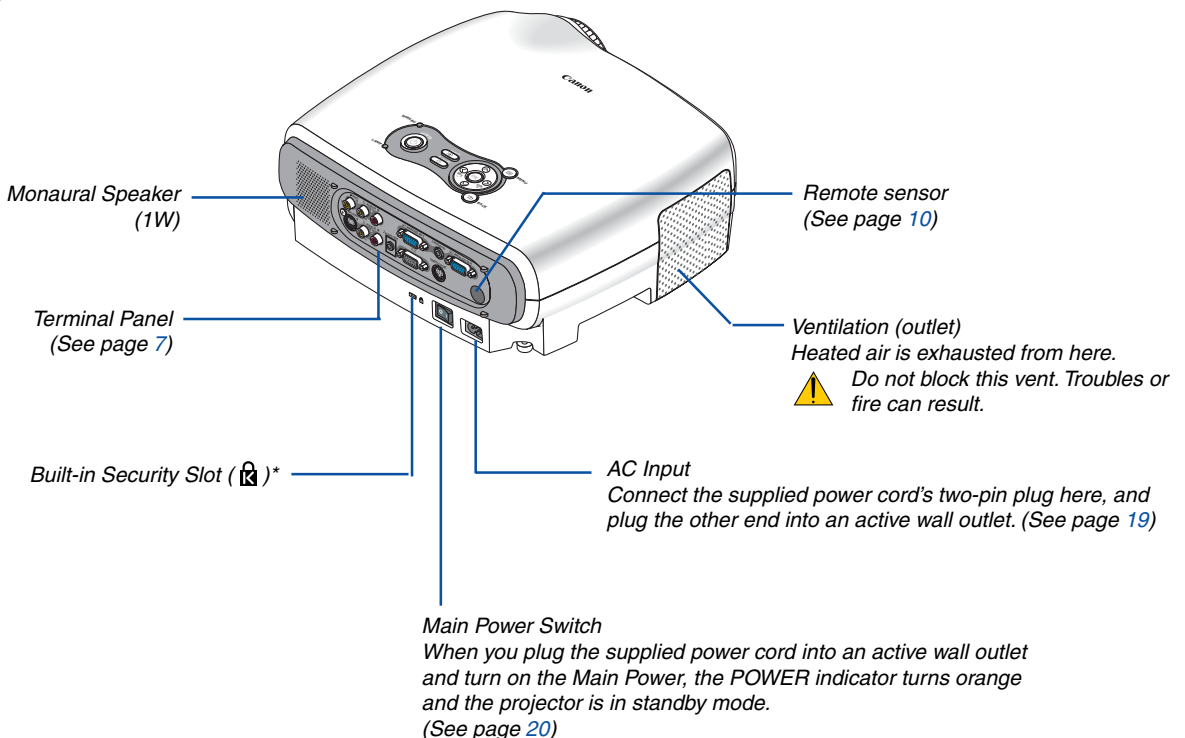

Bottom

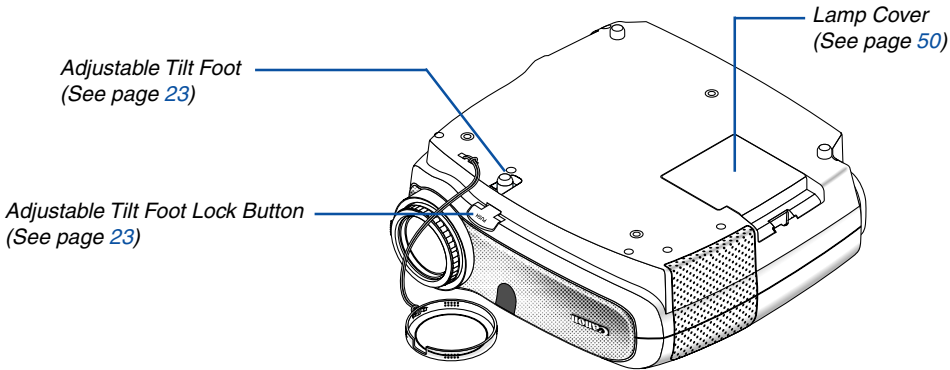

NOTE: A spacer is attached to the rear foot at the factory. To fine-adjust the height of the rear foot, remove the spacer and rotate the rear foot to the desired height. Do not throw away or lose the spacer.

HINT: The Canon logo is on the panel of the projector cabinet. When projecting an image with the projector hung from the ceiling, turn the Canon logo upside down.

To turn the logo upside down, follow the steps below.

1. Push one end of the logo gently.

The other end will pop up slightly.

- The right drawing shows the part "C" is pressed gently.
- The part "n" on the other end will pop up.

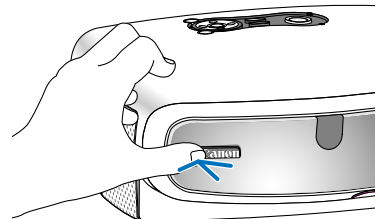

2. Push and hold the end of the logo gently and rotate the logo by holding the other end.

- The right drawing shows that with the part "C" pressed the logo is rotated by holding the part "n" on the other end.

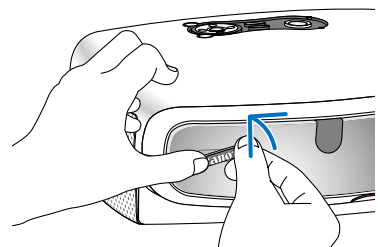

3. Release your hold and turn the logo upside down.

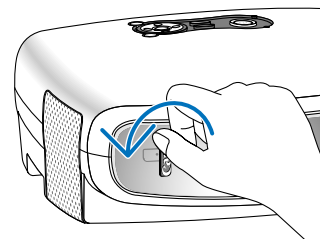

Top Features

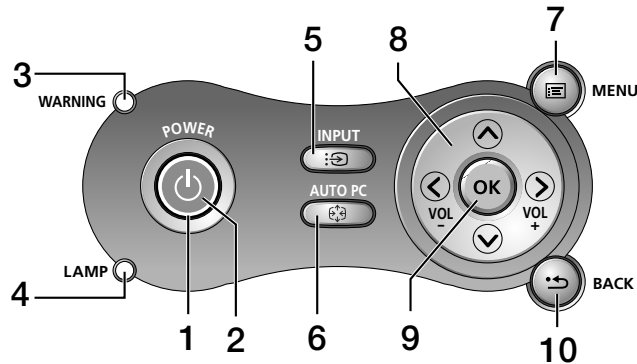

1. POWER Button ()

Use this button to turn the power on and off when the main power is supplied and the projector is in standby mode.

To turn on the projector, press and hold this button for about 1 second. To turn off the projector, press this button twice.

2. POWER Indicator

When this indicator is green, the projector is on; when this indicator is orange, it is in standby mode. See the Power Indicator section on page 53 for more details.

3. WARNING Indicator

If this light blinks red rapidly, it indicates that an error has occurred, the lamp cover is not attached properly or the projector has overheated. If this light remains orange, it indicates that you have pressed a cabinet key while the Key lock is enabled. See the WARNING Indicator section on page 53 for more details.

4. LAMP Indicator

If this light blinks red rapidly, it's warning you that the lamp has reached the end of its usable life. After this light appears, replace the lamp as soon as possible (See page 50). If this is lit green continually, it indicates that the lamp mode is set to Quiet. See the Lamp Indicator section on page 53 for more details.

5. INPUT Button

Selecting from INPUT List

Press and quickly release the INPUT button to display the INPUT list. Each time the INPUT button is pressed, the input source will change as follows: "Computer 1", "Computer 2", "Video" (VCR or laser disc player), "S-Video". To display the selected source, press the OK button or allow 2 seconds to elapse.

Detecting the Signal Automatically

Press and hold the INPUT button for a minimum of 2 seconds, the projector will search for the next available input source. Each time you press and hold the INPUT button for a minimum of 2 seconds, the input source will change as follows:

Computer 1 → Computer 2 → Video → S-Video → Computer1 → ...

6. AUTO PC Button

Use this button to adjust an RGB source for an optimal picture (See page 27).

7. MENU Button

Displays the menu.

8. SELECT () / VOL (+/-) Buttons

() : Use these buttons to select the menu of the item you wish to adjust.

() : Use these buttons to change the level of a selected menu item. A press of the () button executes the selection. When no menus appear, these buttons work as a volume control.

9. OK Button

Executes your menu selection and activates items selected from the menu.

10. BACK Button

Pressing this button will return to the previous menu. While you are in the main menu, pressing this button will close the menu.

Terminal Panel Features

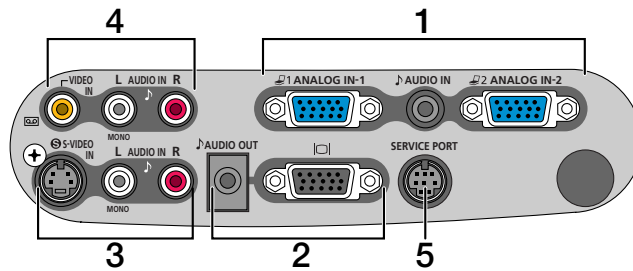

1. ANALOG IN-1 and -2 / Component Input Connector (Mini D-Sub 15 Pin)

Connect your computer or other analog RGB equipment such as IBM compatible or Macintosh computers. Use the supplied RGB cable to connect to your computer. This also serves as a component input connector that allows you to connect a component video output of component equipment such as a DVD player. This connector also supports Scart output signal. See page 15 for more details.

AUDIO IN Mini Jack (Stereo Mini)

This is where you connect the audio output from your computer or DVD player when connected to the COMPUTER input. A commercially available audio cable is required.

2. MONITOR OUT Connector (Mini D-Sub 15 Pin)

You can use this connector to loop your computer image to an external monitor from the RGB input source.

This connector outputs RGB signal in standby mode.

AUDIO OUT Mini Jack (Stereo Mini)

You can use this jack to output sound from the currently selected source (COMPUTER, VIDEO or S-VIDEO). Output sound level can be adjusted in accordance with the sound level of the internal speaker.

Note that this cannot be used as a headphone jack.

(When audio equipment is connected, the projector speaker is disabled.)

When a cable mini-plug is inserted into this jack, both the right and left audio signals are not mixed, but separate.

For example, when a cable mini-plug is inserted into the left AUDIO IN jack only, only left sound is output.

3. S-VIDEO IN Connector (Mini DIN 4 Pin)

Here is where you connect the S-Video input from an external source like a VCR.

NOTE: S-Video provides more vivid color and higher resolution than the traditional composite video format.

S-VIDEO AUDIO Input Jacks L/R (RCA)

These are your left and right channel audio inputs for stereo sound from an S-Video source.

4. VIDEO IN Connector (RCA)

Connect a VCR, DVD player, laser disc player, or document camera here to project video.

VIDEO AUDIO Input Jacks L/R (RCA)

These are your left and right channel audio inputs for stereo sound from a Video source.

5. SERVICE PORT (Mini DIN 8 Pin)

Use this port to connect a PC or control system to control the projector via an optional RS-232C serial cable (LV-CA34). If you are writing your own program, typical PC control codes are on page 62.

4 Part Names of the Remote Control

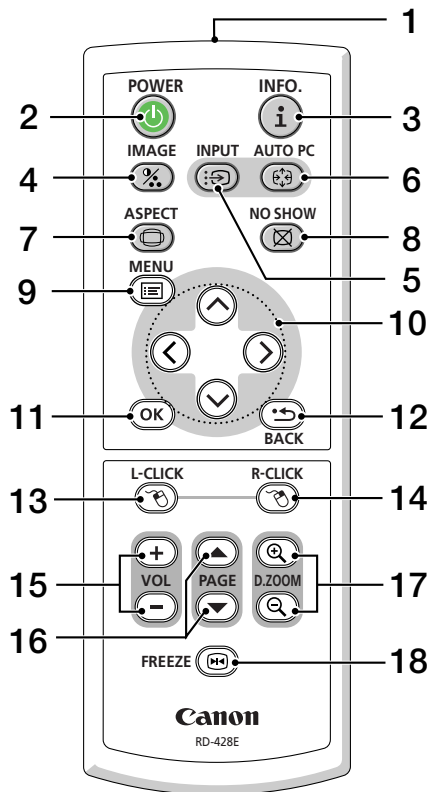

5. INPUT Button

Selecting from INPUT List

Press and quickly release the INPUT button to display the INPUT list. Each time the INPUT button is pressed, the input source will change as follows: "Computer 1", "Computer 2", "Video" (VCR or laser disc player), "S-Video". To display the selected source, press the OK button or allow 2 seconds to elapse.

Detecting the Signal Automatically

Press and hold the INPUT button for a minimum of 2 seconds, the projector will search for the next available input source. Each time you press and hold the INPUT button for a minimum of 2 seconds, the input source will change as follows:

Computer 1 → Computer 2 → Video → S-Video → Computer1 → ...

6. AUTO PC Button

Use this button to adjust an RGB source for an optimal picture.

See page 27.

7. ASPECT Button

Press this button once to display the Aspect select menu. Keep pressing will change aspect ratios. See page 41.

8. NO SHOW Button

This button turns off the image and sound for a short period of time. Press again to restore the image and sound.

9. MENU Button

Displays the menu for various settings and adjustments.

10. SELECT (Mouse) Button

⊙⊙: Use these buttons to select the menu of the item you wish to adjust.

⊙⊙: Use these buttons to change the level of a selected menu item. A press of the ⊙ button executes the selection.

When an image is magnified, the SELECT ⊙⊙⊙⊙ button moves the image. See page 29.

This button also works as a computer mouse when the supplied remote mouse receiver is connected with your computer. See page 31.

1. Infrared Transmitter

Direct the remote control toward the remote sensor on the projector cabinet.

2. POWER Button

When the main power is on, you can use this button to turn your projector on.

NOTE: To turn on the projector, press and hold the POWER button for about 1 second.

You can use this button to turn your projector off.

NOTE: To turn off the projector, press this button twice.

3. INFO. Button

Provides the information on the current signal and projector settings. See page 46.

4. IMAGE Button

Press this button to display the Image adjustment menu to adjust Screen color, Image mode, Brightness, Contrast, Sharpness, Color and Color balance. See pages 39 to 40.

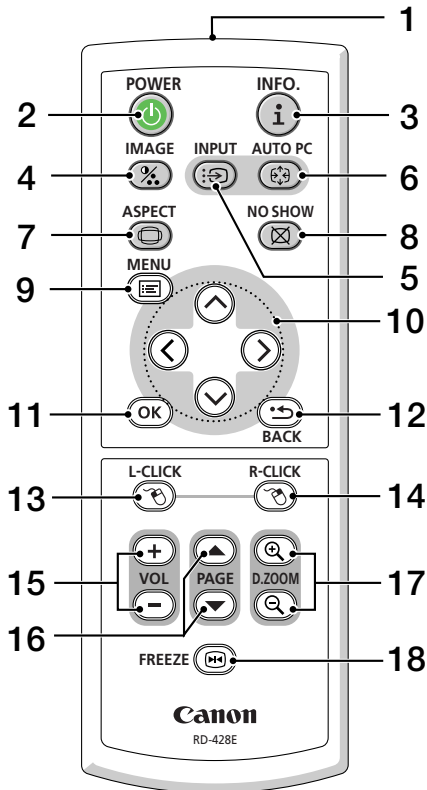

16. PAGE ▲/▼ Button

Use these buttons to operate your computer with the supplied remote mouse receiver. See page 31. You can use these buttons to scroll the viewing area of the window or to move to the previous or next slide in PowerPoint on your computer.

17. D. ZOOM (+) (-) Button

Use this button to adjust the image size up to 400%. The image is magnified about the center of the screen. See page 29.

18. FREEZE Button

This button will freeze a picture. Press again to resume motion. See page 29.

11. OK Button

Use this button to enter your menu selection. It works the same way as the OK button on the cabinet. See page 6.

12. BACK Button

It works the same way as the BACK button on the cabinet. See page 6.

13. L-CLICK Button

This button works as the mouse left button when the supplied remote mouse receiver is connected with your computer. See page 31.

14. R-CLICK Button

This button works as the mouse right button when the supplied remote mouse receiver is connected with your computer. See page 31.

15. VOL (+) (-) Button

Press (+) to increase the volume and (-) to decrease it.

Battery Installation

1 Press firmly and slide the battery cover off.

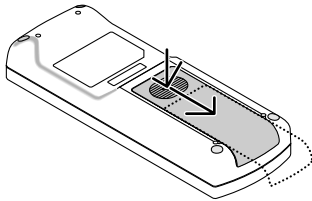

2 Remove both old batteries and install new ones (AAA). Ensure that you have the batteries' polarity (+/-) aligned correctly.

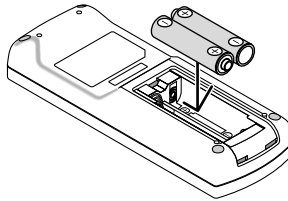

3 Slip the cover back over the batteries until it snaps into place. Do not mix different types of batteries or new and old batteries.

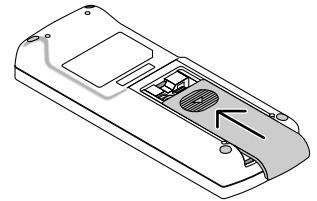
**Remote Control Precautions**

- Handle the remote control carefully.
- If the remote control gets wet, wipe it dry immediately.
- Avoid excessive heat and humidity.
- Do not heat, take apart, or throw batteries into fire.
- Ensure that you have the batteries' polarity (+/-) aligned correctly.
- If you will not be using the remote control for a long time, remove the batteries.
- Do not place the batteries upside down.
- Do not use new and old batteries together, or use different types of batteries together.
- Dispose of used batteries according to your local regulations.

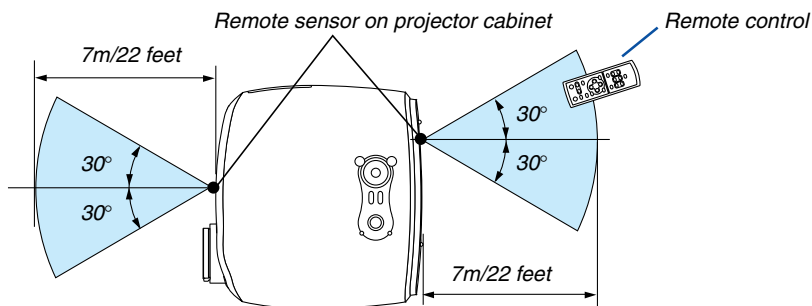
Operating Range for Wireless Remote Control

- The infrared signal operates by line-of-sight up to a distance of about 7 m (22 feet) and within a 60-degree angle of the remote sensor on the projector cabinet.
- The projector will not respond if there are objects between the remote control and the sensor, or if strong light falls on the sensor. Weak batteries will also prevent the remote control from properly operating the projector.

2. Installation and Connections

This section describes how to set up your projector and how to connect video and audio sources.

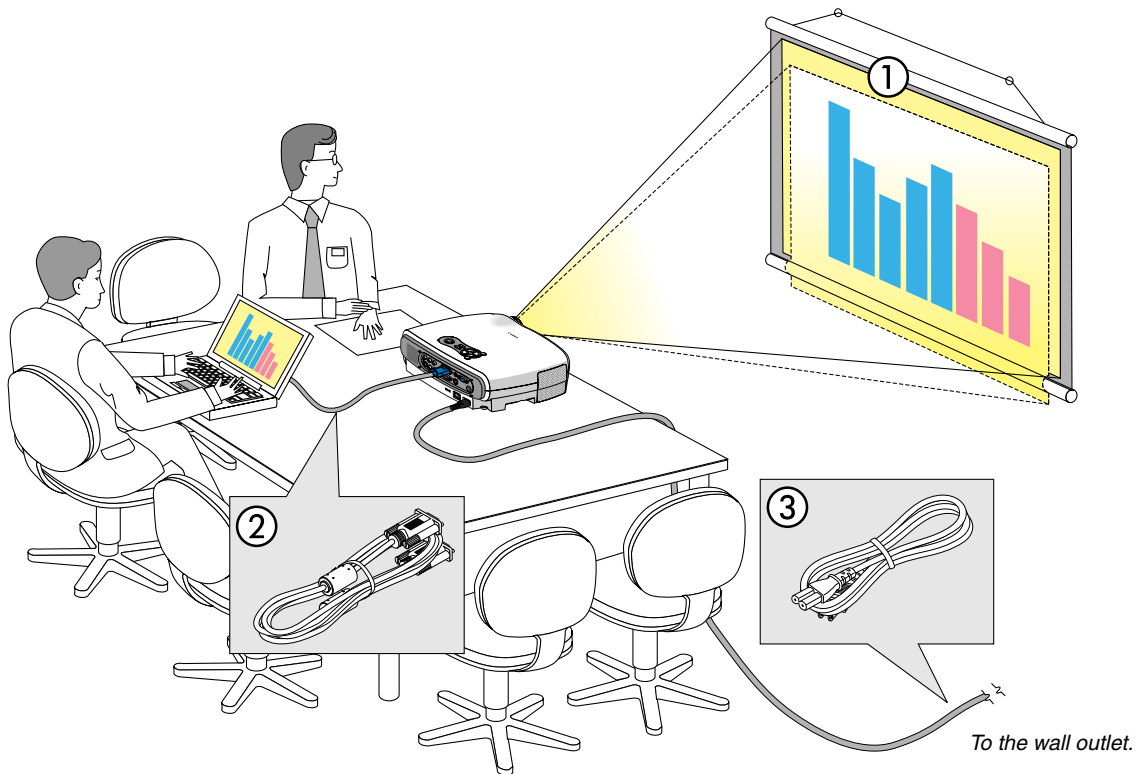

Your projector is simple to set up and use. But before you get started, you must first:

- ① Set up a screen and the projector. See page [12](#).
- ② Connect your computer or video equipment to the projector. See pages [14](#) to [18](#).
- ③ Connect the supplied power cord. See page [19](#).

NOTE: Ensure that the power cord and any other cables are disconnected before moving the projector. When moving the projector or when it is not in use, cover the lens with the lens cap.

1 Setting Up the Screen and the Projector

Selecting a Location

The further your projector is from the screen or wall, the larger the image. The minimum size the image can be is approximately 25" measured diagonally when the projector is roughly 0.9 m (3.1') from the wall or screen. The largest the image can be is 300" when the projector is about 7.6 m (25.0') from the wall or screen. Use the drawing below as a guide.

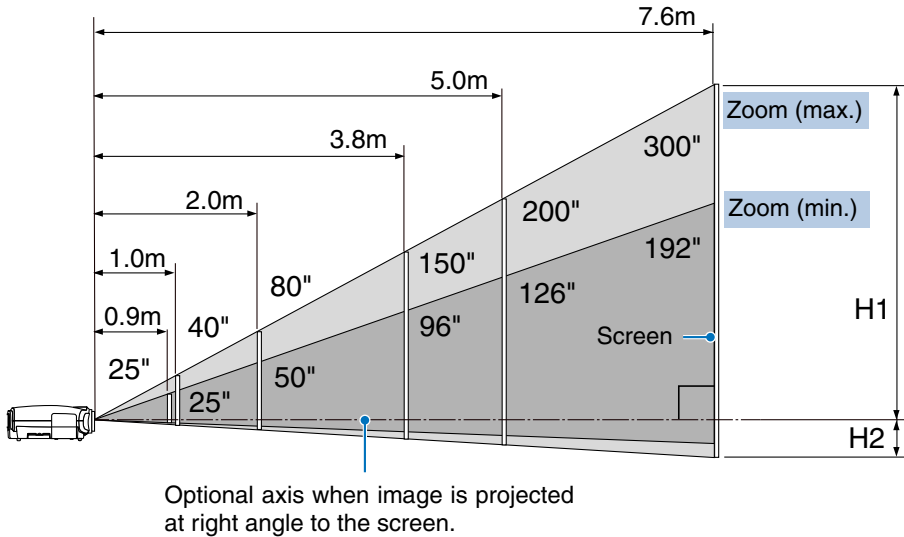

Throw Distance and Screen Size

Screen size (W x H cm)	25"	30"	40"	60"	80"	100"	150"	180"	200"	250"	300"
Screen size (W x H cm)	51 x 38	61 x 46	81 x 61	122 x 91	163 x 122	203 x 152	305 x 229	366 x 206	406 x 305	508 x 381	610 x 457
Projection distance Zoom (max)	-	-	1.0 m (3.2')	1.5 m (4.9')	2.0 m (6.6')	2.5 m (8.3')	3.8 m (12.4')	4.5 m (14.9')	5.0 m (16.6')	6.3 m (20.8')	7.6 m (25.0')
Projection distance Zoom (min)	0.9 m (3.1')	1.1 m (3.8')	1.5 m (5.1')	2.3 m (7.7')	3.1 m (10.3')	3.9 m (12.9')	5.9 m (19.4')	7.1 m (23.3')	-	-	-
H1	34 cm (1.1')	41 cm (1.4')	55 cm (1.8')	82 cm (2.7')	110 cm (3.6')	137 cm (4.5')	206 cm (6.8')	247 cm (8.1')	274 cm (9.1')	343 m (11.3')	411 m (13.6')
H2	4 cm (0.1')	5 cm (0.2')	6 cm (0.2')	9 cm (0.3')	12 cm (0.4')	15 cm (0.5')	23 cm (0.8')	27 cm (0.9')	31 cm (1.0')	38 cm (1.3')	46 cm (1.5')

H1 and H2: H1 is the height of the screen from the intersection of optical axis and screen surface, and H2 is the height of the intersection when an image is projected at right angle to the screen.

TIP:

- For the relationship between the screen size and projection distance, see the table on page 61.
- The sizes in the above table have been obtained assuming that the aspect ratio is 4:3. They may vary from the actual sizes depending on the type of the projected image.
- The Zoom lever adjusts the image size (diagonal) +/- 20%.

NOTE:

- This projector can be hung from the ceiling (Ceiling mounted) with it turned up side down.
- When a translucent screen is used, the projector can project an image from behind the screen (Rear).
- When the projector is hung from the ceiling or projector projects an image from behind the screen, the image must be inverted vertically or horizontally. See page 43.
- When hanging the projector from the ceiling, optional brackets (part No. LV-CL12) are required.

WARNING

- Installing your projector on the ceiling must be done by a qualified technician. Contact your dealer for more information.
- Do not attempt to install the projector yourself.
- Only use your projector on a solid, level surface. If the projector falls to the ground, you can be injured and the projector severely damaged.
- Do not use the projector where temperatures vary greatly. The projector must be used at temperatures between 41°F (5°C) and 95°F (35°C).
- Do not expose the projector to moisture, dust, or smoke. This will harm the screen image.

- Ensure that you have adequate ventilation around your projector so heat can dissipate. Do not cover the vents on the side or the front of the projector.

Reflecting the Image

Using a mirror to reflect your projector's image enables you to enjoy a much larger image. Contact your dealer if you need a mirror system. If you're using a mirror system and your image is inverted, use the MENU and SELECT  buttons on your projector cabinet or your remote control to correct the orientation. See page 43.

② Making Connections

NOTE: When using with a notebook PC, be sure to connect between the projector and the notebook PC before turning on the power to the notebook PC. In most cases signal cannot be output from RGB output unless the notebook PC is turned on after connecting with the projector.

** If the screen goes blank while using your remote control, it may be the result of the computer's screen-saver or power management software.*

Enabling the computer's external display

Displaying an image on the notebook PC's screen does not necessarily mean it outputs a signal to the projector. When using a PC compatible laptop, a combination of function keys will enable/disable the external display. Usually, the combination of the 'Fn' key along with one of the 12 function keys gets the external display to come on or off. For more details, refer to your computer's owner's manual.

Connecting Your PC or Macintosh Computer

NOTE: The COMPUTER 1 connector supports Plug & Play (DDC2).

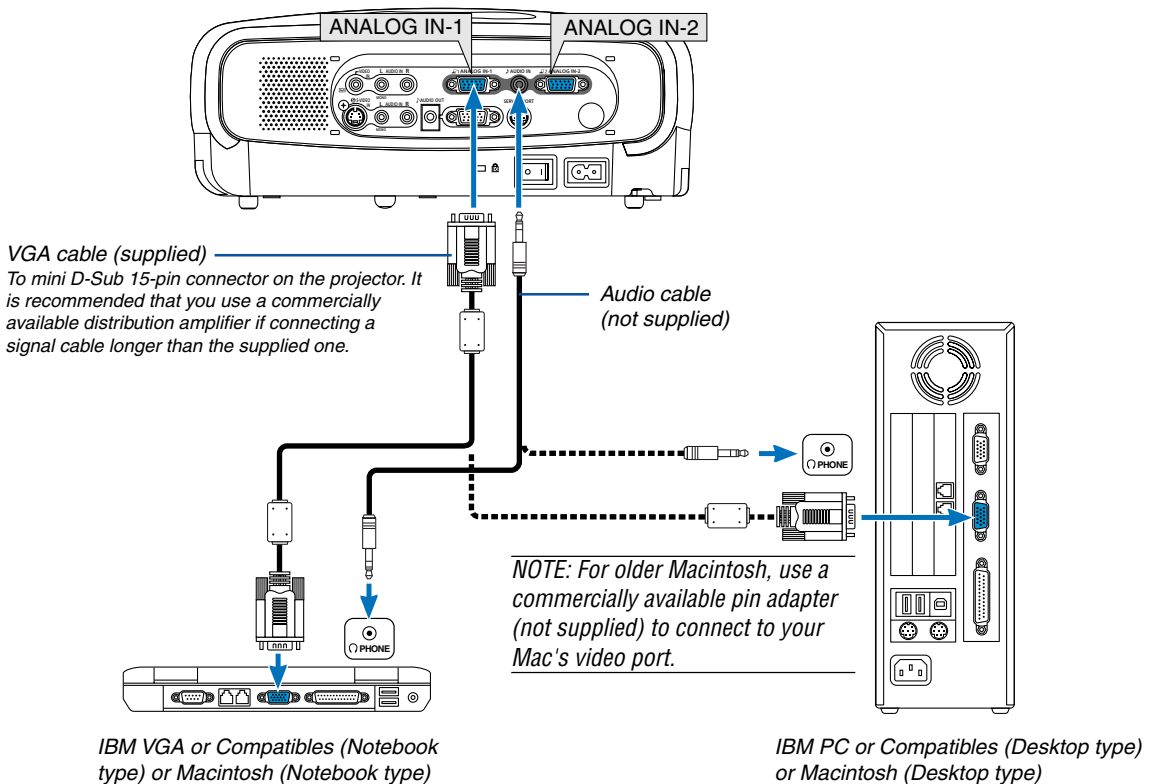

NOTE: Use an audio cable without a built-in resistor. Using an audio cable with a built-in resistor turns down the sound.

NOTE: An image may not be displayed correctly when a Video or S-Video source is played back via a commercially available scan converter.

This is because the projector will process a video signal as a computer signal at the default setting. In that case, do the following.

** When an image is displayed with the lower and upper black portion of the screen or a dark image is not displayed correctly:*

Project an image to fill the screen and then press the AUTO PC button on the remote control or the projector cabinet.

To connect Scart output (RGB)

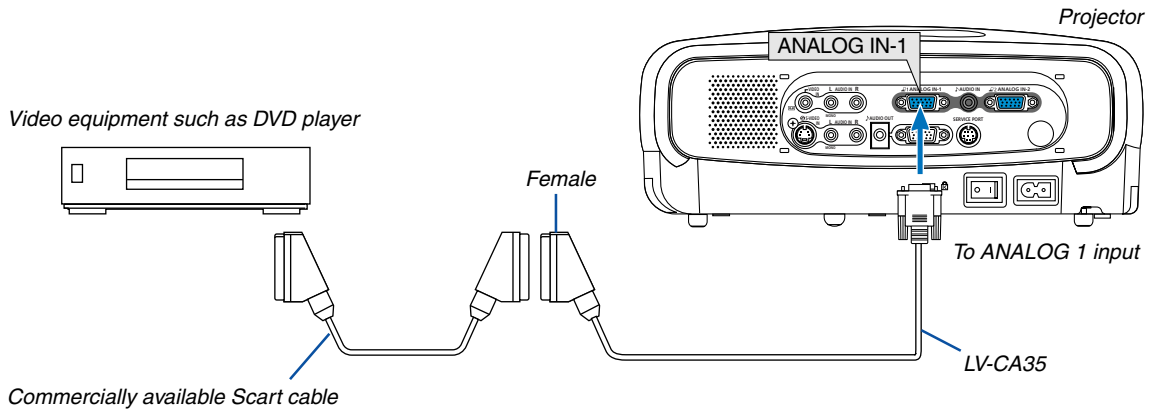

Before connections: An exclusive Scart adapter (LV-CA35) and a commercially available Scart cable are required for this connection.

NOTE: Audio signal is not available for this connection.

From the menu, select [Advanced settings] → [Input signal select] → [Computer 1] → [SCART].
Scart is a standard European audio-visual connector for TVs, VCRs and DVD players. It is also referred to as Euro-connector.

TIP: If a DVD or VCR source will not be displayed correctly, stop playback and restart it.

NOTE: The LV-CA35 Scart adapter is obtainable from your dealer in Europe. Contact your dealer in Europe for more information.

Connecting an External Monitor

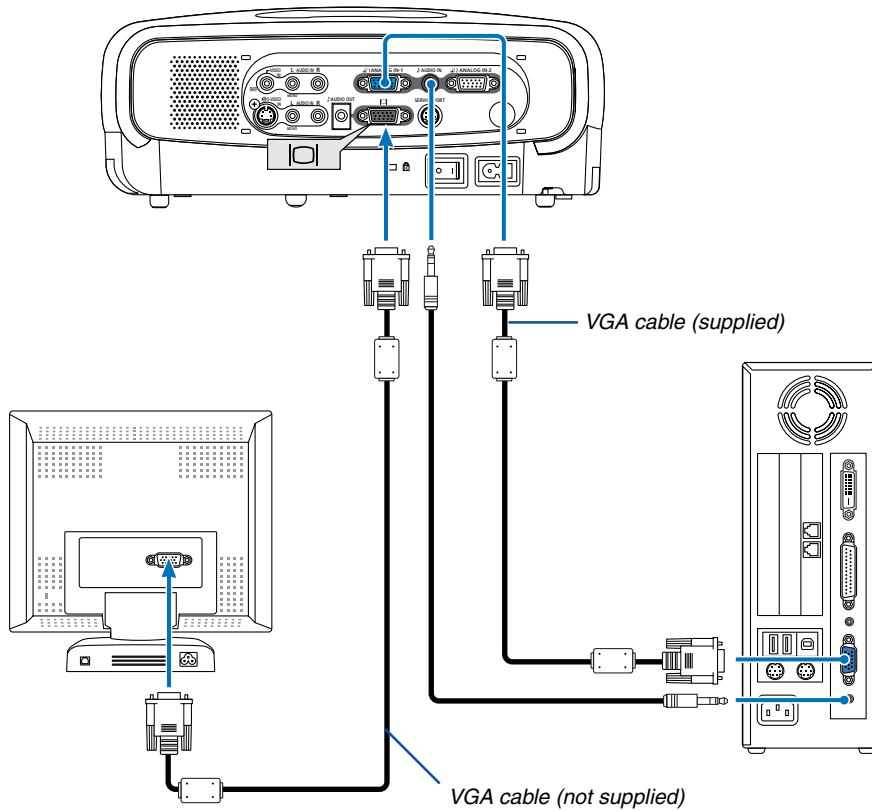

You can connect a separate, external monitor to your projector to simultaneously view on a monitor the RGB analog image you're projecting.

NOTE: Daisy chain connection is not possible.

NOTE: Use an audio cable without a built-in resistor. Using an audio cable with a built-in resistor turns down the sound.

Connecting Your DVD Player with Component Output

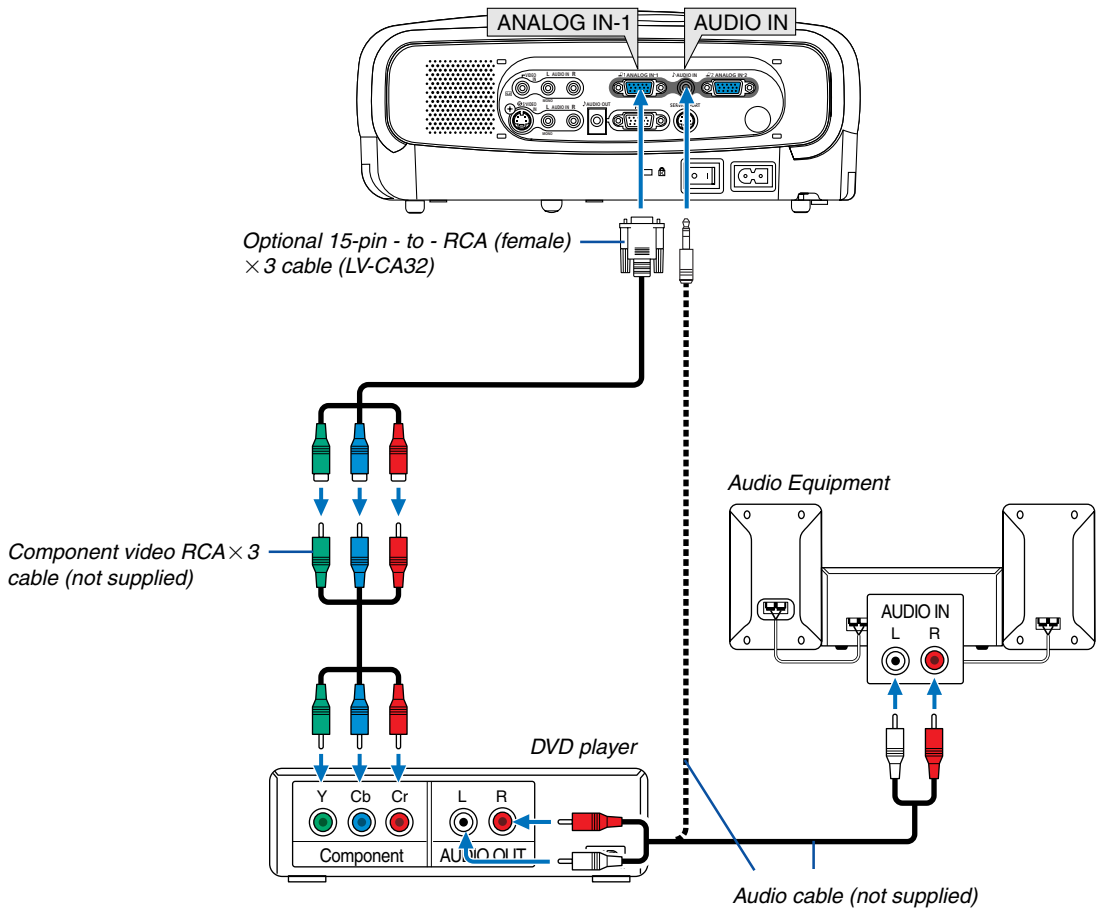

A component signal will be automatically displayed. If not, from the menu, select [Advanced settings] → [Input signal select] → [Computer 1], and then place a check mark in the COMPONENT radio button.

NOTE: Refer to your DVD player's owner's manual for more information about your DVD player's video output requirements.

Connecting Your VCR or Laser Disc Player

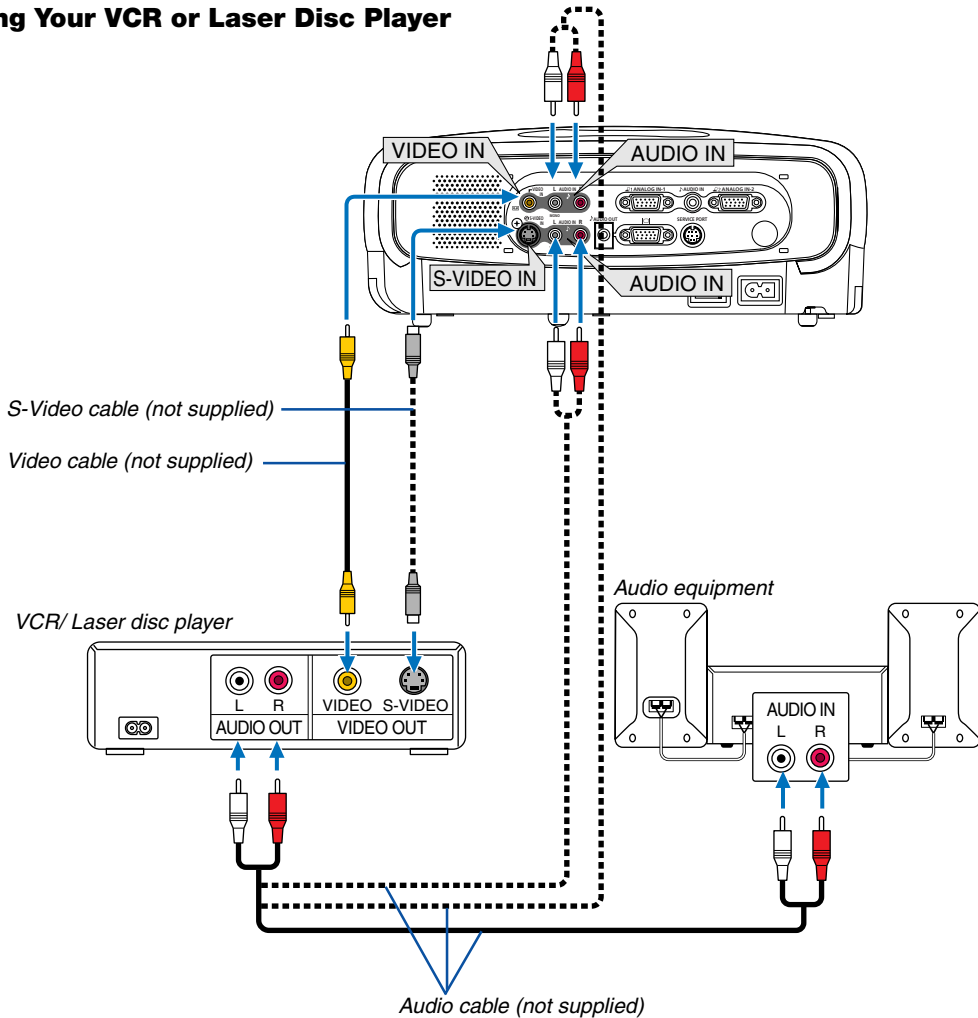

NOTE: Refer to your VCR or laser disc player owner's manual for more information about your equipment's video output requirements.

NOTE: An image may not be displayed correctly when a Video or S-Video source is played back in fast-forward or fast-rewind via a scan converter.

Connecting the Supplied Power Cord

Connect the supplied power cord to the projector.

First connect the supplied power cord's two-pin plug to the AC IN of the projector, and then connect the other plug of the supplied power cord in the wall outlet.

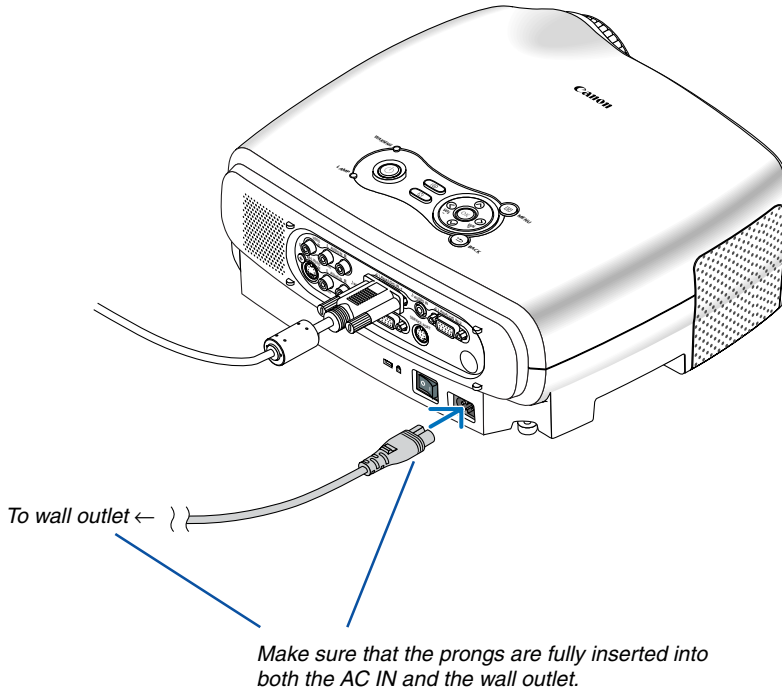

CAUTION:

Do not unplug the power cord from the wall outlet under any one of the following circumstances.

Doing so can cause damage to the projector:

- While the Hour Glass icon appears.
- While the cooling fans are running. The cooling fans continue to work for 30 seconds after the projector is turned off.
- While the lamp is lighted.

3. Projecting an Image (Basic Operation)

This section describes how to turn on the projector and to project a picture onto the screen.

1 Turning on the Projector

NOTE:

- The projector has two power switches: a main power switch and a POWER button.
- When plugging in or unplugging the supplied power cord, make sure that the main power switch is pushed to the off (O) position. Failure to do so may cause damage to the projector.

1. To turn on the main power to the projector, press the Main Power switch to the on position (I).

- The POWER indicator will light orange.
See the Power Indicator section on page 53 for more details.

2. Remove the lens cap.

3. Press the POWER button on the projector cabinet or the POWER button on the remote control for about 1 second. The POWER indicator will turn to green and the projector will become ready to use.

After you turn on your projector, ensure that the computer or video source is turned on and that your lens cap is removed.

NOTE: If you turn on the projector immediately after the lamp is turned off or when the temperature is high, the fans runs without displaying an image for some time and then the projector will display the image.

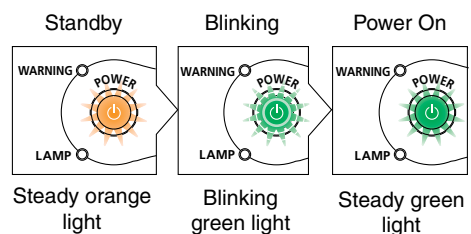
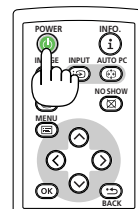
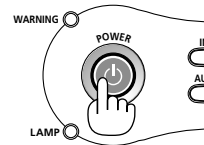
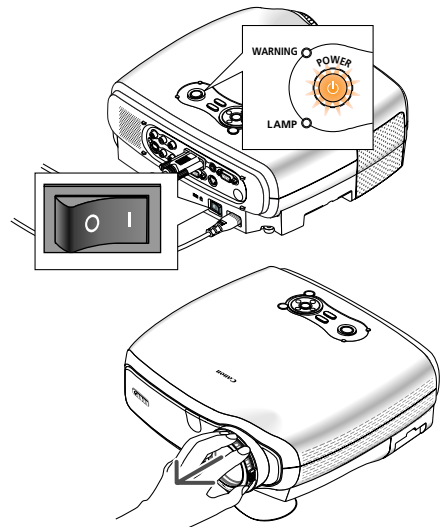

See page 53 for more details.

3. Projecting an Image (Basic Operation)

Note on Startup screen (Menu Language Select screen)

When you first turn on the projector, you will get the Startup menu. This menu gives you the opportunity to select one of the 8 menu languages.

To select a menu language, follow these steps:

1. Use the **SELECT** (UP) or (DOWN) button to select one of the 8 languages for the menu.

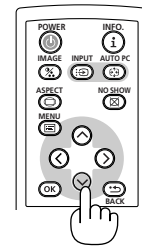
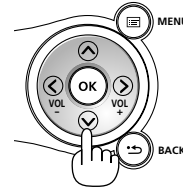
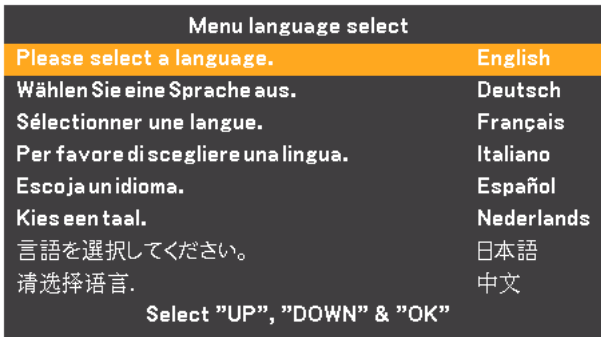

2. Press the **OK** button to execute the selection.

After this has been done, you can proceed to the menu operation.

If you want, you can select the menu language later. See "Language" on pages 37 and 43.

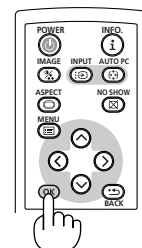
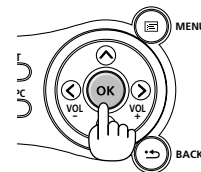

NOTE: Immediately after turning on the projector, screen flicker may occur. This is normal. Wait 3 to 5 minutes until the lamp lighting is stabilized.

When the Lamp mode is set to Quiet, the LAMP indicator will light green.

If one of the following things happens, the projector will not turn on.

- If the internal temperature of the projector is too high, the projector will not turn on to protect the internal system. Please wait for the projector's internal components to cool down.
- When the lamp reaches its end of usable life, the projector will not turn on. If this happens, replace the lamp.
- If the lamp fails to light, and if the WARNING indicator flashes on and off in a cycle of six times, wait a full minute and then turn on the power.

② Selecting a Source

Selecting the computer or video source

NOTE: Turn on the computer or VCR connected to the projector.

Selecting from INPUT List

Press and quickly release the INPUT button on the projector cabinet to display the Source list. Each time the INPUT button is pressed, the input source will change as follows: "Computer 1", "Computer 2", "Video" (VCR or laser disc player), "S-Video". To display the selected source, allow 1 second to elapse.

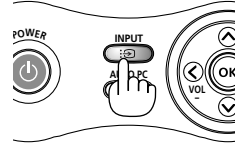

Detecting the Signal Automatically

Press and hold the INPUT button for a minimum of 2 seconds, the projector will search for the next available input source. Each time you press and hold the INPUT button for a minimum of 2 seconds, the input source will change as follows:

Computer1 → Computer2 → Video → S-Video → Computer1 → ...

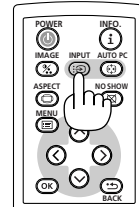

TIP: If no input signal is present, the input will be skipped. When the input source you wish to project is displayed, release the INPUT button.

③ Adjusting the Picture Size and Position

Place your projector on a flat level surface and ensure that the projector is square to the screen.

Lift the front edge of the projector to center the image vertically.

* If the projected image does not appear square to the screen then use the Keystone feature for proper adjustment. See page 25 to 26.

Move the projector left to center the image horizontally on the screen.

Adjust the Tilt Foot

1. Lift the front edge of the projector.

⚠ CAUTION:

Do not try to touch the ventilation outlet during Tilt Foot adjustment as it can become heated while the projector is turned on and during its cool down period after it is turned off.

2. Push and hold the adjustable tilt foot lock button on the front of the projector to extend the adjustable tilt foot.

NOTE: To fine-adjust the height of the rear foot, remove the factory attached spacer and rotate the rear foot to the desired height. Do not throw away or lose the spacer. Attach the spacer to the rear foot again after using the projector.

3. Lower the front of the projector to the desired height.

4. Release the adjustable tilt foot lock button to lock the adjustable tilt foot.

There is approximately 10 degrees (up) of adjustment for the front of the projector.

Adjusting the height of a projected image or changing projection angle will run the Auto Keystone correction function to quickly correct the vertical distortion. The "Keystone" screen will be displayed.

For operating the "Keystone" screen, see "Correcting Keystone Distortion" on page 25.

5. The rear foot height can be adjusted up to 10 mm/0.4 inch.

Rotate the rear foot to the desired height in order to square the image on the projection surface, but the vertical distance from the bottom to the desk or floor should be 10 mm/0.4 inch to make the projector horizontal on the flat surface.

NOTE: If you rotate the rear foot too much, it will come off from the bottom.

⚠ CAUTION:

Do not use the tilt-foot for purposes other than originally intended. Misuses such as using the tilt foot to carry or hang (from the wall or ceiling) the projector can cause damage to the projector.

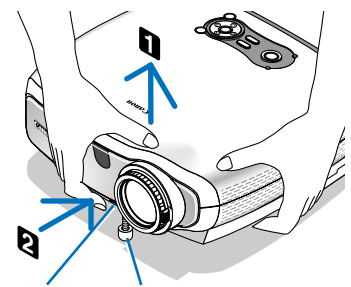
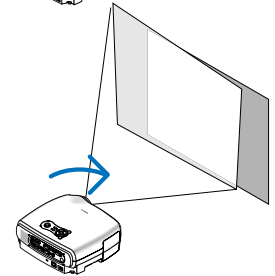
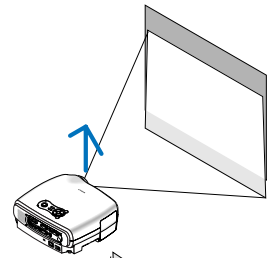

Adjustable Tilt Foot Lever Adjustable Tilt Foot

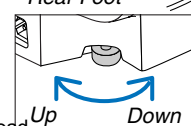
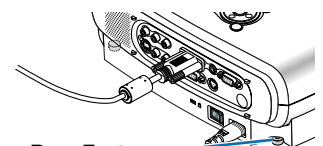
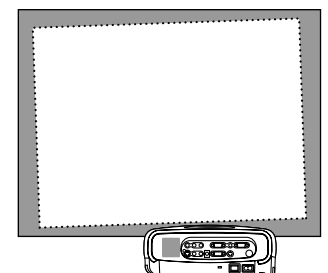
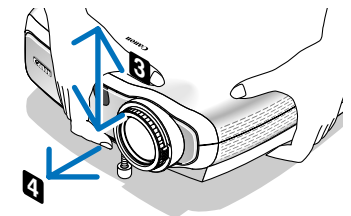

3. Projecting an Image (Basic Operation)

Zoom

Use the ZOOM lever to finely adjust the image size on the screen.

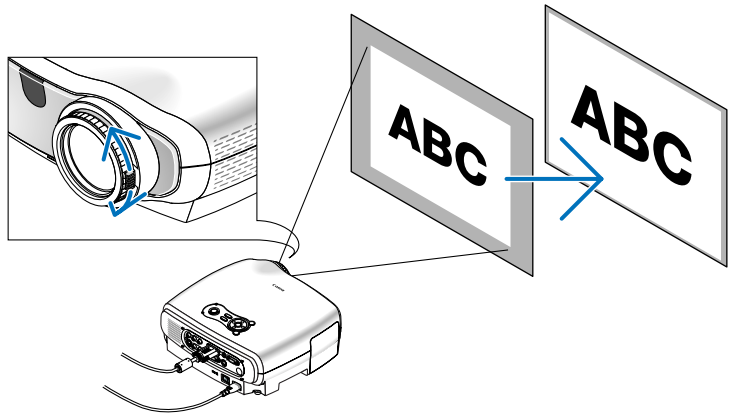

Focus

Use the FOCUS ring to obtain the best focus.

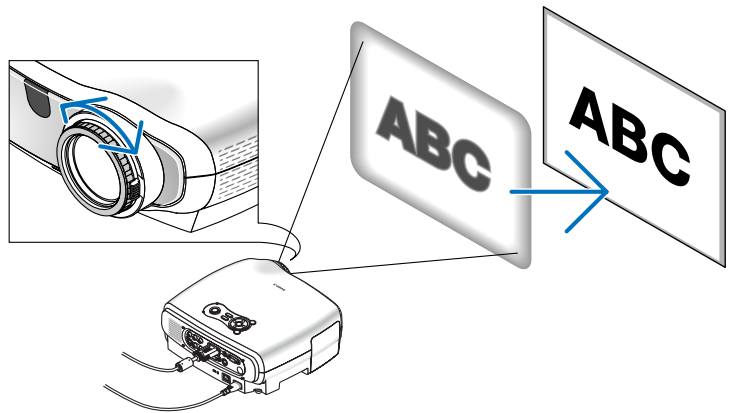

4 Correcting Keystone Distortion

Auto Keystone Correction

The Auto keystone correction feature will correct the vertical distortion of a projected image on the screen. No special operation required. Just put the projector on a flat surface.

NOTE: Although the Auto Keystone angle that can be corrected is about 30 degrees upward and downward, we recommend that you use the Auto Keystone within an angle of +/- 10 degrees.



NOTE: Auto and Manual keystone correction angle could be less than 30 degrees depending on some kinds of signal and aspect ratios.

NOTE: The Auto keystone correction feature can cause an image to be slightly blurred because the correction is made electronically.

Manual Keystone Correction

You can also correct the vertical keystone distortion manually.

To do so:

1. Press the MENU button.

The menu will be displayed.

2. Turn off the Auto keystone function.

Use the SELECT ⏴ button to select “Display settings” and then press OK or the SELECT ⏵ button. The “Auto keystone” will be displayed. Press the SELECT ⏴ to select “Off”.

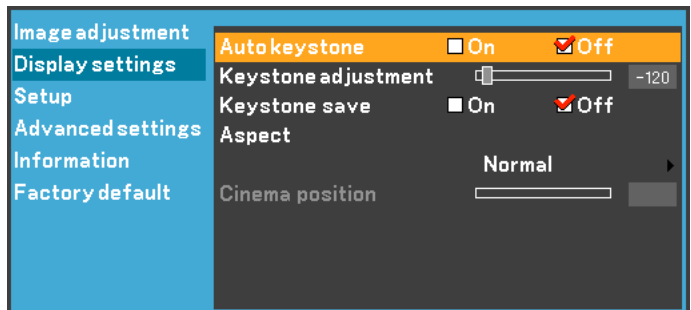

3. Select the Keystone function.

Use the SELECT ⏴ button to select “Keystone adjustment”.

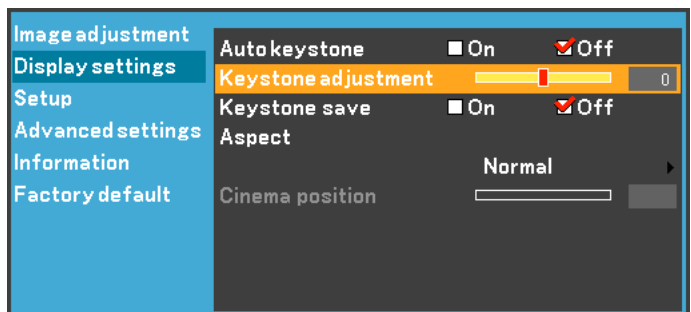

4. Correct the vertical distortion.

Use the SELECT ⏴ or ⏵ button to correct the vertical keystone distortion.

NOTE: The Keystone correction feature can cause an image to be slightly blurred because the correction is made electronically.

3. Projecting an Image (Basic Operation)

5. Press the MENU button to close the menu.

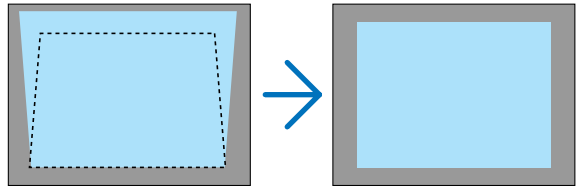

NOTE: You can save the changes using the Keystone save feature when you turn off the projector. See page 41.

5 Automatically Optimizing on RGB Image

Adjusting the Image Using Auto PC adjustment

Optimizing an RGB image automatically.

Press the AUTO PC button to optimize an RGB image automatically.

[Poor picture]

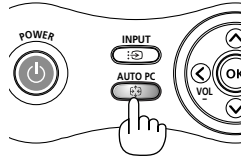
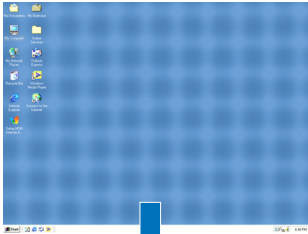

[Normal picture]

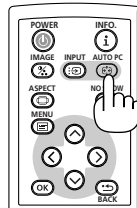
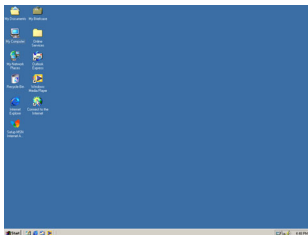

Press the AUTO PC button to fine-tune the computer image or to remove any vertical banding that might appear and to reduce video noise, dot interference or cross talk (this is evident when part of your image appears to be shimmering). This function adjusts the clock frequencies that eliminate the horizontal banding in the image. This function also adjusts the clock phase to reduce video noise, dot interference or cross talk. (This is evident when part of your image appears to be shimmering.)

This adjustment may be necessary when you connect your computer for the first time.

NOTE:

Some signals may not be displayed correctly or take time.

- The Auto PC adjustment function does not work for component, composite and S-video signals.
- If the Auto PC adjustment operation cannot optimize the RGB signal, try to adjust Horizontal/Vertical Position Clock and Tracking manually. See pages 45 and 46.

6 Turning Up or Down Volume

Sound level from the speaker and the AUDIO OUT jack (Stereo mini) on the projector can be adjusted.

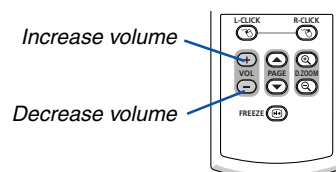
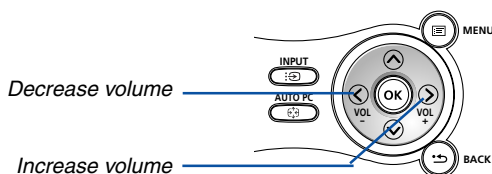

TIP: When no menus appear, the SELECT ◀ and ▶ buttons on the projector cabinet work as a volume control.

7 Turning off the Projector

To turn off the projector:

1. Press the **POWER** button on the projector cabinet or the remote control. The “Power Off / OK?” message will appear.



2. Press the **OK** button or press the **POWER** button again.

The **POWER** indicator will glow orange. After the projector turns off, the cooling fans keep operating for 30 seconds (Cooling-off time).

Immediately after turning on the projector and displaying an image, you cannot turn off the projector for 60 seconds.

3. Turn off the Main Power switch. The power indicator will go out.

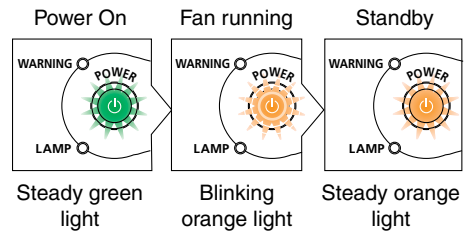
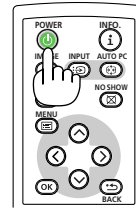
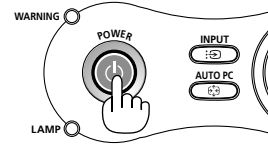

CAUTION

Do not unplug the power cord from the wall outlet or do not turn off the main power under any one of the following circumstances. Doing so can cause damage to the projector:

- While the Hour Glass icon appears.
- While the cooling fans are running. (The cooling fans continue to work for 30 seconds after the projector is turned off)
- While the lamp is lighted.

8 After Use

Preparation: Make sure that the projector is turned off.

1. Unplug the power cord.
2. Disconnect any other cables.
3. Retract adjustable tilt feet if extended.

NOTE: If the spacer is removed from the rear foot before use, attach it again.

4. Cover the lens with the lens cap.
5. Put the projector and its accessories in the supplied soft case.

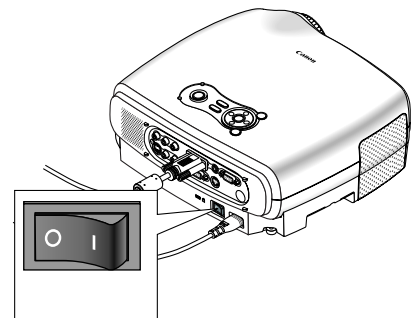

4. Convenient Features

❶ Turning off the Image and Sound

Press the NO SHOW button to turn off the image and sound for a short period of time. Press again to restore the image and sound.

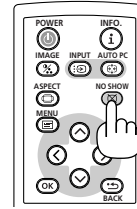

❷ Freezing a Picture

Press the FREEZE button to freeze a projected moving picture such as DVD. Press again to resume motion.

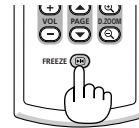

❸ Enlarging and Moving a Picture

You can enlarge the picture up to 400 percent.

To do so:

1. Press the D. ZOOM (+) button to magnify the picture.

To move the magnified image, use the SELECT (⊙) button.

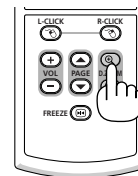
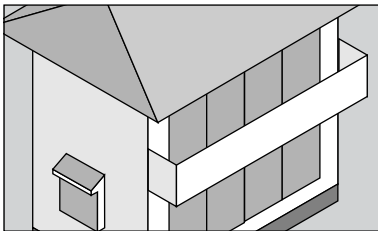
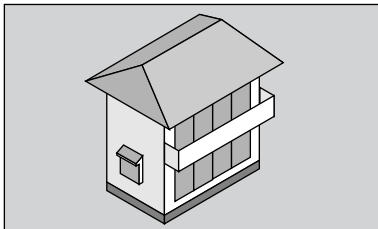

2. Return the image to the original size.

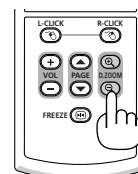
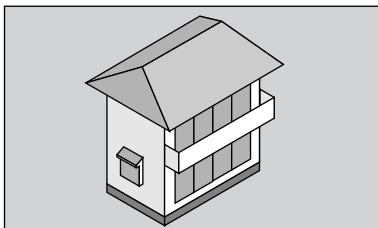

④ Using the Remote Mouse Receiver

The remote mouse receiver enables you to operate your computer's mouse functions from the remote control. It is a great convenience for clicking through your computer-generated presentations.

Connecting the remote mouse receiver to your computer

If you wish to use the remote mouse function, connect the mouse receiver and computer. The mouse receiver can be connected directly to the computer's USB port (type A).

NOTE: Depending on the type of connection or OS installed on your computer, you may have to restart your computer or change your computer settings.

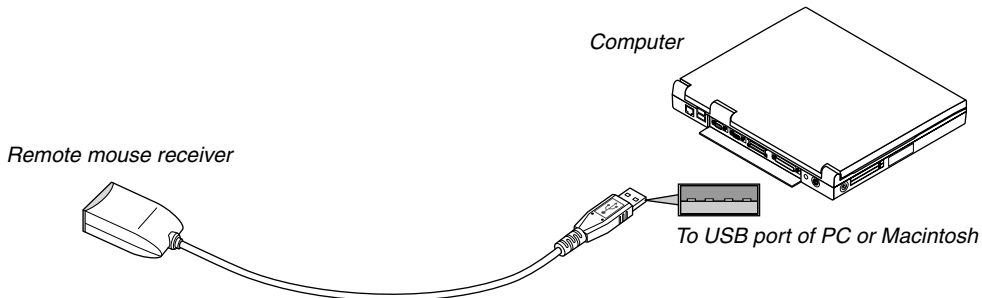

When operating a computer via the remote mouse receiver

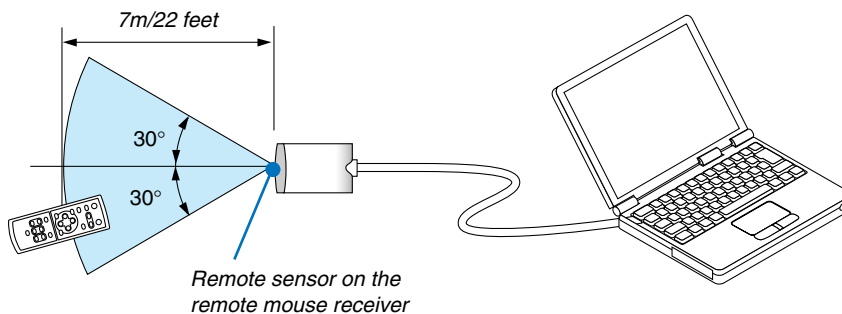

When connecting using the USB terminal

For PC, the mouse receiver can only be used with a Windows 98/Me/XP*, Windows 2000 or Mac OS X 10.0.0 or later operating system.

** NOTE: In SP1 or older version of Windows XP, if the mouse cursor will not move correctly, do the following: Clear the Enhance pointer precision check box underneath the mouse speed slider in the Mouse Properties dialog box [Pointer Options tab].*

NOTE: Wait at least 5 seconds after disconnecting the mouse receiver before reconnecting it and vice versa. The computer may not identify the mouse receiver if it is repeatedly connected and disconnected in rapid intervals.

Operating your computer's mouse from the remote control

You can operate your computer's mouse from the remote control.

PAGE ▲/▼ Button: scrolls the viewing area of the window or to move to the previous or next slide in PowerPoint on your computer.

⊙⊙⊙⊙ / Mouse Buttons: moves the mouse cursor on your computer.

MOUSE L-CLICK Button: works as the mouse left button.

MOUSE R-CLICK Button: works as the mouse right button.

About Drag Mode

By pressing the L-CLICK or R-CLICK button for 2 or 3 seconds then releasing, the drag mode is set and the drag operation can be performed simply by pressing the SELECT ⊙⊙⊙⊙ button. To drop the item, press the L-CLICK (or R-CLICK) button. To cancel it, press the R-CLICK (or L-CLICK) button.

NOTE: When you operate the computer using the SELECT ⊙⊙⊙⊙ or ⊙ button with the menu displayed, both the menu and the mouse pointer will be affected. Close the menu and perform the mouse operation.

TIP: You can change the Pointer speed on the Mouse Properties dialog box on the Windows. For more information, see the user documentation or online help supplied with your computer.

5 Preventing the Unauthorized Use of the Projector

A password can be set for your projector to avoid operation by an unauthorized user using the Menu. When a password is set, turning on the projector will display the password input screen. Unless the correct password is entered, the projector cannot project an image.

To enable the Password function:

1. Select [Advanced settings] → [Password] and press the ◀ button to select "On".

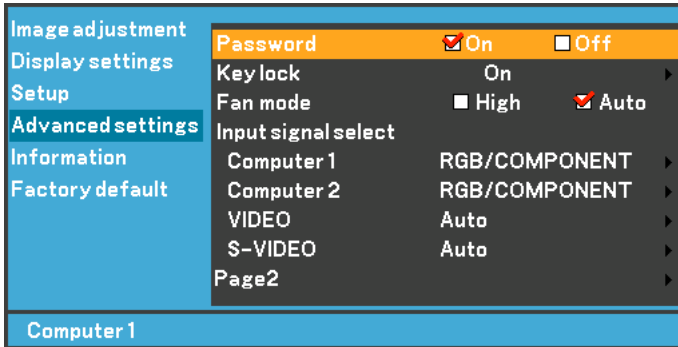

The [Password] screen will be displayed.

2. Type in a combination of the four SELECT buttons (◀▶▶▶) and press the OK button.

NOTE:

- A password must be four to 10 digits in length.
- When you want to cancel registering the password, press the MENU button without entering the password.

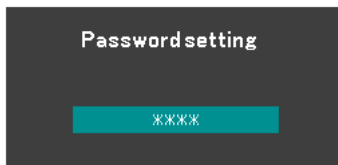

The [Confirm password] screen will be displayed.

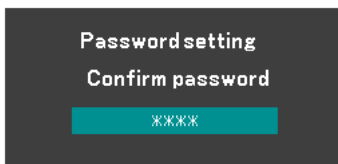

3. Type in the same combination of SELECT buttons (◀▶▶▶) and press the OK button. The confirmation screen will be displayed.

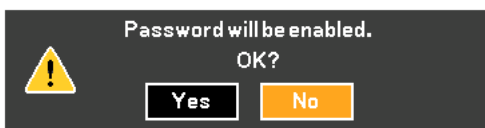

4. Select "Yes" and press the OK button. The Password function has been enabled.

To turn on the projector when Password is enabled:

1. Press the Main Power Switch to the On position (I).
2. Press and hold the POWER button for about 1 second.

The projector will be turned on and display a message to the effect that the projector is password-protected.

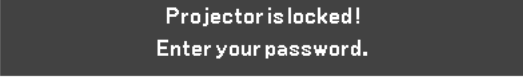

Projector is locked!
Enter your password.

3. Press the MENU button.

The Password screen will be displayed.

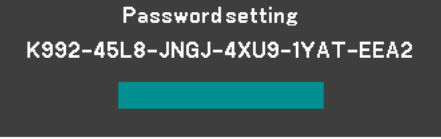

Password setting
K992-45L8-JNGJ-4XU9-1YAT-EEA2

4. Enter your password in the Password screen and press the OK button.

You can view the projected image.

NOTE: The password disable mode is maintained until the main power is turned off (by setting the main power switch to "0" or unplugging the power cord).

To disable the Password function:

1. Select [Advanced settings] → [Password] and press the  button to select "Off".

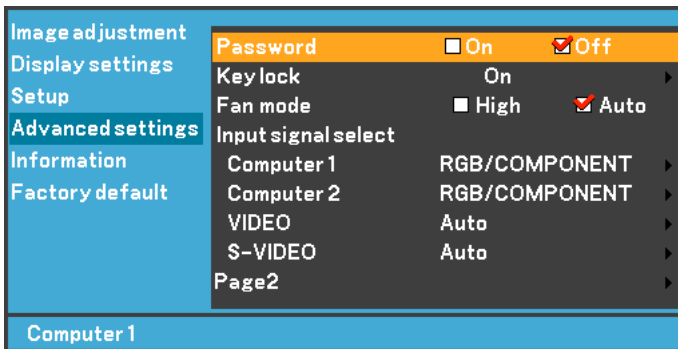

The Password confirmation screen will be displayed.

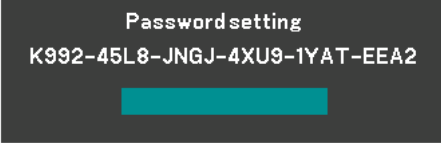

Password setting
K992-45L8-JNGJ-4XU9-1YAT-EEA2

2. Type in your password and press the OK button.

When the correct password is entered, the Password function will be disabled.

NOTE:

- The password disable mode is maintained until the main power is turned off (by setting the main power switch to "0" or unplugging the power cord).
 - If you forget your password, contact your dealer.
-

5. Using On-Screen Menu

① Using the Menus

NOTE: The on-screen menu may not be displayed correctly while interlaced motion video image is projected.

1. Press the **MENU** button on the remote control or projector cabinet to display the Menu.

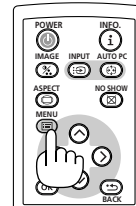
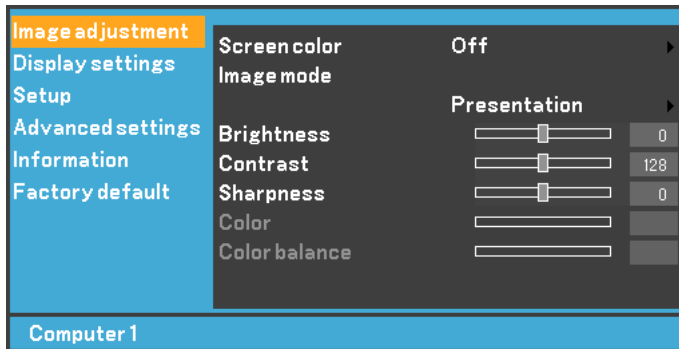

2. Press the **SELECT** (up/down arrow) button on the remote control or the projector cabinet to highlight the menu for the item you want to adjust or set.

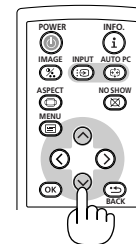
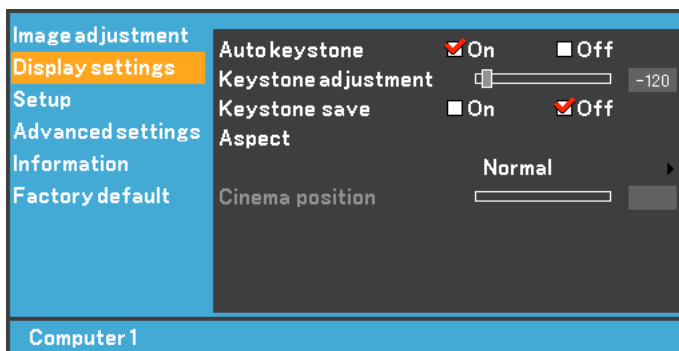

3. Press the **SELECT** (left/right arrow) button or the **OK** button on the remote control or the projector cabinet to select a submenu or item.

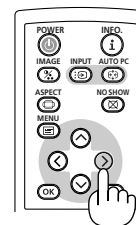
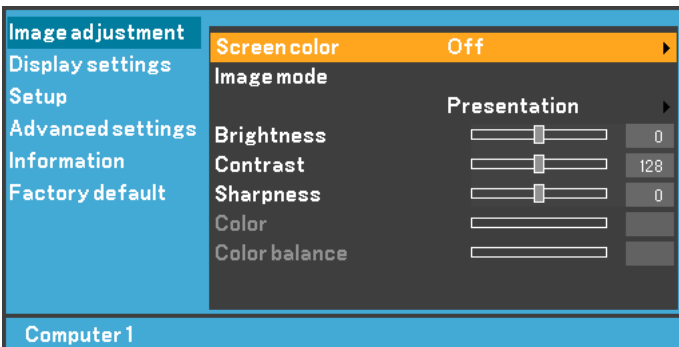

5. Using On-Screen Menu

4. Use the **SELECT** (◂) or (◃) button on the remote control or the projector cabinet to select the item you want to adjust or set.

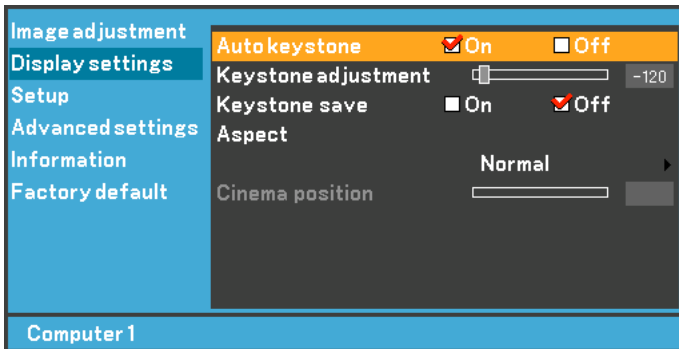
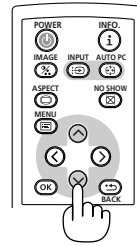
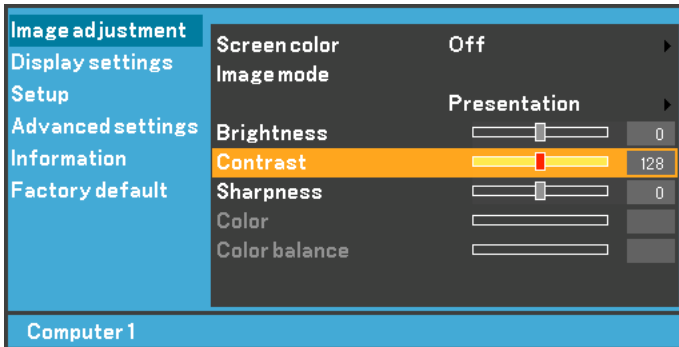

5. Adjust the level or turn the selected item on or off by using **SELECT** (◂) or (◃) button on the remote control or the projector cabinet.

The on-screen slide bar will show you the amount of increase or decrease.

Changes are stored until you adjust it again.

BACK Return to the previous menu.

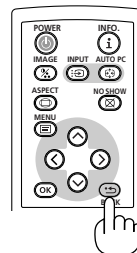

6. Repeat steps 2-5 to adjust an additional item, or press the **MENU** button to close the menu.

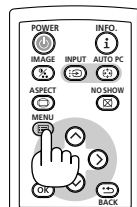

2 Menu Elements

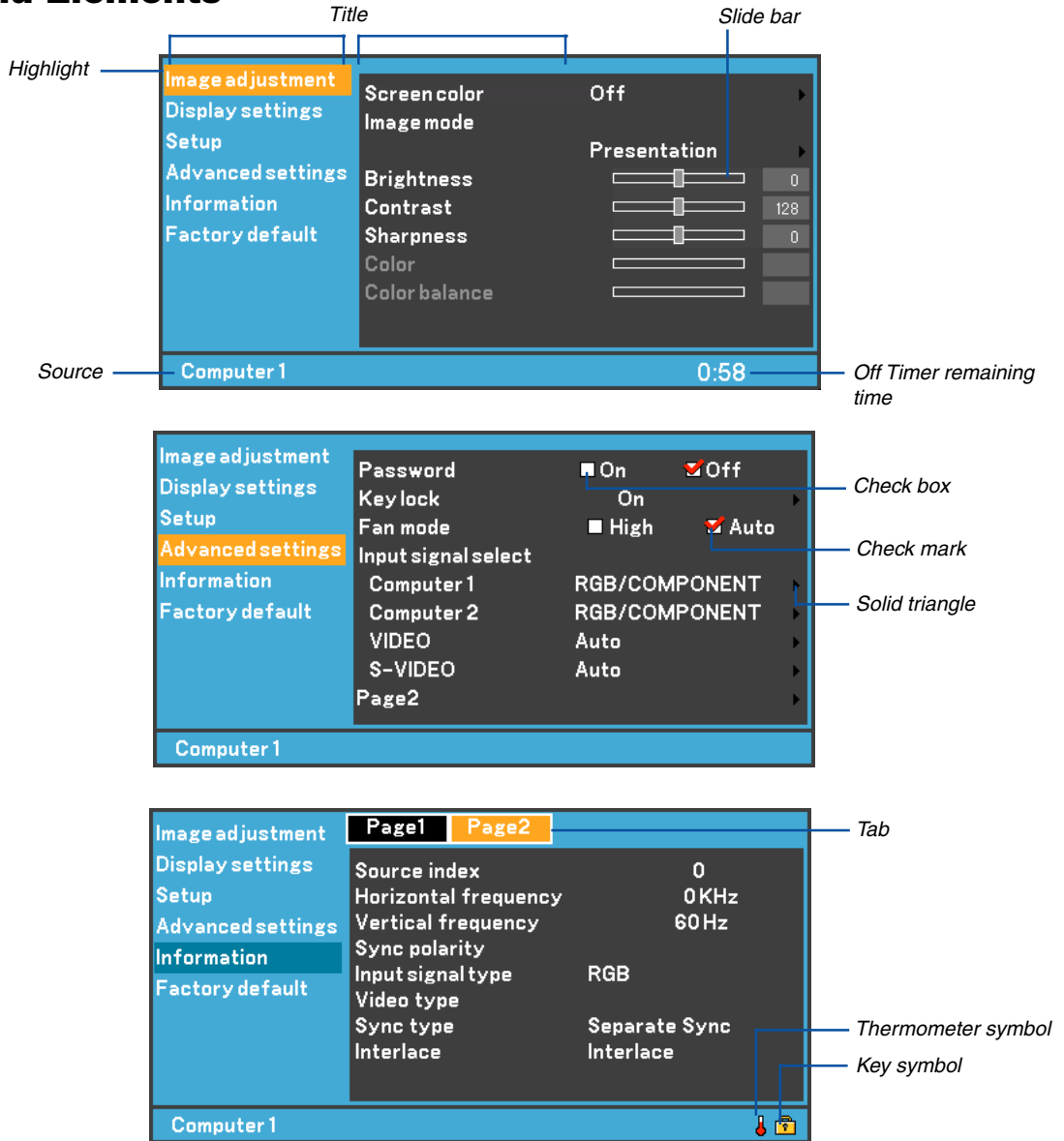

Menu windows or dialog boxes typically have the following elements:

- Title Indicates the menu title.
- Highlight..... Indicates the selected menu or item.
- Source Indicates the currently selected source.
- Remaining countdown time Indicates the remaining countdown time when the Off Timer is preset.
- Solid triangle Indicates further choices are available. A highlighted triangle indicates the item is active.
- Tab Indicates a group of features in a dialog box. Selecting on any tab brings its page to the front.
- Check box Place a checkmark in the square box to turn the option On.
- Check mark Indicates the item is selected.
- Slide bar Indicates settings or the direction of adjustment.
- Key symbol Indicates the Key Lock is enabled.
- Thermometer symbol Indicates the lamp is forcibly being cooled down because the internal temperature is too high.

3 List of Menu Items

Some menu items are not available depending on the input source.

Image adjustment	Default	Item
Screen color	Off	Off, Greenboard, Light yellow, Light green, Light blue, Sky blue, Light rose, Pink
Image mode	*	Standard, Presentation, Cinema, Video, sRGB
	*	User
	*	Base setting Standard, Presentation, Cinema, Video, sRGB
	*	Gamma Black detail, Dynamic, Natural
	*	Brightness R,G,B
	*	Contrast R,G,B
Brightness	*	
Contrast	*	
Sharpness	*	
Color	*	
Color balance	*	

Display settings	Default	Item
Auto keystone	On	On, Off
Keystone adjustment		
Keystone save	Off	On, Off
Aspect	Normal	Normal, Wide zoom, Cinema, True size
Cinema position		

Setup	Default	Item
Off timer	Off	Off, 0:30, 1:00, 2:00, 3:00, 4:00, 6:00, 8:00
Lamp mode	Normal	Normal, Quiet
Language	English	Language-1 English, Deutsch, Français, Italiano, Español, Português, Nederlands Language-2 Svenska, Norsk, Suomi, Česky, Magyar, Polski, Türkçe Language-3 Русский, Ελληνικά, 日本語, 中文, 한국어, عربي, Dansk
Menu color select	Color	Color, Monochrome
Menu display time	45 sec	Manual, 5 sec, 15sec, 45 sec
No signal screen	Blue	Blue, Black, Canon logo
Image flip H/V	None	None / Rear, Ceiling mounted / Rear / Ceiling mounted
Beep	On	On, Off

Advanced settings	Default	Item
Password	Off	On, Off
Key lock	Off	On, Off
Fan mode	Auto	High, Auto
Input signal select		
Computer 1	RGB/COMPONENT	RGB/COMPONENT, RGB, COMPONENT, SCART
Computer 2	RGB/COMPONENT	RGB/COMPONENT, RGB, COMPONENT
VIDEO	Auto	Auto, NTSC3.58, NTSC4.43, PAL, PAL-M, PAL-N, PAL60, SECAM
S-VIDEO	Auto	Auto, NTSC3.58, NTSC4.43, PAL, PAL-M, PAL-N, PAL60, SECAM
Page2	Off	Power management On, Off
	Off	Noise reduction On, Off
	On	Flicker reduction On, Off
	Normal	Auto PC adjustment Off, Normal, Fine
	*	Horizontal position
	*	Vertical position
	*	Clock
	*	Tracking
	19200	Communication speed 4800, 9600, 19200

* The asterisk (*) indicates that the default setting varies depending on the signal.

5. Using On-Screen Menu

Information	
Page1	Remaining lamp time, Lamp counter, Filter counter, Projector usage, BIOS version, Firmware version, Data version
Page2	Source index, Horizontal frequency, Vertical frequency, Sync polarity Input signal type, Video type, Sync type, Interlace

Factory default	
Factory default	Current signal All data
Filter counter	
Lamp counter	

④ Menu Descriptions & Functions [Image adjustment]



Using the Screen color correction [Screen color]



This function allows for quick adaptive color correction in applications where the screen material is not white. The following eight options are available.

- OFF
- Light yellow
- Light blue
- Light rose
- Greenboard
- Light green
- Sky blue
- Pink

Using Image mode [Image mode]

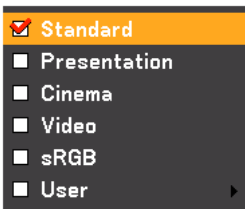

This option allows you to adjust neutral tint for yellow, cyan or magenta.

There are 5 factory presets optimized for various types of images, or you can set user adjustable settings.

- Standard Select this to project an image with a similar quality to that of the original image. An image is projected with a high regard for reproduction of white.
- Presentation Select this to project an image with a similar quality to that of the original image. A bright and high-contrast image is projected.
- Cinema Select this to project a moving picture. A picture is projected with a high regard for color tone reproduction.
- Video Select this to project a regular picture such as TV program
- sRGB Select this when you want to project an image from a sRGBcompatible digital camera. An image is projected in the display mode conforming to the sRGB Standard.
- User User adjustable

NOTE: When "sRGB", "Standard", "Video" or "Cinema" is selected, the brightness decreases slightly when compared to "Presentation". This is not a malfunction.

User Adjust (when using User)

When selecting user adjustable presetting (User), the submenu will be displayed.

You can customize each gamma or color. To do so, first select "User" and press the OK button, and then proceed the following steps.

Selecting Base Setting [Base setting]

This feature allows you to use white balance or gamma values as reference data to optimize for various types of images. You can select one of the following five settings.

- Standard
- Presentation
- Cinema
- Video
- sRGB

Selecting Gamma Mode [Gamma]

Each mode is recommended for :

- Black detail Emphasizes detail in dark areas of the picture
- Dynamic Creates a high-contrast picture
- Natural Natural reproduction of the picture

Adjusting White Balance [Brightness RGB/Contrast RGB]

This allows you to adjust the white balance. Brightness for each color (RGB) is used to adjust the black level of the screen; Contrast for each color (RGB) to adjust the white level of the screen.

Adjusting Brightness, Contrast, Sharpness, Color and Color balance

- Brightness Adjusts the brightness level.
- Contrast Adjusts the intensity of the image according to the incoming signal.
- Sharpness Controls the detail of the image for Video.
- Color Increases or decreases the color saturation level (not valid for RGB).
- Color balance Varies the color level from +/- green to +/- blue. The red level is used as reference. This adjustment is only valid for Video and Component inputs (not valid for RGB).

5 Menu Descriptions & Functions [Display settings]

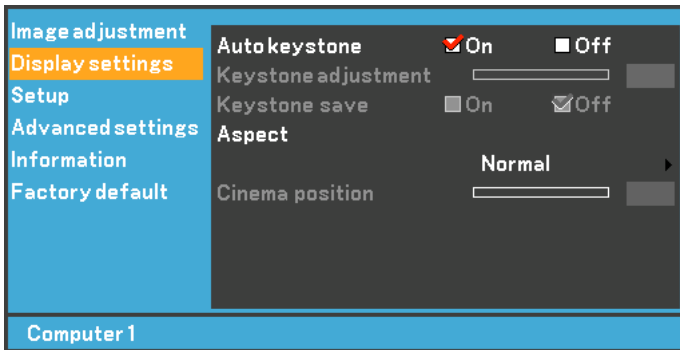

Enabling Auto Keystone [Auto keystone]

This feature allows the projector to detect its tilt and correct vertical distortion automatically. To turn on the Auto keystone feature, select “On”.

Correcting Vertical Keystone Distortion Manually [Keystone adjustment]

You can correct vertical distortion manually from the menu when “Auto keystone” is turned off. You can save the changes using the Keystone save feature when you turn off the projector.

Saving Vertical Keystone Correction [Keystone save]

This option enables you to save your current keystone settings. Saving your change once affects all sources. The changes are saved when the projector is off.

Selecting Aspect Ratio [Aspect]

Aspect allows you to select the best Aspect mode to display your source image. You can also display the Aspect menu by pressing the “ASPECT” button on the remote control.

	<i>Normal</i>	<i>Wide Zoom</i>	<i>Cinema</i>	<i>True size</i>
When 4:3 is selected from the source (i.e. DVD player), the following selections will display:				
	<i>Standard 4:3 Aspect</i>	<i>Left and right stretched</i>	<i>Left and right stretched</i>	
	<hr/>			
When 16:9 is selected from the source (i.e. DVD player), the following selections will display:	<i>Normal</i>	<i>Wide Zoom</i>	<i>Cinema</i>	
	<i>16:9 image displayed in 4:3 mode</i>	<i>Left and right stretched</i>	<i>Left and right stretched to display the true aspect</i>	

True size (RGB only): Turns off the scaling technology feature. The projector displays the current image in its true resolution.

NOTE:

- While you are displaying an image at the projector's native resolution or higher, “True size” is not available.
- You can adjust the image position for Cinema aspect. See “Cinema position” for setting the image position.

Copyright

Please note that using this projector for the purpose of commercial gain or the attraction of public attention in a venue such as a coffee shop or hotel and employing compression or expansion of the screen image with a “Aspect” setting may raise concern about the infringement of copyrights which are protected by copyright law.

Adjusting the Vertical Position of Image [Cinema position] (for Cinema only)

This feature adjusts the vertical position of the image when viewing video with Cinema aspect selected. When “Cinema” is selected in “Aspect”, the image is displayed with black borders on the top and bottom. You can adjust the vertical position between top and bottom.

NOTE: This option is available only when “Cinema” is selected in Aspect.

6 Menu Descriptions & Functions [Setup]

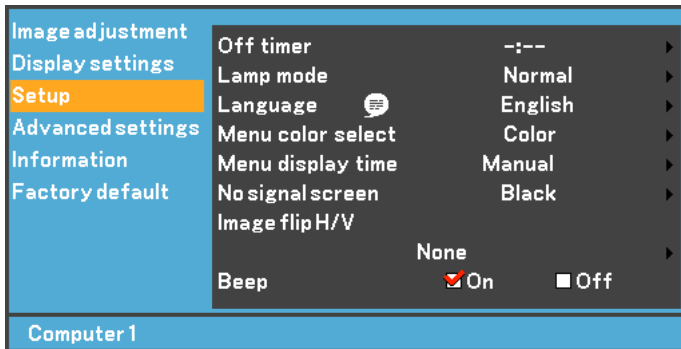

Using Off Timer [Off timer]

You can set the timer so that the projector turns itself off at the preset time.

1. Use the SELECT or button to select your desired time between 30 minutes and 8 hours: Off, 0:30, 1:00, 2:00, 3:00, 4:00, 6:00 and 8:00.
2. Press the OK button.
3. The Off Timer starts counting down the remaining time.
4. The projector turns off after the countdown is complete.

NOTE:

- To cancel the preset time, select “Off” for the preset time or turn off the power.
- When the remaining time reaches 3 minutes before the projector is turned off, the “Power off within 3 minutes.” message will be displayed on the bottom of the screen.

Selecting Lamp Mode [Lamp mode]

This feature enables you to select two brightness modes of the lamp: Normal and Quiet modes. The lamp life can be extended by using the Quiet mode.

Lamp Mode	Description	Status of LAMP indicator
Normal Mode	This is the default setting (100% Brightness).	Off
Quiet Mode	Select this mode to increase the lamp life (approx. 80% Brightness).	Steady Green light

NOTE:

- The lamp life remaining and lamp hours used can be checked in [Information]. Select [Information] → [Page 1].
- If the projector is overheated in Normal mode, there may be a case where the Lamp mode automatically changes to Quiet mode to protect the projector. This is called “forced cooling operation”. When the projector is in a forced cooling operation, the picture brightness decreases. When the projector comes back to normal temperature, the Lamp mode returns to Normal mode. Thermometer symbol [] indicates the lamp mode is automatically set to a forced cooling operation because the internal temperature is too high. In this condition, changing [Lamp mode] setting in the menu will not affect the actual lamp mode and the LAMP indicator lights green.

Selecting Menu Language [Language]

You can choose one of 21 languages for on-screen instructions.

Selecting Menu Color [Menu color select]

You can choose between two color modes for menu color: color and monochrome.

Selecting Menu Display Time [Menu display time]

This option allows you to select how long the projector waits after the last touch of a button to turn off the menu. The preset choices are "Manual", "5 sec", "15 sec", and "45 sec". The "45 sec" is the factory preset.

Selecting a Color or Logo for No signal screen [No signal screen]

Use this feature to display a black/ blue screen or logo when no signal is available.

Selecting Projector Orientation [Image flip H/V]

This sets your image for your type of projection. The options are: front projection, rear projection, ceiling mounted projection and rear ceiling mounted projection.

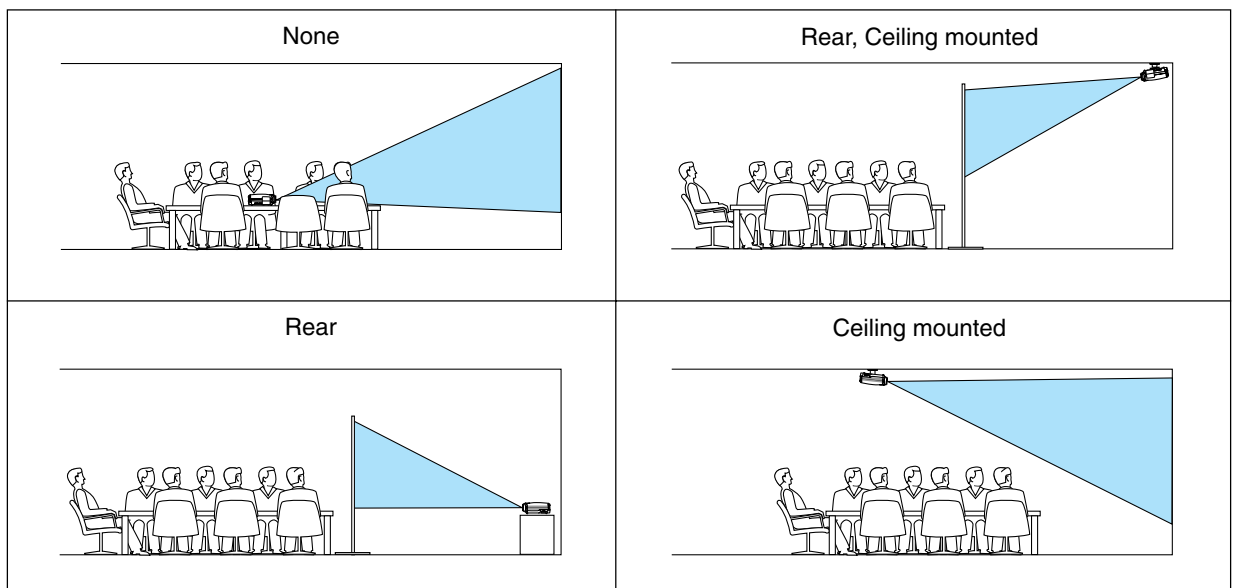

Enabling Key Sound and Error Sound [Beep]

This feature turns on or off the keypad sound or alarm when a button on the cabinet and the remote control is pressed or an error occurs.

7 Menu Descriptions & Functions [Advanced settings]

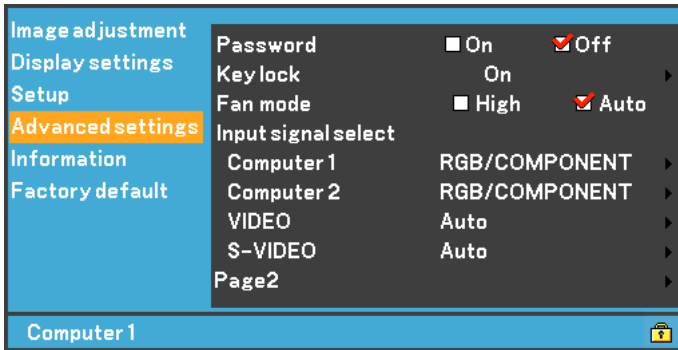

Enabling Password [Password]

This feature turns on or off the Password function.

Unless the correct password is entered, the projector cannot project an image. (→ page 32)

Disabling the Key lock [Key lock]

This option turns on or off the Key lock function.

NOTE:

- This Key lock does not affect the remote control and the PC control functions.
- When the Key Lock is Off, pressing and holding the BACK button for about 10 seconds will change the setting to enable.
- Key symbol  indicates the Key lock is On.

Enabling High Speed Fan Mode [Fan mode]

This option allows you to select two modes for fan speed: High speed mode and Auto mode.

High The built-in fans run at a fixed high speed.

Auto The built-in fans automatically run at a variable speed according to the internal temperature.

When you wish to cool down the temperature inside the projector quickly, select “High”.

NOTE: Select “High” if you continue to use the projector for consecutive days.

Selecting Signal Format [Input signal select]

[Computer]

Allows you to choose “RGB” for an RGB source such as a computer, or “COMPONENT” for a component video source such as a DVD player. Normally select “RGB/COMPONENT” and the projector automatically detects a component signal. However there may be some component signals that the projector is unable to detect. If this is the case, select “COMPONENT”. Select “SCART” in Computer 1 for the European Scart signal.

[VIDEO & S-VIDEO system select]

This feature enables you to select composite video standards manually. Normally select “Auto”.

When you select the video standard for VIDEO and S-VIDEO, select the video standard from the pull-down menu.

This must be done for VIDEO and S-VIDEO respectively.

(Advanced settings Page 2)

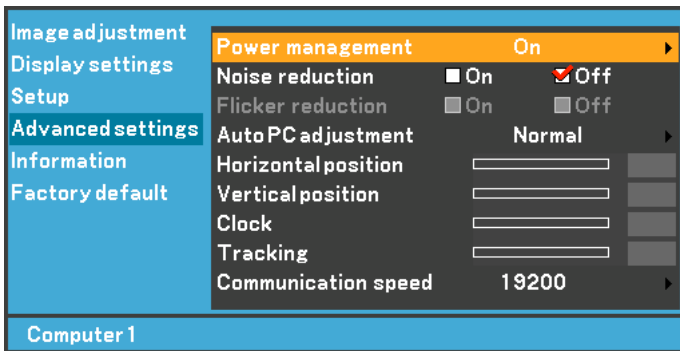

Enabling Power Management [Power management]

When this option is on and there is no signal or no menu operation for five minutes or more, the projector will automatically turn itself off.

Turning On Noise Reduction [Noise reduction] (not available for Video and S-Video signals)

Reduces video noise. Select “On” to enable the Noise Reduction feature.

Turning On Flicker Reduction [Flicker reduction]

Reduces flicker which can occur in an interlaced signal. This feature is not available for RGB and HDTV signals.

NOTE: When the Flicker reduction is ON, jagged lines can be visible depending on the signal. In that case, select OFF.

NOTE: This feature may not be available depending on your video equipment connected to the projector.

Setting Auto PC adjustment [Auto PC adjustment]

This feature sets the Auto PC adjustment mode so that the RGB image can be automatically or manually adjusted for noise and stability. You can automatically make adjustment in two ways: Normal and Fine

- Off The RGB image will not be automatically adjusted.
You can manually optimize the RGB image.
- Normal Default setting. The RGB image will be automatically adjusted. Normally select this option.
- Fine Select this option if fine adjustment is needed. It takes more time to switch to the source than when “Normal” is selected.

Adjusting Position/Clock (when Auto PC adjustment is off)

This allows you to manually adjust the image horizontally and vertically, and adjust Clock and Tracking.

[Horizontal/Vertical position]

Adjusts the image location horizontally and vertically.
This adjustment is made automatically when the Auto PC adjustment is turned on.

[Clock] (available for RGB and HDTV signals only)

Use this item with the “Auto PC adjustment off” to fine tune the computer image or to remove any vertical banding that might appear. This function adjusts the clock frequencies that eliminate the horizontal banding in the image. This adjustment may be necessary when you connect your computer for the first time. This adjustment is made automatically when the Auto PC adjustment is turned on.

[Tracking] (available for RGB and HDTV signals only)

Use this item to adjust the clock phase or to reduce video noise, dot interference or cross talk. (This is evident when part of your image appears to be shimmering.)

Use "Tracking" only after the "Clock" is complete.

This adjustment is made automatically when the Auto PC adjustment is turned on.

Selecting Communication Speed [Communication speed]

This feature sets the baud rate of the SERVICE PORT (Mini DIN 8 Pin). It supports data rates from 4800 to 19200 bps. The default is 19200 bps.

Select the appropriate baud rate for your equipment to be connected (depending on the equipment, a lower baud rate may be recommended for long cable runs).

8 Menu Descriptions & Functions [Information]

	Page1	Page2
Image adjustment		
Display settings	Remaining lamp time	
Setup		100%
Advanced settings	Lamp counter	0 (H)
Information	Filter counter	0 (H)
Factory default	Projector usage	0 (H)
	BIOS version	1.00
	Firmware version	1.00
	Data version	1.00
Computer 1		

Displays the status of the current signal, Remaining lamp time (%), Lamp/Filter/Projector usage time (hours) and version information. The Information has two pages. The Information included is as follows:

[Page 1]

Remaining lamp time (%)*

Lamp counter (H)

Filter counter

Projector usage

- * The progress indicator shows the percentage of remaining bulb life. The value informs you of the amount of lamp usage. When the remaining lamp time reaches 0, the Remaining lamp time bar indicator changes from 0% to 100 Hours and starts counting down.

If the Remaining lamp time reaches 0 hours, the projector will not turn on regardless of whether the lamp mode is set to Normal or Quiet.

BIOS version

Firmware version

Data version

Lamp life(H)		Replacement lamp
Normal	Quiet	
2000	3000	LV-LP24

[Page 2]

- Source index
- Horizontal frequency
- Vertical frequency
- Sync polarity
- Input signal type
- Video type
- Sync type
- Interlace

9 Menu Descriptions & Functions [Factory default]

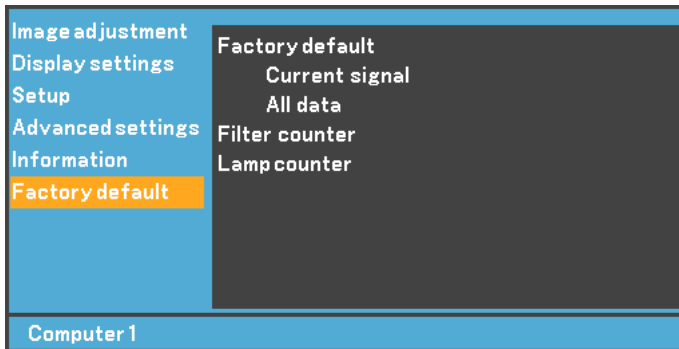

Returning to Factory Default [Factory default]

The Factory default feature allows you to change adjustments and settings to the factory presets.

[Current signal]

Resets the adjustments for the current signal to the factory preset levels.

The items that can be reset are: Brightness, Contrast, Color, Color balance, Sharpness, Noise reduction, Aspect, Horizontal position, Vertical position, Clock, Tracking and Image mode.

[All data]

Resets all the adjustments and settings for all the signals to the factory preset for source except the following: Language, Password, Communication speed, Remaining lamp time, Lamp counter, Filter usage and Projector usage. To reset the lamp and filter usage time, see “Lamp counter” and “Filter counter”.

Resetting the Filter Usage Hours [Filter counter]

Resets the filter usage back to zero. Selecting this option displays submenu for a confirmation. Select “Yes” and press the OK button.

NOTE: Reset the Filter usage after cleaning or replacing the filter.

Clearing Lamp counter [Lamp counter]

Resets the lamp clock back to zero. Selecting this option displays a submenu for a confirmation. Select “Yes” and press the OK button.

NOTE: Do not reset the lamp counter except when you have replaced the lamp. If reset, the lamp counter cannot indicate the correct timing of lamp replacement.

For the lamp replacement method, see page 50.

NOTE: The projector will turn off and go into standby mode after 2100 hours (up to 3100 hours in Quiet mode) of service. If this happens, press the INFO. button on the remote control for ten seconds to reset the lamp clock back to zero.

When the lamp time clock is reset to zero, the LAMP indicator goes out.

Do this only after replacing the lamp.

6. Maintenance

This section describes the simple maintenance procedures you should follow to clean the filter and replace the lamp.

① Cleaning or Replacing the Filter

The air-filter sponge keeps dust and dirt from getting inside the projector and should be cleaned after every 100 hours of operation (more often in dusty conditions). If the filter is dirty or clogged, your projector may overheat.

CAUTION

- Turn off the projector, turn off the main power switch and unplug the projector before replacing the filter.
- Only clean the outside of the filter cover with a vacuum cleaner.
- Do not attempt to operate the projector without the filter cover.

To clean the air-filter:

Vacuum the filter through the filter cover.

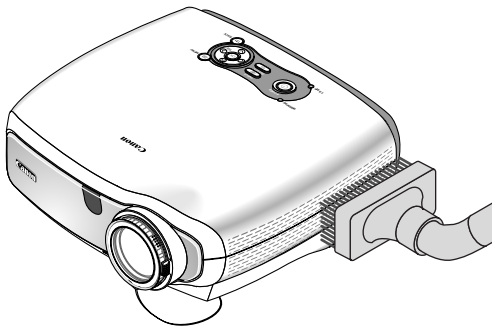

To reset the filter usage time, from the menu, select [Factory default] → [Filter counter]. See also page 47 for resetting the filter usage time.

To replace the filter (sponge):

1. Remove the filter cover by pushing down on the catch of the cover until you feel it detach.

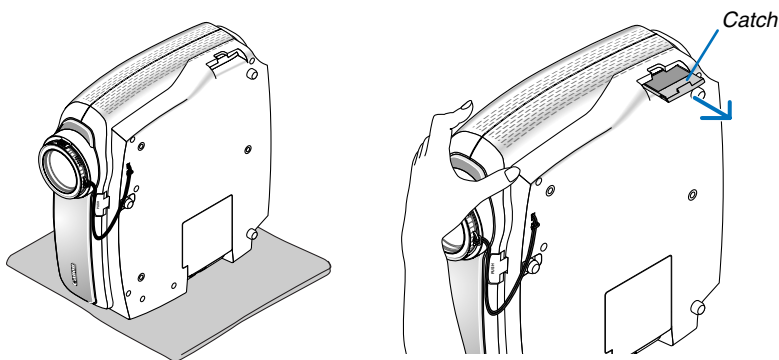

2. Gently peel off the filter (sponge) and replace it with the new one.

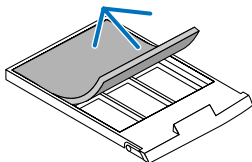

3. Reinstall the new filter cover.

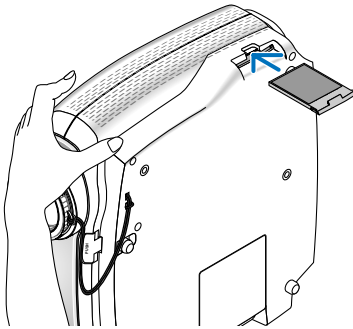

NOTE: Do not wash the filter with soap and water. Soap and water will damage the filter membrane. Before replacing the filter, remove dust and dirt from the projector cabinet. Keep out dust and dirt during filter replacement.

NOTE: When you replace the lamp, it is also wise to replace the filter. The filter comes in the same package with your replacement lamp.

4. Turn on the projector.

5. Reset the Filter counter. See page 47.

② Cleaning the Cabinet and the Lens

1. Turn off the projector before cleaning.
2. Clean the cabinet periodically with a damp cloth. If heavily soiled, use a mild detergent. Never use strong detergents or solvents such as alcohol or thinner.
3. Use a blower or lens paper to clean the lens, and be careful not to scratch or mar the lens.

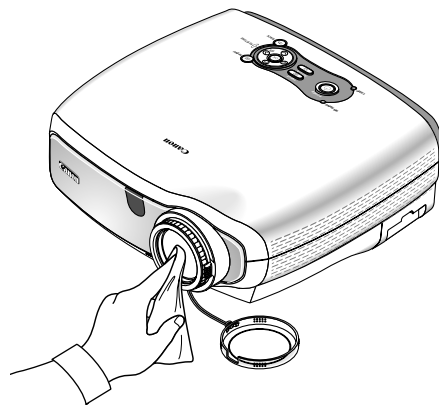
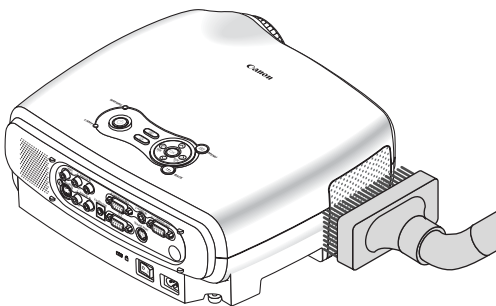

③ Replacing the Lamp

After your lamp has been operating for 2000* hours (up to 3000* hours in Quiet mode) or longer, the LAMP indicator in the cabinet will blink red and the message “**Replace with the new lamp.**” will appear. Even though the lamp may still be working, replace it at 2000* (up to 3000* hours in Quiet mode) hours to maintain optimal projector performance. After replacing the lamp, be sure to clear the lamp counter. See page 47.

CAUTION

- DO NOT TOUCH THE LAMP immediately after it has been used. It will be extremely hot. Turn the projector off, wait 30 seconds, turn off the main power switch and then disconnect the power cord. Allow at least one hour for the lamp to cool before handling.
- DO NOT REMOVE ANY SCREWS except two lamp case screws. You could receive an electric shock.
- Do not break the glass on the lamp housing.
Keep finger prints off the glass surface on the lamp housing. Leaving finger prints in the glass surface might cause an unwanted shadow and poor picture quality.
- The projector will turn off and go into standby mode after 2100* (up to 3100* hours in Quiet mode) hours of service. If this happens, be sure to replace the lamp. If you continue to use the lamp after 2000* hours (up to 3000* hours in Quiet mode) of use, the lamp bulb may shatter, and pieces of glass may be scattered in the lamp case. Do not touch them as the pieces of glass may cause injury. If this happens, contact your dealer for lamp replacement.

**NOTE: The projector will turn off and go into standby mode after 2100 (up to 3100 hours in Quiet mode) hours of service. A lamp may burn out before the LAMP indicator blinks.*

To replace the lamp:

Optional lamp and tools needed for replacement:

- Replacement lamp LV-LP24
- Phillips screwdriver or equivalent

1. Place the projector on a soft cloth and turn it over to access the lamp cover on the bottom.

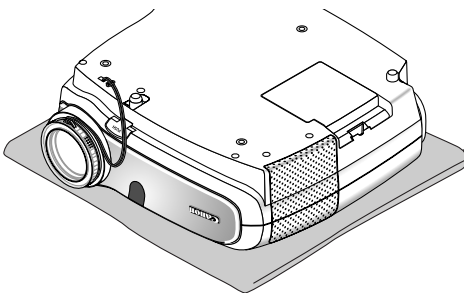

2. Use a Phillips screwdriver to push and release the tab.

Push up and remove the lamp cover.

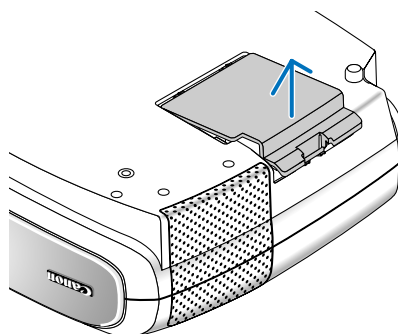
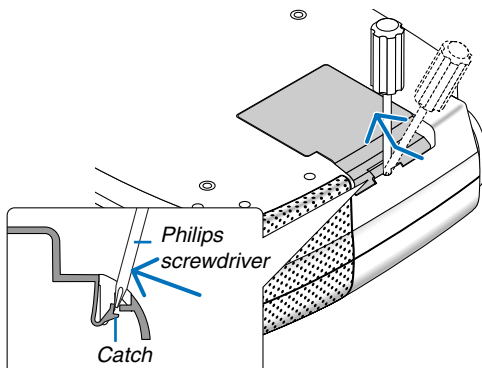

3. Loosen the two screws securing the lamp until the phillips screwdriver goes into a freewheeling condition. The two screws are not removable.

NOTE: Do not remove any screws except these two screws.

Remove the lamp by holding it.

⚠ CAUTION:

DO NOT TOUCH THE LAMP immediately after it has been used. It will be extremely hot. Before handling, turn the projector off, wait until the cooling fans stop, turn off the main power switch, disconnect the power cord and then allow at least 60 minutes for the lamp to cool.

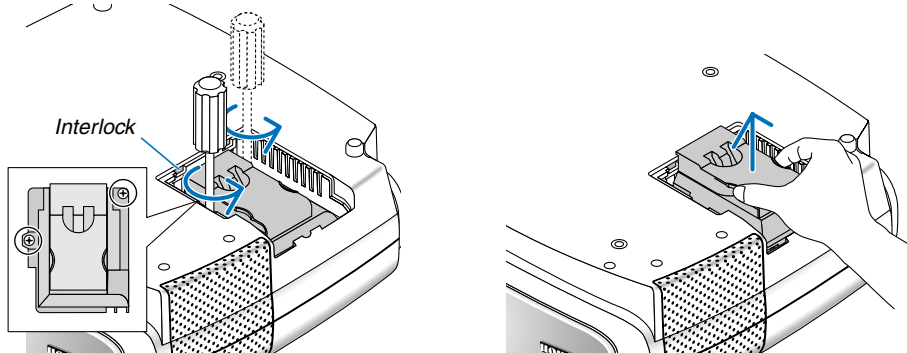

NOTE: There is an interlock on this case to prevent the risk of electrical shock. Do not attempt to circumvent this interlock.

4. Insert a new lamp until the lamp is plugged into the socket.

CAUTION

Do not use a lamp other than the replacement lamp LV-LP24.
This may be ordered from your dealer.

Secure it in place with the two screws.

Be sure to tighten the screws.

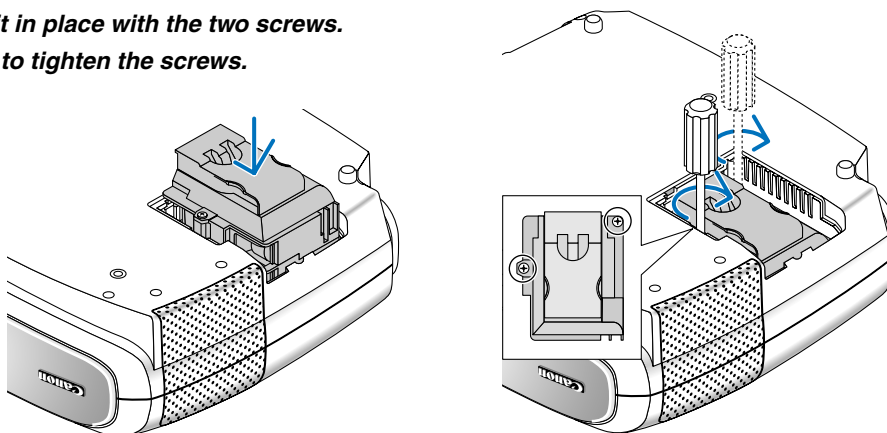

5. Reattach the lamp cover.

Slip the lamp cover back until it snaps into place.

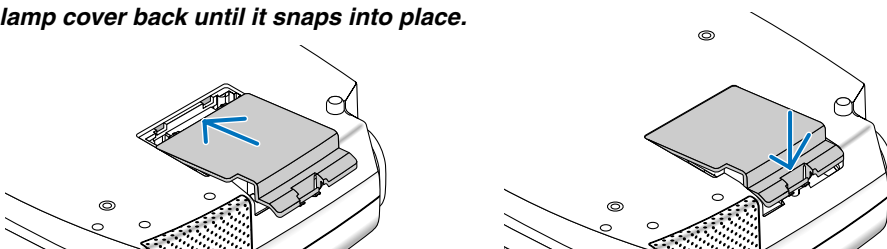

6. Connect the supplied power cord, turn on the Main Power switch and turn on the projector.

7. Finally, select the menu → [Factory default] → [Lamp counter] to reset the lamp usage hours.

NOTE: When the lamp exceeds 2100 hours (up to 3100 hours in Quiet mode) of service, the projector cannot turn on and the menu is not displayed.

If this happens, press the INFO. button on the remote control for ten seconds to reset the lamp clock back to zero.

When the lamp time clock is reset to zero, the LAMP indicator goes out.

7. Appendix

1 Troubleshooting

This section helps you resolve problems you may encounter while setting up or using the projector.

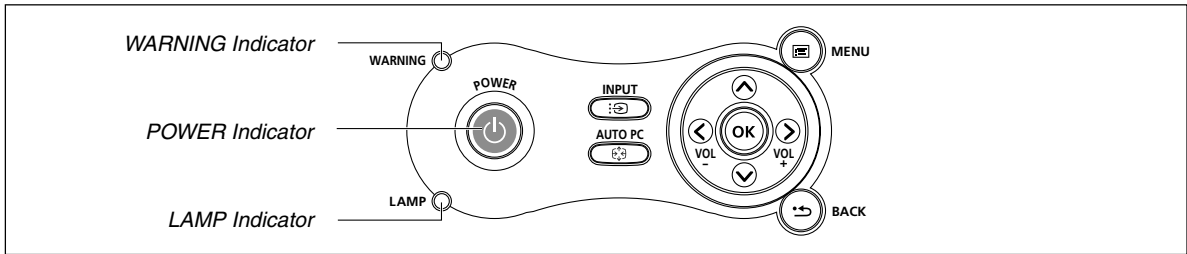

Indicator Messages

POWER Indicator

Indicator Condition			Projector Condition	Note
Off			The main power is off	–
Blinking light	Green	0.5 sec On, 0.5 sec Off	The projector is getting ready to turn on.	Wait for a moment.
		2.5 sec On, 0.5 sec Off	Off Timer is enabled.	–
	Orange	0.5 sec On, 0.5 sec Off	The projector is cooling down.	Wait for a moment.
Steady light	Green		The projector is turned on.	–
	Orange		The projector is in Standby.	–

WARNING Indicator

Indicator Condition			Projector Condition	Note
Off			Normal	–
Blinking light	Red	1 cycle (0.5 sec On, 2.5 sec Off)	Lamp cover error or lamp housing error	Replace the lamp cover or lamp housing correctly.
		2 cycle (0.5 sec On, 0.5 sec Off)	Temperature error	The projector is overheated. Move the projector to a cooler location.
		4 cycle (0.5 sec On, 0.5 sec Off)	Fan error	Fans will not work correctly.
		6 cycle (0.5 sec On, 0.5 sec Off)	Lamp error	Lamp fails to light. Wait a full minute and then turn on again.
	Green		Re-firing the lamp (The projector is cooling down.)	The projector is re-firing. Wait for a moment.
Steady light	Orange		Key lock is On.	You have pressed cabinet button when Key lock is On.

LAMP Indicator

Indicator Condition			Projector Condition	Note
Off			Normal	–
Blinking light	Red		Lamp has reached its end of life. Lamp replacement message will be displayed.	Replace the lamp.
Steady light	Red		Lamp has been used beyond its limit. The projector will not turn on until the lamp is replaced.	Replace the lamp.
	Green		Lamp mode is set to Quiet mode	–

Common Problems & Solutions (See also "POWER/WARNING/LAMP Indicator" on page 53.)

Problem	Check These Items
Does not turn on	<ul style="list-style-type: none"> • Check that the power cord is plugged in and that the power button on the projector cabinet or the remote control is on. See pages 19 and 20. • Ensure that the lamp cover is installed correctly. See page 51. • Check to see if the projector has overheated or the lamp usage exceeds 2100 hours (up to 3100 hours : Quiet mode). If there is insufficient ventilation around the projector or if the room where you're presenting is particularly warm, move the projector to a cooler location. • The lamp may fail to light. Wait a full minute and then turn on the power again. • The lamp has reached the end of its usable life. Replace the lamp.
Will turn off	<ul style="list-style-type: none"> • Ensure that the Power management or Off timer is off. See page 45.
No picture	<ul style="list-style-type: none"> • Use the INPUT button to select your source (Computer 1, Computer 2, Video or S-Video). See page 22. If there is still no picture, press the button again. • Ensure your cables are connected properly. • Use menus to adjust the brightness and contrast. See page 40. • Remove the lens cap. • Reset the settings or adjustments to factory preset levels using the "Factory default" in the Menu. See page 47. • Enter your registered Password if the Password function is enabled. See page 44. • When using with a notebook PC, be sure to connect between the projector and the notebook PC before turning on the power to the notebook PC. In most cases signal cannot be output from RGB output unless the notebook PC is turned on after connecting with the projector. * If the screen goes blank while using your remote control, it may be the result of the computer's screen-saver or power management software. • See also the next page.
Picture suddenly becomes dark	<ul style="list-style-type: none"> • When the room where you're presenting is particularly warm → Move the projector to a cooler location.
Color tone or Color balance is unusual	<ul style="list-style-type: none"> • Check if an appropriate color is selected in "Screen color". If so, select an appropriate option. See page 39. • Adjust "Color balance" in "Image adjustment". See page 40.
Image isn't square to the screen	<ul style="list-style-type: none"> • Reposition the projector to improve its angle to the screen. See page 23. • Use the Keystone correction function to correct the trapezoid distortion. See page 25.
Picture is blurred	<ul style="list-style-type: none"> • Adjust the focus. See page 24. • Reposition the projector to improve its angle to the screen. See page 23. • Ensure that the distance between the projector and screen is within the adjustment range of the lens. See page 12. • Condensation may form on the lens if the projector is cold, brought into a warm place and is then turned on. Should this happen, let the projector stand until there is no condensation on the lens.
Image is scrolling vertically, horizontally or both	<ul style="list-style-type: none"> • Use the INPUT button to select your source (Computer 1, Computer 2, Video or S-Video). See page 22. • Adjust the computer image manually with the Horizontal/Vertical position in the "Advanced settings → Page 2". See page 45.
Remote control does not work	<ul style="list-style-type: none"> • Install new batteries. See page 10. • Make sure there are no obstacles between you and the projector. • Stand within 7 m (22 feet) of the projector. See page 10.
Indicator is lit or blinking	<ul style="list-style-type: none"> • See the POWER/WARNING/LAMP Indicator on page 53.
Cross color in RGB mode	<ul style="list-style-type: none"> • Press the AUTO PC button on the projector cabinet or the remote control. See page 27. • When "Off" is selected in "Auto PC adjustment", adjust the computer image manually with "Clock" and "Tracking" in "Advanced settings" → "Page 2" in the menu. See pages 45 and 46.
Whenever the projector is turned on, a message prompting you to clean the filter will be displayed	<ul style="list-style-type: none"> • Clean or replace the filter and then reset the Filter counter. See page 47.

For more information contact your dealer.

If there is no picture, or the picture is not displayed correctly.

- Power on process for the projector and the PC.

Be sure to connect the RGB cable between the projector and the computer before turning on the computer. There are some notebook PCs, which do not output signal unless there is a projector or monitor connected first.

NOTE: You can check the horizontal frequency of the current signal in the projector's menu under Information. If it reads "0kHz", this means there is no signal being output from the computer. See page 46 or go to next step.

- Enabling the computer's external display.

Displaying an image on the notebook PC's screen does not necessarily mean it outputs a signal to the projector. When using a PC compatible laptop, a combination of function keys will enable/disable the external display. Usually, the combination of the 'Fn' key along with one of the 12 function keys gets the external display to come on or off. For more details, refer to your computer's owner's manual.

- Non-standard signal output from the computer

If the output signal from a notebook PC is not an industry standard, the projected image may not be displayed correctly. Should this happen, deactivate the notebook PC's LCD screen when the projector display is in use. Each notebook PC has a different way of deactivate/reactivate the local LCD screens as described in the previous step. Refer to your computer's documentation for detailed information.

- Image displayed is incorrect when using a Macintosh

When using a Macintosh with the projector, set the DIPswitch of the Mac adapter (not supplied with the projector) according to your resolution. After setting, restart your Macintosh for the changes to take affect.

For setting display modes other than those supported by your Macintosh and the projector, changing the DIP switch on a Mac adapter may bounce an image slightly or may display nothing. Should this happen, set the DIP switch to the 13" fixed mode and then restart your Macintosh. After that, restore the DIP switches to a displayable mode and then restart the Macintosh again.

NOTE: A Video Adapter cable manufactured by Apple Computer is needed for a PowerBook which does not have a mini D-Sub 15-pin connector.

- Mirroring on a PowerBook

- * When using the projector with a Macintosh PowerBook, output may not be set to 1024 x 768 unless "mirroring" is off on your PowerBook. Refer to owner's manual supplied with your Macintosh computer for mirroring.

- Folders or icons are hidden on the Macintosh screen

Folders or icons may not be seen on the screen. Should this happen, select [View] → [Arrange] from the Apple menu and arrange icons.

② Specifications

This section provides technical information about the projector's performance.

Model Number **LV-7255**

Optical

LCD Panel	0.7" p-Si TFT active-matrix with Micro Lens Array (Aspect 4:3)
Resolution	1024 × 768 pixels* native, up to UXGA with scaling technology
Lens	Manual zoom and manual focus F1.6 - 2.5 f=17.7 - 28.3 mm
Lamp	200W DC lamp (150W Quiet mode)
Brightness	2500 lm
Uniformity	85%
Image Size (Diagonal)	25" to 300"
Projection Distance	0.9 m to 7.6 m / 3.1' to 25.0'
Projection Angle	Tele: 1.86° - 1.93°/ Wide: 1.21° - 1.24°
Keystone Correction	+/- 30° Vertical (auto)

Electrical

Inputs	2 RGB/Component (D-Sub 15 Pin), 1 S-Video (DIN 4 Pin), 1 Video (RCA), 2 (L/R) RCA Audio, 1 Stereo Mini Audio, 1 Service Port (Mini DIN 8 Pin)
Outputs	1 RGB (D-Sub 15 Pin), 1 Stereo Mini Audio
Video Compatibility	NTSC, NTSC4.43, PAL, PAL-60, PAL-N, PAL-M, SECAM, 1125i (1080i), 750p (720p), 525p (480p), 525i (480i) / 60Hz 1125i (1080i), 625p (576p), 625i (576i) / 50Hz
Scan Rate	Horizontal: 15 kHz to 100 kHz (RGB: 24 kHz or over) Vertical: 50 Hz to 120 Hz
Video Bandwidth	RGB: 80 MHz (-3dB)
Color Reproduction	16.7 million colors simultaneously, Full color
Horizontal Resolution	NTSC / NTSC4.43/PAL/PAL-M/PAL-N/PAL60/YCbCr: 540 TV lines SECAM: 300 TV lines RGB: 1024 dots (H) × 768 dots (V)
External Control	RS232, IR
Sync Compatibility	Separate Sync / Composite Sync / Sync on G
Built-in Speaker	1W (monaural)
Power Requirement	100 - 240V AC, 50 / 60 Hz
Input Current	3.0 - 1.5A
Power Consumption	8W in Standby mode / 275W in Lamp Normal mode / 210W in Lamp Quiet mode

* Effective pixels are more than 99.99%.

Mechanical

Installation Orientation	Front / Rear / Ceiling mounted / Rear, Ceiling mounted
Dimensions	11.7" (W) × 4.3" (H) × 10.8" (D) / 296mm (W) × 110mm (H) × 273mm (D) (not including protrusions)
Weight	7.3 lbs / 3.3 kg
Fan Noise	35 dB (Normal mode), 30dB (Quiet mode)
Environmental Considerations	Operational Temperatures : 41° to 95°F (5° to 35°C), 20% to 80% humidity (non-condensing) Storage Temperatures : 14° to 122°F (-10° to 50°C), 20% to 80% humidity (non-condensing)
Regulations	<i>For United States:</i> UL Approved (UL 60950-1) Meets FCC Class B requirements <i>For Canada:</i> UL Approved (CSA 60950-1) Meets DOC Canada Class B requirements <i>For Australia/New Zealand:</i> Meets AS/NZS CISPR.22 Class B <i>For Europe:</i> Meets EMC Directive (EN55022, EN55024, EN61000-3-2, EN61000-3-3) Meets Low Voltage Directive (EN60950-1)



The specifications are subject to change without notice.

3 Cabinet Dimensions

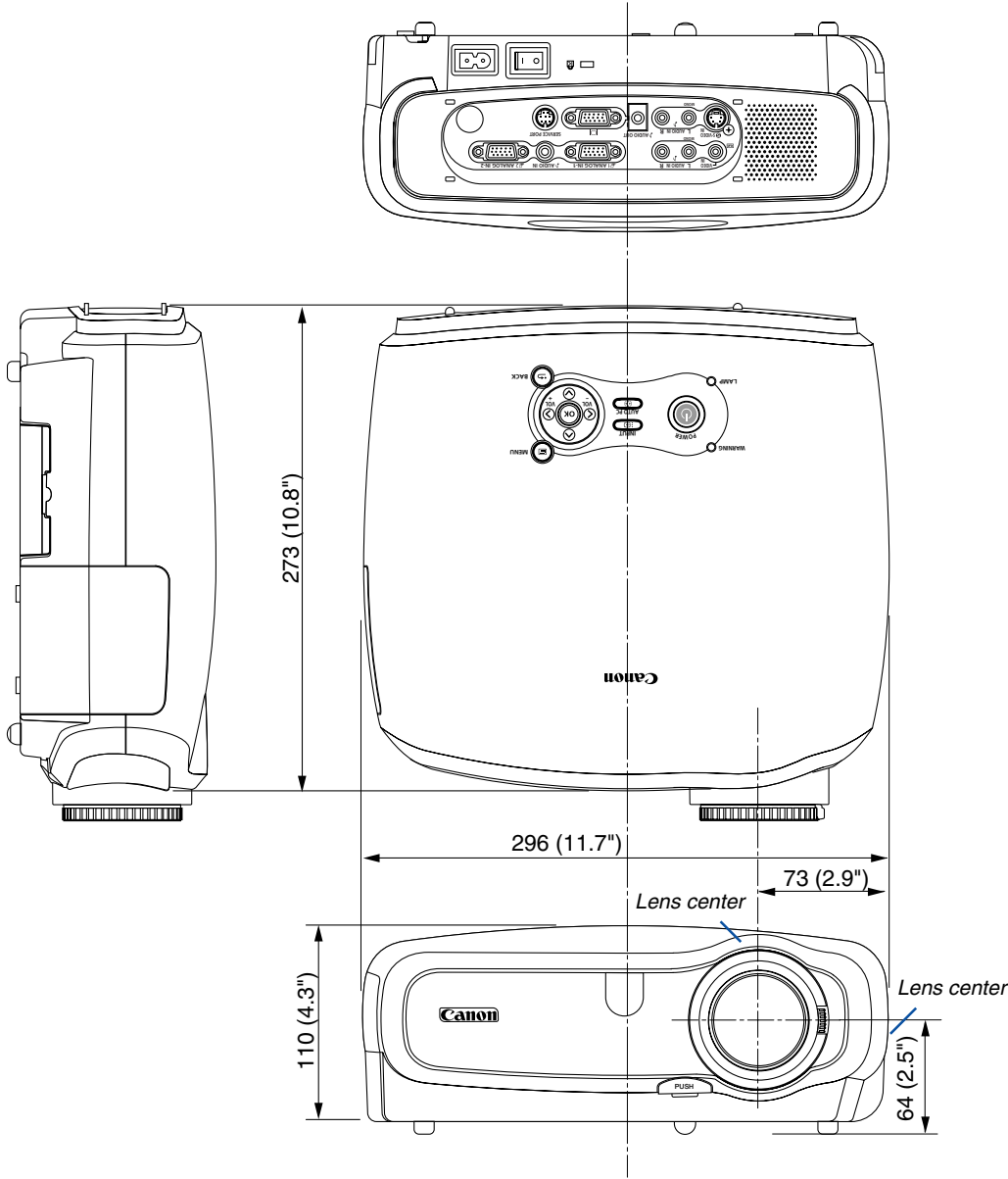

Unit: mm (inch)

④ Pin Assignments of D-Sub ANALOG Input Connector

Mini D-Sub 15 Pin Connector

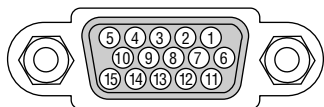

Signal Level

Video signal : 0.7Vp-p (Analog)

Sync signal : TTL level

Pin No.	RGB Signal (Analog)	YCbCr Signal
1	Red	Cr
2	Green or Sync on Green	Y
3	Blue	Cb
4	Ground	
5	Ground	
6	Red Ground	Cr Ground
7	Green Ground	Y Ground
8	Blue Ground	Cb Ground
9	No Connection	
10	Sync Signal Ground	
11	Scart Sync*	
12	Bi-directional DATA (SDA)*	
13	Horizontal Sync or Composite Sync	
14	Vertical Sync	
15	Data Clock*	

* Only ANALOG-1 input connector supported.

5 Compatible Input Signal List

Signal	Resolution (Dots)	Frequency H. (kHz)	Refresh Rate (Hz)
NTSC	–	15.73	60
PAL	–	15.63	50
PAL60	–	15.73	60
SECAM	–	15.63	50
VESA	640 × 480	31.47	59.94
IBM	640 × 480	31.47	60
MAC	640 × 480	34.97	66.67
MAC	640 × 480	35	66.67
VESA	640 × 480	37.86	72.81
VESA	640 × 480	37.5	75
IBM	640 × 480	39.38	75
VESA	640 × 480	43.27	85.01
IBM	720 × 350	31.47	70.09
IBM	720 × 350	39.44	87.85
IBM	720 × 400	39.44	87.85
VESA	800 × 600	35.16	56.25
VESA	800 × 600	37.88	60.32
VESA	800 × 600	48.08	72.19
VESA	800 × 600	46.88	75
VESA	800 × 600	53.67	85.06
MAC	832 × 624	49.73	74.55
VESA	1024 × 768	35.5	43 Interlaced
VESA	1024 × 768	48.36	60
VESA	1024 × 768	56.47	70.07
MAC	1024 × 768	60.24	74.93
VESA	1024 × 768	60.02	75.03
VESA	1024 × 768	68.68	85
# VESA	1152 × 864	67.5	75
# MAC	1152 × 870	68.68	75.06
# SGI	1152 × 900	71.74	76.05
# VESA	1280 × 960	60	60
# VESA	1280 × 1024	63.98	60.02
# MAC	1280 × 1024	69.89	65.18
# VESA	1280 × 1024	79.98	75.03
# VESA	1280 × 1024	91.15	85.02
# SXGA+	1400 × 1050	65.32	59.98
# HDTV (1080p)	1920 × 1080	67.5	60 Progressive
# SDTV(576i)(625i)	–	15.6	50
# SDTV(576p)(625p)	–	31.5	50
# HDTV (1080i)(1125i)	1920 × 1080	33.75	60 Interlace
# HDTV (1080i)(1125i)	1920 × 1080	28.13	50 Interlace
# HDTV (720p)(750p)	1280 × 720	45	60 Progressive
# SDTV (480p)(525p)	–	31.47	59.94 Progressive
# VESA	1600 × 1200	75.0	60
# VESA	1600 × 1200	81.25	65
# VESA	1600 × 1200	87.5	70
# VESA	1600 × 1200	93.75	75
DVD YCbCr	–	15.73	59.94 Interlaced
DVD YCbCr	–	15.63	50 Interlaced

: Images in above flagged with # are compressed with scaling technology.

NOTE: Some composite sync signals may not be displayed correctly.

Signals other than those specified in the table above may not be displayed correctly. If this should happen, change the refresh rate or resolution on your PC. Refer to Display Properties help section of your PC for procedures.

UXGA (1600 x 1200) is supported for separate sync signal only.

⑥ Relationship between Screen Size and Projection distance

Screen size at 4:3 aspect ratio W x D (cm)	Zoomed projection distance		H1	H2	Screen size at 16:9 aspect ratio W x D (cm)
	Max.	Min.			
25" 51 x 38	-	0.9m (3.1')	34cm (1.1')	4cm (0.1')	23" 51 x 29
30" 61 x 46	-	1.1m (3.8')	41cm (1.4')	5cm (0.2')	28" 61 x 34
40" 81 x 61	1.0m (3.2')	1.5m (5.1')	55cm (1.8')	6cm (0.2')	37" 81 x 46
50" 102 x 76	1.2m (4.1')	1.9m (6.4')	69cm (2.3')	8cm (0.3')	46" 102 x 57
60" 122 x 91	1.5m (4.9')	2.3m (7.7')	82cm (2.7')	9cm (0.3')	55" 122 x 69
70" 142 x 107	1.7m (5.8')	2.7m (9.0')	96cm (3.2')	11cm (0.4')	64" 142 x 80
80" 163 x 122	2.0m (6.6')	3.1m (10.3')	110cm (3.6')	12cm (0.4')	73" 163 x 91
90" 183 x 137	2.3m (7.4')	3.5m (11.6')	123cm (4.1')	14cm (0.5')	83" 183 x 103
100" 203 x 152	2.5m (8.3')	3.9m (12.9')	137cm (4.5')	15cm (0.5')	92" 203 x 114
110" 224 x 168	2.8m (9.1')	4.3m (14.2')	151cm (5.0')	17cm (0.6')	101" 224 x 126
120" 244 x 183	3.0m (9.9')	4.7m (15.5')	165cm (5.4')	18cm (0.6')	110" 244 x 137
130" 264 x 198	3.3m (10.8')	5.1m (16.8')	178cm (5.9')	20cm (0.7')	119" 264 x 149
140" 284 x 213	3.5m (11.6')	5.5m (18.1')	192cm (6.3')	21cm (0.7')	129" 284 x 160
150" 305 x 229	3.8m (12.4')	5.9m (19.4')	206cm (6.8')	23cm (0.8')	138" 305 x 171
160" 325 x 244	4.0m (13.3')	6.3m (20.7')	219cm (7.2')	24cm (0.8')	147" 325 x 183
170" 345 x 259	4.3m (14.1')	6.7m (22.0')	233cm (7.7')	26cm (0.9')	156" 345 x 194
176" 358 x 268	4.4m (14.6')	6.9m (22.8')	241cm (8.0')	27cm (0.9')	162" 358 x 201
180" 366 x 274	4.5m (14.9')	7.1m (23.3')	247cm (8.1')	27cm (0.9')	165" 366 x 206
190" 386 x 290	4.8m (15.8')	7.5m (24.6')	261cm (8.6')	29cm (1.0')	174" 386 x 217
200" 406 x 305	5.0m (16.6')	-	274cm (9.1')	31cm (1.0')	184" 406 x 229
210" 427 x 320	5.3m (17.5')	-	288cm (9.5')	32cm (1.1')	193" 427 x 240
220" 447 x 335	5.5m (18.3')	-	302cm (10.0')	34cm (1.1')	202" 447 x 251
230" 467 x 351	5.8m (19.1')	-	315cm (10.4')	35cm (1.2')	211" 467 x 263
240" 488 x 366	6.0m (20.0')	-	329cm (10.9')	37cm (1.2')	220" 488 x 274
250" 508 x 381	6.3m (20.8')	-	343cm (11.3')	38cm (1.3')	229" 508 x 286
260" 528 x 396	6.6m (21.6')	-	357cm (11.8')	40cm (1.3')	239" 528 x 297
270" 549 x 411	6.8m (22.5')	-	370cm (12.2')	41cm (1.4')	248" 549 x 309
280" 569 x 427	7.1m (23.3')	-	384cm (12.7')	43cm (1.4')	257" 569 x 320
290" 589 x 442	7.3m (24.1')	-	398cm (13.1')	44cm (1.5')	266" 589 x 331
300" 610 x 457	7.6m (25.0')	-	411cm (13.6')	46cm (1.5')	275" 610 x 343

7 PC Control Codes and Cable Connection

PC Control Codes

Function	Code Data						
POWER ON	02H	00H	00H	00H	00H	02H	
POWER OFF	02H	01H	00H	00H	00H	03H	
INPUT SELECT COMPUTER-1	02H	03H	00H	00H	02H	01H	09H
INPUT SELECT COMPUTER-2	02H	03H	00H	00H	02H	01H	0AH
INPUT SELECT VIDEO	02H	03H	00H	00H	02H	01H	0EH
INPUT SELECT S-VIDEO	02H	03H	00H	00H	02H	01H	0BH
NO SHOW ON	02H	10H	00H	00H	00H	12H	
NO SHOW OFF	02H	11H	00H	00H	00H	13H	
SOUND MUTE ON	02H	12H	00H	00H	00H	14H	
SOUND MUTE OFF	02H	13H	00H	00H	00H	15H	

NOTE: Contact your local dealer for a full list of the PC Control Codes if needed.

Cable Connection

Communication Protocol

Baud rate 19200 bps
 Data length 8 bits
 Parity No parity
 Stop bit One bit
 X on/off None
 Communications procedure Full duplex

NOTE: Depending on the equipment, a lower baud rate may be recommended for long cable runs.

SERVICE PORT (Mini DIN-8P)

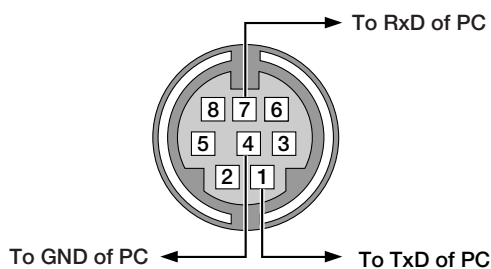

NOTE: Pins 2, 3, 5, 6 and 8 are used inside the projector.

8 Troubleshooting Check List

Before contacting your dealer or service personnel, check the following list to be sure repairs are needed, you may also refer to the "Troubleshooting" section in your user's manual. This checklist below will help us solve your problem more efficiently.

* Print the following pages.

Frequency of occurrence always sometimes (How often? _____) other (_____)

Power

- No power (POWER indicator does not light green) See also "WARNING Indicator (WARNING)".
 - Power cord's plug is fully inserted into the wall outlet.
 - Main power switch is pressed to the ON position.
 - Lamp cover is installed correctly .
 - Lamp counter (lamp operation hours) was cleared after lamp replacement.
 - No power even though you press and hold the POWER button for about 1 second.
- Shut down during operation.
 - Power cord's plug is fully inserted into the wall outlet.
 - Lamp cover is installed correctly .
 - Power Management is turned off (only models with the Power Management function).
 - Sleep Timer is turned off (only models with the Sleep Timer function) .

Video and Audio

- No image is displayed from your PC or video equipment to the projector.
 - Still no image even though you connect the projector to the PC first, then start the PC.
 - Enabling your notebook PC's signal output to the projector.
 - *A combination of function keys will enable/disable the external display. Usually, the combination of the "Fn" key along with one of the 12 function keys turns the external display on or off.*
 - No image (blue background, logo, no display).
 - Still no image even though you press the AUTO PC button.
 - Still no image even though you carry out "Factory default" in the projector's menu.
 - Signal cable's plug is fully inserted into the input connector
 - A message appears on the screen.
(_____)
 - The source connected to the projector is active and available.
 - Still no image even though you adjust the brightness and/or the contrast.
 - Input source's resolution and frequency are supported by the projector.
- Image is too dark.
 - Remains unchanged even though you adjust the brightness and/or the contrast.
- Image is distorted.
 - Image appears to be trapezoidal (unchanged even though you carry out the "Keystone adjustment").
- Parts of the image are lost.
 - Still unchanged even though you press the AUTO PC button.
 - Still unchanged even though you carry out "Factory default" in the projector's menu.
- Image is shifted in the vertical or horizontal direction.
 - Horizontal and vertical positions are correctly adjusted on a computer signal.
 - Input source's resolution and frequency are supported by the projector.
 - Some pixels are lost.
- Image is flickering.
 - Still unchanged even though you press the AUTO PC button.
 - Still unchanged even though you carry out "Factory default" in the projector's menu.
 - Image shows flickering or color drift on a computer signal.
- Image appears blurry or out of focus.
 - Still unchanged even though you checked the signal's resolution on PC and changed it to projector's native resolution.
 - Still unchanged even though you adjusted the focus.
- No sound.
 - Audio cable is correctly connected to the audio input of the projector.
 - Still unchanged even though you adjusted the volume level.
 - AUDIO OUT is connected to your audio equipment (only models with the AUDIO OUT connector).

Other

- Remote control does not work.
 - No obstacles between the sensor of the projector and the remote control.
 - Projector is placed near a fluorescent light that can disturb the infrared remote controls.
 - One or more remote sensors are enabled (only models with the Remote Sensor Selection function).
 - Batteries are new and are not reversed in installation.
 - If present on the remote control, projector selector switch is not used.
- Buttons on the projector cabinet do not work (only models with the Key lock function).
 - Key lock is not turned on or is disabled in the menu.
 - Still unchanged even though you press and hold the BACK button for a minimum of 10 seconds.

In the space below please describe your problem in detail.

Information on application and environment where your projector is used

Projector

Model number:

Serial No.:

Date of purchase:

Lamp operating time (hours):

Lamp Mode: Normal Quiet

Information on input signal:

Horizontal sync frequency [] kHz

Vertical sync frequency [] Hz

Sync polarity H (+) (-)

V (+) (-)

Sync type Separate Composite

Sync on Green

WARNING Indicator:

Steady light Orange Green

Flashing light [] cycles

Remote control model number:

Installation environment

Screen size: inch

Screen type: White matte Beads Polarization

Wide angle High contrast

Throw distance: feet/inch/m

Orientation: Ceiling mount Desktop

Power outlet connection:

Connected directly to wall outlet

Connected to power cord extender or other (the number of connected equipment _____)

Connected to a power cord reel or other (the number of connected equipment _____)

Computer

Manufacturer:

Model number:

Notebook PC / Desktop

Native resolution:

Refresh rate:

Video adapter:

Other:

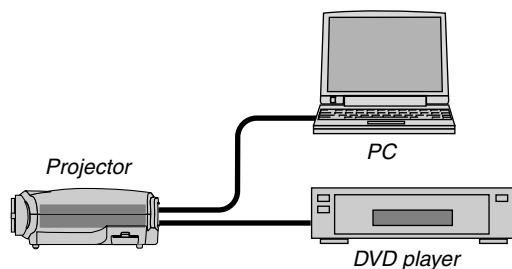

Signal cable

Canon standard or other manufacturer's cable?

Model number: Length: inch/m

Distribution amplifier

Model number:

Switcher

Model number:

Adapter

Model number:

Video equipment

VCR, DVD player, Video camera, Video game or other

Manufacturer:

Model number:

Canon

CANON INC. 30- 2, Shimomaruko 3- chome, Ohta- ku, Tokyo 146- 8501, Japan

CANON U. S. A., INC.

One Canon Plaza, Lake Success, NY 11042, U. S. A.

CANON CANADA, INC.

6390 Dixie Road Mississauga, Ontario L5T 1P7 Canada

CANON LATIN AMERICA, INC.

703 Waterford Way Suite 400 Miami, Florida 33126 U. S. A.

CANON MEXICANA, S. de R. L. de C. V.

Boulevard Manuel Avila Camacho, No. 138 PB, Pisos 15, 16 y 17 Col. Lomas de Chapultepec, CP 11000, Mexico D. F., Mexico

CANON EUROPA N. V.

P. O. Box 2262, 1180 EG Amstelveen, The Netherlands

CANON COMMUNICATION & IMAGE FRANCE

12 Rue De L'Industrie, 92414 Corbevoie, Cedex, France

CANON (UK) LTD.

Woodhatch, Reigate, Surrey RH2 8BF, United Kingdom

CANON DEUTSCHLAND GmbH

Europark Fichtenhain A 10, 47807 Krefeld, Germany

CANON ITALIA S. p. A.

Via Milano, 8 San Donato M. se-20097 (MI), Italy

CANON (Schweiz) A. G.

Industriestrasse 12, 8305 Dietlikon, Switzerland

CANON BELGIUM N. V./ S. A

Bessenveldstraat 7, 1831 Diegem, Belgium

CANON GmbH

Zetschegasse 11, A- 1230 Wien, Austria

CANON ESPANA S. A.

C/ Joaquin Costa 41, 28002 Madrid, Spain

CANON SVENSKA AB

Gustav III:s, Boulevard 26, 169 88 Solna, Sweden

CANON NORGE A/ S

Hallagerbakken 110, P. O. Box 33, Holmlia, N-1201 Oslo, Norway

CANON OY

Huopalahdentie 24, P. O. Box 1, FIN- 00351 Helsinki, Finland

CANON HONGKONG CO., LTD.

19/F., The Metropolis Tower, 10 Metropolis Drive, Hunghom, Kln., H. K.

CANON SINGAPORE PTE. LTD.

1 HarbourFront Avenue #04-01, Keppel Bay Tower Singapore 098632

CANON AUSTRALIA PTY. LTD.

1 Thomas Holt Drive, North Ryde, Sydney, N. S. W. 2113, Australia

CANON NEW ZEALAND LTD.

Akoranga Business Park, Akoranga Drive, Northcote, Auckland, New Zealand

CANON DANMARK A/ S

Knud Hoejgaards Vej 1, DK- 2860 Soeborg, Denmark

Free Manuals Download Website

<http://myh66.com>

<http://usermanuals.us>

<http://www.somanuals.com>

<http://www.4manuals.cc>

<http://www.manual-lib.com>

<http://www.404manual.com>

<http://www.luxmanual.com>

<http://aubethermostatmanual.com>

Golf course search by state

<http://golfingnear.com>

Email search by domain

<http://emailbydomain.com>

Auto manuals search

<http://auto.somanuals.com>

TV manuals search

<http://tv.somanuals.com>