



MULTIMEDIA PROJECTOR

LV-7292A

LV-7297A

LV-7392A

LV-8227A

LV-7292M

LV-7297M

LV-8227M

User's Manual



Features and Design

This Multimedia Projector is designed with the most advanced technology for portability, durability, and ease of use. This projector utilizes built-in multimedia features, a palette of 16.77 million colors, and matrix liquid crystal display (LCD) technology.

◆ **Compact Design**

This projector is designed compact in size and weight. It is easy to carry and installed anywhere you wish to use.

◆ **Simple Computer System Setting**

The projector has the Multi-scan system to conform to almost all computer output signals quickly (p.31). Up to WUXGA resolution can be accepted.

◆ **Useful Functions for Presentations**

- The digital zoom function allows you to focus on the crucial information during a presentation (pp.38,40)
- The MIC function and audio output allow you to make a presentation without any external audio equipment (p.27).

◆ **Lamp mode**

Brightness of the projection lamp can be selected (pp.28, 59).

◆ **Direct Power Off Function**

With the Direct Power Off function, you can disconnect the power cord from the wall outlet or turn off the breaker even during projection (p.23).

◆ **Logo Function**

The Logo function allows you to customize the screen logo (pp.53-55). You can capture an image for the screen logo and use it for the starting-up display or between presentations.

◆ **Multilanguage Menu Display**

Operation menu is available in 20 languages: English, German, French, Italian, Spanish, Portuguese, Dutch, Swedish, Finnish, Polish, Hungarian, Romanian, Russian, Turkish, Kazakh, Vietnamese, Chinese, Korean, Japanese and Thai (p.51).

◆ **Security Function**

The Security function helps you to ensure security of the projector. With the Key lock function, you can lock the operation on the top control or remote control unit (p.60). PIN code lock function prevents unauthorized use of the projector (pp.22, 60-61).

◆ **Helpful Maintenance Functions**

Lamp and filter maintenance functions provide for better and proper maintenance of the projector.

◆ **LAN Network Function**

This projector is loaded with the Wired LAN network function. You can operate and manage the projector via network. For details, refer to the user's manual of "Network Set-up and Operation."
(LAN Network function is only for LV-7292A, LV-7297A, LV-7392A, LV-8227A.)

◆ **Auto Setup Function**

This function enables Auto input, Auto Keystone correction and Auto PC adjustment by simple pressing the AUTO SET button on the top control (p.52).

◆ **Colorboard Function**

At the time of simple projection on the colored wall, you can get the close color image to the color image projected on a white screen by selecting the similar color to the wall color from the preset four colors.

◆ **Power Management Mode**

The Power management mode function reduces power consumption and maintains the lamp life (p.56).

◆ **Closed Caption**

This is a printed version of the program sound or other information displayed on the screen. You can turn on the feature and switch the channels. (p.58)

Table of Contents

Features and Design	2	Image Mode Selection	35
Table of Contents	3	Image Adjustment	36
To the Owner	4	Aspect Setting (For LV-7292A, LV-7297A, LV-7392A, LV-7292M, LV-7297M)	37
Safety Instructions	5	Aspect Setting (For LV-8227A, LV-8227M)	39
Air Circulation	8	VIDEO Input	41
Installing the Projector in Proper Position	8	Input Source Selection (VIDEO, S-VIDEO)	41
Moving the Projector	8	Input Source Selection (COMPONENT, SCART, HDMI)	42
Compliance	9	VIDEO System Selection	43
Part Names and Functions	10	Image Mode Selection	44
Front	10	Image Adjustment	45
Back	10	Aspect Setting (For LV-7292A, LV-7297A, LV-7392A, LV-7292M, LV-7297M)	47
Bottom	10	Aspect Setting (For LV-8227A, LV-8227M)	49
Rear Terminal	11	Setting	51
Top Control	12	Setting	51
Remote Control Unit	13	Information	64
Remote Control Unit Battery Installation	14	Input Source Information Display	64
Remote Control Unit Operating Range	14	Maintenance and Cleaning	65
Remote Control Code	14	WARNING indicator	65
Installation	15	Replacing the Filter	66
Positioning the Projector	15	Resetting the Filter Counter	66
Project vertically to the screen	16	Attaching the Lens Cap	67
Adjust of the Height and the		Cleaning the Projection Lens	67
Incline angle of the projected image	16	Cleaning the Projector Cabinet	67
Connecting to a Computer	17	Lamp Replacement	68
Connecting to VIDEO Equipment	18	Appendix	70
Connecting to COMPONENT VIDEO and SCART Equipment	19	Troubleshooting	70
Using the ferrite core	20	Menu Tree	73
Connecting the AC Power Cord	20	Indicators and Projector Condition	75
Basic Operation	21	Compatible Computer Specifications	76
Turning On the Projector	21	Technical Specifications	78
Turning Off the Projector	23	Optional Parts	79
How to Operate the On-Screen Menu	24	PJ Link Notice (Only for LV-7292A, LV-7297A, LV-7392A, LV-8227A)	80
Main Menu	25	Attaching the Filter Cover to the Projector	80
Zoom and Focus Adjustment	26	Configurations of Terminals	81
Auto Setup Function	26	PIN Code Protection	82
Keystone Correction	26	Dimensions	83
Sound Adjustment	27		
Remote control unit Operation	28		
Computer Input	30		
Input Source Selection (ANALOG PC: COMPUTER)	30		
Computer System Selection	31		
Auto PC Adjustment	32		
Manual PC Adjustment	33		

Trademarks

Each name of corporations or products in this book is either a registered trademark or a trademark of its respective corporation.

To the Owner

Before installing and operating this projector, read this manual thoroughly.

This projector provides many convenient features and functions.

Operating the projector properly enables you to manage those features and maintains it in good condition for many years to come. Improper operation may result in not only shortening the product-life, but also malfunctions, fire hazard, or other accidents.

If your projector seems to operate improperly, read this manual again, check operations and cable connections and try the solutions in the "Troubleshooting" section on pages 70-72 of this manual. If the problem still persists, contact the dealer where you purchased the projector or the service center.

	CAUTION RISK OF ELECTRIC SHOCK DO NOT OPEN	
CAUTION: TO REDUCE THE RISK OF ELECTRIC SHOCK, DO NOT REMOVE COVER (OR BACK). NO USER-SERVICEABLE PARTS INSIDE EXCEPT LAMP REPLACEMENT. REFER SERVICING TO QUALIFIED SERVICE PERSONNEL.		
	THIS SYMBOL INDICATES THAT DANGEROUS VOLTAGE CONSTITUTING A RISK OF ELECTRIC SHOCK IS PRESENT WITHIN THIS UNIT.	
	THIS SYMBOL INDICATES THAT THERE ARE IMPORTANT OPERATING AND MAINTENANCE INSTRUCTIONS IN THE USER'S MANUAL WITH THIS UNIT.	

CAUTION
Not for use in a computer room as defined in the Standard for the Protection of Electronic Computer/Data Processing Equipment, ANSI/NFPA 75.

NOTE FOR CUSTOMERS IN THE US  LAMP(S) INSIDE THIS PRODUCT CONTAIN MERCURY AND MUST BE RECYCLED OR DISPOSED OF ACCORDING TO LOCAL, STATE OR FEDERAL LAWS.
--

READ AND KEEP THIS USER'S MANUAL FOR LATER USE.



Safety Precaution

WARNING:

- **THIS APPARATUS MUST BE EARTHED.**
- **TO REDUCE THE RISK OF FIRE OR ELECTRIC SHOCK, DO NOT EXPOSE THIS APPLIANCE TO RAIN OR MOISTURE.**

- This projector produces intense light from the projection lens. Do not stare directly into the lens, otherwise eye damage could result. Be especially careful that children do not stare directly into the beam.
- Install the projector in a proper position. Improper positioning may reduce the lamp life and result in severe accident or fire hazard.
- Allowing the proper amount of space on the top, sides, and rear of the projector cabinet is critical for proper air circulation and cooling of the unit. The dimension shown here indicate the minimum space required. If the projector is to be built into a compartment or similarly enclosed, these minimum distances must be maintained.

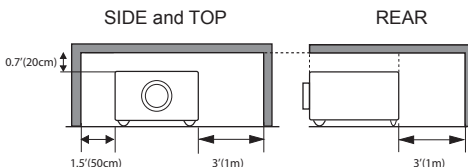

- Do not cover the ventilation slot on the projector. Heat build-up can reduce the service life of your projector, and can also be dangerous.
- If the projector is unused for an extended time, unplug the projector from the power outlet.
- Do not project the same image for a long time. The afterimage may remain on the LCD panels by the characteristic of panel.

DO NOT SET THE PROJECTOR IN GREASY, WET, OR SMOKY CONDITIONS SUCH AS IN A KITCHEN TO PREVENT A BREAKDOWN OR A DISASTER. IF THE PROJECTOR COMES IN CONTACT WITH OIL OR CHEMICALS, IT MAY BECOME DETERIORATED.

Safety Instructions

All the safety and operating instructions should be read before the product is operated.

Read all of the instructions given here and retain them for later use. Unplug this projector from AC power supply before cleaning. Do not use liquid or aerosol cleaners. Use a damp cloth for cleaning.

Follow all warnings and instructions marked on the projector.

For added protection to the projector during a lightning storm, or when it is left unattended and unused for long periods of time, unplug it from the wall outlet. This will prevent damage due to lightning and power line surges.

Do not expose this unit to rain or use near water... for example, in a wet basement, near a swimming pool, etc...

Do not use attachments not recommended by the manufacturer as they may cause hazards.

Do not place this projector on an unstable cart, stand, or table. The projector may fall, causing serious injury to a child or adult, and serious damage to the projector. Use only with a cart or stand recommended by the manufacturer, or sold with the projector. Wall or shelf mounting should follow the manufacturer's instructions, and should use a mounting kit approved by the manufacturers.

An appliance and cart combination should be moved with care. Quick stops, excessive force, and uneven surfaces may cause the appliance and cart combination to overturn.



Slots and openings in the back and bottom of the cabinet are provided for ventilation, to ensure reliable operation of the equipment and to protect it from overheating.

The openings should never be covered with cloth or other materials, and the bottom opening should not be blocked by placing the projector on a bed, sofa, rug, or other similar surface. This projector should never be placed near or over a radiator or heat register.

This projector should not be placed in a built-in installation such as a book case unless proper ventilation is provided.

Never push objects of any kind into this projector through cabinet slots as they may touch dangerous voltage points or short out parts that could result in a fire or electric shock. Never spill liquid of any kind on the projector.

Do not install the projector near the ventilation duct of air-conditioning equipment.

This projector should be operated only from the type of power source indicated on the marking label. If you are not sure of the type of power supplied, consult your authorized dealer or local power company.

Do not overload wall outlets and extension cords as this can result in fire or electric shock. Do not allow anything to rest on the power cord. Do not locate this projector where the cord may be damaged by persons walking on it.

Do not attempt to service this projector yourself as opening or removing Covers may expose you to dangerous voltage or other hazards. Refer all servicing to qualified service personnel.

Unplug this projector from wall outlet and refer servicing to qualified service personnel under the following conditions:

- a. When the power cord or plug is damaged or frayed.
- b. If liquid has been spilled into the projector.
- c. If the projector has been exposed to rain or water.
- d. If the projector does not operate normally by following the operating instructions. Adjust only those controls that are covered by the operating instructions as improper adjustment of other controls may result in damage and will often require extensive work by a qualified technician to restore the projector to normal operation.
- e. If the projector has been dropped or the cabinet has been damaged.
- f. When the projector exhibits a distinct change in performance-this indicates a need for service.

When replacement parts are required, be sure the service technician has used replacement parts specified by the manufacturer that have the same characteristics as the original part. Unauthorized substitutions may result in fire, electric shock, or injury to persons.

Upon completion of any service or repairs to this projector, ask the service technician to perform routine safety checks to determine that the projector is in safe operating condition.

Safety Instructions

WARNING

Immediately turn the power off, unplug the projector, and contact your dealer under the following conditions, otherwise a fire or an electric shock may result.

- If smoke comes out from it.
- If it emits a strange odor, or makes a strange noise.
- If lamp goes out with a loud bang.
- If water or any other liquid gets into it.
- If metal or foreign objects get inside it.
- If it is knocked down or dropped and the cabinet is broken.

WARNING

Follow the instructions below when using the power cable, otherwise a fire, an electric shock, or injury may result.

- Do not place heavy objects on the power cord or position the power cord under the projector. Doing so may damage the power cord.
- Do not run the power cord under a carpet. As it goes unnoticed, excessive load may be applied on the cord unintentionally.
- Do not modify, bend forcibly, twist, or pull the power cord.
- Do not place the power cord near heat generating equipment or heat it.
- Do not bend, wind, or bind excessively the power cord when using it.
- Be sure to connect the projector to a grounded outlet. Failure to do so may result in an electric shock.
- Do not continue to use a damaged power cord. If the power cord is damaged, take it to your dealer and have it replace.
- Use only the supplied power cord.

WARNING

Follow the instructions below when handling the power plug or connector, otherwise a fire, an electric shock, or injury may result.

- Use the projector within the voltage range specified on the projector (AC 100 V– 240 V).
- Insert the power plug or connector into the power outlet firmly. Do not use a damaged or loosen power plug or connector.
- Be sure to hold the power cord plug or connector when disconnecting it from the power outlet. If the power cord itself is pulled, it may be damaged.
- Do not plug or unplug the power cord with wet hands.
- Disconnect the power cord from the power outlet before cleaning the projector.
- Do not stick metal objects into the electrical contacts of the power plug or connector.

- When an extension cord is necessary, be sure that the total current load of all equipment connected to the extension cord does not exceed the specified rating of the extension cord.
- Periodically unplug the power cord and remove the dust that builds up on the power cord or connector.

WARNING

Follow the instructions below to install or handle the projector. Otherwise, a fire, an electric shock, or injury may result.

- Do not touch the projector, power cord, or cables when lighting begins.
- Do not use the projector in a bathroom or shower room.
- Do not expose the projector to rain, snow, or use near water.
- Do not insert metal objects into the projector through the air vents.
- Do not place the containers with water on the projector.
- Do not install in the locations exposed to oily vapors or smoke (e.g., near a cooking table or humidifier).
- Before moving the projector, turn the power off and disconnect the power cord and all cables.
- Do not put spray cans in front of the exhaust vent. When spray cans are exposed to heat, the pressure in them will increase and explode.
- Do not open nor remove the cabinet. There are high voltage components inside the projector. Contact your dealer for inspection, adjustment, and service.
- Do not attempt to disassemble the projector (including expendable parts) or remote control unit.
- Do not look into the lens while the projector is used. Strong light may hurt your eyes. Be especially careful that small children do not look into the lens.

WARNING

Follow the instructions below when the lamp is replaced or breaks.

- Always unplug the power cord before replacing the lamp.
- When the lamp breaks, shards of glass may scatter in the lamp housing. Contact your dealer for cleaning or inspecting the projector, or replacing the lamp.

WARNING

Follow the instructions below when handling the batteries. Failure to do so may cause explosion, heat generation, a fire, or leakage of the battery fluid.

- Do not heat or disassemble the batteries, or throw them into fire.
- Do not attempt to recharge the batteries.

- Remove the batteries when they have been exhausted or not in use for an extended period of time.
- Be sure to replace both batteries at the same time. Do not mix batteries of different types.
- Insert batteries correctly according to the "+" and "-" markings.
- If a fluid from a battery leaks and comes in contact with your skin, rinse the affected skin thoroughly as soon as possible.

CAUTION

- Do not place heavy objects or step on the projector. Be especially careful that small children do not step on the projector. If not, the projector may drop or break, causing injury.
- Disconnect the power cord from the power outlet if the projector is left unused for a long period of time. Failure to do so may result in a fire.
- Do not bring your hands to the peripheral part of the exhaust vent on the cabinet. This area becomes hot during use. Be especially careful that small children do not touch the area. Failure to do so may result in burn.
- Do not put metal objects in front of or near the exhaust vent. They will become hot while projector is being used.
- Do not place the projector on top of unstable or slanted surfaces. The projector may fall down and cause injury.
- Do not attach the lens cover while the projector is being used or place any objects in front of the lens. Failure to do so may result in a fire.
- A buildup of dust inside the projector can cause a fire or damage. Consult your dealer for cleaning.
- When installing the projector to a ceiling, consult your electrician or dealer. If the projector is not fixed securely, accidents may result.

CAUTION

- Never take out the lamp soon after the projector is used. Let the projector cool for at least 1 hour before taking out the lamp, as burns may result.
- If the lamp replacement icon appears or the LAMP REPLACE indicator lights orange, immediately replace the lamp with a new one. Otherwise, the lamp may burst.
- If the lamp burns out, the gas or dust (containing mercury) inside the lamp may escape from the air vents. Immediately open the windows and ventilate the room. If you inhale the gas or the gas gets into your eyes or mouth, see a doctor at once.
- Dispose of a lamp containing mercury in the same manner as fluorescent lamps according to local regulations.

Precaution During Use

- This projector is a precision machine. Do not subject the projector to strong shocks or vibrations or knock it down. Remove the lens, close the lens mounting hole with the front cover, and retract the adjustable foot before placing the projector into the carrying case. The projector may be damaged if you place it in the case without retracting the adjustable foot.
- Place the projector into the specified case when transporting it by courier or any other transportation service. Consult your dealer for the case.
- Keep space of 1 m or more at the sides of the projector between the intake/exhaust vents and walls. Poor ventilation may cause malfunction.
- Do not install the projector in the locations with heavy dust, high humidity, oily vapors, or cigarette smoke.
A buildup of dust on the optical elements such as lens or mirror may degrade image quality.
- Directly touching the lens may cause poor image quality.
- If the projector is carried from a cold place to a warm place or the room temperature is raised rapidly, condensation may form on the lens and mirror due to the moisture in the atmosphere, resulting in a blurred picture. Wait until condensation evaporates and normal picture is shown.
- Do not install the projector in the locations with great difference in temperature. Doing so may cause malfunction. The ranges of the operating and storage temperatures are as shown below:
Operating temperature: 41°F–95°F [5°C–35°C]
Storage temperature: 10°F–140°F (-10°C–60°C)
- Do not install the projector near high-voltage electric power lines or power sources.
- Do not place the projector on a carpet or bed. The internal temperature will rise, causing malfunction.
- To avoid increase in the internal temperature, do not block the intake/exhaust vents.
- Position the projector at a proper angle. Incorrect positioning may cause troubles and accidents. Do not roll the projector more than 20 degrees from the horizontal.
- Do not place any heat-sensitive objects on the projector.

Safety Instructions

Air Circulation

Openings in the cabinet are provided for ventilation. To ensure reliable operation of the product and to protect it from overheating, these openings must not be blocked or covered.

CAUTION

Hot air is exhausted from the exhaust vent. When using or installing the projector, the following precautions should be taken.

- Do not put any flammable object or spray can near the projector, hot air is exhausted from the ventilation holes.
- Keep the exhaust vent at least 3' (1 m) away from any objects.
- Do not touch a peripheral part of the exhaust vent, especially screws and metallic parts. These areas will become hot while the projector is being used.
- Do not put anything on the cabinet. Objects put on the cabinet will not only get damaged but also may cause fire hazard by heat.
- Make sure that there is no object under the projector to prevent from covering the bottom openings.

Cooling fans are provided to cool down the projector. The fans' running speed is changed according to the temperature inside the projector.

Air Intake Vent (Filter)

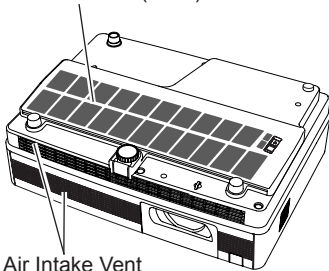

Air Intake Vent

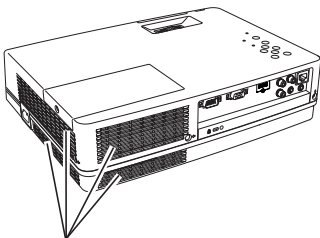

Exhaust Vent
(Hot air exhaust)

Installing the Projector in Proper Position

Install the projector properly. Improper installation may reduce the lamp life and cause a fire hazard.

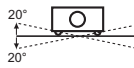

Do not roll the projector more than 20 degrees from side to side.

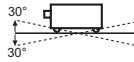

Do not pitch the projector more than 30 degrees from above and below.



Do not point the projector up to project an image.



Do not point the projector down to project an image.



Do not put the projector on either side to project an image.

Moving the Projector

When moving the projector, retract the adjustable foot to prevent damage to the cabinet and use a suitable carrying case. When this projector is not in use for an extended period, put it into a suitable case to protect the projector.

CAUTION IN CARRYING OR TRANSPORTING THE PROJECTOR

- Do not drop or bump the projector, otherwise damages or malfunctions may result.
- When carrying the projector, use a suitable carrying case.
- Do not transport the projector by courier or any other transport service in an unsuitable transport case. This may cause damage to the projector. For information about transporting the projector by courier or any other transport service, consult your dealer.
- Do not put the projector in a case before the projector is cooled enough.

Compliance

Federal Communications Commission Notice

Multimedia Projector, Model: LV-7292A, LV-7297A, LV-7392A, LV-8227A, LV-7292M, LV-7297M, LV-8227M

This device complies with Part 15 of the FCC Rules. Operation is subject to the following two conditions:

- (1) This device may not cause harmful interference, and
- (2) this device must accept any interference received, including interference that may cause undesired operation.

Note: This equipment has been tested and found to comply with the limits for a Class B digital device, pursuant to Part 15 of the FCC Rules. These limits are designed to provide reasonable protection against harmful interference in a residential installation. This equipment generates, uses and can radiate radio frequency energy and, if not installed and used in accordance with the instructions, may cause harmful interference to radio communications. However, there is no guarantee that interference will not occur in a particular installation. If this equipment does cause harmful interference to radio or television reception, which can be determined by turning the equipment off and on, the user is encouraged to try to correct the interference by one or more of the following measures:

- Reorient or relocate the receiving antenna.
- Increase the separation between the equipment and receiver.
- Connect the equipment into an outlet on a circuit different from that to which the receiver is connected.
- Consult the dealer or an experienced radio/TV technician for help.

Use of shielded cable is required to comply with class B limits in Subpart B of Part 15 of FCC Rules.

Do not make any changes or modifications to the equipment unless otherwise specified in the instructions. If such changes or modifications should be made, you could be required to stop operation of the equipment.

Canon U.S.A., Inc.
One Canon Plaza, Lake Success, NY 11042-1198, U.S.A.
Tel No. (516)328-5600

Canadian Radio Interference Regulations

This Class B digital apparatus complies with Canadian ICES-003.

AC POWER CORD REQUIREMENT

The AC Power Cord supplied with this projector meets the requirement for use in the country you purchased it.

AC Power Cord for the United States and Canada:

AC Power Cord used in the United States and Canada is listed by the Underwriters Laboratories (UL) and certified by the Canadian Standard Association (CSA).

AC Power Cord has a grounding-type AC line plug. This is a safety feature to be sure that the plug will fit into the power outlet. Do not try to defeat this safety feature. Should you be unable to insert the plug into the outlet, contact your electrician.



THE SOCKET-OUTLET SHOULD BE INSTALLED NEAR THE EQUIPMENT AND EASILY ACCESSIBLE.



European Union (and EEA) only.

These symbols indicate that this product is not to be disposed of with your household waste, according to the WEEE Directive (2002/96/EC), the Battery Directive (2006/66/EC) and/or your national laws implementing those Directives.



If a chemical symbol is printed beneath the symbol shown above, in accordance with the Battery Directive, this indicates that a heavy metal (Hg = Mercury, Cd = Cadmium, Pb = Lead) is present in this battery or accumulator at a concentration above an applicable threshold specified in the Battery Directive.



This product should be handed over to a designated collection point, e.g., on an authorized one-for-one basis when you buy a new similar product or to an authorized collection site for recycling waste electrical and electronic equipment (EEE) and batteries and accumulators. Improper handling of this type of waste could have a possible impact on the environment and human health due to potentially hazardous substances that are generally associated with EEE. Your cooperation in the correct disposal of this product will contribute to the effective usage of natural resources.

For more information about the recycling of this product, please contact your local city office, waste authority, approved scheme or your household waste disposal service or visit

www.canon-europe.com/environment.

(EEA: Norway, Iceland and Liechtenstein)

Part Names and Functions

Front

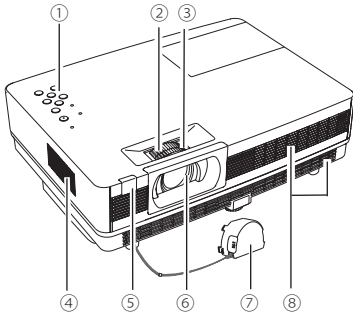

- ① Top controls and Indicators
- ② Zoom Ring
- ③ Focus Ring
- ④ Speaker
- ⑤ Infrared Remote Receiver
- ⑥ Projection Lens
- ⑦ Lens Cap
(See page 67 for attaching.)

⚠ CAUTION

Do not turn on a projector with lens cap attached. High temperature from light beam may damage lens cap and result in fire hazard.

- ⑧ Air Intake Vent

⚠ CAUTION

Internal fan is equipped in this projector, do not block the Air Intake Vent, otherwise it may cause a fire.

Back

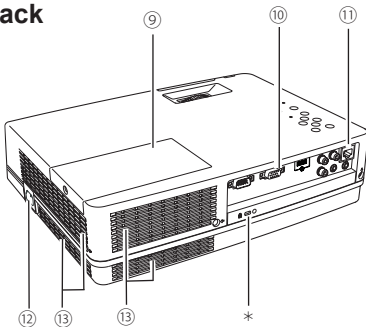

- ⑨ Lamp Cover
- ⑩ Terminals and Connectors
- ⑪ LAN Connection Terminal
(LAN Connection Terminal is only for LV-7292A, LV-7297A, LV-7392A, LV-8227A.)

✓ Note:

LAN Connection Terminal is for the Network function. Refer to the user's manual of "Network Set-up and Operation".

- ⑫ Power Cord Connector

✓ Note:

Replace only with the same types of the supplied cords or cables. Using improper cords or cables may cause an electric shock or a fire.

Bottom

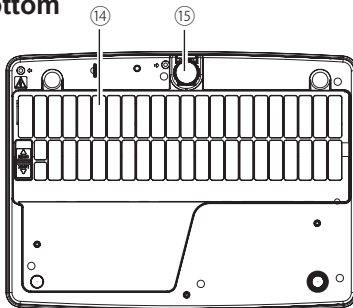

- ⑬ Exhaust Vents

⚠ CAUTION

Hot air is exhausted from the exhaust vent. Do not put heat-sensitive objects near this side.

- ⑭ Air Intake Vent (Filter)
- ⑮ Adjustable Foot

* Kensington Security Slot

This slot is for a Kensington lock used to deter theft of the projector.

*Kensington is a registered trademark of ACCO Brands Corporation.

Rear Terminal

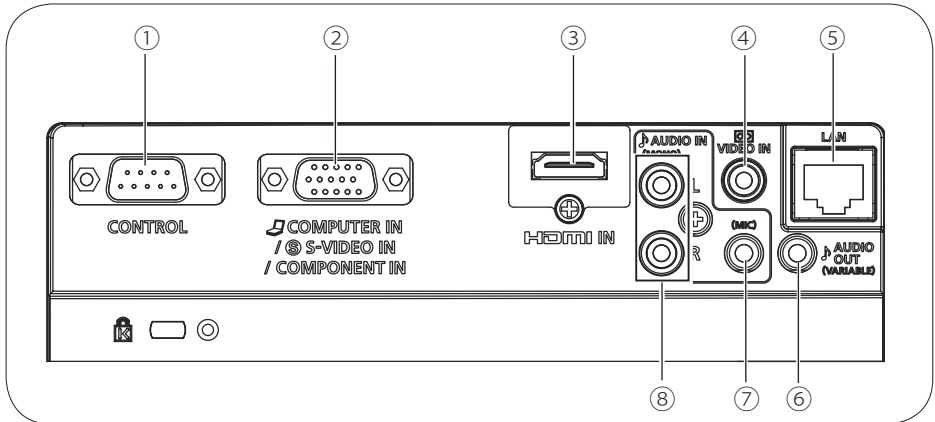

- ① **CONTROL**
When the projector is controlled by a computer, connect to this jack with serial control cable.
 - ② **COMPUTER IN/S-VIDEO IN / COMPONENT IN**
Connect output signal from a computer, component video output, RGB scart 21-pin video output or S-VIDEO output to this terminal (pp.17-19).
 - ③ **HDMI IN Terminal**
Connect the HDMI signal (including sound signal) from the HDMI equipment or from computer to this terminal (p.17-18). HDMI, the HDMI logo and High Definition Multimedia Interface are trademarks or registered trademarks of HDMI Licensing, LLC.
 - ④ **VIDEO IN**
Connect the composite video output signal to this jack (p.18).
 - ⑤ **LAN Connection Terminal**
Connect the LAN cable (refer to the user's manual of "Network Set-up and Operation"). (LAN Connection Terminal is only for LV-7292A, LV-7297A, LV-7392A, LV-8227A.)
 - ⑥ **AUDIO OUT (VARIABLE)**
Connect an external audio amplifier to this jack (pp.17-19). This terminal outputs sound from AUDIO IN terminal ⑦ or ⑧, or HDMI terminal ③ (digital audio). Never plug headphones and earphones into AUDIO OUT jack.
 - ⑦ **AUDIO IN (PC/MIC)**
Connect the audio output signal from computer or video equipment connected to ② to this jack. Or connect the MIC to this jack (pp.17-19).
 - ⑧ **AUDIO IN (L/R)**
Connect the audio output signal from video equipment connected to ④ to this jack. For a mono audio signal (a single audio jack), connect it to L(MONO) jack (p.18).
- ✓ **Note:**
When using AUDIO IN(PC/MIC) terminal as MIC input, these terminals can be used for PC audio input.

Part Names and Functions

Top Control

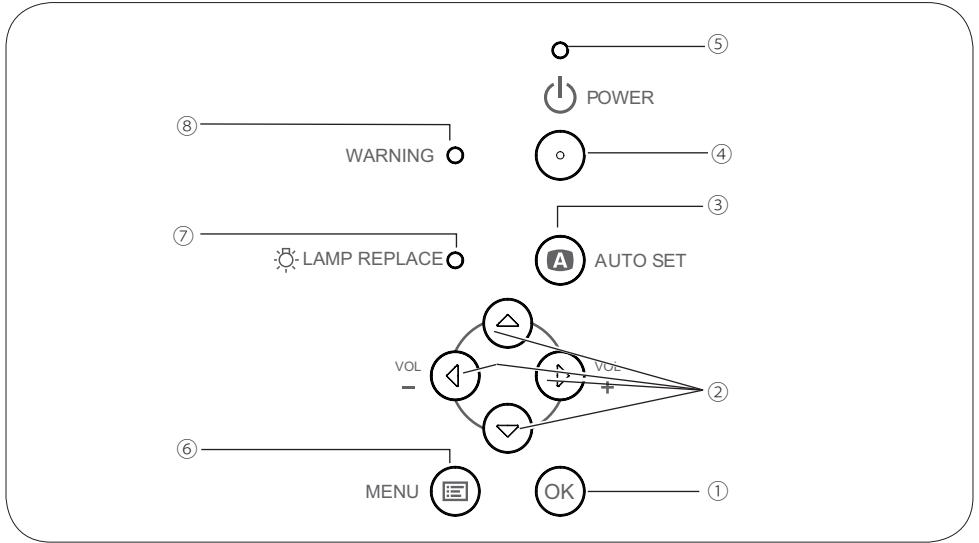

① OK button

- Execute the selected item (p.24).
- Zoom in or out the image in the Digital zoom mode (pp.38, 40).

② POINT ▲ ▼ ◀ ▶ (VOLUME -/+) buttons

- Select an item or adjust the value in the On-Screen Menu (p.24).
- Pan the image in the Digital zoom +/- mode (pp.38, 40).
- Adjust the volume level (Point ◀ ▶ buttons) (p.27).

③ AUTO SET button

- Execute the setting of Auto setup (includes Auto input, Auto PC and Auto Keystone functions) in the setting menu (pp.26, 52).

④ POWER button

- Turn the projector on or off (pp.21-23).

⑤ POWER indicator

- Lights red when the projector is in stand-by mode.
- Lights green during operations.
- Blinks green in the Power management mode (p.56).

⑥ MENU button

- Open or close the On-Screen Menu (p.24).

⑦ LAMP REPLACE indicator

- Lights yellow when the projection lamp reaches its end of life (pp.68, 75).

⑧ WARNING indicator

- Lights red when the projector detects an abnormal condition.
- Blinks red when the internal temperature of the projector exceeds the operating range (pp.65, 75).

Remote Control Unit

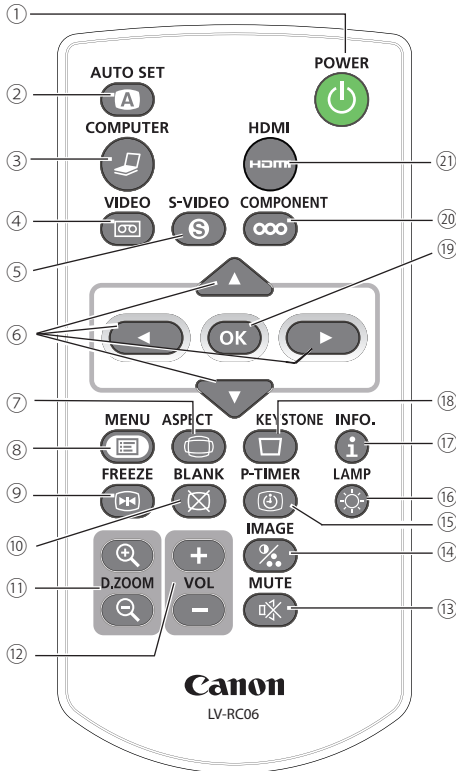

- ① **POWER button**
Turn the projector on or off. (pp.21-23)
- ② **AUTO SET button**
Execute the setting of Auto setup (includes Auto input, Auto PC and Auto Keystone functions) in the setting menu. (pp.26, 52)
- ③ **COMPUTER button**
Select the COMPUTER input source. (pp.30, 42)

✓ **Note:**

- To ensure safe operation, please observe the following precautions:
- Do not bend, drop or expose the remote control unit to moisture or heat.
 - For cleaning, use a soft dry cloth. Do not apply benzene, thinner, spray, or any chemical material.

- ④ **VIDEO button**
Select the VIDEO input source. (p.41)
- ⑤ **S-VIDEO button**
Select the S-VIDEO input source. (p.41)
- ⑥ **Point ▲▼◀▶ buttons**
 - Select an item or adjust the value in the On-Screen Menu. (p.24)
 - Pan the image in the Digital zoom +/- mode. (pp.38, 40)
- ⑦ **ASPECT button**
Select a screen mode. (pp.29,37-40,47-50)
- ⑧ **MENU button**
Open or close the On-Screen Menu. (p.24)
- ⑨ **FREEZE button**
Freeze the picture on the screen. (p.28)
- ⑩ **BLANK button**
Temporarily turn off the image on the screen. (p.29)
- ⑪ **D.ZOOM +/- buttons**
Zoom in and out the images. (pp.28, 38, 40)
- ⑫ **VOLUME +/- buttons**
Adjust the volume level. (p.27)
- ⑬ **MUTE button**
Mute the sound. (p.27)
- ⑭ **IMAGE button**
Select the image mode. (pp.29, 35, 44)
- ⑮ **P-TIMER button**
Operate the P-timer function. (pp.29, 57)
- ⑯ **LAMP button**
Select a lamp mode. (pp.28, 59)
- ⑰ **INFO. button**
Operate the information function. (p.64)
- ⑱ **KEYSTONE button**
Correct keystone distortion. (p.26)
- ⑲ **OK button**
 - Execute the selected item. (p.24)
 - Zoom in or out the image in Digital zoom mode. (pp.38, 40)
- ⑳ **COMPONENT button**
Select the COMPONENT input source. (p.42)
- ㉑ **HDMI button**
Select the HDMI input source. (p.42)

Part Names and Functions

Remote Control Unit Battery Installation

1 Open the battery compartment lid.

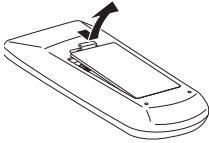

2 Install new batteries into the compartment.

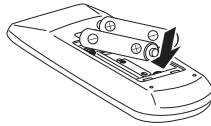

Two AAA size batteries
For correct polarity (+ and -), be sure battery terminals are in contact with pins in compartment.

3 Replace the compartment lid.

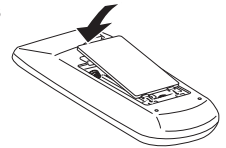

WARNING

To ensure safe operation, please observe the following precautions :

- Use two (2) AAA type batteries.
- Always replace batteries in sets.
- Do not use a new battery with a used battery.
- Avoid contact with water or liquid.
- Do not expose the remote control unit to moisture or heat.
- Do not drop the remote control unit.
- If the battery has leaked on the remote control unit, carefully wipe the case clean and install new batteries.
- Risk of an explosion if battery is replaced by an incorrect type.
- Dispose of used batteries according to the instructions or your local disposal rule or guidelines.

Remote Control Unit Operating Range

Point the remote control unit toward the projector (Infrared Remote Receiver) when pressing the buttons. Maximum operating range for the remote control unit is about 16.4'(5 m) and 60 degrees in front of the projector.

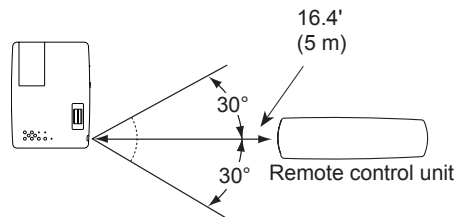

Remote Control Code

The 2 different remote control codes (Code 1–Code 2) are assigned to this projector. Switching the remote control codes prevents interference from other remote control units when several projectors or video equipment next to each other are operated at the same time. Change the remote control code for the projector first before changing that for the remote control unit. See "Remote control" in the Setting Menu on page 59.

Press and hold the MENU and IMAGE buttons for more than five seconds to switch between the **Code 1** and **Code 2**. The initial code is set to **Code 1**.

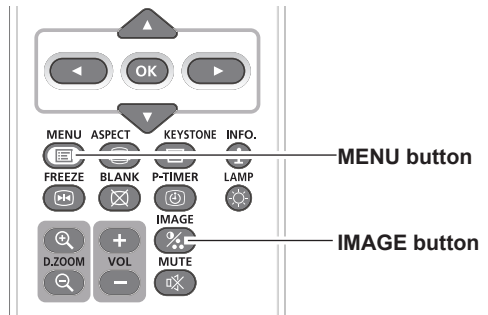

Installation

Positioning the Projector

For projector positioning, see the figures below. The projector should be set perpendicularly to the plane of the screen.

✓ **Note:**

- The brightness in the room has a great influence on picture quality. It is recommended to limit ambient lighting in order to obtain the best image.
- All measurements are approximate and may vary from the actual sizes.

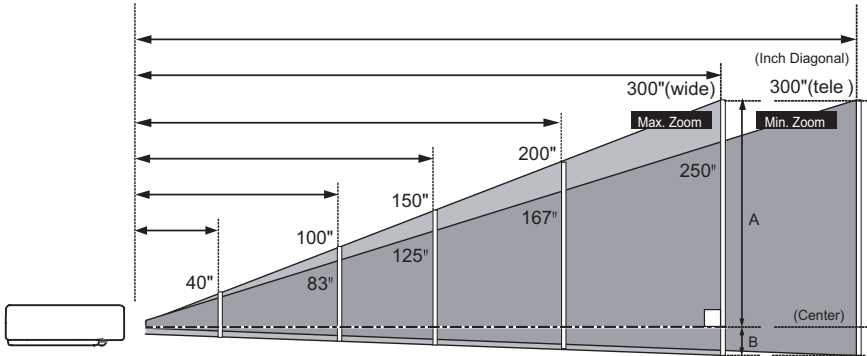

For LV-7292A, LV-7297A, LV-7292M, LV-7297M

A:B = 6:1

Screen Size (W x H) mm	40"	100"	150"	200"	300"
4:3 aspect ratio	813 x 610	2032 x 1524	3048 x 2286	4064 x 3048	6096 x 4572
Zoom (max)	4.3'(1.30m)	10.7'(3.26m)	16.1'(4.90m)	21.5'(6.55m)	32.3'(9.84m)
Zoom (min)	5.1'(1.55m)	12.9'(3.92m)	19.4'(5.90m)	25.8'(7.87m)	38.7'(11.80m)

For LV-7392A

A:B = 6:1

Screen Size (W x H) mm	40"	100"	150"	200"	300"
4:3 aspect ratio	813 x 610	2032 x 1524	3048 x 2286	4064 x 3048	6096 x 4572
Zoom (max)	3.6'(1.1m)	9.5'(2.9m)	14.3'(4.4m)	19.1'(5.8m)	28.6'(8.7m)
Zoom (min)	4.5'(1.4m)	11.4'(3.5m)	17.1'(5.2m)	22.9'(7.0m)	34.4'(10.5m)

For LV-8227A, LV-8227M

A:B = 13:1

Screen Size (W x H) mm	40"	100"	150"	200"	300"
16:10 aspect ratio	862 x 538	2154 x 1346	3231 x 2019	4308 x 2692	6462 x 4039
Zoom (max)	4.0'(1.2m)	10.1'(3.1m)	15.1'(4.6m)	20.2'(6.2m)	30.3'(9.3m)
Zoom (min)	4.8'(1.5m)	12.1'(3.7m)	18.2'(5.5m)	24.3'(7.4m)	36.4'(11.1m)

Project vertically to the screen

Adjust the light axis vertically to the screen.

✓ **Note:**

If the projector is too oblique to the screen, part of the focus may be deviated.

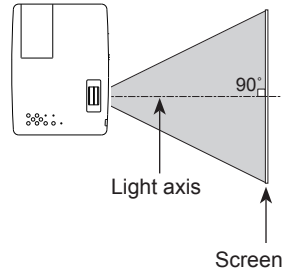

Adjust the Height and the Incline angle of the projected image

Projection angle can be adjusted up to 10.0 degrees with the adjustable foot.

Lift the front of the projector and push the foot lock latch on the projector.

Release the foot lock latch to lock the adjustable foot and rotate the adjustable foot to adjust the position and tilt.

To retract the adjustable foot, lift the front of the projector and push and undo the foot lock latch.

✓ **Note:**

Retract the adjustable foot when transporting the projector.

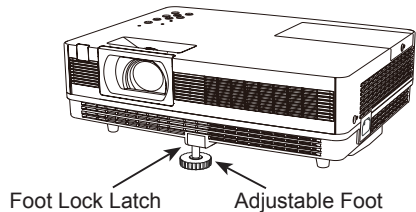

● Tilt the projector within ± 20 degrees horizontally

When moving the projector horizontally, make sure to tilt the projector within ± 20 degrees, otherwise it may result in lamp malfunction.

● About the Keystone distortion adjust

The projection image will become distorted if the adjustable foot is lifted too high or the project angle is too oblique to the screen. In these conditions, adjust the height of the support desk of the projector.

✓ **Note:**

Keystone distortion of the projected image can be corrected by menu operation. (pp 26, 38, 40, 48, 50)

● About the brightness of the room

Do not expose the screen directly to the sunlight or lamp light, because this will make the screen too white to see the projection image clearly. When using the projector in a sufficient brightness room, slightly lower the brightness of the room.

Connecting to a Computer

Cables used for connection

- VGA Cables (Mini D-sub 15 pin) *(Only one cable is supplied.)
 - Audio Cables
 - HDMI-DVI Cable
- (*One cable is supplied; other cables are not supplied with the projector.)

✓ Note:

Unplug the power cords of both the projector and external equipment from the AC outlet before connecting cables.

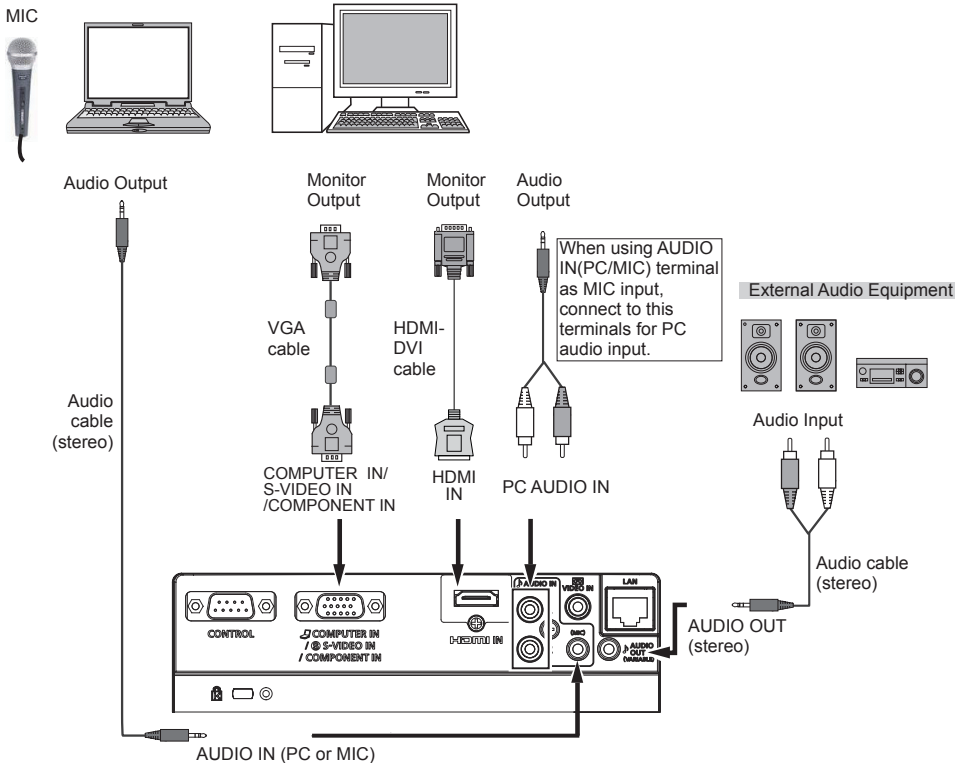

✓ Note:

- When the MIC function is set to **Off** in the Sound menu, the MIC function is disabled.
- When **MIC** is set to **On** in Sound Menu, AUDIO IN (PC/MIC) and AUDIO IN(L/R) terminals can be connected at the same time. At this time, AUDIO IN (PC/MIC) terminal as MIC input, AUDIO IN(L/R) terminal as COMPUTER or VIDEO audio input.
- When the AUDIO OUT is plugged-in, the projector's built-in speaker is not available.

Installation

Connecting to VIDEO Equipment

Cables used for connection

- VIDEO Cable
- S-VIDEO Cable
- S-VIDEO-VGA Cable
- Audio Cables
- HDMI Cable

(Cables are not supplied with the projector.)

✓ Note:

Unplug the power cords of both the projector and external equipment from the AC outlet before connecting cables.

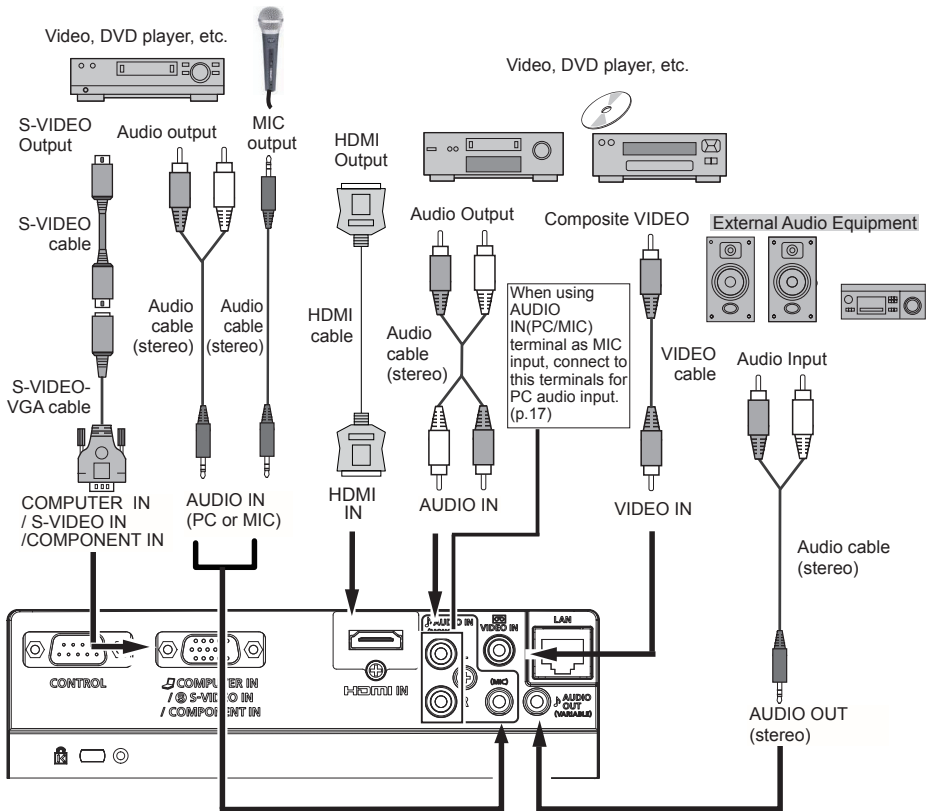

✓ Note:

- When the MIC function is set to **Off** in the Sound menu, the MIC function is disabled.
- When the AUDIO OUT is plugged-in, the projector's built-in speaker is not available.
- See page 79 for ordering optional cables.

Connecting to COMPONENT VIDEO and SCART Equipment

Cables used for connection

- Audio Cables
 - Scart-VGA Cable
 - COMPONENT Cable
 - COMPONENT-VGA Cable
- (Cables are not supplied with this projector.)

✓ Note:

Unplug the power cords of both the projector and external equipment from the AC outlet before connecting cables.

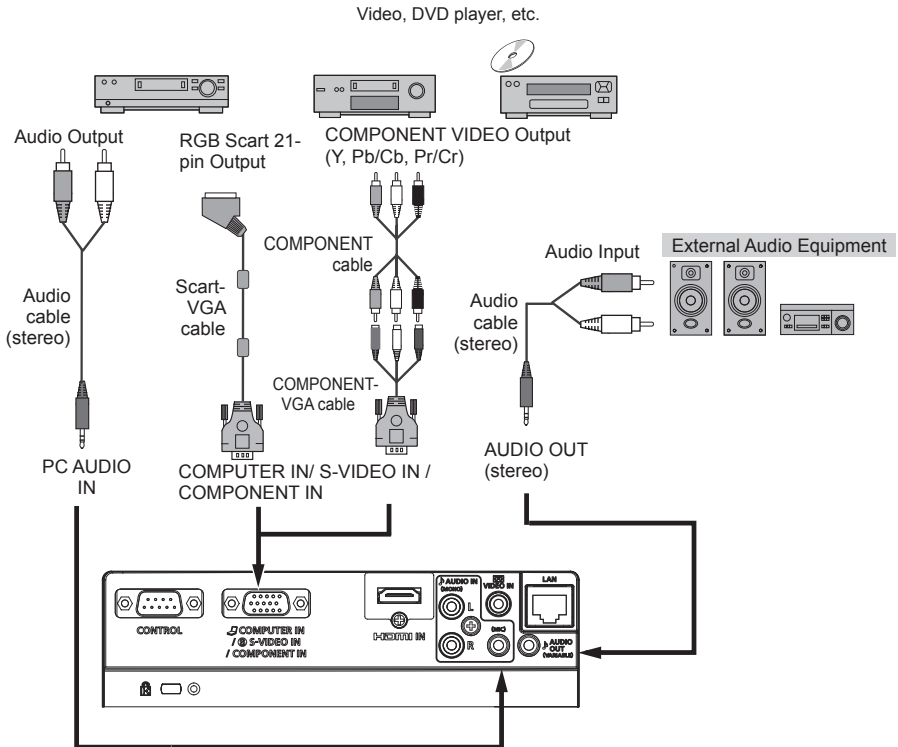

✓ Note:

- When using MIC function, see pages 17-18 for detail about connection.
- When the AUDIO OUT is plugged-in, the projector's built-in speaker is not available.
- See page 79 for ordering optional cables.

Installation

Using the ferrite core

Before using the AC Power Cord, attach the ferrite core (supplied) as shown below. (See below for mounting location.)

The Power Cord with ferrite core must be used for RF interference suppression.

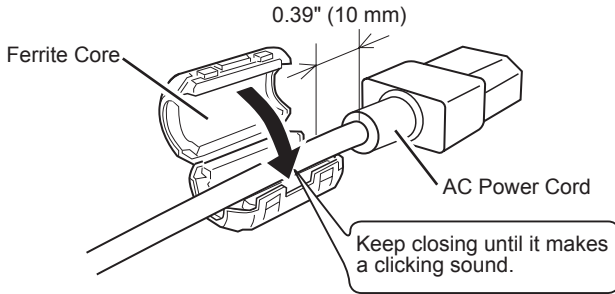

Connecting the AC Power Cord

This projector uses nominal input voltages of 100-240 V AC and it automatically selects the correct input voltage. It is designed to work with single-phase power systems having a grounded neutral conductor. To reduce the risk of electrical shock, do not plug into any other type of power system. If you are not sure of the type of power being supplied, consult your authorized dealer or service center.

Connect the projector with all peripheral equipment before turning the projector on.

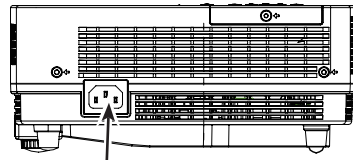

Connect the AC power cord (supplied) to the projector.

CAUTION



The AC outlet must be near this equipment and must be easily accessible.

✓ Note:

Unplug the AC power cord when the projector is not in use. When this projector is connected to an outlet with the AC power cord, it is in Stand-by mode and consumes a little electric power.

NOTE ON THE POWER CORD

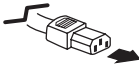
AC power cord must meet requirement of the country where you use the projector. Confirm the AC plug type with the chart below and proper AC power cord must be used. If supplied AC power cord does not match your AC outlet, contact your sales dealer.

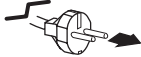
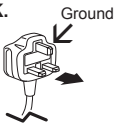
Projector side	AC outlet side		
 <p>To power cord connector on your projector.</p>	<p>For the U.S.A. and Canada</p>  <p>To the AC outlet. (120 V AC)</p>	<p>For Continental Europe</p>  <p>To the AC outlet. (200 - 240 V AC)</p>	<p>For the U.K.</p>  <p>To the AC outlet. (200 - 240 V AC)</p>

Basic Operation

Turning On the Projector

- 1 Complete peripheral connections (with a computer, VCR, etc.) before turning on the projector.
- 2 Connect the projector's AC power cord into an AC outlet. The POWER indicator lights red. Open the lens cap.
- 3 Press the POWER button on the top control or on the remote control unit. The POWER indicator lights green and the cooling fans start to operate. The preparation display appears on the screen and the countdown starts.
- 4 After the countdown, the input source that was selected the last time and the Lamp mode status icon (p. 59) appear on the screen for about 4 seconds.
- 5 If there is no signal input when start on the projector, or the current signal is missed while operating the projector, the VIDEO/PC selection window will be displayed on the screen, please move the pointer to input source desired by pressing the Point ▲▼ buttons and press the OK button. And then follow the input signal guidance window to correct the signal and connection.

If the projector is locked with a PIN code, PIN code input dialog box will appear. Enter the PIN code as instructed on the next page.



The preparation display will disappear after 30 seconds.

Selected Input Source and Lamp mode



(See page 59 for Lamp mode status.)

✓Note:

The Filter warning and Lamp replacement icons may appear on the screen depending on the usage state of the projector.

PC Selection

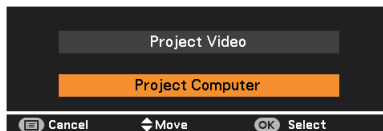

Guidance for PC Input

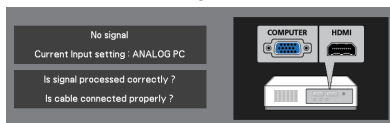

Video Selection

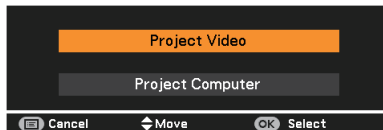

Guidance for Video Input

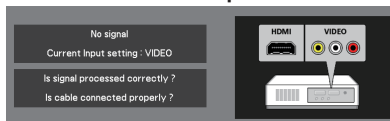

✓Note:

- When the Logo select function is set to **Off**, the logo will not be shown on the screen (p.53).
- When **Countdown off** or **Off** is selected in the Display function, the preparation display will not be shown on the screen (p.53).
- When the Auto input function is set to **On 2**, the input signal will be searched automatically (p.52).
- When **Off** is selected in the Display function, the VIDEO/PC selection window and the input signal guidance window are not shown on the screen (p.53).

Basic Operation

Enter a PIN code

Use the Point ▲▼ buttons to enter a number. Press the Point ► button to fix the number and move the red frame pointer to the next box. The number changes to *. If you fixed an incorrect number, use the Point ◀ button to move the pointer to the number you want to correct, and then enter the correct number.

Repeat this step to complete entering a four-digit number.

After entering the four-digit number, move the pointer to "Set". Press the OK button so that you can start to operate the projector.

If you entered an incorrect PIN code, **PIN code** and the number (* * * *) will turn red for a moment. Enter the correct PIN code all over again.

What is PIN code?

PIN (Personal Identification Number) code is a security code that allows the person who knows it to operate the projector. Setting a PIN code prevents unauthorized use of the projector.

A PIN code consists of a four-digit number. Refer to the PIN code lock function in the Setting Menu on pages 60-61 for locking operation of the projector with your PIN code.

About the Power Management mode

This projector has the Power Management mode function. When there is no signal input for more than 30 seconds and also there is no operation to the projector, the **No signal** image appears and the countdown begins. After the countdown, the lamp will be off. This function helps to save power consumption and extend the lamp life. (p. 56)

When set to Standby

The cooling starts when the countdown is finished and the lamp is off. During the cooling, the POWER indicator blinks red, and do not do any operation to the projector.

The POWER indicator blinks green when the cooling is completed and it goes to the Power Management mode. In this condition, the projection lamp will be turned on and image will be projected if the input signal is reconnected or any button on the top control or remote control unit is pressed.

When set to Exit

The cooling starts when the countdown is finished and the lamp is off. During the cooling, the POWER indicator blinks red, and do not do any operation to the projector.

The power will be turned off and the projector goes to Standby mode when the cooling is completed.

PIN Code Input Dialog Box

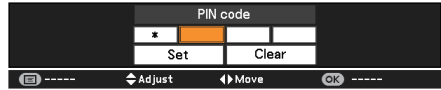

After the OK icon disappears, you can operate the projector.



✓ **Note:**

- If the PIN code number is not entered or wrong PIN code number is entered within three minutes after the PIN code dialog box appeared, the projector will be turned off automatically.
- The "1234" is set as the initial PIN code at the factory.

CAUTION ON HANDLING PIN CODE

If you forget your PIN code, the projector can no longer be started. Take special care in setting a new PIN code. Write down the number as a reminder. Should the PIN code be missing or forgotten, consult your dealer or service center.



Remaining Time until the lamp is off.

Turning Off the Projector

- 1 Press the POWER button on the top control or on the remote control unit, and **Power off?** appears on the screen.
- 2 Press the POWER button again to turn off the projector. The POWER indicator starts to blink red, and the cooling fans keep running. (You can select the level of fans' quietness and speed. See "Fan" on page 62.) At this time, you can unplug the AC power cord even if the fans are still running.
- 3 When the projector has cooled down enough, the POWER indicator stops blinking and you can turn on the projector.

CAUTION

TO MAINTAIN THE LIFE OF THE LAMP, ONCE YOU TURN THE PROJECTOR ON, WAIT AT LEAST FIVE MINUTES BEFORE TURNING IT OFF.

CAUTION

DO NOT OPERATE THE PROJECTOR CONTINUOUSLY WITHOUT REST. CONTINUOUS USE MAY RESULT IN SHORTENING THE LAMP LIFE. TURN OFF THE PROJECTOR AND LET STAND FOR ABOUT AN HOUR IN EVERY 24 HOURS.

✓Note:

- When the Direct power on function is set to **On**, the projector will be turned on automatically by connecting the AC power cord to an AC outlet (p.56).
- The running speed of cooling fans is changed according to the temperature inside the projector.
- Do not put the projector in a case before the projector is cooled enough.
- If the WARNING indicator blinks or lights red, see "WARNING indicator" on page 65.
- While the POWER indicator is blinking, the lamp is being cooled down and the projector cannot be turned on. Wait until the POWER indicator stops blinking to turn on the projector again.
- The fan rotation will terminate directly if the AC power cord is unplugged immediately after the projector is turned off.
- The projector can be turned on after the POWER indicator turns red. The waiting time to restart will be shortened when the normal power-off processing for fan cooling is completed, compared with the time the AC power cord is immediately unplugged after the power-off.

Power off ?

Power off? disappears after 4 seconds.

Direct Power Off Function

You can disconnect the power cord from the wall outlet or turn off the breaker even during projection without pressing the POWER button.

✓Note:

When using the Direct Power Off function, you can not restart the projector immediately after the power is disconnected. If the external power supply is suddenly cut off, the fans stop immediately. The lamp remains high temperature and needs to be cooled.

Basic Operation

How to Operate the On-Screen Menu

The projector can be adjusted or set via the On-Screen Menu. The menus have a hierarchical structure, with a main menu that is divided into submenus, which are further divided into other submenus. For each adjustment and setting procedure, refer to respective sections in this manual.

- 1 Press the MENU button on the top control or the remote control unit to display the On-Screen Menu.
- 2 Use the Point ▲▼ buttons to highlight or select a main menu item. Press the Point ► or the OK button to access the submenu items. (The selected item is highlighted in orange.)
- 3 Use the Point ▲▼ buttons to select the desired submenu item and press the OK button to set or access the selected item.
- 4 Use the Point ▲▼◀► buttons to adjust the setting or switch between each option and press the OK button to activate it and return to the submenu.
- 5 Press the Point ◀ button to return to the main menu. Press the MENU button to exit the On-Screen Menu.

Top Control

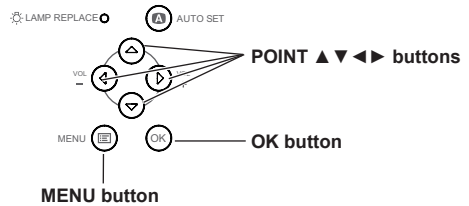

Remote control unit

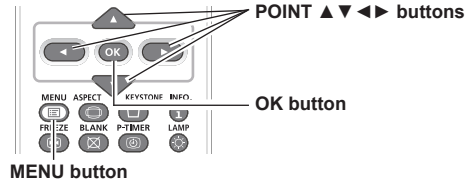

When Main menu is selected

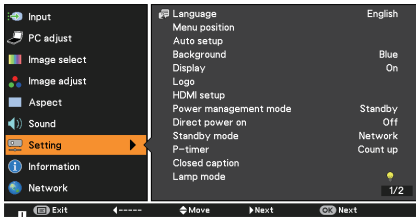

When Sub menu is selected

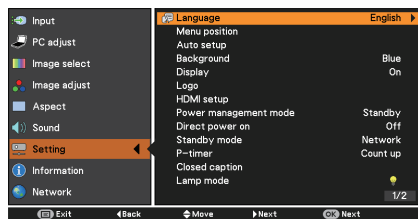

● About the guide bar*

Display the Select and Execute buttons.

The right picture shows the Sub menu guide bar.

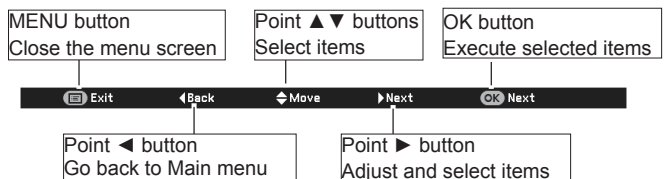

Main Menu

For detailed functions of each menu, see “Menu Tree” on pages 73-74.

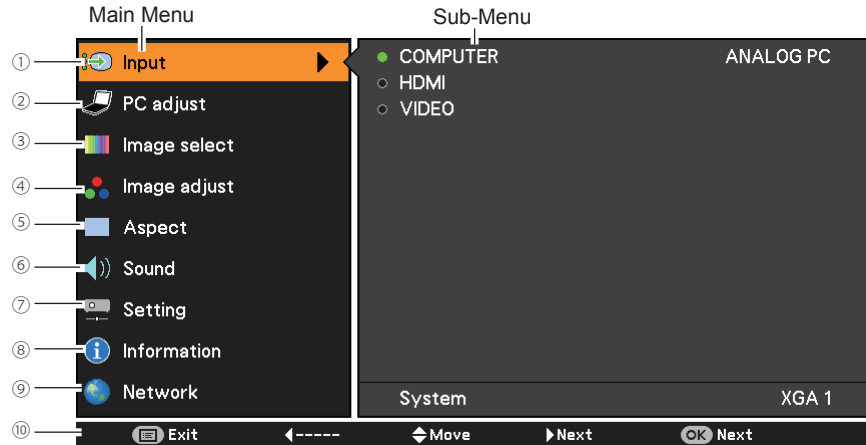

1 Input

Used to select an input source from **COMPUTER**, **HDMI** or **VIDEO**. (pp.30, 41-42)

2 PC adjust

Select **Auto PC**, **Fine sync**, **Total dots**, **Horizontal position**, **Vertical position**, **Current mode**, **Clamp**, **Display area H**, **Display area V**, **Reset**, **Mode free** and **Store** to adjust the parameters to match with the PC input signal format. (pp.32-33)

3 Image select

Used to select an image mode from among **Presentation**, **Standard**, **High contrast**, **Cinema**, **Blackboard(Green)**, **Colorboard** and **User 1-4**. (pp.35, 44)

4 Image adjust

For Computer source, used to adjust computer image [**Contrast**, **Brightness**, **Auto iris***, **Color temp.**, **White balance (R/G/B)**, **Sharpness**, **Gamma**, **Reset** and **Store**]. (p.36)

For VIDEO or HDMI source, used to adjust picture image [**Contrast**, **Brightness**, **Color**, **Tint**, **Auto iris***, **Color temp.**, **White balance (R/G/B)**, **Sharpness**, **Gamma**, **Noise reduction**, **Progressive**, **Reset** and **Store**]. (pp.45-46)

* Auto iris is only for LV-7292A, LV-7297A, LV-7392A, LV-8227A.

5 Aspect

LV-7292A, LV-7297A, LV-7392A, LV-7292M, LV-7297M:

For Computer source, used to adjust size of the image [**Normal**, **Full**, **16:9**, **Zoom**, **True**, **Custom**, **Custom adj.**, **Digital zoom +/-**, **Keystone**, **Ceiling**, **Rear** and **Reset**]. (pp.37-38)

For VIDEO or HDMI source, used to set size of image [**Normal**, **Full**, **16:9**, **Zoom**, **Custom**, **Custom adj.**, **Keystone**, **Ceiling**, **Rear** and **Reset**]. (pp.47-48)

LV-8227A, LV-8227M:

For COMPUTER source, used to adjust size of the image [**Normal**, **Full**, **16:9**, **Zoom**, **True**, **Custom**, **Custom adj.**, **Digital zoom +/-**, **Keystone**, **Ceiling**, **Rear**, **Screen aspect** and **Reset**]. (pp.39-40)

For VIDEO or HDMI source, used to set size of image [**Normal**, **Full**, **16:9**, **Zoom**, **Natural wide**, **Custom**, **Custom adj.**, **Keystone**, **Ceiling**, **Rear**, **Screen aspect** and **Reset**]. (pp.49-50)

6 Sound

Used to adjust the volume or mute the sound or set configurations to the MIC functions (p.27).

7 Setting

Used to set the projector's operating configurations. (pp.51-63)

8 Information

Display the input source information. (p.64)

9 Network

See user's manual of "Network Set-up and Operation".
(Network function is only for LV-7292A, LV-7297A, LV-7392A, LV-8227A.)

10 Guide

The key operation is displayed.

Basic Operation

Zoom and Focus Adjustment

Rotate the Zoom Ring to zoom in and out.
Rotate the Focus Ring to adjust the focus of the image.

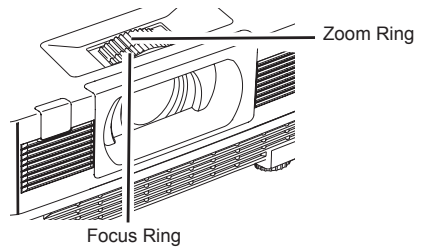

Auto Setup Function

Auto setup function is provided to automatically execute the setting of Auto setup (includes Auto input, Auto PC and Auto Keystone functions) in the setting menu by just pressing the AUTO SET button on the top control or the remote control unit. Refer to page 52 for the setting of the Auto setup function.

✓Note:

- Auto Keystone corrects vertical distortion only; it does not correct horizontal distortion.
- Auto Keystone cannot work when Ceiling feature is set to **On** in the Setting menu (pp.38, 40, 48, 50).
- Perfect correction of the image distortion cannot be ensured with the Auto setup function. If the distortion cannot be corrected properly by pressing the AUTO SET button, adjust manually by pressing the KEYSTONE button on the remote control unit or selecting Keystone in the Aspect menu (pp.38, 40, 48, 50).
- **Fine sync, Total dots, Horizontal position and Vertical position** position of some computers cannot be fully adjusted with the Auto PC Adjustment function. When the image is not provided properly with this operation, manual adjustments are required (pp.33-34).

Top Control

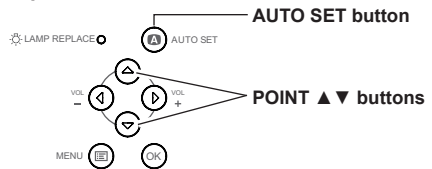

Remote control unit

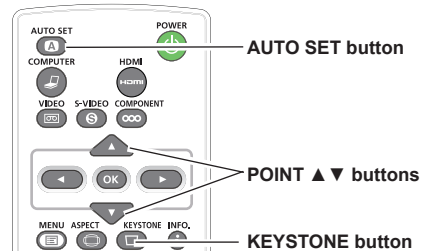

Keystone Correction

If a projected picture still has keystone distortion after pressing the AUTO SET button on the top control or the remote control unit, correct the image manually as follows:

Press the KEYSTONE button on the remote control unit. The Keystone dialog box appears. Use the Point ▲▼ buttons to correct keystone distortion. The keystone adjustment can be stored (pp.38, 40, 48, 50).

Reduce the upper width with the Point ▲ button.

Reduce the lower width with the Point ▼ button.

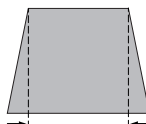
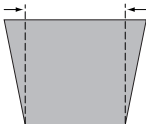

- The white arrows indicate that there is no correction.
- A blue arrow indicates the direction of correction.
- An arrow disappears at the maximum correction.
- If you press the KEYSTONE button on the remote control unit once more while the keystone dialog box is being displayed, the keystone adjustment will be canceled.
- The adjustable range is limited depending on the input signal.

Sound Adjustment

Direct Operation

Volume

Press the VOLUME +/- buttons on the top control or on the remote control unit to adjust the volume. The volume dialog box appears on the screen for a few seconds.

Mute

Press the MUTE button on the remote control unit to select **On** to temporarily turn off the sound. To turn the sound back on, press the MUTE button again to select **Off** or press the VOLUME +/- buttons. The Mute function is also effective for the AUDIO OUT jack.

Menu Operation

- 1 Press the MENU button to display the On-Screen Menu. Use the Point ▲▼ buttons to select **Sound**. Press the Point ► or the OK button to access the submenu items.
- 2 Use the Point ▲▼ buttons to select the desired submenu item and press the OK button to access the selected item.

Volume

Press the Point ► button to turn up the volume; Press the Point ◀ button to turn down the volume.

Mute

Press the OK button to switch the mute function **On/Off**. When the sound is turned off, **On** is displayed. Press the VOLUME +/- buttons again or adjust MIC gain's volume to turn the sound back on.

MIC

Use the Point ▲▼ buttons to switch the MIC function **On/Off**, and then press the OK button. When **On** is selected, the synthesis volume (MIC and RCA) is output.

MIC GAIN

Press the Point ► button to turn up the MIC mixing gain; Press the Point ◀ button to turn down the MIC mixing gain.

STANDBY MIC OUT

When setting the STANDBY MIC OUT function to **On** and in Standby mode status, only MIC input volume can be output.

Top Control

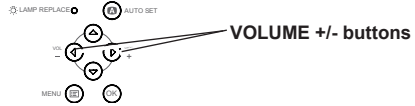

Remote control unit

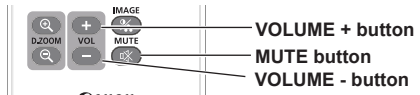

Volume Dialog Box

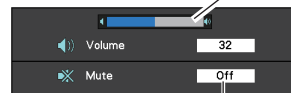

Press the MUTE button to set the Mute function **On** or **Off**. The dialog box disappears after 4 seconds.

Sound Menu

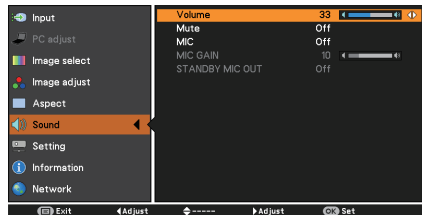

AUDIO INPUT SELECTION (see pages 17-19)

	AUDIO IN		
MIC Setup	RCA L/R terminal	Mini jack	HDMI (digital audio)
MIC Off	VIDEO audio input	PC audio input	HDMI audio
MIC On	VIDEO or PC audio input	MIC input	---
MIC on for HDMI	---	---	HDMI audio(*1)

*1 HDMI setup = HDMI

✓ Note:

- When **Off** is selected in MIC function, the MIC GAIN and STANDBY MIC OUT functions are not available.
- Only the Standby mode is set to **Network**, **STANDBY MIC OUT** can be selected.
- If the MIC function is turned on when connecting PC audio to the AUDIO IN (a mini jack), loud sound may be output suddenly depending on the setting value of MIC GAIN.
- Press the Point ◀► buttons on the top control or on the remote control unit to adjust the MIC input volume.

Basic Operation

Remote control unit Operation

Using the remote control unit for some frequently used operations is advisable. Just pressing one of the buttons enables you to make the desired operation quickly without calling up the On-Screen Menu.

COMPUTER, HDMI, VIDEO, S-VIDEO and COMPONENT buttons

Press the COMPUTER, HDMI, VIDEO, S-VIDEO and COMPONENT buttons on the remote control unit to select the input source. See pages 30, 41-42 for details.

FREEZE button

Press the FREEZE button on the remote control unit to freeze the picture on the screen, meanwhile, volume is muted. To cancel the Freeze function, press the FREEZE button again or press any other button.

Fig.1 will appear on the screen while the Freeze function is working.

Fig.1



INFO. button

Display the input source information: **Input**, **H-sync freq.**, **V-sync freq.**, **Aspect**, **Language**, **Lamp status**, **Lamp counter**, **Power management mode**, **Key lock**, **PIN code lock**, **Remote control** and **SERIAL NO.** (p.64)

D.ZOOM buttons

Press the D.ZOOM buttons on the remote control unit to enter to the Digital zoom +/- mode. See pages 38,40 for details.

LAMP button

Press the LAMP button on the remote control unit to select the lamp mode for changing the brightness on the screen.

- 💡 High..... Brighter than the Normal mode.
- 💡 Normal Normal brightness
- 💡 Eco..... Lower brightness reduces the lamp power consumption and extends the lamp life.

Remote control unit

COMPUTER button

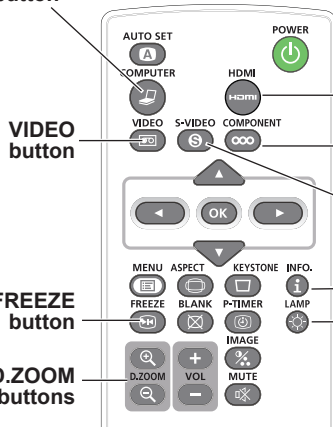

VIDEO button

HDMI button COMPONENT button

S-VIDEO button

FREEZE button

INFO. button LAMP button

D.ZOOM buttons

✓ Note:

See the next page for the description of other buttons.

BLANK button

Press the BLANK button on the remote control unit to black out the image. To restore to normal, press the BLANK button again or press any button. When the projected image is captured and is set as **User** in the Logo selection (p. 53), the screen changes each time you press the BLANK button as follows.

black out → the captured image → normal
→ • • • • •

✓ Note:

When use the MUTE button to release the Blank function, the mute function can not be operated at the same time.

Remote control unit

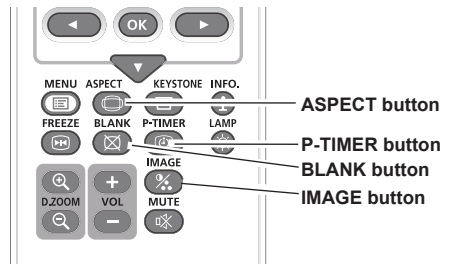

✓ Note:

See the previous page for the description of other buttons.

P-TIMER button

Press the P-TIMER button on the remote control unit to operate the Count up/Count down function. Refer to p.57 for detail of Setting for the P-timer function.

To stop the count time, press the P-TIMER button.

To restart the P-timer, press the P-TIMER button again.

To cancel the P-timer function, press and hold the P-TIMER button.

IMAGE button

Press the IMAGE button on the remote control unit to select a desired image mode of the screen. See pages 35, 44 for details.

ASPECT button

Select the screen size (See pages 37-40, 47-50 for details).

BLANK



Blank disappears after 4 seconds.

P-Timer



Computer Input

Input Source Selection (ANALOG PC: COMPUTER)

Direct Operation

Choose **COMPUTER (ANALOG PC)** by pressing the **COMPUTER** button on the remote control unit.

Remote control unit

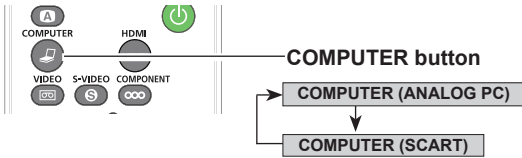

Menu Operation

- 1 Press the **MENU** button to display the On-Screen Menu. Use the Point **▲▼** buttons to select **Input** and then press the Point **▶** or the **OK** button.
- 2 Use the Point **▲▼** buttons to select **COMPUTER** and then press the **OK** button.
- 3 When **COMPUTER** is selected, press the Point **▶** button to access the submenu items. Use the Point **▲▼** buttons to select the **ANALOG PC** input source and then press the **OK** button.

Input Menu

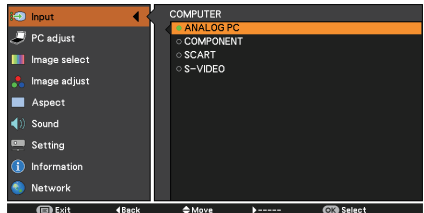
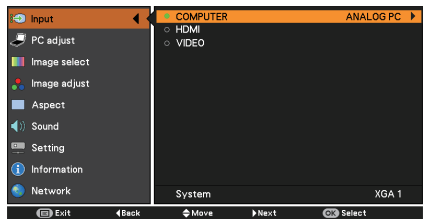
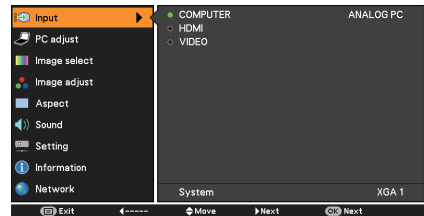

✓Note:

When the Auto input function is set to **On 1** or **On 2** in the Auto setup function, the input signal will be searched automatically (p.52).

Computer System Selection

This projector automatically tunes to various types of computers with its Multi-scan system and Auto PC Adjustment. If a computer is selected as a signal source, this projector automatically detects the signal format and tunes to project a proper image without any additional settings. (Signal formats provided in this projector are shown on pages 76-77.)

One of the following messages may appear when:

Auto When the projector cannot recognize the connected signal conforming to the provided PC systems, **Auto** is displayed on the System Menu box and the Auto PC Adjustment function works to display proper images. If the image is not projected properly, a manual adjustment is required (pp. 33-34).

--- There is no signal input from the computer. Check the connection between your computer and the projector. (See "Troubleshooting" on p. 71.)

Mode 1 The preset system is manually adjusted in the PC adjust Menu. The adjusted data can be stored in **Mode 1-10** (pp. 33-34).

SVGA 1 PC Systems provided in this projector is chosen. The projector chooses a proper system provided in the projector and displays it.

***Mode 1** and **SVGA 1** are examples.

PC System Menu

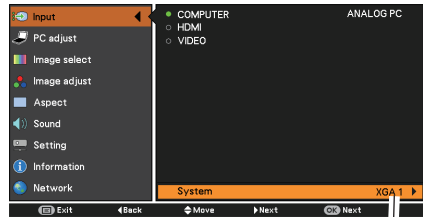

Selected system in the PC System Menu is displayed.

Selecting Computer System Manually

PC system can also be selected manually.

- 1 Press the MENU button to display the On-Screen Menu. Use the Point ▲▼ buttons to select **Input** and then press the Point ► or the OK button.
- 2 Use the Point ▲▼ buttons to select **System** and then press the Point ► or the OK button.
- 3 Use the Point ▲▼ buttons to select the desired system and then press the OK button.

PC System Menu

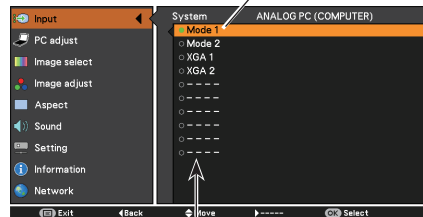

Customized **Mode (1-10)** set in the PC adjust Menu (pp. 33-34).

Systems in this dialog box can be selected.

Auto PC Adjustment

When the image is not stable or flicker, or when the image is not in right position as inputting ANALOG PC signal, press the AUTO SET button on the remote control unit to adjust the **Fine sync**, **Total dots**, **Horizontal position** and **Vertical position** to obtain best display.

- 1 Press the MENU button to display the On-Screen Menu. Use the Point ▲▼ buttons to select **PC adjust** and then press the Point ► or the OK button.
- 2 Use the Point ▲▼ buttons to select **Auto PC** and then press the OK button.

✓**Note:**

- The adjusted parameters from the Auto PC Adjustment can be stored in the projector. Once the parameters are stored, the setting can be done just by selecting a Mode (1–10) in the PC System Menu (p.31). See also “Store” on page 34.
- The Auto PC Adjustment cannot be operated when **480i**, **575i**, **480p**, **575p**, **720p**, **1035i** or **1080i** is selected in the PC System Menu (p. 31), or when the signal is coming from the HDMI terminal.

PC adjust Menu

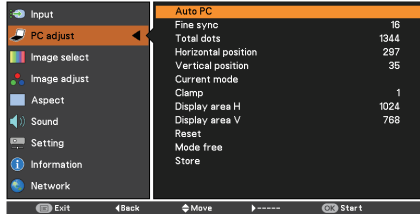

When the image is not provided properly with Auto PC adjustment

When the image is not provided properly with Auto PC, operate as follows:

- Use **Input** menu to adjust the System mode to match to the computer resolution. Refer to page 31 for details. See operation example below.
- Use **PC adjust** menu to adjust the System mode manually and store the adjusted parameters in the Custom Mode. See page 34.

Operation Example

Resolution :1600 x 1200, Vertical Frequency: 60 Hz

- 1 Press the MENU button to display the On-Screen Menu. Press the Point ▲▼ buttons to select **Input**.
- 2 Press the Point ► button to access to **COMPUTER** and then press the OK button.
- 3 Confirm the System mode displayed. If the input signal is different from the computer signal, operate the following steps.
- 4 Use the Point ▲▼ buttons to select **System** and and press the OK button or the Point ► button.
- 5 Use the Point ▲▼ buttons to select the input computer signal and press the OK button.
- 6 Press the MENU button to exit the On-Screen Menu and confirm the image.

✓**Note:**

- Refer to page 76 for the Compatible Computer Specifications.
- Some signal formats may not be able to display correctly.
- Only when input computer signal to the projector, **PC adjust** will become available.

Input Menu

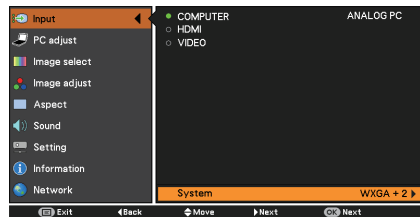

Confirm System mode

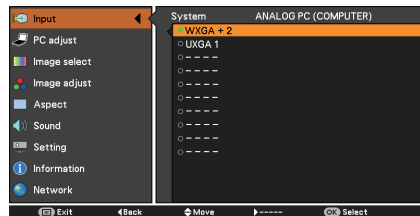

Change System mode

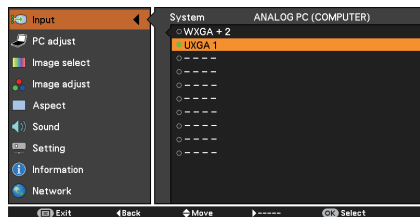

Manual PC Adjustment

Some computers employ special signal formats which may not be tuned by Multi-scan system of this projector. Manual PC Adjustment enables you to precisely adjust several parameters to match those signal formats. The projector has 10 independent memory areas to store those parameters manually adjusted. It allows you to recall the setting for a specific computer.

- 1 Press the MENU button to display the On-Screen Menu. Use the Point ▲▼ buttons to select **PC adjust** and then press the Point ► or the OK button.
- 2 Use the Point ▲▼ buttons to select the desired item and then press the OK button to display the adjustment dialog box. Use the Point ◀▶ buttons to adjust the setting value.

PC adjust Menu

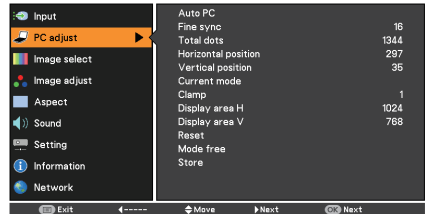

Fine sync

Use the Point ◀▶ buttons to adjust the value, eliminating a flicker from the image displayed (from 0 to 31).

Total dots

Use the Point ◀▶ buttons to adjust the number of total dots in one horizontal period to match your PC image.

Horizontal position

Use the Point ◀▶ buttons to adjust the horizontal picture position.

Vertical position

Use the Point ◀▶ buttons to adjust the vertical picture position.

Current mode

Press the OK button to show **H-sync freq.** and **V-sync freq.** of the connected computer.

Clamp

Use the Point ◀▶ buttons to adjust the clamp level. When the image has dark bars, try this adjustment.

Display area H

Use the Point ◀▶ buttons to adjust the horizontal area displayed by this projector.

Display area V

Use the Point ◀▶ buttons to adjust the vertical area displayed by this projector.

✓Note:

- **Display area (H/V)** cannot be selected when **480i, 575i, 480p, 575p, 720p, 1035i** or **1080i** is selected in the PC System Menu (p.31).

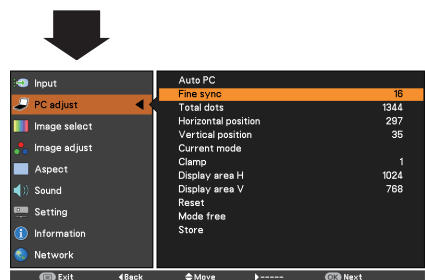

Computer Input

Reset

To reset the adjusted data, select **Reset** and press the OK button. A confirmation box appears and then select **Yes**. All adjustments will return to their previous figures.

Mode free

To clear the stored data, select **Mode free** and then press the Point ► or the OK button. Move the highlight to the Mode that you want to clear and then press the OK button.

Store

To store the adjusted data, select **Store** and then press the Point ► or the OK button. Move the highlight to one of the Modes 1 to 10 in which you want to store, and then press the OK button.

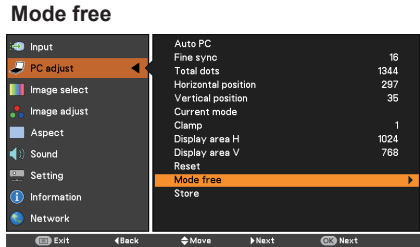

This Mode has stored parameters.

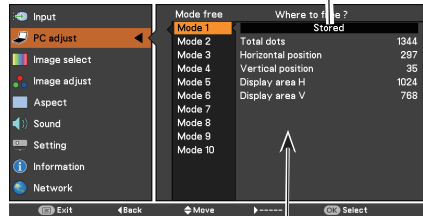

Values of **Total dots**, **Horizontal position**, **Vertical position**, **Display area H**, and **Display area V**.

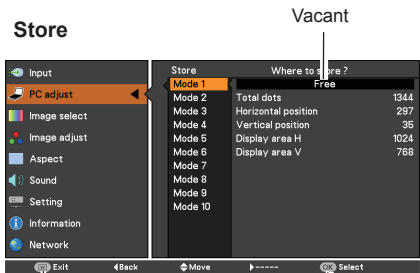

Press MENU button to close this dialog box.

Press OK button to store the data.

Image Mode Selection

Direct Operation

Select the desired image mode among **Presentation, Standard, High contrast, Cinema, Blackboard (Green), Colorboard, User 1, User 2, User 3** and **User 4** by pressing the IMAGE button on the remote control unit.

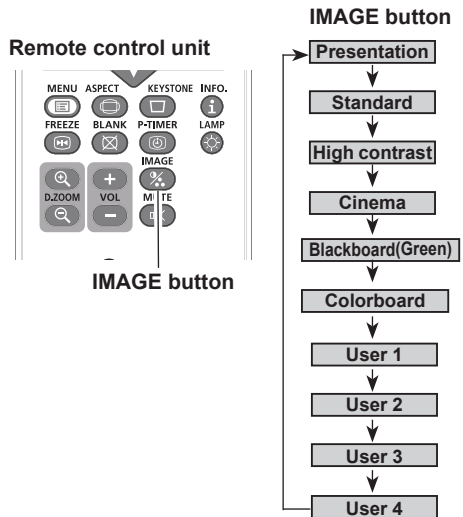

Menu Operation

- 1 Press the MENU button to display the On-Screen Menu. Use the Point ▲▼ buttons to select **Image select** and then press the Point ► or the OK button.
- 2 Use the Point ▲▼ buttons to select the desired item and then press the OK button.

Presentation

For viewing pictures in a bright room.

Standard

Normal picture mode preset on the projector.

High contrast

Picture mode with improved halftone for graphics.

Cinema

Picture mode adjusted with fine tone.

Blackboard (Green)

For the image projected on a blackboard. This mode helps enhance the image projected on a blackboard. This is mainly effective on a green colored board, not truly effective on a black colored board.

Colorboard

At the time of simple projection on the colored wall, you can get the close color image to the color image projected on a white screen by selecting the similar color to the wall color from the preset four colors.

Use the Point ▲▼ buttons to select **Colorboard** and then press the Point ► or the OK button to access the submenu. Press the Point ▲▼ buttons to select items among Red, Blue, Yellow and Green.

User 1-4

For viewing with the user preset image mode in the Image Adjust Menu (see page 36).

Image select Menu

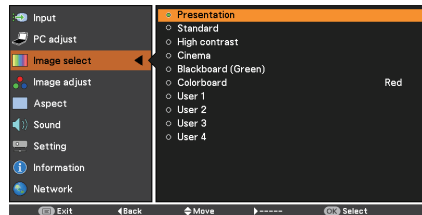
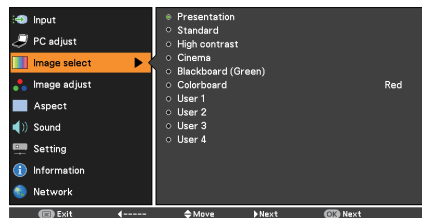

Image Adjustment

- 1 Press the MENU button to display the On-Screen Menu. Use the Point ▲▼ buttons to select **Image adjust** and then press the Point ► or the OK button.
- 2 Use the Point ▲▼ buttons to select the desired item and then press the OK button to display the adjustment dialog box. Use the Point ◀▶ buttons to adjust the setting value.

Contrast

Press the Point ◀ button to decrease the contrast; press the Point ► button to increase the contrast (from 0 to 63).

Brightness

Press the Point ◀ button to decrease the brightness; press the Point ► button to increase the brightness (from 0 to 63).

Auto iris*

Press the Point ◀▶ buttons to select **Off** or **On**.
Off Disabled.

On The iris function is activated.

* Auto iris is only for LV-7292A, LV-7297A, LV-7392A, LV-8227A.

Color temp.

Use the Point ◀▶ buttons to select the desired Color temp. level (**XLow**, **Low**, **Mid**, or **High**).

White balance (Red / Green / Blue)

Press the Point ◀ button to lighten R/G/B tone; press the Point ► button to deepen R/G/B tone (from 0 to 63).

Sharpness

Press the Point ◀ button to decrease the sharpness of the image; press the Point ► button to increase the sharpness of the image (from 0 to 15).

Gamma

Use the Point ◀▶ buttons to adjust the gamma value to obtain a better balance of contrast (from 0 to 15).

Reset

To reset the adjusted data, select **Reset** and press the OK button. A confirmation box appears and then select **Yes**. All adjustments will return to their previous figures.

Store

To store the adjusted data, select **Store** and press the Point ► or the OK button. Use the Point ▲▼ buttons to select one from **User 1** to **User 4** and press the OK button. A confirmation box appears and then select **Yes**. Stored data can be called up by selecting an **User (1-4)** in the Image Mode Selection on page 35.

Image Adjust Menu

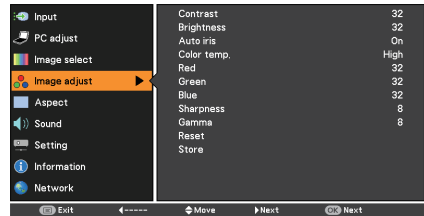

Selected Image mode



Use the Point ◀▶ buttons to adjust the setting value.



Store

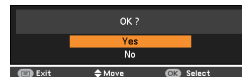

A confirmation box appears and then select **Yes**.

✓Note:

- When White balance **Red**, **Green** or **Blue** is adjusted, **Color temp.** will change to **User**.
- When **Blackboard(Green)** or **Colorboard** is selected in Image select, **Color temp.** will change to **Blackboard** or **Colorboard**.

Aspect Setting (For LV-7292A, LV-7297A, LV-7392A, LV-7292M, LV-7297M)

This projector has the picture screen resize function, which enables you to customize the image size.

- Press the MENU button to display the On-Screen Menu. Use the Point ▲▼ buttons to select **Aspect** and then press the Point ► or the OK button.
- Use the Point ▲▼ buttons to select the desired item and then press the OK button

Normal

Provide the image to fit the screen size.

Full

Provide the full screen image.

16:9

Provide the image at the 16:9 wide screen ratio.

Zoom

Scale the image proportionally to fit the entire screen. Either side of image may go over the screen.

True

Provide the image in its original size. When the original image size is larger or smaller than the screen size (1024 x 768), the projector enters to the panning mode automatically. Use the Point ▲▼◀▶ buttons to pan the image. When adjusted, the arrows will turn red. When reached to the correction limits, the arrows will disappear.

Custom

Provide the last stored aspect screen image.

Custom adj.

Adjust the screen scale and position manually with this function. Press the Point ► button at **Custom adj.** and the Custom adjustment menu is displayed on the screen, you can use the Point ▲▼ buttons to choose the item you want to adjust.

Scale H/V Adjust the Horizontal/Vertical screen scale.

H&V When set to **On**, the aspect ratio is fixed. The **Scale V** appears dimmed and becomes unavailable. Adjust **Scale H**, then the screen scale is automatically modified based on the aspect ratio.

Position H/V .. Adjust the Horizontal/Vertical screen position.

Common Save the adjusted scale or position to all the inputs. Press the OK button at **Common** to display a confirmation box. To save the scale or position, press the OK button at **Yes**. When **Custom** is selected, the saved scale or position is used.

Reset Reset the all adjusted values. Press the OK button at **Reset** to display a confirmation box. To reset, press the OK button at **Yes**.

Aspect Menu

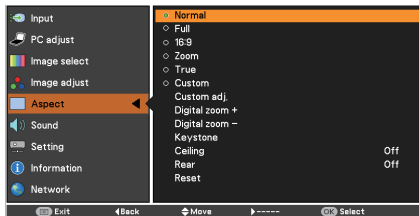
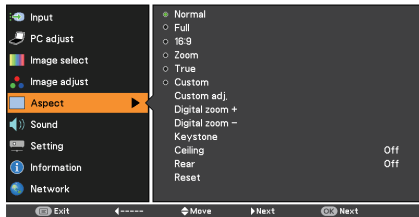

Note:

- This projector cannot display any resolution higher than 1920 x 1200. If your computer's screen resolution is higher than it, reset the resolution to the lower before connecting to the projector.
- The image data in other than 1024 x 768 is modified to fit the screen size in initial mode.
- True** and **Digital zoom +/-** are disabled and cannot be displayed when **480i**, **575i**, **480p**, **575p**, **720p.1035i** or **1080i** is selected in the PC System Menu (p. 31).
- When **True** is selected in the Screen menu, **Digital zoom +/-** cannot be selected.

Custom adj.

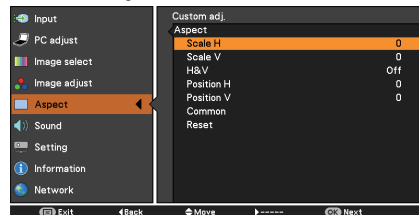

Note:

- When no signal is detected, **Normal** is set automatically.
- The adjustable range for **Scale H/V** and **Position H/V** is limited depending on the input signal.

Computer Input

Digital zoom +

Select **Digital zoom +**. The On-Screen Menu disappears and **D. zoom +** appears. Press the OK button to expand the image size. Use the Point ▲▼◀▶ buttons to pan the image. The Panning function can work only when the image is larger than the screen size. A projected image can be also expanded by pressing the D.ZOOM + or the OK button on the remote control unit.

Digital zoom -

Select **Digital zoom -**. The On-Screen Menu disappears and **D. zoom -** appears. Press the OK button to compress image size. The projected image can be also compressed by pressing the D.ZOOM - or the OK button on the remote control unit.

To exit the Digital zoom +/- mode, press any button except the D.ZOOM +/- buttons, OK and Point buttons.

To return to the previous screen size, select a screen size from the Screen Size Adjustment Menu or select an input source from the Input Source Selection Menu (see page 30) again, or adjust the screen size with the D.ZOOM +/- buttons.

Keystone

This function is used to adjust keystone distortion of the projected image. Use the Point ▲▼ buttons to choose the item you want to adjust.

Keystone

To correct keystone distortion, press the OK button.

Keystone appears on the screen. Use the Point ▲▼ buttons to correct keystone distortion (p.26).

Store

To store or reset the keystone correction, press the Point ▶ button.

Store Keep the keystone correction even when the AC power cord is plugged out or turned off the projector.

Reset..... Release the keystone correction when the AC power cord is plugged out.

Ceiling

When this function is set to **On**, the picture will be top/bottom and left/right reversed. This function is used to project the image from a ceiling-mounted projector.

Rear

When this function is set to **On**, the picture will be left/right reversed. This function is used to project the image from rear of the screen.

Reset

To reset the adjusted data, select Reset and press the OK button. A confirmation box appears and then select Yes. All adjustments will return to their previous figures.

Remote control unit

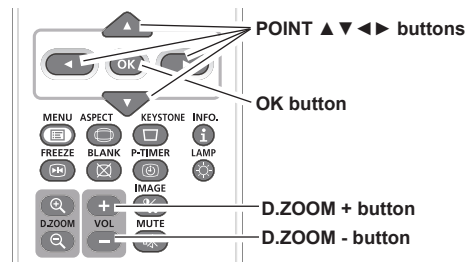

Keystone

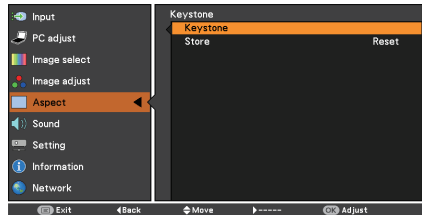

Press the OK button.

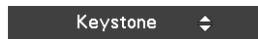

Ceiling

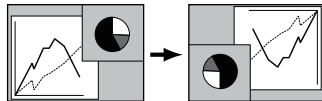

Rear

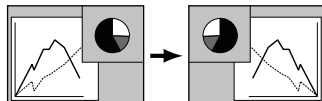

✓ Note:

- The minimum compression ratio is limited depending on the input signal, when the Keystone function is working or when the custom is selected for the screen size.
- **True** and **Digital zoom +/-** are disabled and cannot be displayed when **480i, 575i, 480p 575p, 720p, 1035i or 1080i** is selected in the PC System Menu (p.31).
- **Digital zoom +/-** cannot be selected when **True** is selected.
- The minimum compression ratio is limited at Normal screen size.

Aspect Setting (For LV-8227A, LV-8227M)

This projector has the picture screen resize function, which enables you to customize the image size.

- 1 Press the MENU button to display the On-Screen Menu. Use the Point ▲▼ buttons to select **Screen** and then press the Point ► or the OK button.
- 2 Use the Point ▲▼ buttons select the desired item and then press the OK button .

Normal

Provide the image to fit the screen size.

Full

Provide the full screen image.

16:9

Provide the image at the 16:9 wide screen ratio.

Zoom

Scale the image proportionally to fit the entire screen. Either side of image may go over the screen.

True

Provide the image in its original size. When the original image size is larger or smaller than the screen size (1280 x 800), the projector enters to the panning mode automatically. Use the Point ▲▼◀▶ buttons to pan the image. When adjusted, the arrows will turn blue. When reached to the correction limits, the arrows will disappear.

Custom

Provide the last stored aspect screen image.

Custom adj.

Adjust the screen scale and position manually with this function. Press the Point ► button at **Custom adj.** and the Custom adjustment menu is displayed on the screen, you can use the Point ▲▼ buttons to choose the item you want to adjust.

Scale H/V Adjust the Horizontal/Vertical screen scale.

H&V When set to **On**, the aspect ratio is fixed. The **Scale V** appears dimmed and becomes unavailable. Adjust **Scale H**, then the screen scale is automatically modified based on the aspect ratio.

Position H/V.. Adjust the Horizontal/Vertical screen position.

Common Save the adjusted scale or position to all the inputs. Press the OK button at **Common** to display a confirmation box. To save the scale or position, press the OK button at "Yes". When **Custom** is selected, the saved scale or position is used.

Reset..... Reset the all adjusted values. Press the OK button at **Reset** to display a confirmation box. To reset, press the OK button at "Yes".

Aspect Menu

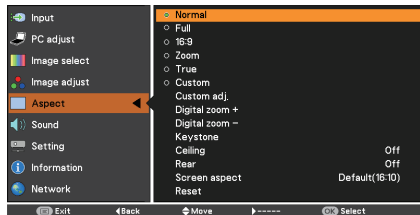
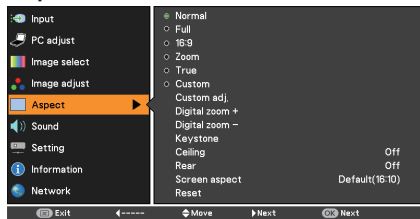

✓Note:

- This projector cannot display any resolution higher than 1920 x 1200. If your computer's screen resolution is higher than it, reset the resolution to the lower before connecting to the projector.
- The image data in other than 1280x800 is modified to fit the screen size in initial mode.
- **16:9**, **True** and **Digital zoom +/-** are disabled and cannot be displayed when **480i**, **575i**, **480p**, **575p**, **720p**, **1035i** or **1080i** is selected in the PC System Menu (p.31).
- When **True** is selected in the Screen menu, **Digital zoom +/-** can not be selected.

Custom adj.

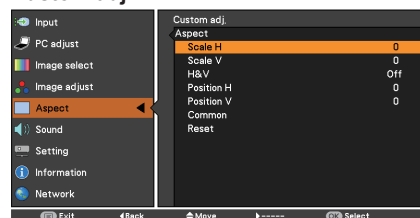

✓Note:

- When no signal is detected, **Normal** is set automatically .
- The adjustable range for **Scale H/V** and **Position H/V** is limited depending on the input signal.

Computer Input

Digital zoom +

Select **Digital zoom +**. The On-Screen Menu disappears and **D. zoom +** appears. Press the OK button to expand the image size. Use the Point **▲▼◀▶** buttons to pan the image. The Panning function can work only when the image is larger than the screen size. A projected image can be also expanded by pressing the D.ZOOM + or the OK button on the remote control unit.

Digital zoom -

Select **Digital zoom -**. The On-Screen Menu disappears and **D. zoom -** appears. Press the OK button to compress image size. The projected image can be also compressed by pressing the D.ZOOM - or the OK button on the remote control unit.

To exit the Digital zoom +/- mode, press any button except the D.ZOOM +/- buttons, OK and Point buttons.

To return to the previous screen size, select a screen size from the Screen Size Adjustment Menu or select an input source from the Input Source Selection Menu (see page 30) again, or adjust the screen size with the D.ZOOM +/- buttons.

Keystone

This function is used to adjust keystone distortion of the projected image. Use the Point **▲▼** buttons to choose the item you want to adjust.

Keystone

To correct keystone distortion, press the OK button.

Keystone appears on the screen. Use the Point **▲▼** buttons to correct keystone distortion (p.26).

Store

To store or reset the keystone correction, press the Point **▶** button.

Store Keep the keystone correction even when the AC power cord is plugged out or turned off the projector.

Reset Release the keystone correction when the AC power cord is plugged out.

Ceiling

When this function is set to **On**, the picture will be top/ bottom and left/right reversed. This function is used to project the image from a ceiling-mounted projector.

Rear

When this function is set to **On**, the picture will be left/right reversed. This function is used to project the image from rear of the screen.

Screen aspect

This function is used to project the image to a 4:3 or 16:9 projection screen.

Default (16:10) 16:10 is the aspect of the LCD panel. The original Screen Menu is available.

16:9 Set to a 16:9 projection screen.

4:3 Set to a 4:3 projection screen.

Reset

To reset the adjusted data, select Reset and press the OK button. A confirmation box appears and then select Yes. All adjustments will return to their previous figures.

Remote control unit

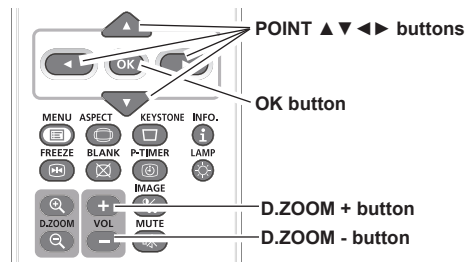

Keystone

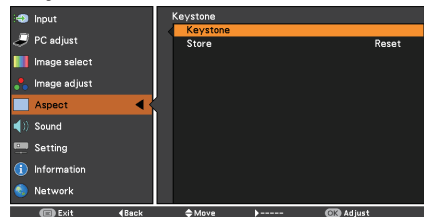

Press the OK button.



Ceiling

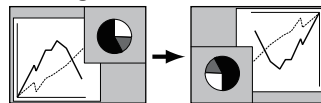

Rear

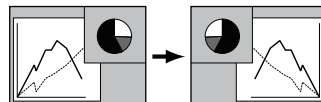

✓ Note:

- The minimum compression ratio is limited depending on the input signal, when the Keystone function is working or when the custom is selected for the screen size.
- True** and **Digital zoom +/-** are disabled and cannot be displayed when **480i**, **575i**, **480p** **575p**, **720p**, **1035i** or **1080i** is selected in the PC System Menu (p.31).
- Digital zoom +/-** cannot be selected when **True** is selected.
- The minimum compression ratio is limited at Normal screen size.
- Natural wide** cannot be selected when **720p**, **1035i**, **1080i** or **1080p** is selected on AV System Menu (p.43).
- When the 16:9 function is selected on Screen aspect menu, **16:9** is not available in the PC and AV screen (pp.39, 49).
- When the 4:3 function is selected on Screen aspect menu, **Natural wide** is not available in the AV screen (p.49).

VIDEO Input

Input Source Selection (VIDEO, S-VIDEO)

Direct Operation

Choose **VIDEO** or **S-VIDEO** by pressing the VIDEO or the S-VIDEO button on the remote control unit.

Remote control unit

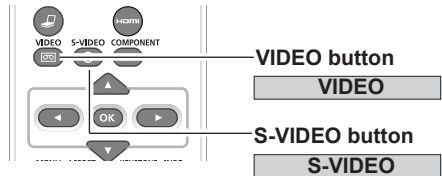

Menu Operation

- 1 Press the MENU button to display the On-Screen Menu. Use the Point ▲▼ buttons to select **Input** and then press the Point ► or the OK button.
- 2 Use the Point ▲▼ buttons to select **VIDEO** and then press the OK button.

VIDEO When video input signal is connected to the VIDEO jack, select **VIDEO**.

Use the Point ▲▼ buttons to select **COMPUTER**. And then press the Point ► button to access the submenu items. Use the Point ▲▼ buttons to select the **S-VIDEO** and then press the OK button.

S-VIDEO When the input source is coming from video equipment connected to the COMPUTER IN/S-VIDEO IN/COMPONENT IN terminal with a S-VIDEO-VGA cable, select **S-VIDEO**.

VIDEO

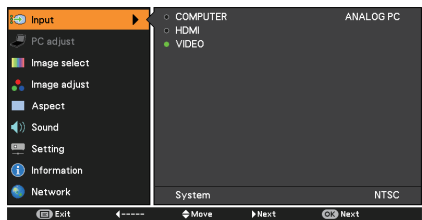

S-VIDEO

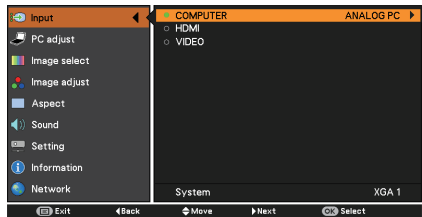

Press the Point ▲▼ buttons to select **S-VIDEO**.

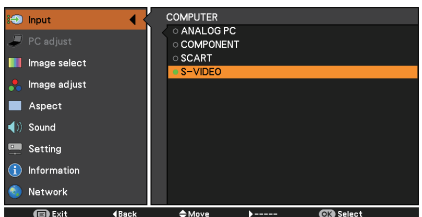

Note:

When the Auto input function is set to **On 1** or **On 2** in the Auto setup function, the input signal will be searched automatically (p.52).

VIDEO Input

Input Source Selection (COMPONENT, SCART, HDMI)

Direct Operation

Choose **COMPUTER (COMPONENT)** or **COMPUTER (SCART)** by pressing the **COMPONENT** or the **COMPUTER** button on the remote control unit. Choose **HDMI** by pressing the **HDMI** button on the remote controller.

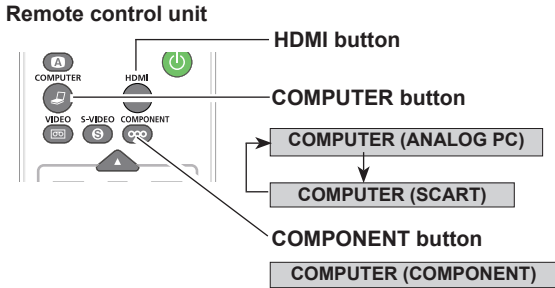

Menu Operation

- 1 Press the **MENU** button to display the On-Screen Menu. Use the Point **▲▼** buttons to select **Input** and then press the Point **▶** or the **OK** button.
- 2 Use the Point **▲▼** buttons to select **COMPUTER** and then press the Point **▶** button.
- 3 Use the Point **▲▼** buttons to select **COMPONENT** or **SCART** and then press the **OK** button.

COMPONENT When the input source is coming from video equipment connected to the **COMPUTER IN/S-VIDEO IN/COMPONENT IN** terminal with a **COMPONENT-VGA Cable**, select **COMPONENT**.

SCART When the input source is coming from video equipment connected to the **COMPUTER IN/S-VIDEO IN/COMPONENT IN** terminal with a **Scart-VGA Cable**, select **SCART**.

HDMI When video input signal is connected to the **HDMI** jack, select **HDMI**.

✓ **Note:**
When the Auto input function is set to **On 1** or **On 2**, the input signal will be searched automatically (p.52).

Input Menu

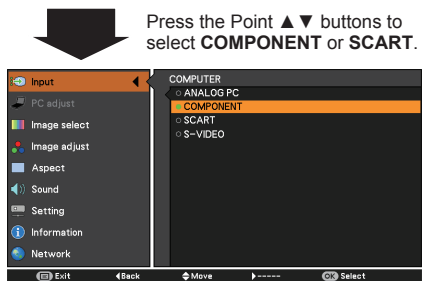
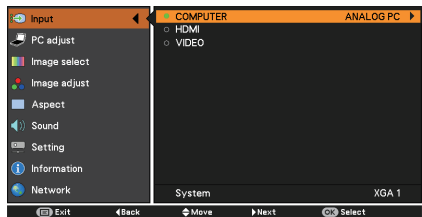
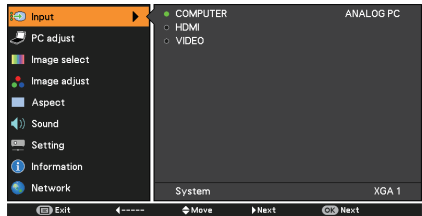

VIDEO System Selection

- 1 Press the MENU button to display the On-Screen Menu. Use the Point ▲▼ buttons to select **Input** and then press the Point ► or the OK button.
- 2 Select **VIDEO**, **COMPUTER (S-VIDEO)** or **COMPUTER (COMPONENT)** input source. (pp. 41-42)
- 3 Use the Point ▲▼ buttons to select **System** and then press the Point ► or the OK button. Use the Point ▲▼ buttons to select the desired system and then press the OK button.

VIDEO or S-VIDEO

Auto

The projector automatically detects an incoming video system, and adjusts itself to optimize its performance. When VIDEO System is **PAL-M** or **PAL-N**, select the system manually.

PAL/SECAM/NTSC/NTSC4.43/PAL-M/PAL-N

If the projector cannot reproduce proper video image, select a specific broadcast signal format from among **PAL**, **SECAM**, **NTSC**, **NTSC 4.43**, **PAL-M** and **PAL-N**.

COMPONENT

Auto

The projector automatically detects an incoming video signal, and adjusts itself to optimize its performance.

COMPONENT VIDEO SIGNAL FORMAT

If the projector cannot reproduce proper video image, select a specific component video signal format from among **480i**, **575i**, **480p**, **575p**, **720p**, **1035i** and **1080i**.

✓ Note:

The AV System Menu cannot be selected when selecting **SCART**.

AV System Menu (VIDEO or S-VIDEO)

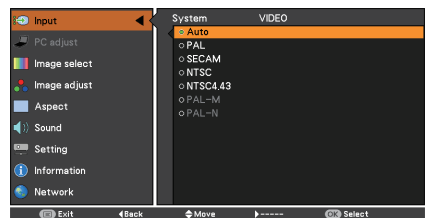
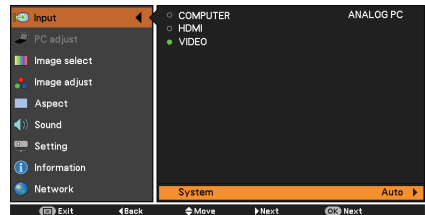

AV System Menu (COMPONENT)

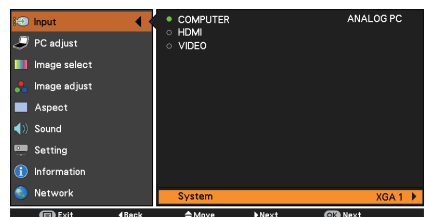

Image Mode Selection

Direct Operation

Select the desired image mode among **Presentation, Standard, High contrast, Cinema, Blackboard (Green), Colorboard, User 1, User 2, User 3** and **User 4** by pressing the IMAGE button on the remote control unit.

Remote control unit

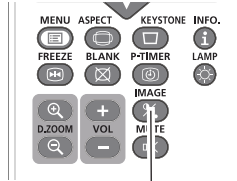
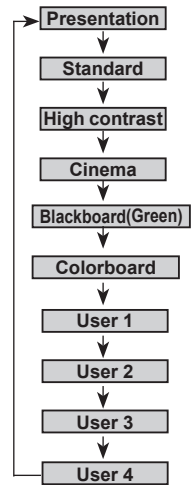

IMAGE button

IMAGE button



Menu Operation

- 1 Press the MENU button to display the On-Screen Menu. Use the Point ▲▼ buttons to select **Image select** and then press the Point ► or the OK button.
- 2 Use the Point ▲▼ buttons to select the desired item and then press the OK button.

Presentation

For viewing pictures in a bright room.

Standard

Normal picture mode preset on the projector.

High contrast

Picture mode with improved halftone for graphics.

Cinema

Picture mode adjusted with fine tone.

Blackboard (Green)

For the image projected on a blackboard. This mode helps enhance the image projected on a blackboard. This is mainly effective on a green colored board, not truly effective on a black colored board.

Colorboard

At the time of simple projection on the colored wall, you can get the close color image to the color image projected on a white screen by selecting the similar color to the wall color from the preset four colors.

Use the Point ▲▼ buttons to select **Colorboard** and then press the Point ► or the OK button to access the submenu. Press the Point ▲▼ buttons to select items among Red, Blue, Yellow and Green.

User 1-4

For viewing with the user preset image mode in the Image Adjust Menu (p. 46).

Image select Menu

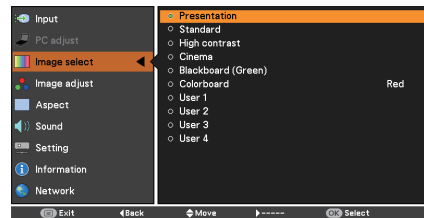
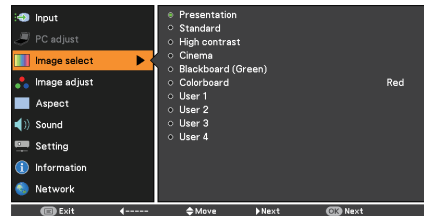

Image Adjustment

- 1 Press the MENU button to display the On-Screen Menu. Use the Point ▲▼ buttons to select **Image adjust** and then press the Point ► or the OK button.
- 2 Use the Point ▲▼ buttons select the desired item and then press the OK button to display the adjustment dialog box. Use the Point ◀▶ buttons to adjust the setting value.

Contrast

Press the Point ◀ button to decrease the contrast; press the Point ► button to increase the contrast (from 0 to 63).

Brightness

Press the Point ◀ button to decrease the brightness; press the Point ► button to increase the brightness (from 0 to 63).

Color

Press the Point ◀ button decrease the intensity of the color; press the Point ► button increase the intensity of the color (from 0 to 63).

Tint

Press the Point ◀▶ buttons to adjust the tint value to get a proper color balance (from 0 to 63).

Auto iris*

Press the Point ◀▶ buttons to select **Off** or **On**.
Off Disabled.

On The Auto iris function is activated.

* Auto iris is only for LV-7292A, LV-7297A, LV-7392A, LV-8227A.

Color temp.

Use the Point ◀▶ buttons to select the desired Color temp. level (**XLow**, **Low**, **Mid** or **High**).

White balance (Red / Green / Blue)

Press the Point ◀ button to lighten R/G/B tone; press the Point ► button to deepen R/G/B tone (from 0 to 63).

Sharpness

Press the Point ◀ button to decrease the sharpness of the image; press the Point ► button to increase the sharpness of the image (from 0 to 15).

Gamma

Use the Point ◀▶ buttons to adjust the gamma value to obtain a better balance of contrast (from 0 to 15).

✓ Note:

- When the **White balance Red**, **Green** or **Blue** is adjusted, the Color temp. level will change to **User**.
- **Tint** cannot be selected when the video system is **PAL**, **SECAM**, **PAL-M** or **PAL-N** (p. 43).
- When **Blackboard (Green)** or **Colorboard** is selected in Image select, **Color temp.** will change to **Blackboard** or **Colorboard**.

Image Adjust Menu

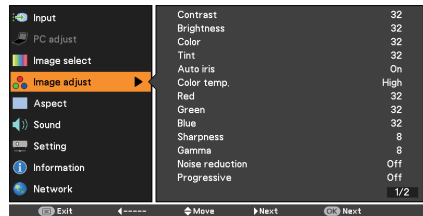

Selected Image mode



Use the Point ◀▶ buttons to adjust the setting value.



VIDEO Input

Noise reduction

Noise interference on the screen can be reduced. Select one of the following options to get smoother images.

- Off..... Disabled.
- L 1..... Lower reduction
- L 2..... Higher reduction

Progressive

An interlaced video signal can be displayed in progressive mode. Select one of the following options.

- Off..... Disabled.
- L 1..... For an active picture.
- L 2..... For a still picture.
- Film For watching a film. With this function, the projector reproduces pictures faithful to the original film quality.

Reset

To reset the adjusted data, select **Reset** and press the OK button. A confirmation box appears and then select **Yes**. All adjustments will return to their previous figures.

Store

To store the adjusted data, select **Store** and press the Point ► or the OK button. Use the Point ▲ ▼ buttons to select one from **User 1** to **User 4** and press the OK button. A confirmation box appears and then select **Yes**. Stored data can be called up by selecting an **User (1-4)** in the Image Mode Selection on page 44.

Store Menu

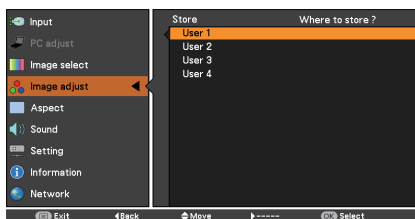

A confirmation box appears and then select **Yes**.

✓Note:

Noise reduction and **Progressive** can not be selected when the input signal is **480p, 575p, 720p, 1035i or 1080i** (p.43).

Aspect Setting (For LV-7292A, LV-7297A, LV-7392A, LV-7292M, LV-7297M)

This projector has the picture screen resize function, which enables you to customize the image size.

- 1 Press the MENU button to display the On-Screen Menu. Use the Point ▲▼ buttons to select **Aspect** and then press the Point ► or the OK button.
- 2 Use the Point ▲▼ buttons select the desired item and then press the OK button.

Normal

Provide the image to fit the screen size while maintaining the aspect ratio of the input signal.

Full

Provide the full screen image.

16:9

Provide the image at the 16:9 wide screen ratio.

Zoom

Pan the horizontal direction of the image and cut the vertical direction of the image to fit the screen size (16:9). Only for 4:3 video aspect ratio signals.

Custom

Provide the last stored aspect screen image.

Custom adj.

Adjust the screen scale and position manually with this function.

Press the Point ► button at **Custom adj.** and the Custom adjustment menu is displayed on the screen, you can use the Point ▲▼ buttons to choose the item you want to adjust.

Scale H/V Adjust the Horizontal/Vertical screen scale.

H&V When set to **On**, the aspect ratio is fixed. The **Scale V** appears dimmed and becomes unavailable. Adjust **Scale H**, then the screen scale is automatically modified based on the aspect ratio.

Position H/V.. Adjust the Horizontal/Vertical screen position.

Common Save the adjusted scale or position to all the inputs. Press the OK button at **Common** to display a confirmation box. To save the scale or position, press the OK button at **Yes**. When **Custom** is selected, the saved scale or position is used.

Reset Reset the all adjusted values. Press the OK button at **Reset** to display a confirmation box. To reset, press the OK button at **Yes**.

Aspect Menu

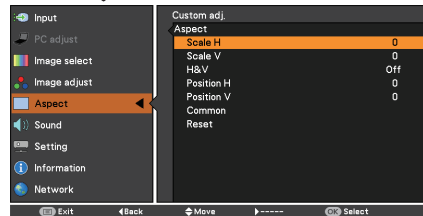

✓Note:

- When no signal is detected, **Normal** is set automatically and the Aspect adjustment menu disappears.
- The adjustable range for **Scale H/V** and **Position H/V** is limited depending on the input signal.

Keystone

This function is used to adjust keystone distortion of the projected image. Use the Point ▲ ▼ buttons to choose the item you want to adjust.

Keystone

To correct keystone distortion, press the OK button.

Keystone appears on the screen. Use the Point ▲ ▼ buttons to correct keystone distortion (p. 26).

Store

To store or reset the keystone correction, press the Point ► button.

StoreKeep the keystone correction even when the AC power cord is plugged out or turned off the projector.

Reset.....Release the keystone correction when the AC power cord is plugged out.

Keystone



Press the OK button.



Ceiling

When this function is set to **On**, the picture will be top/bottom and left/right reversed. This function is used to project the image from a ceiling-mounted projector.

Ceiling

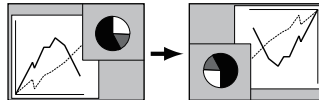

Rear

When this function is set to **On**, the picture will be left/right reversed. This function is used to project the image from rear of the screen.

Rear

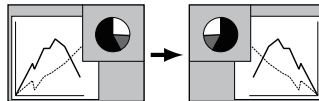

Reset

To reset the adjusted data, select Reset and press the OK button. A confirmation box appears and then select Yes. All adjustments will return to their previous figures.

Aspect Setting (For LV-8227A, LV-8227M)

This projector has the picture screen resize function, which enables you to customize the image size.

- 1 Press the MENU button to display the On-Screen Menu. Use the Point ▲▼ buttons to select **Aspect** and then press the Point ► or the OK button.
- 2 Use the Point ▲▼ buttons select the desired item and then press the OK button.

Normal

Provide the image to fit the screen size while maintaining the aspect ratio of the input signal.

Full

Provide the full screen image.

16:9

Provide the image at the 16:9 wide screen ratio.

Zoom

Pan the horizontal direction of the image and cut the vertical direction of the image to fit the screen size (16:9). Only for 4:3 video aspect ratio signals.

Natural wide

Expand the right and left sides of images naturally without changing the center areas.

Custom

Provide the last stored aspect screen image.

Custom adj.

Adjust the screen scale and position manually with this function.

Press the Point ► button at **Custom adj.**, and the Custom adjustment menu is displayed on the screen, you can use the Point ▲▼ buttons to choose the item you want to adjust.

Scale H/V Adjust the Horizontal/Vertical screen scale.

H&V When set to **On**, the aspect ratio is fixed. The **Scale V** appears dimmed and becomes unavailable. Adjust **Scale H**, then the screen scale is automatically modified based on the aspect ratio.

Position H/V.. Adjust the Horizontal/Vertical screen position.

Common Save the adjusted scale or position to all the inputs. Press the OK button at **Common** to display a confirmation box. To save the scale or position, press the OK button at **Yes**. When **Custom** is selected, the saved scale or position is used.

Reset..... Reset the all adjusted values. Press the OK button at **Reset** to display a confirmation box. To reset, press the OK button at **Yes**.

Aspect Menu

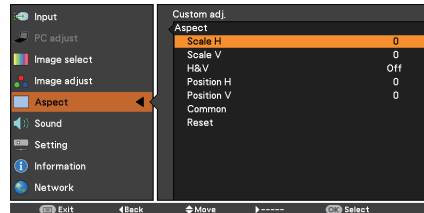
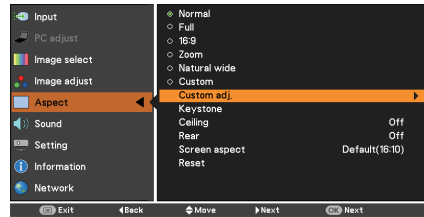

✓Note:

- When no signal is detected, **Normal** is set automatically and the Aspect adjustment menu disappears.
- The adjustable range for **Scale H/V** and **Position H/V** is limited depending on the input signal.
- **Natural wide** cannot be selected when **720p**, **1035i**, **1080i** or **1080p** is selected on AV System Menu (p.43).

VIDEO Input

Keystone

This function is used to adjust keystone distortion of the projected image. Use the Point ▲▼ buttons to choose the item you want to adjust.

Keystone

To correct keystone distortion, press the OK button.

Keystone appears on the screen. Use the Point ▲▼ buttons to correct keystone distortion (p. 26).

Store

To store or reset the keystone correction, press the Point ► button.

StoreKeep the keystone correction even when the AC power cord is plugged out or turned off the projector.

Reset.....Release the keystone correction when the AC power cord is plugged out.

Keystone



Press the OK button.



Ceiling

When this function is set to **On**, the picture will be top/bottom and left/right reversed. This function is used to project the image from a ceiling-mounted projector.

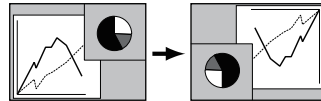

Rear

When this function is set to **On**, the picture will be left/right reversed. This function is used to project the image from rear of the screen.

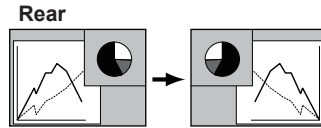

Screen aspect

This function is used to project the image to a 4:3 or 16:9 projection screen.

Default (16:10)16:10 is the aspect of the LCD panel. The original Screen Menu is available.

16:9Set to a 16:9 projection screen.

4:3Set to a 4:3 projection screen.

Reset

To reset the adjusted data, select Reset and press the OK button. A confirmation box appears and then select "Yes". All adjustments will return to their previous figures.

✓Note:

- When the 16:9 function is selected on Screen aspect menu, **16:9** is not available in the PC and AV screen (pp.39, 49).
- When the 4:3 function is selected on Screen aspect menu, **Natural wide** is not available in the AV screen (p.49).

Setting

Setting

This projector has a Setting menu that allows you to set up the other various functions described below.

- 1 Press the MENU button to display the On-Screen Menu. Press the Point ▲▼ buttons to select **Setting** and press the Point ► or the OK button to access the submenu items.
- 2 Use the Point ▲▼ buttons to select the desired item and then press the Point ► or the OK button to access the selected item.
- 3 Use the Point ▲▼ buttons to select the desired item and then press the OK button.

Setting Menu

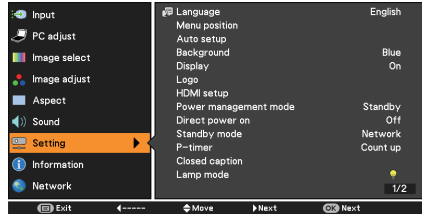

Language

The language used in the On-Screen Menu is available in English, German, French, Italian, Spanish, Portuguese, Dutch, Swedish, Finnish, Polish, Hungarian, Romanian, Russian, Turkish, Kazakh, Vietnamese, Chinese, Korean, Japanese and Thai.

Menu position

This function is used to change the position of the On-Screen Menu. Select **Menu position** and press the OK button.

The Menu position changes each time you press OK button as follows.
the center → the bottom left → the bottom right → the top left → the top right→.....

Language

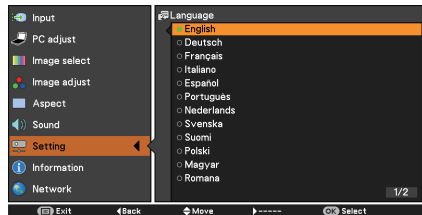
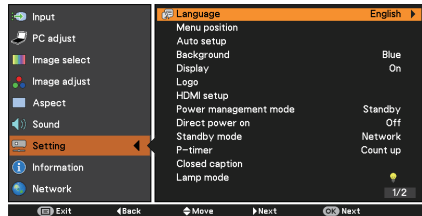

Auto setup

This function enables Auto input, Auto Keystone correction and Auto PC adjustment by pressing the AUTO SET button on the top control or the remote control unit. Settings for those functions can be altered as follows:

Auto input

This function detects the input signal automatically. When a signal is found, the search will stop. Use the Point ▲▼ buttons to select one of the following options.

- Off** Auto input does not work.
- On 1** Auto input works under the following situation.
 - When pressing the AUTO SET button on the top control or the remote control unit.
- On 2** Auto input works under the following situation.
 - When turning on the projector by pressing the POWER button on the top control or the remote control unit.
 - When pressing the AUTO SET button on the remote control unit or the top control.
 - When the current input signal is cut off.*

* If the Blank or Freeze function is active, cancel it to activate the Auto input. It is also unavailable when On-Screen menu is displayed.

Auto PC

- On** Enables Auto PC Adjustment when pressing the AUTO SET button on the remote control unit or the top control.
- Off** Disables Auto PC Adjustment.

Auto Keystone

- Auto** Always works and corrects keystone distortion according to the projector's tilt.
- Manual** ... Works only when pressing the AUTO SET button on the top control or the remote control unit.
- Off** Disables Auto Keystone.

✓ Note:

- While **Auto input** is set to **On 1** or **On 2**, the status of Input and Lamp are displayed every time the signal is switched.
- Only the last selected input source can be detected.

Auto setup

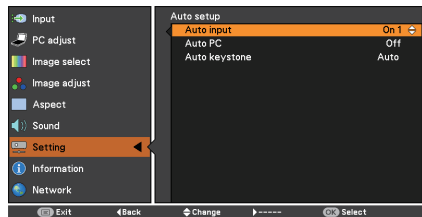
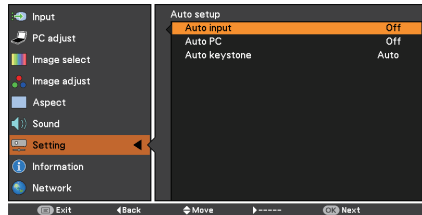
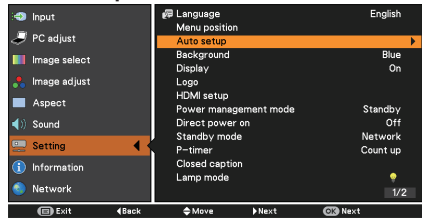

✓ Note:

- During **Auto input** is in progress, If the MENU button or the POWER button is pressed, **Auto input** will stop. If the COMPUTER button or VIDEO or COMPONENT or S-VIDEO or HDMI button is pressed, **Auto input** will stop and go back to the button's input signal.
- **Auto input**, **Auto PC** and **Auto Keystone** can not be set **Off** at the same time.
- **Auto Keystone** corrects vertical distortion only, not correct horizontal distortion.
- The Auto Keystone function can not work when the Ceiling feature is set **On** in the Screen menu (pp. 38, 40, 48, 50).
- Perfect correction of the image distortion can not be ensured with the Auto setup function. If the distortion is not corrected properly by pressing the AUTO SET button, adjust manually by pressing the KEYSTONE button on the remote control unit or selecting **Keystone** in the Setting menu (pp. 26, 38, 40, 48, 50).
- **Fine sync**, **Total dots**, **Horizontal position** and **Vertical position** of some computers cannot be fully adjusted with the Auto PC Adjustment function. When the image is not provided properly with this operation, manual adjustments are required (pp. 33-34).

Background

Select the background screen for when no input signal is detected. Press the Point ▲▼ buttons to switch between each option.

Blue.....Project a blue background.

User.....Project an image captured in the Logo setting.

Black.....Project a black background.

Display

This function decides whether to display On-Screen Displays.

On..... Show all the On-Screen displays. Use this function when you want to project images after the lamp becomes bright enough. The factory default setting is in this option.

Countdown Off... Show the input image instead of the countdown when turning on the projector. Use this function when you want to project the image as early as possible even when the lamp is not bright enough.

Off..... Hide the On-Screen Displays except;

- On-Screen Menu.
- **Power off?** (p. 23)
- **P-Timer display.** (p. 29)
- **No signal** for Power management (p. 56)
- **Please wait ...**
- Arrows for the True function in the Aspect Menu. (p. 39)

Logo (Logo and Logo PIN code lock settings)

This function allows you to customize the screen logo with **Logo select**, **Capture**, **Logo PIN code lock** and **Logo PIN code change** functions.

✓ Note:

When **On** is selected in the Logo PIN code lock function, **Logo select** and **Capture** functions cannot be selected.

Logo select

This function decides on the starting-up display from among following options.

User..... Show the image you captured.

Default... Show the factory-set logo.

Off..... Show the countdown display only.

Logo select

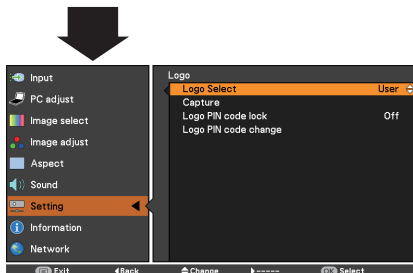
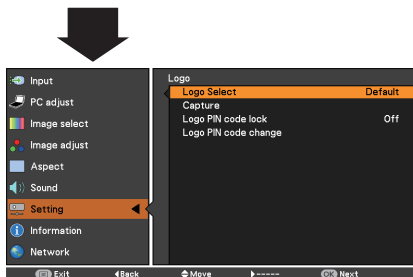
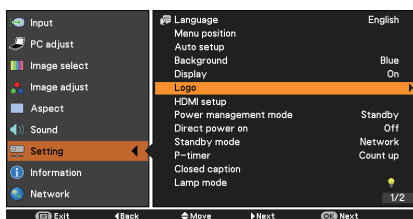

Setting

Capture

This function enables you to capture an image being projected to use it for a starting-up display or interval of presentations.

Select **Capture** and press the OK button. A confirmation box appears and select **Yes** to capture the projected image.

After capturing the projected image, go to the Logo select function and set it to **User**. Then the captured image will be displayed the next time you turn on the projector or when you press the BLANK button (p 29).

To cancel the capture function, select **Yes** in the "Quit?" confirmation box.

✓Note:

- Before capturing an image, select **Standard** in the Image select Menu to capture a proper image (pp. 35,44).
- A signal from a computer can be captured up to panel size (1024 x 768). (Only for LV-7292A, LV-7297A, LV-7392A, LV-7292M, LV-7297M)
- A signal from a computer can be captured up to panel size WXGA (1280 x 800). A signal from video equipment can be captured except for **1035i** and **1080i**. (Only for LV-8227A, LV-8227M)
- When capturing the image that has been adjusted by the Keystone function, the adjusted data is automatically reset and the projector captures an image without keystone correction.
- When Logo PIN code lock function is set to **On**, **Logo select** and **Capture** can not be selected.
- When starting to capture a new image, the previously stored image is cleared even if you cancel the capturing.
- When there is no captured image or it is interrupted while capturing an image, **User** can not be selected, you can only switch between **Default** and **Off**.

Capture

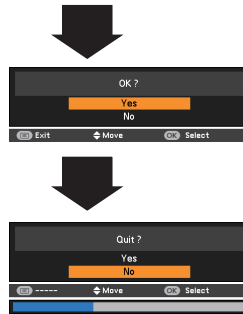
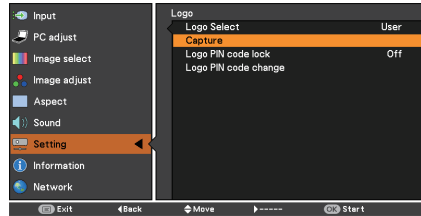

Logo PIN code lock

This function prevents an unauthorized person from changing the screen logo.

Off..... The screen logo can be changed freely from the Logo Menu (p. 53).

On..... The screen logo cannot be changed without a Logo PIN code.

If you want to change the **Logo PIN code lock** setting, press the OK button and the Logo PIN code dialog box appears. Enter a Logo PIN code by following the steps below. The initial **Logo PIN code** is set to "4321" at the factory.

Logo PIN code lock

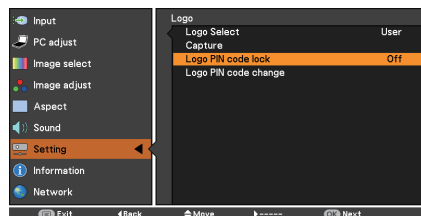

Enter a Logo PIN code

Use the Point ▲▼ buttons to enter a number. Press the Point ◀▶ buttons to fix the number and move the red frame pointer to the next box. The number changes to *. If you fixed an incorrect number, use the Point ◀▶ buttons to move the pointer to the number you want to correct, and then enter the correct number.

Repeat this step to complete entering a four-digit number.

After entering the four-digit number, move the pointer to **Set**. Press the OK button so that you can start to operate the projector.

If you entered an incorrect Logo PIN code, **Logo PIN code** and the number (****) will turn red for a moment. Enter the correct Logo PIN code all over again.

Change the Logo PIN code lock setting

Use the Point ▲▼ buttons to switch **On** or **Off**, and then press the OK button to make a choice.

Logo PIN code change

Logo PIN code can be changed to your desired four-digit number. Press the OK button to select **Logo PIN code change**. **Current logo PIN code** dialog box appears, use the Point ▲▼ buttons to enter the correct code. The New Logo PIN code input dialog box appears. Set a new Logo PIN code, confirmation box appears, choose **Yes** to set the new Logo PIN code.

Be sure to note the new Logo PIN code and keep it on hand. If you lost the number, you could no longer change the Logo PIN code setting.

CAUTION:

WHEN YOU HAVE CHANGED THE LOGO PIN CODE, WRITE DOWN THE NEW LOGO PIN CODE AS A REMINDER. SHOULD THE LOGO PIN CODE BE LOST OR FORGOTTEN, THE LOGO PIN CODE SETTING CAN NO LONGER BE CHANGED.

✓ Note:

If you forget your Logo PIN code and unable to change it, the Logo PIN code can be reset to the factory default setting (4321) according to the following procedures.

When you reset the Logo PIN code, the PIN code and Key lock will be reset, as well.

1. Unplug the AC Power Cord from the AC outlet.
2. Hold down the OK button on the projector and connect the AC Power Cord into the outlet again. Keep holding down the OK button until the POWER indicator lights. The Logo PIN code returns to the factory default setting while the Logo PIN code lock state will remain the same as the previous set state.

Enter a Logo PIN code

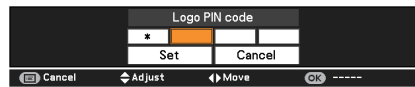

After a correct Logo PIN code is entered, the following dialog box appears.

Change the Logo PIN code lock setting

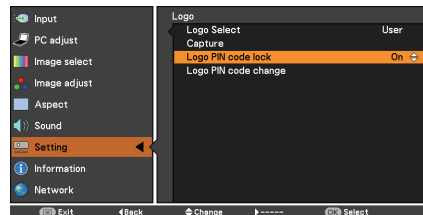

Change the Logo PIN code

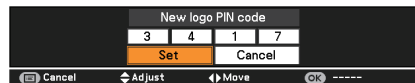
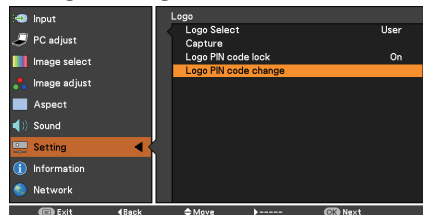

Setting

HDMI setup

This function is only used for HDMI input source.

Image

Select **Normal** or **Enhanced** to match the video range setting of your HDMI Digital RGB equipment.

Sound

HDMI: When using the HDMI cable, select **HDMI**. Both video and audio are transferred and you need not to connect any additional cables for audio.

COMPUTER: When using the DVI-HDMI cable, select **COMPUTER** and connect the audio cable to COMPUTER IN terminal.

The names for the output setting of Digital RGB vary from equipment to equipment. For details, refer to the user's manual of your Digital RGB equipment.

When the black parts of the image are destroyed or stand out, please switch to **Normal** or **Enhanced**, and then switch the output type of the HDMI Digital RGB output equipment.

Power management mode

For reducing power consumption as well as maintaining the lamp life, the Power management mode function turns off the projection lamp when the projector is not operated for a certain period.

Select one of the following options:

Standby..... When the lamp has been fully cooled down, the POWER indicator changes to green blinking. In this condition, the projection lamp will be turned on if the input signal is reconnected or any button on the top control or remote control unit is pressed.

Exit..... When the lamp has been fully cooled down, the power will be turned off.

Off..... Power management mode function is off.

Timer..... If the input signal is interrupted and no button is pressed for more than 30 seconds, the timer display with **No signal** appears. It starts the countdown until the lamp is turned off. Use the Point ▲▼ buttons to set the Timer (1~30min).

✓Note:

Factory default is **Standby: 5 min.**

Direct power on

When this function is set to **On**, the projector will be automatically turned on just by connecting the AC power cord to a wall outlet.

HDMI setup

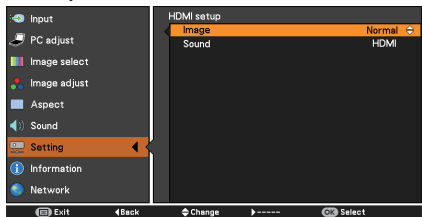

Power management mode



Time left before Lamp is off.

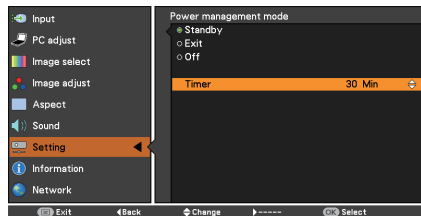
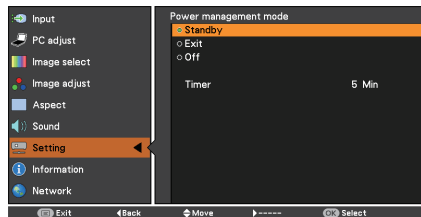

✓Note:

Be sure to turn off the projector properly (see "Turning Off the Projector" on page 23). If the projector is turned off in the incorrect sequence, the Direct power on function will not work properly.

Standby mode

This function is available when operating the projector via network.

For LV-7292A, LV-7297A, LV-7392A, LV-8227A:

Network.. Supply the power to the network function even after turning off the projector by pressing the POWER button on the remote control unit.

Eco Select **Eco** when you do not use the projector via network. The projector's network function will stop when turning off the projector, you can not turn on the projector via network.

Refer to the user's manual of "Network Set-up and Operation".

For LV-7292M, LV-7297M, LV-8227M:

Serial Does not restrict functionality even in standby mode.

Eco Restricts some functions in standby mode to reduce power consumption.

P-timer

This function allows you to change the setting of the P-timer and execute it.

Select one of the following options:

Count up The P-timer display **000:00** appears on the screen and the count up starts (**000:00-180:00**)

Count down .. The time set in the Timer setting appears on the screen and the countdown starts.

Timer Use the Point **▲▼** buttons to set the Timer (**1-180 Min**). **Timer** is available in Count down only. Factory default value is **10 Min**.

Start It executes the count up or count down function. Press the OK button at **Start** and the indication changes into Stop. To stop **Count up** or **Count down**, press the OK button at **Stop** on the screen menu, then the indication changes into **Restart**. Press the OK button at **Restart** to resume **Count up** or **Count down**.

Reset Reset the P-timer values. Press the OK button at **Reset** to return to the following value;

Count up ... "000:00"
Count down ... Timer that you set

Exit To exit the P-timer operation.

X: disabled O: enabled

	Eco	Network/Serial
Serial command	X	O
Network*2	X	O
Audio Out	X	X *1
Direct power on	O	O

*1 When switch the STANDBY MIC OUT function **On** in Standby mode status, only MIC volume can be output.

*2 **Network** is only for LV-7292A, LV-7297A, LV-7392A, LV-8227A.

✓Note:

- When selecting **Network**, the cooling fans may be running depending on the temperature inside the projector even if the projector is turned off.
- When **Eco** is selected and the projector is in Standby mode, the communication of RS-232C serial port is not available.
- Network** is only for LV-7292A, LV-7297A, LV-7392A, LV-8227A.

P-TIMER



111:11

P-timer display

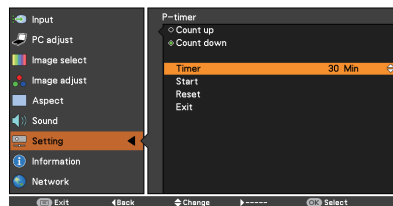
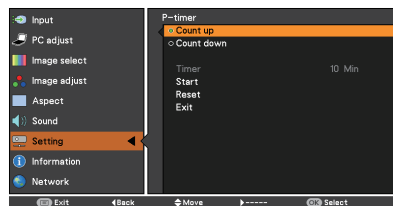
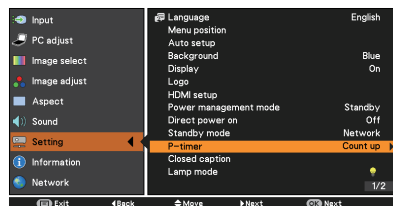

Stop or Cancel the P-timer via Remote control unit

To stop the P-timer function, press the P-TIMER button. To cancel the P-timer, press and hold the P-TIMER button for a few seconds.

Closed Caption

Closed Caption is a printed version of the program sound or other information displayed on the screen. If the input signal contains closed captions, you can turn on the feature and switch the channels. Press the Point ▲▼ buttons to select **Off**, **CC1**, **CC2**, **CC3** or **CC4**. If the closed caption is not clear, you can change the text from **Color** to **White**.

Closed Caption

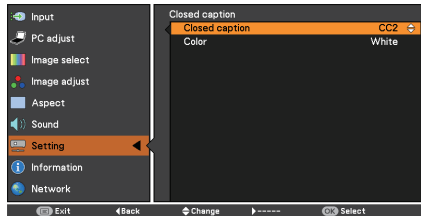
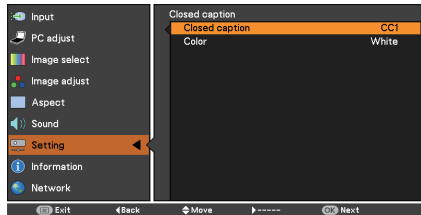
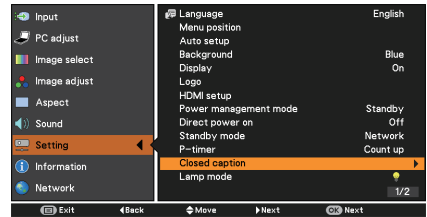

Press the Point ▲▼ buttons to select **Off**, **CC1**, **CC2**, **CC3** or **CC4**, and then press the OK button.

✓Note:

The Closed Caption is available only under the situation below.

- When the input signal is **COMPONENT** (for adjustment only), **VIDEO** or **S-VIDEO**, and the system is set to **Auto**, **NTSC** or **480i**, the Closed caption is available.
- If the system is set to **Auto**, and choose **NTSC** or **480i** as the input signal, the Closed caption function will be available.
- **Closed caption** will be unavailable when under other setting conditions.
- The Closed caption function is unavailable when On-Screen menu and P-timer are displayed.
- The menu items of Closed Caption are displayed in gray while it is not available.

Lamp mode

This function allows you to change brightness of the screen.

- 💡 High..... Brighter than the Normal mode.
- 💡 Normal Normal brightness
- 💡 Eco..... Lower brightness reduces the lamp power consumption and extends the lamp life.

✓Note:

- Lamp mode can not be changed for a while after turning on the projector. Lamp needs some time to stabilize after the power is turned on. Stored lamp mode will be active after the lamp is stabilized.

Remote control

This projector provides two different remote control codes: the factory-set initial code (**Code 1**) and the secondary code (**Code 2**). This switching function prevents remote control unit interference when operating several projectors or video equipment at the same time.

When operating the projector in **Code 2**, both the projector and the remote control unit must be switched to **Code 2**.

To change the code for the projector:

Select either **Code 1** or **Code 2** in this Setting Menu.

To change the code for the remote control unit:

Press and hold both the MENU and IMAGE buttons together for 5 seconds or more. After changing the code, make sure the remote control unit operates properly.

✓Note:

- When different codes are set on the projector and on the remote control unit, any operation cannot be made. In that case, switch the code on the remote control unit to fit the code on the projector.
- If the batteries are removed from the remote control unit for a long period of time, the remote control code will be reset.

Remote control

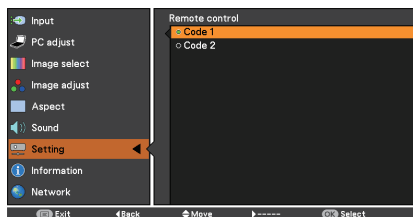





Security (Key lock and PIN code lock)

This function allows you to use the Key lock and PIN code lock function to set the security for the projector operation.

Key lock

This function locks the top control and remote control unit buttons to prevent operation by unauthorized persons.

Select **Key lock** and then press the OK button, and select the desired item by pressing the Point ▲▼ buttons.

-  Unlocked.
-  Lock the operation of the top control. To unlock, use the remote control unit.
-  Lock the operation of the remote control unit. To unlock, use the top control.

If the top control accidentally becomes locked and you do not have the remote control unit nearby or there is something wrong with your remote control unit, contact the dealer where you purchased the projector or the service center.

PIN code lock

This function prevents the projector from being operated by unauthorized persons and provides the following setting options for security.

- Off**..... Unlocked.
- On 1**..... Enter the PIN code every time turning on the projector.
- On 2**..... Enter the PIN code to operate the projector once the power cord is disconnected; as long as the AC power cord is connected, the projector can be operated without a PIN code.

Whenever you change the PIN code lock setting or the PIN code (the four-digit number), you are required to enter the PIN code. The "1234" is set as the initial PIN code at the factory.

If you want to change the PIN code lock setting, press the OK button and the PIN code dialog box appears.

When the projector is locked with the PIN code, the Security icon appears on the guide.

Key lock

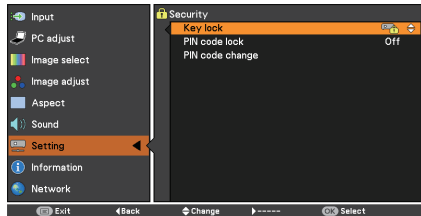
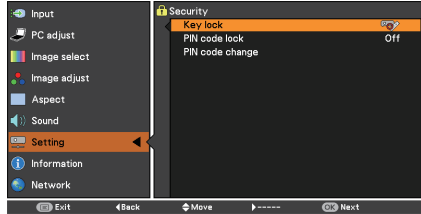

PIN code lock

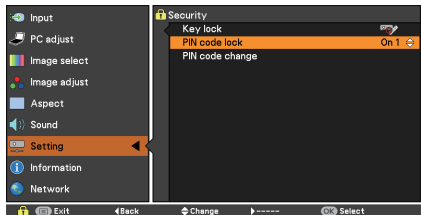

When the projector is locked with the PIN code, the Security icon appears on the guide.

Enter a PIN code

Use the Point ▲▼ buttons to enter a number. Press the Point ◀▶ buttons to fix the number and move the red frame pointer to the next box. The number changes to *. If you fixed an incorrect number, use the Point ◀▶ buttons to move the pointer to the number you want to correct, and then enter the correct number.

Repeat this step to complete entering a four-digit number.

After entering the four-digit number, move the pointer to **Set**. Press the OK button so that you can change the following PIN code lock setting.

If you entered an incorrect PIN code, **PIN code** and the number (****) will turn red for a moment. Enter the correct PIN code all over again.

Change the PIN code lock setting

Use the Point ▲▼ buttons to select **Off**, **On 1** or **On 2**, and then press the OK button to make a choice.

Change the PIN code

The PIN code can be changed to your desired four-digit number. Press the OK button to select **PIN code change**. Pin code dialog box appears, use the Point ▲▼ buttons to enter the correct code. The New PIN code input dialog box appears. Set a new PIN code.

CAUTION:

WHEN YOU HAVE CHANGED THE LOGO PIN CODE, WRITE DOWN THE NEW PIN CODE AS A REMINDER. IF YOU FORGET YOUR PIN CODE, THE PROJECTOR CAN NO LONGER BE STARTED.

✓ Note:

If you forget your PIN code and unable to change it, the PIN code can be reset to the factory default setting (1234) according to the following procedures.

When you reset the PIN code, the Logo PIN code and Key lock will be reset, as well.

1. Unplug the AC Power Cord from the AC outlet.
2. Hold down the OK button on the projector and connect the AC Power Cord into the outlet again. Keep holding down the OK button until the POWER indicator lights. The PIN code returns to the factory default setting while the PIN code lock state will remain the same as the previous set state.

Enter a PIN code

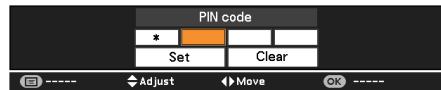

Change the PIN code

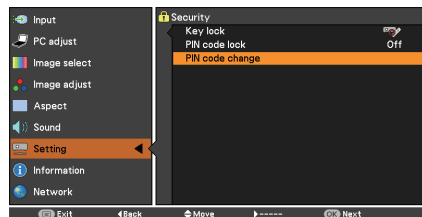

OK button

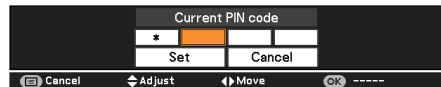

Enter current PIN code to confirm

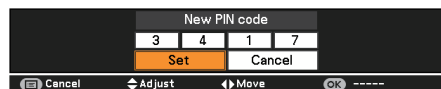

Enter new PIN code

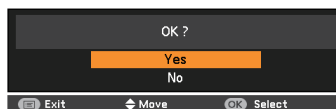

Select Yes to finish the new PIN code setting.

Setting

Fan

This function provides the following options in the cooling fans' operation when the projector is turned off (p.23).

- L 1.... Normal operation
- L 2.... Slower, lower-sound and longish-time than the normal operation (L 1).

Fan control

Choose the running speed of cooling fans from the following options according to the ground elevation under which you use the projector.

- Off**..... Normal speed. Set this function to Off when using the projector in non- high altitude environment.
- On 1**..... Faster than Off mode. Select this mode when using the projector in high altitudes (about 1,000 meters to 2,000 meters above the sea level) where the fans have less cooling effect.
- On 2**..... Faster than On 1 mode. Select this mode when using the projector in higher altitudes (about 2,000 meters to 3,000 meters above the sea level) where the fans have lesser cooling effect.

✓**Note:**
The fan noise becomes louder in **On 1** and **On 2**.

Video delay control

When you want to make a digital processing of a projected image faster, set this function. Use the Point ▲ ▼ buttons, select an item of **Off** or **On**.

✓**Note:**
Noise reduction and **Progressive** can not be selected when Video delay control function is set to **On**.

Lamp counter

Be sure to reset the Lamp replacement counter after the lamp is replaced. (p.68)

Press the Point ▲ ▼ buttons to choose the Lamp counter function and then press the Point ► or the OK button to access the submenu items.

Lamp counter.....This item shows the total accumulated time of the lamp usage.

Lamp counter reset.....Press the OK button to choose **Lamp counter reset**. Select **Yes** in the confirmation box if you want to reset the lamp counter, and then choose **Yes** in the second confirmation box to reset lamp counter.

Lamp counter reset

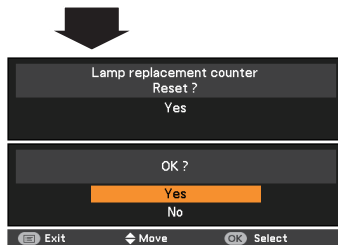
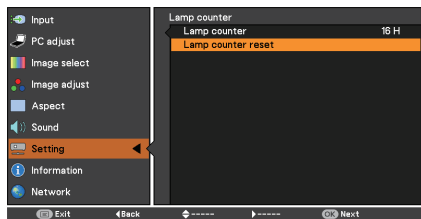

Filter counter

This function is used to set a frequency for the filter cleaning.

Use the Point ▲▼ buttons to select Filter counter and then press the Point ► or the OK button to access the submenu items.

Filter counter.....Show the total accumulated time of the filter use timer setting.

Timer..... To set a timer, when the projector reaches the time, the Filter warning icon (Fig.1) appears on the screen and the total accumulated time turns red, indicating that the filter replacement is necessary.

Filter counter reset... After replacing the filter, be sure to reset the timer. The Filter warning icon will not turn off until the filter counter is reset. For details about resetting the timer, refer to "Resetting the Filter Counter" on page 66.

Fig.1 Filter warning icon



Filter warning icon appears on the screen at a set time (**Off/2000H/3000H/4000H**).

✓ **Note:**

- This icon also appears at turning on.
- The Filter warning icon (Fig.1) will not appear when the Display function is set to **Off** (p.53), during **Freeze** (p.28), or **Blank** (p.29).

Warning log

This function records anomalous operations while the projector is in operation and use it when diagnosing faults. Up to 10 warning logs are displayed with the latest warning message at the top of the list, followed by previous warning messages in chronological order.

✓ **Note:**

When the Factory default function is executed, all the warning log records will be deleted.

Factory default

This function returns all setting values except for the **User logo**, **PIN code lock**, **Logo PIN code lock**, **Lamp counter** and **Filter counter** to the factory default settings.

Filter counter

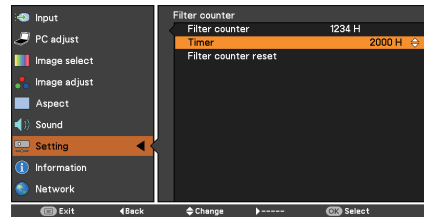

Press the OK button to select **Timer**, and then use the Point ▲▼ buttons to set the timer. Select from (**Off/2000H/3000H/4000H**) depending on the use environment.

Factory default

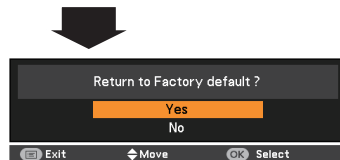
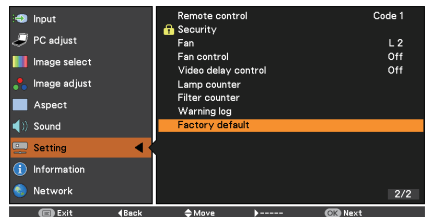

Information

Input Source Information Display

The Information Menu is used for checking the status of the image signal being projected and the operation of the projector.

Direct Operation

Press the INFO. button on the remote control unit to display the Information Menu.

Menu Operation

Press the Point ▲ ▼ buttons to select the Information. The Information Menu is displayed.

See below for displayed information.

Input

The selected input source is displayed.

H-sync freq.

The horizontal frequency of the input signal is displayed in **KHz**, or **----** **KHz** when no signal.

V-sync freq.

The vertical frequency of the input signal is displayed in **Hz**, or **----** **Hz** when no signal. Numbers of Hz doubles when during Interface.

Aspect

The selected Screen size is displayed.

Language

The selected language is displayed.

Lamp status

The selected lamp mode is displayed.

Lamp counter

The cumulative lamp operating time is displayed.

Power management mode

Off, **Standby** or **Exit**, and **Timer** are displayed.

Key lock

The selected Key lock icon is displayed.

PIN code lock

Off or **On 1** or **On 2** is displayed.

Remote control

The selected remote code is displayed.

SERIAL NO.

The serial number of the projector is displayed. The serial number is used to service the projector.

Remote control unit

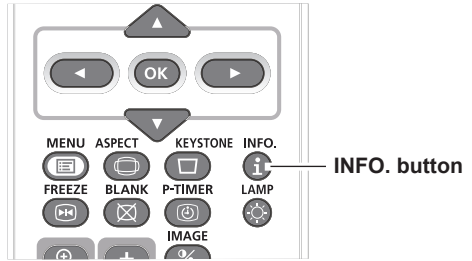

Information Menu

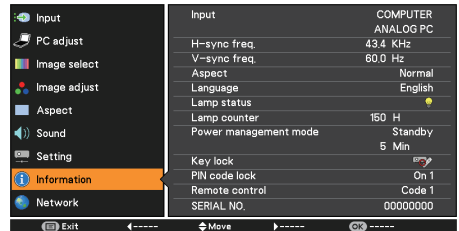

Maintenance and Cleaning

WARNING indicator

The WARNING indicator shows the state of the function which protects the projector. Check the state of the WARNING indicator and the POWER indicator to take proper maintenance.

The projector is shut down and the WARNING indicator is blinking red.

When the temperature inside the projector reaches a certain level, the projector will be automatically shut down to protect the inside of the projector. The POWER indicator is blinking while the projector is being cooled down. When the projector has cooled down enough (to its normal operating temperature), it can be turned on again by pressing the POWER button.

✓ **Note:**

The WARNING indicator continues to blink even after the temperature inside the projector returns to normal. When the projector is turned on again, the WARNING indicator stops blinking.

Top Control

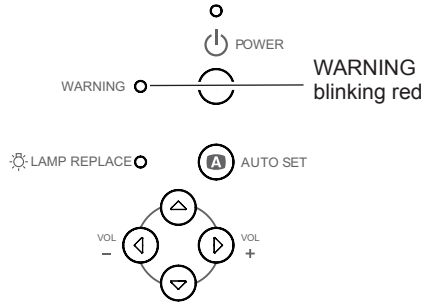

Then check the matters below:

- Did you provide appropriate space for the projector to be ventilated? Check the installing condition to see if the air vents of the projector are not blocked.
- Has the projector been installed near an Air-Conditioning/ Heating Duct or Vent? Move the installation of the projector away from the duct or vent.
- Is the filter clean? Clean the filter periodically.

The projector is shut down and the WARNING indicator lights red.

When the projector detects an abnormal condition, it is automatically shut down to protect the inside of the projector and the WARNING indicator lights red. In this case, unplug the AC power cord and reconnect it, and then turn the projector on once again to verify operation. If the projector cannot be turned on and the WARNING indicator still lights red, unplug the AC power cord and contact the service center.

Top Control

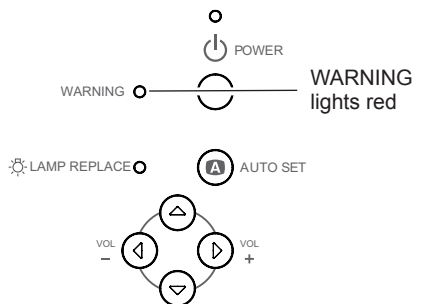

WARNING

DO NOT LEAVE THE PROJECTOR WITH THE AC POWER CORD CONNECTED UNDER AN ABNORMAL CONDITION. IT MAY RESULT IN FIRE OR ELECTRIC SHOCK.

Maintenance and Cleaning

Replacing the Filter

Filter prevents dust from accumulating on the optical elements inside the projector. Should the Filter become clogged with dust particles, it will reduce cooling fans' effectiveness and may result in internal heat buildup and adversely affect the life of the projector. If a "Filter warning" icon appears on the screen, replace the Filter immediately. Replace the filter by following the steps below.

- 1 Turn off the projector, and unplug the AC power cord from the AC outlet.
- 2 Place the latch in the OPEN position and pull out the filter in the arrow direction.
- 3 Slide the new filter (along the guide rails. Make sure that the filter is inserted completely.) Place the latch back in the LOCK position.
- 4 Connect the AC power cord to the projector and turn on the projector.
- 5 Reset the filter counter.

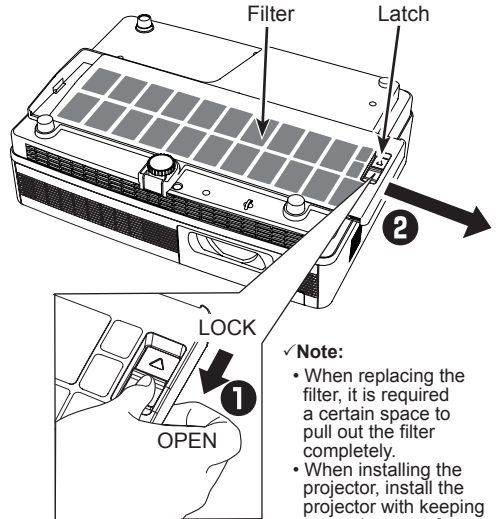

CAUTION

- Do not operate the projector with the filter removed. Dust may accumulate on the optical elements degrading picture quality.
- Do not put anything into the air vents. Doing so may result in malfunction of the projector.
- Do not wash the filter with water or any other liquid matter. Otherwise the filter may be damaged.

RECOMMENDATION

We recommend avoiding dusty/smoky environments when you operate the projector. Usage in these environments may cause poor image quality.

When using the projector under dusty or smoky conditions, dust may accumulate on a lens, LCD panels, or optical elements inside the projector degrading the quality of a projected image. When the symptoms above are noticed, contact your authorized dealer or service center for proper cleaning.

Note:

- When replacing the filter, it is required a certain space to pull out the filter completely.
- When installing the projector, install the projector with keeping a certain space for replacing the filter.

Resetting the Filter Counter

Be sure to reset the Filter counter after cleaning or replacing the filter.

- 1 Press the MENU button to display the On-Screen Menu. Use the Point ▲▼ buttons to select Setting and then press the Point ► or the OK button.
- 2 Use the Point ▲▼ buttons to select **Filter counter** and then press the Point ► or the OK button. Use the Point ▲▼ buttons to select **Filter counter reset** and then press the OK button. **Filter counter Reset?** appears. Select **Yes** to continue.
- 3 Another confirmation dialog box appears, select **Yes** to reset the Filter counter.

Filter counter reset



Filter counter Reset? appears.

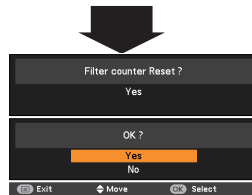

Select **Yes**, then another confirmation box appears.

Select **Yes** again to reset the Filter counter.

Attaching the Lens Cap

When moving this projector or while not using it over an extended period of time, attach the lens cap.

Attach the lens cap according to the following procedures.

- 1 Thread the string through the hole on the lens cap and then tie a knot in the string to secure it in place.
- 2 To pass the other end of the string into the hole on the bottom of the projector and pull at it.

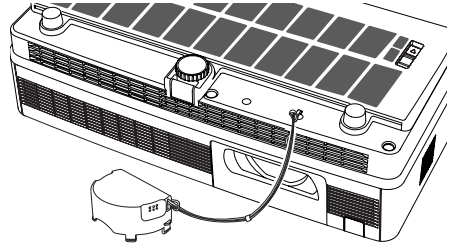

Cleaning the Projection Lens

Unplug the AC power cord before cleaning.

Gently wipe the projection lens with a cleaning cloth that contains a small amount of non-abrasive camera lens cleaner, or use a lens cleaning paper or commercially available air blower to clean the lens.

Avoid using an excessive amount of cleaner. Abrasive cleaners, solvents, or other harsh chemicals might scratch the surface of the lens.

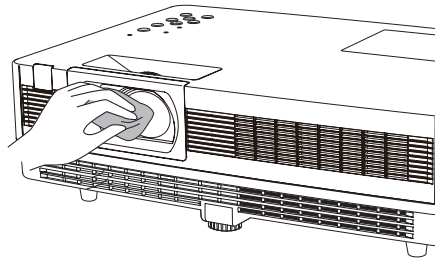

Cleaning the Projector Cabinet

Unplug the AC power cord before cleaning.

Gently wipe the projector body with a soft dry cleaning cloth. When the cabinet is heavily soiled, use a small amount of mild detergent and finish with a soft dry cleaning cloth. Avoid using an excessive amount of cleaner. Abrasive cleaners, solvents, or other harsh chemicals might scratch the surface of the cabinet.

When the projector is not in use, put the projector in an appropriate carrying case to protect it from dust and scratches.

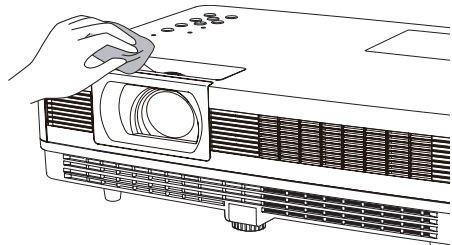

CAUTION

Do not use any flammable solvents or air sprays on the projector and in its vicinity. The explosion or fire hazard may occur even after the AC power cord is unplugged because the temperature inside the projector is extremely high due to the lamps. In addition, there is a risk that the internal parts may be damaged not only by the flammable air spray but also by the cold air.

Lamp Replacement

When the projection lamp of the projector reaches its end of life, the Lamp replacement icon appears on the screen and LAMP REPLACE indicator lights yellow. Replace the lamp with a new one promptly. The timing when the LAMP REPLACE indicator should light is depending on the lamp mode.

Top Control

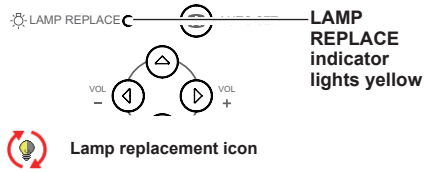

✓ Note:

- The image will be displayed for about 10 seconds.
- The Lamp replacement icon will not appear when the Display function is set to **Off** (p.53), during **Freeze** (p.28), or **Blank** (p.29).



CAUTION

Allow a projector to cool for at least one hour before you open the Lamp Cover. The inside of the projector can become very hot.



CAUTION

When replacing the lamp because it has stopped illuminating, there is a possibility that the lamp may be broken. If replacing the lamp of a projector which has been installed on the ceiling, you should always assume that the lamp is broken, and you should stand to the side of the lamp cover, not underneath it. Remove the lamp cover gently. Small pieces of glass may fall out when the lamp cover is opened. If pieces of glass get into your eyes or mouth, seek medical advice immediately.



CAUTION

For continued safety, replace with a lamp of the same type. Do not drop a lamp or touch a glass bulb! The glass can shatter and may cause injury.

Follow these steps to replace the lamp.

- 1** Unplug the AC power cord. Let the projector cool for at least one hour.
- 2** Loosen the screw and open the lamp cover.
- 3** Loosen the three (3) screws that secure the lamp. Lift the lamp out of the projector by using the handles.
- 4** Replace the lamp with a new one and secure the three (3) screws. Make sure that the lamp is set properly. Close the lamp cover and secure the screw.
- 5** Connect the AC power cord to the projector and turn on the projector.
- 6** **Reset the lamp counter.** See "Lamp Counter" on page 62.

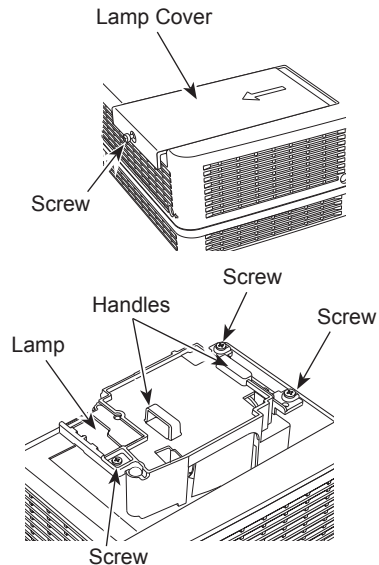

ORDER REPLACEMENT LAMP

Replacement lamp can be ordered through your dealer. When ordering a projection lamp, give the following information to the dealer.

- **Model No. of your projector :** LV-7292A, LV-7297A, LV-7392A,
LV-8227A, LV-7292M, LV-7297M,
LV-8227M
- **Replacement Lamp Type No.:** LV-LP35



CAUTION

LAMP HANDLING PRECAUTIONS

This projector uses a high-pressure lamp which must be handled carefully and properly.

Improper handling may result in accidents, injury, or create a fire hazard.

- Lamp life may differ from lamp to lamp and according to the environment of use. There is no guarantee of the same life for each lamp. Some lamps may fail or terminate their life in a shorter period of time than other similar lamps.
- If the projector indicates that the lamp should be replaced, i.e., if the LAMP REPLACE indicator lights up, replace the lamp with a new one IMMEDIATELY after the projector has cooled down.
(Follow carefully the instructions in the Lamp Replacement section of this manual.)
Continuous use of the lamp with the LAMP REPLACE indicator lighted may increase the risk of lamp explosion.
- A Lamp may explode as a result of vibration, shock or degradation as a result of hours of use as its lifetime draws to an end. Risk of explosion may differ according to the environment or conditions in which the projector and lamp are being used.

IF A LAMP EXPLODES, THE FOLLOWING SAFETY PRECAUTIONS SHOULD BE TAKEN.

If a lamp explodes, disconnect the projector's AC plug from the AC outlet immediately. Contact an authorized service center for a checkup of the unit and replacement of the lamp. Additionally, check carefully to ensure that there are no broken shards or pieces of glass around the projector or coming out from the cooling air circulation holes. Any broken shards found should be cleaned up carefully. No one should check the inside of the projector except those who are authorized trained technicians and who are familiar with projector service. Inappropriate attempts to service the unit by anyone, especially those who are not appropriately trained to do so, may result in an accident or injury caused by pieces of broken glass.

Appendix

Troubleshooting

Before calling your dealer or service center for assistance, check the items below once again.

- Make sure you have properly connected the projector to peripheral equipment as described on pages 17-19.
- Make sure all equipment is connected to AC outlet and the power is turned on.
- When the projector does not project an image from the connected computer, restart the computer.

Problem: – Solutions

No power

- Plug the power cord of the projector into the AC outlet.
- See if the POWER indicator lights red.
- Wait until the POWER indicator stops blinking to turn on the projector again. The projector can be turned on after the POWER indicator turns red. See page 21.
- Check the WARNING indicator. If the WARNING indicator lights red, projector cannot be turned on. See page 70.
- Check the projection lamp. See page 68.
- Unlock the Key lock function for the projector. See page 60.

The initial display is not shown. – Make sure **Off** or **Countdown off** are not chosen at display function. See page 53.

The initial display is not same as the default set. – Make sure **User** or **Off** are not chosen at Logo (select) function. See page 53.

Input signal switches automatically (or does not switch automatically) – Make sure Auto input function is adjusted properly. See page 52.

When the projector is on and you press the input source buttons, an icon other than the Lamp mode icon appears. – That is the Filter warning icon. See page 60.

An icon other than Input mode or Lamp mode icon appears. – That is the Lamp replacement icon or the Filter warning icon. See page 68 or 60.

Image is out of focus. – Adjust focus of the projector. See page 26.
– Provide proper distance between the projector and the projection screen. See page 15.
– Check the projection lens to see if it needs cleaning. See page 67.
– Moving the projector from a cool to warm place may result in moisture condensation on the projection lens. In such cases, leave the projector off and wait until condensation evaporates.

Image is Left/Right reversed. – Check the Ceiling/Rear function. See pages 38,40,48,50.
Image is Top/Bottom reversed. – Check the Ceiling function. See pages 38,40,48,50.

Picture is not bright enough. – Check if the **Contrast** or **Brightness** is adjusted properly. See pages 36, 45.
– Check if **Image mode** is selected properly. See pages 35,44.
– Check the Lamp mode function. See pages 28, 59.
– Check the LAMP REPLACE indicator. If it lights, the end of lamp life is approaching. Replace the lamp with a new one promptly. See page 68.

<p>No image</p>	<ul style="list-style-type: none"> - Check the connection between your computer or video equipment and the projector. See pages 17-19. - See if the input signal is correctly output from your computer. Some laptop computers may need to change the setting for monitor output when connecting to a projector. See your computer's instruction manual for the setting. - It takes about 30 seconds to display an image after turning on the projector. See page 21. - Check the Input signal, color system, video system or computer system mode. - Make sure the temperature is not out of the specified Operating Temperature (41°F–95°F [5°C–35°C]). - When Blank is operating, the image cannot be displayed. Press the BLANK button or any other button on the remote control unit.
<p>No sound</p>	<ul style="list-style-type: none"> - Check the audio cable connection from audio input source. - Adjust the audio source. - Press the Volume + button. See page 27. - Press the Mute button. See page 27. - When the AUDIO OUT is plugged-in, the projector's built-in speaker is not available. - Is the image projected? You will hear the Computer and VIDEO sound only when the image is projected.
<p>The color is strange.</p>	<ul style="list-style-type: none"> - Check the Input signal, color system, video system or computer system mode. - Make sure the Blackboard is not selected on Image select menu. See pages 35,44.
<p>Some displays are not seen during the operation.</p>	<ul style="list-style-type: none"> - Check the Display function. See page 53.
<p>Auto PC adjustment function does not work.</p>	<ul style="list-style-type: none"> - Check the Input signal. Auto PC adjustment function can not work when 480p, 575p, 720p, 480i, 575i, 1035i or 1080i is selected (see page 31), or when the signal is coming from the HDMI terminal.
<p>The setting does not remain after turning off power.</p>	<ul style="list-style-type: none"> - Make sure you selected Store after adjusting setting. Some settings can not be stored if not registered with Store. See pages 36,46.
<p>Power management mode does not work.</p>	<ul style="list-style-type: none"> - Power management mode function can not work while Freeze or BLANK function is running. See page 56.
<p>Capture function does not work.</p>	<ul style="list-style-type: none"> - Check the connection and the input signal to see if there is signal.
<p>Auto setup does not work properly.</p>	<ul style="list-style-type: none"> - Make sure Off is not selected at any function of Auto setup. See page 52. - Make sure On is not selected at the Ceiling function. See pages 38,40,48,50.
<p>Auto keystone function does not work even when the projector is tipped.</p>	<ul style="list-style-type: none"> - Make sure the Auto keystone function is not set to Manual. Press the AUTO SET button on the top control. See pages 26, 52.

Appendix

The image is distorted or runs off. – Check **PC adjust** menu or **Screen** menu and adjust them. See pages 33-34, 38-40.

PIN code dialog box appears at start-up. – PIN code lock is being set. Enter a PIN code (the “1234” or numbers you have set). See pages 22, 60-61.

The Remote control unit does not work.

- Check the batteries.
- Make sure no obstruction is between the projector and remote control.
- Make sure you are not too far from the projector when using the remote control unit. Maximum operating range is 16.4'(5 m).
- Make sure the code of the remote control unit is conformed to the projector's code. See page 59.
- Unlock the Key lock function for the remote control unit function. See page 60.

Indicator blinks or lights. – Check the status of the projector with referring to "Indicators and projector Condition". See page 75.

The exclamation mark appears on the screen. – Your operation is invalid. Operate correctly.

Top control does not work. – The top control is not available if the top control is locked at **Key lock** under **Security** of Setting section. See page 60.



Service

appears on the screen

– The projector detects an abnormal condition. Unplug the AC power cord and contact the dealer where you purchased the projector or the service center.

WARNING :

High voltages are used to operate this projector. Do not attempt to open the cabinet.

If problems still persist after following all operating instructions, contact the dealer where you purchased the projector or the service center. Specify the model number and explain about the problem. We will advise you how to obtain service.

Menu Tree

Computer Input/HDMI Input/VIDEO Input

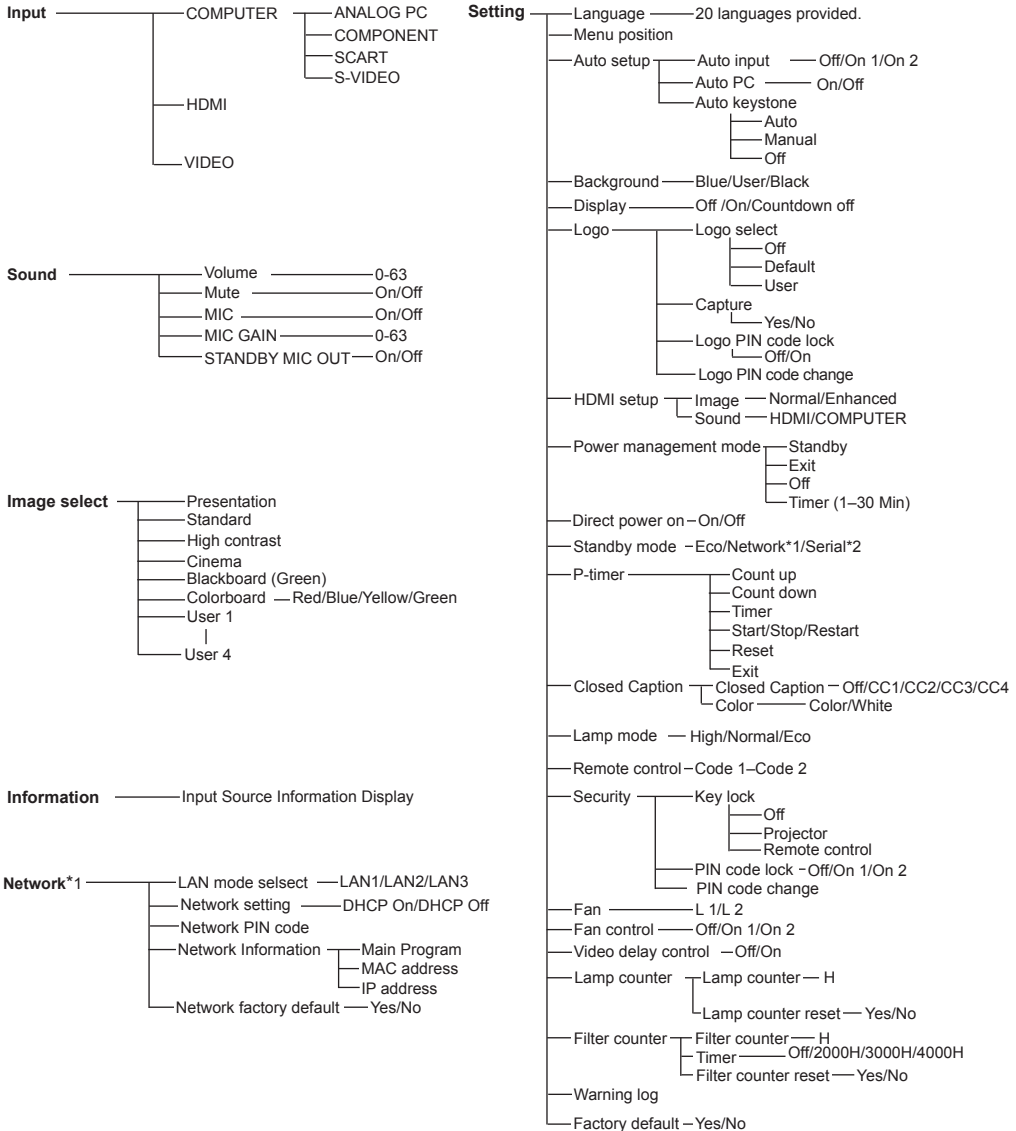

*1 **Network** is only for LV-7292A, LV-7297A, LV-7392A, LV-8227A.

*2 **Serial** is only for LV-7292M, LV-7297M, LV-8227M.

Appendix

HDMI Input/VIDEO Input

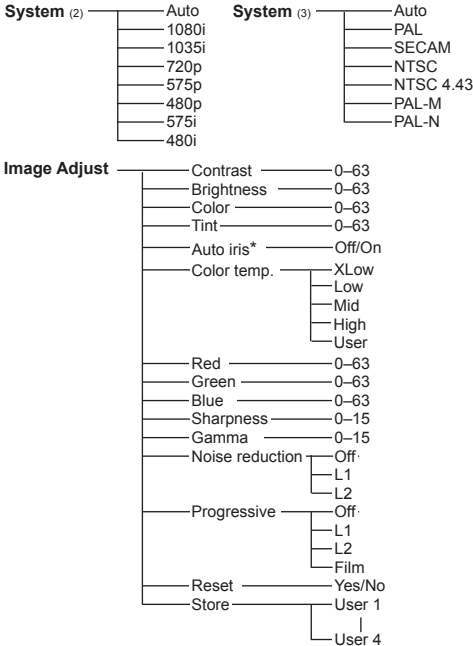

* Auto iris is only for LV-7292A, LV-7297A, LV-7392A, LV-8227A.

For LV-7292A, LV-7297A, LV-7392A, LV-7292M, LV-7297M

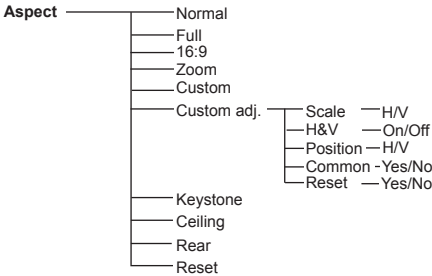

For LV-8227A, LV-8227M

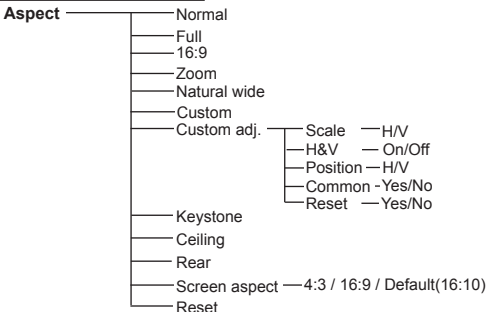

Computer Input

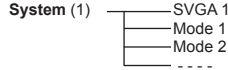

* Systems displayed in the System Menu vary depending on an input signal.

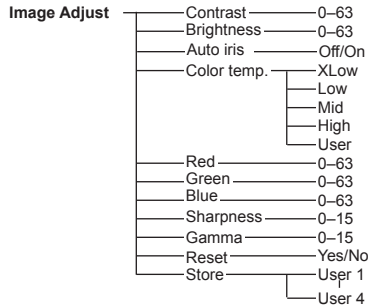
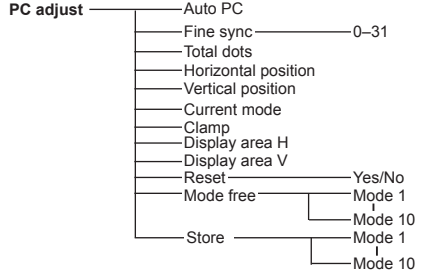

For LV-7292A, LV-7297A, LV-7392A, LV-7292M, LV-7297M

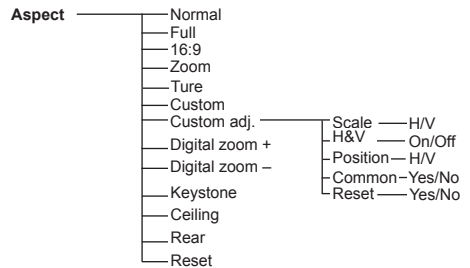

For LV-8227A, LV-8227M

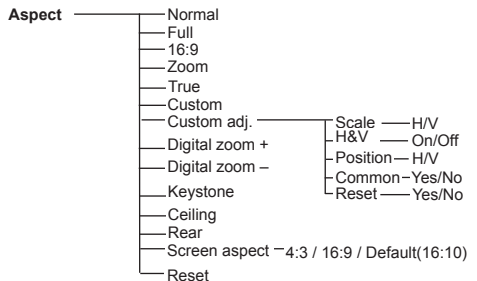

Indicators and Projector Condition

Check the indicators for projector condition.

Indicators			Projector Condition
POWER red/green	WARNING red	LAMP REPLACE yellow	
●	●	●	The projector is off. (The AC power cord is unplugged.)
⊘	●	*	The projector is in stand-by mode. Press the POWER button to turn on the projector.
○	●	*	The projector is operating normally.
⊘	●	*	The projector is preparing for stand-by or the projection lamp is being cooled down. The projector cannot be turned on until cooling is completed and the POWER indicator stops blinking.
○	●	*	The projector is in the Power management mode. The lamp lights up when operating the projector, and the projector begins to work.
⊘	⊘	*	The temperature inside the projector is abnormally high. The projector cannot be turned on. When the projector is cooled down enough and the temperature returns to normal, the POWER indicator stops blinking and the projector can be turned on. (The WARNING indicator keeps blinking.)
⊘	⊘	*	The projector has been cooled down enough and the temperature returns to normal. When turning on the projector, the WARNING indicator stops blinking. Please check the Air filter.
●	⊘	*	The projector detects an abnormal condition and cannot be turned on. Unplug the AC power cord and plug it again to turn on the projector. If the projector is turned off again, unplug the AC power cord and contact the dealer or the service center for service and checkup. Do not leave the projector on. It may cause an electric shock or a fire hazard.
*	*	●	Reaches recommended replacement time. The icon  appearing on the top right corner of the image indicates the replacement of the lamp. Please replace the lamp as soon as possible. The time before the LAMP REPLACE indicator lighting up, depends on the operating conditions (the state of the lamp mode).

○ ••• green. ⊘ ••• red ○ ••• blinks green. ⊘ ••• blinks red.

● ••• yellow. ● ••• off

* When the projection lamp reaches its end of life, the LAMP REPLACE indicator lights yellow. When this indicator lights yellow, replace the projection lamp with a new one promptly. (pp. 62,68)

Compatible Computer Specifications

Basically this projector can accept the signal from all computers with the V-, H-Frequency mentioned below and less than 140 MHz of Dot Clock.

When selecting these modes, PC adjustment can be limited.

ON-SCREEN DISPLAY	RESOLUTION	H-frekv. (KHz)	V-frekv. (Hz)	ON-SCREEN DISPLAY	RESOLUTION	H-frekv. (KHz)	V-frekv. (Hz)
VGA 1	640 x 480	31.47	59.88	SXGA 8	1280 x 1024	63.98	60.02
VGA 2	720 x 400	31.47	70.09	SXGA 9	1280 x 1024	79.976	75.025
VGA 3	640 x 480	31.47	70.09	SXGA 10	1280 x 960	60.00	60.00
VGA 4	640 x 480	37.86	74.38	SXGA 11	1152 x 900	61.20	65.20
VGA 5	640 x 480	37.86	72.81	SXGA 12	1152 x 900	71.40	75.60
VGA 6	640 x 480	37.50	75.00	SXGA 13	1280 x 1024	50.00	86.00 (Interface)
VGA 7	640 x 480	43.269	85.00	SXGA 14	1280 x 1024	50.00	94.00 (Interface)
MAC LC13	640 x 480	34.97	66.60	SXGA 15	1280 x 1024	63.37	60.01
MAC 13	640 x 480	35.00	66.67	SXGA 16	1280 x 1024	76.97	72.00
480p	640 x 480	31.47	59.88	SXGA 17	1152 x 900	61.85	66.00
575p	768 x 576	31.25	50.00	SXGA 18	1280 x 1024	46.43	88.70 (Interface)
480i	640 x 480	15.734	60.00 (Interface)	SXGA 19	1280 x 1024	63.79	60.18
575i	768 x 576	15.625	50.00 (Interface)	SXGA 20	1280 x 1024	91.146	85.024
SVGA 1	800 x 600	35.156	56.25	SXGA+ 1	1400 x 1050	63.97	60.19
SVGA 2	800 x 600	37.88	60.32	SXGA+ 2	1400 x 1050	65.35	60.12
SVGA 3	800 x 600	46.875	75.00	SXGA+ 3	1400 x 1050	65.12	59.90
SVGA 4	800 x 600	53.674	85.06	MAC21	1152 x 870	68.68	75.06
SVGA 5	800 x 600	48.08	72.19	MAC	1280 x 960	75.00	75.08
SVGA 6	800 x 600	37.90	61.03	MAC	1280 x 1024	80.00	75.08
SVGA 7	800 x 600	34.50	55.38	WXGA 1	1366 x 768	48.36	60.00
SVGA 8	800 x 600	38.00	60.51	WXGA 2	1360 x 768	47.70	60.00
SVGA 9	800 x 600	38.60	60.31	WXGA 3	1376 x 768	48.36	60.00
SVGA 10	800 x 600	32.70	51.09	WXGA 4	1360 x 768	56.16	72.00
SVGA 11	800 x 600	38.00	60.51	WXGA 6	1280 x 768	47.776	59.87
MAC 16	832 x 624	49.72	74.55	WXGA 7	1280 x 768	60.289	74.893
MAC 19	1024 x 768	60.24	75.08	WXGA 8	1280 x 768	68.633	84.837
XGA 1	1024 x 768	48.36	60.00	WXGA 9	1280 x 800	49.600	60.050
XGA 2	1024 x 768	68.677	84.997	WXGA 10	1280 x 800	41.200	50.000
XGA 3	1024 x 768	60.023	75.03	WXGA 11	1280 x 800	49.702	59.810
XGA 4	1024 x 768	56.476	70.07	WXGA 12	1280 x 800	63.98	60.02
XGA 5	1024 x 768	60.31	74.92	WXGA 17	1280 x 800	58.289	69.975
XGA 6	1024 x 768	48.50	60.02	WXGA 18	1280 x 800	60.044	71.995
XGA 7	1024 x 768	44.00	54.58	WXGA 19	1280 x 800	62.790	74.928
XGA 8	1024 x 768	63.48	79.35	WXGA 20	1280 x 800	71.553	84.879
XGA 9	1024 x 768	36.00	87.17 (Interface)	WXGA 21	1280 x 768	55.993	69.991
XGA 10	1024 x 768	62.04	77.07	WXGA 22	1280 x 768	57.675	72.004
XGA 11	1024 x 768	61.00	75.70	WUXGA 1	1920 x 1200	74.556	59.885
XGA 12	1024 x 768	35.522	86.96 (Interface)	WUXGA 2	1920 x 1200	74.038	59.950
XGA 13	1024 x 768	46.90	58.20	WSXGA+ 1	1680 x 1050	65.290	59.954
XGA 14	1024 x 768	47.00	58.30	WXGA+ 1	1440 x 900	55.935	59.887
XGA 15	1024 x 768	58.03	72.00	WXGA+ 2	1440 x 900	74.918	60.000
SXGA 1	1152 x 864	64.20	70.40	UXGA 1	1600 x 1200	75.00	60.00
SXGA 2	1280 x 1024	62.50	58.60	UXGA 2	1600 x 1200	81.25	65.00
SXGA 3	1280 x 1024	63.90	60.00	UXGA 3	1600 x 1200	87.5	70.00
SXGA 4	1280 x 1024	63.34	59.98	UXGA 4	1600 x 1200	93.75	75.00
SXGA 5	1280 x 1024	63.74	60.01	720p	1280 x 720	45.00	60.00
SXGA 6	1280 x 1024	71.69	67.19	720p	1280 x 720	37.50	50.00
SXGA 7	1280 x 1024	81.13	76.107	1035i	1920 x 1035	33.75	80.00 (Interface)
				1080i	1920 x 1080	33.75	80.00 (Interface)
				1080i	1920 x 1080	28.125	50.00 (Interface)

✓ **Note:**

The specifications are subject to change without notice.

When the input signal is digital from HDMI terminal, refer to the chart below.

ON-SCREEN DISPLAY	RESOLUTION	H-frekv. (KHz)	V-frekv. (Hz)
D-480p	640 x 480	31.47	59.88
D-575p	768 x 575	31.25	50.00
D-720p	1280 x 720	37.50	50.00
D-720p	1280 x 720	45.00	60.00
D-VGA	640 x 480	31.47	59.94
D-SVGA	800 x 600	37.879	60.32
D-XGA	1024 x 768	43.363	60.00
D-WXGA 1	1366 x 768	48.36	60.00
D-WXGA 2	1360 x 768	47.7	60.00
D-WXGA 3	1376 x 768	48.36	60.00
D-WXGA 4	1360 x 768	56.160	72.000
D-WXGA 5	1366 x 768	46.500	50.000
D-WXGA 6	1280 x 768	47.776	59.870
D-WXGA 7	1280 x 768	60.289	74.893
D-WXGA 8	1280 x 768	68.633	84.837
D-WXGA 9	1280 x 800	49.572	59.870
D-WXGA 10	1280 x 800	41.200	50.000
D-WXGA 11	1280 x 800	49.702	59.810
D-WXGA 12	1280 x 800	63.98	60.02

ON-SCREEN DISPLAY	RESOLUTION	H-frekv. (KHz)	V-frekv. (Hz)
D-WXGA 17	1280x800	58.289	69.975
D-WXGA 18	1280x800	60.044	71.995
D-WXGA 19	1280x800	62.790	74.928
D-WXGA 20	1280x800	71.553	84.879
D-WXGA 21	1280x768	55.993	69.991
D-WXGA 22	1280x768	57.675	72.004
D-SXGA1	1280 x 1024	63.98	60.02
D-SXGA2	1280 x 1024	60.276	58.069
D-SXGA3	1280 x 1024	31.65	29.80
D-SXGA+ 1	1400 x 1050	63.97	60.19
D-SXGA+ 2	1400 x 1050	65.350	60.120
D-SXGA+ 3	1400 x 1050	65.120	59.900
D-WSXGA+1	1680 x 1050	65.290	59.954
D-WXGA +1	1440 x 900	55.935	59.887
D-1035i	1920 x 1035	33.75	60.00 (interface)
D-1080i	1920 x 1080	33.75	60.00 (interface)
D-1080i	1920 x 1080	28.125	50.00 (interface)
D-WUXGA 2	1920 x 1200	74.038	59.95
D-1080p	1920 x 1080	67.5	60.00
D-1080p	1920 x 1080	56.25	50.00

✓ **Note:**

- The specifications are subject to change without notice.
- Depending on your PC settings, the digital signals of your PC may not be projected correctly. In such a case, confirm your PC settings.
- When you project a DVI signal, connect the cables, turn the projector on, then select the input. Finally, turn on your PC. Be sure to follow this procedure, otherwise an image may not be projected on the screen. If an image is not projected correctly, restart your PC.
- Do not disconnect the cable while the projector is running. If the cable has been disconnected and then reconnected, an image may not be correctly projected.

Technical Specifications

Mechanical Information	Projector Type	Multi-media Projector			
	Dimensions (W x H x D)	13.13" x 3.98" x 9.72" (333.5mm x 101.0mm x 247.0mm) (Not including protrusions)			
	Net Weight	LV-7292A, LV-7297A, LV-7392A, LV-8227A : 6.6 lbs (2.99 kg) LV-7292M, LV-7297M, LV-8227M : 6.4 lbs (2.9 kg)			
	Foot Adjustment	0° to 10°			
Panel Resolution	LCD Panel System	LV-7292A, LV-7297A, LV-7292M, LV-7297M, L: 0.55"; LV-7392A: 0.63"; LV-8227A, LV-8227M: 0.59" TFT Active Matrix type, 3 panels			
	Panel Resolution	LV-7292A, LV-7297A, LV-7392A, LV-7292M, LV-7297M: 1,024 x 768 dots LV-8227A, LV-8227M: 1,280 x 800 dots			
	Number of Pixels	LV-7292A, LV-7297A, LV-7392A, LV-7292M, LV-7297M: 2,359,296 (1,024 x 768 x 3 panels) LV-8227A, LV-8227M: 3,072,000 (1,280 x 800 x 3 panels)			
Signal Compatibility	Color System	PAL, SECAM, NTSC, NTSC4.43, PAL-M, and PAL-N			
	SD/HD TV Signal	480i, 480p, 575i, 575p, 720p, 1035i, and 1080i			
	Input Scanning Frequency	H-sync. 15 kHz–100 kHz, V-sync. 50–100 Hz			
Optical Information	Projection Image Size (Diagonal)	Adjustable from 40" to 300"			
	Throw Distance	LV-7292A, LV-7297A, LV-7292M, LV-7297M: 4.3' -38.7' (1.3m - 11.8m) LV-7392A: 3.6' - 34.4' (1.1m - 10.5m) LV-8227A, LV-8227M: 4.0' - 36.4' (1.2m - 11.1m)			
	Projection Lens	F 2.0 ~ 2.15 lens with f 18.38 mm ~ 22.06 mm with manual zoom and focus			
	Projection Lamp	215 W			
Image Information	Brightness (Lamp mode: "High", Image mode: "Presentation")	LV-7392A	LV-7297A, LV-7297M	LV-8227A, LV-8227M	LV-7292A, LV-7292M
		3000 lm	2600 lm	2500 lm	2200 lm
	Contrast ratio (Lamp mode: "High", Image mode: "Presentation" Auto iris*: "On")	LV-8227A	LV-7292A, LV-7297A, LV-7392A	LV-7292M, LV-7297M, LV-8227M	
		3000:1	2000:1	500:1	
	Uniformity	85%			
Interface	VIDEO Input Jack	RCA Type x 1			
	Audio Input Jack	RCA Type x 2			
	Computer In/S-VIDEO In/ COMPONENT In/	D-sub 15 pin x 1			
	MIC Audio Input Jack	Mini Jack (stereo) x 1			
	Control	D-sub 9 pin x 1			
	Audio Output Jack	Mini Jack (stereo) x 1 (variable)			
	LAN Connection Terminal (Only for LV-7292A, LV-7297A, LV-7392A and LV-8227A.)	RJ-45			
	HDMI	HDMI (V.1.3 with Deep Color) x 1			
Audio	Internal Audio Amp	LV-7292A, LV-7297A, LV-7392A, LV-8227A :10 W RMS; LV-7292M, LV-7297M, LV-8227M :1 W RMS			
	Built-in Speaker	LV-7292A, LV-7297A, LV-7392A, LV-8227A :ø1.6" (37 mm); LV-7292M, LV-7297M, LV-8227M :ø1.12" (28 mm)			

* Auto iris is only for LV-7292A, LV-7297A, LV-7392A, LV-8227A.

Power supply	AC 100–120 V (3.6A Max.), 50/60 Hz (U.S.A and Canada) AC 100–240 V (3.6A -2.0A Max.), 50/60 Hz (For other countries)				
Power consumption	Lamp mode: Eco/Normal/ High	LV-7292A	LV-7297A	LV-7392A	LV-8227A
		185W/225W/250W		185W/250W/270W	
		LV-7292M		LV-7297M, LV-8227M	
		177W/220W/245W		177W/245W/265W	
Standby Power consumption	Standby mode: Eco/Network*	LV-7292A, LV-7297A, LV-7392A, LV-8227A			
		0.49W/9.6W			
		LV-7292M, LV-7297M, LV-8227M			
		0.49W/9.0W			
Operating Environment	Operating Temperature	41°F–95°F (5 °C–35 °C)			
	Storage Temperature	14°F–140°F (-10°C–60 °C)			
Remote control unit	Battery	AAA Type 1.5V x 2			
	Operating Range	16.4' (5 m), ±30°			
	Dimensions (W x H x D)	2.0" x 0.7" x 4.3" (52 mm x 18 mm x 110 mm)			
	Net Weight	2.37 oz (67 g) (including batteries)			

* Network is only for LV-7292A, LV-7297A, LV-7392A, LV-8227A.

Accessories

User's Manual (CD-ROM)
 Important Information and Quick Start Guide
 Warranty card
 AC Power Cord
 Remote controller and Batteries
 VGA Cable
 Lens Cap with String
 PIN Code Label
 Ferrite core
 Filter Cover for Ceiling Mount

- The specifications are subject to change without notice.
- LCD panels are manufactured to the highest possible standards. Even though 99.99% of the pixels are effective, a tiny fraction of the pixels (0.01% or less) may be ineffective by the characteristics of the LCD panels.

Optional Parts

The parts listed below are optionally available. When ordering those parts, specify the item name and Model No. to the sales dealer.

	Model No.
COMPONENT-VGA Cable	: LV-CA32
S-VIDEO-VGA Cable	: LV-CA33
Soft Carrying Case	: LV-SC01
Remote controller	: LV-RC06
Projector Attachment	: LV-CL17
Ceiling Attachment	: LV-CL18
High Ceiling Attachment	: LV-CL19
Lamp	: LV-LP35

PJ Link Notice (Only for LV-7292A, LV-7297A, LV-7392A, LV-8227A)

This projector is compliant with PJLink Standard Class 1 of JBMIA (Japan Business Machine and Information System Industries Association). This projector supports all commands defined by PJLink Class 1 and is verified conformance with PJLink Standard Class 1.

For PJ Link password, see the user's manual of "Network Set-up and Operation."

Projector Input		PJLink Input	Parameter
COMPUTER	ANALOG PC	RGB 1	11
	COMPONENT	VIDEO 3	23
	SCART	RGB 2	12
	S-VIDEO	VIDEO 2	22
HDMI	HDMI	DIGITAL 1	31
VIDEO	VIDEO	VIDEO 1	21

PJLink is a registered trademark of JBMIA and pending trademark in some countries.



Attaching the Filter Cover to the Projector

The supplied filter cover is designed for preventing dust accumulation on the filter when mounting the projector on the ceiling.

- 1 Turn over the projector.
- 2 Place the filter cover on the filter as the picture shown below.
- 3 Attach the projector to the ceiling mount in accordance with the instruction manuals which come with the ceiling mount.

✓ **Note:**

- To keep the filter cover in position, be sure to attach the drop-prevention wire by threading it through the hole of the filter cover.
- If the LV-CL17 Projector Attachment is applied, the supplied filter cover is unnecessary.

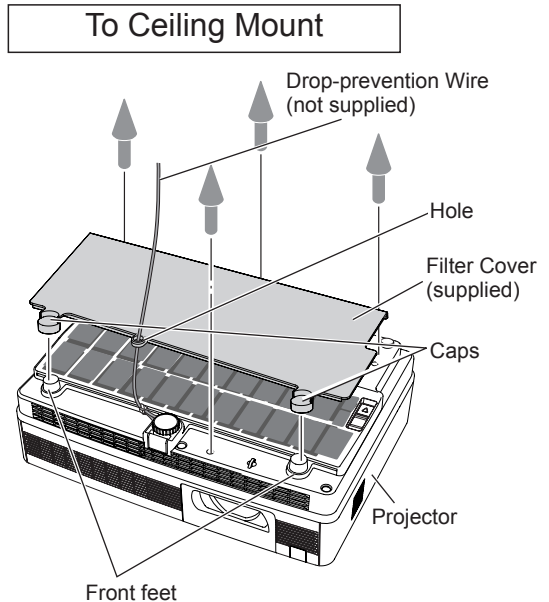

Configurations of Terminals

COMPUTER IN / S-VIDEO IN/ COMPONENT IN

Terminal: Analog RGB (Mini D-sub 15 pin)

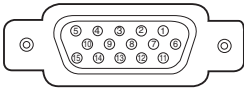

1	Red/Cr/S-C Input	9	+5V Power
2	Green/Y/S-Y Input	10	Ground (Vert.sync.)
3	Blue/Cb/--- Input	11	Ground
4	-----	12	DDC Data
5	Ground (Horiz.sync.)	13	Horiz. sync. Input/Output (Composite H/V sync.)
6	Ground (Red)	14	Vert. sync.
7	Ground (Green)	15	DDC Clock
8	Ground (Blue)		

HDMI (19 Pin Type A)

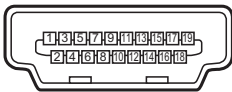

1	TMDS Data 2+ Input	11	Ground (TMDS Clock)
2	Ground (TMDS Data 2)	12	TMDS Clock- Input
3	TMDS Data 2- Input	13	-----
4	TMDS Data 1+ Input	14	-----
5	Ground (TMDS Data 1)	15	SCL
6	TMDS Data 1- Input	16	SDA
7	TMDS Data 0+ Input	17	Ground (DDC/CEC)
8	Ground (TMDS Data 0)	18	+5V Power
9	TMDS Data 0- Input	19	Plug insert detection
10	TMDS Clock+ Input		

CONTROL CONNECTOR (D-sub 9 pin)

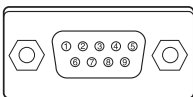

	Serial	5	SG
1	-----	6	-----
2	R X D	7	-----
3	T X D	8	-----
4	-----	9	-----

LAN TERMINAL

(For LV-7292A, LV-7297A, LV-7392A, LV-8227A.)

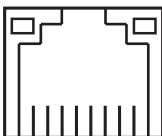

87654321

1	TX +	5	-----
2	TX -	6	RX -
3	RX +	7	-----
4	-----	8	-----

PIN Code Protection

While the projector is locked with the PIN code.

Put the label below (supplied) on in a prominent place of the projector's body while it is locked with a PIN code.

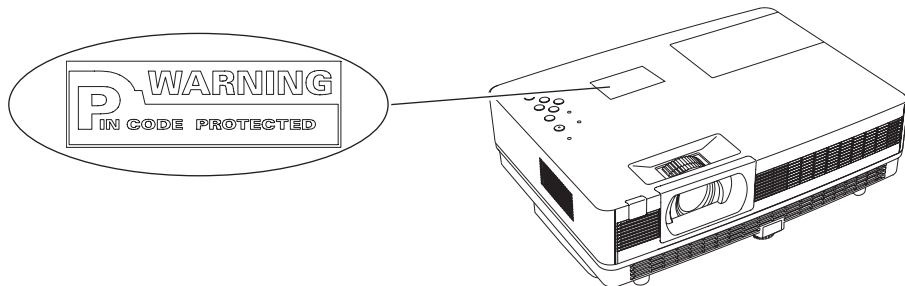

Dimensions

Unit: mm(inch)

↙ Screw Holes for Ceiling Mount
Screw: M4
Depth: 12.0(0.47)

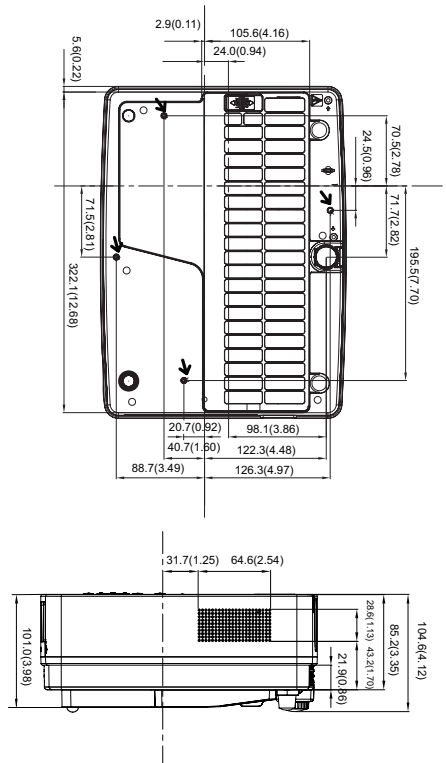
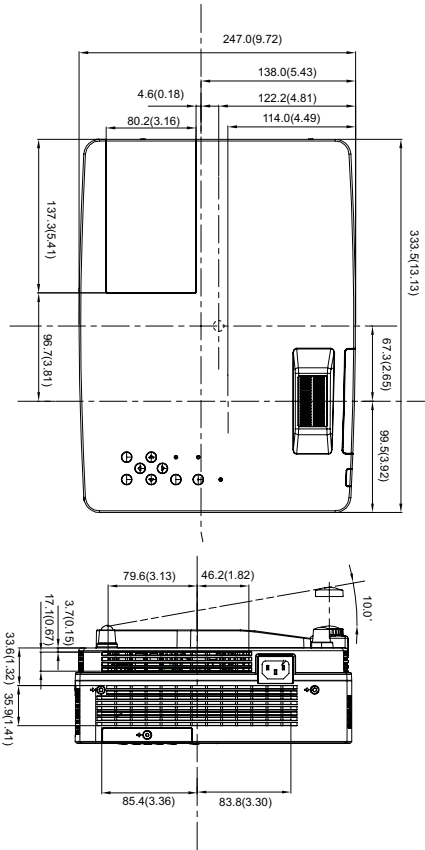

Canon

CANON INC.

30-2, Shimomaruko 3-chome, Ohta-ku,
Tokyo 146-8501, Japan

U.S.A.

CANON U.S.A. INC.

One Canon Plaza, Lake Success, NY
11042-1198, U.S.A.

*For all inquiries concerning this product, call
toll free in the U.S. 1-800-OK-CANON*

CANADA

CANON CANADA INC. HEADQUARTERS

6390 Dixie Road, Mississauga, Ontario L5T
1P7, Canada

CANON CANADA INC. MONTREAL BRANCH

5990, Cote-de-Liesse, Montreal Quebec H4T
1V7, Canada

CANON CANADA INC. CALGARY OFFICE

2828, 16th Street, N.E. Calgary, Alberta T2E
7K7, Canada

*For all inquiries concerning this product, call
toll free in Canada 1-800-OK-CANON*

EUROPE, AFRICA & MIDDLE EAST

CANON EUROPE LTD.

3 The Square, Stockley Park, Uxbridge,
Middlesex, UB11 1ET United Kingdom

CANON EUROPA N.V.

Bovenkerkerweg 59-61, 1185 XB Amstelveen,
The Netherlands

CANON FRANCE S.A.S

17, quai du President Paul Doumer, 92414
Courbevoie Cedex, France

CANON UK LTD.

Woodhatch Reigate Surrey RH2 8BF,
United Kingdom

CANON DEUTSCHLAND GmbH

Europark Fichtenhain A10, 47807 Krefeld,
Germany

CANON ITALIA S.p.A.

Via Milano 8 I-20097 San Donato Milanese,
Milano, Italy

CANON Schweiz AG

Geschäftsbereich Wiederverkauf,
Industriestrasse 12, CH-8305 Dietlikon,
Switzerland

CANON GMBH

Zetschegasse 11, A-1230 Wien, Austria

CANON España, S.A.

Av. De Europa, 6 Alcobendas 28108 Madrid, Spain

CANON PORTUGAL S.A.

Rua Alfredo da Silva, 14 Alfragide 2610-016

Amadora, Portugal

CANON Belgium N.V./S.A.

Berkenlaan 3, 1831 Diegem (Mechelen), Belgium

CANON Netherland NV

Neptunusstraat 1, 2132 JA Hoofddorp,

The Netherlands

CANON LUXEMBOURG S.A.

Rue des Joncs 21, L-1818 Howald, Luxembourg

CANON DENMARK A/S

Knud Høeigaards Vej 1 DK-2860 Soeborg,

Danmark

CANON OY

Huopalahdentie 24 PL 1 00351 Helsinki, Finland

CANON SVENSKA AB

Gustav III:s Boulevard 26 169 88 Solna, Sweden

CANON NORGE as

Hallagerbakken 110, Postboks 33, Holmlia, 1201

Oslo, Norway

CENTRAL & SOUTH AMERICA

CANON LATIN AMERICA, INC.

703 Waterford Way, Ste. 400 Miami, FL 33126,
U.S.A.

ASIA

CANON (China) Co., Ltd.

15F Jinbao Building No.89 Jinbao Street,
Dongcheng District, Beijing 100005, China

CANON HONGKONG CO., LTD.

19/F., The Metropolis Tower, 10 Metropolis Drive,
Hungghom, Kowloon, Hong Kong

CANON SINGAPORE PTE. LTD.

1 HarbourFront Avenue, #04-01 Keppel Bay
Tower, Singapore 098632

CANON KOREA CONSUMER IMAGING INC.

Canon BS Tower 5F, #168-12, Samseong-dong,
Gangnam-gu, Seoul, Korea

OCEANIA

CANON AUSTRALIA PTY. LTD.

1 Thomas Holt Drive, North Ryde, N.S.W. 2113,
Australia

CANON NEW ZEALAND LTD.

Akoranga Business Park, Akoranga Drive,
Northcote, Auckland, New Zealand

Free Manuals Download Website

<http://myh66.com>

<http://usermanuals.us>

<http://www.somanuals.com>

<http://www.4manuals.cc>

<http://www.manual-lib.com>

<http://www.404manual.com>

<http://www.luxmanual.com>

<http://aubethermostatmanual.com>

Golf course search by state

<http://golfingnear.com>

Email search by domain

<http://emailbydomain.com>

Auto manuals search

<http://auto.somanuals.com>

TV manuals search

<http://tv.somanuals.com>