

**REALiS**  
MULTIMEDIA PROJECTORS

**Canon**



**PRESENTING EXCELLENCE.**  
Rich Color. Deep Contrast. Sharp Resolution.

**WUX4000 D**

**WUX4000**

**WUX10 Mark II D**

**WUX10 Mark II**

**SX7 Mark II D**

**SX7 Mark II**

**SX80 Mark II D**

**SX80 Mark II**

**SX60**

**SX800**

**X700**

# Canon: Focused on Leadership

LOOKING FOR EXCELLENCE IN PRESENTATION TECHNOLOGY? YOU'VE COME TO THE RIGHT SOURCE. FOR OVER

70 YEARS, CANON'S HERITAGE IN OPTICS AND COLOR MANAGEMENT REMAINS UNRIVALLED.

UNLIKE OTHER MANUFACTURERS, CANON'S MAIN



FOCUS IS THE OPTICAL SCIENCES. WE SPEND SIGNIFICANT R&D RESOURCES IN CULTIVATING GROWTH IN THE FIVE "IMAGING ENGINES" – IMAGE CAPTURING, ELECTROPHOTOGRAPHY, INKJET PRINTING, PHOTOLITHOGRAPHY AND DISPLAYS – AND THESE EXCITING BREAKTHROUGHS BENEFIT EVERY CANON PRODUCT, INCLUDING, OF COURSE, CANON REALiS PROJECTORS WITH LCOS (LIQUID CRYSTAL ON SILICON) TECHNOLOGY. FROM THE CREATION OF THE INCOMPARABLE CANON LENS TO CANON'S HIGH-ACCURACY COLOR MANAGEMENT SYSTEM, CANON OPTICS ARE BEST-OF-BREED. THE IMAGE OF PERFECTION.



**Canon**

# LCOS vs. LCD or DLP: What can REALiS do for you?

What's the LCOS technology advantage? Lattice-free, seamless images and smooth, film-like quality video.

Say goodbye to annoying visual distractions common with LCD projectors, such as the grid-like pixel patterns known as "screen door effect." Compared to LCD panels, LCOS panels result in smaller gaps seen between pixels – virtually eliminating the screen door.

Single-chip DLP projectors can produce troublesome red-green-blue spots, frequently referred to as a "rainbow effect." LCOS panel technology does not have this problem inherent to single-chip DLP projectors.

The seamless images projected using LCOS panels result in images with realistic depth and intricate detail. Fine lines are displayed accurately and clearly. Small text is crisp and dark (even at 7pt.), making it easy to read. Thanks to the fast response time of LCOS panels, high-definition video leaps off the screen with breathtaking quality and integrity.

There's no comparison. The advantages of LCOS are easy to see for both presenter and audience alike: crisp, clean images with deep contrast, fine grain and sharp resolution.

There's no clearer choice than REALiS Multimedia Projectors.

## Comparing Technologies

**LCOS Projector**  
Three-Panel

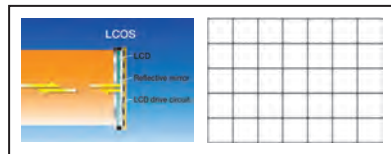
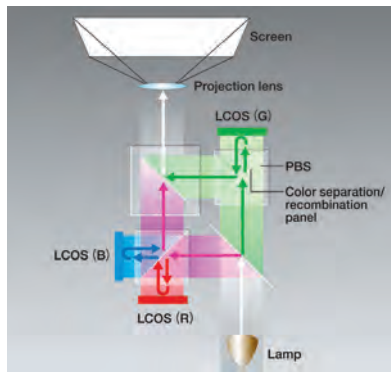

Light from the projector lamp is separated into red, green and blue, and then reflected from each of the three LCOS panels. The separated light is then recombined by the polarized beam splitter. Since the light is reflecting from the LCOS panels, there is virtually no "screen door" effect.

**LCD Projector**  
Three-Panel

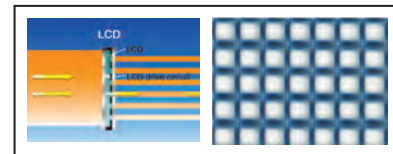
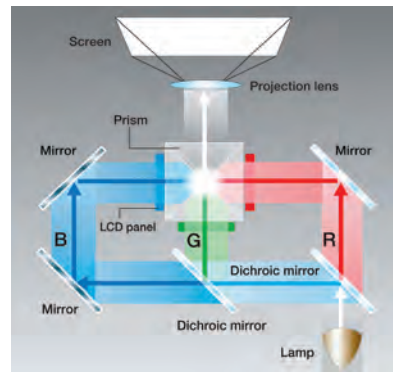

Light from the projector lamp is separated into red, green and blue, then passed through each of the three LCD panels. The separated light is then recombined by a prism. The light passes through the LCD panels as small dots, which tend to create a lattice-like pattern on the screen.

**DLP Projector**  
Single-Chip

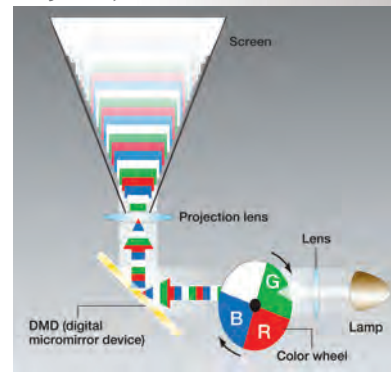

A constantly rotating color wheel reflects red, green, blue, and white image components off a micro-mirror device to produce the projected image. The three primary colors are sequentially displayed and synthesized in the viewer's brain to produce images perceived as full color.

## Seeing The Difference

Canon REALiS projectors use LCOS technology which virtually eliminates the appearance of gaps between pixels that exist in LCD and DLP projectors. Truth is, all three projector systems can provide equally high pixel counts. But here is the difference. With LCD, the panels contain pixels framed by drive circuits that obstruct a portion of the light from transmitting onto the screen. For DLP projectors, the chips are made of tiny reflective mirrors, one per pixel. These mirrors tilt back and forth based on the information of the images to be projected. As they tilt, the mirrors can create shadows which may give the appearance of spaces between pixels.

### Display of color and detail

REALiS projectors present outstanding color and intricate detail.

**LCOS**



**LCD**



**DLP**



*Images shown are for illustration purposes only. Simulated images displayed based on differences in aperture ratio for projectors using LCOS (>90%), LCD (60%), and DLP (<90%).*

# The AISYS Advantage

## Taking LCOS to the Next Level

Rarely satisfied and never complacent, count on Canon – and only Canon – to develop a method for making LCOS technology even better. Our proprietary AISYS Optical Engine

Image quality is optimized thanks to new optical elements that were incorporated into the illumination optical system, enhancing the uniformity of light. Technically speaking, the Polarizing Beam Splitters (PBS) in the color separation and recombination system are now designed for more precise light control. AISYS even allows us to produce a more compact unit, reducing unit weight and cost.

What does all this science mean to you? It means no one does LCOS like Canon. REALiS projectors bring you a whole new standard in bright, beautiful, high-definition, high contrast images. REALiS assures a captivated audience. REALiS assures confident presenters. REALiS brings you the next level in LCOS performance.

### AISYS OPTICAL ENGINE

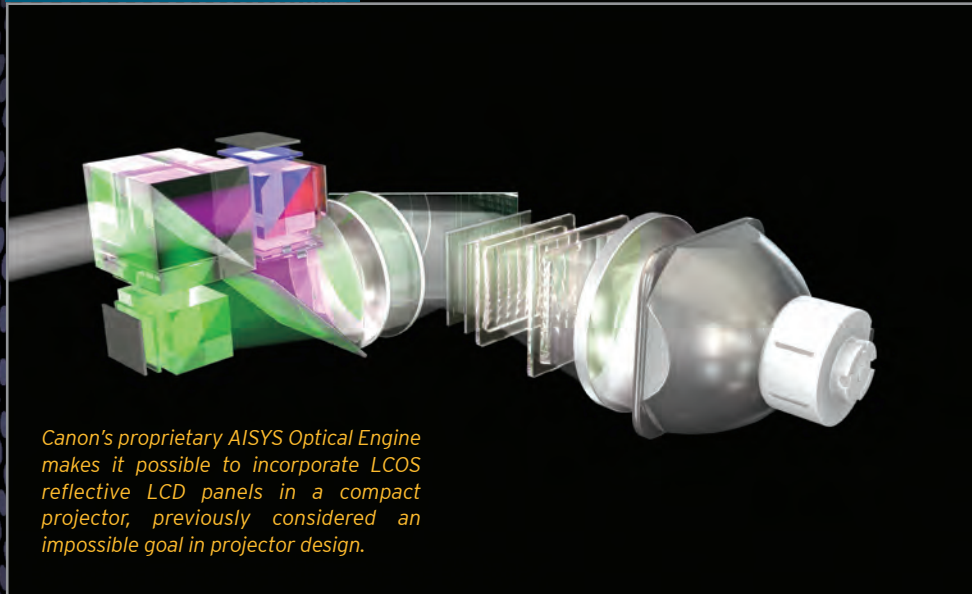

*Canon's proprietary AISYS Optical Engine makes it possible to incorporate LCOS reflective LCD panels in a compact projector, previously considered an impossible goal in projector design.*

efficiently utilizes and equalizes light from the projector lamp, thereby boosting the performance of both key functions: brightness and contrast. AISYS, which stands for Aspectual Illumination System, increases brightness and contrast together; one function never sacrifices the other, and that's a capability only Canon can deliver.

REALiS Multimedia Projectors come in a variety of models and feature sets to match your discerning needs. Select the solution that's right for you.

NEW



### WUX4000 D / WUX4000 High-Res Install Projectors

LCOS | WUXGA 1920 x 1200 | 4000 Lumens

Item Codes: 4964B005 (WUX4000 D), 4964B002 (WUX4000)

- 3 optional interchangeable lenses
- Motorized lens shift
- Easy-accessible lamp and filter
- HDMI™ V.1.3 Deep Color with 1080p Support
- DICOM Mode (WUX4000 D only)



### WUX10 Mark II D / WUX10 Mark II High Definition

LCOS | WUXGA 1920 x 1200 | 3200 Lumens

Item Codes: 4231B005 (WUX10 Mark II D), 4231B002 (WUX10 Mark II)

- 1.5x optical zoom lens (powered)
- HDMI™ V.1.3 Deep Color with 1080p Support
- Full 10-bit image processing
- Photo Image Mode
- DICOM Mode (WUX10 Mark II D only)



### SX7 Mark II D / SX7 Mark II Astounding Color Reproduction

LCOS | SXGA+ 1400 x 1050 | 4000 Lumens

Item Codes: 4233B008 (SX7 Mark II D), 4233B002 (SX7 Mark II)

- 1.7x optical zoom lens (powered)
- Adobe RGB color-match system
- 1000:1 contrast ratio
- Photo Image Mode
- DICOM Mode (SX7 Mark II D only)



### SX80 Mark II D / SX80 Mark II Versatile Performance

LCOS | SXGA+ 1400 x 1050 | 3000 Lumens

Item Codes: 4232B005 (SX80 Mark II D), 4232B002 (SX80 Mark II)

- 1.5x optical zoom lens (powered)
- HDMI™ V.1.3 Deep Color with 1080p Support
- 900:1 contrast ratio
- PC-free presentation, PictBridge
- Photo Image Mode
- DICOM Mode (SX80 Mark II D only)



### SX60 Whisper-Quiet Operation

LCOS | SXGA+ 1400 x 1050 | 2500 Lumens

Item Code: 1292B002

- 1.7x optical zoom lens (powered)
- 1000:1 contrast ratio
- 2000:1 contrast ratio in Home Cinema mode



### SX800 Affordable and Reliable

LCOS | SXGA+ 1400 x 1050 | 3000 Lumens

Item Code: 3289B002

- 1.5x optical zoom lens (powered)
- 900:1 contrast ratio
- 2 VGA inputs



### X700 High Quality - Fast, Easy and Quiet

LCOS | XGA 1024 x 768 | 4000 Lumens

Item Code: 2224B002

- 1.7x optical zoom lens (powered)
- 1000:1 contrast ratio
- 3 audio inputs/1 audio output

## Project an Enhanced Image

Whether you're in the engineering, architecture or business field...in healthcare, higher education or government...in fine arts, fashion or graphic design...if you're in the business of making impressions, impress your audience with REALiS Multimedia Projectors.

### Engineering, Architecture & Business

- The fine lines of blueprints and renderings are visible in clear detail.
- Contrast and accurate shadowing maximize form and texture.
- Tiny type is clearly readable and complex charts spring to life.

### Healthcare, Higher Education & Government

- Anatomical imagery and microscopic photography are recreated true-to-life.
- Historical documents and photos display stunning resolution.
- Intricate charts, maps and grids are easily viewed from a distance.

### Fine Arts, Fashion & Graphic Design

- Even the subtlest hues and color gradations are reproduced with amazing clarity.
- Crisp contrast and accurate grayscale help produce a true picture.
- Fine detail and razor resolution add depth, dimension and drama.

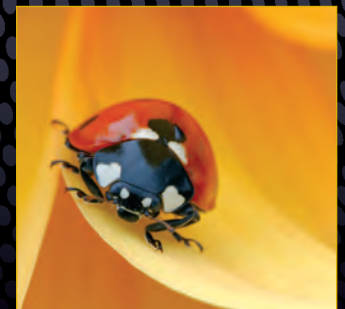
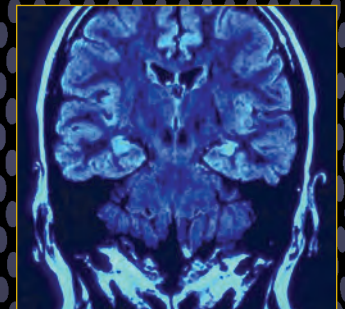

# REALiS Simple. REALiS Spectacular.

SIMPLY PUT, OUR CANON REALiS MULTIMEDIA PROJECTOR LINEUP PROVIDES POWERFUL FEATURES AND LEADING PERFORMANCE THAT EXCEED THE MOST DEMANDING QUALITY EXPECTATIONS – FROM PROFESSIONALS IN A VARIETY OF FIELDS.. YES, THERE ARE OTHER PROJECTORS AVAILABLE, BUT CANON SIMPLY DOES IT BEST.

## Genuine Canon Optics

In Canon's REALiS Series, the lens configuration is a six-group assembly with 12 elements and four moving groups, featuring one UD lens and two high-precision double-sided aspherical lenses. The result: amazing clarity.

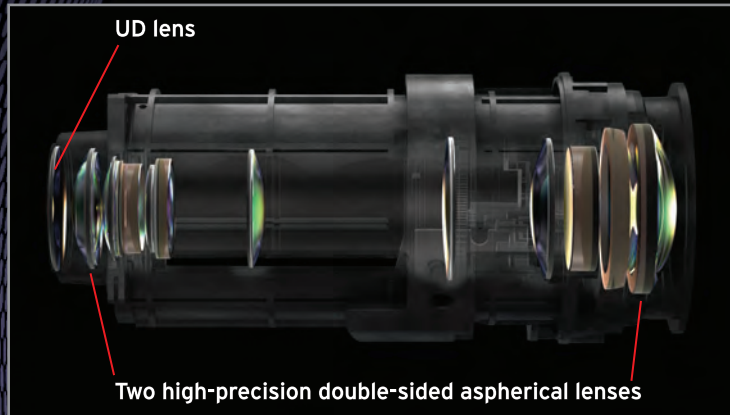

The new 1.5x Powered Zoom Lens has been engineered to accommodate LCOS reflective LCD panels. And, with our new 10:0 lens offset, REALiS projectors can now be pulled back even further without the image hitting the table or the ceiling. This minimizes the need for keystone correction. (See chart on opposite page.)

WUX4000 D WUX4000 WUX10 Mark II D  
WUX10 Mark II SX7 Mark II D SX7 Mark II  
SX80 Mark II D SX80 Mark II SX60 SX800 X700

The 1.7x Powered Zoom Lens gives you a diagonal screen size range of 40" when placed 3.9' away and 100" at 9.8' away. With a maximum screen size of 300", REALiS projectors adapts to virtually any room. The incorporation of a dual-sided aspherical lens in the optical array suppresses distortion and keeps peripheral image distortion to an absolute minimum. The result is enhanced resolution for accurate reproduction of highly detailed images.

WUX4000 D WUX4000 WUX10 Mark II D  
WUX10 Mark II SX7 Mark II D SX7 Mark II  
SX80 Mark II D SX80 Mark II SX60 SX800 X700

This exciting new technology means Canon now offers a WUXGA LCOS projector, featuring superior brightness, spectacular image quality and flexible operational functions – all in a conveniently compact and cost-effective package. In fact, the latest notebook PCs already support native WUXGA, an ideal solution for today's HD and Blu-Ray content. (See chart A)

WUX4000 D WUX4000 WUX10 Mark II D  
WUX10 Mark II SX7 Mark II D SX7 Mark II  
SX80 Mark II D SX80 Mark II SX60 SX800 X700

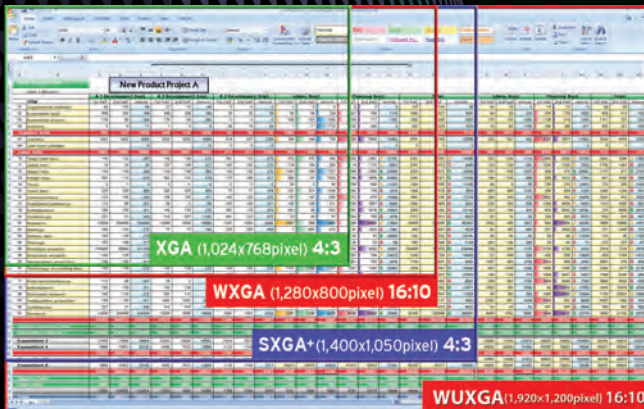

Chart A

## Canon Throw Distance

### REALiS WUX4000 D, WUX4000 (1.5x Zoom Lens RS-IL01ST)

Projection Image Size		40"	80"	100"	150"	200"	300"
Projection Distance	Wide	1.3'	2.6'	3.2'	4.8'	6.4'	9.6'
	Tele	1.9'	3.9'	4.8'	7.2'	9.6'	14.5'

### REALiS WUX4000 D, WUX4000 (Long Focus Zoom Lens RS-IL02LZ)

Projection Image Size		40"	80"	100"	150"	200"	300"
Projection Distance	Wide	1.9'	4.2'	4.7'	7.1'	9.5'	14.2'
	Tele	3.2'	7.2'	8.0'	12.1'	16.1'	24.2'

### REALiS WUX4000 D, WUX4000 (Ultra Wide Angle Lens RS-IL03WF)

Projection Image Size		40"	80"	100"	150"	200"	300"
Projection Distance	Fixed	0.7'	1.6'	1.7'	2.6'	3.4'	5.2'

### REALiS WUX10 MARK II D, WUX10 MARK II

Projection Image Size		40"	80"	100"	150"	200"	300"
Projection Distance	Wide	3.9'	7.9'	9.8'	14.8'	20.0'	29.9'
	Tele	5.6'	11.5'	14.4'	22.0'	29.2'	-

### REALiS SX7 MARK II D, SX7 MARK II, SX60, X700

Projection Image Size		40"	80"	100"	150"	200"	300"
Projection Distance	Wide	3.9'	7.9'	9.8'	14.8'	19.7'	29.5'
	Tele	5.9'	11.5'	14.4'	21.7'	29.2'	-

### REALiS SX80 MARK II D, SX80 MARK II, SX800

Projection Image Size		40"	80"	100"	150"	200"	300"
Projection Distance	Wide	3.9'	7.9'	9.8'	14.8'	19.7'	29.9'
	Tele	5.6'	11.5'	14.4'	21.7'	29.2'	-

## Proprietary Color Management

### Amazing Color Quality and Control

Canon's high-accuracy Color Management System (CMS) ensures accurate color reproduction for an extended color space and compensates for color variances due to lighting differences. The advantage: true HD-quality color even in the toughest conditions.

WUX4000 D WUX4000 WUX10 Mark II D  
WUX10 Mark II SX7 Mark II D SX7 Mark II  
SX80 Mark II D SX80 Mark II SX60 SX800 X700

### Crisp Blacks Enhance Shadow Detail

Precise control prevents the excess leakage of light, producing rich, detailed gradations even in the shadowed portions of images – recreating depth and dimension with stunning drama and realism.

WUX4000 D WUX4000 WUX10 Mark II D  
WUX10 Mark II SX7 Mark II D SX7 Mark II  
SX80 Mark II D SX80 Mark II SX60 SX800 X700

### Adobe RGB Color Match System

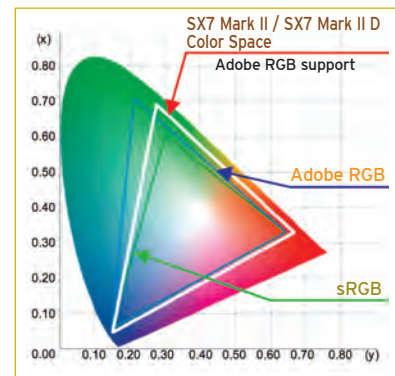

Proprietary color filters incorporated into the AISYS optical system deliver exceptional accuracy and detail in both Adobe RGB and sRGB modes. This is ideal for professional photography, design, publishing, printing and fine art, where color integrity is crucial.

WUX4000 D WUX4000 WUX10 Mark II D  
WUX10 Mark II SX7 Mark II D SX7 Mark II  
SX80 Mark II D SX80 Mark II SX60 SX800 X700

### 6-Axis Color Adjustments

A 6-Axis Color Adjustment function meets and exceeds the demands of professionals with demanding color requirements. Both hue and saturation can be adjusted independent of RGB and CMYK color axes.

WUX4000 D WUX4000 WUX10 Mark II D  
WUX10 Mark II SX7 Mark II D SX7 Mark II  
SX80 Mark II D SX80 Mark II SX60 SX800 X700

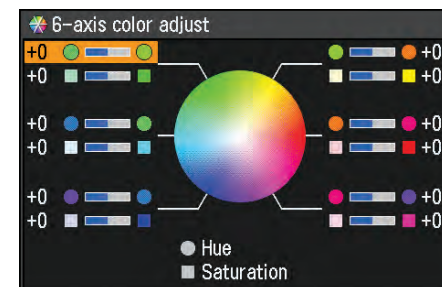

A bluer sky



Original



Color Adjusted

More orange in the sunset

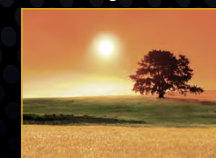

Original



Color Adjusted

# Versatile Performance

## 16:9 Digital Image Shift



Before Shift



Digital Image Shift UP



Digital Image Shift DOWN

## 16:9 Screen Aspect Mode



Watch 4:3 content on a 16:9 screen



Watch 16:9 content on a 16:9 screen

## Screen Aspect Modes

Canon REALiS projectors operate brilliantly in both 4:3 aspect ratio and 16:9 aspect ratio. So, no matter which screen you own, you won't need to purchase another.

WUX4000 D WUX4000 WUX10 Mark II D  
WUX10 Mark II SX7 Mark II D SX7 Mark II  
SX80 Mark II D SX80 Mark II SX60 SX800 X700

## AC Projector Lamp

A newly engineered AC lamp boosts the purity of projected reds and greens. Built for extended life as well, it not only ensures more vivid images, it also means a better value.

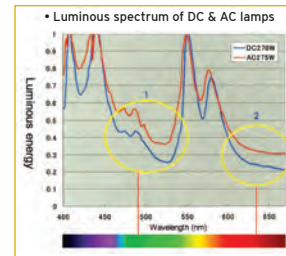

WUX4000 D WUX4000 WUX10 Mark II D  
WUX10 Mark II SX7 Mark II D SX7 Mark II  
SX80 Mark II D SX80 Mark II SX60 SX800 X700

## Image Modes

REALiS projectors allow you to select the image mode that best suits the characteristics of your content. For example, select "Presentation" mode for briefings and conferences or "Adobe RGB" or "sRGB" when color fidelity is essential. The model SX60 even comes equipped with a home cinema filter, making it ideal for this entertainment application. (see below)

WUX4000 D WUX4000 WUX10 Mark II D  
WUX10 Mark II SX7 Mark II D SX7 Mark II  
SX80 Mark II D SX80 Mark II SX60 SX800 X700

## Photo Image Mode

For highly precise color temperature and color level adjustments, Canon has incorporated Photo Image Mode into select REALiS projectors. Ideal for displaying digital camera images, Photo Image Mode provides clearly defined gradations and improved color reproduction.

WUX4000 D WUX4000 WUX10 Mark II D  
WUX10 Mark II SX7 Mark II D SX7 Mark II  
SX80 Mark II D SX80 Mark II SX60 SX800 X700

## DICOM Simulation Mode

DICOM, or Digital Imaging and Communication in Medicine Simulation Mode, allows medical professionals to produce high-resolution images with twenty-one different levels of grayscale gradation for displaying film-like x-rays to large audiences in lecture halls, while also presenting ultra-smooth, lattice-free images.

WUX4000 D WUX4000 WUX10 Mark II D  
WUX10 Mark II SX7 Mark II D SX7 Mark II  
SX80 Mark II D SX80 Mark II SX60 SX800 X700

## Presenter-Friendly Use

### Quiet Operation

Why do most projectors make so much noise? It's the cooling system needed to dissipate the considerable heat generated by the unit. On all REALiS models, however, ventilation vents, the cooling fan and the layout of the optical array have all been engineered with noise prevention in mind, resulting in exceptionally quiet operation.

WUX4000 D WUX4000 WUX10 Mark II D  
WUX10 Mark II SX7 Mark II D SX7 Mark II  
SX80 Mark II D SX80 Mark II SX60 SX800 X700

## Image Modes

Model	Standard	Presentation	Movie	Movie & Photo	Vivid Photo	Adobe RGB	sRGB	Photo/sRGB	User Setting 1-5	Dynamic	Video	Cinema
WUX4000 D WUX4000 AV	■	■	■	■	■	■	■	■	■	■	■	■
WUX10 Mark II D WUX10 Mark II	■	■	■	■	■	■	■	■	■	■	■	■
SX80 Mark II D SX80 Mark II	■	■	■	■	■	■	■	■	■	■	■	■
SX7 Mark II D SX7 Mark II	■	■	■	■	■	■	■	■	■	■	■	■
SX60	■	■	■	■	■	■	■	■	■	■	■	■
SX800	■	■	■	■	■	■	■	■	■	■	■	■
X700	■	■	■	■	■	■	■	■	■	■	■	■

■ **Standard** Prioritizes reproduction of white, closely matching the image characteristics of the original

■ **Presentation** Produces a bright, high-contrast display for ease of viewing text and numerical data

■ **Movie** Suitable for displaying theatrical content; image quality emphasizes gradation in dark areas

■ **Movie & Photo** For display of video and digital camera images; clearly defines gradations and improves color reproduction

■ **Vivid Photo** Emphasizes the vividness of colors. Suitable for viewing in a somewhat darker room.

■ **Adobe RGB** ■ **sRGB** ■ **Photo/sRGB** Reproduces colors in the appropriate color space for accurate projection of content produced in specific standardized formats

■ **Home Cinema** Controls brightness while enhancing contrast to a ratio of 2000:1; for display of theatrical content in pitch-dark rooms

■ **Photo Image** provides highly precise color temperature and color level adjustments and clearly defined gradations

■ **DICOM Simulation** is used to produce high-resolution images with twenty-one different levels of grayscale gradation. Available on select models only.

■ **User Setting 1-5** Users can register up to 5 types of combinations of settings of image quality into memory for future use.

■ **Dynamic** Suitable for viewing visual software (moving pictures) in a somewhat brighter room.

■ **Video** Suitable for viewing video taken with a video camera and similar video in a somewhat darker room.

■ **Cinema** Suitable for ordinary visual software (video). Mode allows viewers to easily enjoy the atmosphere of a movie theater in a dim room.



## LED Input Illumination

When several image input devices are connected, an LED indicates which image signal is selected as the input. The LED illumination on the operation panel flashes to indicate start-up, end of presentation and other commands.

WUX4000 D WUX4000 WUX10 Mark II D  
WUX10 Mark II SX7 Mark II D SX7 Mark II  
SX80 Mark II D SX80 Mark II SX60 SX800 X700

## Remote Control Convenience

These flexible remote control features enable presenters to drive home a point without ever breaking stride.

WUX4000 D WUX4000 WUX10 Mark II D  
WUX10 Mark II SX7 Mark II D SX7 Mark II  
SX80 Mark II D SX80 Mark II SX60 SX800 X700

**Digital Zoom** - enlarges a selected single area of the screen, like specific data in a graph; images can be enlarged up to 12x.\*

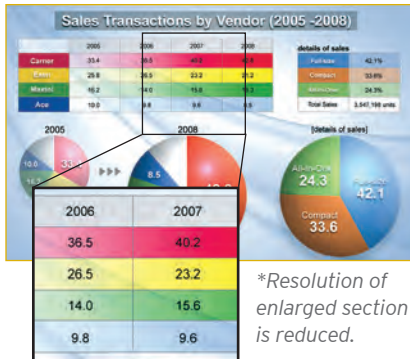

**Spot** - highlights a portion of the image on the screen; the spotlight can be made larger or smaller, or it can be moved anywhere on the screen.

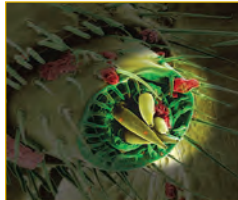

**Freeze** - lets you freeze the on-screen display for pauses in the presentation, such as changing PC connections or checking the subsequent image file.

## Auto Setup

These smart features make preparing for a presentation quick and easy. Just press the Auto Setup button, and within seconds your input source is connected, distortion is corrected, focus is sharpened and color is balanced.

\*The SX800 Auto-Set-up feature does not include Auto Focus and Auto Screen Color

WUX4000 D WUX4000 WUX10 Mark II D  
WUX10 Mark II SX7 Mark II D SX7 Mark II  
SX80 Mark II D SX80 Mark II SX60 SX800 X700

**Auto Keystone** - automatically calculates the angle of the projector and corrects for image distortion. Vertical (+/- 20°).



**Auto Screen Color** - automatically adjusts the color balance according to the projection surface's color, such as a green chalkboard.



Without Color Correction With Color Correction

**Auto Input** - automatically detects and identifies the image signal from the input terminal and selects it for display.

**Auto Focus** - automatically measures the distance to the screen using an infrared sensor, and adjusts the focus in as little as one second.



## Direct Power On

All models can be switched on and off from a central control terminal without having to press the buttons on the unit. This permits remote operation when the unit is mounted overhead. When the Direct Power setting is "on," and power is introduced, the projector starts up automatically and is ready to display in about 20 seconds.

WUX4000 D WUX4000 WUX10 Mark II D  
WUX10 Mark II SX7 Mark II D SX7 Mark II  
SX80 Mark II D SX80 Mark II SX60 SX800 X700

## Guide Functions

All REALiS models display guide messages in an on-screen window, providing feedback on invalid operations and setup tips.

WUX4000 D WUX4000 WUX10 Mark II  
WUX10 Mark II D SX7 Mark II D SX7 Mark II  
SX80 Mark II D SX80 Mark II SX60 SX800 X700

## Off and Go

All REALiS models are equipped with an internal charging system to run the fan. This makes it possible to unplug the projector and pack up and go immediately after using it, while the unit continues to cool down.

WUX4000 D WUX4000 WUX10 Mark II D  
WUX10 Mark II SX7 Mark II D SX7 Mark II  
SX80 Mark II D SX80 Mark II SX60 SX800 X700



Before Auto Focus



After Auto Focus



Guide functions display

# Convenient. Connectable. Compatible.

REALIS MULTIMEDIA PROJECTORS ARE NOT ONLY EASY FOR PRESENTERS TO USE, BUT ALSO FOR ORGANIZATIONS TO INSTALL, NETWORK AND MAINTAIN. OUR TECHNOLOGY IS ENGINEERED FOR SEAMLESS INTEGRATION WITH A VARIETY OF INFORMATION TECHNOLOGY, NETWORK MANAGEMENT AND AUDIO/VISUAL ENVIRONMENTS. IN A PHRASE, IT'S BUILT TO FIT IN.

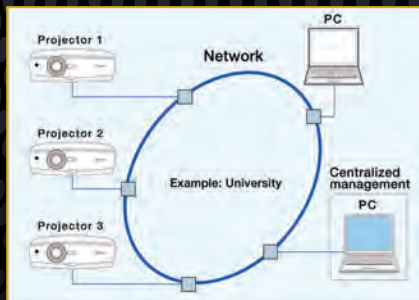

## Flexible Compatibility

REALIS Multimedia Projectors are compatible with a variety of image signals, including HDTV.

- 1 Digital RGB Input/  
Analog RGB Input (DVI-I)
- 2 HDMI Input
- 3 Analog RGB Input
- 4 Component Input
- 5 Monitor Output
- 6 USB Port
- 7 S-Video Input
- 8 Video Input
- 9 Stereo Audio Input
- 10 Stereo Audio Output
- 11 RS-232C/Controller
- 12 Network
- 13 Digital RGB Input  
(DVI-D)

WUX4000 D / WUX4000



SX800

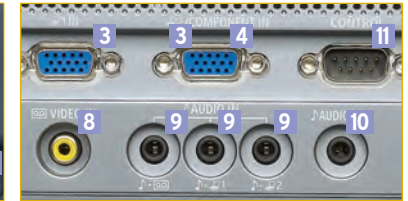

SX80 MARK II D  
SX80 MARK II

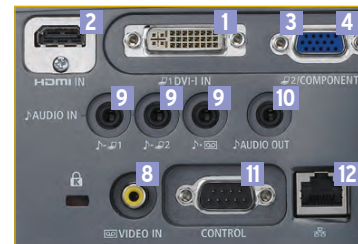
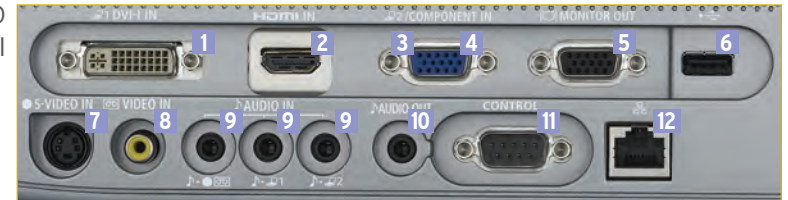

WUX10 MARK II D  
WUX10 MARK II

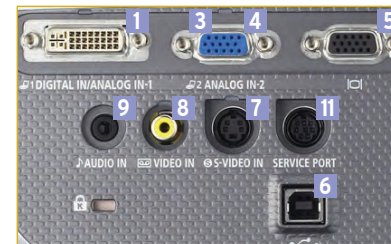

SX60

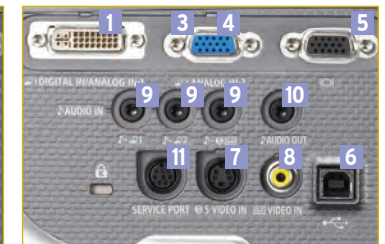

SX7 MARK II D / SX7 MARK II  
X700

## Network Management

Multiple projectors can be managed through a built-in network port. This feature makes it possible to operate ceiling-mounted units or other remote installations from a single PC screen. The SX60 and the X700 require an optional network adapter to operate the projector from a networked PC.

WUX4000 D WUX4000 WUX10 Mark II D  
WUX10 Mark II SX7 Mark II D SX7 Mark II  
SX80 Mark II D SX80 Mark II SX60 SX800 X700

## Audio Input & Output

Audio input source will switch automatically to match the image signal. Audio output terminals permit connection to external audio devices, making it easy to control sound levels from the projector's remote control unit.

WUX4000 D WUX4000 WUX10 Mark II D  
WUX10 Mark II SX7 Mark II D SX7 Mark II  
SX80 Mark II D SX80 Mark II SX60 SX800 X700

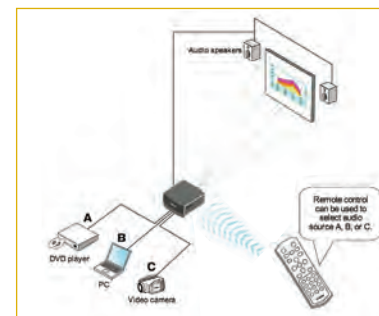

## PC-Free Presentations

Need to share media not resident on a PC? No problem with our convenient built-in interfaces. Connect a USB memory stick directly into the projector, connect a PictBridge compatible digital camera via USB cable or use the HDMI™ terminal for instant display of HD video.

WUX4000 D WUX4000 WUX10 Mark II D  
WUX10 Mark II SX7 Mark II D SX7 Mark II  
SX80 Mark II D SX80 Mark II SX60 SX800 X700



## Optional Accessories

To increase the performance value of your REALiS projector, add these smart accessories.



**Ceiling Mount**  
RS-CL07  
WUX10 Series, SX7 Series, SX60, X700,  
RS-CL10  
SX80 Series, SX800  
RS-CL11  
WUX4000 Series



**Replacement Lamp**  
RS-LP03  
SX60  
RS-LP04  
WUX10 Series, SX7 Series, X700,  
RS-LP05  
SX80 Series, SX800  
RS-LP06  
WUX4000 Series



**Ceiling Extension**  
RS-CL08  
(15.75"-23.60")  
RS-CL09  
(23.60"-39.37")  
Compatible with the  
RS-CL07, RS-CL10,  
and RS-CL11



**Replacement Air Filter**  
RS-FL01  
WUX4000 Series



**DVI-D Cable**  
LV-CA29  
WUX10 Series, SX7 Series,  
SX80 Series, SX60, X700



**RS-232C Cable**  
RS-CA01 9.8'  
1025V632 18"  
SX7 Series, SX60,  
X700



**Network Adapter**  
RS-NA01  
SX60, X700



**1.5x Zoom Lens**  
RS-IL01ST  
WUX4000 Series



**Ultra Wide Angle Lens**  
RS-IL03WF  
WUX4000 Series



**Remote Control**  
RS-C04  
WUX4000 Series



**Long Focus Zoom Lens**  
RS-IL02LZ  
WUX4000 Series



**Wide Angle Converter Lens**  
T-WC070  
SX7 Series, SX60, X700



**REALiS Rolling Projector Case**  
All Projectors  
(except WUX4000 Series)

## Kit Contents

REALiS projectors come with everything you need to begin presenting right out of the box.



Remote Control



Soft Case\*\*\*\*



Computer Cable\*\*  
(VGA-VGA)



USB Cable\*



Computer Cable\*\*\*  
(DVI-VGA)



Power Cord



Component Video  
Adapter Cable\*\*\*\*

- \* Only included with the SX7 Series and the X700.
- \*\* Only included with the SX800 and WUX4000 Series.
- \*\*\* Not included with the SX800 or WUX4000 Series.
- \*\*\*\* Not included with the WUX4000 Series.

## Customer Service

How do you make what's already better *best* in its class? You provide unprecedented customer support. Like our "Triple P" Program.

### "Triple P" Program

Canon's Projector Protection Program, also known as "Triple P," is a service program that provides a loaner projector of equal or greater quality in the event that your projector needs to be repaired.



- Free to any buyer within the 3-year new product limited warranty
- Canon Customer Support Center toll-free hotline: 1-800-828-4040
- Customer Service Hours: 8 a.m. to midnight, Monday-Friday and 10 a.m. to 8 p.m., Saturday EST
- For next business day delivery of loaner projector(s), a Customer Activation Form must be received by Canon Customer Support Center by 3 p.m. EST (Monday-Friday)
- Customer must provide a valid credit card as security for the loaner unit
- Delivery not available on Saturday and Sunday
- Program available for products purchased and utilized in the U.S.A. only
- Applies to Canon Multimedia Projectors only
- Loaner unit based on availability
- Program subject to change at any time without any given notice

Make it real.  
Make it REALiS.

COMMITTED TO  
**SERVICE & SUPPORT EXCELLENCE**

Canon has built its reputation as an industry leader in product reliability, service and support. No matter what Canon consumer product you buy, expect a top-rate experience. From our cutting edge technology to industry-leading response times for service and support, Canon USA strives for complete customer satisfaction in everything we do.

www.usa.canon.com/prosatisfaction  
1-800-OK-CANON



## Product Specifications

### FEATURES

NEW

	WUX4000 D WUX4000	WUX10 Mark II D WUX10 Mark II	SX7 Mark II D SX7 Mark II	SX80 Mark II D SX80 Mark II	SX60	SX800	X700
Native Resolution	1920 x 1200		1400 x 1050				1024 x 768
Max. Resolution Supported	1920 x 1200		1600 x 1200				
Imaging Technology	0.7" LCOS x 3		0.55" LCOS x 3	0.7" LCOS x 3	0.55" LCOS x 3	0.7" LCOS x 3	
Brightness	4000 Lumens	3200 Lumens	4000 Lumens	3000 Lumens	2500 Lumens	3000 Lumens	4000 Lumens
Uniformity	88%						
Contrast Ratio	1000:1		900:1	1000:1/2000:1 in Home Cinema mode	900:1	1000:1	
Digital Keystone Correction	Depends on optional lens	+20° vertical (Auto/Manual)	+20° vertical (Auto/Manual), +/-20° horizontal (Manual)	+20° vertical (Auto/Manual)	+20° vertical (Auto/Manual), +/-20° horizontal (Manual)	+20° vertical (Auto/Manual)	+20° vertical (Auto/Manual), +/-20° horizontal (Manual)
DICOM Simulation	WUX4000 D Only	WUX10 Mark II D Only	SX7 Mark II D Only	SX80 Mark II D Only	N/A		
Photo Mode	YES				N/A		
Lens Offset	N/A	10:0, Fixed	9:1, Fixed	10:0, Fixed	9:1, Fixed	10:0, Fixed	9:1, Fixed
Zoom Lens	Depends on optional lens	1.5x Powered 12x Digital	1.7x Powered 12x Digital	1.5x Powered 12x Digital	1.7x Powered 12x Digital	1.5x Powered 12x Digital	1.7x Powered 12x Digital
Focus	Powered (Manual)	Powered (Auto/Manual)					
Screen Size	40" - 300"						
Projection Distance	See Page 7	3.9 - 29.9 ft (1.2 - 9.1)	3.9 - 29.5 ft (1.2 - 9.0)	3.9 - 29.9 ft (1.2 - 9.1)	3.9 - 29.5 ft (1.2 - 9.0)	3.9 - 29.9 ft (1.2 - 9.1)	3.9 - 29.5 ft (1.2 - 9.0)
Throw Ratio (D:W)	See Page 7	1.48 - 2.18:1	1.46 - 2.43:1	1.48 - 2.18:1	1.46 - 2.43:1	1.48 - 2.18:1	1.46 - 2.43:1
Computer Inputs	Input 1	DVI-D	DVI-I†			D-sub 15	DVI-I†
	Input 2	D-sub 15	D-sub 15††				
Computer Output	NA		D-sub 15		N/A	D-sub 15	
Scanning Frequency	H:15 ~ 75kHz, V:50 ~ 85Hz, Dot clock: 162MHz or less	H:15 ~ 75kHz, V:50 ~ 85Hz, Dot clock: 170MHz	H:15 ~ 100kHz, V:50 ~ 100Hz, Dot clock: 170MHz	H:15 ~ 75kHz, V:50 ~ 85Hz, Dot clock: 170MHz	H:15 ~ 100kHz, V:50 ~ 100Hz, Dot clock: 170MHz	H:15 ~ 75kHz, V:50 ~ 85Hz, Dot clock: 170MHz	H:15 ~ 100kHz, V:50 ~ 100Hz, Dot clock: 170MHz
Video Inputs	HDMI, DVI-D, Component, Composite	HDMI, DVI-I,* Component,** Composite	DVI-I,* Component,** S-Video, Composite	HDMI, DVI-I,* Component,** S-Video, Composite	DVI-I,* Component,** S-Video, Composite	Component,** Composite	DVI-I,* Component,** S-Video, Composite
Video Support	1080p / 1080i / 720p 576p / 480p / 480i	1080p / 1080i / 1035i 720p / 576p / 576i 480p / 480i	1080i / 1035i / 720p 576p / 576i / 480p 480i	1080p / 1080i / 1035i 720p / 576p / 576i 480p / 480i	1080i / 1035i / 720p 575p / 575i / 480p 480i	1080p / 1080i / 1035i 720p / 576p / 576i 480p / 480i	1080i / 1035i / 720p 575p / 575i / 480p 480i
Audio Input/Output	Stereo audio input x 2, Stereo audio output x 1	Stereo audio input x 3, Stereo audio output x 1		Stereo audio input x 1	Stereo audio input x 3, Stereo audio output x 1		
Mouse Control/PictBridge	N/A		Mouse (USB)	PictBridge (USB)	Mouse (USB)	N/A	Mouse (USB)
Serial Control	D-Sub 9 pin		Mini DIN 8 pin	D-Sub 9 pin	Mini DIN 8 pin	D-Sub 9 pin	Mini DIN 8 pin
Network	Yes, RJ-45		N/A	Yes, RJ-45	Optional Adapter	N/A	Optional Adapter
Lamp Type	330W NSH (AC)	275W NSH (AC)		230W NSH (AC)	180W NSH (DC)	230W NSH (AC)	275W NSH (AC)
Lamp Life (Normal/Quiet)	3000/4000 Hours	2000/3000 Hours		2000/2500 Hours	2500/4000 Hours	2000/2500 Hours	2000/3000 Hours
Noise Level (Normal/Quiet)	39/36 dB	36/32dB	35/31dB	30/27dB	35/31dB		
Power Voltage	AC 100 - 240V, 50/60Hz						
Dimensions (WxDxH)	14.96" x 16.92" x 5.90" (without lens)	11.2" x 13.2" x 4.5"	10.5" x 13.2" x 4.5"	13.0" x 13.4" x 4.8"	10.5" x 13.2" x 4.5"	13.0" x 13.4" x 4.8"	10.5" x 13.2" x 4.5"
Weight	18.7 lbs. (without lens)	10.9 lbs.	10.6 lbs.	11.5 lbs.	10.1 lbs.	11.0 lbs.	10.6 lbs.
Warranty	3 years parts and labor, 120-day lamp warranty						

**Canon**  
image*ANYWARE*

1-800-OK-CANON  
www.usa.canon.com/projectors

Canon U.S.A., Inc.  
One Canon Plaza  
Lake Success, NY 11042 U.S.A.

Canon Canada Inc.  
6390 Dixie Road  
Mississauga, Ontario L5T 1P7  
Canada

Canon Latin America  
703 Waterford Way, Suite 400  
Miami, FL 33126 U.S.A.

Canon Mexicana, S. de R.L. de C.V.  
Blvd. Manuel Ávila Camacho  
No. 13B, Piso 17  
Col. Lomas de Chapultepec  
C.P. 11000 México, D.F. México

©2010 CANON U.S.A., INC.  
PRINTED IN U.S.A.

0149W594 12/10

† Supports either digital or analog signals †† Can be analog PC or 5 BNC input  
\* HDCP Compliant \*\* Using analog PC input 2 and VGA to RGB adapter

Errors and omissions excepted. Weight and dimensions are approximate. Specifications subject to change without notice.  
Download from [www.SoftManuals.com](http://www.SoftManuals.com). All Manuals Search And Download.

## Free Manuals Download Website

<http://myh66.com>

<http://usermanuals.us>

<http://www.somanuals.com>

<http://www.4manuals.cc>

<http://www.manual-lib.com>

<http://www.404manual.com>

<http://www.luxmanual.com>

<http://aubethermostatmanual.com>

Golf course search by state

<http://golfingnear.com>

Email search by domain

<http://emailbydomain.com>

Auto manuals search

<http://auto.somanuals.com>

TV manuals search

<http://tv.somanuals.com>