

METROPOLITAN

OWNER'S MANUAL

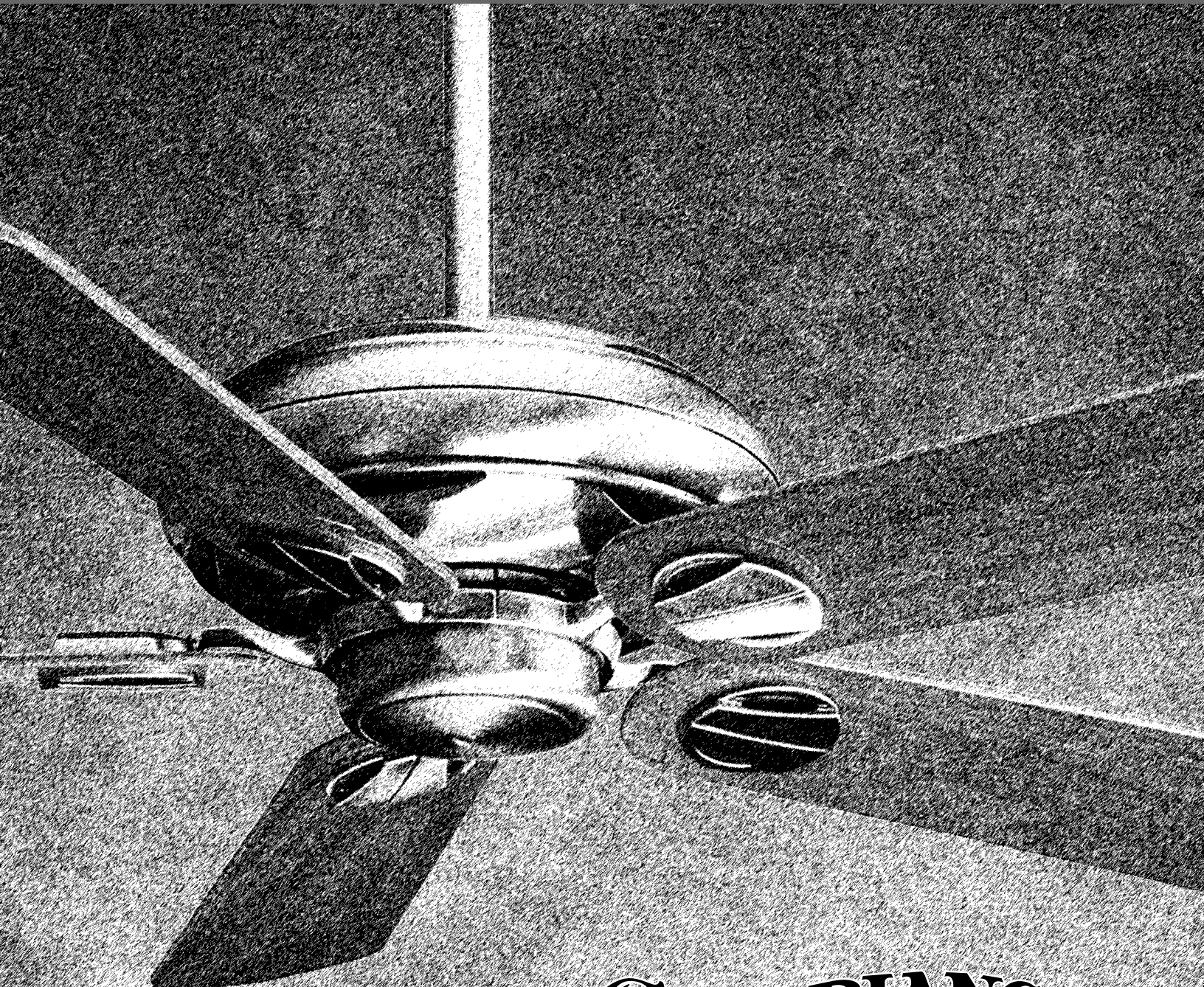

CASABLANCA[®]
FAN COMPANY

CONTENTS

INTRODUCTION	1
MOUNTING RECOMMENDATIONS	2
FAN INSTALLATION	3
CONTROL FEATURES:	
INTELI•TOUCH OPERATION	8
TROUBLESHOOTING INTELI•TOUCH	11
COMFORT•TOUCH OPERATION	12
TROUBLESHOOTING COMFORT•TOUCH	16

READ AND SAVE THESE INSTRUCTIONS

SAFETY FIRST

Safety and the proper operation of your Casablanca fan both require a thorough knowledge of the product and proper installation; therefore, before attempting to install and operate your Casablanca fan, read this owner's manual completely and carefully. Retain this manual for future reference.

CAUTION: To avoid possible electrical shock, make certain that electricity is turned off at the circuit breaker or fuse box before attempting any installation procedure.

BEFORE YOU START

- All wiring must be in accordance with the National Electric Code ANSI/NFPA 70-1993 and the appropriate local electrical codes. The National Electric Code requires proper grounding as a precaution against electrical shock. A qualified electrician should be consulted if you are unsure.
- This fan is designed to be installed on an existing electrical outlet box. The outlet box must be UL Listed for ceiling fan installations, if it is not, a new box must be installed. Casablanca extension poles are available for sloped or high ceiling installations.
- This ceiling fan requires a grounded electrical supply of 120 VAC, 60 Hz and a minimum 15 amp circuit. The maximum current requirement for the fan with light fixture is 3.8 amps. The fan uses about 1 amp or 100 watts. Maximum light current is 2.8 amps or 340 watts of lighting.
- Where wire nuts are employed, be sure all bare wires are within the connectors. When installing the canopy hatch, make sure all wires are within the canopy and that no wires are being pinched.

For best performance and for your warranty to be valid, use only genuine Casablanca blades, light fixtures, and accessories.

SAFE USE

- The blades in each pack are matched for equal weight to assure smooth fan operation. If more than one fan is being installed, be careful not to mix blades from different cartons.
- Inspect the contents of your carton for possible shipping or handling damage and report any such damage directly to your authorized Casablanca dealer.
- It is always a good idea to have an assistant to help with the installation.
- When cleaning, painting, or working near your fan, be very careful of the fan and blades. Always turn the power OFF to the ceiling fan before servicing it, working on it, or replacing light bulbs.
- Never insert anything into the path of the fan blades while the fan is in operation.
- Never install a fan over a pool or spa.
- Never operate a fan that has been damaged in any way. Contact Casablanca Fan Company by calling toll free 1-888-227-2178, or contact your local authorized Casablanca dealer for assistance in obtaining service.

FUSE BOX
(REMOVE FUSE FOR THE
CIRCUIT YOU WILL BE
WORKING ON)

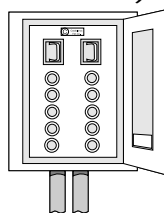

CIRCUIT BREAKER
(TRIP BREAKER FOR THE
CIRCUIT YOU WILL BE
WORKING ON)

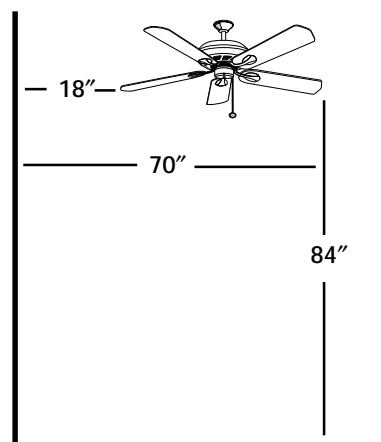
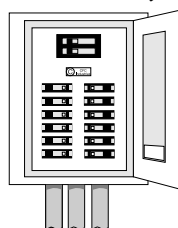

CAUTION: MOUNT WITH THE LOWEST MOVING PARTS AT LEAST 2.5 METRES ABOVE FLOOR OR GRADE LEVEL.

ATTENTION: INSTALLER DE SORTE QUELES PIÈCES INFÉRIEURES SOIENT À AU MOINS 2.5 MÈTRES AU-DESSUS DU PLANCHER OU DU SOL.

MOUNTING RECOMMENDATIONS

Before mounting your Casablanca fan, read the following helpful recommendations. The location of the fan, air circulation, and fan size are all important factors to consider before installation.

Location

Ceiling fans have practical uses in almost every room in your home. We suggest you follow these mounting recommendations as you decide where to install your Casablanca fan.

- For safety reasons, the fan blades must be a minimum of 7' above the floor.
- Do not locate the fan in a doorway or above a swinging door.
- In any installation, the tips of the blades must be at least 18" from the wall in order to provide sufficient clearance for the blades.
- In bedrooms, fans work best when mounted above the foot of the bed.
- Over pool tables, be sure to provide plenty of clearance to avoid damage from pool cues.
- In low ceiling locations, our optional Low Ceiling Adaptor (LCA)—available at extra cost—can be used to gain 3 1/2".
- In kitchens be sure to allow for open cupboard doors to clear the fan blades.
- Do not install a fan close to, or over, a pool or spa. High humidity combined with corrosive gases will destroy the finish and warp the blades.

Fan Size

Variable fan speed capability permits the use of a full-size 52" fan even in smaller rooms. For very large rooms, two fans may be needed.

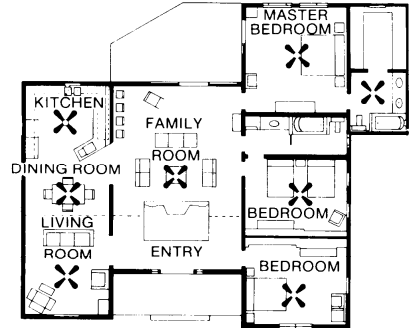

SLOPED CEILING INSTALLATIONS

Suggested Extension Pole Lengths	
Ceiling Height	Pole Length
8'	Standard
8' 6"	Standard
9'	6"
9' 6"	12"
10'	12"
11'	18"
12'	24"
13'	36"
14'	48"

When to Use Extension Poles

For best performance and best appearance, an extension pole should be used with your Casablanca fan when installing on high (cathedral) ceilings or sloped ceilings. Casablanca offers standard poles in increments of 6" up to 5'. Custom poles are available in lengths up to 10'. See your Authorized Casablanca Dealer for details.

Note: Fan may wobble or vibrate if pole length is not long enough and inside blade is too close to downslope or side wall. Extending pole length will usually solve problem.

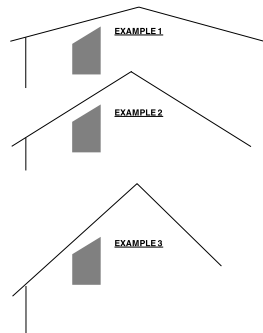
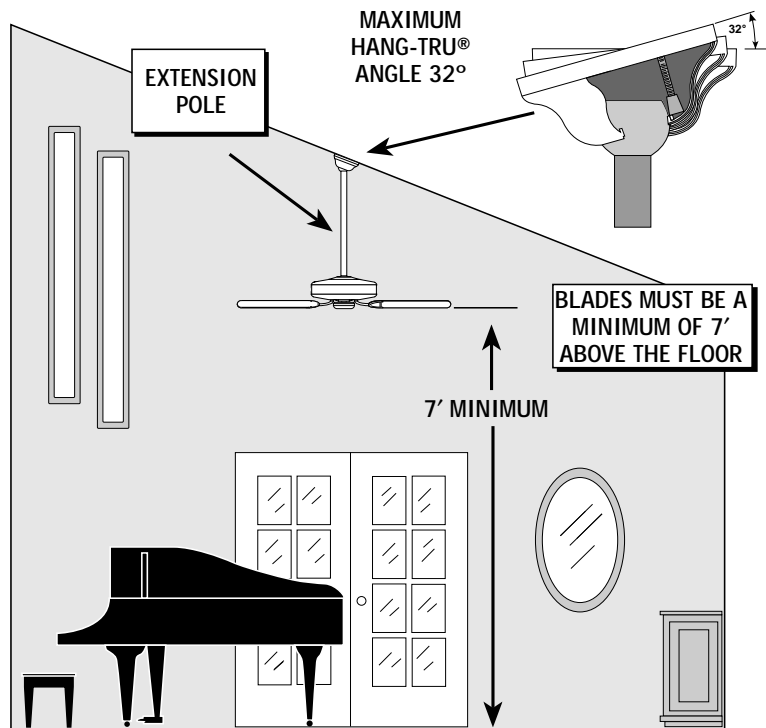

EXAMPLE 1

This slope is less than 32°. It is OK to install your fan.

EXAMPLE 2

This slope is 32°. This is the maximum slope that will allow the fan to hang straight down. It is OK to install your fan.

EXAMPLE 3

This slope is more than 32°. Your fan will not hang straight down, an adaptor is necessary. Contact your local Authorized Casablanca Dealer in regards to purchasing a "Slope Ceiling Adaptor."

Calculation of 32°

Use the tear-off *Ceiling Angle Template* card inserted in the back of this manual, it provides you with a simple 'go' or 'no-go' for installing your fan on a sloped ceiling.

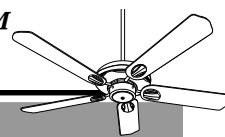

INSTALLATION INSTRUCTIONS

Unpacking: Before assembling and installing your ceiling fan, remove all parts from the shipping cartons and check them against the parts listed here. Before discarding packaging material, be certain that all parts have been removed.

PERMA•LOCK™ HARDWARE



ALLEN SET SCREW
1/4-20 x 1/4"
(PRE-INSTALLED)



3mm
ALLEN WRENCH

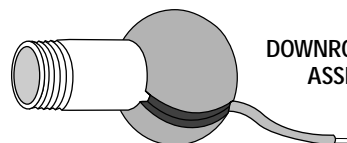

DOWNROD & BALL
ASSEMBLY

FAN PREPARATION

IMPORTANT SAFETY INFORMATION!

BEFORE STARTING THE INSTALLATION OF YOUR CEILING FAN, INSTALL THE THREADED DOWNROD INTO THE MOTOR COUPLING AND LOCK THE ASSEMBLY

Prepare for fan installation as follows:

Step A. Route the wires from the motor through the Perma•Lock™ downrod and ball assembly.

Tip: The downrod has a tapered thread that is designed to lock completely when correctly installed.

Step B. Using the provided allen wrench, loosen the set screw several turns to allow installation of the downrod. Thread the downrod into the motor coupling until it stops turning, this will take at least four and a half full turns.

Step C. Securely tighten the set screw with the provided allen wrench to ensure safe operation of your fan.

CAUTION: Failure to fully lock in the downrod before securely tightening the allen set screw may cause the fan to separate from the downrod during normal operation!

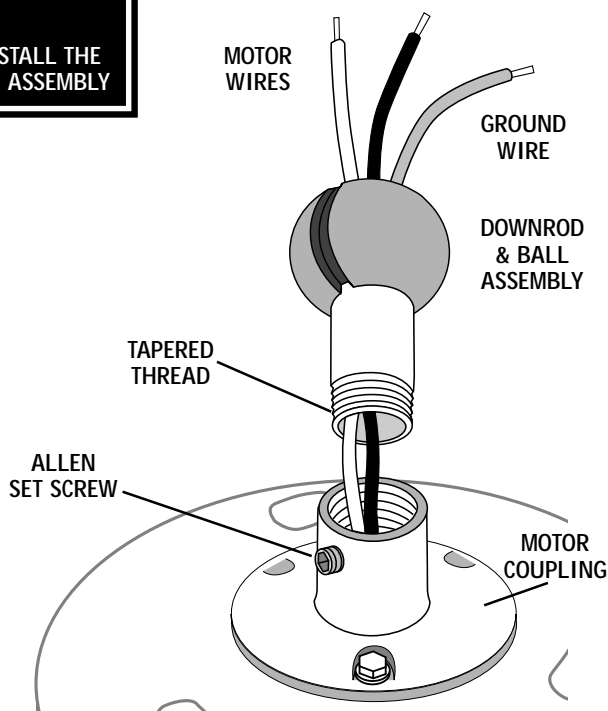

CEILING HARDWARE

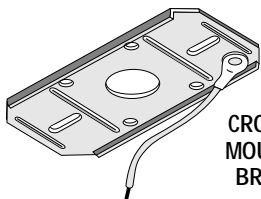

CROSSBAR
MOUNTING
BRACKET



WIRE NUT (4)

ADDITIONAL HARDWARE

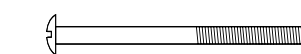

CROSSBAR MOUNTING
BRACKET SCREW 2 1/4" (2)



CROSSBAR MOUNTING
BRACKET SCREW 1" (2)



FLAT WASHER (2)

GETTING STARTED - CONTINUED

Installing a New Ceiling Fixture Outlet Box

If you do not have an existing fixture located where you wish to place your Casablanca fan, an approved ceiling fixture outlet box must be installed and wired.

Warning: To reduce the risk of fire, electrical shock, or personal injury, mount to outlet box marked acceptable for ceiling fan support.

Using Existing Ceiling Fixture Outlet Box

After turning the power OFF at its source (either circuit breaker or fuse box), lower the old fixture and disconnect the wiring. Check the ceiling fixture outlet box to be sure that it is marked 'Approved for ceiling fan mounting'. If it is not, a new box must be installed.

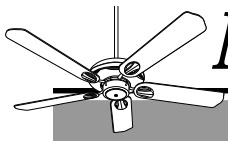

CROSSBAR MOUNTING BRACKET INSTALLATION

Proceed with installation as follows:

Step 1. Route the wires from the ceiling outlet box through the crossbar mounting bracket center hole. Attach the bracket, with ground wire and ridges down, to the 'Approved For Ceiling Fan Installation' ceiling fixture outlet box with the outlet box mounting hardware.

Tighten the screws firmly, being careful not to bend the bracket by over tightening.

CAUTION: To reduce the risk of personal injury, use only the mounting hardware provided with the approved outlet box to install the crossbar mounting bracket.



CEILING FAN APPROVED WIRING BOX

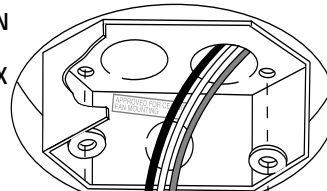

CEILING WIRING

CROSSBAR MOUNTING BRACKET

RIDGE SIDE DOWN

FLAT WASHER

GREEN GROUND WIRE

APPROVED OUTLET BOX HARDWARE

CANOPY HARDWARE

CANOPY HATCH

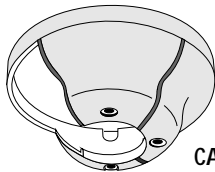

CANOPY

CANOPY SCREW (4)

CANOPY LOCK WASHER (4)

CANOPY INSTALLATION

Step 2. Attach the canopy to the crossbar mounting bracket with three of the 8-32 x 2 1/4" long canopy screws and canopy lock washers. Hand tighten until snug against the ceiling.

Note: On sloped ceilings, align the canopy opening towards the top or room peak.



CROSSBAR MOUNTING BRACKET INSTALLED

CANOPY

CANOPY LOCK WASHERS

CANOPY SCREWS

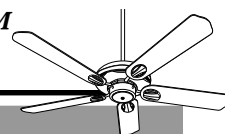

HANGING THE FAN

Step 3. To hang the fan body in the canopy, hold the fan body firmly and insert the nylon ball into the canopy opening. Check that no wires were pinched. Rotate the fan body until the slot in the nylon ball fits into the pin opposite the canopy opening.

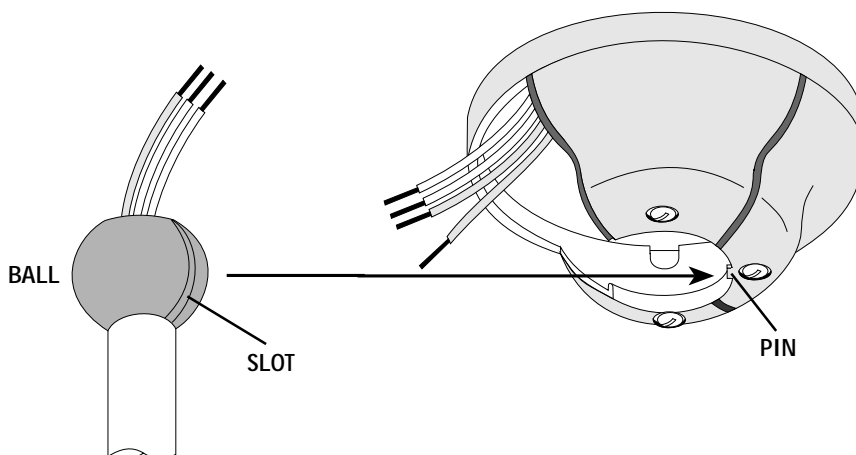

CANOPY ELECTRICAL CONNECTIONS

Step 4. Attach the fan wires to the ceiling fixture outlet box wiring by twisting the bare ends of the wires together and then securing with a wire nut. Test that the connection is secure by pulling on the wire nut. Connect in this order:

Electrical Connections

- GREEN leads from mounting plate and fan to GROUND conductor of power source. Secure with wire nut.
- WHITE wire from fan to white NEUTRAL wire in ceiling fixture outlet box. Secure with wire nut.
- BLACK power wire from fan to BLACK power wire in ceiling outlet box. Secure with wire nut.

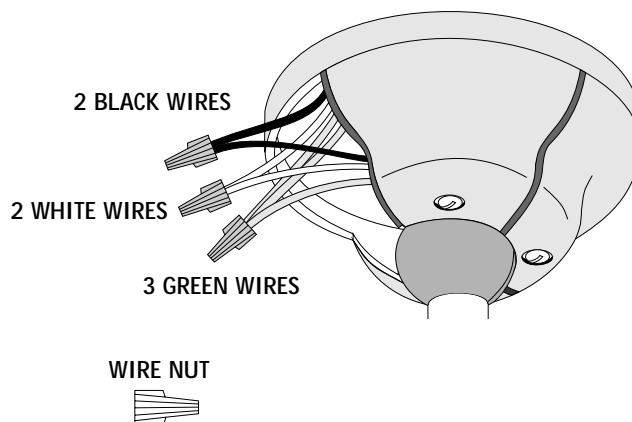

CANOPY HATCH INSTALLATION

Step 5. Tuck the wires into the canopy with the wire nuts pointed upwards, so that the WHITE and BLACK wires are on opposite sides of the canopy and all wires are clear of the canopy opening.

Step 6. Install canopy hatch with the last canopy screw and lock washer. To do this, tilt the fan body away from the hatch opening. Tighten the screws firmly by **hand** only.

Step 7. Straighten the fan, then check to ensure that there is no movement between the canopy and ceiling or Hang-Tru ball and top support shaft.

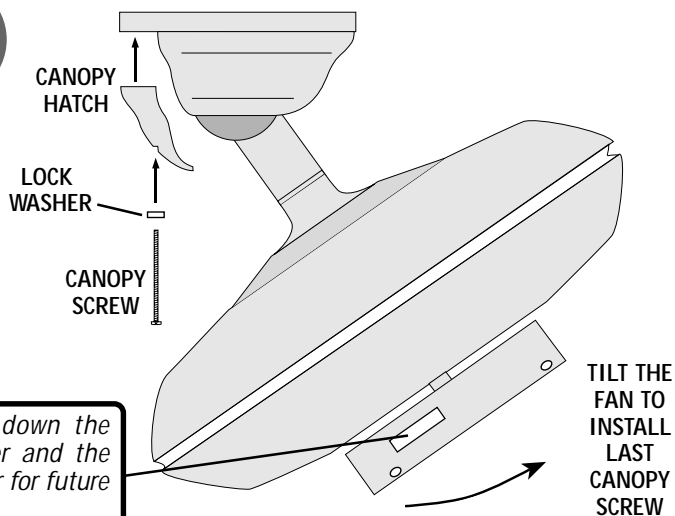

Note: Write down the Serial Number and the model number for future reference.

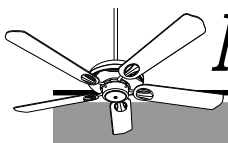

BLADE HOLDERS & HARDWARE

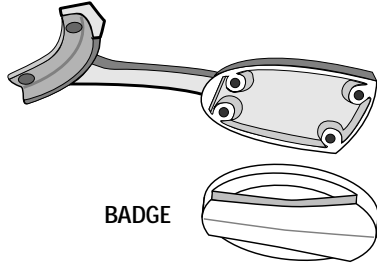

BADGE

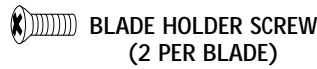

BLADE HOLDER SCREW
(2 PER BLADE)

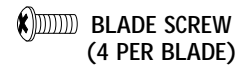

BLADE SCREW
(4 PER BLADE)

ASSEMBLE BLADE HOLDER & BLADE

Step 8. Attach the blades to the blade holders by first pressing the blade badge into the blade, then installing the blade holder using the four blade screws provided for each blade.

Hand tighten securely.

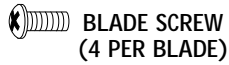

BLADE SCREW
(4 PER BLADE)

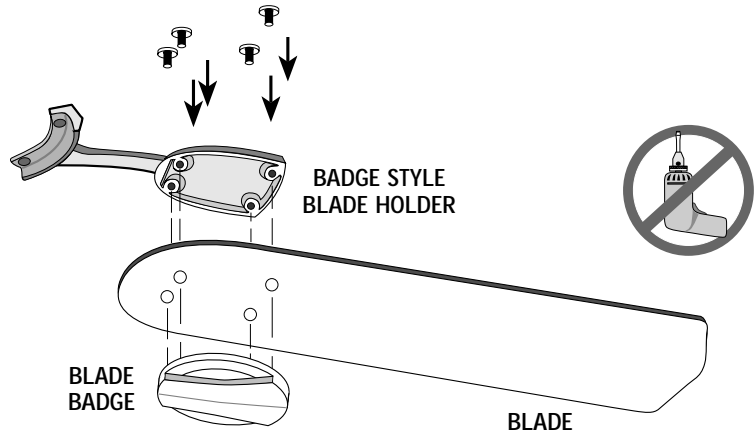

BADGE STYLE
BLADE HOLDER

BLADE
BADGE

BLADE

BLADE/BLADE HOLDER INSTALLATION

Step 9. Rotate the flywheel so that the screw holes can be accessed through the recessed area of the metal plate.

Attach each blade/blade holder assembly to the motor.

Tighten securely by **hand** only.

4/5 Blade Combination Flywheel

Your Casablanca fan includes our 4/5 combination flywheel. This flywheel accommodates your preference to use either 4 or 5 blades on your fan. If you desire a 4-blade fan, locate the square counterbores on the flywheel and use these threaded holes to mount the blades. If you desire a 5-blade fan, locate the round counterbores on the flywheel and use these threaded holes.

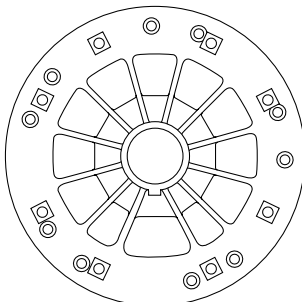

□ = 4-blade mounting hole ○ = 5-blade mounting hole

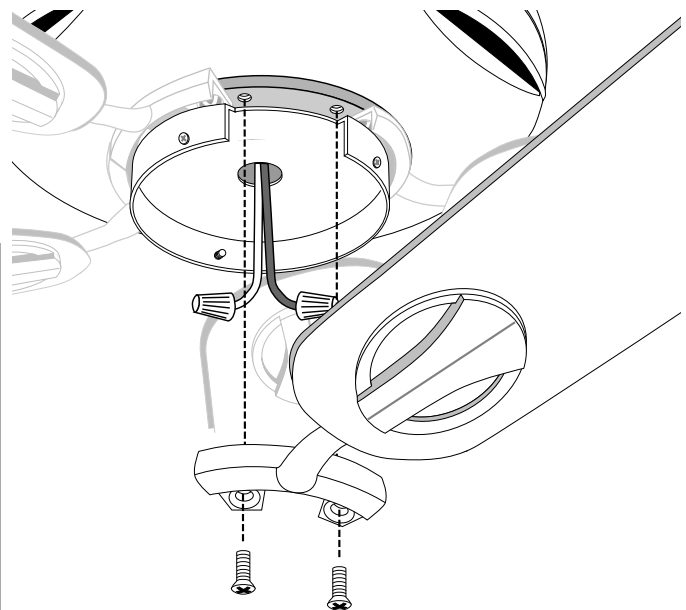

BLADE HOLDER
SCREW
(2 PER BLADE)

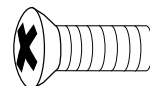

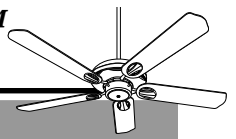

PREPARING TO INSTALL SWITCH HOUSING CAP

Step 10. Remove the three screws on the mounting plate.

Set aside for Step 12.

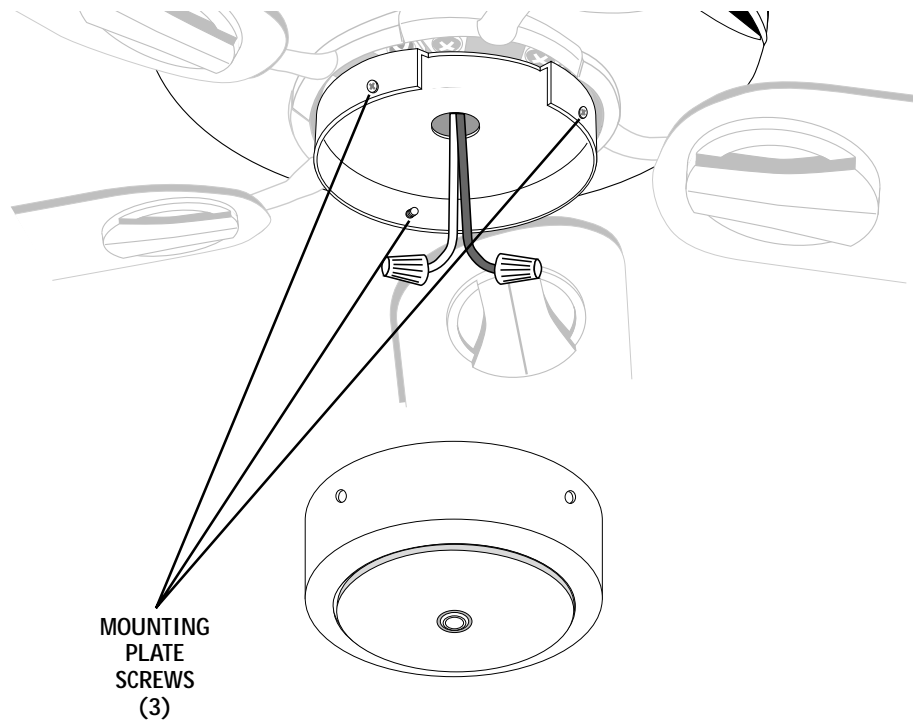

INSTALLING THE SWITCH HOUSING CAP

Step 11. Line up the three threaded holes in the rim of the switch housing with the three clearance holes in the mounting plate. Carefully slide the switch housing into the mount so that the threaded holes are directly behind the clearance holes.



Step 12. Install the three screws removed in Step 10.

Tighten securely by *hand* only.

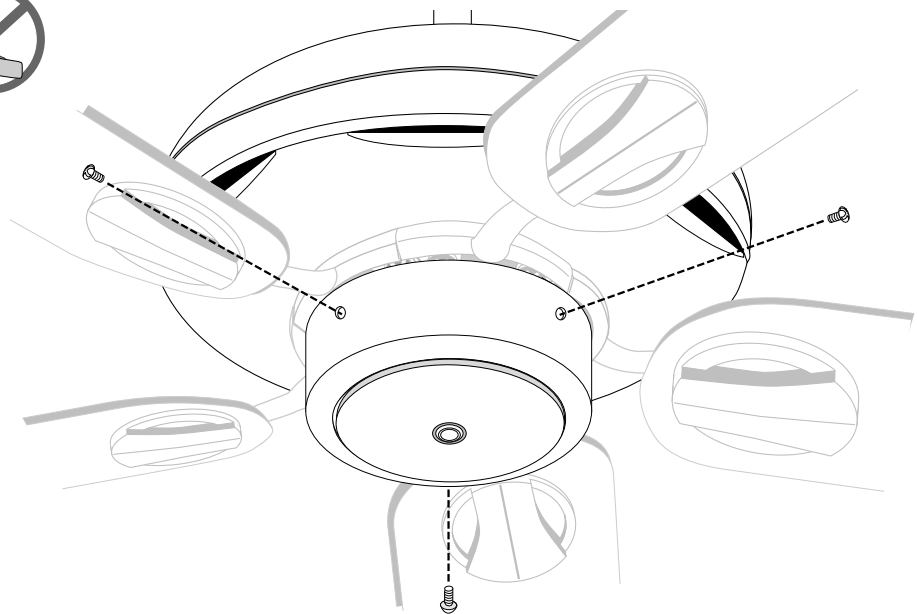

PROCEED TO YOUR FAN'S CONTROL FEATURE SECTION FOR INSTALLATION/OPERATING INSTRUCTIONS:
INTELI•TOUCH = PAGE 8 COMFORT•TOUCH = PAGE 12



INTELI-TOUCH® INSTALLING THE W-32 WALL CONTROL

The wall control installs in the same manner as an ordinary light switch, using an existing junction box and wiring. This controller is designed to signal the fan microcomputer as well as perform normal switching operations. For this reason the following precautions must be observed:

1. Use **only** the Casablanca W-32 wall control.
2. Do not use any additional control with your Intel-Touch fan (for example, dimmer, fan speed control, etc.).
3. Do not use more than **one fan per wall control**.
4. No other light fixtures or electrical appliances may be connected on the circuit controlled by the W-32 wall control.

INTELI-TOUCH ♦ SINGLE W-32 INSTALLATION

CAUTION! Ensure power is turned OFF at the breaker or fuse panel before starting installation.

W-32 is used to describe either white (-11) or ivory finish.

1. Remove the screws and switch plate from the existing switch box.
2. Remove the screws holding the switch in the switch box.
3. Pull the existing switch from the switch box to expose the wire connections.
4. Remove the two wires from the switch.
5. Connect the two wires just removed from the switch to the W-32 wall control black wire and black/white stripe wire. Secure these connections with wire nuts.
6. Install the W-32 in the wall box with the two long screws provided.
7. Install the wall plate with the two color matched screws.

NOTE: If wall control operation is reversed (fan switch controls lights and light switch controls fan) turn off the power at the breaker or fuse panel, then swap the two W-32 black/white stripe wires.

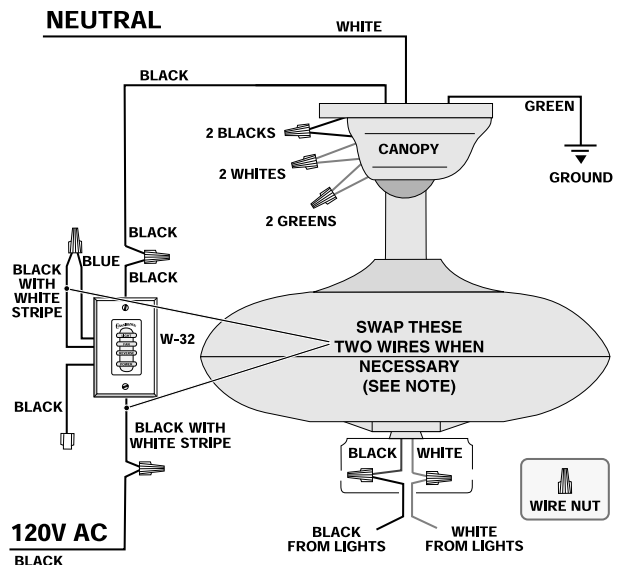

INTELI-TOUCH ♦ DUAL W-32 INSTALLATION

CAUTION! Ensure power is turned OFF at the breaker or fuse panel before starting installation.

To control the fan and lights from two locations (a three-way circuit), use 2 W-32 wall controls.

1. Remove the screws and switch plate from the existing switch box and the screws holding the switch in the switch box.
2. Pull the existing switch from the switch box to expose the wire connections.
3. Determine which wire is connected to the common terminal of the 3-way switch. (The terminal will be marked on switch).
4. Remove the wire from the common terminal of the 3-way switch. Connect this wire to the remaining black/white striped wire on the W-32 control. Secure this splice with a wire nut.
5. Remove the two remaining wires from the 3-way switch. Connect one of these wires to a black wire on the W-32 control. Secure the splice with a wire nut. The remaining wire is to be connected to the other black wire on the W-32. Secure the splice with a wire nut.
6. Install the W-32 in the wall box with the two long screws provided.
7. Install the wall plate with the two short color-matched screws provided.
8. Installation of the second W-32 control is identical. Repeat steps 1 through 7.

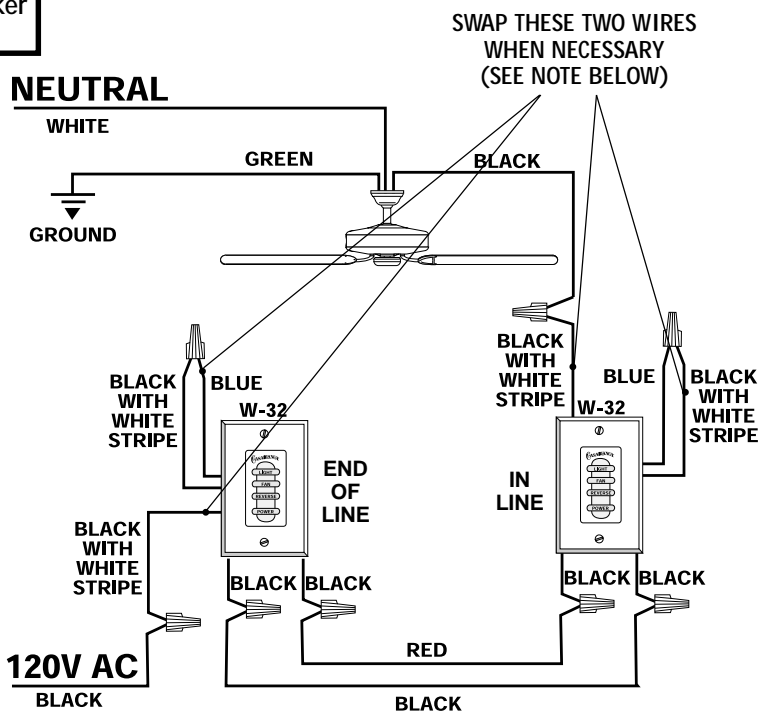

NOTE: If wall control operation is reversed (fan switch controls lights and light switch controls fan) turn off the power at the breaker or fuse panel, then swap the two W-32 black/white stripe wires.

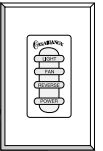

INTELI-TOUCH OPERATION ♦ POWER

The **POWER** button is normally left in the on position. Always turn the power off during cleaning or servicing the fan and during thunderstorms. It is also used to exit or enter additional programs.

POWER must be left on to retain a previously set fan speed or light level.

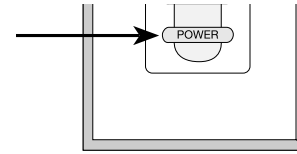

INTELI-TOUCH OPERATION ♦ SPEED CONTROL

There are six individual speed settings for the fan; each speed is indicated by an audible tone of increasing pitch.

To select the desired fan speed:

1. With fan off, press and hold the button labeled **FAN**. The fan blades will start rotating at the slowest speed, and will increase in steps.
2. Release the button when the desired speed is reached.

The fan speed is now in memory and will automatically come on at the same speed each time the **FAN** button is used. To maintain this level of speed, turn the fan on by pressing **FAN** less than one second. To lower speed, turn fan off, then on by pressing and holding the **FAN** button until the desired speed is reached. When the fan is on, you may increase the speed by pressing and holding the **FAN** button until the desired speed is reached, then release it.

FAN CONTROL

ON - OFF:
A momentary press of the **FAN** button

CHANGE SPEED:
Press and hold **FAN** button longer than one second

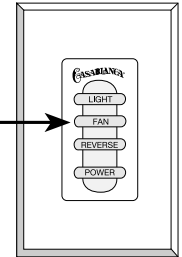

INTELI-TOUCH OPERATION ♦ REVERSING AIRFLOW

The direction of airflow can be changed from downward to upward or from upward to downward.

To reverse the airflow:

1. Make sure the **FAN** is on.
2. Press the **REVERSE** button.

Note: A four-toned signal indicates the command was accepted by the fan. A few seconds later the fan will slow to a stop and then reverse direction.

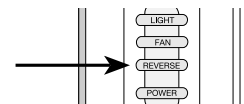

INTELI-TOUCH OPERATION ♦ LIGHT

To turn the lights off and on, press and release the **LIGHT** button for less than one second.

To vary the light brightness:

1. With lights off, press and hold the **LIGHT** button. After one second the lights come on at their lowest level and gradually become brighter.
2. Release the button when the desired brightness level is reached.

The brightness level is now in the fan memory and will automatically come on at the same brightness the next time the **LIGHT** button is used. To maintain this level of brightness, press the **LIGHT** button for less than one second. To lower the brightness, turn the lights off, then press and hold the **LIGHT** button until the desired brightness level is reached. When the light is on, you may increase the brightness level by pressing and holding the **LIGHT** button until the desired level is reached, then release it.

LIGHT CONTROL

ON - OFF:
A momentary press of the **LIGHT** button

CHANGE BRIGHTNESS:
PRESS AND HOLD **LIGHT** BUTTON LONGER THAN ONE SECOND

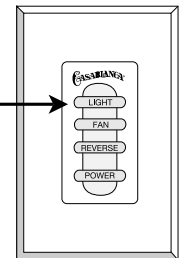

AUTOMATIC DEMONSTRATION PROGRAM

Programmed into every Intelli-Touch Series fan is an Automatic Demonstration Program. It can be used to fully demonstrate and test the operation of the fan.

To enter the demonstration program:

1. Turn **POWER** off for at least three seconds. This will clear the fan memory ready for programming.
2. Turn **POWER** on.
3. Immediately operate the buttons in the following sequence:

FAN - LIGHT - FAN - LIGHT - FAN

A multi-tone signal will verify the start of the test program which proceeds as follows:

- Lights slowly increase to full intensity.
- Fan accelerates to speed three with audio tones.
- Light dims to half intensity.
- Fan accelerates to full speed with audio tones.
- Fan reverses at full speed with audio tones.
- Fan operates at full speed.
- Fan power is reversed with audio tones.
- Fan turns off with audio tones (blades coast for a short time).
- Lights turn off.

The complete cycle lasts slightly over one minute. It will continue to repeat until the **POWER** is turned off for more than three seconds, cancelling the program.

INTELI-TOUCH OPERATION ♦ LIGHT-MINDER® PROGRAM

The Light-Minder program automatically turns OFF the fan mounted lights after two hours.

To enter the Light-Minder Program:

1. Turn the **POWER** OFF for at least three seconds.
2. Turn the **POWER** ON.
3. Immediately operate the buttons in the following sequence:

FAN + **FAN** + **LIGHT** + **LIGHT**

4. A series of tones indicates this command has been accepted. The fan and light will operate normally using the buttons to turn them on and off. But, if the lights are left on, they will automatically shut off after two hours. To cancel the Light-Minder Program, turn the **POWER** off for three seconds.

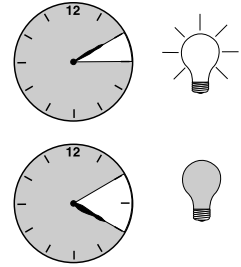

INTELI-TOUCH OPERATION ♦ SAFE-EXIT® PROGRAM

The Safe-Exit Program gives you about thirty seconds of light when you turn the lights off, enabling you to exit your home before the lights go out.

To enter the Safe-Exit Program:

1. Turn the **POWER** off for at least three seconds.
2. Turn the **POWER** on.
3. Immediately operate the buttons in the following sequence:

FAN + **FAN** + **LIGHT** + **LIGHT**

After you hear the confirming audio

tones from the fan - **immediately press** **LIGHT**

4. The lights will blink to indicate this command has been accepted. The lights will stay on for twenty seconds and then begin to dim. After a total of thirty seconds has elapsed, the lights will be off completely. To cancel the Safe-Exit Program, turn the **POWER** off for three seconds.

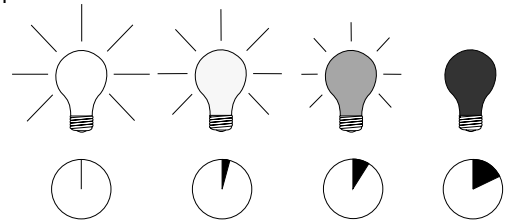

Note: Both Light-Minder and Safe-Exit programs can run at the same time, however the dimmer cannot be used, the light may only be turned ON/OFF.

INTELI-TOUCH OPERATION ♦ HOME-SAFE® PROGRAM

The Home-Safe Program makes an unoccupied home appear occupied by turning the lights on and off at random times.

To enter the Home-Safe Program:

1. Turn the **POWER** off for at least three seconds.
2. Turn the **POWER** on.
3. Immediately operate the buttons in the following sequence:

LIGHT + **FAN** + **LIGHT** + **FAN**

4. A tone and flashing light indicate this command has been accepted. This program overrides all manual control of lights and fan. The lights will now be automatically cycled on and off in a controlled sequence as follows: On 1 hour, off 1/2 hour, on 2 hours, off 1 hour, on 1/2 hour then off 2 hours.

This seven hour pattern will repeat continuously so that a different pattern of lighting is seen each day of the week.

To cancel the Home-Safe Program, turn the **POWER** off for three seconds.



INTELI-TOUCH OPERATION ♦ FAN-MINDER™ PROGRAM

The Fan-Minder feature will add to your comfort when used in the bedroom. The program reduces the speed of the fan each two-hour interval to compensate for the cooling night air.

To enter the Fan-Minder Program:

1. Turn the **POWER** off for at least three seconds.
2. Turn the **POWER** on.
3. Immediately operate the buttons in the following sequence:

LIGHT + **LIGHT** + **FAN** + **FAN**

4. The fan controller will respond with three descending tones. A timer is now initiated and the fan will reduce one speed for each two-hour interval. The fan will not, however, descend below the second lowest speed.

To cancel the Fan-Minder Program, turn the **POWER** off for three seconds. You may increase the fan speed by pressing and holding the **FAN** button until the desired speed is reached, then release it. The fan will again reduce one speed for each 2 hour interval.

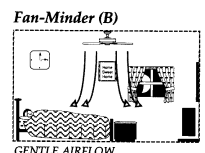
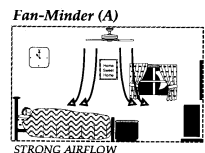

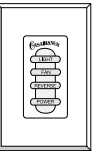

TROUBLESHOOTING

Before Requesting Service: Please follow this troubleshooting guide before contacting your dealer for assistance.

Caring for Finishes: For cleaning, a soft brush or lint-free cloth should be used to prevent scratching the finish. A vacuum cleaner brush nozzle can remove heavier dust. Surface smudges or an accumulation of dirt and dust can easily be removed by using a mild detergent and slightly dampened soft cloth. An antistatic agent may be used, but *never* use abrasive cleaning agents. These will damage the finish. Painted and high-gloss blades may be cleaned in the same manner.

Blades: Wood finish blades should be cleaned with a furniture polishing cloth. Occasionally, a light coat of furniture polish may be applied for added protection and beauty.

Never Lubricate this Fan!

The precision motor at the heart of your Casablanca fan features sealed bearings that are lubricated for life. Do not attempt to oil the motor.

Changing Light Bulbs

Be sure to turn power to the fan OFF at the wall switch or circuit breaker before changing light bulbs. Replace bulbs with same type as removed from the fixture. Each fan is rated for a maximum **TOTAL** wattage of lighting.

Exceeding the rated maximum allowable wattage for the fan will burn out the fan electronics module and void the warranty.

PROBLEM	INTELI•TOUCH	POSSIBLE REMEDIES
NO FAN OR LIGHT		Check main circuit fuses, curcuit breakers, or wall switch position. Check all wire connections, making sure the power is turned off during this inspection.
FAN WOBBLER OR SHAKES EXCESSIVELY		Be sure canopy pin is properly set into the slot on the ball Check the screws holding the blade holders to the fan motor. Tighten as necessary. Check the angle of the blades to make sure that a blade holder has not been bent during installation.
FAN NOISY DURING OPERATION		Check and tighten light fixture retaining screws, glass shade screws and/or the light bulb(s). Tighten canopy screws and mounting plate assembly. Tighten the blade to bladeholder screws and blade holders to flywheel. Make sure all screws in the motor housing are snug, but not overly tight. Check that the wire nuts inside the canopy and switch housing are not touching the metal parts or have fallen off the wire splices. Tighten or adjust as necessary.
BREAK-IN PERIOD		Let fan run at high speed for two (2) hours
DOES NOT RUN ON LOW SPEED		If new, "break-in" may be required - run at higher speed for several days
LIGHTS FLASH OR BLINK DURING OPERATION OF W-32 WALL CONTROLS/FAN MAY ROTATE OR MAKE AUDIBLE TONES DURING OPERATION OF THE W-11 AND W-12 WALL CONTROLS: Normal operation.		
WHEN AC POWER IS TURNED ON FOR THE FIRST TIME, THE LIGHTS OPERATE NORMALLY, BUT W-32 WALL CONTROL OPERATION IS REVERSED: FAN BUTTON OPERATES THE LIGHTS; LIGHT BUTTON OPERATES THE FAN: Reverse the 2 black and white striped wire connections.		
FAN OR LIGHTS APPEAR TO OPERATE BY THEMSELVES (CHANGING SPEED OR INTENSITY), WALL CONTROL OPERATION IS INTERMITTENT: Check AC supply for irregularities, (noise spikes, fluctuations, or failure); or circuit board assembly.		

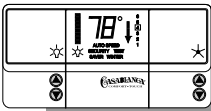

COMFORT•TOUCH®

COMFORT•TOUCH ♦ W-21 MOUNTING PARTS

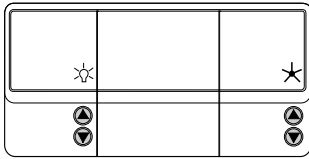

REMOTE CONTROL
W-21

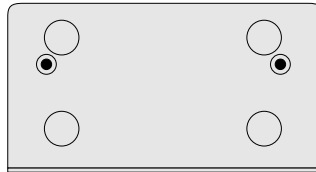

REMOTE CONTROL
WALL BRACKET

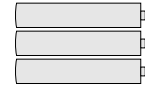

'AAA' ALKALINE
BATTERY (3)



WALL BRACKET
ANCHOR (4)



WALL BRACKET
SCREW (4)

COMFORT•TOUCH ♦ W-21 WALL BRACKET INSTALLATION

Installation of Remote Control

The wall mounting bracket for the remote control should be located in a position that is approximately eye level. Secure the wall mounting bracket with the 1/4" screws or anchors provided, making sure it is level with the floor.

CAUTION! DO NOT MOUNT REMOTE CONTROL ON OR NEAR A METAL SURFACE - ERRATIC OPERATION WILL OCCUR.

Changes or modifications not expressly approved in writing by Casablanca Fan Co. may void the user's authority to operate this equipment.

...

This device complies with RSS-210 of Industry Canada. Operation is subject of the following two conditions: (1) this device may not cause interference, and (2) this device must accept any interference, including interference that may cause undesired operation of the device.

Mount control in convenient location

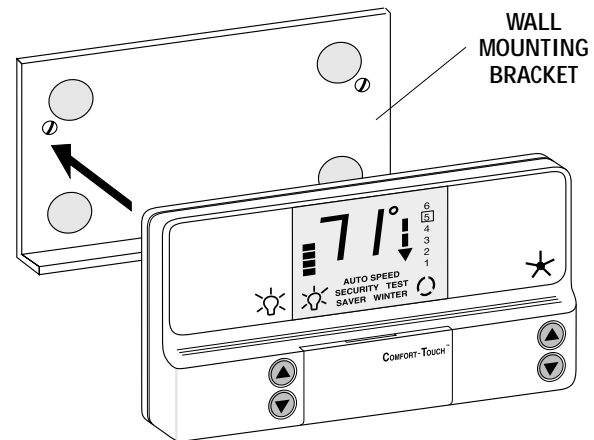

Remove for handheld or tabletop use

COMFORT•TOUCH ♦ W-21 BATTERY INSTALLATION

Battery Installation

Install three 'AAA' alkaline batteries in the sequence shown and replace the battery compartment cover, then press the remote control firmly to the wall bracket so that the Velcro® pads grip the pads on the rear of the control. The remote control can be easily removed at any time should you wish to use it in another location. Just give the control a gentle tug to remove it.

REMEMBER THE REMOTE CONTROL WILL GO BACK TO THE ORIGINAL FACTORY 'PRESET CHANNEL' NUMBER WHEN THE BATTERIES ARE CHANGED. CHANGE CONTROL CHANNEL IF NECESSARY AFTER BATTERY REPLACEMENT.

PRESET CHANNEL #

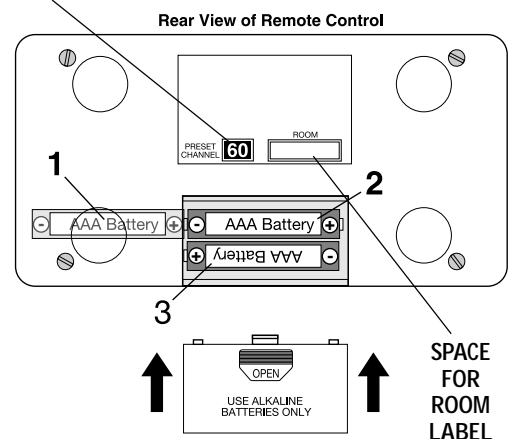

COMFORT•TOUCH ♦ W-21 LOW BATTERY WARNING

Low Battery Indicator

The remote control warns of a low battery condition by displaying a rapidly flashing 'Lo' in place of the temperature display. When this occurs replace with fresh alkaline battery.

WARNING: Use of batteries other than non-leak sealed alkaline in the remote control will void the warranty and can destroy the unit.

Note: When the remote is in the low battery mode the fan may not respond to control commands correctly even though the fan may be running.

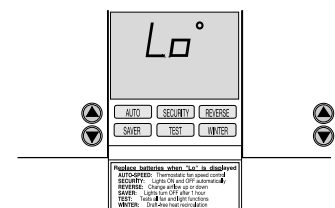

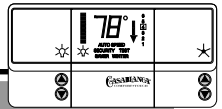

COMFORT•TOUCH ♦ IMPORTANT OPERATING NOTES

Turning On Your Fan

The fan will not receive any signals for the first 20 seconds after power on. This allows the electronics to warm up and stabilize.

Power Failure

The remote control is not affected by household power failure as it is battery operated. Once power is restored to the fan it will receive an auto-update signal from the remote control within 30 minutes after power is restored. All previously set modes and functions will be restored to the fan.

Button Operation

Rapid button pressing causes erratic fan operation.

For reliable operation of the remote control and fan you must wait **ONE SECOND** between button presses to allow the radio signal to be transmitted to the fan and received.

Labeling

If you have more than one Comfort•Touch fan in your home, we suggest you put an adhesive room identification label on the back of the control. Labels are in the remote control package.

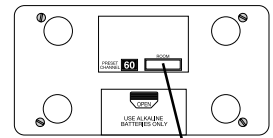

SPACE FOR LABEL

General

Your Comfort•Touch remote control uses one of 15 different radio signals to control the fan. This channel is set at the factory. There may be times when the channel needs to be changed, i.e.:

- Two fans in the house set to the same causing interference.
- Two fans are to be operated from one control.
- Two controls are to operate the same fan - see special 'Dual Remote Control' section on the next page.

COMFORT•TOUCH ♦ TEST PROGRAM

Press the **TEST** button to activate a two minute program that puts the fan through a complete functional test. The test starts with a full screen display, then the 'preset' channel number before going into a full light, fan and reverse exercise. Follow the remote control LCD display and compare it to the actual fan operation to confirm correct operation.

FULL LCD SCREEN DISPLAY

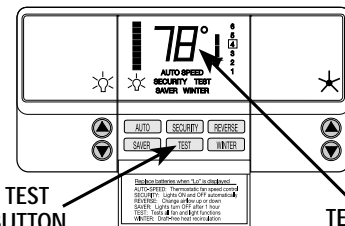

TEST BUTTON

W-21 TEMPERATURE

COMFORT•TOUCH ♦ FAN OPERATION

The Comfort•Touch fan is controlled by the remote control. The fan is turned on and off by alternate pushes of the large right hand button. As with all button operations, an audio tone sounds with each push. With the fan on, the control display will indicate an up or down moving arrow that shows direction and places a box around the operating speed. The two small **▲** and **▼** buttons below the fan button increase or decrease speed once for each press.

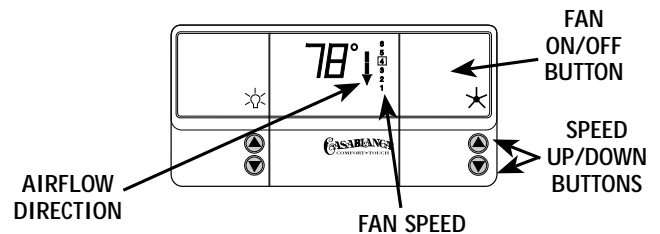

FAN ON/OFF BUTTON

AIRFLOW DIRECTION

FAN SPEED

SPEED UP/DOWN BUTTONS

COMFORT•TOUCH ♦ LIGHT OPERATION

The light is turned on and off by alternate pushes of the large left hand button. When on, the display will indicate the light bulb symbol and a vertical segment display representing brightness. When the light is on, the brightness may be changed by using the small **▲** and **▼** buttons below the light button. Pressing and holding either button will change the brightness continuously.

Bulb-Saver Feature

When the light is turned on, the brightness is gradually increased until it reaches the preset level. This feature helps extend light bulb life.

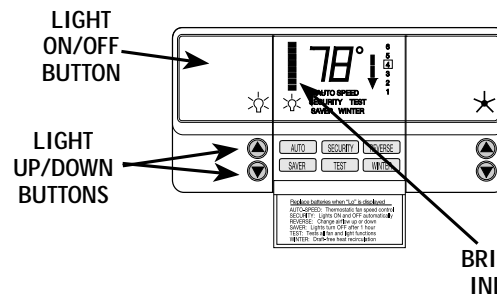

LIGHT ON/OFF BUTTON

LIGHT UP/DOWN BUTTONS

BRIGHTNESS INDICATOR

COMFORT•TOUCH ♦ ADDITIONAL CONTROL FEATURES

Additional control program features are available from the control panel by opening the control panel door. To activate a control function press the appropriate button; the display will indicate that the program is running.

In some cases you can run more than one program at once, such as **SECURITY** and **SAVER** and the display will indicate that they are both activated. In other cases one program will override another as the two programs can not run together i.e. **AUTO** and **WINTER**. Full details are explained in the sections that follow.

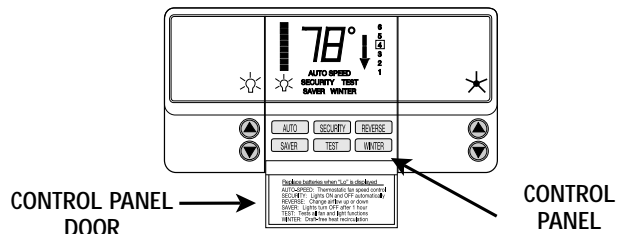

CONTROL PANEL DOOR

CONTROL PANEL

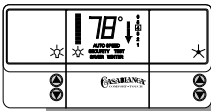

COMFORT TOUCH®

COMFORT TOUCH ♦ REVERSE FEATURE

Pressing the **REVERSE** button will change the direction of rotation. An audio tone signals the beginning of the reverse sequence and you will see the airflow direction arrow changing. The fan gradually slows to a stop, then reverses direction.

Note: This function does not operate if the fan is not running.

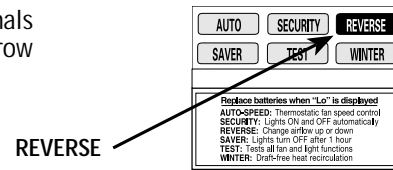

COMFORT TOUCH ♦ AUTO-SPEED FEATURE

In the Auto Speed mode, fan speed changes in response to changes in room temperature. Push the **AUTO** button to start. The words 'AUTO SPEED' show on the display. Set the fan speed to the speed at which you are most comfortable. Once set, the fan will increase or decrease by one speed for each 1.5°F increase or decrease in temperature. If temperature decreases enough to turn the fan OFF, the Auto Speed indicator will flash slowly to remind you that the fan will turn on when the temperature increases.

Note: The temperature displayed is from an electronic thermometer built into the remote control that reads room temperature. It is not a thermostat that controls the room temperature.

To cancel Auto Speed, simply push the **AUTO** button again. Selecting **WINTER** also cancels Auto Speed.

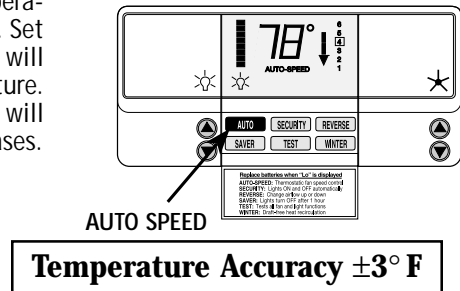

Temperature Accuracy ±3°F

COMFORT TOUCH ♦ SAVER FEATURE

The Saver mode will automatically turn lights off 1 hour after the lights are turned on. Press the **SAVER** button and 'SAVER' will appear in the display. An audio tone will warn you 20 seconds before the program is going to turn the lights off. Press the **SAVER** button again to cancel.

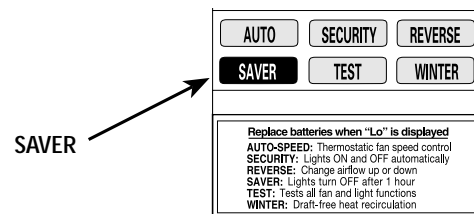

COMFORT TOUCH ♦ WINTER FEATURE

The Winter mode provides draft-free recirculation of heated air. Press **WINTER** to activate, and the word 'WINTER' is indicated. This puts the fan in the upward airflow direction at the fan's lowest speed. Every ten minutes the fan will increase to speed 3 for ten seconds before returning to the lowest speed.

Pressing any button on the remote will cancel the 'Winter' mode; except using the light functions.

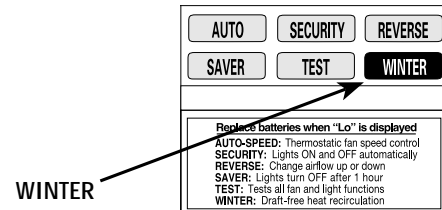

COMFORT TOUCH ♦ SECURITY FEATURE

Pressing the **SECURITY** button will start the Security lighting program. The controller beeps and indicates 'SECURITY'. The light will automatically turn ON and OFF in a seemingly random manner over an eight and a quarter hour programmed cycle that is designed to give the home a "lived-in" look.

Regardless of the light setting when switching to the Security mode (lights on or off, dim or bright), the lights will increase to high brightness and then begin the Security cycle. This cycle is then repeated continuously until cancelled by pressing the **SECURITY** button.

At any time during the Security mode you may adjust the fan speed, reverse the direction, operate in Auto Speed or Winter, use Saver or run the Test mode without affecting Security mode.

You may still turn the light ON and OFF (or OFF and ON) manually for temporary lighting, but the light will continue to operate automatically at its programmed times.

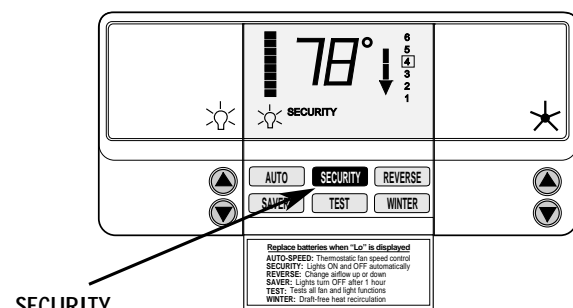

SECURITY MODE CYCLE

1. On for 30 minutes (80% bright)
2. Off for 30 minutes
3. On for 120 minutes (50% bright)
4. Off for 60 minutes
5. On for 60 minutes (100% bright)
6. Off for 120 minutes
7. On for 15 minutes (20% bright)
8. Off for 60 minutes



COMFORT•TOUCH ♦ CHANGING CHANNELS - CONTROL

Changing the control channel

1. Hold the **TEST** button down until a tone is heard.
2. The temperature display will show the current channel number.
3. Press fan up or down buttons to change the number to a unique number from 49 to 63.

DO NOT use other channel numbers.

4. Push **TEST** to return to normal operation.

You will need to repeat this step any time you remove the remote control batteries. Record the new channel setting in the space provided on the rear label.

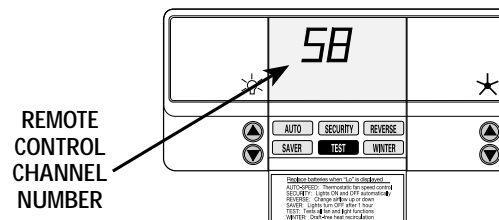

Note: Always change the remote control channel first. The fan channel can only be changed by having the desired channel already set in the remote control.

COMFORT•TOUCH ♦ CHANGING CHANNELS - FAN

1. Turn OFF power to the fan for five seconds or longer using the wall switch or circuit breaker.
2. Turn the power back ON.

WAIT 20 SECONDS.

You have 90 seconds in which to complete step 3.

3. Press and hold the **TEST** and **AUTO** buttons together until the display shows 'cc' (for Change Channel), then release.

The control automatically changes the fan channel to the new setting.

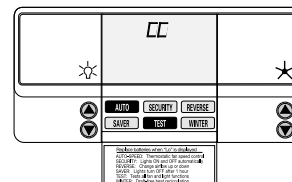

Do not reset the channel on other fans in your home during this 110 second period.

COMFORT•TOUCH ♦ DUAL REMOTE CONTROL - BASE

A second remote control can be purchased from your dealer to provide dual remote control of one fan. Because the fan could be confused by two controllers signaling different information it is necessary to set a **BASE** control and an **AUXILIARY** control.

The last control manually operated controls the fan.

Where two remote controls are used to control a single fan, they *must* be set so that:

- **BOTH** controls are set to the **SAME** channel.
 - **ONE** control is made into the **BASE** control.
 - The **OTHER** control is made an **AUXILIARY** control.
- (All remote controls leave the factory as a **BASE**).

Initial remote control settings

1. Set *both* the controls to operate the fan.
2. Select *one* of the remote controls to be the **BASE** unit.

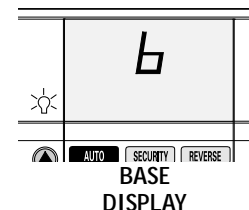

BASE Check

To confirm that the control is the **BASE**:

1. Press **AUTO** for 3 seconds until a beep is heard.
2. Confirm temperature display shows 'b'.
3. Press **AUTO** again to set.

COMFORT•TOUCH ♦ DUAL REMOTE CONTROL - AUXILIARY

Change the other remote to be used in the room to **AUXILIARY**

1. Press **AUTO** until a beep is heard. Remote displays 'b'.
2. Press fan up or down buttons to change the display to 'A'.
3. Press **AUTO** again to set.

The fan will now respond to either of the remotes when pressed.

- **Reminder!** These steps will have to be repeated whenever the batteries are changed.
- When **AUTO-SPEED**, **SECURITY**, **SAVER** or **TEST** modes are in effect at any control: Automatic control will only be from the control that was last operated manually.

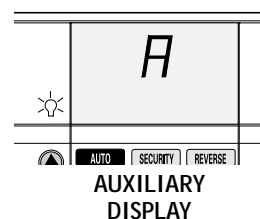

TWO CONTROLS OPERATING ONE FAN

When two controls are used for the same fan, we suggest that both controls be set for the same features (AUTO-SPEED, SAVER, etc.) so that performance remains the same as you move from one to the other. Remember, the fan will only respond to updates from the control that was last operated manually.

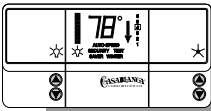

TROUBLESHOOTING

Before Requesting Service: Please follow this troubleshooting guide before contacting your dealer for assistance.

Caring for Finishes: For cleaning, a soft brush or lint-free cloth should be used to prevent scratching the finish. A vacuum cleaner brush nozzle can remove heavier dust. Surface smudges or an accumulation of dirt and dust can easily be removed by using a mild detergent and slightly dampened soft cloth. An antistatic agent may be used, but *never* use abrasive cleaning agents. These will damage the finish. Painted and high-gloss blades may be cleaned in the same manner.

Blades: Wood finish blades should be cleaned with a furniture polishing cloth. Occasionally, a light coat of furniture polish may be applied for added protection and beauty.

Never Lubricate this Fan!

The precision motor at the heart of your Casablanca fan features sealed bearings that are lubricated for life. Do not attempt to oil the motor.

Changing Light Bulbs

Be sure to turn power to the fan OFF at the wall switch or circuit breaker before changing light bulbs. Replace bulbs with same type as removed from the fixture. Each fan is rated for a maximum **TOTAL** wattage of lighting.

Exceeding the rated maximum allowable wattage for the fan will burn out the fan electronics module and void the warranty.

PROBLEM	COMFORT•TOUCH	POSSIBLE REMEDIES
FAN O.K., NO LIGHT		Check for burned-out light bulb. Check fan light wires.
REMOTE CONTROL OF FAN IS ERRATIC		Check batteries installed correctly. Install fresh ALKALINE batteries.
SELECTING WINTER MODE CANCELS AUTO-SPEED		Normal.
CHANGING SPEED OR DIRECTION CANCELS WINTER		Normal.
FAN APPEARS TO RESPOND TO UNKNOWN SIGNAL		Change channel of control and fan to a number between 49 and 63.
CONTROL ALSO OPERATES A SECOND FAN IN HOME		Change channel on control and fan.
TEMPERATURE DISPLAY DOES NOT CHANGE QUICKLY		Normal. Updates only every 2 minutes.
FAN WOBBLER OR SHAKES EXCESSIVELY		Make sure hanging ball slot is properly aligned. Tighten canopy and mounting crossbar screws. Tighten all blade screws. Blades must be balanced (contact your dealer).
FAN NOISY DURING OPERATION		Tighten glassware and light bulbs. Tighten motor housing screws. Tighten canopy and mounting crossbar screws.
DOES NOT RUN ON LOW SPEED		If new, "break-in" may be required - run at higher speed for several days.
BATTERY LIFE SEEMS SHORT		Not using Alkaline batteries: Replace with Alkaline batteries.
TEMPERATURE READINGS		Temperature accuracy = $\pm 3^{\circ}\text{F}$
FAN DOES NOT RESPOND TO REMOTE CONTROL:		Power to fan is off; wrong remote being used; remote channel changed; fan receive SET channel changed; or fan antenna not receiving. See above; in locations with two or more fans in different rooms check that controllers are in right rooms; change SET channel to match fan; change fan SET channel to match remote; check antenna connected to RCM; check antenna positioned correctly; if batteries weak by moving remote close to fan; check that remote not laying on metal surface causing weak signal; or connect Earth ground to fan.
FAN APPEARS TO RESPOND TO UNKNOWN SIGNAL OR IS ERRATIC:		Invalid lower channel SET; 2nd remote in area SET to same channel; or remote buttons pressed too quickly Be sure SET channel is between 49 and 63; check SET channels of any other remotes at site (check if nearby homes have Comfort Touch fans installed- remote signal can travel 50 ft.); and for proper operation of the control you must wait "one second" between presses.
AFTER POWER FAILURE, FAN AND LIGHTS ARE OFF:		Normal: To immediately restore fan to its original settings press any button. Fan will reset itself within about 30 minutes after power is restored when remote sends normal update message to fan.
WHEN AC POWER IS TURNED ON, LIGHT COMES ON OR FAN TURNS:		Remote control defective; remote buttons pressed too soon; AC electricity irregularities (noise spikes, fluctuations, or failure). Turn off with remote and restart; replace remote control unit; or wait twenty seconds for electronics warm-up; check AC electricity for irregularities (defective light dimmers, noise spikes, voltage changes caused by appliances, motors, supply brown outs or interruptions, or storms, etc).

761 CORPORATE CENTER DRIVE • POMONA, CA 91768
TOLL FREE: 888-CASA-1ST (227-2178)

www.CasablancaFanCo.com

©COPYRIGHT 2000 CASABLANCA FAN COMPANY • U.S. PATENT PENDING

PRINTED IN ROC

Free Manuals Download Website

<http://myh66.com>

<http://usermanuals.us>

<http://www.somanuals.com>

<http://www.4manuals.cc>

<http://www.manual-lib.com>

<http://www.404manual.com>

<http://www.luxmanual.com>

<http://aubethermostatmanual.com>

Golf course search by state

<http://golfingnear.com>

Email search by domain

<http://emailbydomain.com>

Auto manuals search

<http://auto.somanuals.com>

TV manuals search

<http://tv.somanuals.com>