

# CONTENTS

INTRODUCTION .....	1
MOUNTING RECOMMENDATIONS .....	2
FAN INSTALLATION - GETTING STARTED .....	3
CONTROL FEATURES:	
4-SPEED .....	7
INTELI•TOUCH .....	9
TROUBLE SHOOTING .....	10
ADVAN•TOUCH .....	13
TROUBLE SHOOTING .....	16

**READ AND SAVE THESE INSTRUCTIONS**

## SAFETY FIRST

Safety and the proper operation of your Casablanca fan both require a thorough knowledge of the product and proper installation; therefore, before attempting to install and operate your Casablanca fan, read this owner's manual completely and carefully. Retain this manual for future reference.

**CAUTION:** To avoid possible electrical shock, make certain that electricity is turned off at the circuit breaker or fuse box before attempting any installation procedure.

## BEFORE YOU START

- **CAUTION: RISK OF ELECTRICAL SHOCK!** All wiring must be performed in accordance with national and local electrical codes. If you are unfamiliar with the wiring codes, you should use a qualified electrician. To avoid overheating and possible damage to other equipment, do not install control to a receptacle, fluorescent light fixture, motor operated appliance, or transformer-supplied appliance.
- This fan is designed to be installed on an existing electrical outlet box. The outlet box must be UL Listed for ceiling fan installations, if it is not, a new box must be installed. Casablanca extension poles are available for sloped or high ceiling installations.
- This ceiling fan requires a grounded electrical supply of 120 VAC, 60 Hz and a minimum 15 amp circuit. The maximum current requirement for the fan with light fixture is 3.8 amps. The fan uses about 1 amp or 100 watts. Maximum light current is 2.8 amps or 340 watts of lighting.
- Where wire nuts are employed, be sure all bare wires are within the connectors. When installing the canopy hatch, make sure all wires are within the canopy and that no wires are being pinched.

For best performance and for your warranty to be valid, use only genuine Casablanca blades, light fixtures, and accessories.

## NOTES

- The blades in each pack are matched for equal weight to assure smooth fan operation. If more than one fan is being installed, be careful not to mix blades from different cartons.
- Inspect the contents of your carton for possible shipping or handling damage and report any such damage directly to your authorized Casablanca dealer.
- It is always a good idea to have an assistant to help with the installation.
- When cleaning, painting, or working near your fan, be very careful of the fan and blades. Always turn the power OFF to the ceiling fan before servicing it, working on it, or replacing light bulbs.
- Never insert anything into the path of the fan blades while the fan is in operation.
- Never install a fan over a pool or spa.
- Never operate a fan that has been damaged in any way. Contact Casablanca Fan Company by calling 1-888-227-2178, or contact your local authorized Casablanca dealer for assistance in obtaining service.

**FUSE BOX  
(REMOVE FUSE FOR THE  
CIRCUIT YOU WILL BE  
WORKING ON)**

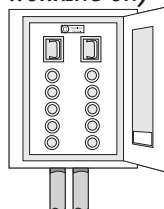

**CIRCUIT BREAKER  
(TRIP BREAKER FOR THE  
CIRCUIT YOU WILL BE  
WORKING ON)**

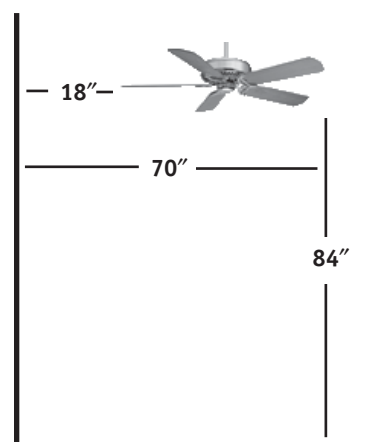
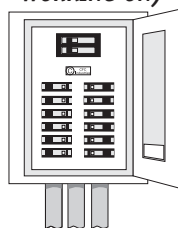

## MOUNTING RECOMMENDATIONS

Before mounting your Casablanca fan, read the following helpful recommendations. The location of the fan, air circulation, and fan size are all important factors to consider before installation.

### Location

Ceiling fans have practical uses in almost every room in your home. We suggest you follow these mounting recommendations as you decide where to install your Casablanca fan.

- For safety reasons, the fan blades must be a minimum of 7' above the floor.
- Do not locate the fan in a doorway or above a swinging door.
- In bedrooms, fans work best when mounted above the foot of the bed.
- Over pool tables, be sure to provide plenty of clearance to avoid damage from pool cues.
- In kitchens be sure to allow for open cupboard doors to clear the fan blades.
- Do not install a fan close to or over a pool or spa. High humidity combined with corrosive gases will destroy the finish and warp the blades.

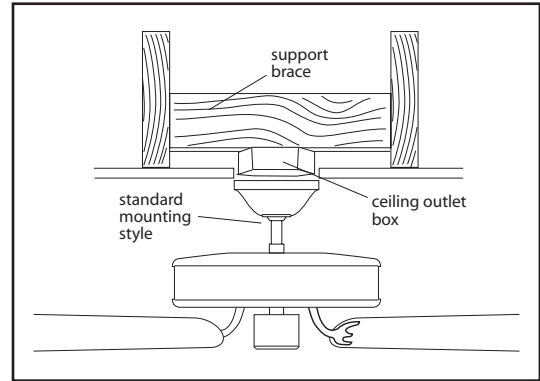

### Fan Size

Variable fan speed capability permits the use of a full-size 52" fan even in smaller rooms. For very large rooms, two fans may be needed.

## SLOPED CEILING INSTALLATIONS

### SUGGESTED EXTENSION POLE LENGTHS

Ceiling Height	Pole Length
8' 0"	standard
8' 6"	standard
9' 0"	6"
9' 6"	12"
10' 0"	12"
11' 0"	18"
12' 0"	24"
13' 0"	36"
14' 0"	48"

### When to Use Extension Poles

For optimum performance and appearance, an extension pole should be used with your Casablanca fan when installing on high (cathedral) ceilings or sloped ceilings. Casablanca offers standard poles in increments of 6" up to 5'. Custom poles are available in lengths up to 9'9". See your Authorized Casablanca Dealer for details.

**NOTE:** Fan may wobble or vibrate if pole length is not long enough and inside blade is too close to downslope or side wall. Extending pole length will usually solve problem.

### Calculation of Ceiling Angle

Use the tear-off *Ceiling Angle Template* card inserted in this manual. It provides you with a simple "go" or "no-go" for installing your fan on a sloped ceiling.

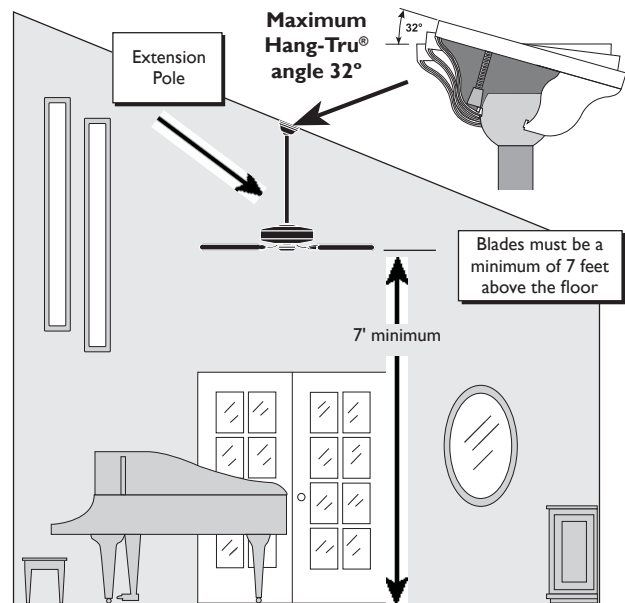

This slope is less than 32°. It is OK to install your fan.



This slope is 32°. This is the maximum slope that will allow the fan to hang straight down. It is OK to install your fan.



This slope is more than 32°. Your fan will not hang straight down, an adaptor is necessary. Contact your local Authorized Casablanca Dealer in regards to purchasing a "Sloped Ceiling Adaptor."



## FAN INSTALLATION GETTING STARTED

### Installing a New Ceiling Fixture Outlet Box

If you do not have an existing fixture located where you wish to place your Casablanca fan, an approved ceiling fixture outlet box must be installed and wired.

#### WARNING!

To reduce the risk of fire, electrical shock, or personal injury, mount to outlet box marked "Acceptable Fan Support of 22.7 kg (50 lbs.) or less" using the mounting hardware provided with the outlet box.

### Using Existing Ceiling Fixture Outlet Box

After turning the power OFF at its source (either the circuit breaker or fuse box), lower the old fixture and disconnect the wiring. Check the ceiling fixture outlet box to be sure it is marked "Approved for Ceiling Fan Mounting." If it is not, a new box must be installed.

Note: The weight of this fan is 24 to 26 pounds, depending on model.

## CROSSBAR MOUNTING BRACKET INSTALLATION

### CEILING HARDWARE (not to scale)



Note: After removing the old fixture, check the outlet box to insure that it is supported by a joist or beam across its upper surface. If not, a 2 x4 stud must be installed.

**Step 1a.** Remove the knockout plug in the center of the outlet box or drill a 1/2-inch hole for the lag screw to pass through. Then drill a 1/4-inch guide hole into the joist or beam to a depth of 3 inches.

**Step 1b.** Route the outlet box wires through the keyhole slot of the crossbar mounting bracket as shown. Attach the crossbar mounting bracket to the outlet box with the screws provided, making sure the outlet box wires are not pinched by the washer.

#### CAUTION:

To reduce the risk of personal injury, use only the mounting hardware provided with the approved outlet box to install the crossbar mounting bracket.

#### WARNING!

Support directly to building structure only.

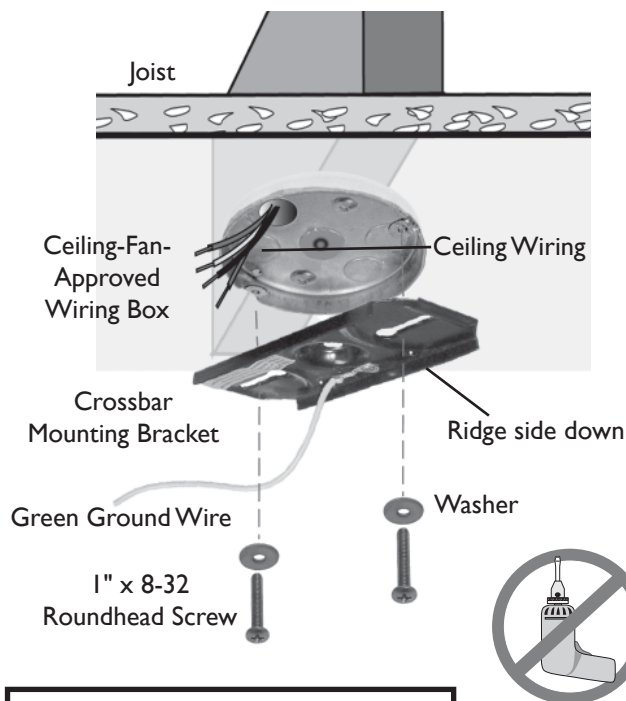

**WARNING:** Damp Location rated fans require a Ground Fault Interrupter (GFI). use a weather-proof outlet box, properly connect ground wires, and use only under a weather-proof structure.

## LAG SCREW INSTALLATION (OPTIONAL)

**NOTE:** This step is required only under two conditions: If the fan weighs 36 lbs. or more (which does not pertain to this fan) or if the existing ceiling fixture outlet box needs to be modified for a ceiling fan application (for example, if the house is not new construction and you are replacing an existing light fixture). We recommend that the ceiling box be of sufficient capacity to support the weight of the fan and light fixture under any conditions. If in doubt whether you need to install the lag screw, consult a qualified electrician.

Step 2 (optional). With the large washer attached, pass the lag screw (Pack A) through the center hole of the crossbar mounting bracket and screw into the guidehole. Tighten until the outlet box is mounted firmly to the beam. This box must be secured to the ceiling firmly.

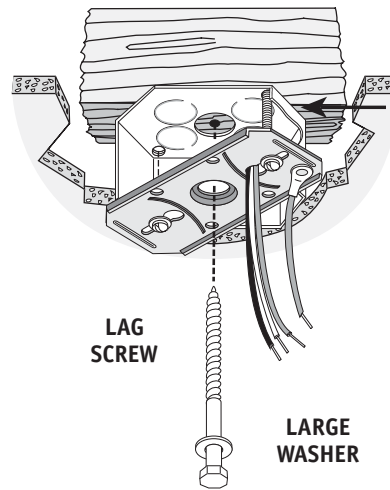

## PERMA•LOCK™ HARDWARE



**ALLEN SET SCREW**  
1/4"-20 x 1/4"  
(PRE-INSTALLED)



**3mm ALLEN WRENCH**

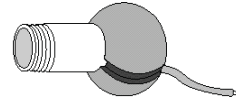

**DOWNROD & BALL ASSEMBLY**

## FAN PREPARATION

### IMPORTANT SAFETY INFORMATION!

BEFORE STARTING THE INSTALLATION OF YOUR CEILING FAN, INSTALL THE THREADED DOWNROD INTO THE MOTOR COUPLING AND LOCK THE ASSEMBLY

Prepare for fan installation as follows:

**3a.** Route the wires from the motor through the Perma•Lock™ downrod and ball assembly.

**Tip:** The downrod has a tapered thread that is designed to lock completely when correctly installed.

**3b.** Using the provided allen wrench, loosen the set screw several turns to allow installation of the downrod. Thread the downrod into the motor coupling until it stops turning, this will take at least four and a half full turns.

**3c.** Securely tighten the set screw with the provided allen wrench to ensure safe operation of your fan.

**CAUTION:** Failure to fully lock in the downrod before securely tightening the set screw may cause the fan to separate from the downrod during normal operation!

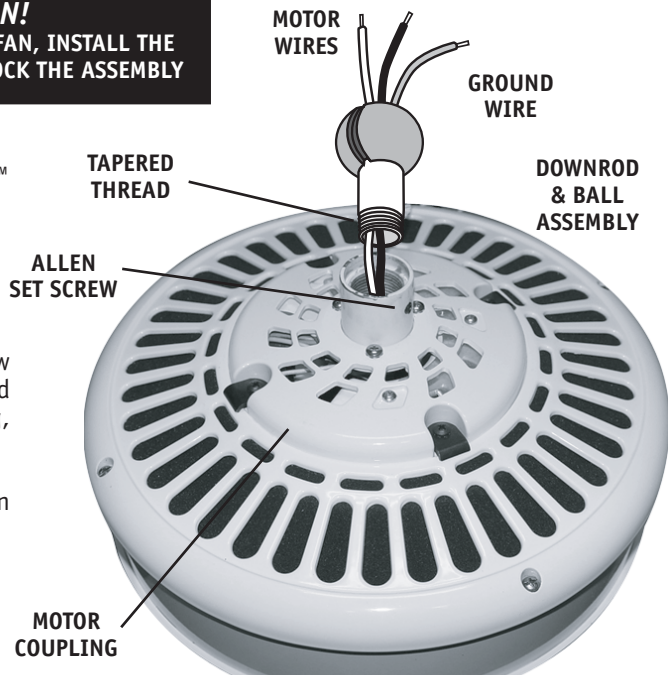



## CANOPY HARDWARE



## CANOPY INSTALLATION

**Step 4.** Attach the canopy to the crossbar mounting bracket with three of the 8-32 x 2 1/2" long canopy screws and lock washers provided with your Casablanca fan. Hand tighten until snug against the ceiling.

**Note:** On sloped ceilings, align the canopy opening toward the top or peak of the room.

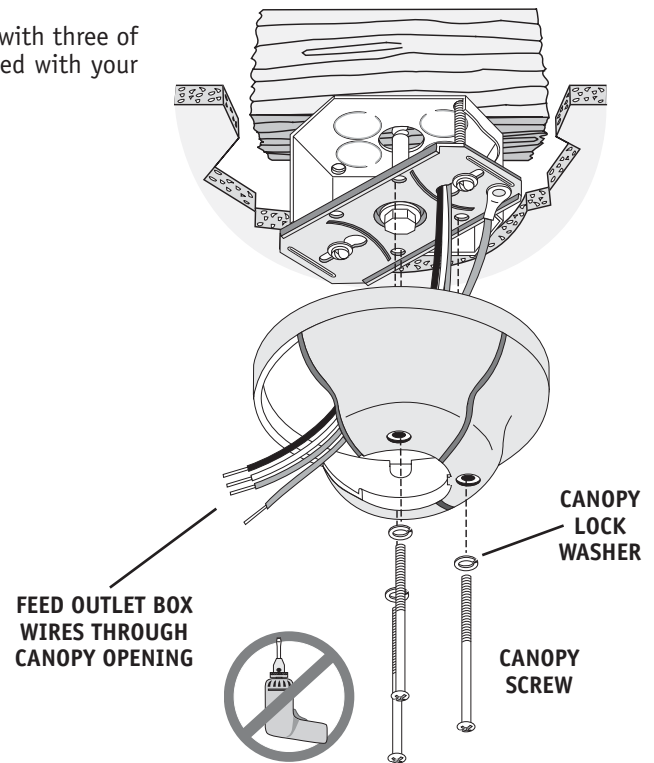

## HANGING THE FAN

**Step 5.** To hang the fan body in the canopy, hold the fan body firmly and insert the ball into the canopy opening. Check that no wires were pinched. Rotate the fan body until the slot in the nylon ball fits into the pin opposite the canopy opening.

**NOTE:** Independent control of the light fixture using a W-81 requires an additional power wire run from the wall switch to the fan. See Page 8 for wiring.

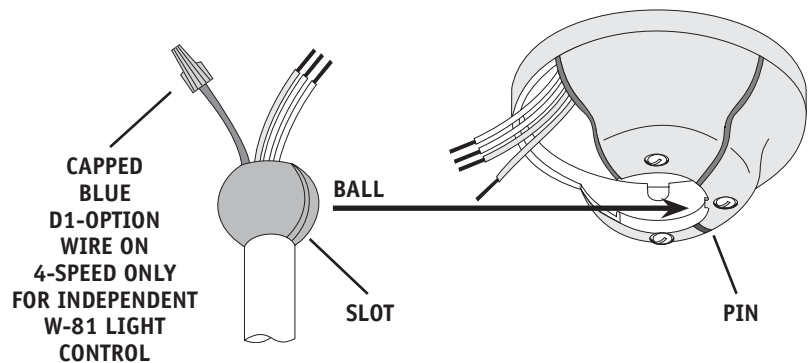

## CANOPY ELECTRICAL CONNECTIONS

**Step 6a.** Attach the fan wires to the ceiling fixture outlet box wiring by twisting the bare ends of the wires together and then securing with a wire nut. Test that the connection is secure by pulling on the wire nut. Connect in this order:

**Step 6b. Pull Chain or W-41 Wiring Connections**

- GREEN leads from mounting plate and fan to GROUND conductor of power source. Secure with wire nut.
- WHITE wire from fan to white NEUTRAL wire in ceiling fixture outlet box. Secure with wire nut.
- BLUE wire and BLACK power wire from fan to BLACK power wire in ceiling outlet box. Secure with wire nut.

**Step 6c. W-81 Wiring Connections**

- GREEN leads from mounting plate and fan to GROUND conductor of power source. Secure with wire nut.
- WHITE wire from fan to white NEUTRAL wire in ceiling fixture outlet box. Secure with wire nut.
- BLACK power wire from fan to RED wire from W-81 in ceiling outlet box. Secure with wire nut.
- BLUE wire from fan to YELLOW wire from W-81 in ceiling outlet box. Secure with wire nut.

**NOTE:** See Page 8 for additional wiring information.

**WIRE NUT**

**PULL CHAIN OR W-41 CONNECTIONS**

2 BLACK & BLUE D1-OPTION WIRES (WITHOUT W-81)  
2 WHITE WIRES  
3 GREEN WIRES

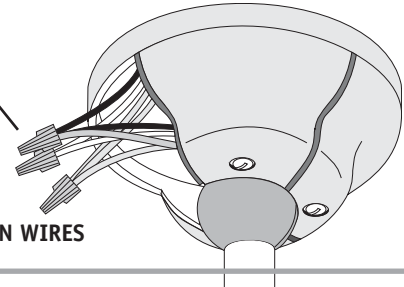

**W-81 CONNECTIONS**

BLUE & YELLOW WIRES  
BLACK & RED WIRES  
2 WHITE WIRES  
3 GREEN WIRES

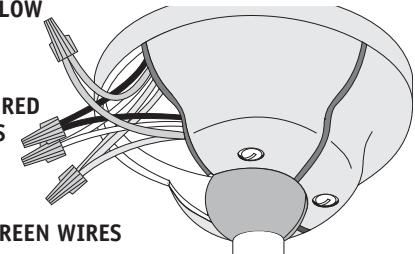

## CANOPY HATCH INSTALLATION

**Step 7.** Tuck the wires into the canopy with the wire nuts pointed upwards, so that the WHITE and BLACK wires are on opposite sides of the canopy and all wires are clear of the canopy opening.

**Step 8.** Install canopy hatch with the last canopy screw and lock washer. To do this, tilt the fan body away from the hatch opening. Tighten the screws firmly by *hand* only.

**Step 9.** Straighten the fan, then check to ensure that there is no movement between the canopy and ceiling or Hang-Tru ball and top support shaft.

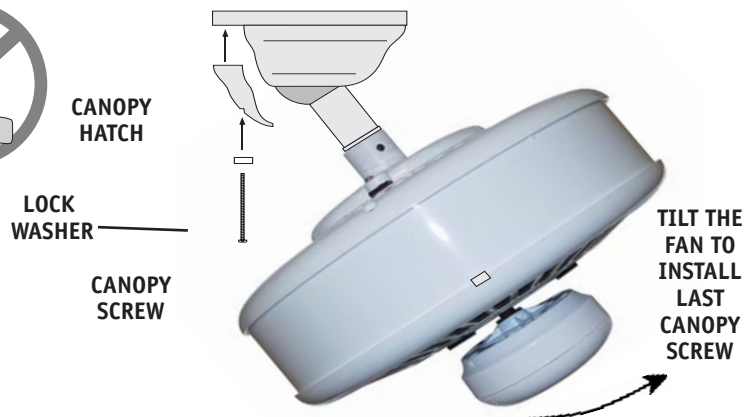

## BLADE HOLDER & BLADE ASSEMBLY

**Step 10.**

Attach the blades to the blade holders with the three blade screws and felt washers provided for each blade. *Hand* tighten securely.

Install the assembled blade and blade holder to the motor. *Hand* tighten securely.

Repeat for each assembly.

BLADE HOLDER SCREW (2 PER BLADE HOLDER)

BLADE SCREW (3 PER BLADE)

FELT WASHER (3 PER BLADE)

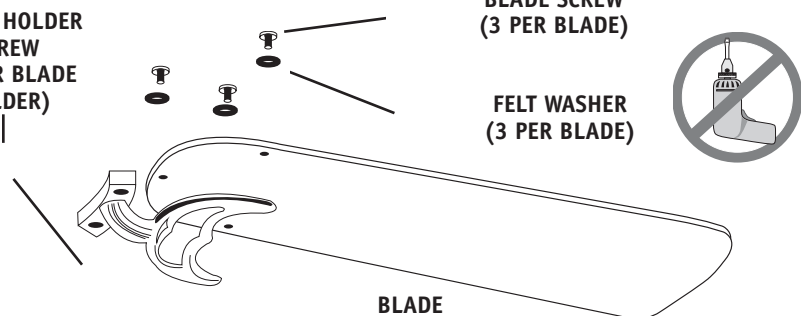

**WARNING:** To reduce the risk of personal injury, do not bend blade holders when installing, balancing, or cleaning. Do not insert foreign objects between rotating fan blades.

PROCEED TO YOUR FAN'S CONTROL FEATURE SECTION FOR INSTALLATION/OPERATING INSTRUCTIONS:  
4-SPEED - PAGE 7 | INTELI•TOUCH2 - PAGE 9



## 4-SPEED OPERATION

Pull-chain switches on the fan control the fan and lights. Using the fan control pull-chain switch: Fan off at start.

- First pull: fan ON, High speed
- Second pull: Medium speed
- Third pull: Medium Low speed
- Fourth pull: Low speed
- Fifth pull: Fan OFF

Using the optional light pull-chain switch: Light off at start.

- First pull: light ON
- Second pull: light OFF

Direction of blade rotation is controlled by the reverse slide switch on the side of the switch housing.

No changes in household wiring are required.

OPTIONAL LIGHT  
PULL CHAIN  
SWITCH

FAN & SPEED CON-  
TROL  
PULL CHAIN SWITCH

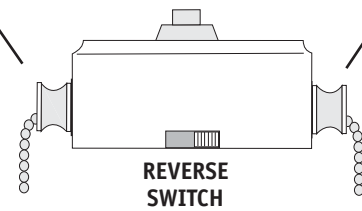

REVERSE  
SWITCH

## 4-SPEED • OPTIONAL LIGHT FIXTURE INSTALLATION

**NOTE:** If a separate circuit is used to control the lights from a wall control, the BLUE D1-Option wire in the canopy should be connected to that switch leg with the BLACK fan power wire.

1. Refer to light kit instructions to assemble and attach your light kit correctly.
2. Remove the two 8-32 screws from the switch housing cap.
3. Remove the plug from switch housing.
4. Install pull-chain switch and finger tighten collar on switch.
5. Connect one wire from pull-chain switch to the BLUE D1-Option wire. Secure splice with a wire nut.
6. Connect other wire from pull-chain switch to BLACK wire from light kit. Secure splice with a wire nut.
7. Connect WHITE wire from switch housing to WHITE wire from light kit. Secure splice with a wire nut.
8. At the canopy, connect the BLACK and BLUE wires.

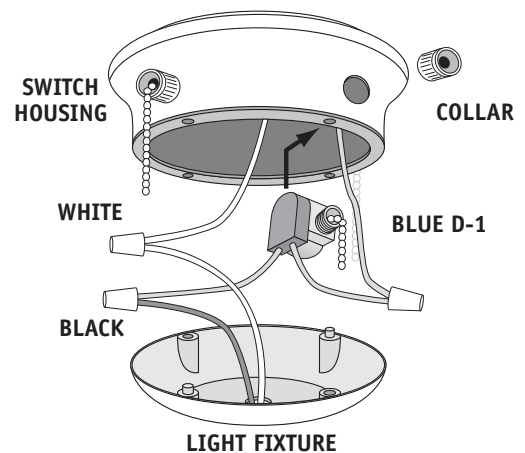

## 4-SPEED OPTIONAL WALL CONTROL • W-41

The W-41 wall control provides four-speed control of fan from a convenient wall location. The W-41 is designed to replace a standard wall switch and will fit wall boxes with a depth of 2" or greater. **Not for use with single pull-chain fan/light option wiring.**

To install a W-41 wall control in place of an existing wall switch, follow the instructions on the W-41 package.

Note: No rewiring is required if the fan is replacing an existing light fixture.

Operation of the fan from the wall switch is simple:

1. Turn knob to obtain desired speed setting.

**CAUTION! Failure to set the pull-chain speed to HIGH can result in faulty operation of the fan and damage to the W-41 wall control. To confirm fan is set to HIGH: Turn W-41 fan speed switch to 'HI' - set fastest fan speed with pull chain.**

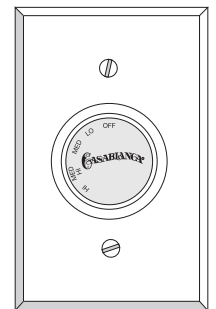

## 4-SPEED • OPTIONAL WALL CONTROL • W-81

The W-81 wall control provides separate control of fan and light with two separate knobs from a convenient wall location. The W-81 is designed to replace a standard wall switch and wall boxes with a depth of 2" or greater. Requires two hot leads from wall box to ceiling wiring box.

To install a W-81 wall control in place of an existing wall switch, follow the instructions on the W-81 package.

Operation of the fan from the wall switch is simple:

1. Turn the upper knob to the desired fan speed.
2. Turn the lower knob to the desired light setting.

**CAUTION! Failure to set the pull-chain speed to HIGH can result in faulty operation of the fan and damage to the W-81 wall control. To confirm fan is set to HIGH: Turn W-81 fan speed switch to 'HI' - set fastest fan speed with pull chain.**

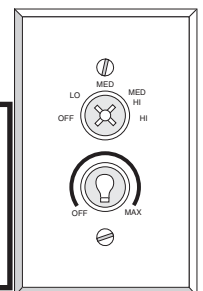

# 4-SPEED

## 4-SPEED • W-41 WALL CONTROL OF THE FAN

- The W-41 allows the choice of four (4) different speed settings.
- No light fixture is used.
- Set the FAN pull chain switch to the HIGH speed setting.
- No changes in household or fan wiring are required.
- The fan may be turned ON and OFF by the W-41 wall control.

**CAUTION!** Failure to set the pull-chain speed to HIGH can result in faulty operation of the fan and damage to the W-41 wall control. To confirm fan is set to HIGH: Turn W-41 fan speed switch to 'HI' - set fastest fan speed with pull chain.

**NOTE:** This product has been evaluated and is suitable for Solid State Speed Controls.

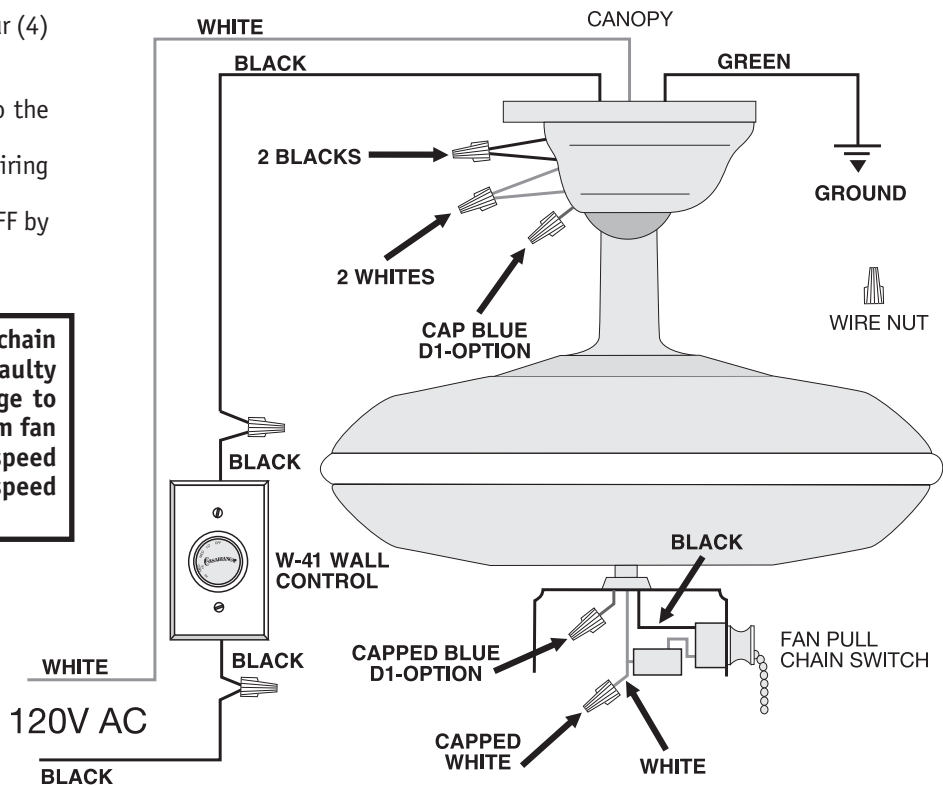

## 4-SPEED • W-81 WALL CONTROL OF THE FAN & LIGHT(S)

- The fan may be turned ON and OFF by the W-81 wall control.
- The lights may be turned ON and OFF by the W-81 and the intensity adjusted from low to high.
- The fan must be supplied with two independent 120V AC supply wires.
- Set the FAN pull chain switch to the HIGH speed setting.
- Turn the lights ON at the fan.
- The W-81 allows the choice of four (4) different speed settings.

**CAUTION!** Failure to set the pull-chain speed to HIGH can result in faulty operation of the fan and damage to the W-81 wall control. To confirm fan is set to HIGH: Turn W-81 fan speed switch to 'HI' - set fastest fan speed with pull chain.

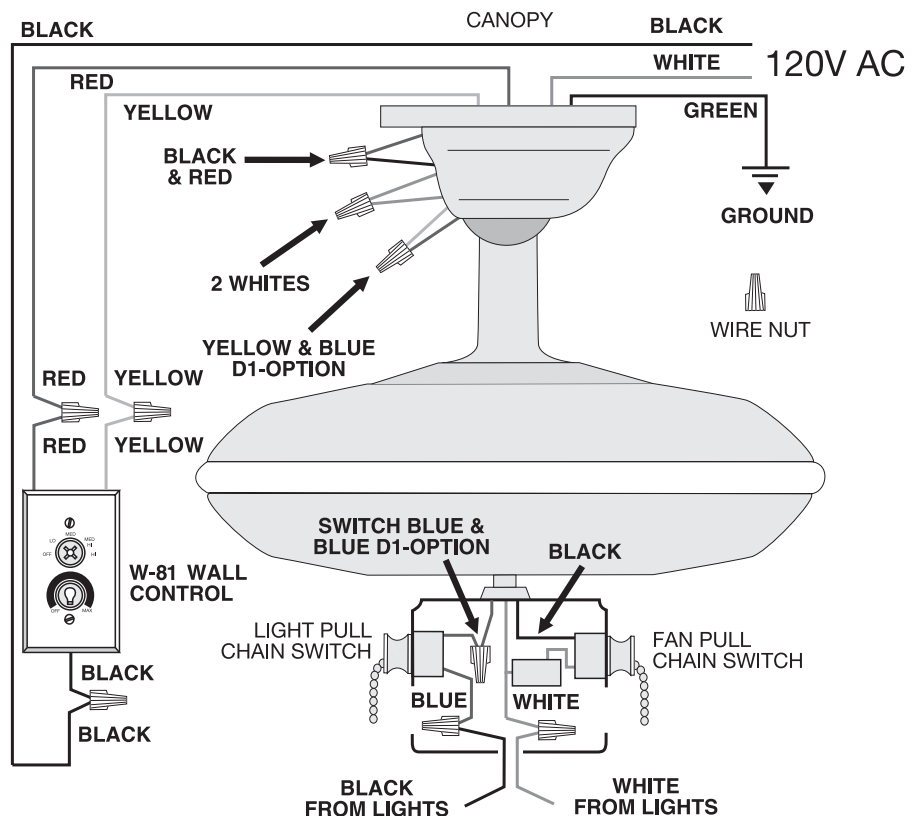





## INTELI•TOUCH INSTALLING THE W-32 WALL CONTROL

The wall control installs in the same manner as an ordinary light switch, using an existing junction box and wiring. This controller is designed to signal the fan microcomputer as well as perform normal switching operations. For this reason the following precautions must be observed:

1. Use **only** the Casablanca W-32 wall control.
2. Do not use any additional control with your Inteli-Touch fan (for example, dimmer, fan speed control, etc.).
3. Do not use more than **one fan per wall control**.
4. No other light fixtures or electrical appliances may be connected on the circuit controlled by the W-32 wall control.

## INTELI•TOUCH SINGLE W-32 INSTALLATION

**CAUTION! Ensure power is turned OFF at the breaker or fuse panel before starting installation.**

W-32 is used to describe either white (-11) or ivory finish.

1. Remove the screws and switch plate from the existing switch box.
2. Remove the screws holding the switch in the switch box.
3. Pull the existing switch from the switch box to expose the wire connections.
4. Remove the two wires from the switch.
5. Connect the two wires just removed from the switch to the W-32 wall control black wire and black/white stripe wire. Secure these connections with wire nuts.
6. Connect the green ground wire coming from the back of the W-32 control to the ground wire in the switch box. Secure the splice with a wire nut.
7. Install the W-32 in the wall box with the two long screws provided.
8. Install the wall plate with the two color matched screws.

**NOTE:** If wall control operation is reversed (fan switch controls lights and light switch controls fan) turn off the power at the breaker or fuse panel, then swap the two W-32 black/white stripe wires.

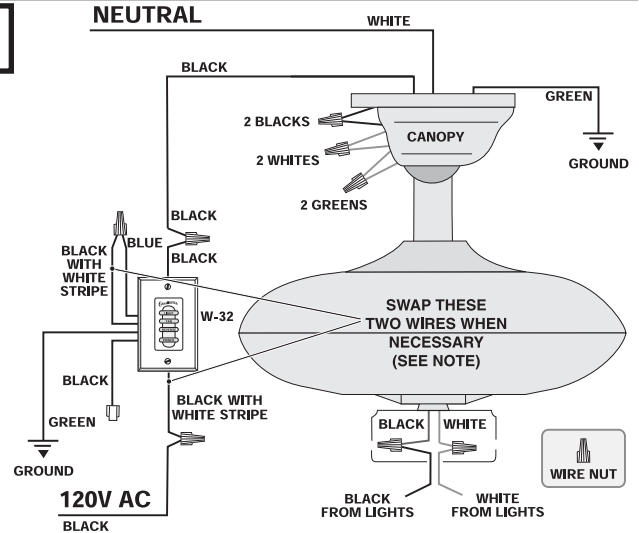

## INTELI•TOUCH DUAL W-32 INSTALLATION

**CAUTION! Ensure power is turned OFF at the breaker or fuse panel before starting installation.**

To control the fan and lights from two locations (a three-way circuit), use 2 W-32 wall controls.

1. Remove the screws and switch plate from the existing switch box and the screws holding the switch in the switch box.
2. Pull the existing switch from the switch box to expose the wire connections.
3. Determine which wire is connected to the common terminal of the 3-way switch. (The terminal will be marked on switch).
4. Remove the wire from the common terminal of the 3-way switch. Connect this wire to the remaining black/white striped wire on the W-32 control. Secure this splice with a wire nut.
5. Remove the two remaining wires from the 3-way switch. Connect one of these wires to a black wire on the W-32 control. Secure the splice with a wire nut. The remaining wire is to be connected to the other black wire on the W-32. Secure the splice with a wire nut.
6. Connect the green ground wire coming from the back of the W-32 control to the ground wire in the switch box. Secure the splice with a wire nut.
7. Install the W-32 in the wall box with the two long screws provided.
8. Install the wall plate with the two short color-matched screws provided.
9. Installation of the second W-32 control is identical. Repeat steps 1 through 7.

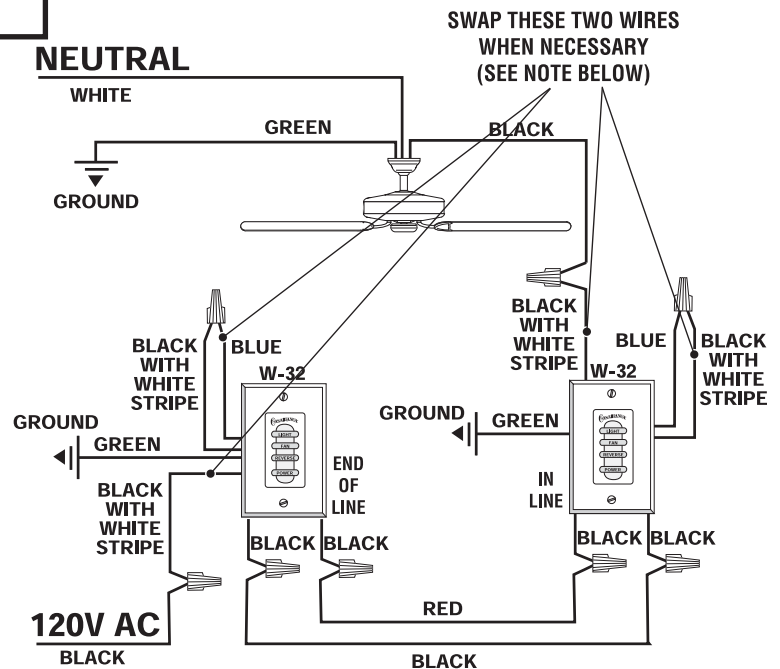

**NOTE:** If wall control operation is reversed (fan switch controls lights and light switch controls fan) turn off the power at the breaker or fuse panel, then swap the two W-32 black/white stripe wires.

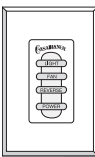

# Inteli-Touch™

## INTELI-TOUCH OPERATION POWER

The **POWER** button is normally left in the on position. Always turn the power off during cleaning or servicing the fan and during thunderstorms. It is also used to exit or enter additional programs.

**POWER must be left on to retain a previously set fan speed or light level.**

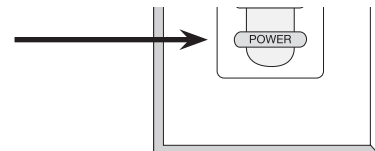

## INTELI-TOUCH OPERATION SPEED CONTROL

There are six individual speed settings for the fan; each speed is indicated by an audible tone of increasing pitch.

### To select the desired fan speed:

1. With fan off, press and hold the button labeled **FAN**. The fan blades will start rotating at the slowest speed, and will increase in steps.
2. Release the button when the desired speed is reached.

The fan speed is now in memory and will automatically come on at the same speed each time the **FAN** button is used. To maintain this level of speed, turn the fan on by pressing **FAN** less than one second. To lower speed, turn fan off, then on by pressing and holding the **FAN** button until the desired speed is reached. When the fan is on, you may increase the speed by pressing and holding the **FAN** button until the desired speed is reached, then release it.

### FAN CONTROL

**ON - OFF**  
A momentary press of the **FAN** button

**TO CHANGE SPEED**  
Press and hold **FAN** button longer than one second

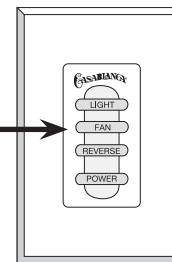

## INTELI-TOUCH • REVERSING AIRFLOW

The direction of airflow can be changed from downward to upward or from upward to downward.

### To reverse the airflow:

1. Make sure the **FAN** is on.
2. Press the **REVERSE** button.

**Note:** A four-toned signal indicates the command was accepted by the fan. A few seconds later the fan will slow to a stop and then reverse direction.

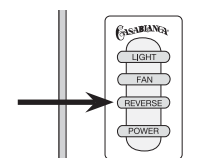

## INTELI-TOUCH LIGHT

To turn the lights off and on, press and release the **LIGHT** button for less than one second.

### To vary the light brightness:

1. With lights off, press and hold the **LIGHT** button. After one second the lights come on at their lowest level and gradually become brighter.
2. Release the button when the desired brightness level is reached.

The brightness level is now in the fan memory and will automatically come on at the same brightness the next time the **LIGHT** button is used. To maintain this level of brightness, press the **LIGHT** button for less than one second. To lower the brightness, turn the lights off, then press and hold the **LIGHT** button until the desired brightness level is reached. When the light is on, you may increase the brightness level by pressing and holding the **LIGHT** button until the desired level is reached, then release it.

### LIGHT CONTROL

**ON - OFF**  
A momentary press of the **LIGHT** button

**TO CHANGE BRIGHTNESS**  
PRESS AND HOLD **LIGHT** BUTTON LONGER THAN ONE SECOND

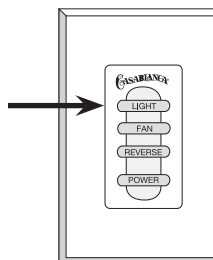

## AUTOMATIC DEMONSTRATION PROGRAM

Programmed into every Inteli-Touch Series fan is an Automatic Demonstration Program. It can be used to fully demonstrate and test the operation of the fan.

### To enter the demonstration program:

1. Turn **POWER** off for at least three seconds. This will clear the fan memory ready for programming.
2. Turn **POWER** on.
3. Immediately operate the buttons in the following sequence:



A multi-tone signal will verify the start of the test program which proceeds as follows:

- Lights slowly increase to full intensity.
- Fan accelerates to speed three with audio tones.
- Light dims to half intensity.
- Fan accelerates to full speed with audio tones.
- Fan reverses at full speed with audio tones.
- Fan operates at full speed.
- Fan power is reversed with audio tones.
- Fan turns off with audio tones (blades coast for a short time).
- Lights turn off.

The complete cycle lasts slightly over one minute. It will continue to repeat until the **POWER** is turned off for more than three seconds, cancelling the program.

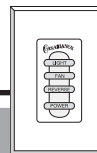

## INTELI•TOUCH OPERATION LIGHT-MINDER PROGRAM

The Light-Minder program automatically turns OFF the fan mounted lights after two hours.

### To enter the Light-Minder Program:

1. Turn the **POWER** OFF for at least three seconds.
2. Turn the
3. Immediately operate the buttons in the following sequence:



4. A series of tones indicates this command has been accepted.

The fan and light will operate normally using the buttons to turn them on and off. But, if the lights are left on, they will automatically shut off after two hours. To cancel the Light-Minder Program, turn the **POWER** off for three seconds.

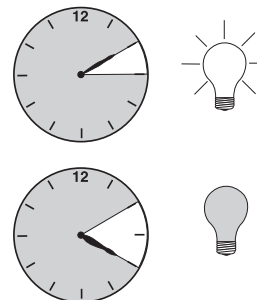

## INTELI•TOUCH OPERATION SAFE-EXIT PROGRAM

The Safe-Exit Program gives you about thirty seconds of light when you turn the lights off, enabling you to exit your home before the lights go out.

### To enter the Safe-Exit Program:

1. Turn the **POWER** off for at least three seconds.
2. Turn the **POWER** on.
3. Immediately operate the buttons in the following sequence:



**After** you hear the confirming audio

tones from the fan - **immediately press** **LIGHT**

4. The lights will blink to indicate this command has been accepted. The lights will stay on for twenty seconds and then begin to dim. After a total of thirty seconds has elapsed, the lights will be off completely. To cancel the Safe-Exit Program, turn the **POWER** off for three seconds.

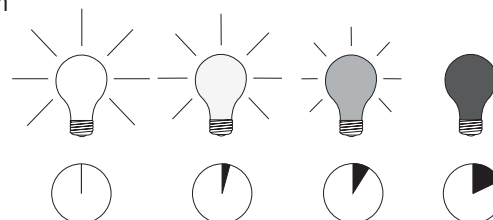

**Note:** Both Light-Minder and Safe-Exit programs can run at the same time, however the dimmer cannot be used, the light may only be turned ON/OFF.

## INTELI•TOUCH OPERATION HOME-SAFE® PROGRAM

The Home-Safe Program makes an unoccupied home appear occupied by turning the lights on and off at random times.

### To enter the Home-Safe Program:

1. Turn the **POWER** off for at least three seconds.
2. Turn the **POWER** on.
3. Immediately operate the buttons in the following sequence:



4. A tone and flashing light indicate this command has been accepted.

This program overrides all manual control of lights and fan. The lights will now be automatically cycled on and off in a controlled sequence as follows: On 1 hour, off 1/2 hour, on 2 hours, off 1 hour, on 1/2 hour then off 2 hours.

This seven hour pattern will repeat continuously so that a different pattern of lighting is seen each day of the week.

To cancel the Home-Safe Program, turn the **POWER** off for three seconds.



## INTELI•TOUCH OPERATION FAN-MINDER® PROGRAM

The Fan-Minder feature will add to your comfort when used in the bedroom. The program reduces the speed of the fan each two-hour interval to compensate for the cooling night air.

### To enter the Fan-Minder Program:

1. Turn the **POWER** off for at least three seconds.
2. Turn the **POWER** on.
3. Immediately operate the buttons in the following sequence:



4. The fan controller will respond with three descending tones. A timer is now initiated and the fan will reduce one speed for each two-hour interval. The fan will not, however, descend below the second lowest speed.

To cancel the Fan-Minder Program, turn the **POWER** off for three seconds. You may increase the fan speed by pressing and holding the **FAN** button until the desired speed is reached, then release it. The fan will again reduce one speed for each 2 hour interval.

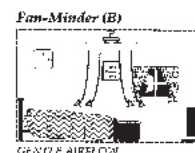
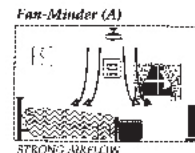

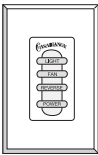

## TROUBLESHOOTING

**Before Requesting Service: Please follow this troubleshooting guide before contacting your dealer for assistance.**

**Caring for Finishes:** For cleaning, a soft brush or lint-free cloth should be used to prevent scratching the finish. A vacuum cleaner brush nozzle can remove heavier dust. Surface smudges or an accumulation of dirt and dust can easily be removed by using a mild detergent and slightly dampened soft cloth. An antistatic agent may be used, but **never** use abrasive cleaning agents. These will damage the finish. Painted and high-gloss blades may be cleaned in the same manner.

**Blades:** Wood finish blades should be cleaned with a furniture polishing cloth. Occasionally, a light coat of furniture polish may be applied for added protection and beauty.

**Never Lubricate this Fan!**

The precision motor at the heart of your Casablanca fan features sealed bearings that are lubricated for life. Do not attempt to oil the motor.

**Changing Light Bulbs**

Be sure to turn power to the fan OFF at the wall switch or circuit breaker before changing light bulbs. Replace bulbs with same type as removed from the fixture. Each fan is rated for a maximum **TOTAL** wattage of lighting.

Exceeding the rated maximum allowable wattage for the fan will burn out the fan electronics module and void the warranty.

### PROBLEM INTELI•TOUCH POSSIBLE REMEDIES

**NO FAN OR LIGHT** Check main circuit fuses, curcuit breakers, or wall switch position. Check all wire connections, making sure the power is turned off during this inspection.

**FAN WOBBLES OR SHAKES EXCESSIVELY** Be sure canopy pin is properly set into the slot on the ball  
Check the screws holding the blade holders to the fan motor. Tighten as necessary.  
Check the angle of the blades to make sure that a blade holder has not been bent during installation.

**FAN NOISY DURING OPERATION** Check and tighten light fixture retaining screws, glass shade screws and/or the light bulb(s).  
Tighten canopy screws and mounting plate assembly.  
Tighten the blade to bladeholder screws and blade holders to flywheel.  
Make sure all screws in the motor housing are snug, but not overly tight.  
Check that the wire nuts inside the canopy and switch housing are not touching the metal parts or have fallen off the wire splices. Tighten or adjust as necessary.

**BREAK-IN PERIOD** Let fan run at high speed for two (2) hours

**DOES NOT RUN ON LOW SPEED** If new, "break-in" may be required - run at higher speed for several days

**LIGHTS FLASH OR BLINK DURING OPERATION OF W-32 WALL CONTROLS/FAN MAY ROTATE OR MAKE AUDIBLE TONES DURING OPERATION OF THE W-32 WALL CONTROLS:** Normal operation.

**WHEN AC POWER IS TURNED ON FOR THE FIRST TIME, THE LIGHTS OPERATE NORMALLY, BUT W-32 WALL CONTROL OPERATION IS REVERSED: FAN BUTTON OPERATES THE LIGHTS; LIGHT BUTTON OPERATES THE FAN:** Reverse the 2 black and white striped wire connections.

**FAN OR LIGHTS APPEAR TO OPERATE BY THEMSELVES (CHANGING SPEED OR INTENSITY), WALL CONTROL OPERATION IS INTERMITTENT:** Check AC supply for irregularities, (noise spikes, fluctuations, or failure); or circuit board assembly.

## SAFETY FIRST

**Warning:** To reduce the risk of electrical shock, this fan must be installed with an isolating wall control/switch.

## ADVAN•TOUCH W-62 BRACKET/HOLSTER REMOVAL

**Step 1.** Remove the two 6-32 x 5/16" screws holding the bracket to the holster. Save screws for later.

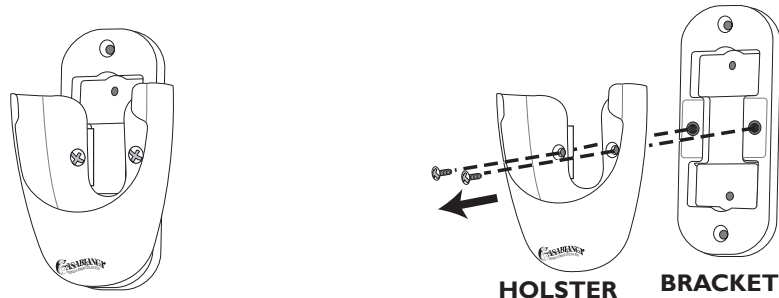

## ADVAN•TOUCH CONTROL BRACKET INSTALLATION

**CAUTION!** Do not use with wall dimmer.

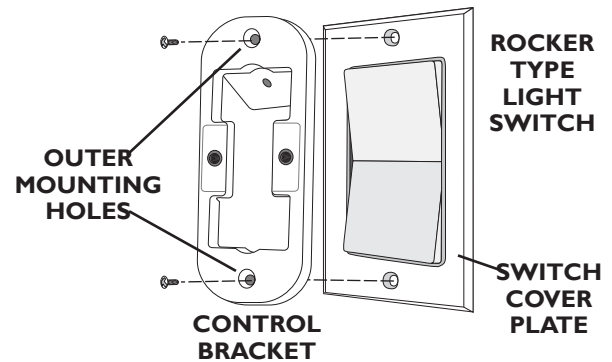
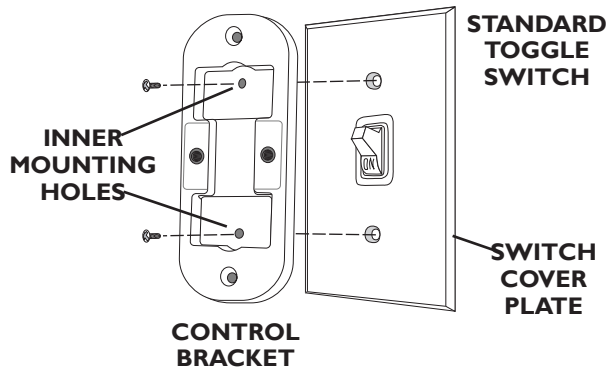

### Standard Light Switch

**Step A.** Remove the two screws holding the switch cover plate. Do not remove the cover plate.

**Step B.** Orient the control bracket as shown and line up the two inner mounting holes with those on the switch.

**Step C.** Install and tighten screws by **hand** only.

### Rocker Light Switch

**Step A.** Break off the two tabs by pushing outward.

**Step B.** Remove the two screws holding the switch cover plate. Do not remove the cover plate.

**Step C.** Orient the control bracket as shown and line up the two inner mounting holes with those on the switch.

**Step D.** Install and tighten screws by **hand** only.

### Wall Installation

**Step A.** Locate a 2x4 wall stud in a convenient location.

**Step B.** Orient the control bracket as shown over the 2x4 stud.

**Step C.** Use the 1" wood screws in either the inner or outer mounting holes. Install and tighten screws by **hand** only.

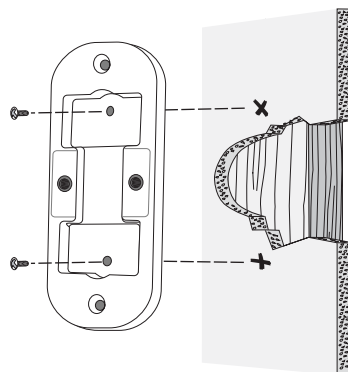

**Note:** The wall anchors and 6-32 x 1" screws may be used in situations where mounting to a stud is not possible. Use the inner mounting holes. After securing the anchor, discard the anchor's pointed screws and use the 6-32 decor ovalhead screws supplied.

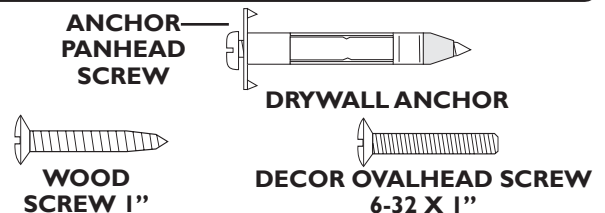

## ADVAN•TOUCH ATTACH HOLSTER TO BRACKET

### Step 2

After you have completed installing the bracket to the wall, using the 2 screws removed in Step 1, attach the W-62 holster to the bracket.



# ADVAN•TOUCH™

## ADVAN•TOUCH BATTERY INSTALLATION

Open Battery Door by pressing down on the insert tab provided.

**BATTERY DOOR**

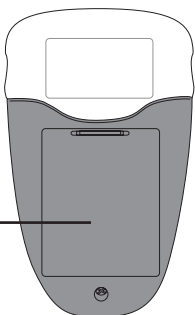

Install 4 "AAA" alkaline batteries in the space provided. Please observe proper polarity placement. Replace Battery Door.

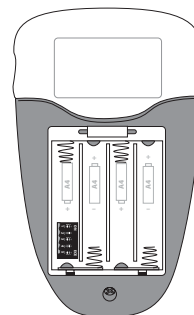

## ADVAN•TOUCH IMPORTANT OPERATING NOTES

### Power turned off, interrupted or failure:

The remote control is battery operated, therefore if the power is turned off, interrupted or you experience a power failure, the remote control remembers the previous setting for both fan and light.

### Button operation:

#### Rapid button operation causes erratic fan operation.

For reliable operation of the remote control and fan you must wait one second between button presses to allow the radio signal to be transmitted to the fan and received.

## ADVAN•TOUCH OPERATION

### Fan Operation

The Advan•Touch fan is controlled by the remote control. The fan button located in the center top row, turns the fan on or off.

With the fan on, the control display will indicate an up or down moving arrow that shows direction and places a box around the operating speed. It will also show you a moving fan image that tells you the fan is on and what direction the blades are moving in (looking up from underneath the fan).

Just below the fan button, there are two ▲ and ▼ buttons. Use the ▲ button (on the left) to increase fan speed once for each press and the ▼ button (on the right) to decrease speed once for each press.

Use the reverse button to change the direction of the rotation. Reverse operates at any speed. The fan returns to its set speed after reversing.

You will see the airflow direction arrow change each time to press reverse.

### Light Operation

The light is turned on or off independently of the fan by pressing the LIGHT button. Keep pressing the button (hold it down) and it becomes a dimmer. The light varies from "bright" to "dim" over approximately 8 seconds. This sequence will reverse the light when it reaches the brightest or dimmest level if you continue to hold the LIGHT button. Release the button when the desired level is reached.

### Safe Exit Feature

To turn off the light, hit the button once and the light will increase slightly if less than 100% and gradually turn off, taking approximately 20 seconds. (If set at 100%, light will decrease to about 50% and then gradually turn off.) This enables you to leave a room or your home safely before the lights go completely out.

Push the light button two times and the light will immediately dim to about half and then turn off completely.

The fan will remember the last light setting and will come on at that setting until changed.

### Bulb Saver Feature

When the light is turned on, the brightness will take 1.5 seconds until it reaches the present level. This feature helps extend light bulb life.

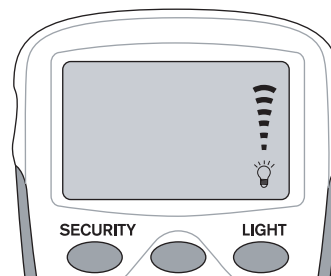
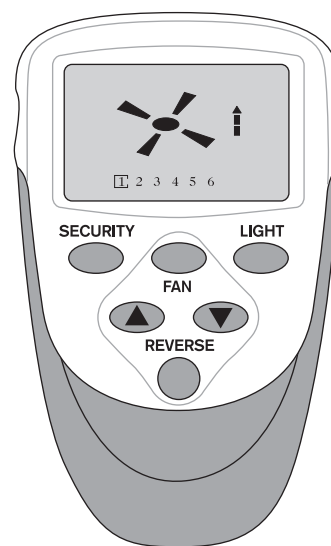

## SECURITY FEATURE

Pressing the 'SECURITY' button will start the Security lighting program. The controller beeps and indicates 'SECURITY'. The light will automatically turn ON and OFF in a seemingly random manner over an eight and a quarter hour programmed cycle that is designed to give the home a "lived-in" look. Regardless of the light setting when switching to the Security mode (lights on or off, dim or bright), the lights will increase to high brightness and then begin the Security cycle. This cycle is then repeated continuously until cancelled by pressing the 'SECURITY' button.

At any time during the Security mode you may adjust the fan speed, reverse the direction, operate in Auto Speed or Winter, use Saver or run the Test mode without affecting Security mode.

You may still turn the light ON and OFF (or OFF and ON) manually for temporary lighting, but the light will continue to operate automatically at its programmed times.

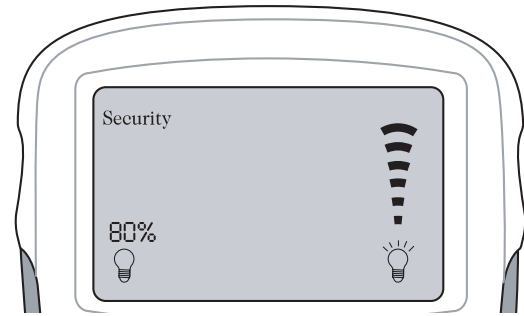

### SECURITY MODE CYCLE

- |                                    |                                   |
|------------------------------------|-----------------------------------|
| 1. On for 60 minutes (80% bright)  | 4. Off for 60 minutes             |
| 2. Off for 30 minutes              | 5. On for 90 minutes (50% bright) |
| 3. On for 120 minutes (30% bright) |                                   |

## ADVAN•TOUCH CHANGING FREQUENCY SETTING

**Note:** All fans leave the factory set to '10000'.

**You will have to change the dip switch settings in the remote if you are using more than one fan in the same area and want to control them separately.**

**Step 1.** At the circuit breaker or fusebox, turn the power off for the fan you want to change.

**Step 2.** Open the battery door of the Advan•Touch control and remove the first battery on the left to gain access to the dip switches.

**Step 3.** Change the dip switch settings, assuring that they are different from the previously installed Advan•Touch fan(s).

**Step 4.** Re-install the battery in the proper polarity and the battery door on the control.

**Step 5.** At the circuit breaker or fuse box, turn the power back on for the fan whose frequency you are changing.

**Step 6.** Within 20 seconds of restoring power, push the ▲ up and ▼ down buttons at the same time. Hold for a few seconds. You will see the LCD Screen flash all of the graphics. You should now have control of the fan.

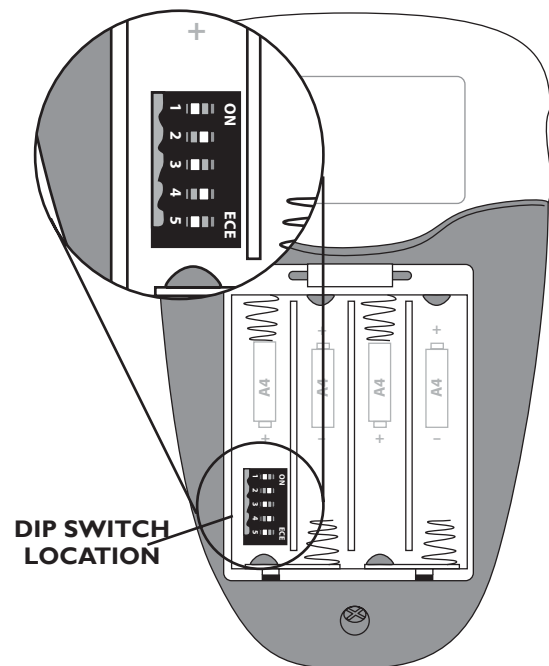

**Note:** You may want to label your controls to assure you do not mix them up.

## ADVAN•TOUCH IF THE FAN DOES NOT WORK

**If the fan is not functioning after installation:**

**Step 1.** Check to make sure the batteries are installed properly in the control.

**Step 2.** Turn the power off to the fan (from the circuit breaker) for at least 5 seconds.

**Step 3.** Turn the power back on (at the circuit breaker) and push the ▲ up and ▼ down buttons at the same time, within 20 seconds from restoring power.

**Step 4.** The fan should now function properly.



**Before Requesting Service: Please follow this troubleshooting guide before contacting your dealer for assistance.**

**Caring for Finishes:** For cleaning, a soft brush or lint-free cloth should be used to prevent scratching the finish. A vacuum cleaner brush nozzle can remove heavier dust. Surface smudges or an accumulation of dirt and dust can easily be removed by using a mild detergent and slightly dampened soft cloth. An antistatic agent may be used, but **never** use abrasive cleaning agents. These will damage the finish. Painted and high-gloss blades may be cleaned in the same manner.

**Blades:** Wood finish blades should be cleaned with a furniture polishing cloth. Occasionally, a light coat of furniture polish may be applied for added protection and beauty.

**Never Lubricate this Fan!**

The precision motor at the heart of your Casablanca fan features sealed bearings that are lubricated for life. Do not attempt to oil the motor.

**Changing Light Bulbs**

Be sure to turn power to the fan OFF at the wall switch or circuit breaker before changing light bulbs. Replace bulbs with same type as removed from the fixture. Each fan is rated for a maximum **TOTAL** wattage of lighting.

Exceeding the rated maximum allowable wattage for the fan will burn out the fan electronics module and void the warranty.

PROBLEM	ADVAN•TOUCH	POSSIBLE REMEDIES
---------	-------------	-------------------

<b>FAN WILL NOT START</b>	-Check main circuit fuses, circuit breakers, or wall switch position. Check all wire connections, making sure the power is turned off during this inspection. -Pin connectors are not making good contact. Check all connections. -Battery weak—install fresh battery. -Fan receiver defective—replace.	
---------------------------	--	--

<b>FAN DOES NOT RESPOND TO REMOTE CONTROL</b>	-Power to fan is off. -Wrong remote is being used. -Remote dip settings changed—see instructions for changing the frequency setting.	
---	--	--

<b>FAN WOBBLER OR SHAKES EXCESSIVELY</b>	-Be sure canopy pin is properly set into the slot on the ball. -Check that bladeholders have not been bent during installation and blades are balanced. -Hanger bracket and/or ceiling outlet are loosely attached: Make sure that the hanger bracket is tightly attached to the ceiling outlet box. Make sure that the downrod assembly is secured firmly. -Downrod is loosely attached to downrod base: Make sure that all screws are securely tightened.	
--	--	--

<b>FAN NOISY DURING OPERATION</b>	-Check and tighten light fixture retaining screws, glass shade screws and/or the light bulb(s). -Tighten canopy screws and mounting plate assembly. Check that the wire nuts inside the canopy and switch housing are not touching the metal parts or have fallen off the wire splices. Tighten as necessary. -Tighten blade holders to flywheel (or direct drive motor)/and blade to bladeholder screws. -Make sure all screws in the motor housing are snug, but not overly tight. Defective bulb: Replace bulb.	
-----------------------------------	---	--

<b>DOES NOT RUN ON LOW SPEED</b>	-If new, “break-in” may be required - run at higher speed for several days.	
----------------------------------	---	--

<b>BATTERY LIFE SEEMS SHORT</b>	-Not using Alkaline batteries: Replace with ALKALINE batteries.	
---------------------------------	---	--

**FAN O.K., NO LIGHT:** Check for burned out light bulb. Check fan light wires.

**LIGHT O.K., NO FAN:** Check connectors, may not be making good contact.

**REMOTE CONTROL OF FAN IS ERRATIC:** Check batteries installed correctly. Install fresh ALKALINE batteries.

**FAN STARTS WORKING BY ITSELF:** Frequency interference; Change dip switch code.

This device complies with RSS-210 of Industry Canada. Operation is subject to the following two conditions: (1) this device may not cause interference, and (2) this device must accept any interference, including interference that may cause undesired operation of the device.

1. This device complies with part 15 of the FCC Rules. Operation is subject to the following two conditions: (1) this device may not cause harmful interference, and (2) this device must accept any interference received, including interference that may cause undesired operation.

2. This equipment has been tested and found to comply with the limits for a Class B digital device, pursuant to Part 15 of the FCC Rules. These limits are designed to provide reasonable protection against harmful interference in a residential installation. This equipment generates, uses and can radiate radio frequency energy and, if not installed and used in accordance with the instructions, may cause harmful interference to radio communications. However there is no guarantee that interference will not occur in a particular installation. If this equipment does cause harmful interference to radio or television reception, which can be determined by turning the equipment off and on, the user is encouraged to try to correct the interference by one or more of the following measures: Reorient or relocate the receiving antenna, Increase the separation between the equipment and receiver, Connect the equipment into an outlet on a circuit different from that to which the receiver is connected. Consult the dealer or an experienced radio/TV technician for help. Note: Any changes or modifications to the transmitter or receiver not expressly approved by Casablanca Fan Company may void one's authority to operate this remote control.



## Free Manuals Download Website

<http://myh66.com>

<http://usermanuals.us>

<http://www.somanuals.com>

<http://www.4manuals.cc>

<http://www.manual-lib.com>

<http://www.404manual.com>

<http://www.luxmanual.com>

<http://aubethermostatmanual.com>

Golf course search by state

<http://golfingnear.com>

Email search by domain

<http://emailbydomain.com>

Auto manuals search

<http://auto.somanuals.com>

TV manuals search

<http://tv.somanuals.com>