

EXILIM

E

Digital Camera

EX-Z3

User's Guide

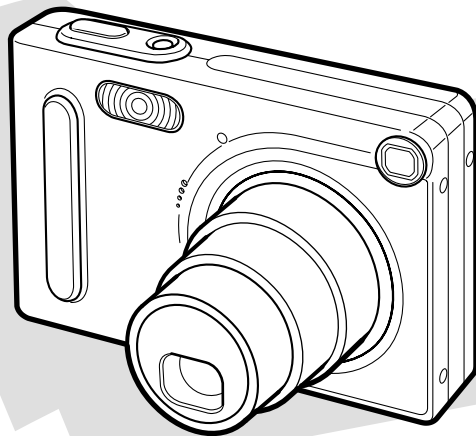

Thank you for purchasing this CASIO Product. Before using it, be sure to read the precautions contained in this User's Guide, and keep the User's Guide in a safe place for future reference.

K855PCM1DMX

Download from [Www.Somanuals.com](http://www.Somanuals.com). All Manuals Search And Download.

CASIO®

INTRODUCTION

Unpacking

Check to make sure that all of the items shown below are included with your camera. If something is missing, contact your dealer as soon as possible.



Camera

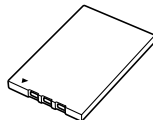

Rechargeable lithium ion battery (NP-20)



USB Cradle (CA-21)

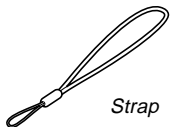

Strap



CD-ROM

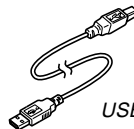

USB Cable

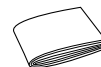

Basic Reference

- Note that the shape of the AC adaptor depends on the area where you purchased the camera.

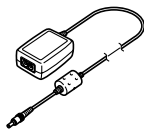

Special AC Adaptor (Inlet Type)

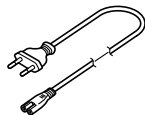

AC power cord *

* The shape of the AC power cord plug varies according to country or geographic area.

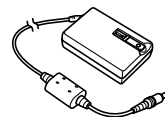

Special AC Adaptor (Plug-in Type)

Contents

2 INTRODUCTION

| | |
|------------------------------|----|
| Unpacking | 2 |
| Features | 9 |
| Precautions | 11 |
| General Precautions | 11 |
| Data Error Precautions | 12 |
| Operating conditions | 13 |
| Condensation | 13 |
| LED Backlight | 14 |
| Lens | 14 |
| Other | 14 |

15 QUICK START GUIDE

| | |
|--|----|
| First, charge the battery! | 15 |
| To configure display language and clock settings | 16 |
| To record an image | 17 |
| To view a recorded image | 17 |
| To delete an image | 18 |

19 GETTING READY

| | |
|--|----|
| About This Manual | 19 |
| General Guide | 20 |
| Camera | 20 |
| USB Cradle | 21 |
| Monitor Screen Contents | 22 |
| REC mode | 22 |
| PLAY mode | 23 |
| Changing the Contents of the Monitor Screen | 24 |
| Indicator Lamps | 24 |
| Attaching the Strap | 25 |
| Power Requirements | 25 |
| To load the battery | 25 |
| To remove the battery | 27 |
| To charge the battery | 27 |
| Power Supply Precautions | 32 |
| Turning the Camera On and Off | 35 |
| Configuring Power Saving Settings | 36 |
| Using the On-screen Menu | 37 |
| Configuring Display Language and Clock Settings ... | 39 |
| To configure display language and clock settings | 40 |

INTRODUCTION

43 BASIC IMAGE RECORDING

| | |
|---|----|
| Recording an Image | 43 |
| Recording Precautions | 45 |
| About Auto Focus | 46 |
| About the REC Mode Monitor Screen | 46 |
| Using the Optical Viewfinder | 47 |
| Using Zoom | 48 |
| Optical Zoom | 48 |
| Digital Zoom | 49 |
| Using the Flash | 50 |
| Flash Unit Status | 52 |
| Flash Precautions | 52 |
| Using the Self-timer | 53 |
| Specifying Image Size and Quality | 55 |
| To specify the image size | 55 |
| To specify image quality | 56 |

57 OTHER RECORDING FUNCTIONS

| | |
|--------------------------------|----|
| Selecting the Focus Mode | 57 |
| Using Auto Focus | 57 |
| Using the Macro Mode | 58 |
| Using the Infinity Mode | 59 |
| Using Manual Focus | 59 |
| Using Focus Lock | 60 |

| | |
|--|----|
| Exposure Compensation (EV Shift) | 61 |
| Adjusting White Balance | 63 |
| Adjusting White Balance Manually | 64 |
| Using the Best Shot Mode | 65 |
| Creating Your Own Best Shot Setup | 66 |
| Combining Shots of Two People into a Single Image (Coupling Shot) | 69 |
| Recording a Subject onto an Existing Background Image (Pre-shot) | 71 |
| Using the Movie Mode | 73 |
| Using the Histogram | 75 |
| REC Mode Camera Settings | 76 |
| Specifying ISO Sensitivity | 76 |
| Turning Image Review On and Off | 77 |
| Assigning Functions to the [◀] and [▶] Keys | 77 |
| Specifying Power On Default Settings | 78 |
| Resetting the Camera | 79 |

80 PLAYBACK

| | |
|---------------------------------|----|
| Basic Playback Operation | 80 |
| Flipping the Display | 81 |
| Zooming the Display Image | 82 |
| Resizing an Image | 83 |

INTRODUCTION

| | |
|--|----|
| Cropping an Image | 84 |
| Playing a Movie | 85 |
| Displaying the 9-image View | 86 |
| Selecting a Specific Image in the 9-image View | 87 |
| Displaying the Calendar Screen | 87 |
| Playing a Slide Show | 88 |
| To specify the slideshow images | 90 |
| To specify the slideshow time | 91 |
| To set the slideshow interval | 91 |
| Using the Photo Stand Feature | 92 |
| Rotating the Display Image | 93 |

94 DELETING FILES

| | |
|------------------------------|----|
| Deleting a Single File | 94 |
| Deleting All Files | 95 |

96 FILE MANAGEMENT

| | |
|--|-----|
| Folders | 96 |
| Memory Folders and Files | 96 |
| Protecting Files | 97 |
| To protect a single file | 97 |
| To protect all files in memory | 98 |
| DPOF | 98 |
| To configure print settings for a single image | 99 |
| To configure print settings for all images | 100 |

| | |
|---|-----|
| PRINT Image Matching II | 101 |
| Exif Print | 101 |
| Using USB DIRECT-PRINT | 102 |
| Using the FAVORITE Folder | 104 |
| To copy a file to the FAVORITE folder | 104 |
| To display a file in the FAVORITE folder | 105 |
| To delete a file from the FAVORITE folder | 106 |

108 OTHER SETTINGS

| | |
|---|-----|
| Specifying the File Name Serial Number Generation Method | 108 |
| Turning the Key Tone On and Off | 109 |
| Specifying an Image for the Startup Screen | 109 |
| Using the Alarm | 110 |
| To set an alarm | 110 |
| Stopping the Alarm | 111 |
| Setting the Clock | 112 |
| To select your Home Time zone | 112 |
| To set the current time and date | 113 |
| Changing the Date Format | 113 |
| Using World Time | 114 |
| To display the World Time screen | 114 |
| To configure World Time settings | 114 |
| To configure summer time (DST) settings | 115 |
| Changing the Display Language | 116 |
| Formatting Built-in Memory | 117 |

INTRODUCTION

118 USING A MEMORY CARD

| | |
|--|-----|
| Using a Memory Card | 119 |
| To insert a memory card into the camera | 119 |
| To remove a memory card from the camera | 119 |
| Formatting a Memory Card | 120 |
| Memory Card Precautions | 121 |
| Copying Files | 122 |
| To copy all the files in built-in memory to a memory card | 122 |
| To copy a file from a memory card to built-in memory | 123 |

124 VIEWING IMAGES ON A COMPUTER

| | |
|---|-----|
| Using the Camera with a Windows Computer | 124 |
| USB Connection Precautions | 129 |
| Using the Camera with a Macintosh Computer | 129 |
| USB Connection Precautions | 134 |
| Operations You Can Perform from Your Computer .. | 134 |
| Using a Memory Card to Transfer Images to a Computer | 135 |
| Memory Data | 136 |
| DCF Protocol | 136 |
| Memory Directory Structure | 136 |
| Image Files Supported by the Camera | 137 |
| Built-in Memory and Memory Card Precautions | 138 |

139 USING THE CAMERA WITH A COMPUTER

| | |
|---|-----|
| Using the Album Feature | 139 |
| Creating an album | 139 |
| Selecting an Album Layout | 140 |
| Configuring Detailed Album Settings | 141 |
| Viewing Album Files | 143 |
| Saving an Album | 146 |
| Installing the Software from the CD-ROM | 146 |
| About the bundled CD-ROM | 146 |
| Computer System Requirements | 147 |
| Installing Software from the CD-ROM in Windows ... | 148 |
| Getting Started | 148 |
| Selecting a Language | 148 |
| Viewing the Contents of the "Read me" File | 149 |
| Installing an Application | 149 |
| Viewing User Documentation (PDF Files) | 150 |
| User Registration | 150 |
| Exiting the Menu Application | 150 |
| Installing Software from the CD-ROM on a Macintosh | 151 |
| Installing Software | 151 |
| Viewing User Documentation (PDF Files) | 152 |

154 APPENDIX

| | |
|--------------------------------|-----|
| Menu Reference | 154 |
| Indicator Lamp Reference | 156 |
| REC mode | 157 |
| PLAY mode | 158 |
| USB Cradle Indicator Lamps | 158 |
| Troubleshooting Guide | 159 |
| Display Messages | 162 |
| Specifications | 163 |
| Main Specifications | 163 |

INTRODUCTION

►► IMPORTANT! ◀◀

- The contents of this manual are subject to change without notice.
- CASIO COMPUTER CO., LTD. assumes no responsibility for any damage or loss resulting from the use of this manual.
- CASIO COMPUTER CO., LTD. assumes no responsibility for any loss or claims by third parties which may arise through the use of the EX-Z3.
- CASIO COMPUTER CO., LTD. shall not be held liable for any damages or losses suffered by you or any third party due to the use of Photo Loader and/or Photohands.
- CASIO COMPUTER CO., LTD. assumes no responsibility for any damage or loss caused by deletion of data as a result of malfunction, repairs, or battery replacement. Be sure to back up all important data on other media to protect against its loss.
- *The SD logo is a registered trademark.*
- *Windows, Internet Explorer, and DirectX are registered trademarks of Microsoft Corporation.*
- *Macintosh is a registered trademark of Apple Computer, Inc.*
- *MultiMediaCard is a trademark of Infineon Technologies AG of Germany, and licensed to the MultiMediaCard Association (MMCA).*
- *Acrobat and Acrobat Reader are trademarks of Adobe Systems Incorporated.*

- *The USB driver (mass storage) uses Phoenix Technologies Ltd. software.
Compatibility Software Copyright © 1997
Phoenix Technologies Ltd., All Rights Reserved.*
- *Other company, product and service names used herein may also be trademarks or service marks of others.*
- *Photo Loader and Photohands are the property of CASIO COMPUTER CO., LTD. Except as stipulated above, all copyrights and other related rights to these applications revert to CASIO COMPUTER CO., LTD.*

■ Copyright Restrictions

Except for the purposes of your own personal enjoyment, unauthorized copying of snapshot files and movie files violates copyright laws and international contracts. Distribution to third parties of such files over the Internet without permission of the copyright holder, whether for profit or for free, violates copyright laws and international contracts.

Features

- **3.2 million Effective Pixels**
A high-resolution megapixel CCD provides 3.2 million effective pixels (3.34 million total pixels) for images that print beautifully.
- **2.0-inch TFT color LCD monitor screen**
- **12X seamless zoom**
3X optical zoom, 4X digital zoom
- **10MB Flash memory**
Images can be recorded without using a memory card.
- **Support for SD memory cards and MMC (MultiMedia Cards) for memory expansion**
- **Easy Charging**
Just place the camera onto the USB cradle to charge its battery.
- **Easy Image Transfer**
Transfer images to a computer simply by placing the camera onto the USB cradle.
- **Photo Stand feature**
A slideshow of images in file memory can be played while the camera is on its USB cradle.
- **Best Shot**
Simply select the sample scene that matches the type of image you are trying to record and the camera performs troublesome setups automatically for beautiful pictures every time.
- **Coupling Shot and Pre-shot**
Coupling Shot lets you combine two subjects into a single image, while Pre-shot lets you add a subject to a previously recorded background image. This means you can create images that include you and your friend, even if you are the only two people around. You can use Coupling Shot and Pre-shot by selecting the applicable sample images in the Best Shot mode.
- **Triple Self-timer mode**
The self-timer can be set up to repeat three times, automatically.
- **Real-time histogram**
An on-screen histogram lets you adjust exposure as you view the effect on overall image brightness, which makes shooting under difficult lighting conditions easier than ever before.
- **World Time**
A simple operation sets the current time for your current location. You can select from among 162 cities in 32 time zones.

INTRODUCTION

- **Alarm**
A built-in alarm helps to keep you on time for important events, and even can be used in place of an alarm clock. You can also have a specific image appear on the monitor screen when the alarm time is reached.
- **Album Function**
HTML files are generated automatically to create an album of recorded images. Album contents can be viewed and printed using a standard Web browser. Images can also be incorporated into Web pages quickly and easily.
- **Calendar screen**
A simple operation displays a full-month calendar on the camera's monitor screen. Each day of the full-month calendar shows a thumbnail of the first image recorded for that date, which helps to make searching for a particular image quicker and easier.
- **Movie mode with audio**
- **DCF Data Storage**
DCF (Design rule for Camera File system) data storage protocol provides image inter-compatibility between the digital camera and printers.
- **Digital Print Order Format (DPOF)**
Images can be printed easily in the sequence you want using a DPOF compatible printer. DPOF can also be used when specifying images and quantities for printing by professional print services.
- **PRINT Image Matching II Compatible**
Images include PRINT Image Matching II data (mode setting and other camera setup information). A printer that supports PRINT Image Matching II reads this data and adjusts the printed image accordingly, so your images come out just the way you intended when you recorded them.
- **USB DIRECT-PRINT support**
Your camera supports USB DIRECT-PRINT, which was developed by Seiko Epson Corporation. When connected directly to a printer that supports USB DIRECT-PRINT, you can select images to print and start the print operation directly from the camera.
- **Bundled with Photo Loader and Photohands**
Your camera comes bundled with Photo Loader, the popular application that automatically loads images from your camera to your PC. It also comes with Photohands, and application that makes image retouching quick and easy.

Precautions

General Precautions

Be sure to observe the following important precautions whenever using the EX-Z3.

All references in this manual to “this camera” and “the camera” refer to the CASIO EX-Z3 Digital Camera.

- Never try to take pictures or use the built-in display while operating a motor vehicle or while walking. Doing so creates the danger of serious accident.
- Never try to open the case of the camera or attempt your own repairs. High-voltage internal components create the risk of electric shock when exposed. Always leave maintenance and repair work up to a CASIO authorized service center.
- Never look at the sun or any other bright light through the camera's viewfinder. Doing so can damage your eyesight.
- Keep the small parts and accessories of this camera out of the reach of small children. If swallowed accidentally, contact your physician immediately.
- Never fire the flash in the direction of a person operating a motor vehicle. Doing so can interfere with the driver's vision and create the danger of accident.

- Never fire the flash while it is too close to the subject's eyes. Intense light from the flash can cause eye damage if it is fired too close to the eyes. This is especially true with young children. When using the flash, the camera should be at least one meter (3.3') from the eyes of the subject.
- Keep the camera away from water and other liquids, and never let it get wet. Moisture creates the danger of fire and electric shock. Never use the camera outdoors in the rain or snow, at the seashore or beach, in the bathroom, etc.
- Should foreign matter or water ever get into the camera, immediately turn it off. Next, remove the camera's battery and/or unplug the AC adaptor power cord from the power outlet, and contact your dealer or nearest CASIO authorized service center. Using the camera under these conditions creates the danger of fire and electric shock.
- Should you ever notice smoke or a strange odor coming out of the camera, immediately turn it off. Next, taking care you do not burn your fingers, remove the camera's battery and/or unplug the AC adaptor power cord from the power outlet, and contact your dealer or nearest CASIO authorized service center. Using the camera under these conditions creates the danger of fire and electric shock. After making sure there is no more smoke coming from the camera, take it to your nearest CASIO authorized service center for repair. Never attempt your own maintenance.

INTRODUCTION

- Never use the AC adaptor to power any other device besides this camera. Never use any other AC adaptor besides the one that comes with this camera.
- Never cover the AC adaptor with a quilt, blanket, or other cover while it is in use, and do not use it near a heater.
- At least once a year, unplug the AC adaptor power cord from the power outlet and clean the area around the prongs of the plug. Dust build up around the prongs can create the danger of fire.
- If the camera's case should ever become cracked due to dropping it or otherwise subjecting it to rough treatment, immediately turn it off. Next, remove the camera's battery and/or unplug the AC adaptor power cord from the power outlet, and contact your dealer or nearest CASIO authorized service center.
- Never use the camera inside of an aircraft or in any other areas where its use is prohibited. Doing so can result in an accident.
- Physical damage and malfunction of this camera can cause the data stored in its memory to be deleted. Be sure to always keep backup copies of data by transferring them to personal computer memory.
- Never open the battery cover, disconnect the AC adaptor from the camera, or unplug the AC adaptor from the wall socket while recording images. Doing so will not only make storage of the current image impossible, it can also corrupt other image data already stored in file memory.

Data Error Precautions

- Your digital camera is manufactured using precision digital components. Any of the following creates the risk of corruption of data in file memory.
 - Removing the battery or memory card, or setting the camera onto the USB cradle while the camera is performing a record or memory access operation
 - Removing the battery, removing the memory card, or placing the camera onto the USB cradle while the operation lamp is still flashing after you turn off the camera
 - Disconnecting the USB cable, removing the camera from the USB cradle, or disconnecting the AC adaptor from the USB cradle while a data communication operation is being performed
 - Low battery power
 - Other abnormal operations

Any of the above conditions can cause an error message to appear on the monitor screen (page 162). Follow the instructions provided by the message to eliminate the cause of the error.

Operating conditions

- This camera is designed for use in temperatures ranging from 0°C to 40°C (32°F to 104°F).
- Do not use or keep the camera in the following areas.
 - In areas subject to direct sunlight
 - In areas subject to high humidity or dust
 - Near air conditioners, heaters, or other areas subject to temperature extremes
 - Inside of a closed vehicle, especially one parked in the sun
 - In areas subject to strong vibration

Condensation

- When you bring the camera indoors on a cold day or otherwise expose it to a sudden change of temperature, there is the possibility that condensation can form on the exterior or on interior components. Condensation can cause malfunction of the camera, so you should avoid exposing it to conditions that might cause condensation.
- To keep condensation from forming, place the camera into a plastic bag before moving it into a location that is much warmer or colder than your current location. Leave it in the plastic bag until the air inside the bag has a chance to reach the same temperature as the new location. If condensation does form, remove the battery from the camera and leave the battery cover open for a few hours.

LED Backlight

- The monitor screen is illuminated by an LED backlight. A dark monitor screen indicates that the LED backlight has reached the end of its service life, and needs to be replaced by a CASIO authorized service center. Note that you will be charged for LED backlight replacement. The LED backlight brightness is reduced by half after about 1,000 hours of use.

Lens

- Never apply too much force when cleaning the surface of the lens. Doing so can scratch the lens surface and cause malfunction.
- Fingerprints, dust, or any other soiling of the lens can interfere with proper image recording. Never touch the lens with your fingers. You can remove dust particles from the lens surface by using a lens blower to blow them off. Next, wipe the surface of the lens with a soft lens cloth.

Other

- The camera may become slightly warm during use. This does not indicate malfunction.
- If the exterior of the camera needs cleaning, wipe it with a soft, dry cloth.

QUICK START GUIDE

First, charge the battery!

1. Load the battery (page 25).

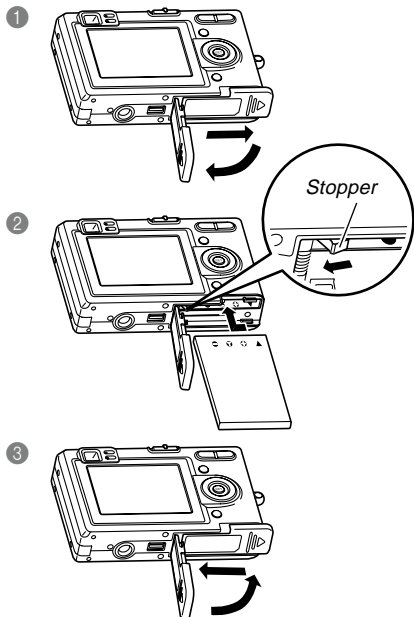

2. Place the camera onto the USB cradle to charge the battery (page 27).

- Note that the shape of the AC adaptor depends on the area where you purchased the camera.
- It takes about two hours to achieve a full charge.

1 Inlet Type

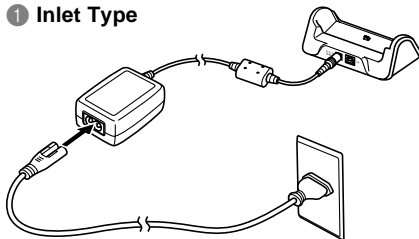

2

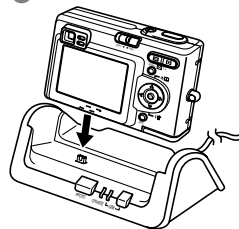

1 Plug-in Type

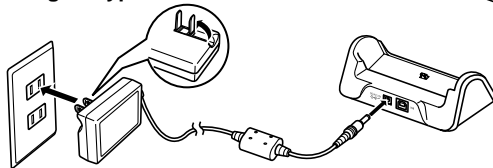

To configure display language and clock settings

- Be sure to configure the following settings before using the camera to record images. (See page 39 for details.)

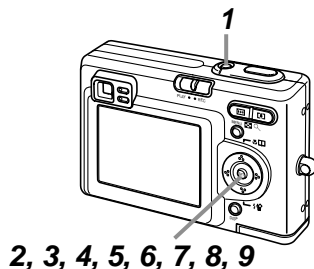

1. Press the power button to turn on the camera.
2. Press [▲] to select the language you want.
3. Press [SET] to register the language setting.
4. Use [▲], [▼], [◀], and [▶] to select the geographical area you want, and then press [SET].
5. Use [▲] and [▼] to select the city you want, and then press [SET].
6. Use [▲] and [▼] to select the summer time (DST) setting you want, and then press [SET].
7. Use [▲] and [▼] to select the date format setting you want, and then press [SET].
8. Set the date and the time.
9. Press [SET] to register the clock settings and exit the setting screen.

To record an image

(See page 43 for details.)

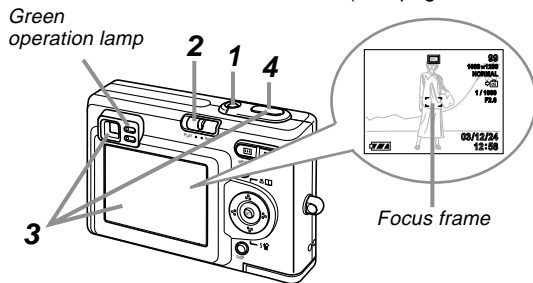

1. Press the power button to turn on the camera.
2. Align the mode selector with “REC”.
3. Point the camera at the subject, use the monitor screen or viewfinder to compose the image, and then press the shutter release button half way.
 - When proper focus is achieved, the focus frame turns green and the green operation lamp lights.
4. Holding the camera still, gently press the shutter release button.

To view a recorded image

(See page 80 for details.)

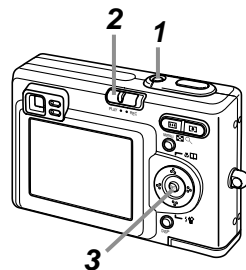

1. Press the power button to turn on the camera.
2. Align the mode selector with “PLAY”.
3. Use [◀] and [▶] to scroll through the images.

To delete an image

(See page 94 for details.)

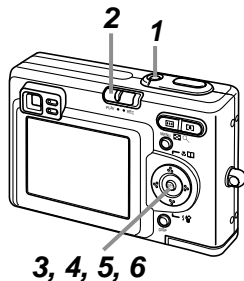

- 1. Press the power button to turn on the camera.**
- 2. Align the mode selector with “PLAY”.**
- 3. Press [▼] (⏪).**
- 4. Use [◀] and [▶] to display the image you want to delete.**
- 5. Use [▲] and [▼] to select “Delete”.**
 - To exit the image delete operation without deleting anything, select “Cancel”.
- 6. Press [SET] to delete the image.**

GETTING READY

This section contains information about things you need to know about and do before trying to use the camera.

About This Manual

This section contains information about the conventions used in this manual.

Terminology

The following table defines the terminology used in this manual.

| This term as used in this manual: | Means this: |
|-----------------------------------|--|
| "this camera" or "the camera" | The CASIO EX-Z3 Digital Camera |
| "file memory" | The location where the camera is currently storing images you record (page 43) |
| "battery" | The NP-20 Rechargeable Lithium Ion Battery |
| "optional charger unit" | The optionally available CASIO BC-10L Charger Unit |

Button Operations

Button operations are indicated by the button name inside of brackets ([]).

On-screen Text

On-screen text is always enclosed by double quotation marks (" ").

File Memory

The term "file memory" in this manual is a general term that refers to the location where your camera is currently storing the images you record. File memory can be any one of the following three locations.

- The camera's built-in Flash memory
- An SD memory card loaded in the camera
- A MultiMediaCard loaded in the camera

For more information about how the camera stores images, see page 118.

General Guide

The following illustrations show the names of each component, button, and switch on the camera.

Camera

■ Front

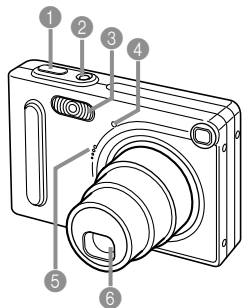

- 1 Shutter release button
- 2 Power button
- 3 Flash
- 4 Self-timer lamp
- 5 Microphone
- 6 Lens

■ Back

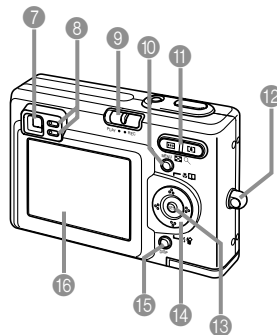

- 7 Viewfinder
- 8 Operation lamp
- 9 Mode selector
- 10 [MENU] button
- 11 Zoom button
- 12 Strap ring
- 13 [SET] button
- 14 [▲][▼][◀][▶]
- 15 [DISP] button
- 16 Monitor Screen

GETTING READY

Bottom

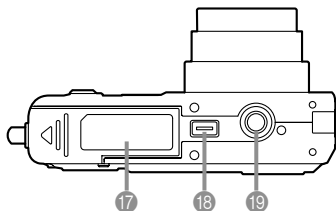

- 17 Battery cover
- 18 Connector
- 19 Tripod screw hole

* Use this hole when attaching to a tripod.

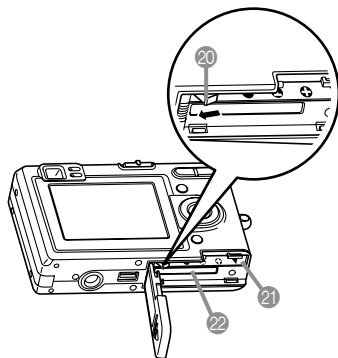

- 20 Stopper
- 21 Battery compartment
- 22 Memory card slot

USB Cradle

Simply placing your CASIO digital camera onto the USB cradle lets you perform the following tasks.

- Battery charging (page 27)
- Automatic transfer of images to a computer (page 124)
- Viewing of images using the Photo Stand slideshow feature (page 92).

Front

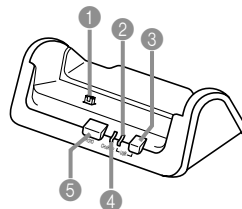

- 1 Camera connector
- 2 [USB] lamp
- 3 [USB] button
- 4 [CHARGE] lamp
- 5 [PHOTO] button

Back

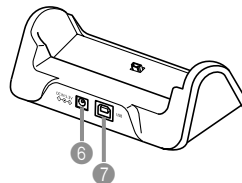

- 6 [DC IN 5.3V]
(AC adaptor connector)
- 7 [USB]
(USB port)

Monitor Screen Contents

The monitor screen uses various indicators and icons to keep you informed of the camera's status.

REC mode

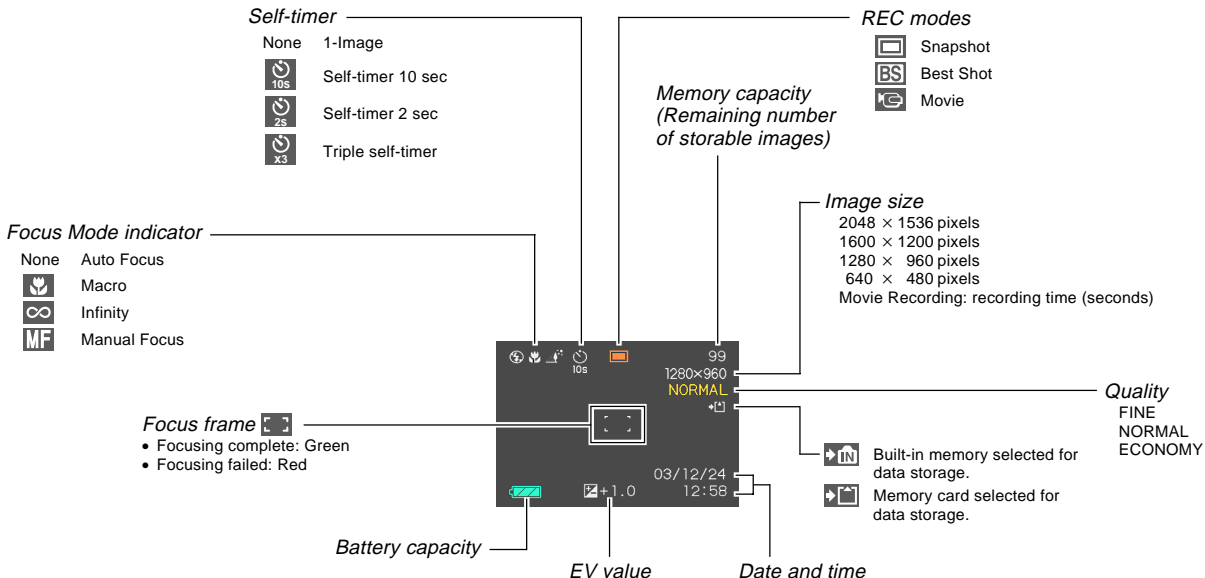

GETTING READY

White balance indicator

| | |
|------|-------------|
| None | Auto |
| | Sunlight |
| | Shade |
| | Light Bulb |
| | Fluorescent |
| | Manual |

Digital zoom indicator

Shutter speed value

- An out of range aperture or shutter speed causes the corresponding monitor screen value to turn amber.

Aperture value

ISO sensitivity

Flash Mode indicator

| | |
|------|-------------------|
| None | Auto |
| | Flash Off |
| | Flash On |
| | Red-eye reduction |

Zoom indicator

Left side indicates optical zoom.
Right side indicates digital zoom.

Flash Mode indicator

- If the camera detects that flash is required while auto flash is selected, the flash on indicator will appear when the shutter release button is pressed half way.

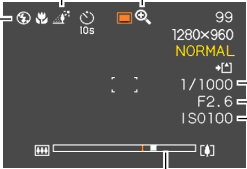

PLAY mode

Folder number/ File number

Image protection indicator

PLAY mode file type

| | |
|--|----------|
| | Snapshot |
| | Movie |

Image size

| |
|--------------------|
| 2048 × 1536 pixels |
| 1600 × 1200 pixels |
| 1280 × 960 pixels |
| 640 × 480 pixels |

Quality

| |
|---------|
| FINE |
| NORMAL |
| ECONOMY |

Built-in memory selected for data storage.

Memory card selected for data storage.

Date and time

Battery capacity

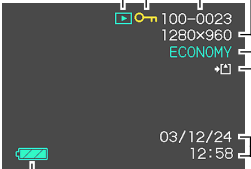

IMPORTANT!

- Some information may not display properly if you display an image that was recorded using a different digital camera model.

Changing the Contents of the Monitor Screen

Each press of the [DISP] button changes the contents of the monitor screen as shown below.

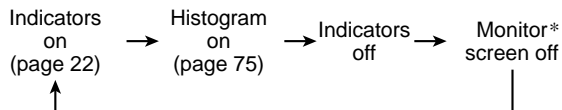

* You cannot turn off the monitor screen in the following modes: PLAY mode, Best Shot mode, Movie mode, Macro mode.

Indicator Lamps

You can find out the operational status of the camera and the USB cradle at a glance by checking the color of the indicator lamps, and whether a lamp is lit or flashing. For details, see “Indicator Lamp Reference” on page 156.

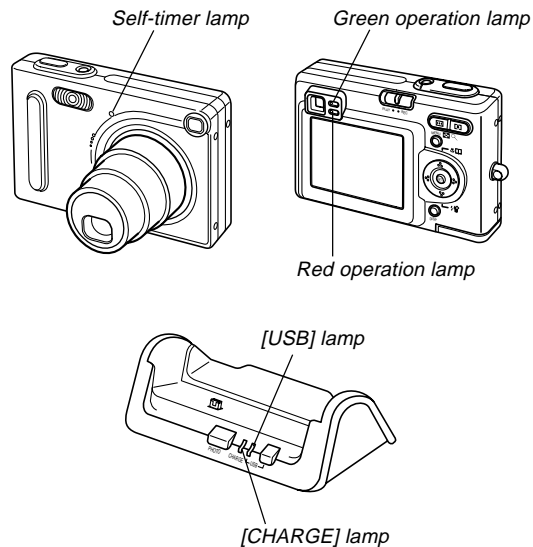

Attaching the Strap

Attach the strap to the strap ring as shown in the illustration.

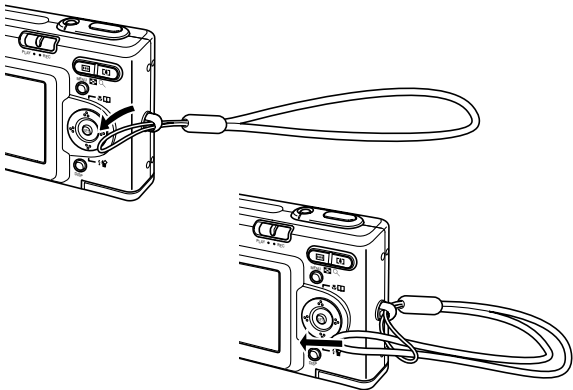

►► IMPORTANT! ◀◀

- Be sure to keep the strap around your wrist when using the camera to protect against accidentally dropping it.
- The supplied strap is intended for use with this camera only. Do not use it for any other purpose.
- Never swing the camera around by the strap.

Power Requirements

Your camera is powered by a rechargeable lithium ion battery (NP-20).

To load the battery

1. While pressing the battery cover on the bottom of the camera, slide the cover in the direction indicated by the arrow, and then swing it open.

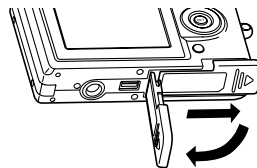

GETTING READY

2. While pulling the stopper in the direction indicated by the arrow in the illustration, align the arrow mark on the battery with the arrow mark on the camera and slide the battery into the camera.

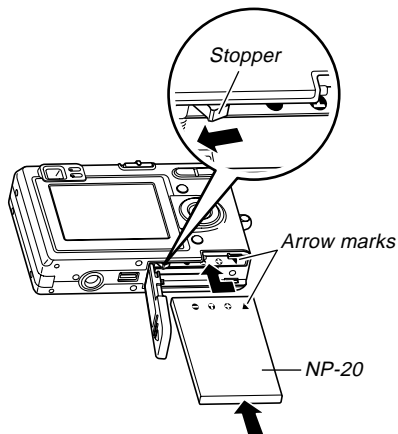

- Push the bottom of the battery, and make sure that the stopper securely locks the battery in place.

3. Swing the battery cover closed, and then slide it in the direction indicated by the arrow.

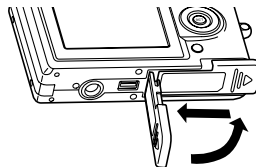

►► IMPORTANT! ◀◀

- Use only the special NP-20 rechargeable lithium ion battery to power this camera. Use of any other type of battery is not supported.

The battery is not charged when you purchase the camera. You need to charge the battery before using the camera for the first time (page 27).

To remove the battery

1. Open the battery cover.
2. Pull the stopper in the direction indicated by the arrow.
 - This will cause the battery to come part way out of the slot.

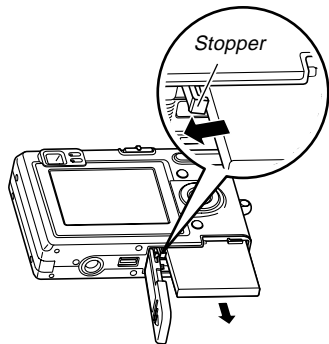

3. Release the stopper and pull the battery from the camera.
 - Take care so you do not drop the battery.

To charge the battery

1. Connect the bundled AC adaptor to the [DC IN 5.3V] connector of the USB cradle, and then plug it in to a household power outlet.
 - Note that the shape of the AC adaptor depends on the area where you purchased the camera.

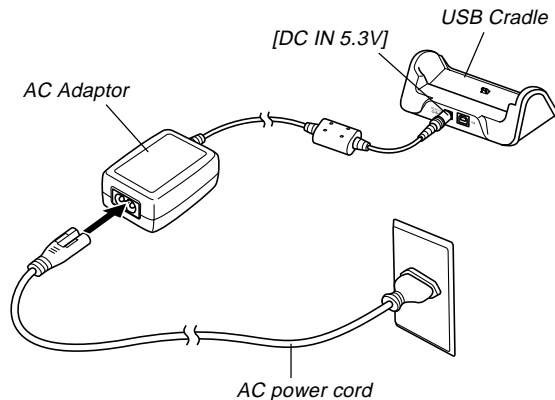

GETTING READY

NOTE

- The bundled AC adaptor is designed for operation with any power supply in the range of 100V to 240V AC. Note, however, that the shape of the AC power cord plug varies according to country or geographic area. If you plan to use the AC adaptor in a geographic area where the power receptacle shape is different from that in your area, replace the AC power cord with one of the other ones that comes with the camera, or purchase a commercially available AC power cord that is compatible with the power outlets in that area.

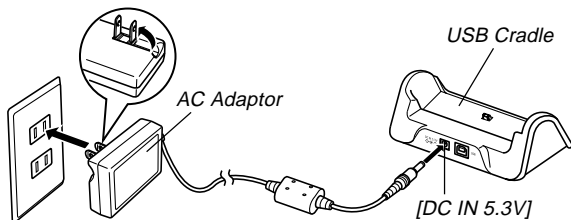

NOTE

- The AC adaptor is designed for operation on power ranging from 100V AC to 240V AC. Note, however, that the shape of the power cord plug varies according to country or geographic area. It is up to you to find out if the shape of the AC adaptor power cord plug is compatible with local power outlets when traveling abroad.

2. Turn off the camera.

3. Set the camera onto the USB cradle.

- Do not place the camera onto the USB cradle while it is turned on.
- The [CHARGE] lamp on the USB cradle should turn red, indicating that charging has started. When charging is complete, the [CHARGE] lamp will turn green.

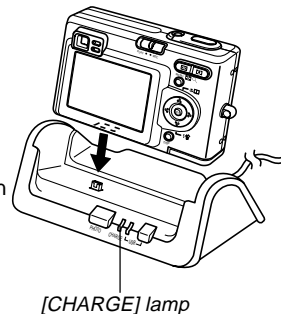

4. After charging is complete, remove the camera from the USB cradle.

GETTING READY

▶▶ IMPORTANT! ◀◀

- It takes about two hours to achieve a full charge. Actual charging time depends on current battery capacity and charging conditions.
 - Use only the USB cradle (CA-21) or the optionally available charger unit (BC-10L) to charge the special NP-20 rechargeable lithium ion battery. Never use any other charging device.
 - Use only the bundled AC adaptor. Never use any other type of AC adaptor. Do not use optionally available AD-C40, AD-C620 and AD-C630 AC adaptors with this camera.
 - Make sure that the camera connector of the USB cradle is securely inserted into the camera's connector as far as it will go.
 - The [CHARGE] lamp may remain amber colored and the charge operation may not start right away if you try to charge immediately after using the camera (which causes battery to become warm) or when it is too hot or too cold where you are performing the charge operation. If this happens, simply wait until the battery reaches normal temperature. The [CHARGE] lamp will turn red and charging will start when the battery temperature returns to the allowable charging temperature range.
- If the [CHARGE] lamp starts flashing red, it means that an error occurs while charging. An error can be caused by any of the following: a problem with the USB cradle, a problem with the camera, or a problem with the battery or how it is loaded. Remove the camera from the USB cradle and see if it works normally.
 - You can use the USB cradle to charge the camera's battery, to exchange data with a computer over a USB connection, or when using the Photo Stand feature only.

■ If the camera works normally

1. **Continue using the camera until the current charge is used up, and then charge the battery.**

■ If the camera does not work normally

This can mean there is a problem with how the battery is loaded.

1. **Remove the battery from the camera and check the battery contacts for dirt. If the contacts are dirty, wipe them clean with a dry cloth.**
2. **Check to make sure that the AC adaptor's power cord is connected securely to the power outlet and USB cradle.**
 - If the same symptoms occur again when you place the camera on the USB cradle after taking the above steps, contact a CASIO authorized service center.

■ Battery Life Guidelines

The battery life guideline values given below indicate the amount of time at standard temperature (25°C (77°F)) until power automatically turns off due to battery failure. They do not guarantee that the battery will provide the amount of service indicated. Low temperatures and continued use reduce battery life.

| Operation | Approximate Battery Life |
|---|--------------------------|
| Continuous Recording* ¹ (Continuous Snapshot Recording) | 75 minutes (450 shots) |
| Continuous Playback* ² | 120 minutes |

Supported Battery: NP-20 (Rated Capacitance: 680mAh)

*1 Continuous Recording Conditions

- Normal temperature: 25°C (77°F)
- Flash: Off
- Monitor screen: On
- Image recorded about every 10 seconds using the following operations: Zoom to full wide angle → Auto Focus → Zoom to full close-up → Auto Focus → Image recording

*2 Continuous Playback Conditions

- Normal temperature: 25°C (77°F)
- Scroll one image about every 10 seconds



GETTING READY





- Recording one image per minute under the above conditions reduces battery life to about one sixth of that noted above.
- The above values are based a new battery starting from a full charge. Repeated charging shortens battery life.
- Battery life is greatly affected by how much you use flash, zoom and other functions, and how long you leave power turned on.

■ Tip to Make the Battery Last Longer

If you do not need the flash while recording, select  (flash off) for the flash mode. See page 50 for more information.

■ Low Battery Indicator

The following shows how the battery capacity indicator on the monitor screen changes as battery power is used. The  indicator means that remaining battery power is low. Note that you will not be able to record images while the battery indicator is . Charge the battery immediately whenever either of these indicators appears.

| | |
|---------------|--|
| Battery Level | High ←————→ Low |
| Indicator |  →  →  →  |

Power Supply Precautions

Note the following precautions when handling or using the battery and the optional charger unit.

■ Battery Handling Precautions

● SAFETY PRECAUTIONS

Be sure to read the following Safety Precautions before trying to use the battery for the first time. Keep these safety precautions and all operating instructions on hand for future reference.

))) NOTES ((

- The term “battery” in this manual refers to the CASIO NP-20 Rechargeable Lithium Ion Battery.
- The term “optional charger unit” in the following precautions refers to the optionally available CASIO BC-10L Charger Unit.

- Failure to observe any of the following precautions while using the battery creates the risk of overheating, fire, and explosion.
 - Never use any other type of charger except the optional charger unit specified for the battery.
 - Never try to use the battery to power any other device other than this camera.
 - Never use or leave the battery near open flame.
 - Never place the battery in a microwave oven, throw it into fire, or otherwise expose it to intense heat.
 - Make sure the battery is oriented correctly when you load it into the camera or attach it to the optional charger unit.
 - Never carry or store the battery together with items that can conduct electricity (necklaces, pencil lead, etc.)
 - Never try to take the battery apart, modify it in any way, or expose it to strong impact.
 - Do not immerse the battery in fresh water or salt water.
 - Do not use or leave the battery under direct sunlight, in an automobile parked in the sun, or in any other area subject to high temperatures.

GETTING READY

- Should you ever notice leakage, strange odor, heat generation, discoloration, deformation, or any other abnormal condition while using, charging, or storing a battery, immediately remove it from the camera or optional charger unit and keep it away from open flame.
- If the battery does not achieve full charge after the normal charging time has passed, stop charging. Continued charging creates the risk of overheating, fire, and explosion.
- Battery fluid can damage your eyes. Should battery fluid get into your eyes accidentally, immediately rinse them with clean tap water and then consult a physician.
- Be sure to read page 27 of this User's Guide and the instructions that come with the optional charger unit before using or charging the battery.
- If the battery is to be used by young children, make sure that a responsible adult makes them aware of the precautions and proper handling instructions and make sure that they handle the battery correctly.
- Should fluid from the battery accidentally get onto clothing or your skin, immediately rinse it off with clean tap water. Prolonged contact with battery fluid can cause skin irritation.

● PRECAUTIONS DURING USE

- The battery is designed for use with this CASIO digital camera only.
- Use only the USB cradle that comes with the camera or the specified optional charger unit to charge the battery. Never use any other type of charger unit for charging.
- A new battery is not charged. Be sure to charge the battery before using it for the first time.
- Use of a battery in cold environments shortens the operating time you can expect on a full charge. Charge the battery in a location where the temperature is in the range of 10°C to 35°C (50°F to 95°F). Charging outside this temperature range can cause charging to take longer than normal or even cause charging to fail.
- Very limited operation following a full charge indicates that the battery has reached the end of its service life. Replace the battery with a new one.
- Never wipe the battery with thinner, benzene, alcohol, or other volatile agents or chemically treated rags. Doing so can cause deformation of the battery and lead to malfunction.

● BATTERY STORAGE PRECAUTIONS

- Make sure you remove the battery when you do not plan to use the camera for a long time. A battery left in the camera discharges very small amounts of power even when power is turned off, which can lead to a dead battery or the need for longer charging before the next use.
- Store the battery in a cool, dry place (20°C (68 °F) or lower).

● USING THE BATTERY

- See page 27 of this manual or the instructions that come with the optional charger unit for information about charging procedures and charging times.
- When transporting a battery, keep it either loaded in the camera or stored in its case.

■ USB Cradle and AC Adaptor Precautions



- Never use an electrical outlet whose voltage is outside the rating marked on the AC adaptor. Doing so can create the danger of fire or electric shock. Use only the bundled AC adaptor specified for this camera.
- Do not allow the AC adaptor cord to become cut or damaged, do not place heavy objects on it, and keep it away from heat. A damaged power cord creates the risk of fire and electric shock.
- Never try to modify the AC adaptor cord, or subject it to severe bending, twisting, or pulling. Doing so creates the risk of fire and electric shock.
- Never touch the AC adaptor while your hands are wet. Doing so creates the risk of electric shock.
- Do not overload extension cords or wall outlets. Doing so creates the danger of fire and electric shock.
- Should the cord of the AC adaptor become damaged (exposed internal wiring), request a replacement from a CASIO authorized service center. A damaged AC adaptor cord creates the danger of fire or electric shock.

GETTING READY

- Make sure you always remove the camera from the USB cradle before connecting or disconnecting the AC adaptor.
- Charging, USB data communication, and using the Photo Stand feature can cause the AC adaptor to become warm. This is normal and does not indicate malfunction.
- Unplug the AC power cord from the power outlet whenever you are not using it.
- Never place a blanket or any other cover on the AC adaptor. Doing so creates the risk of fire.

Turning the Camera On and Off

Press the power button to turn the camera on and off. Pressing the power button to turn on the camera causes the green operation lamp to light temporarily. Press the power button again to turn off the camera.

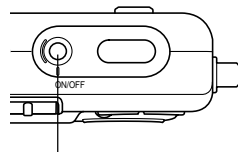

Power button

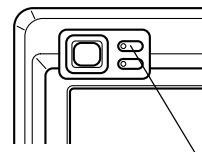

Green operation lamp

»» IMPORTANT! ««

- If camera power is turned off by the Auto Power Off feature, press the power button to turn it back on again.
- Turning on camera power while the REC mode is selected by the mode selector causes the lens to extend from the camera. Make sure there is nothing in front of the camera that can be hit by the lens when you turn on the camera.

Configuring Power Saving Settings

You can configure the settings described below to conserve battery power.

Sleep : Automatically turns off the monitor screen if no operation is performed for a specified amount of time in the REC mode.

Performing any button operation causes the monitor screen to turn back on.

Auto Power Off : Turns off power if you do not perform any operation for a specified amount of time.

1. Turn on the camera, and then align the mode selector with “REC” or “PLAY”.
2. Press [MENU].
3. Use [◀] and [▶] to select the “Set Up” tab.
4. Use [▲] and [▼] to select the feature whose setting you want to configure, and then press [SET].

- See page 37 for information about how to use menus.

| To configure this feature: | Select this setting: |
|----------------------------|----------------------|
| Sleep | Sleep |
| Auto Power Off | Auto Power Off |

5. Use [▲] and [▼] to change the currently selected setting, and then press [SET].

- Available Sleep settings are: “30 sec”, “1 min”, “2 min”, and “Off”.
- Available Auto Power Off settings are: “2 min” and “5 min”.
- Note that the Sleep feature does not operate in the PLAY mode.
- Pressing any button while the camera is in the Sleep state immediately turns the monitor screen back on.
- The Auto Power Off and Sleep features are disabled in the following cases.
 - When the camera is connected to a computer or some other device through the USB cradle
 - While a slideshow is in progress

Using the On-screen Menus

Pressing [MENU] displays menus on the monitor screen that you can use to perform various operations. The menu that appears depends on whether you are in the REC mode or the PLAY mode. The following shows an example menu procedure in the REC mode.

1. Turn on the camera, and then align the mode selector with "REC" to enter the REC mode.

- If you want to enter the PLAY mode instead, you would align the mode selector with "PLAY".

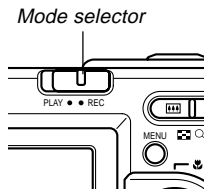

2. Press [MENU].

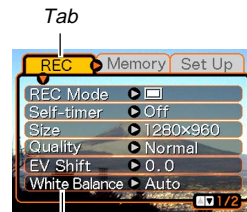
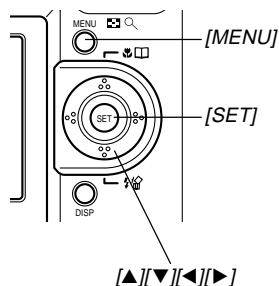

Settings

Selection cursor (indicates the currently selected item)

GETTING READY

● Menu Screen Operations

| When you want to do this: | Do this: |
|--|---------------------------|
| Move between tabs | Press [◀] and [▶]. |
| Move from the tab to the settings | Press [▼]. |
| Move from the settings to the tab | Press [▲]. |
| Move between the settings | Press [▲] and [▼]. |
| Display the options available for a setting | Press [▶] or press [SET]. |
| Select an option | Press [▲] and [▼]. |
| Register an option selection and exit the menu screen | Press [SET]. |
| Register an option selection and return to the menu screen | Press [◀]. |
| Exit the menu screen | Press the [MENU] button. |

3. Press [◀] or [▶] to select the tab you want, and then press [SET] to move the selection cursor from the tab to the settings.

4. Use [▲] and [▼] to select the feature whose setting you want to configure, and then press [▶].

- Instead of pressing [▶], you could also press [SET].



Example: To select the "REC Mode" item.

5. Use [▲] and [▼] to change the currently selected setting.

6. Perform one of the following operations to apply the setting you configured.

| To do this: | Perform this key operation: |
|--|---|
| Apply the setting and exit the menu screen. | Press [SET]. |
| Apply the setting and return to feature selection in step 4. | Press [◀]. |
| Apply the setting and return to tab selection in step 3. | 1. Press [◀]. 2. Use [▲] to move back up to tab selection. |

- See “Menu Reference” on page 154 for more information about menus.

Configuring Display Language and Clock Settings

Be sure to configure the following settings before using the camera to record images.

- Display language
- Home city
- Date Style
- Date and time

Note that the current date and time settings are used by the camera to generate the date and time that are stored along with image data, etc.

▶▶ IMPORTANT! ◀◀

- The camera's clock settings are cleared whenever power is totally cut off. This can happen if the battery goes dead while the camera is not being supplied power by the USB cradle. The clock setting screen will appear automatically the next time you turn on power after the settings are cleared. Set the date and time before using the camera.
- The current date and time settings will be cleared if the battery remains dead without being charged for about two days.
- Recording images without configuring the clock settings causes incorrect time information to be registered. Be sure to configure the clock settings before using the camera.

To configure display language and clock settings

1. Press the power button to turn on the camera.
2. Use [▲], [▼], [◀], and [▶] to select the language you want, and then press [SET].



日本語 : Japanese

English : English

Français : French

Deutsch : German

Español : Spanish

Italiano : Italian

Português : Portuguese

中國語 : Chinese (Complex)

中国語 : Chinese (Simplified)

한국어 : Korean

GETTING READY

3. Use [▲], [▼], [◀], and [▶] to select the geographical area where you live, and then press [SET].



4. Use [▲] and [▼] to select the name of the city where you live, and then press [SET].



5. Use [▲] and [▼] to select the summer time (DST) setting you want, and then press [SET].

| When you want to do this: | Select this setting: |
|--|----------------------|
| Keep time using summer time (Daylight Saving Time) | On |
| Keep time using standard time | Off |

6. Use [▲] and [▼] to change the date format setting, and then press [SET].

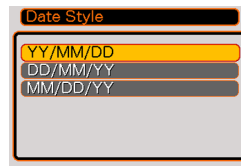

Example: October 23, 2003

| To display the date like this: | Select this format: |
|--------------------------------|---------------------|
| 03/10/23 | YY/MM/DD |
| 23/10/03 | DD/MM/YY |
| 10/23/03 | MM/DD/YY |

7. Set the current date and the time.

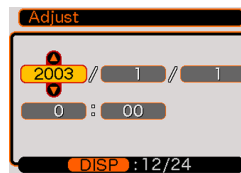

| To do this: | Do this: |
|---|--------------------|
| Change the setting at the current cursor location | Press [▲] and [▼]. |
| Move the cursor between settings | Press [◀] and [▶]. |
| Toggle between 12-hour and 24-hour timekeeping | Press [DISP]. |

8. Press [SET] to register the settings and exit the setting screen.

BASIC IMAGE RECORDING

This section describes the basic procedure for recording an image.

Recording an Image

Your camera automatically adjusts shutter speed in accordance with the brightness of the subject. Images you record are stored in the camera's built-in memory, or to a memory card if you have one loaded in the camera.

- When an optionally available SD memory card or MultiMediaCard (MMC) is loaded in the camera, images are stored on the card (page 118).

1. Press the power button to turn on the camera.

- This causes an image or a message to appear on the monitor screen.

Power button

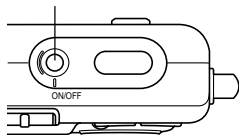

2. Align the mode selector with "REC".

- This enters the REC mode for image recording.

Mode selector

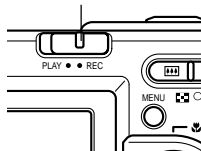

3. Compose the image on the monitor screen so the main subject is within the focus frame.

- The focusing range of the camera in the Auto Focus mode is approximately 40cm (1.3 feet) to infinity (∞) (page 57).
- You can compose images using either the monitor screen or the optical viewfinder (page 47).
- When using the optical viewfinder to compose images, you can use the [DISP] button to turn off the monitor screen and conserve battery power.

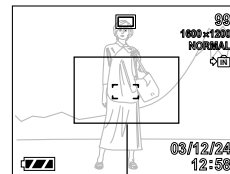

Focus frame

BASIC IMAGE RECORDING

4. Press the shutter release button half way to focus the image.

- When you press the shutter release button half way, the camera's Auto Focus feature automatically focuses the image, and displays the shutter speed and aperture values.
- You can tell whether the image is focused by observing the focus frame and the green operation lamp.

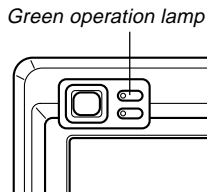
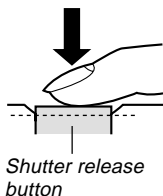

● Operation Lamp and Focus Frame Operation

| When you see this: | It means this: |
|--|----------------------------|
| Green focus frame Green operation lamp | The image is in focus. |
| Red focus frame Flashing green operation lamp | The image is not in focus. |

- Make sure you are not blocking the lens or the flash with your fingers while recording an image.

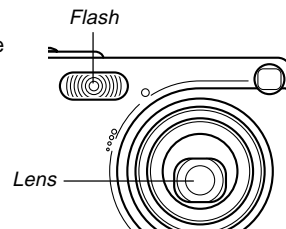

5. After making sure that the image is focused properly, press the shutter release button the rest of the way down to record.

- The number of images that can be stored in memory depends on the resolution setting you are using (page 164).
- Press the shutter release button gently to avoid camera movement.

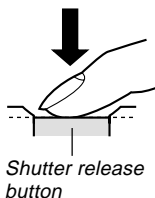

Recording Precautions

- Never open the battery cover or place the camera onto the USB cradle while the green operation lamp is flashing. Doing so not only causes the current image to be lost, it can also corrupt images already stored in file memory and even lead to malfunction of the camera.
- Never remove the memory card while an image is being recorded to the memory card.
- Fluorescent lighting actually flickers at a frequency that cannot be detected by the human eye. When using the camera indoors under such lighting, you may experience some brightness or color problems with recorded images.
- When "Auto" is selected for the ISO sensitivity setting (page 76), the camera automatically adjusts its sensitivity in accordance with the brightness of the subject. This can cause some static noise to appear in images of relatively dark subjects.
- When recording a dimly lit subject while "Auto" is selected for the ISO sensitivity setting (page 76), the camera increases sensitivity and uses a slower shutter speed. Because of this, you need to guard against camera movement if you have flash turned off (page 50).
- If unwanted light is shining on the lens, shade the lens with your hand when recording the image.

About Auto Focus

- Auto Focus tends not to work well if the camera is moved during recording, or when recording the types of subjects listed below.
 - Solid color walls or objects with little contrast
 - Strongly backlit objects
 - Polished metal or other brightly reflective objects
 - Venetian blinds or other horizontally repeating patterns
 - Multiple images that are varying distances from the camera
 - Subjects in poorly lit areas
 - Moving subjects
- Note that a green operation lamp and focus frame do not necessarily guarantee that an image is in focus.
- If Auto Focus does not produce the results you want for some reason, try using focus lock (page 60) or manual focus (page 59).

About the REC Mode Monitor Screen

- The image shown on the monitor screen in the REC mode is a simplified image for composing purposes. The actual image is recorded in accordance with the image quality setting currently selected on your camera. The image saved in file memory has much better resolution and detail than the REC mode monitor screen image.
- Certain levels of subject brightness can cause the response of the REC mode monitor screen to slow down, which causes some static noise in the monitor screen image.

Using the Optical Viewfinder

You can conserve battery power by turning off the camera's monitor screen (page 24) and using the optical viewfinder to compose images.

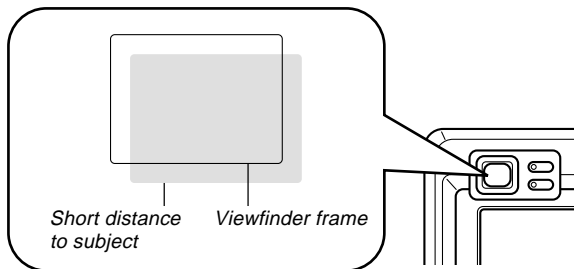

►► IMPORTANT! ◀◀

- The frame that is visible inside of the viewfinder indicates the image recorded at a distance of about one meter (3.3'). When the subject is closer than one meter, the recorded image will be different from what you see inside the viewfinder frame.
- The monitor screen turns on automatically whenever you select the Macro mode or Manual Focus mode. Always use the monitor screen to compose images in these modes.

BASIC IMAGE RECORDING

Using Zoom

Your camera is equipped with two types of zoom: optical zoom and digital zoom.

Optical Zoom



The range of the optical zoom factor is shown below.

Optical Zoom Factor Range: 1X to 3X

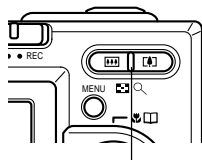
1. In the REC mode, press the zoom button to change the zoom factor.



Zoom button

| To do this: | Press this side of the zoom button: |
|-------------|--|
| Zoom out |  (Wide Angle) |
| Zoom in |  (Telephoto) |

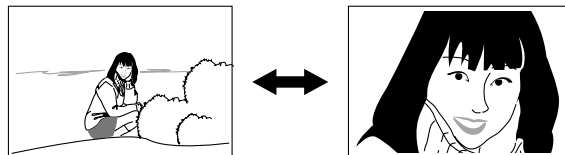

Zoom out

Zoom in

2. Compose the image and then press the shutter release button.

NOTES

- The optical zoom factor also affects the lens aperture.
- Use of a tripod is recommended to protect against hand movement when using the telephoto setting (zoom in).

Digital Zoom

Digital zoom is activated after you reach the maximum optical zoom factor (3X). It enlarges the part of the image at the center of the image screen. The range of the digital zoom factor is shown below.

Digital Zoom Factor Range: 3X to 12X
(in combination with optical zoom)

1. In the REC mode, press [MENU].
2. Use [◀] and [▶] to select the “REC” tab.
3. Use [▲] and [▼] to select “Digital Zoom”, and then press [▶].
4. Select “On”, and then press [SET].
 - Selecting “Off” disables digital zoom.

5. Hold down the [📷] (Telephoto) zoom button to increase the optical zoom factor.

- When the digital zoom factor reaches its maximum value (3X), it stops momentarily. Keep the [📷] (Telephoto) zoom button depressed and zoom will switch over to digital zoom automatically.
- Switching to digital zoom causes the zoom indicator to appear on the monitor screen. The zoom indicator shows the current approximate zoom factor.

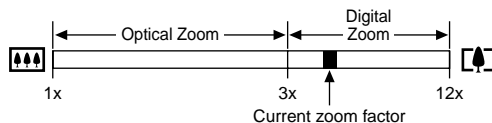
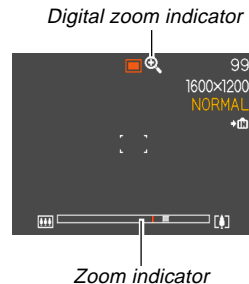

6. Compose the image and then press the shutter release button.

▶▶ IMPORTANT! ◀◀

- Digital zoom is disabled whenever the monitor screen is turned off (page 24).
- Using digital zoom can cause degradation of the recorded image.

Using the Flash

Perform the following steps to select the flash mode you want to use.

1. In the REC mode, press [MENU].

2. Press [▼] (⚡🏠) to select the flash mode.

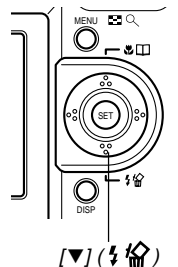

- Each press of [▼] (⚡🏠) cycles through the flash mode settings shown below on the monitor screen.

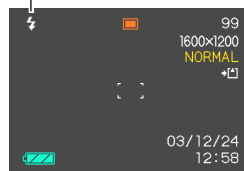

Flash mode indicator



BASIC IMAGE RECORDING

| To do this: | Select this setting: |
|---|---|
| Have the flash fire automatically when required (Auto Flash) | None |
| Turn off the flash (Flash Off) |  |
| Always fire the flash (Flash On) |  |
| Fire a pre-flash followed by image recording with flash, reducing the chance of red-eye in the image (Red-eye reduction) In this case, the flash fires automatically when required |  |

3. Record the image.

»» IMPORTANT! ««

- The flash unit of this camera fires a number of times when you record an image. The initial flashes are pre-flashes, which the camera uses to obtain information that it uses for exposure settings. The final flash is for recording. Make sure that you keep the camera still until the shutter releases.
- Image recording may not be performed if you press the shutter release button while the red operation lamp is flashing.

■ About Red-eye Reduction

Using the flash to record at night or in a dimly lit room can cause red spots inside the eyes of people who are in the image. This is caused when the light from the flash reflects off of the retina of the eye. When red-eye reduction is selected as the flash mode, the camera performs two pre-flash operations, one designed to cause the irises in the eyes of any people in the image to close, and one for the Auto Focus operation. This is followed by another flash operation for actual recording of the image.

»» IMPORTANT! ««

Note the following important points when using red-eye reduction.

- Red-eye reduction does not work unless the people in the image are looking directly at the camera during the pre-flash. Before pressing the shutter release button, call out to the subjects so they all look at the camera while the pre-flash operation is performed.
- Red-eye reduction may not work very well if the subjects are located far away from the camera.

Flash Unit Status

You can find out the current flash unit status by pressing the shutter release button half way and checking the monitor screen and red operation lamp.

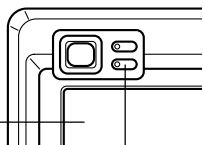

The  indicator is also shown on the monitor screen when the flash unit is ready to fire.

Red operation lamp*



* Red operation lamp

| When the red operation lamp is this: | It means this: |
|--------------------------------------|-----------------------------|
| Flashing | Flash unit is charging |
| Lit | Flash unit is ready to fire |

Flash Precautions

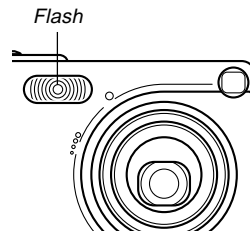
Take care that your fingers do not block the flash when you hold the camera. Covering the flash with your finger can greatly reduce its effectiveness.



- You may not be able to achieve the desired results using a flash if the subject is too close or too far away.
- The flash takes anywhere from a few seconds to as long as 10 seconds to attain full charge after being fired. The actual time required depends on the battery level, temperature, and other conditions.
- The flash does not fire in the Movie mode. This is indicated by  (Flash Off) on the monitor screen.
- The flash unit may not be able to charge when battery power is low. Low battery power is indicated by  (Flash Off) on the monitor screen, and when the flash fails to fire properly resulting in poor image exposure. When these symptoms occur, charge the camera's battery as soon as possible.
- When the red-eye reduction mode () is selected, flash intensity is adjusted automatically in accordance with the exposure. The flash may not fire at all when the subject is brightly lit.

- White balance is fixed while the flash is being used, so sunlight, fluorescent lighting, or other sources of illumination in the immediate area may affect the coloring of the recorded image.

Using the Self-timer

The self-timer lets you select either a 2-second or 10-second delay of the shutter release after you press the shutter release button. A Triple Self-timer feature lets you perform three consecutive self-timer operations to record three images.

- 1. In the REC mode, press [MENU].**
- 2. Use [◀] and [▶] to select the “REC” tab.**
- 3. Use [▲] and [▼] to select “Self-timer”, and then press [▶].**
- 4. Use [▲] and [▼] to select the self-timer time you want to use, and then press [SET].**
 - Selecting “Off” in step 4 disables the self-timer.

BASIC IMAGE RECORDING

| To do this: | Select this setting: |
|--------------------------------|----------------------|
| Specify a 10-second self-timer | 10 sec |
| Specify a 2-second self-timer | 2 sec |
| Specify Triple Self-timer | X3 |
| Disable the self-timer | Off |

- With the Triple Self-timer, the camera records a series of three images in the sequence described below.
 1. The camera performs a 10-second countdown and then records the first image.
 2. The camera prepares to record the next image. The amount of time required for preparation depends on the camera's current "Size" and "Quality" settings, the type of memory (built-in or card) you are using for image storage, and whether or not the flash is charging.
 3. After preparation is complete, the indicator "1sec" appears on the monitor screen, and another image is recorded one second later.
 4. Steps 2 and 3 are repeated once more to record the third image.

5. Record the image.

- When you press the shutter release button, the self-timer lamp flashes and the shutter releases after the self-timer reaches the end of its countdown.
- You can interrupt an ongoing self-timer countdown by pressing the shutter release button while the self-timer lamp is flashing.

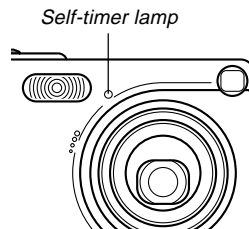

NOTE

- The "2 sec" self-timer setting is best when shooting with a slow shutter speed, because it helps to avoid blurring of images due to hand movement.

Specifying Image Size and Quality

You can specify the image size and image quality to suit the type of image you are recording.

To specify the image size

1. In the REC mode, press [MENU].
2. Use [◀] and [▶] to select the “REC” tab.
3. Use [▲] and [▼] to select “Size”, and then press [▶].
4. Use [▲] and [▼] to select the setting you want, and then press [SET].

2048 x 1536 : 2048 x 1536 pixels

1600 x 1200 : 1600 x 1200 pixels

1280 x 960 : 1280 x 960 pixels

640 x 480 : 640 x 480 pixels

NOTE

- Use 2048 x 1536 when you plan to produce a large print of the image. Use 640 x 480 when you need to economize on space because you plan to send images in e-mail, etc.

To specify image quality

1. In the REC mode, press [MENU].
2. Use [◀] and [▶] to select the “REC” tab.
3. Use [▲] and [▼] to select “Quality”, and then press [▶].
4. Use [▲] and [▼] to select the setting you want, and then press [SET].

| To get this: | Select this setting: |
|--|----------------------|
| Very high quality, but large file size | Fine |
| Normal quality | Normal |
| Small file size, but low quality | Economy |

NOTE

- Use the “Fine” setting when image quality is your top priority and file size is secondary. Conversely, use the “Economy” setting when file size is your top priority and image quality is secondary.

IMPORTANT!

- Actual file size depends on the type of image you record. This means that the remaining image capacity noted on the monitor screen may not be exactly accurate (pages 22 and 164).

Free Manuals Download Website

<http://myh66.com>

<http://usermanuals.us>

<http://www.somanuals.com>

<http://www.4manuals.cc>

<http://www.manual-lib.com>

<http://www.404manual.com>

<http://www.luxmanual.com>

<http://aubethermostatmanual.com>

Golf course search by state

<http://golfingnear.com>

Email search by domain

<http://emailbydomain.com>

Auto manuals search

<http://auto.somanuals.com>

TV manuals search

<http://tv.somanuals.com>