

PTZ CAMERA

ZC-PT SERIES

USER MANUAL

EN

Thank you for your purchase of this product. Before operating the product, please read this instruction manual carefully to ensure proper use. Please store this instruction manual in a safe place for future reference, after you have read it.

GAWZ[®]



Preface

The information provided in this manual was current when published. The company reserves the right to revise and improve its products. All specifications are subject to change without notice.

Notice

To work with the PTZ cameras, any installer or technician must have the following minimum qualifications:

- A basic knowledge of CCTV systems and components
- A basic knowledge of electrical wiring and low-voltage electrical connections
- Thorough familiarity with the contents of this manual

Important Information

Before proceeding, please read and observe all instructions and warnings in this manual. Retain this manual with the original bill of sale for future reference and, if necessary, warranty service. When unpacking your unit, check for missing or damaged items. If any item is missing, or if damage is evident, DO NOT INSTALL OR OPERATE THIS PRODUCT. Contact your dealer for assistance.

Copyright

Under copyright laws, the contents of this user manual may not be copied, photocopied, translated, reproduced or replicated in any electronic medium or machine-readable format, in whole or in part, without the prior written permission of CBC Co. Ltd.

©Copyright2006CBC Co. Ltd.

Warning Notices

- **Handle the camera with care**
Do not abuse the camera. Avoid striking, shaking, etc. The camera could be damaged by improper handling or storage.
- **Do not dismantle the camera**
To prevent electric shock, do not remove screws or covers. There are no user serviceable parts inside. Contact a qualified service person for servicing.
- **Do not block cooling holes on the bracket**
This camera has a cooling fan inside. Blocking the cooling holes leads to a build up of heat inside the camera and may cause malfunctions.
- **Do not operate the camera outside the specified temperature, humidity or power source rating range**
Use the indoor camera under conditions where the temperature is between 0~40°C (32 ~104°F) and the outdoor camera at -50~ 50°C (-58 ~122°F) and in humidity of below 90%.
- **Do not use strong or abrasive detergents when cleaning the camera body**
Use a dry cloth to clean the camera when dirty. If the dirt is hard to remove, use a mild detergent and wipe gently.
- **Never point the camera towards the sun**
Do not aim the camera at bright objects. Whether the camera is in use or not, never aim it at the sun or other extremely bright objects. Otherwise, the camera may be smeared or damaged.

Contents

1. Overview	5
1.1 Product Features	6
1.2 Product Application.....	7
2. Connecting the PTZ Camera	8
2.1 Package Content.....	8
2.2 Switch Definition.....	9
2.3 Communication Switch Setting.....	9
2.4 PTZ Camera ID Setting.....	10
2.5 PTZ Camera Control Protocol.....	10
2.6 22-Pin Connector Definition	12
2.7 RS-485 Connector.....	13
3. Operation and Configuration	14
3.1 OSD Display Format	14
3.2 OSD Menu Tree	15
3.2.1 18× / 26× Model.....	15
3.2.2 22× / 23× Model.....	17
3.3 Configuration Menu.....	20
3.3.1 DEFAULT CAMERA	20
3.3.2 BACKLIGHT	21
3.3.3 FOCUS	21
3.3.4 APERTURE	22
3.3.5 AE MODE	23
3.3.6 WBC MODE	24
3.3.7 ID DISPLAY	25
3.3.8 SETUP MENU	26
FLIP (IMAGE/ME/OFF).....	26
ZOOM SPEED.....	27
SPEED BY ZOOM	27
AUTO CALIBRATION	27
DIGITAL ZOOM	27
SLOW SHUTTER	28
ANGLE ADJUSTER.....	28
RESET	29
EXIT	29
3.3.9 SETUP MENU2 (18×/26× Model Only)	29
APERTURE	29
MASK DISPLAY.....	29
3.3.10 TITLE DISPLAY.....	29

3.3.11 TITLE SETTING	30
3.3.12 ALARM SETTING.....	31
3.3.13 HOME SETTING	32
3.3.14 SEQUENCE	34
3.3.15 AUTOPAN.....	35
3.3.16 CRUISE	37
3.3.17 IR FUNCTION (Removable IR Blocking).....	38
3.3.18 ALARM DETECT (18×/26× Model Only)	39
3.3.19 WDR Setting (23× Model Only)	40
3.3.20 PRIVACY	40
3.3.21 TIME FUNCTION	44
3.3.22 SCHEDULE FUNCTION	44
3.3.23 EXIT OSD	45
Appendix A: Technical Specifications	46
OSD Menu Notes.....	47
<18×/26× Model>	47
<22×/23× Model>	49

1. Overview

The ZC-PT series integrated indoor PTZ camera is a new sub-compact model designed to deliver superb performance and durability combined with an intelligent and stylish housing that is suitable for any security and surveillance installation. The ZC-PT-XT series is a new weather resistant integrated outdoor PTZ camera. The ZC-PT and ZC-PT-XT series support a standard wiring concept for easy installation, and can be integrated with CCTV products, such as DVRs, control keyboards and CCTV accessories to provide a total surveillance solution.

The PTZ camera range includes four models of new generation advanced DSP colour cameras:

- ZC-PT226 model: 26× optical zoom / 12× digital magnification
- ZC-PT223 model: 23× optical zoom / 12× digital magnification
- ZC-PT222 model: 22× optical zoom / 12× digital magnification
- ZC-PT218 model: 18× optical zoom / 12× digital magnification

The PTZ camera delivers the power of a 312 x zoom, enabling it to capture clear images from a long distance away. Continuous auto focus, back light compensation, auto exposure and digital slow shutter functions are provided to ensure clear and high quality images. The key features incorporated to meet your needs include a removable IR cut filter to 24-hour operation, additional privacy masks specially designed to prevent any intrusive monitoring in specific areas and a wide dynamic range function. The Home function allows the user to specify a preset position as the 'home position' or function (sequence/auto-pan/cruise). The PTZ camera can then return to its home position or function when the user does not operate any of the controls for a set period of time. The unique scheduling function also enables users to program a preset point or function (sequence/auto-pan, cruise), which is automatically triggered at a certain time.

The PTZ camera provides variable pan/tilt speeds ranging from a fast patrol of 400° per second to a slow sweep of 5° per second with 0.225° pan accuracy for fast and accurate tracking capability. The 360° continuous rotation and -10°~190° tilt travel allows an object passing directly underneath the PTZ camera to be tracked. Up to 256 preset points can be programmed for precise location of target areas, and you can also define 8 sequence, 4 auto-pan and 1 cruise route for the camera to operate automatically. An RS-485 communication port is available for remote control purposes.

The PTZ camera provides 8 alarm inputs and 2 alarm outputs, and the smart alarm management mechanism can be programmed using the OSD setup menu; certain functions (Preset/Sequence/Auto-Pan/Cruise) can be activated when an alarm is triggered.

More than 10 built-in protocols including, GANZ-PT, GANZ-S, Pelco-D, -P, VCL, Philips, AD-422 (Manchester) etc. provide connectivity to other surveillance systems, allowing the integrated PTZ camera to be used in conjunction with systems from other manufacturers.

Dependability and ultra high reliability are key factors of the camera design. Every PTZ camera is assembled with meticulous care and thorough testing at our ISO 9001 certified factory. High performance, reliability, and reasonable pricing make this camera an ideal solution for even the toughest surveillance requirements.

1.1 Product Features

Precise and Accurate Tracking

- Auto calibration
- Scheduling functions
- Pan driver accuracy of 0.225°
- Preset speed up to 400°/sec.
- Pan & tilt proportional to zoom ratio
- 256 preset positions / 8 sequences / 4 auto-pan / 1 cruise

Day / night features

- Removable IR cut filter (23×, 26× model)

Low-light applications

- Minimum illumination 0.01 Lux
- Digital slow shutter
- Electronic shutter

Perfect contrast solution for high image quality

- Wide dynamic range (23x model)
- Auto white balance
- Auto gain control
- Backlight compensation
- Auto iris control

Privacy mask for privacy protection

- Up to 24 programmable privacy zones for camera view (18×, 26× model)

Dynamic PTZ camera configuration

- Flexible indoor and outdoor mountings
- Compact lightweight design for easy installation
- Weather resistant housing to protect against temperature, sunlight and rain

Integrated enhanced Internet capability (optional)

- Remote monitoring mode / system configuration / software upgrades
- Incorporate active Windows applications

1.2 Product Application

Connect the PTZ camera to other devices as shown in the diagram to create a complete video surveillance solution.

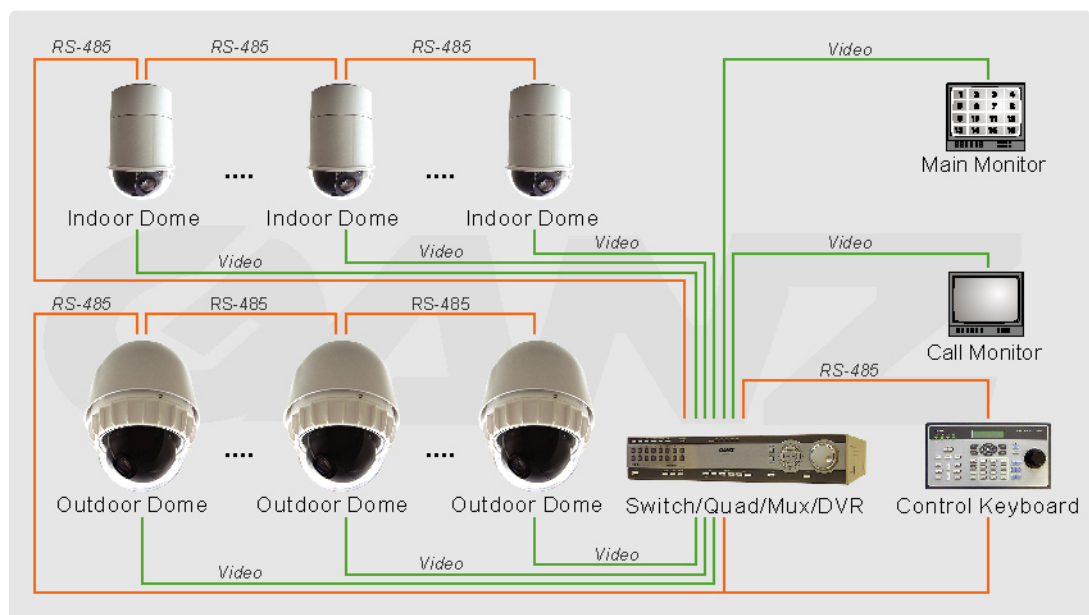

2. Connecting the PTZ Camera

Please refer to the sections below for details of how to set and connect the PTZ camera. In order to control PTZ camera, a control keyboard or alternative control device is required.

2.1 Package Content

Before proceeding, please check that the box contains the items listed here. If any item is missing, or if damage is evident, DO NOT install or operate the product and contact your dealer immediately for assistance.

Indoor PTZ Camera Standard Package

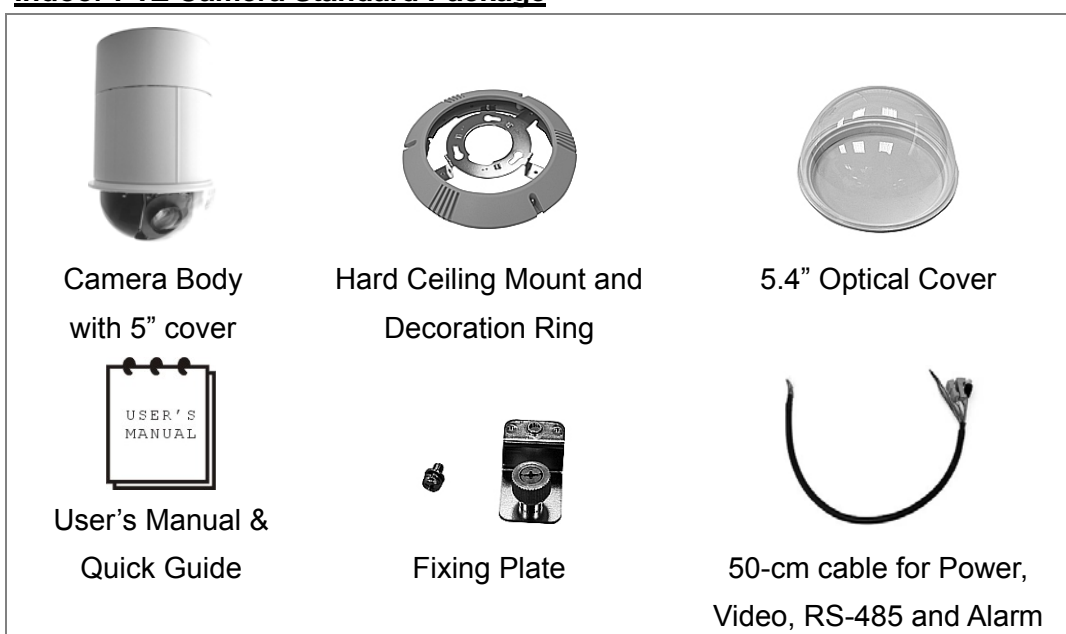

Outdoor PTZ Camera Standard Package

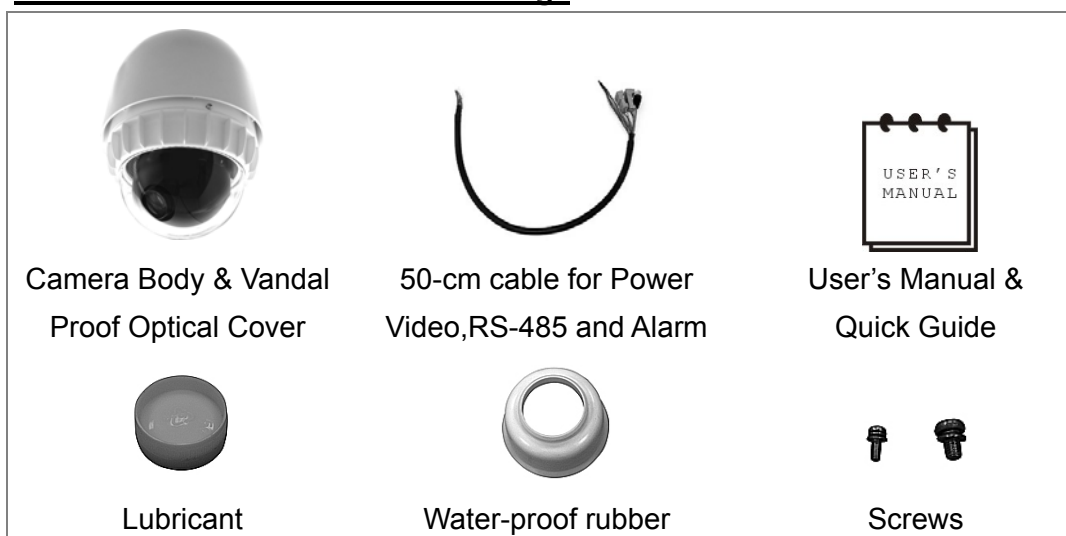

2.2 Switch Definition

The PTZ camera ID and communication protocol must be configured before connecting the camera to other devices. The switches used to configure these settings are located on the bottom of the PTZ camera.

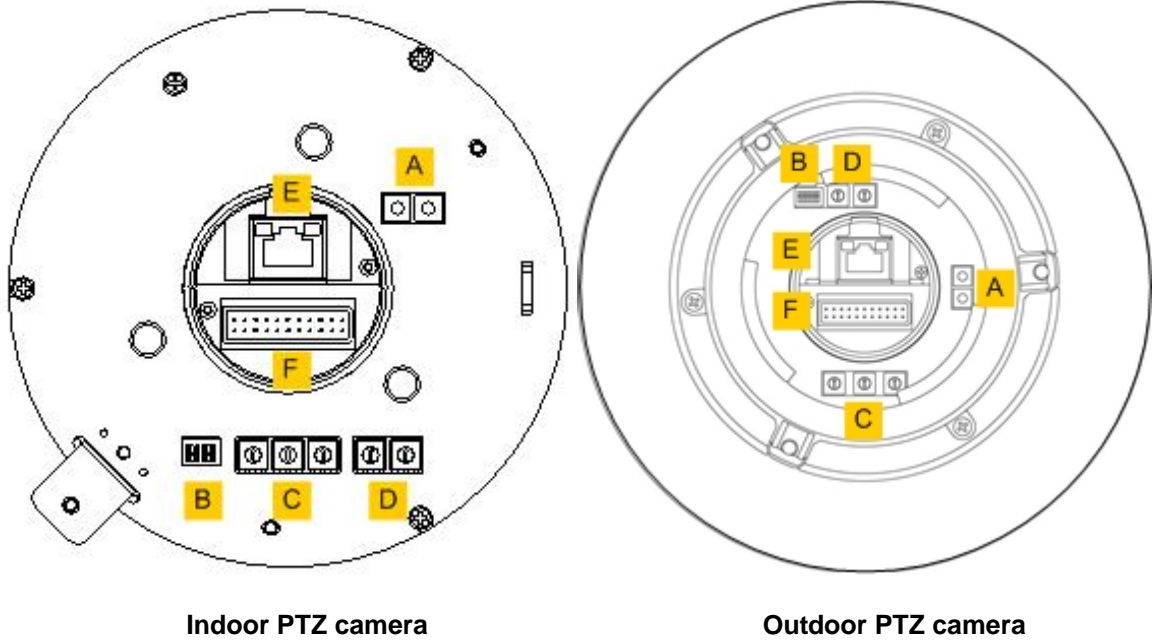

A	Reserved
B	Communication switch
C	PTZ camera ID switch
D	PTZ Camera Control Protocol
E	RJ-45 connector (for IP camera only)
F	22-pin connector

2.3 Communication Switch Setting

The table below shows the function of each pin within the communication switch.

Communication switch	Pin 1	RS-485 setting
	Pin 2	Termination
	Pin 3	Line lock
	Pin 4	System initialise
	Pin 5	Reserved

RS-485 is the interface that allows the PTZ camera to communicate with its control unit; the RS-485 configuration on the PTZ camera and the control unit must therefore

be the same. The default RS-485 setting is half-duplex. Please do not change the default setting without seeking the advice of a qualified specialist or the supplier. Pin 3 and pin 4 are used for termination and line lock adjustment respectively. Pin 5 is mainly used after updating the software and changing protocol.

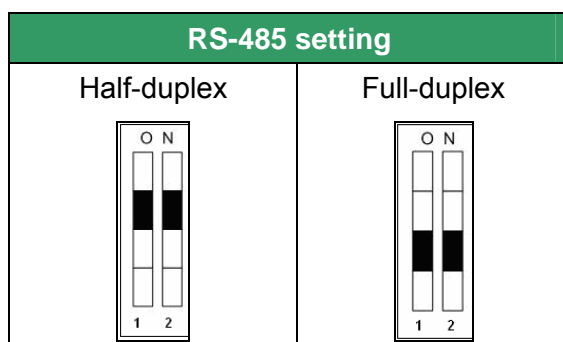

2.4 PTZ Camera ID Setting

Use the switch to change your PTZ camera ID by turning the arrow to the desired number. For example, if the camera ID is 123, the ID switch should be set as below.



NOTE: No two cameras should be given the same ID or communication conflict may occur.

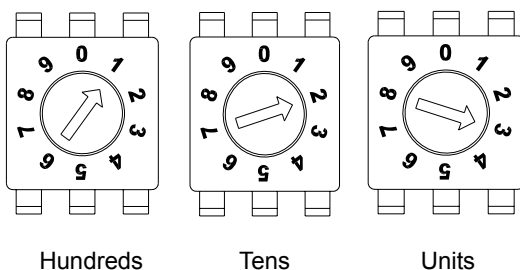

NOTE: The number “0” should be located at the top as shown in above diagram to ensure correct switch definition.

2.5 PTZ Camera Control Protocol

A protocol is a specific set of rules and procedures used for data communication. Define the protocol you are going to use based on the devices in your surveillance system. Generally, you should use a single protocol even if the devices are supplied by different manufacturers. Use the switch to set your PTZ camera control protocol and the baud rate. Refer to the table below and turn the arrow to choose a protocol for your camera.

Switch no.	Protocol	Baud rate
00	VCL	9600
01	Pelco D	2400
02	Pelco P	4800
04	Chiper	9600
05	Philips	9600
07	GANZ-PT	9600
08	AD422	4800
09	DM P	9600
11	Pelco D	4800
12	Pelco D	9600
13	Pelco P	2400
14	Pelco P	9600
16	GANZ-S	4800
17	GANZ-S	9600
18	GANZ-S	19200
19	GANZ-S	38400

*GANZ-PT is for ZC-PT series PTZ camera. GANZ-S is for ZC-S series PTZ camera.

For example, select protocol Pelco D with a baud rate of 2400, the ID switch should be set as shown below.

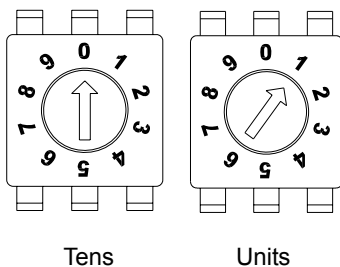

NOTE: Change the PTZ camera control protocol only when the camera is powered off.

After changing protocol, please do the following procedure:

- (1) Set PIN 5(Communication switch) on.
- (2) Power on the camera and check the message on the screen.
- (3) Power off and set PIN 5(Communication switch) off.
- (4) Power on again.

2.6 22-Pin Connector Definition

A 50 cm data cable (as shown below) is supplied with the PTZ camera for quick installation, e.g. for demonstration or testing purposes. The cable design requires an additional alarm cable.

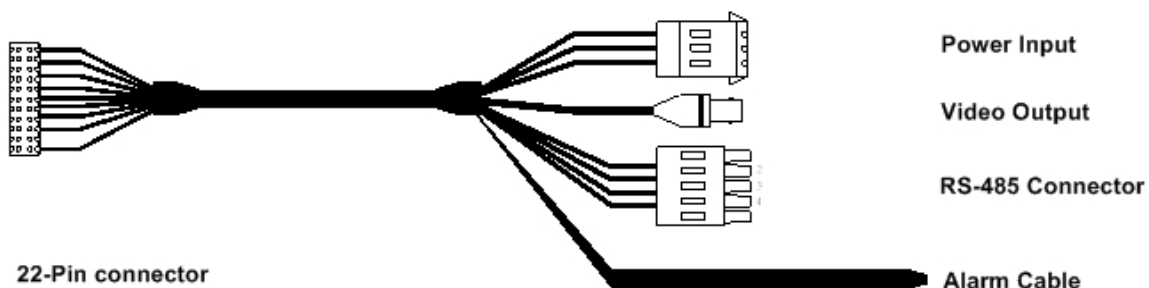

The 22-pin connector definition is listed in the table below.

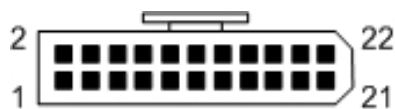

Pin	Definition	Cable
1	AC24-1	20AWG
2	ALM NO	24AWG
3	AC24-2	20AWG
4	ALM NC	24AWG
5	FG	20AWG
6	ALM COM	24AWG
7	T+	24AWG
8	R-	
9	T-	
10	R+	
11	Alarm ISOG	
12	ALM-1	
13	ALM-3	
14	ALM-2	
15	ALM-4	
16	ALM-5	
17	ALM-6	
18	ALM-7	
19	ALM-8	
20	ALM GND	
21	VGND	
22	Video	

2.7 RS-485 Connector

RS-485 is the interface that the PTZ camera uses to communicate with its control unit. Connect the control keyboard to the camera via the terminal block. The recommended cables for RS-485 communication are **CAT 5** cables; the maximum cable length for wire with a gauge above 24 is 4000 feet (1219 meters). If the total cable length exceeds 4000 feet, using a repeater to amplify the signals is recommended.



	Corresponding Pins (22-Pin Connector)	Definition
1	7,10	T+, R+ (D+)
2	Reserved	
3	Reserved	
4	Reserved	
5	8,9	T-, R- (D-)

3. Operation and Configuration

3.1 OSD Display Format

The information shown on the screen is described in terms of the corresponding OSD display, its position and its function in the table below.

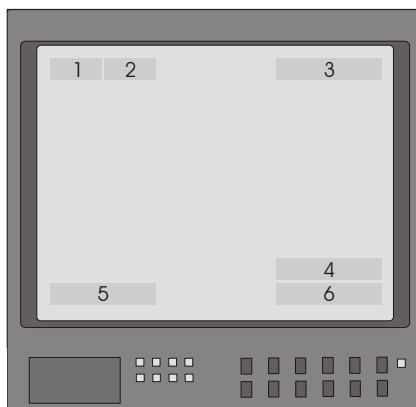

Position	Function	OSD display	Description
1	Focus modes	A	Auto focus mode
		M	Manual focus mode
2	Backlight	X	Back light compensation OFF
		B	Back light compensation ON
3	Alarm	ALARM	Alarm message
4	Zoom ratio	×1	Current zoom ratio (Optical zoom→Digital zoom)
5	Title	<ul style="list-style-type: none"> Maximum 20 characters for each title. 16 sets of titles are available. 	
6	Camera ID	Shows the camera ID	

3.2 OSD Menu Tree

The OSD setup menu structures for the 18×/26× model and the 22×/23× model are listed separately in the section below. The star symbol indicates the factory default.

For a detailed function description, please refer to section [3.3 Configuration Menu](#).

3.2.1 18× / 26× Model

Item	Layer 1	Layer 2	Layer 3	Default
DEFAULT CAMERA	<ON>, <OFF>			ON
BACKLIGHT	<ON>, <OFF>			OFF
FOCUS	AUTO	AF mode <Normal>, <Interval>, <Zoom trigger>		Normal
	MANUAL	Manual focus speed <01> - <08>		
AE MODE	AUTO	Exposure comp. <OFF>, <1>~<15>		OFF
	BRIGHT	Bright <0> ~ <31>		
	SHUTTER	Shutter speed <1> ~ <1/10000> sec.		
	GAIN	Gain <-3> ~ <28>dB		
	IRIS	Iris <Close>, <F1.6> ~ <F28>		
WBC MODE	AUTO (Auto white balance)			☆
	INDOOR			
	OUTDOOR			
	ATW (Auto-tracing WBC)			
	MANUAL	R gain <000> ~ <128>	B gain <000> ~ <128>	
ID DISPLAY	<ON>, <OFF>			ON
SETUP MENU 1	FLIP	<IMAGE>, <M.E.>, <OFF>		OFF
	ZOOM SPEED	<1> ~ <8>		8
	SPEED BY ZOOM	<ON>, <OFF>		OFF
	AUTO CALI.	<ON>, <OFF>		OFF
	DIGITAL ZOOM	<ON>, <OFF>		ON
	SLOW SHUTTER	<ON>, <OFF>		OFF
	ANGLE ADJUSTER	ADJUST MIN ANGLE		00
		ADJUST MAX ANGLE		90
		RESET		
	RESET	<YES>		
EXIT				
SETUP MENU 2	APERTURE	<01> ~ <16>		01
	MASK DISPLAY	<FIRST>, <LAST>		First
TITLE DISPLAY	<ON>, <OFF>			OFF
TITLE SETTING	<01> ~ <16>			01
ALARM SETTING	ALARM PIN	<1> ~ <8>		1
	ALARM SWITCH	<ON>, <OFF>		OFF
	ALARM TYPE	<N.O.> (Normally open), <N.C.> (Normally closed)		N.C.
	ALARM ACTION	PRESET		☆
		SEQUENCE		
		AUTOPAN		
		CRUISE		
	PRESET POINT SEQUENCE LINE	<001> ~ <256>		001
AUTOPAN LINE	<1> ~ <8>			
CRUISE LINE	<1> ~ <4>			
	<1>			
DWELL TIME	<001> ~ <127> Sec., <ALWAYS>		ALWAYS	
EXIT	YES			

Item	Layer 1	Layer 2	Layer 3	Default	
HOME SETTING	HOME FUNC.	<ON>, <OFF>		OFF	
	SELECT MODE	PRESET		☆	
		SEQUENCE			
		AUTOPAN			
		CRUISE			
	PRESET POINT SEQUENCE LINE AUTOPAN LINE CRUISE LINE	<001> ~ <256> <1> ~ <8> <1> ~ <4> <1>		001	
	RETURN TIME	<001> ~ <128> min.		001	
	GO	ENTER			
EXIT					
SEQUENCE	SEQUENCE LINE	<1> ~ <8>		1	
	SEQUENCE POINT	<01> ~ <32>		01	
	PRESET POS.	<001> ~ <255>, <END>		001	
	SPEED	<01> ~ <15>		01	
	DWELL TIME	<000> ~ <127> sec.		000	
	RUN SEQUENCE				
	EXIT				
AUTOPAN	AUTOPAN LINE	<1> ~ <4>		1	
	START POINT	<TO FIND>, <TO SAVE>			
	END POINT	<TO FIND>, <TO SAVE>			
	DIRECTION	<RIGHT>, <LEFT>		Right	
	SPEED	<01> ~ <04>		01	
	RUN AUTOPAN				
	EXIT				
CRUISE	RECORD START				
	RECORD END				
	RUN CRUISE				
	EXIT				
IR FUNCTION (26× model only)	<AUTO>, <ON>			Auto	
ALARM DETECT	DETECT SWITCH	<ON>, <OFF>		OFF	
	DETECT MODE	<INT. FOCUS>, <FIX FOCUS>, <INT. AE>, <FIX AE>		Int. focus	
	EXIT				
PRIVACY	PRIVACY SWITCH	<ON>, <OFF>		OFF	
	TRANSPARENCY	<ON>, <OFF>		OFF	
	COLOUR	<BLACK>, <HEAVY GRAY>, <LIGHT GRAY>, <WHITE>, <RED>, <GREEN>, <BLUE>, <CYAN>, <YELLOW>, <MAGENTA>		Black	
	SET MASK	<01> ~ <24>	H CENTRE <L>, <R>		
			V CENTRE <D>, <U>		
			H SIZE <00> ~ <80>		
V SIZE <00> ~ <60>					
EXIT	YES				
TIME	TIME DISPLAY	<ON>, <OFF>		OFF	
	SET YEAR				
	SET MONTH				
	SET DAY				
	SET HOUR				
	SET MINUTE				
	EXIT+SAVE				
SCHEDULE	SCHEDULE SW.	<ON>, <OFF>		OFF	
	SCHEDULE POINT	<01> ~ <32>		01	
	SCHEDULE HOUR			00	
	SCHEDULE MIN			00	
	SCHEDULE MODE	NONE			☆
		PRESET			
SEQUENCE					

Item	Layer 1	Layer 2	Layer 3	Default
		AUTOPAN		
		CRUISE		
		IR FUNC.		
	NO FUNCTION PRESET POINT SEQUENCE LINE AUTOPAN LINE CRUISE LINE IR FUNCTION	<1> ~ <256> <1> ~ <8> <1> ~ <4> <1> <AUTO>, <ON>		
	SCHEDULE RESET	YES		
	SCHEDULE EXIT			
EXIT OSD	YES			

3.2.2 22x / 23x Model

Item	Layer 1	Layer 2	Layer 3	Default
DEFAULT CAMERA	<ON>, <OFF>			ON
BACKLIGHT	ON	BLC level <00> ~ <100>		
	OFF			☆
FOCUS	AUTO	Focal length <1cm>, <10cm>, <30cm> <1m>		10 cm
	MANUAL	<01> ~ <08>		
APERTURE	AUTO			☆
	MANUAL	H APERTURE <00> ~ <31> V APERTURE <00> ~ <31>		
AE MODE	AUTO	IRIS OFFSET <00> ~ <99>		50
	SHUTTER	SHUTTER SPEED <1/2> ~ <1/30000>		
	IRIS	IRIS <00> ~ <09>		
	AGC	AGC <00> ~ <05>		
WBC MODE	AUTO			☆
	MANUAL	R gain <00> ~ <99> B gain <00> ~ <99>		
ID DISPLAY	<ON>, <OFF>			ON
SETUP MENU	FLIP	<IMAGE>(23x model only), <M.E.>, <OFF>		OFF
	ZOOM SPEED	<FAST>, <SLOW>		Slow
	SPEED BY ZOOM	<ON>, <OFF>		OFF
	AUTO CALI.	<ON>, <OFF>		OFF
	DIGITAL ZOOM	<1> ~ <12>, <OFF>		OFF
	SLOW SHUTTER (23x model only)	<1/2> ~ <1/60> sec. (NTSC) <1/1.5> ~ <1/50> sec. (PAL)		1/30
	ANGLE ADJUSTER	ADJUST MIN ANGLE		00
		ADJUST MAX ANGLE		90
		RESET		
	RESET	YES		
EXIT				
TITLE DISPLAY	<ON>, <OFF>			OFF
TITLE SETTING	<01> ~ <16>			01
ALARM SETTING	ALARM PIN	<1> ~ <8>		1
	ALARM SWITCH	<ON>, <OFF>		OFF
	ALARM TYPE	<N.O.>, <N.C.>		N.C.
	ALARM ACTION	PRESET		☆
		SEQUENCE		
	AUTOPAN			
	CRUISE			

Item	Layer 1	Layer 2	Layer 3	Default	
	PRESET POINT SEQUENCE LINE AUTOPAN LINE CRUISE LINE	<001> ~ <256> <1> ~ <8> <1> ~ <4> <1>		001	
	DWELL TIME	<001> ~ <127> sec., ALWAYS		ALWAYS	
	EXIT	YES			
HOME SETTING	HOME FUNC.	<ON>, <OFF>		OFF	
	SELECT MODE	PRESET		☆	
		SEQUENCE			
		AUTOPAN			
		CRUISE			
	PRESET POINT SEQUENCE LINE AUTOPAN LINE CRUISE LINE	<001> ~ <256> <1> ~ <8> <1> ~ <4> <1>		001	
	RETURN TIME	<001> ~ <128> min.		001	
GO	ENTER				
EXIT	YES				
SEQUENCE	SEQUENCE LINE	<1> ~ <8>		1	
	SEQUENCE POINT	<01> ~ <32>		01	
	PRESET POS.	<001> ~ <255>, <END>		001	
	SPEED	<01> ~ <15>		01	
	DWELL TIME	<000> ~ <127> sec.		000	
	RUN SEQUENCE	ENTER			
	EXIT				
AUTOPAN	AUTOPAN LINE	<1> ~ <4>		1	
	START POINT	<TO FIND>, <TO SAVE>			
	END POINT	<TO FIND>, <TO SAVE>			
	DIRECTION	<RIGHT>, <LEFT>		Right	
	SPEED	<01> ~ <04>		01	
	RUN AUTOPAN	ENTER			
	EXIT				
CRUISE	RECORD START				
	RECORD END				
	RUN CRUISE				
	EXIT				
IR FUNCTION (23× model only)	AUTO	THRESHOLD	<LOW>, <MID>, <HI>	LOW	
		IR COLOUR	<B/W>, <COLOUR>	B/W	
		EXIT			
ON					
WDR SETTING (23× model only)	WDR SWITCH	<ON>, <OFF>		OFF	
	WDR FUNCTION	AUTO		☆	
		MANUAL	RATIO LEVEL <000>~<128>		
			SHUTTER LEVEL <000>~<128>		
	IRIS OFFSET <000>~<128>				
EXIT					
PRIVACY (23× model only)	PRIVACY SWITCH	<ON>, <OFF>		OFF	
	SHADE	<BLACK>, <WHITE>, <GREY>		Grey	
	SET MASK	<1> ~ <8>	H CENTRE <000> ~ <256>		
			V CENTRE <000> ~ <256>		
			H SIZE <000> ~ <127>		
			V SIZE <000> ~ <127>		
	MASK CLEAR+RESET	<01> ~ <08>		01	
	MASK DISPLAY	<FIRST>, <LAST>		First	
EXIT	YES				
TIME	TIME DISPLAY	<ON>, <OFF>		OFF	

Item	Layer 1	Layer 2	Layer 3	Default	
	SET YEAR				
	SET MONTH				
	SET DAY				
	SET HOUR				
	SET MINUTE				
	EXIT+SAVE				
SCHEDULE	SCHEDULE SWITCH	<ON>, <OFF>		OFF	
	SCHEDULE POINT	<01> ~ <32>		01	
	SCHEDULE HOUR			00	
	SCHEDULE MIN			00	
	SCHEDULE MODE	NONE			☆
		PRESET			
		SEQUENCE			
		AUTOPAN			
		CRUISE			
	NO FUNCTION PRESET SEQUENCE LINE AUTOPAN LINE CRUISE LINE IR FUNCTION	IR FUNC.			
		PRESET	<1> ~ <256>		
		SEQUENCE LINE	<1> ~ <8>		
		AUTOPAN LINE	<1> ~ <4>		
CRUISE LINE		<1>			
IR FUNCTION		<AUTO>, <ON>			
SCHEDULE RESET					
SCHEDULE EXIT					
EXIT OSD	YES				

3.3 Configuration Menu

The detailed functions and parameter settings for your PTZ camera can be set in the OSD (On Screen Display) menu using a control unit, such as a control keyboard (ZCA-SC201). The functions in the OSD menu on the 18×, 22×, 23× and 26× models are described in the following sections.

18×/26× Model

MAIN PAGE 1	
DEFAULT CAMERA	OFF
BACKLIGHT	OFF
FOCUS	AUTO
AE MODE	AUTO
WBC MODE	AUTO
ID DISPLAY	ON
SETUP MENU1	
SETUP MENU2	

22× / 23× Model

MAIN PAGE 1	
DEFAULT CAMERA	OFF
BACKLIGHT	OFF
FOCUS	AUTO
APERTURE	AUTO
AE MODE	AUTO
WBC MODE	AUTO
ID DISPLAY	ON
SETUP MENU	ENTER

To enter the OSD menu for the selected camera, press the <CAMERA MENU> button on the control keyboard and hold for 3 seconds to enter the OSD menu.

To select the setup option, use the direction keys on the keyboard to move the cursor in the OSD menu.

To set an item, use the direction keys on the keyboard to move the cursor in the OSD menu. For items with →, press the right/left direction buttons on the control keyboard to select. For items with ↓, press the <CAMERA MENU> button on the control keyboard to enter the sub-menu. For items with →↓, users can use the right/left direction buttons to select functions then press the <CAMERA MENU> button on the control keyboard to enter its sub-menu.

For further detailed setup procedures, please refer to the user manual for the installed control units.

3.3.1 DEFAULT CAMERA

The DEFAULT CAMERA option is used to restore the camera settings (e.g. Backlight/Focus/AE/WBC/Aperture). Once any one of the items is modified, the setting will automatically revert to <OFF>. Select <ON> for this item to restore the previous camera parameters.



NOTE: On the 18×/26× model, the Aperture function is provided in SETUP MENU2, instead of DEFAULT CAMERA.

3.3.2 BACKLIGHT

The backlight compensation function prevents the central object from being too dark in surroundings where excessive light is shining from behind it.

18x/26x Model:

Turn this option <ON>; the central object will be brightened in contrast to the edge of the picture (where a backlight would most likely be located).

22x23x Model:

The backlight compensation level ranges from 000 to 100.

	BLC LEVEL	
LEVEL		20
EXIT		YES



NOTE: If this function is enabled, the WDR function (for 23x model only) will be disabled automatically. For details, refer to section [3.3.19 WDR Setting](#).

3.3.3 FOCUS

Automatically adjusts the focus position to maximize the high frequency content of the picture in a central measurement area, taking into consideration the high luminance and strong contrast components. The focus on the PTZ camera can be operated in two modes: Manual focus mode and auto focus mode. Different settings for the various models are described below.

18x/26x Model:

- **AUTO**

The optimum focus is achieved using the internal digital circuit. There are 3 modes for users to select for different conditions.

Normal AF (auto focus) mode: The PTZ camera will automatically adjust the focus of the picture.

Zoom trigger mode: When the zoom ratio is changed using the TELE or WIDE buttons on the control keyboard or another control unit, the PTZ camera will automatically adjust the focus again after a period of time (the preset value is initially set to five seconds).

Interval AF mode: This mode is used for AF movements carried out at particular intervals. If users pan/tilt the PTZ camera, the PTZ camera will focus automatically after a period of time. The preset value is five seconds.

- **MANUAL**

In this focus mode, users can adjust the lens focus manually by pressing the focus in/out button on the control keyboard or another control unit.

22x/23x Model:

- **AUTO**

The optimum focus is achieved using the internal digital circuit. Users can adjust the minimum auto focus range for certain special conditions; the options are <1 cm>, <10 cm>, <30 cm> and <1 m>.

- **MANUAL**

In this focus mode, users can adjust the lens focus manually by pressing the focus in/out button on the control keyboard.

FOCAL LENGTH	
TURNING VALUE	10CM
EXIT	YES

3.3.4

APERTURE

Sharpness is the subjective evaluation of detail in the picture. With this APERTURE function, users can adjust the enhancement of the edges of objects in the picture. When shooting text, this function may help to make it sharper and thus achieve a better image. There are 32 adjustment levels; the options are <00> ~ <31>, where <00> represents “no enhancement”.

- **AUTO**

The PTZ camera will assign an appropriate aperture value automatically to enable the camera to capture a better image.

- **MANUAL**

Select this option if you want to adjust the aperture value manually. A higher value enhances the incident light on the camera.

APERTURE MENU	
H APERTURE	15
V APERTURE	15



NOTE: On the 18x/26x model, refer to section [3.3.9 SETUP MENU2](#) for information about the aperture function.

3.3.5

AE MODE

The exposure is the amount of light captured by the image sensor and is determined by how wide you open the lens diaphragm (iris adjustment), how long you leave the sensor exposed (shutter speed) and other exposure parameters. This option allows users to define how the Auto Exposure (AE) function will work.

18x/26x Model:

- **AUTO**

In this mode, the camera's IRIS and AGC (Auto Gain Control) circuits work together automatically to adjust the light exposure of the image sensor in order to obtain a consistent video output level. In these conditions, the shutter speed is fixed at 1/60 (NTSC) or 1/50 (PAL). Users can adjust the internal brightness reference level using auto exposure compensation to control the brightness of camera. The exposure compensation value can be selected between <0> and <16> and the gain varies from -10.5 dB to 10.5 dB. Each step is 1.5 dB and an exposure compensation value of <7> is equal to a gain value of 0 dB. The camera will not compensate for brightness if exposure compensation is set to <OFF>. The default setting is <OFF>.

- **BRIGHT**

The brightness control function adjusts the IRIS and AGC gain using an internal algorithm. The brightness is controlled by the gain in dark lighting conditions and by the iris in bright lighting conditions.

- **SHUTTER**

This option means that the shutter speed is the main factor controlling the exposure, and both IRIS and AGC will function automatically in conjunction with the set shutter speed to achieve consistent exposure output.

- **GAIN**

The automatic gain control function means that the gain is the main factor controlling the exposure, taking priority over SHUTTER and IRIS. The internal circuit will function automatically to obtain a consistent exposure.

- **IRIS**

This option gives the IRIS function a higher priority. The shutter speed and the AGC circuit will function automatically in conjunction with the ARIS setting to obtain consistent exposure output. Opening a lens controls the amount of light reaching the surface of the selected device. Increasing the F-stop number (F/1.6, F/2, F/2.4, etc.) allows less light to pass.

22x/23x Model:

- **AUTO**

In this mode, the camera's shutter, IRIS and AGC control functions work together automatically to adjust the light exposure of the image sensor in order to obtain a consistent video output level. IRIS OFF SET is used to set the level of IRIS variation.

- **SHUTTER**

This option means that the SHUTTER setting takes priority over IRIS and AGC; the IRIS and AGC circuits will function automatically in conjunction with the set shutter speed to obtain a consistent exposure.

- **IRIS**

This option means that the IRIS setting takes priority over SHUTTER and AGC; the SHUTTER and AGC circuits will function automatically in conjunction with the IRIS setting to obtain a consistent exposure. If the IRIS setting is modified manually, exposure compensation depends on the AGC circuit.

- **AGC**

This option means that the AGC setting takes priority over SHUTTER and IRIS; the SHUTTER and IRIS circuits will function automatically in conjunction with the AGC setting to obtain a consistent exposure. If the AGC setting is modified manually, exposure compensation depends on changing the IRIS setting.

3.3.6**WBC MODE**

A digital camera needs to find a reference colour temperature, which is a way of measuring the quality of a light source, in order to correctly calculate all the other colours. The unit for measuring this ratio is degrees Kelvin (K). You can select one of the white balance control modes depending on the conditions. The following table shows the colour temperature of some light sources.

Light source	Colour temperature in K
Cloudy sky	6,000 to 8,000
Noon sun and clear sky	6,500
Household lighting	2,500 to 3,000
75 watt bulb	2,820
Candle flame	1,200 to 1,500

18x/26x Model:

- **AUTO**
In this mode, the white balance function works within its colour temperature range. This mode computes the white balance value output using colour information from the entire screen. It outputs the appropriate value using the colour temperature radiating from a black subject based on a range of values from 3000K to 7500K.

- **INDOOR**
3200 K base mode.

- **OUTDOOR**
5800 K base mode.

- **ATW**
Auto tracing white balance mode. The PTZ camera records the signals from a screen in the range from 2000 K to 10000 K.

- **MANUAL**
In this mode, the user can change the white balance value manually; R gain and B gain are adjustable in the range from 0 to 128.

WBC MENU		
R GAIN		50
B GAIN		50

22x/23x Model:

- **AUTO**
In this mode, the white balance function works within its colour temperature range and calculates the best-fit white balance value.

- **MANUAL**
In this mode, the user can change the white balance value manually; R gain and B gain are adjustable in the range from 0 to 99.

WBC MENU		
R GAIN		50
B GAIN		50

3.3.7 ID DISPLAY

The user can choose whether the PTZ camera ID will be displayed on the monitor to identify the camera. For more information, refer to section [2.4 PTZ Camera ID Setting](#).

- **ON**
Display the ID address of the selected camera in the bottom right of the monitor screen.
- **OFF**
Hide the ID address of the selected PTZ camera.

3.3.8 SETUP MENU

The user can adjust the camera lens model parameters in the SETUP menus. The SETUP menus are different depending on the model of the PTZ camera.

18x/26x Model

SETUP MENU1		SETUP MENU2	
FLIP	ENTER	APERTURE	01
ZOOM SPEED	1	MASK DISPLAY	FIRST
SPEED BY ZOOM	OFF		
AUTO CALI.	OFF		
DIGITAL ZOOM	12		
SLOW SHUTTER	OFF		
ANGLE ADJUSTER	ENTER		
RESET	YES		
EXIT	YES		

22x/23x Model

SETUP PAGE	
FLIP	ON
ZOOM SPEED	FAST
SPEED BY ZOOM	ON
AUTO CALI.	OFF
DIGITAL ZOOM	12
SLOW SHUTTER	1/2
ANGLE ADJUSTER	ENTER
RESET	YES
EXIT	YES

- **FLIP (IMAGE/ME/OFF)**
The user can track an object continuously when it passes under the PTZ camera with a Flip setting of IMAGE (digital flip) or M.E. (mechanical flip).

FLIP SETTING	
FLIP	OFF
EXIT	YES

IMAGE

IMAGE represents a digital IMAGE FLIP and enables the user to keep tracking the object seamlessly with no delay compared to a mechanical flip.



NOTE: The Privacy Mask function will be automatically disabled if the Image Flip function is enabled, and “Masking disabled” will be displayed on the screen.

M.E.

This option is a standard mechanical operation. As the PTZ camera tilts by 90°, it will pan 180° then continue tilting to keep tracking the object.

OFF

Select this option to disable the flip function.



NOTE: The PTZ camera will only be able to tilt 90°, or -10° ~100° with angle adjuster adjustments.

- **ZOOM SPEED**

This option is used to set the zoom speed for operating the PTZ camera.

18x/26x Model:

For these models, the zoom speed options are <1> (slow) ~ <8> (fast). The default setting is <8>.

22x/23x Model:

For these two models, the options are <FAST> and <SLOW> (default).

- **SPEED BY ZOOM**

If the option is set to <ON>, the pan/tilt speed will be adjusted by an internal algorithm when zooming automatically. The larger zoom ratio results in a slower rotation speed.

- **AUTO CALIBRATION**

Each PTZ camera features one horizontal and one vertical infrared light check points. If the camera position is moved during installation or maintenance, the relative distance between the original set point and the check point will be changed. If the Auto Calibration function is enabled, the camera will automatically detect this and reset the point to its original position.

- **DIGITAL ZOOM**

This option allows the user to enable or disable the 12x digital zoom. The digital zoom is activated after the full optical zoom level has been reached.



NOTE: The difference between optical and digital zoom is that optical zoom uses the lens within the camera to draw the image closer by zooming in or out to achieve the desired effect. Optical zoom retains the full

resolution and quality of the zoomed image. By contrast, digital zoom takes a portion of the image and expands that portion to the full size of the image; however the image quality will be reduced.

18x/26x Model:

On these models, a maximum 12× digital zoom function can be enabled. The default setting is <ON>.

22x/23x Model:

On these two models, the digital zoom ratio is adjustable from <1> to <12>.

- **SLOW SHUTTER**

The shutter speed determines how long the image sensor is exposed to light. To see a clear image in a dark environment, enable this function and select a slower shutter speed.

18x/26x Model:

When this digital slow shutter function is enabled, the PTZ camera will automatically adjust the shutter speed based on the lighting conditions in the installation environment. It enables users to see objects in a dark environment below 0.2 lux.

23x Model:

The shutter speed is adjustable on the 23x model. With the slowest shutter speed, the user can see objects in a dark environment below 0.2 lux or see a smooth video image with a higher shutter speed. The options range from <1/2> to <1/60>.

- **ANGLE ADJUSTER**

This option is used to adjust the camera view angle. The view angle range changes in the different FLIP modes: the range is from -10° to +100° in ME FLIP and FLIP OFF modes, and from -10° ~ +190° in IMAGE FLIP mode. With the IMAGE FLIP function, the user is able to adjust the view angle from -10° ~ +190° to capture a true horizontal line.

ANGLE ADJUSTER	
ADJUST MIN ANGLE	-10 DEG
ADJUST MAX ANGLE	100 DEG
EXIT+SET	YES

- **RESET**
Select this option to reset all camera parameters in the SETUP menus to the factory defaults.
- **EXIT**
Exit SETUP MENU1 and go back to the MAIN MENU.

3.3.9 SETUP MENU2 (18x/26x Model Only)

The Aperture and Mask Display settings can be configured under SETUP MENU2.

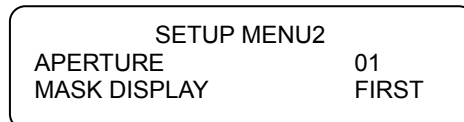

- **APERTURE**
In this setup menu, the user can adjust the enhancement of the edges of objects in the picture. There are 16 adjustment levels; the options are <01> ~ <16>, where <01> represents “no enhancement”. When shooting text, this function may help to make it sharper.
- **MASK DISPLAY**
This option allows the user to set when the privacy mask is displayed to prevent any intrusive monitoring. If the preset point function or the sequence function is activated, the difference between the two display modes will be obvious.

FIRST

If this display mode is selected and preset or sequence functions are activated, the camera will detect and display the masks set in the next area first and the PTZ camera will then rotate to the next preset point.

LAST

If this display mode is selected and preset or sequence functions are activated, the PTZ camera will move to the next preset point zone then detect and display the mask set for that zone.



NOTE: It is recommended that the privacy mask be set for 1× optical zoom and a sequence speed value higher than 10.

3.3.10 TITLE DISPLAY

The user can name a certain view area and display its title for easy recognition. In this option, the user can choose whether or not to display the titles set in advance.

- **ON**
A title set for a certain view will be displayed when the PTZ camera returns to that view area.
- **OFF**
If TITLE DISPLAY is set to <OFF>, no title will be displayed on the screen even if titles have been set.

3.3.11 TITLE SETTING

Up to 16 zone titles can be set with a maximum 20 characters for each title; two mask zones can be set for a view area. The user can name the zone titles with privacy mask ID numbers for future recognition.



NOTE: On the 23x model, the available area for setting the privacy mask is restricted to a tilt angle of 45°.

Follow the steps below to set a camera title.

STEP 1: Move the PTZ camera to a particular view area for which you want to set a title.

STEP 2: Turn on OSD and select <TITLE SETTING>.

STEP 3: Select a number to indicate the view area.

STEP 4: Press <ENTER> to go into editing mode.

TITLE SETTING: 01												
0	1	2	3	4	5	6	7	8	9			EXIT
A	B	C	D	E	F	G	H	I	J			SAVE
K	L	M	N	O	P	Q	R	S	T			LEFT
U	V	W	X	Y	Z	:	/	.	,			RIGHT
[]	+	?	-								DELETE
TITLE:												
ABC												

STEP 5: Choose a character using the direction keys and then press <ENTER> to input that character. Example: <A > <ENTER>, <ENTER>, <C> <ENTER>

TITLE: ABC

STEP 6: To delete characters entered, move the cursor <LEFT> or <RIGHT> and press <ENTER> to select a character in the entry field, then move the cursor to <DELETE> and press <ENTER> to delete the selected character.

STEP7: Once the setting is complete, move the cursor to <SAVE> and press <ENTER> to save.

3.3.12 ALARM SETTING

The PTZ camera provides eight alarm inputs and two alarm outputs (N.O. and N.C) to connect alarm devices. This function enables the PTZ camera to work in conjunction with an alarm system to capture images of a particular event. For wiring details, please refer to the installation guide and/or qualified service personnel. Alarm parameters can be set on this page.

ALARM SETTING	
ALARM PIN	1
ALARM SWITCH	OFF
ALARM TYPE	N.C.
ALARM ACTION	PRESET
PRESET POINT	001
DWELL TIME	ALWAY
EXIT	YES

- **ALARM PIN**

The PTZ camera provides eight alarm inputs and two outputs (1 x N.O. and 1 x N.C). Select an alarm connection for which you want to use this option to set alarm-related parameters and then set those parameters in the Alarm Setting menu. For alarm pin definitions, refer to section [2.6 Alarm Pin Definition](#) or the installation guide.

- **ALARM SWITCH**

This option is used to enable or disable the selected alarm pin function. Use the left/right direction keys on the control keyboard to change the setting.

- **ALARM TYPE**

There are two alarm types: Normally open and Normally closed, which are illustrated below. Select an alarm type that corresponds to the alarm application.

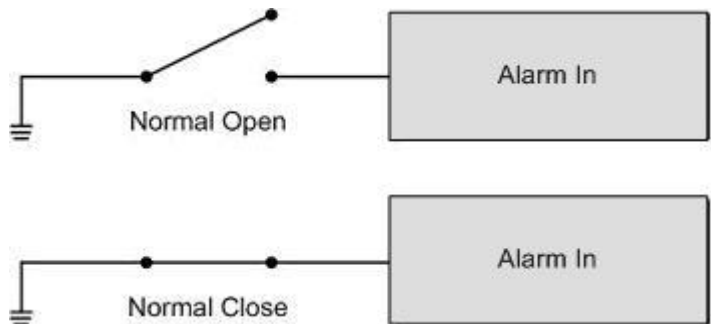

- **ALARM ACTION**

Select one of these modes to choose the actions to be performed when an alarm is triggered. The alarm actions can be set to execute the preset position,

sequence, auto-pan or cruise function. Use the right direction key on the control keyboard to change the setting and the following items will change to correspond to your selection.

- **PRESET**

Select a preset point for the PTZ camera to move to when an alarm pin is triggered. The preset points can be set on a control keyboard.

SEQUENCE

Select a sequence line for the PTZ camera to execute when an alarm pin is triggered. The sequence line should have previously been defined in the SEQUENCE setup menu.

AUTOPAN

Select an auto-pan line for the PTZ camera to execute when an alarm pin is triggered. The auto-pan line can be defined in the AUTOPAN setup menu.

CRUISE

Select a cruise line for the PTZ camera to execute when an alarm pin is triggered. The cruise line can be defined in the CRUISE setup menu.

- **DWELL TIME**

The DWELL TIME is the duration required to execute the ALARM ACTION: preset or sequence. When an alarm occurs, the PTZ camera will move to the preset position or execute the set sequence function and stay at each sequence point for a certain period of time (1~127 seconds). If <Always> is selected, the PTZ camera will move to the preset position and stay there until the alarm condition is removed or the user rotates the PTZ camera.



NOTE: The DWELL TIME is only accessible when selecting ALARM ACTION: preset or sequence.

- **EXIT**

Exit the ALARM SETTING menu.

3.3.13

HOME SETTING

The user can set an operating mode to ensure constant monitoring; if the PTZ camera is idle for a period of time, the preset function will be activated automatically, this is the HOME function. The HOME function allows continuous and accurate monitoring and prevents the PTZ camera stopping or missing events.

HOME SETTING	
HOME FUNCTION	OFF
SELECT MODE	PRESET
PRESET POINT	001
RETURN TIME	001
GO	ENTER
EXIT	YES

- **HOME FUNCTION**

This option is used to enable or disable the HOME function. Use the left/right direction keys on the control keyboard to change the setting.

- **SELECT MODE**

Select a mode that you want the PTZ camera to execute when the HOME function is enabled and the RETURN TIME has expired. The options are <AUTOPAN>, <SEQUENCE>, <CRUISE> and <PRESET>. Use the right direction key on the control keyboard to change the setting and the following items will change to correspond to your selection.

- **PRESET**

Select a preset point for the PTZ camera to move to when an alarm pin is triggered.

SEQUENCE

Select a sequence line for the PTZ camera to execute when an alarm pin is triggered. The sequence line should have previously been defined in the SEQUENCE setup menu.

AUTOPAN

Select an auto-pan line for the PTZ camera to execute when an alarm pin is triggered. The auto-pan line can be defined in the AUTOPAN setup menu.

CRUISE

Select a cruise line for the PTZ camera to execute when an alarm pin is triggered. The cruise line can be defined in the CRUISE setup menu.

- **RETURN TIME**

The PTZ camera starts to count down the RETURN TIME when the PTZ camera is idle, and will execute the function set under SELECT MODE if the return time expires. The RETURN TIME range is from 1 to 128 minutes.

- **GO**

If the HOME function is enabled, the user can also execute the HOME function manually by selecting this option.

- **EXIT**
Exit the HOME SETTING menu.

3.3.14 SEQUENCE

This function carries out pre-positioning of the pan, tilt, zoom and focus features in a certain sequence for a camera. Before setting up this function, the user must set at least two preset points.

SEQUENCE	
SEQUENCE LINE	1
SEQUENCE POINT	01
PRESET POSITION	001
SPEED	1
DWELL TIME	001
RUN SEQUENCE	ENTER
EXIT	YES

- **SEQUENCE LINE**
The PTZ camera has eight built-in sets of sequence lines. First use the LEFT/RIGHT direction keys to select a line and then set the associated sequence points.
- **SEQUENCE POINT**
Up to 32 points can be specified for each sequence line. The sequence points represent the order of the preset points that the PTZ camera will automatically move to and the PRESET POSITION, SPEED and DWELL TIME options are related to this setting.
- **PRESET POSITION**
The user can use this option to assign a specific preset position to the selected sequence point.
- **SPEED**
The user can set the speed at which the PTZ camera moves to the next sequence point, within a range of 1 ~ 15. Refer to the table below for more information.

	Pan (degree/sec.)	Tilt (degree/sec.)
Speed 1	10	8
Speed 2	23	12
Speed 3	35	22
Speed 4	45	30
Speed 5	55	40

Speed 6	65	50
Speed 7	75	58
Speed 8	185	185
Speed 9	205	210
Speed 10	225	240
Speed 11	250	275
Speed 12	280	305
Speed 13	320	335
Speed 14	365	365
Speed 15	400	400

- **DWELL TIME**

The DWELL TIME is the duration for which the PTZ camera will remain at a sequence point and has a range from <0> to <127> seconds. The PTZ camera will move to the next sequence point when the DWELL TIME has expired. If the setting is <0>, the PTZ camera will remain at the sequence point until it is manually moved by the user.

- **RUN SEQUENCE**

The user can command the PTZ camera to run the selected sequence line manually.

- **EXIT**

Select this option to exit the SEQUENCE menu.

3.3.15 **AUTOPAN**

Auto-pan refers to a PTZ camera rotating or scanning in a side-to-side motion to view an area horizontally. The parameters can be set on this page.

AUTOPAN	
AUTOPAN LINE	1
START POINT	TO FIND
END POINT	TO FIND
DIRECTION	RIGHT
SPEED	1
RUN AUTOPAN	ENTER
EXIT	YES

- **AUTOPAN LINE**

The PTZ camera has eight built-in sets of auto-pan lines. The user can select a line to execute using the LEFT/RIGHT direction keys. The user can command the PTZ camera to perform continuous panning with no time limit by setting an identical start and end point.

- **START POINT**

Follow the description to set the start position for the AUTOPAN path.

1. Move the cursor to <START POINT> and press <ENTER> while <TO FIND> is flashing - the option will change to <TO SAVE> automatically.
2. Move the PTZ camera to the desired position and press <ENTER> to save the position as the start point; the cursor will move to <END POINT> automatically. Set the end point to complete the auto-pan setting.



NOTE: The tilt and zoom values for the start point will be recorded and fixed for the selected auto-pan line.

- **END POINT**

The user can set the end point once the start point has been defined. Pan the PTZ camera to another position and press <ENTER> to save the position as the end point.

- **DIRECTION**

This option is used to set the AUTOPAN direction for the PTZ camera. If you select <RIGHT>, the camera will start to pan clockwise from the start point to the end point and then return to the start point. If you select <LEFT>, the camera will start to pan anticlockwise from the start point to the end point. Refer to the diagram below.

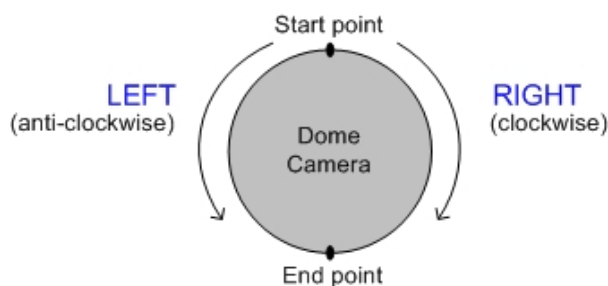

- **SPEED**

This option is used to define the PTZ camera rotation speed while running auto-pan. The speed is adjustable between 1 and 4; refer to the table below for details.

	PAN (degree/sec.)
Speed 1	10
Speed 2	23
Speed 3	35
Speed 4	45

- **RUN AUTOPAN**

Once the setting is complete, select this option to manually execute the auto-pan function.

- **EXIT**

Exit the AUTOPAN menu.

3.3.16 **CRUISE**

A cruise is a sequence of manual operations that can be stored and then called up to be executed repeatedly. It can be made up of pan, tilt position and zoom parameters (zoom setting only on 18×/26× model).

CRUISE	
RECORD START	ENTER
RECORD END	ENTER
RUN CRUISE	ENTER
EXIT	YES

- **RECORD START**

Follow the description to record the CRUISE path.

1. Rotate the PTZ camera to the desired view area and press <ENTER> to create the cruise path using the joystick on the control unit. The percentage of the memory buffer used will be displayed on the screen.
2. Pan and tilt the PTZ camera to create a path. The zoom setting is only available on the 18×/26× model.

 **NOTE:** Pay attention to the memory size when creating the cruise path. Once the buffer percentage reaches 100%, recording of the path will stop.

- **RECORD END**

The cursor will move to RECORD END while you are creating the cruise line; when the setting is complete, press <ENTER> to save the path.

- **RUN CRUISE**

Once the setting is complete, select this option to manually execute the cruise function.

- **EXIT**

Exit the CRUISE menu.

3.3.17 IR FUNCTION (Removable IR Blocking)

The IR blocking filter enables the PTZ camera to capture a clear image at night time or in very dark lighting conditions. During the day, the IR blocking filter is fitted to block the infrared light and ensure a clear image; at night, the IR blocking filter is removed to catch the available infrared rays to view images in black and white. On the 23x model, the user can view colour images when the IR function is activated.

Refer to the description to operate the removable IR blocking filter.

18x 26x Model :

- **AUTO**
The internal circuit will automatically decide when to remove the IR blocking filter based on the lighting conditions calculated by the internal algorithm.
- **ON**
Select this option to remove the IR blocking filter.

23x Model:

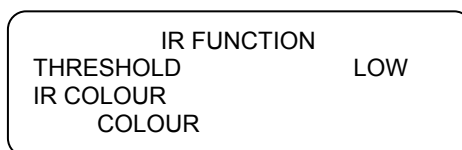

- **AUTO**
The internal circuit will automatically decide when to remove the IR blocking filter based on the image brightness level.

THRESHOLD

The PTZ camera will remove the filter immediately when the threshold value is reached. The threshold options are <LOW>, <MID> and <HI>. A <LOW> threshold indicates a higher sensitivity and can improve the reliability of the lens.

IR COLOUR

When the IR function is enabled, the video output can be programmed as colour or B/W.

- **ON**
Select this option to remove the IR blocking filter.

3.3.18 ALARM DETECT (18x/26x Model Only)

This function instructs the camera to detect movement within the monitoring area and then send an alarm signal automatically. To activate this function, the alarm connection setup must have been completed in advance.

ALARM DETECT	
DETECT SWITCH	OFF
DETECT MODE	INT. FOCU
EXIT	YES

- **DETECT SWITCH**

This option is used to enable or disable the ALARM DETECTION function.

- **DETECT MODE**

Four alarm detection modes are provided for different applications.

INT. FOCUS

The alarm will be triggered if the internal focus changes and will stop if the focus returns to its original position.

FIX FOCUS

If focus movement is detected, the alarm will be triggered and the alarm stops when the focus returns to its original position. If the detected focus movement keeps changing for more than four seconds, the new focus position will be memorized as the reference and the alarm will stop.



NOTE: The INT. FOCUS and FIX FOCUS detection modes will only be activated in auto focus mode.

INT. AE

If auto exposure (AE) movement is detected, the alarm will be triggered and the alarm stops when the exposure returns to its original level.

FIX AE

The alarm will be triggered if the exposure value changes; if the adjusted AE value persists for four seconds, the new value will be saved as the reference and the alarm will stop.

- **EXIT**

Exit this page.

3.3.19 WDR Setting (23x Model Only)

The wide dynamic range function is especially effective in solving indoor and outdoor contrast issues to enhance the image quality and video performance. It enables the PTZ camera to acquire detailed data from the dark areas (indoors) without any saturation from the bright areas (outdoors). The parameters for the WDR function can be set on this page.



NOTE: The backlight function will automatically be turned off when the WDR function is enabled, because the WDR function is more effective than backlight compensation.

WDR SETTING	
WDR SWITCH	OFF
WDR FUNCTION	AUTO
EXIT	YES

- **WDR SWITCH**

Use this option to enable or disable the WDR function.

- **WDR FUNCTION**

This option is used to define the WDR function mode.

AUTO

If you select <AUTO>, the PTZ camera operates the WDR function automatically.

MANUAL

The user can adjust the WDR function manually by defining the RATIO LEVEL, SHUTTER SPEED and IRIS OFFSET values.

WDR MODE	
RATIO LEVEL	000
SHUTTER SPEED	000
IRIS OFFSET	000
EXIT	YES

- **EXIT**

Exit this setup menu.

3.3.20 PRIVACY

The Privacy Mask function is designed to prevent any intrusive monitoring. The user can adjust the camera view position using the joystick and adjust the mask size and area using the direction keys on the control keyboard. The PTZ camera will memorize the centre of the selected view as an original point, which locks the

joystick when the user enters the Privacy Setup menu. Refer to the description below for details of setting privacy masks.



NOTE: The Image Flip function will be disabled automatically while the Privacy function is enabled.

18x/26x Model:

PRIVACY MASK MENU	
PRIVACY SWITCH	ON
TRANSPARENCY	OFF
COLOR	BLACK
SET MASK	01
EXIT	YES

- **PRIVACY SWITCH**

This option allows the user to enable or disable the Privacy Mask function.

- **TRANSPARENCY**

The colour of the privacy mask can be set as transparent in relation to the background image. Select <ON> to display transparent masks.

- **COLOUR**

This option can be used to set the colour of the privacy mask. The available colours are black, heavy grey, light grey, white, red, green, blue, cyan, yellow and magenta.

- **SET MASK**

Use the control unit to move the PTZ camera to the area in which you want to set a mask. Press <ENTER> to enter the MASK SETUP MENU. The camera will memorize this position as the privacy mask position. Up to 24 masks can be set.

MASK01 MENU	
H CENTER	L/R
V CENTER	U/D
H SIZE	000
V SIZE	000
EXIT+SAVE	YES

H CENTER

The original horizontal centre of the mask zone is the centre of the screen; it can be moved to another position by adjusting the horizontal value using the LEFT/RIGHT keys.

V CENTRE

The original vertical centre of the mask zone is the centre of the screen; it can be moved to another position by adjusting the vertical value using the LEFT/RIGHT keys.

H SIZE (00~80)

This option allows the user to adjust the horizontal size of the privacy mask. Setting the H and V size to 0 deletes the selected mask.

V SIZE (00~80)

This option allows the user to adjust the vertical size of the privacy mask. Setting the H and V size to 0 deletes the selected mask.

- **EXIT**

Exit this page.

23x Model:

PRIVACY	
PRIVACY SWITCH	ON
SHADE	GRAY
SET MASK	01
MASK CLEAR+RESET	01
MASK DISPLAY	FIRST
EXIT	YES

- **PRIVACY SWITCH**

This option is used to enable or disable the masking function. Set this item to <ON> before configuring the mask zone.

- **SHADE**

This option can be used to set the colour of the privacy mask. The available colours are black, grey and white.

- **SET MASK**

After pressing <ENTER> for this option, the PTZ camera memorises this position as the privacy mask position. Up to 8 masks can be set. The model prevents the mask zones from being set too close to one another.

MASK01 MENU	
H CENTER	000
V CENTER	000
H SIZE	000
V SIZE	000
EXIT+SAVE	YES

H CENTRE (000~256)

The original centre of the mask zone is the centre of the screen. The user can move the centre of the mask zone to another position by adjusting this value by pressing the LEFT/RIGHT keys.

V CENTRE (000~256)

The original centre of the mask zone is the centre of the screen. The user can move the centre of the mask zone to another position by adjusting this value by pressing the LEFT/RIGHT keys.

H SIZE (000~127)

This option allows the user to adjust the horizontal size of the privacy mask. Setting the H and V size to 0 deletes the selected mask.

V SIZE (000~127)

This option allows the user to adjust the vertical size of the privacy mask. Setting the H and V size to 0 deletes the selected mask.

- **MASK CLEAR+RESET**

This option is used to clear the mask settings for the selected privacy mask. Use the LEFT/RIGHT direction keys to select a mask and then press <ENTER> to erase the configuration.

- **MASK DISPLAY**

This option is used to set when the privacy mask is to be displayed.

FIRST

If you select this mode, the camera will detect the mask zone for the next preset position and display the mask in advance, then pan to the preset point.

LAST

If you select this mode, the camera will move to the preset point, then display the mask zone.



NOTE: On the 23x model, the available area for setting the privacy mask is restricted to a tilt angle of 45° and two mask zones are permitted in a view area.

- **EXIT**

Exit this page.

3.3.21 TIME FUNCTION

This option is used to set the TIME related parameters for the PTZ camera.

TIME SETTING	
TIME DISPLAY	OFF
SET YEAR	05
SET MONTH	10
SET DAY	02
SET HOUR	12
SET MINUTE	12
EXIT+SAVE	YES

- **TIME DISPLAY**

Select <ON> to display the time information on screen, or <OFF> if you do not want to display it.

- **YEAR / MONTH / DAY**

These options are used for setting the system date.

- **HOUR / MINUTE**

These options are used for setting the system time.

- **EXIT+SAVE**

Exit this page.

3.3.22 SCHEDULE FUNCTION

The unique scheduling function enables users to program a preset point or function (sequence/auto-pan/cruise), which is automatically triggered at a certain time.

SCHEDULE	
SCHEDULE SWITCH	ON
SCHEDULE POINT	01
SCHEDULE HOUR	11
SCHEDULE MINUTE	53
SCHEDULE MODE	PRESET
PRESET POINT	001
SCHEDULE RESET	YES
SCHEDULE EXIT	YFS

- **SCHEDULE SWITCH**

Select <ON> to enable the scheduling function or <OFF> to disable.

- **SCHEDULE POINT**

The user can set up 32 scheduling points.

- **SCHEDULE HOUR / MINUTE**

These options are used for setting the time of scheduling points.

- **SCHEDULE MODE**

Used to set the scheduling function for the selected scheduling point; the options are as follows.

NONE

No function will be executed for the schedule.

PRESET

Select one of the defined preset points for the selected schedule.

SEQUENCE

Select one of the eight defined sequence lines for the schedule.

AUTOPAN

Select one of the four defined auto-pan lines for the selected schedule.

CRUISE

Enable the cruise function for the selected schedule.

IR FUNCTION

Select <AUTO> or <ON> to enable the function for the schedule.

3.3.23

EXIT OSD

To exit the OSD setup menu, the user can either select this option or press the ESC button on the control keyboard.

Appendix A: Technical Specifications

Item		22x Model	18x Model	23x Model	26x Model
CAMERA					
Effective pixels	NTSC	380k			
	PAL	440k			
Horizontal resolution	NTSC	480 TV lines			
	PAL	480 TV lines			
Scanning area		Progressive 1/4" CCD	1/4" CCD ExView	Progressive 1/4" CCD	1/4" CCD ExView
Scanning system		PAL, NTSC			
Synchronisation		Internal / Line lock			
Video output		1.0 Vp-p / 75 Ω, BNC			
S/N ratio (AGC OFF)		More than 49dB			
Minimum illumination		1 lux	0.7 lux	0.01 lux, 0 lux (IR illuminator)	0.01 lux, 0 lux (IR illuminator)
Focal length		4~88 mm	4.1~73.8 mm	3.1~73.8 mm	3.5~91 mm
Zoom ratio		22x optical zoom	18x optical zoom	23x optical zoom	26x optical zoom
Digital zoom		×1 ~ ×12 variable			
Focus mode		Auto / Manual			
White balance		Auto / Manual			
Iris control		Auto / Manual			
Electronic shutter	NTSC	1/2~1/4k sec.	1/1~1/10k sec.	1/2~1/4k sec.	1/1~1/10k sec.
	PAL	1/1.5~1/4k sec	1/1~1/10k sec	1/1.5~1/4k sec	1/1~1/10k sec
AGC control		Auto / Manual			
Back light compensation		On / Off			
OPERATION					
Built-in protocols		Ganz-S , Ganz-PT, Pelco-P&D, VCL, Philips, AD-Manchester, AD-422 etc.			
Pan travel		360° continuous			
Tilt travel		-10°~100°	-10°~190°		
Manual speed		1°~90°/s			
Presets		256			
Preset accuracy	Pan	0.225°			
	Tilt	0.45°			
Preset speed**	Pan	5°~400°/s, high resolution (both D&E type motor)			
	Tilt	5°~400°/s, standard resolution (D type motor) 5°~400°/s, high resolution (E type motor)			
Cruise		1			
Sequence		8			
Auto pan		4			
Privacy mask		-	24	8	24
Pan & tilt proportional to zoom ratio		Yes	Yes	Yes	Yes
P/T/Z auto-restore		Yes	Yes	Yes	Yes
Auto turn around		Yes	Yes	Yes	Yes
Zone title		Yes	Yes	Yes	Yes
Home function		Yes	Yes	Yes	Yes
Digital flip		-	Yes	Yes	Yes
Digital slow shutter		-	Yes	Yes	Yes
Motion detection		-	Yes	-	Yes
Wide dynamic range		-	-	Yes	-
Day/night: IR cut filter		-	-	Yes	Yes
GENERAL					
Environment		Indoor / Outdoor			
Controller interface		RS-485			
Operating temperature		Indoor: 0°C~40°C (32°F~104°F) Outdoor: -50°C~50°C (-58°F~122°F)			
Waterproof standard		IP 66 Standard (outdoor only)			
Dimensions	Indoor	□131 × 226 mm (5.2 x 7.6 inches)			
	Outdoor	□172 x 302.5mm (6.7 x 11.9 inches)			
		□190 x 302.5mm (7.5x 11.9 inches), with sunshield			
Weight	Indoor	1.6kg (3.5 lbs)			
	Outdoor	5.8 kg (12.9 lbs)			
Power source	Indoor	AC 24 V			
	Outdoor	AC 24 V			
Power consumption		30 W / 52 W (with heater)			
Regulatory standards		CE, FCC, IP66			

**D&E motors are available for different PTZ cameras and featuring various "Preset speeds" and resolutions. Standard resolution: 800 steps/resolution. High resolution: 1600 steps/resolution.

OSD Menu Notes

The following OSD menu tables are provided for users to record the PTZ camera settings.

<18x/26x Model>

Item	Layer 1	Layer 2	Layer 3	Note	
DEFAULT CAMERA	<ON>, <OFF>				
BACKLIGHT	<ON>, <OFF>				
FOCUS	AUTO	AF mode <Normal>, <Interval>, <Zoom trigger>			
	MANUAL	Manual focus speed <01> - <08>			
AE MODE	AUTO	Exposure comp. <OFF>, <1>~<15>			
	BRIGHT	Bright <0> ~ <31>			
	SHUTTER	Shutter speed <1> ~ <1/10000> sec.			
	GAIN	Gain <-3> ~ <28>dB			
	IRIS	Iris <Close>, <F1.6> ~ <F28>			
WBC MODE	AUTO (Auto white balance)				
	INDOOR				
	OUTDOOR				
	ATW (Auto-tracing WBC)				
	MANUAL	R gain <000> ~ <128> B gain <000> ~ <128>			
ID DISPLAY	<ON>, <OFF>				
SETUP MENU 1	FLIP	<IMAGE>, <M.E.>, <OFF>			
	ZOOM SPEED	<1> ~ <8>			
	SPEED BY ZOOM	<ON>, <OFF>			
	AUTO CALI.	<ON>, <OFF>			
	DIGITAL ZOOM	<ON>, <OFF>			
	SLOW SHUTTER	<ON>, <OFF>			
	ANGLE ADJUSTER	ADJUST MIN ANGLE			
		ADJUST MAX ANGLE			
		RESET			
	RESET	<YES>			
EXIT					
SETUP MENU 2	APERTURE	<01> ~ <16>			
	MASK DISPLAY	<FIRST>, <LAST>			
TITLE DISPLAY	<ON>, <OFF>				
TITLE SETTING	<01> ~ <16>				
ALARM SETTING	ALARM PIN	<1> ~ <8>			
	ALARM SWITCH	<ON>, <OFF>			
	ALARM TYPE	<N.O.> (Normally open), <N.C.> (Normally closed)			
	ALARM ACTION	PRESET			
		SEQUENCE			
		AUTOPAN			
		CRUISE			
	PRESET POINT	<001> ~ <256>			
	SEQUENCE LINE	<1> ~ <8>			
	AUTOPAN LINE	<1> ~ <4>			
CRUISE LINE	<1>				
DWELL TIME	<001> ~ <127> Sec., <ALWAYS>				
EXIT	YES				
HOME SETTING	HOME FUNC.	<ON>, <OFF>			
	SELECT MODE	PRESET			
		SEQUENCE			
		AUTOPAN			
		CRUISE			
	PRESET POINT	<001> ~ <256>			
	SEQUENCE LINE	<1> ~ <8>			
	AUTOPAN LINE	<1> ~ <4>			
	CRUISE LINE	<1>			
	RETURN TIME	<001> ~ <128> min.			
GO	ENTER				
EXIT					
SEQUENCE	SEQUENCE LINE	<1> ~ <8>			
	SEQUENCE POINT	<01> ~ <32>			

Item	Layer 1	Layer 2	Layer 3	Note
	PRESET POS.	<001> ~ <255>, <END>		
	SPEED	<01> ~ <15>		
	DWELL TIME	<000> ~ <127> sec.		
	RUN SEQUENCE			
	EXIT			
AUTOPAN	AUTOPAN LINE	<1> ~ <4>		
	START POINT	<TO FIND>, <TO SAVE>		
	END POINT	<TO FIND>, <TO SAVE>		
	DIRECTION	<RIGHT>, <LEFT>		
	SPEED	<01> ~ <04>		
	RUN AUTOPAN			
	EXIT			
CRUISE	RECORD START			
	RECORD END			
	RUN CRUISE			
	EXIT			
IR FUNCTION (18x/26x model only)	<AUTO>, <ON>			
ALARM DETECT	DETECT SWITCH	<ON>, <OFF>		
	DETECT MODE	<INT. FOCUS>, <FIX FOCUS>, <INT. AE>, <FIX AE>		
	EXIT			
PRIVACY	PRIVACY SWITCH	<ON>, <OFF>		
	TRANSPARENCY	<ON>, <OFF>		
	COLOUR	<BLACK>, <HEAVY GRAY>, <LIGHT GRAY>, <WHITE>, <RED>, <GREEN>, <BLUE>, <CYAN>, <YELLOW>, <MAGENTA>		
	SET MASK	<01> ~ <24>	H CENTRE <L>, <R> V CENTRE <D>, <U> H SIZE <00> ~ <80> V SIZE <00> ~ <60>	
	EXIT	YES		
TIME	TIME DISPLAY	<ON>, <OFF>		
	SET YEAR			
	SET MONTH			
	SET DAY			
	SET HOUR			
	SET MINUTE			
	EXIT+SAVE			
SCHEDULE	SCHEDULE SW.	<ON>, <OFF>		
	SCHEDULE POINT	<01> ~ <32>		
	SCHEDULE HOUR			
	SCHEDULE MIN			
	SCHEDULE MODE	NONE PRESET SEQUENCE AUTOPAN CRUISE IR FUNC.		
	NO FUNCTION			
	PRESET POINT	<1> ~ <256>		
	SEQUENCE LINE	<1> ~ <8>		
	AUTOPAN LINE	<1> ~ <4>		
	CRUISE LINE	<1>		
	IR FUNCTION	<AUTO>, <ON>		
SCHEDULE RESET	YES			
SCHEDULE EXIT				
EXIT OSD	YES			

<22x/23x Model>

Item	Layer 1	Layer 2	Layer 3	Note	
DEFAULT CAMERA	<ON>, <OFF>				
BACKLIGHT	ON	BLC level <000> ~ <100>			
	OFF				
FOCUS	AUTO	Focal length <1cm>, <10cm>, <30cm> <1m>			
	MANUAL	<01> ~ <08>			
APERTURE	AUTO				
	MANUAL	H APERTURE <00> ~ <31> V APERTURE <00> ~ <31>			
AE MODE	AUTO	IRIS OFFSET <00> ~ <99>			
	SHUTTER	SHUTTER SPEED <1/2> ~ <1/30000>			
	IRIS	IRIS <00> ~ <09>			
	AGC	AGC <00> ~ <05>			
WBC MODE	AUTO				
	MANUAL	R gain <00> ~ <99> B gain <00> ~ <99>			
ID DISPLAY	<ON>, <OFF>				
SETUP MENU	FLIP	<IMAGE>(23x model only), <M.E.>, <OFF>			
	ZOOM SPEED	<FAST>, <SLOW>			
	SPEED BY ZOOM	<ON>, <OFF>			
	AUTO CALI.	<ON>, <OFF>			
	DIGITAL ZOOM	<1> ~ <12>, <OFF>			
	SLOW SHUTTER (23x model only)	<1/2> ~ <1/60> sec. (NTSC) <1/1.5> ~ <1/50> sec. (PAL)			
	ANGLE ADJUSTER	ADJUST MIN ANGLE			
		ADJUST MAX ANGLE			
		RESET			
RESET	YES				
EXIT					
TITLE DISPLAY	<ON>, <OFF>				
TITLE SETTING	<01> ~ <16>				
ALARM SETTING	ALARM PIN	<1> ~ <8>			
	ALARM SWITCH	<ON>, <OFF>			
	ALARM TYPE	<N.O.>, <N.C.>			
	ALARM ACTION	PRESET			
		SEQUENCE			
		AUTOPAN CRUISE			
	PRESET POINT SEQUENCE LINE AUTOPAN LINE CRUISE LINE	<001> ~ <256> <1> ~ <8> <1> ~ <4> <1>			
	DWELL TIME	<001> ~ <127> sec., ALWAYS			
EXIT	YES				
HOME SETTING	HOME FUNC.	<ON>, <OFF>			
	SELECT MODE	PRESET			
		SEQUENCE			
		AUTOPAN			
		CRUISE			
	PRESET POINT SEQUENCE LINE AUTOPAN LINE CRUISE LINE	<001> ~ <256> <1> ~ <8> <1> ~ <4> <1>			
	RETURN TIME	<001> ~ <128> min.			
	GO	ENTER			
EXIT	YES				
SEQUENCE	SEQUENCE LINE	<1> ~ <8>			
	SEQUENCE POINT	<01> ~ <32>			
	PRESET POS.	<001> ~ <255>, <END>			
	SPEED	<01> ~ <15>			
	DWELL TIME	<000> ~ <127> sec.			
	RUN SEQUENCE	ENTER			
EXIT					
AUTOPAN	AUTOPAN LINE	<1> ~ <4>			
	START POINT	<TO FIND>, <TO SAVE>			
	END POINT	<TO FIND>, <TO SAVE>			
	DIRECTION	<RIGHT>, <LEFT>			

Item	Layer 1	Layer 2	Layer 3	Note
	SPEED	<01> ~ <04>		
	RUN AUTOPAN	ENTER		
	EXIT			
CRUISE	RECORD START			
	RECORD END			
	RUN CRUISE			
	EXIT			
IR FUNCTION (23× model only)	AUTO	THRESHOLD	<LOW>, <MID>, <HI>	
		IR COLOUR	<B/W>, <COLOUR>	
		EXIT		
	ON			
WDR SETTING (23× model only)	WDR SWITCH	<ON>, <OFF>		
	WDR FUNCTION	AUTO		
		MANUAL	RATIO LEVEL <000>~<128>	
			SHUTTER LEVEL <000>~<128>	
	EXIT	IRIS OFFSET <000>~<128>		
PRIVACY (23× model only)	PRIVACY SWITCH	<ON>, <OFF>		
	SHADE	<BLACK>, <WHITE>, <GREY>		
	SET MASK	<1> ~ <8>	H CENTRE <000> ~ <256>	
			V CENTRE <000> ~ <256>	
			H SIZE <000> ~ <127>	
			V SIZE <000> ~ <127>	
	MASK CLEAR+RESET	<01> ~ <08>		
	MASK DISPLAY	<FIRST>, <LAST>		
EXIT	YES			
TIME	TIME DISPLAY	<ON>, <OFF>		
	SET YEAR			
	SET MONTH			
	SET DAY			
	SET HOUR			
	SET MINUTE			
	EXIT+SAVE			
	SCHEDULE	SCHEDULE SWITCH	<ON>, <OFF>	
SCHEDULE POINT		<01> ~ <32>		
SCHEDULE HOUR				
SCHEDULE MIN				
SCHEDULE MODE		NONE		
		PRESET		
		SEQUENCE		
		AUTOPAN		
		CRUISE		
		IR FUNC.		
NO FUNCTION				
PRESET		<1> ~ <256>		
SEQUENCE LINE		<1> ~ <8>		
AUTOPAN LINE	<1> ~ <4>			
CRUISE LINE	<1>			
IR FUNCTION	<AUTO>, <ON>			
SCHEDULE RESET				
SCHEDULE EXIT				
EXIT OSD	YES			

Specifications are subject to change without notice



CBC Co.,Ltd.
Tokyo, Japan
www.GANZ.jp

Free Manuals Download Website

<http://myh66.com>

<http://usermanuals.us>

<http://www.somanuals.com>

<http://www.4manuals.cc>

<http://www.manual-lib.com>

<http://www.404manual.com>

<http://www.luxmanual.com>

<http://aubethermostatmanual.com>

Golf course search by state

<http://golfingnear.com>

Email search by domain

<http://emailbydomain.com>

Auto manuals search

<http://auto.somanuals.com>

TV manuals search

<http://tv.somanuals.com>