

CONTENTS

INSTALLATIONS MANUAL

| | |
|--|---|
| 1 / SAFETY INSTRUCTIONS | |
| • Important warnings _____ | 4 |
| 2 / INSTALLING YOUR DISHWASHER | |
| • Free-standing appliances _____ | 5 |
| • Built-in appliances _____ | 5 |
| • Sound-Proofing seals _____ | 6 |
| • Appliances built-in under a hob _____ | 6 |
| • Levelling by adjusting the feet _____ | 6 |
| • Connecting to the water supply _____ | 7 |
| • Draining away the waste water _____ | 8 |
| • Connecting to the electricity supply _____ | 9 |



Important :

Please read this instructions manual carefully so that you can comply with the instructions for installing and fitting your machine.



NB :

This instructions manual covers various models. There may be some slight differences between your appliance and the descriptions shown.

• **IMPORTANT WARNINGS**



Important :

After unpacking your appliance, make sure that it has not suffered any damage during transport. Never connect up a damaged appliance. If your appliance is damaged, please contact your dealer.



Danger :

If your appliance operates incorrectly, disconnect it (pull out the plug) or switch off the circuit concerned and close the water supply tap. Contact our After-Sales Service.



Important :

All the necessary electrical and plumbing work for installing the appliance must respectively be carried out by a qualified electrician or plumber.

- Once you have installed your appliance, ensure that it is not resting on the power cable or the water supply or drain hoses.
- The appliance must be kept disconnected from the mains supply throughout the whole installation process.
- Check that your appliance's Earth circuit complies with the prevailing regulations.
- The electrical connection details on the manufacturer's plate on your machine must match those for the mains power supply.



Important :

For safety's sake, do not leave your dishwasher's door fully open after use. If your dishwasher is being installed on a carpeted floor, ensure that the feet are set to leave an air space under the appliance.

2 / INSTALLING YOUR DISHWASHER

• FREE-STANDING APPLIANCES

You can use the top of the appliance as a worktop.

NB:

Do not position your dishwasher too close to a heat source; otherwise the trim around the top could be damaged.

• BUILT-IN APPLIANCES

• Installation dimensions

By removing the appliance's worktop you can build in your appliance under an existing worktop provided that the space conforms to the dimensions on the sketch. (Fig. 01)

• Building in your appliance under a worktop

If you are building in your appliance under an existing worktop:

- Remove the top of the appliance by unscrewing the two screws under the edge of the top (Fig. 02).
- Remove the top by unclipping it from the back of the appliance and pushing it a few cm to move it (Fig. 03).
- Lift the top of your dishwasher to release it (Fig. 03).
- Insert the dishwasher into its appropriate space
- Adjust the height of the feet, if necessary (please refer to the Section: "Levelling by adjusting the feet").
- Fasten your dishwasher to the kitchen worktop with two screws under the front of the plastic lip (Fig 04).

If your worktop is marble or a similar material, you can fasten your dishwasher at the side with two brackets (available from After-Sales or your dealer).

You can also incorporate your appliance into a vertical unit (raised above the ground).

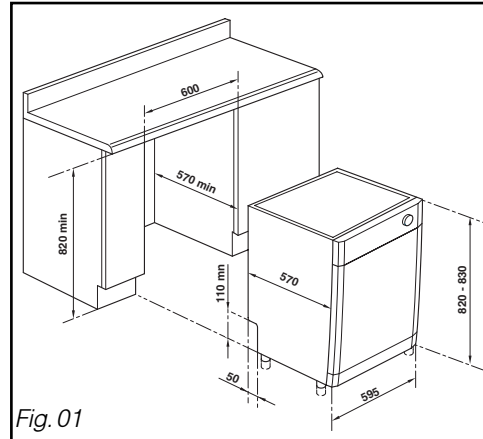

Fig. 01

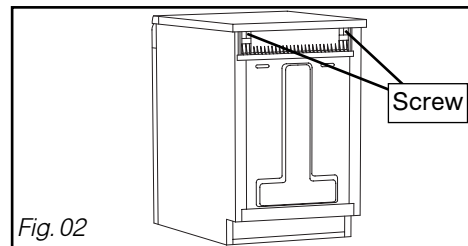

Fig. 02

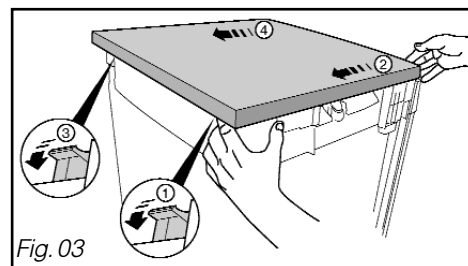

Fig. 03

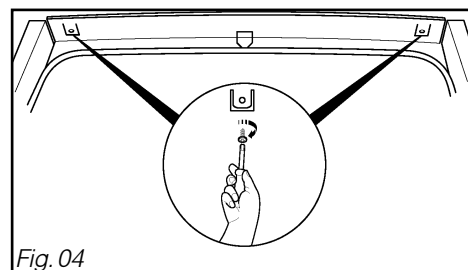

Fig. 04

2 / INSTALLING YOUR DISHWASHER

• SOUND-PROOFING SEALS

To improve the built-in appliance's sound-proofing, fit the sound-proofing seals (depending on the model). (1 2 on Fig. 05)

If the recess is bigger, stick on seal 1 using the adhesives provided.

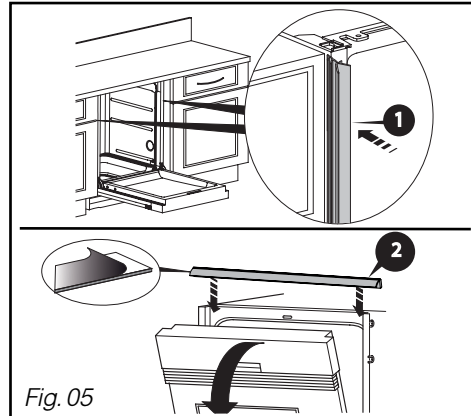

• APPLIANCES BUILT-IN UNDER A HOB



Danger :

If your worktop has a hob fitted above your dishwasher, you must fit thermal insulation on top of your dishwasher. You can obtain an insulation panel from your dealer. Remember to leave a space between the gas pipe and the top of your dishwasher.

• LEVELLING BY ADJUSTING THE FEET

Ensure that your dishwasher is quite plumb and stable and that it is in the place where it will be installed. The feet are adjustable. Use a screwdriver to adjust them, if necessary, so that the door closes and seals perfectly (Fig.06).

Ensure that the dishwasher's door closes correctly, without catching at the sides.

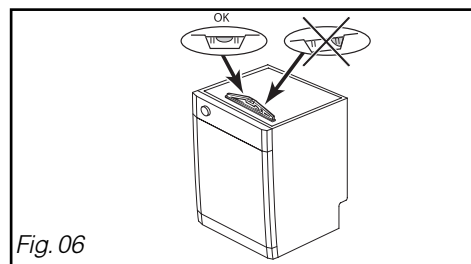

2 / INSTALLING YOUR DISHWASHER

• CONNECTING TO THE WATER SUPPLY

This dishwasher can be supplied with cold water or hot water up to a maximum of 60°C. When supplying with hot water, check that your original hose allows such connection (red marking on the hose). However, we recommend that you connect to the cold water supply. Your appliance is fitted with a supply hose 1.50m long.

Connect the hose to a tap with a threaded end, diameter 20/27 (3/4" BSP).

Check that the water pressure does not exceed the values below:

Flow rate: 10 L/min (1 L/min minimum)

Pressure: 1 to 10 bars (0.1 - 1 MPa) (Fig. 07)

If the water pressure is too high, please fit a pressure regulator. Your Water department will advise you of the water pressure in your region.

Warning :
! *If you use a self-piercing tap, check that there is sufficient water flow. Check that the hose seal is present and that the connection is tight. (Fig. 05) Do not re-use any previously used hoses for making the connection.*

Avoid any kinks or constrictions in the hose, which could prevent the water from passing or slow down its flow, particularly when building in the appliance under the worktop. (Fig. 8).

If the appliance is connected to new pipes or pipes that have not been used for a certain length of time, let the water run for a few minutes before connecting the water hose to avoid and deposits of sand or rust that could block the water hose's filter.

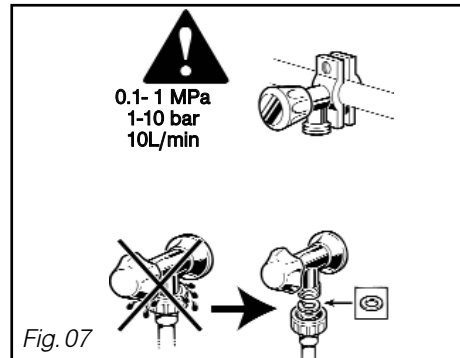

Danger : **⚡** *The symbol ⚡ indicates that the hose is fitted with an electrical device for cutting off the water supply (depending on the model). Do not leave this hose in water and do not cut it.*

NB: **🔍** *Any connection to a water conduit necessarily involves the risk of a leak occurring, whatever the precautions taken. Therefore, always close the water tap when you are not using your machine.*

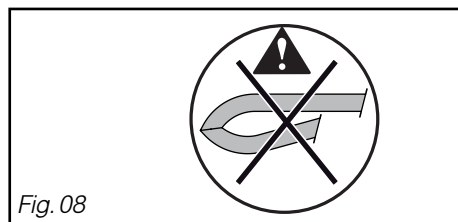

2 / INSTALLING YOUR DISHWASHER

• DRAINING AWAY THE WASTE WATER

You can connect the end of the drain hose to:

- A ventilated U-bend (Fig. 9) or
- A sink U-bend (Fig. 9) or
- The edge of the sink, using the special plastic hook provided (depending on the model) (Fig. 11).

When connecting to a U-bend, you must remove the flapper from the U-bend. Then fully install the rubber end. If necessary, add a tightening collar (Fig. 10).

NB :
Ensure that the drain hose is held in place with a tie to avoid any potential flooding.

The drain connection must be 0.40m (minimum) to 1m (maximum) above the floor (Fig. 9).

If necessary, you can increase the hose's length (up to 3m maximum). In this case, check that the appliance drains correctly. The hose must rest on the floor and only rise vertically close to the drainage system.

For appliances installed in vertical units, the drainage system must not rise higher than the top of the appliance.

! Important :
*When fitting the hose, pull on it gradually so as not to kink it. (Fig. 8)
Avoid any kinks or constrictions in the hose, which could prevent the water from passing or slow down its flow.*

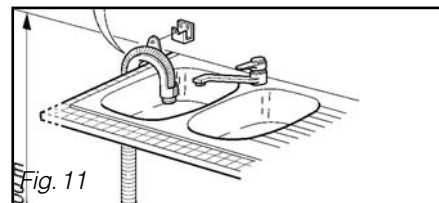
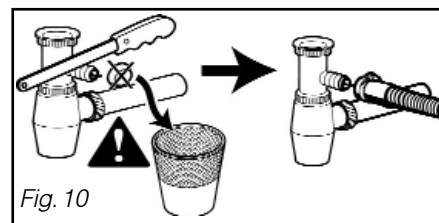
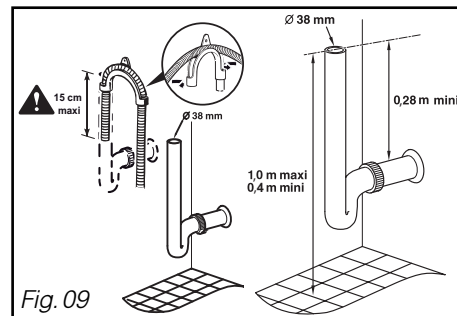

2 / INSTALLING YOUR DISHWASHER

• ELECTRICAL CONNECTION

The appliance must be at a standstill when connecting to the electricity supply circuit.

Before connecting your appliance, ensure that:

- The mains voltage indicated on the manufacturer's plate on your machine (230V) matches the voltage supplied by your installation.
- Your meter and the fuses can support the current. A 16A fuse is the minimum requirement.

If you must connect your appliance to a different voltage from that indicated on your machine, connect an appropriate transformer.

NB :  Use the services of a qualified electrician to make the modifications and ensure that your electrical installation complies with the regulations.

This appliance must necessarily be connected directly to an earthed plug and socket. In all cases, it must be connected in accordance with the prevailing regulations in the country concerned and any additional regulations from the local electricity utility.

Warning :  The plug and socket must be accessible even after your appliance has been installed. The appliance must not be connected via an extension lead, a multiple socket or an electric time delay programmer. (Fig. 12)

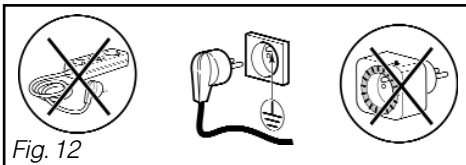

We cannot be held responsible in the event of an accident or an incident caused by the lack of or a defective earthing system.

Your dishwasher complies with European Directives 73/23/EEC (Low Voltage Directive) and 89/336/EEC (Electromagnetic Compatibility) as modified by Directive 93/68/EEC.

• Replacing the power cable

Danger :  For your safety's sake, this operation must only be performed by the manufacturer's After-Sales Department or by someone with similar qualifications in order to avoid any risks.

• Appliances delivered without a plug

Danger :  The wires in your appliance's power cable are coloured as follows:

| | |
|------------------|---------|
| - Green & Yellow | Earth |
| - Blue | Neutral |
| - Brown | Live |

If the cable's colours do not match your plug, proceed as follows:

The wire coloured green and yellow must be connected to the connector in your plug marked with the letter E, the symbol \perp or coloured green and yellow.

The blue-coloured wire must be connected to the connector marked with the letter N or coloured black.

The brown-coloured wire must be connected to the connector marked with the letter L or coloured red.

NOTES

CONTENTS

INSTRUCTION MANUAL

| | |
|--|----|
| 1/ FOR THE USER'S ATTENTION | |
| • Safety instructions _____ | 12 |
| • Environmental protection _____ | 13 |
| • Economical, environmentally friendly washing _____ | 13 |
| 2/ DESCRIPTION OF YOUR APPLIANCE | |
| • General presentation of the dishwasher _____ | 14 |
| • Presentation of the control panel _____ | 15 |
| 3/ INFORMATION _____ | 16 |
| 4/ WHAT TO DO BEFORE FIRST USING THE MACHINE | |
| • Measure the water hardness and select the type of detergent ____ | 17 |
| • Hardness table _____ | 17 |
| 5/ DETERGENT PRODUCTS AND ADJUSTING THE WATER SOFTENER | |
| • For traditional products _____ | 18 |
| • For multi-purpose products _____ | 19 |
| 6/ FILLING WITH REGENERATING SALT _____ | 20 |
| 7/ FILLING WITH RINSE AID _____ | 21 |
| 8/ YOUR DISHWASHER'S EQUIPMENT | |
| • The lower basket _____ | 22 |
| • The upper basket _____ | 23 |
| • The cutlery basket _____ | 24 |
| 9/ YOUR DISHWASHER'S SAFETY SYSTEMS _____ | 25 |
| 10/ WASHING PROGRAMMES TABLE _____ | 26 |
| 11/ PROGRAMMING _____ | 28 |
| 12/ CLEANING YOUR APPLIANCE | |
| • Cleaning the waste filters _____ | 29 |
| 13/ IF OPERATING ABNORMALITIES OCCUR _____ | 31 |
| 14/ INDICATIONS FOR THE TESTING LABORATORIES _____ | 37 |

1/ FOR THE USER'S ATTENTION

 **Important :** *Keep this user's manual with your appliance. If the appliance is sold or transferred to someone else, ensure that the manual is with it. Please take note of these instructions before installing and using your appliance. They have been drawn up for your own and other people's safety.*

• SAFETY INSTRUCTIONS

• Installation

- When you receive your appliance, unpack it or have it unpacked immediately. Check that it has not suffered any damage during transport. Express any reservations in writing on the delivery note, of which you keep a copy. Never connect up a damaged machine. If your appliance is damaged, please contact CDA Customer Care.
- Before proceeding to connect up your machine, please refer to the instructions in your Installation Guide.
- Your dishwasher must be kept disconnected from the mains supply throughout the whole of the installation process.
- The electrical connection details on your appliance's description plate must comply with those for the mains supply.
- The socket must still be accessible once your appliance has been installed.
- Do not alter or attempt to alter the appliance's characteristics. This could put you at risk.
- If your installation has to be altered, only entrust the electrical and plumbing work to a qualified electrician or plumber respectively.
- Your appliance is designed for normal domestic use. Do not use it for industrial or commercial purposes or for any other purpose than that for which it has been designed.
- The dishwasher's walls must not be pierced under any circumstances.

• Children's safety

- This appliance is not intended for use by young children or infirm persons unless they have been adequately supervised by a responsible person to ensure that they can use the appliance safely.
- This appliance must only be used by adults. Ensure that children do not touch it and do not use it as a toy. Ensure that they do not operate the appliance's controls.
- Keep young children away from the appliance when it is operating.
- Detergents contain irritant and abrasive substances. These products can have caustic effects on the eyes, the mouth or the throat. They can be extremely dangerous if ingested. Avoid any contact with the skin and the eyes. Ensure that the appliance's detergent container is empty at the end of the washing cycle.
- Place detergents out of children's reach and do not put any detergent in the machine until just before you start the washing programme.
- The water in your dishwasher is not drinking water; this is why children must not go near the appliance when its door is open.
- Do not let your children play or sit on the door when it is open.
- Once you have unpacked your appliance, place the packaging out of children's reach.
- Keep all the packaging materials (e.g. plastic bags, polystyrene, etc.) out of children's reach because they can be dangerous for children (ie. risk of suffocation).

• Use

- When machine is running, do not open door. This may provoke steam leakage or splashing of water.
- Only use products specially designed for your dishwasher (regenerating salt, detergent and rinse aid).
- As far as possible, avoid opening the dishwasher's door when it is operating, and in particular during the heating phases, because scalding steam may escape or you may be splashed with hot water. The machine is fitted

1/ FOR THE USER'S ATTENTION

- with a safety system that immediately blocks the dishwasher's operation if the door is opened.
- Never use chemical solvents in your appliance because these could cause an explosion.
 - Always close your appliance's door after loading or removing your items.
 - Do not lean or sit on your appliance's door when it is open.
 - You are strongly advised to disconnect the machine after use and turn off the water supply.
 - Unplug your machine before carrying out any technical work on it.
 - Avoid placing your machine immediately next to a cooking or heating appliance to prevent any risk of heat damage;
 - Do not place any items in your machine, which are not certified as dishwasher safe.
 - If you have removed an item before the end of the washing programme, it is important to rinse it carefully to remove any residual washing products.
 - If your appliance breaks down, never attempt to repair it yourself. Any repairs made by non-qualified personnel can cause significant damage or product failure.
 - The machine complies with applicable safety regulations. Any repairs should be carried out by qualified technicians. Repairs or changes that do not conform may be dangerous for the users. In case of replacement, only use original parts.
 - If the machine malfunctions due to other causes than those mentioned in this booklet, disconnect the machine (remove the plug) or break the circuit concerned and contact CDA Customer Care.

• ENVIRONMENTAL PROTECTION

This appliance's packaging material is recyclable. Help recycle it and protect the environment by disposing of it in compliance with local waste disposal laws.

Broken machines should be taken to the closest recycling centre. Destroy the door closing system so it no longer works (children may close themselves in whilst playing and suffocate). Cut the electric cable after having removed the plug from the socket.

Your appliance also contains a great amount of recyclable material. It is marked with this label to indicate the used appliances that should not be mixed with other waste. This way, the appliance recycling organised by your manufacturer will be done under the best possible conditions, in compliance with European Directive 2002/96/EC on Waste Electrical and Electronic Equipment. Contact your council for the used appliance collection points closest to your home.



We thank you doing your part to protect the environment.

• ECONOMICAL, ENVIRONMENTALLY FRIENDLY WASHING

- Remove any food residue from your crockery (bones, pips, etc.)
- Do not pre-wash your items by hand.
- Utilise your dishwasher's capabilities to the full for an economical, environmentally friendly wash.
- Always select a washing programme suitable for the crockery type and how dirty they are.
- Avoid overdosing with detergent, regenerating salt and rinsing liquid. Follow the recommendations in this guide (pages 17 - 18) and the instructions on the product packs.
- Ensure that the water softener is correctly set (see pages 18 - 19).

2/ DESCRIPTION OF YOUR APPLIANCE

• GENERAL PRESENTATION OF THE DISHWASHER

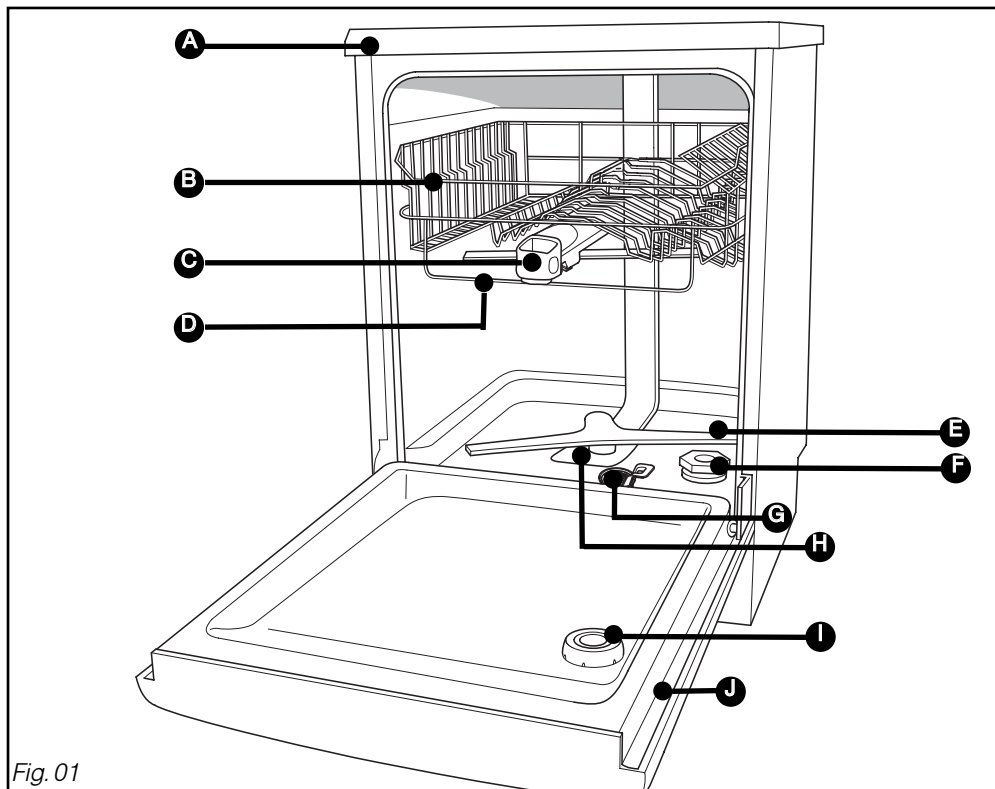

Fig. 01

- | | |
|-------------------------------------|---|
| A Removable top | F Regenerating salt tank |
| B Upper basket | G Waste filter |
| C Washing products dispenser | H Main filter |
| D oversized plate barrier | I Rinsing product dispenser |
| E Lower sprinkler arm | J Description plate (Model number) |



Advice:

This user's guide is applicable to several models. There may be some slight differences in the details and the equipment between your appliance and the descriptions provided here.

2/ DESCRIPTION OF YOUR APPLIANCE

• PRESENTATION OF THE CONTROL PANEL

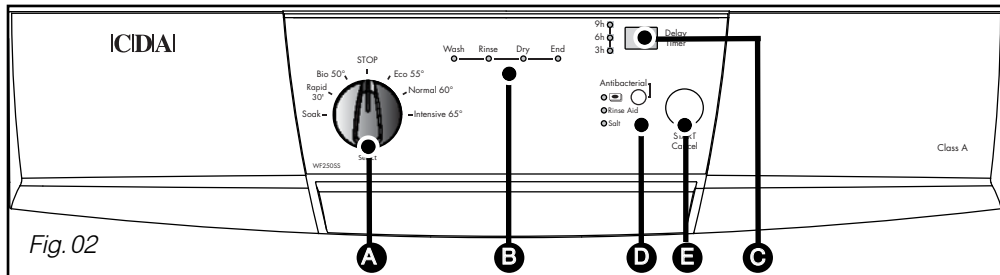

A Selector switch (3 functions):

- **Choosing a programme:** Turn the selector switch to choose a programme.
- **selector switch:** Turn the switch to the Select position to access Select options. (See Section 5, / Detergent products and adjusting the water softener).
- **Off:** Turn the switch to the "STOP" position when the programme has finished.

B Programme progress:

Wash Rinse Dry End This shows you the programme's progress.

C Delay Timer: Press this button to delay the start of the programme by 3, 6 or 9 hours.

D : "Antibacterial" Multipurpose-products button

Press this button if you use "4-in-1" tablets.

E Start / Cancel: Briefly press this button to start your programme. If you make an error, to cancel a selection or cancel a programme while it is running, hold down this button for 3 seconds.

The indicator lights:

Salt:

When lit, it indicates lack of regenerating salt

Rinse aid

When lit, it indicates lack of rinse aid.

Washing product:

Indicates that your dishwasher is set for using "2, 3, or 4-in-1" tablets.

3/ INFORMATION

 **Important:**
To obtain impeccable washing and drying results from your dishwasher without any marks, you must set it carefully using the water softening system, which utilises regenerating salt.

As rainwater infiltrates into the ground it picks up mineral salts; some minerals are found in solid form and are commonly called 'lime'. This reduces the detergent's washing performance and leaves white marks on the crockery. The more lime there is in the water, the 'harder' the water is.

- Use the most suitable washing products for the hardness of your town's water supply.
- There are several types of products:

For an impeccable clean, opt for using traditional products together:

- ① **Washing product** for a perfect clean (standard powder, liquid or tablets).
- ② **Regenerating salt** for your dishwasher's water softener to work correctly.
- ③ **Rinse aid** to assist drying and eliminate drip marks.

 **Important:**
Never use normal washing-up liquid.

For ease of use and in certain water hardness conditions only (<35°F), multi-purpose products can make the use of regenerating salt and rinse aid unnecessary.

- **"Two-in-one" tablets** contain detergents and rinsing liquid or an agent serving the function of the salt.
- **"Three-in-one" tablets** contain detergents and rinsing liquid as well as an agent serving the function of the salt.
- **"Four-in-one" tablets** also contain additives that prevent wear on poor quality glasses or the risk of stainless items corroding.

 **Important:**
Follow the instructions in the user's manual and the recommendations on the multi-purpose detergent's pack.

 **NB:**
If in any doubt, please contact the detergent's manufacturer if the items are very wet at the end of the programme or if chalky deposits appear.

4/ WHAT TO DO BEFORE FIRST USING THE MACHINE

• MEASURE THE WATER HARDNESS AND SELECT THE TYPE OF DETERGENT: TRADITIONAL OR MULTI-PURPOSE

In one simple action, you can test your water's lime content using the testing strip supplied with your dishwasher. Alternatively, contact your local water utility to ascertain your water's hardness.

- Let the water run from the tap for a few moments.
- Fill a glass with water.
- Take the test strip from its holder and immerse it for 3 seconds.
- Wait 1 minute, shake it and look at the colours to ascertain your water's hardness.



• HARDNESS TABLE

| Test strip | | | | | | |
|---------------------------------|----------|---|---|-----------|-----------|-----------|
| Hardness | 0-10°F | 10-25°F | 25-40°F | 40-55°F | 55-70°F | > 70°F |
| Water | Soft | Slightly hard | Slightly hard | Hard | Hard | Very hard |
| Water softening and use of salt | Optional | Essential if using traditional products | Essential if using traditional products | Mandatory | Mandatory | Mandatory |

| | |
|---|--|
| <p>Possible use of traditional products ①</p> <p>① + + </p> <p>or ② Multi-purpose</p> <p>② </p> | <p>Use only of traditional products ①</p> <p> + + </p> |
|---|--|

① Traditional products:

P : Powder detergent or L : Liquid detergent + S : Regenerating Salt + R : Rinse aid

② Multi-purpose products: Multi-purpose tablets

5/ DETERGENT PRODUCTS AND ADJUSTING THE WATER SOFTENER

• FOR TRADITIONAL PRODUCTS

- **Your machine must be specially adjusted to use traditional products.**

• To adjust the water softener using the control panel:

Turn the selector switch to "Select". The six indicators' lights come on, meaning you are in adjustment mode.

- Press the "Delay Timer" button once. The setting is indicated by the indicators' lights flashing on and off (factory setting: 40 to 55°F).
- To change this setting (depending on the hardness of the water), press the "Delay Timer" button repeatedly. Each time you press it, the setting changes.

Please refer to the table below.

- Reset the switch to the Programme or STOP position.

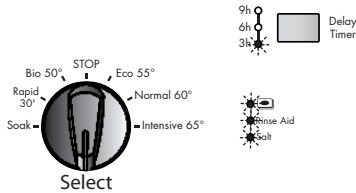

| | Test strip | □ □ □ □ □ □ | ■ □ □ □ □ □ | ■ ■ □ □ □ □ | ■ ■ ■ □ □ □ | ■ ■ ■ ■ □ □ | ■ ■ ■ ■ ■ □ |
|--------|---------------------|--|--|---|---|---|---|
| | | Hardness | 0-10°F | 10-25°F | 25-40°F | 40-55°F | 55-70°F |
| Adjust | Traditional product | 9h ○ 6h ○ 3h ○ ○ Rinse Aid ● Salt | 9h ○ 6h ○ 3h ○ ○ Rinse Aid ● Salt | 9h ○ 6h ○ 3h ○ ○ Rinse Aid ● Salt | 9h ○ 6h ○ 3h ● ○ Rinse Aid ● Salt | 9h ○ 6h ● 3h ● ○ Rinse Aid ● Salt | 9h ● 6h ● 3h ● ○ Rinse Aid ● Salt |
| | | ○ : indicator light off ● : indicator light on | ○ : indicator light off ● : indicator light on | | | | |



Important:

It is very important to set the water softener correctly.

- If the setting is too low, there is the risk of chalky marks appearing.
- If the setting is too high, there is the risk of causing clouding of glasses.

If you relocate, adjust the water softener setting as required.

• Traditional tablets

Non-multipurpose tablets should be placed in the external compartment (Fig 04) or, for optimum performance, pull out the dispenser drawer and lay the tablet inside (Fig 05).

• Powders or liquids (Fig 03)

Fill at least up to the minimum mark for slightly dirty crockery and to the maximum mark for dirty crockery. If the crockery is very dirty and for programmes with a pre-wash we recommend that you add 5g of detergent (a dessert spoonful) into your dishwasher's tub in accordance with the programmes table.



Important:

Keep these products out of children's reach and away from dampness.

Only use products specially designed for dishwashers.

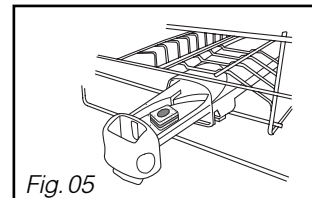
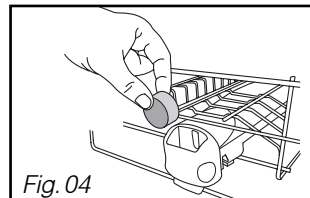
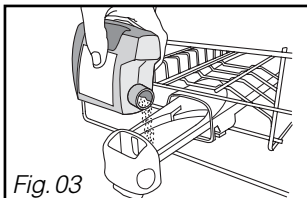

5/ DETERGENT PRODUCTS AND ADJUSTING THE WATER SOFTENER

• FOR MULTI-PURPOSE PRODUCTS : USING THE BUTTON

- Your machine can be specially adjusted to use multi-purpose products if the water hardness is less than 25°F.



Tip:

Your dishwasher's  button adjusts to the wide range of multipurpose products. It has two possible settings, which you access via the Select.

“Extra Dry” (the factory setting) improves the results after drying where the “2 in 1”, “3 in 1” or “4 in 1” multipurpose product offers a lower level of performance.

“Sparkling Clean” improves the shine of your crockery, whatever sort of multipurpose product you use.

• To adjust the water softener











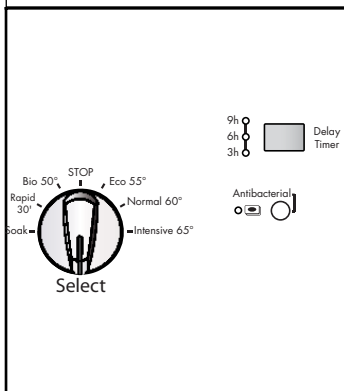



















- Turn the selector switch to “Select”. The six indicator lights come on, showing you that you are in adjustment mode.
- Press the “Delay Timer” button once; you can tell the setting from which indicator lights blink. Please refer to the table below.

– You must change this setting if you use multipurpose tablets.

To do so, press repeatedly on the “Delay Timer” button and select a water hardness of either 0-10 ° F or 10-25 ° F.

• To change the option (if necessary)

- Press the “4-in-1” button to select the setting “Sparkling Clean”.
- Press once more to go back to “Extra Dry” .
- The setting is saved automatically when you exit the Select.

|  | Testing strip |  |  |
|---|---|---|---|
| | Hardness | 0-10 ° F | 10-25 ° F |
| Multi-purpose | 9h  6h  3h     | 9h  6h  3h     | |
| “Extra Dry” (réglage d'origine) | Wash  Rinse  Dry  End  ○ — ○ — ● — ○ | Wash  Rinse  Dry  End  ○ — ● — ○ — ○ | |
| “Sparkling Clean” | Wash  Rinse  Dry  End  ○ — ● — ○ — ○ | Wash  Rinse  Dry  End  ○ — ● — ○ — ○ | |

○ : indicator light off ● : indicator light on

 : indicator flashing



Important:

The settings for multipurpose products disable the warning lights for rinse aid and salt only when the setting is 0-10°F.

• Loading the multi-purpose tablet dispenser

To assist in loading the detergent, the distributor is situated on the front of the upper basket. It is compatible with all the products recommended for dishwashers.

- Place the tablet in the external compartment (Fig 04 on previous page) or, for optimum results, pull out the distributor's drawer and lay the tablet inside (Fig 05 on previous page).

- Close the dispenser.

6/ FILLING WITH REGENERATING SALT

• Filling with regenerating salt (Fig 06)

Filling with salt is essential for providing a good wash without marks. It regenerates the resins that soften the water, by removing its lime content (unless the mains water supply is soft enough). Refer to "Setting the water softener".



Important :

Only use special dishwasher regenerating salt. Do not use table salt or any type of cooking salt, this could damage your appliance's water softener.

- A** Unscrew and remove the stopper on the salt tank.
- B** Fill the tank with regenerating salt specially designed for dishwashers.
- C** Use the funnel supplied with your dishwasher. The first time, top up with water up to the rim of the tank.

• **Regenerating salt indicator:**

This illuminates when salt must be added. After the tank has been filled with regenerating salt, the indicator light may remain lit until the salt has dissolved sufficiently, usually after one cycle (of if the tank has not been filled completely; for example, when first putting the machine into service using the sample).



Important

If the salt overflows when filling the tank, to avoid oxidization of the tub it is advisable to remove the salt crystals or to run a Prewash programme.

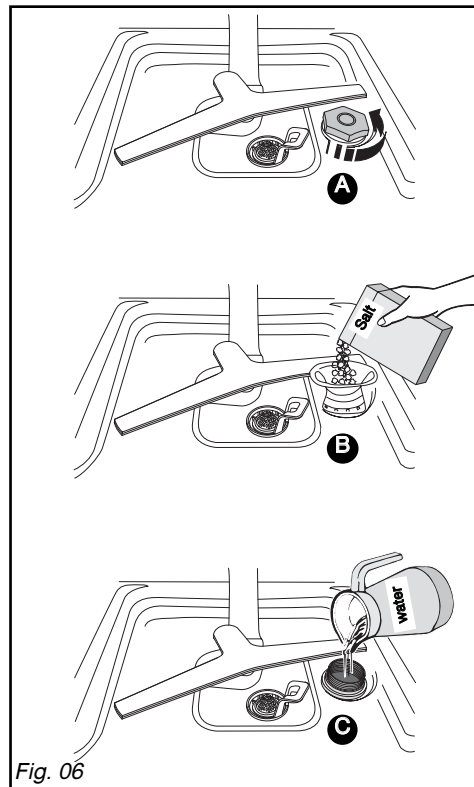

7/ FILLING WITH RINSE AID

• Filling with rinse aid (Fig. 07)

⚠ Important :
Only use a rinse aid designed for dish-washers. The rinse aid ensures your items shine and are well dried.

A B When first putting the machine into service, fill the tank until the level is flush with the top of the adjustment lever. Pour in at least all the rinsing product provided. The tank contains 120 ml (approximately one glass)

The original setting is in the centre (middle position: reference mark 2). If you encounter marks or poor drying after a few cycles, you can adjust the setting using the adjustment lever (fig 07 **C**; Reference mark 3 will increase the setting).

- Close the tank lightly

• **Rinse aid indicator light:** ✨

This illuminates when rinse aid is required.

⚠ Important :
If any of the product overflows during filling, sponge up the excess to avoid producing foam.

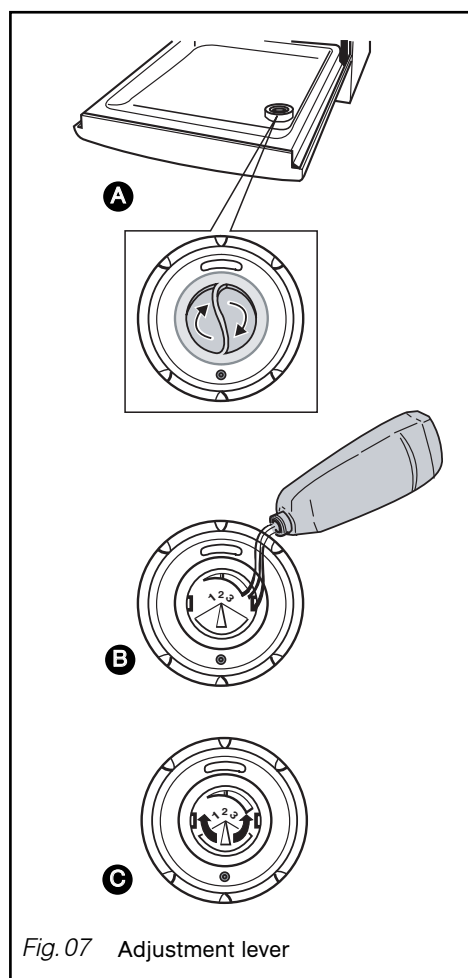

Fig. 07 Adjustment lever

8/ YOUR DISHWASHER'S EQUIPMENT



Very important

Items not suitable for washing in a dishwasher:

- **Wooden cutting boards**
 - **Stainless steel utensils or plastic utensils that are not heat-resistant**
 - **Copper or pewter items**
 - **Glued crockery and cutlery**
 - **Cutlery with wooden, horn or mother-of-pearl handles**
 - **Antique or hand-painted porcelain**
- When purchasing crockery, glasses or cutlery, ensure that it is dishwasher-safe**

• **THE LOWER BASKET**

Arrange your items so that the water can circulate freely and spray over all the utensils. Place large diameter dishes and pans at the sides.

Do not intersperse, jam together or superimpose flat plates and concave dishes (Fig. 08). The flexible racking spikes makes it easier to arrange your large dishes (Fig. 09).



Advice:

When you re-insert the lower basket, ensure that nothing catches on the oversize plate barrier to avoid blocking the rotating spray arm.

Unloading your items

Empty the lower basket first to avoid droplets of water falling from the upper basket onto dry items in the lower basket.

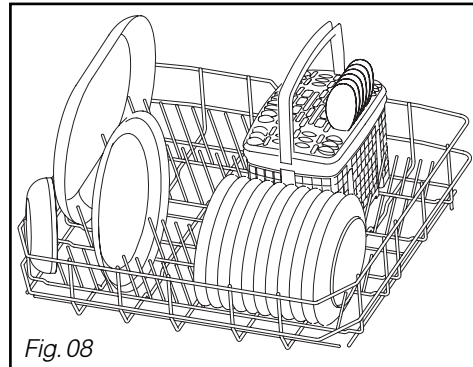

Fig. 08

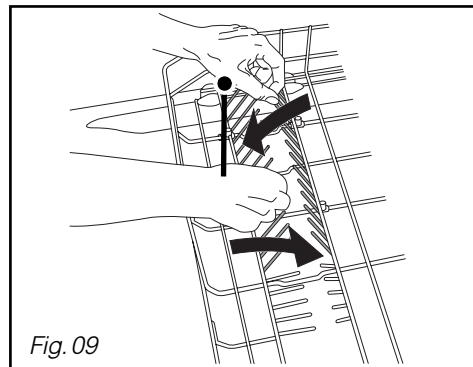

Fig. 09

8/ YOUR DISHWASHER'S EQUIPMENT

• **THE UPPER BASKET**

This basket is particularly designed to take glasses, cups, ramekins, small salad bowls, bowls and saucers.

Arrange your items methodically to save on space (arranging glasses, cups or bowls together).

You can also arrange cups, ladles, etc. on the folding cup racks (Fig. 10)



Advice:
Position the cavities of glasses, cups or bowls facing downwards.

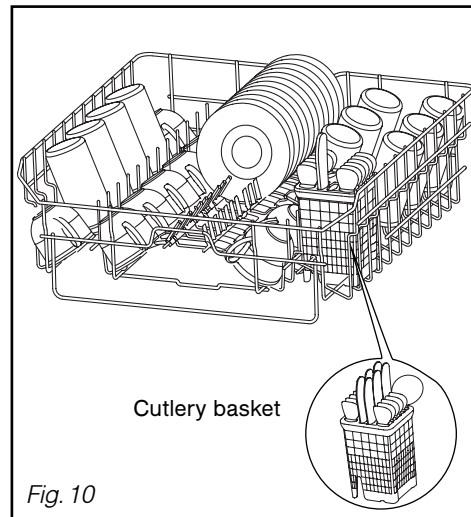

Fig. 10

8/ YOUR DISHWASHER'S EQUIPMENT

• THE CUTLERY BASKET

The cutlery basket slides to allow flexible loading.

It can be placed anywhere in the lower basket. You can therefore make a variety of loads depending on the items (Fig. 12).

If your cutlery items or your dishes are too large, alter the height setting for the upper basket.

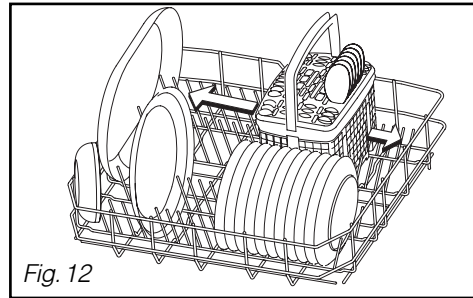

Fig. 12

Movable grills are available for if you wish to load your cutlery in an orderly manner (Fig. 13).

For optimum washing and drying, use these separation grills partially or totally.

Point the handles on the cutlery downwards.

Important :
For safety reasons, we recommend that you place knives with pointed ends with the point facing downwards in the cutlery basket (to avoid the risk of an accident).
Long-bladed knives and other sharp kitchen utensils must be placed flat in the upper basket.

Avoid washing cutlery with horn handles in your dishwasher.

Separate silverware from other metals using the separation grill.

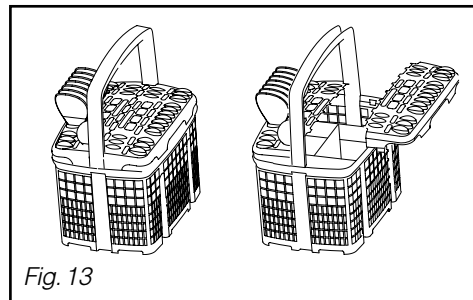

Fig. 13

9/ YOUR DISHWASHER'S SAFETY SYSTEMS

- **Locked programme access**

While the programme is running, the programme selection switch is automatically locked and cannot be changed. It will unlock automatically when the programme ends or is cancelled.

- **Anti-overflow system**

This system activates the drain pump automatically if the water in the tank reaches an abnormal level.

- **Anti-leak protection system**

This system cuts off the water supply if a leak is detected under the appliance.



Note:

To unlock, press the Start/Cancel button and hold it down for three seconds.



Important: -> Error in programme or malfunction:

Refer to Section 13 / If the machine does not operate normally.

The indicator lights flash to denote errors as follows:

Wash Rinse Dry End
● ○ ○ ○ Check that the tap is open. (d01)

Wash Rinse Dry End
○ ● ○ ○ The dishwasher is not emptying. Several possible reasons: refer to Section 9, paragraph headed "Programming, display". (d02)

Wash Rinse Dry End
● ● ● ○ The dishwasher's anti-leak system is active: call a technician. (d07)

Wash Rinse Dry End
○ ○ ● ● Several possible causes: refer to Section 9, paragraph "Malfunction". (d12)

10/ WASHING PROGRAMMES

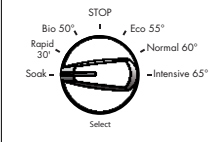
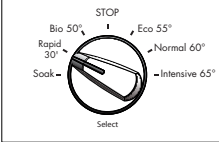
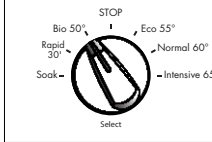
| | | | |
|--|--|--|--|
| ITEM TYPE (porcelain, pans, cutlery, glasses) FOOD RESIDUE: Quantity, type and amount | Mixed | Mixed | Mixed |
| | Very short cycle (with no detergent) for rinsing and re-dampening the items while waiting for a wash expected in the following two days. | Very short 30-minute wash specially designed for a small amount of daily items with a limited amount of non-greasy residue, not dried on. | Normally dirty wash Washing at low temperature, economical and particularly suitable for compact – enzymatic detergents |
| |  |  |  |
| PROGRAMMES | Soak | Rapid 30' | Bio 50° |
| PROGRAMME SEQUENCE | Cold pre-wash | Washing at 45°C Rinse Hot rinse at 60°C Natural drying | Washing at 50°C Rinse Hot rinse Drying by condenser |
| As an indication only: | | | |
| Duration in min | 15' | 30' | 160' |
| Water (L) | 4,5 | 12 | 16 |
| Energy (Kwh) | 0,02 | 0,8 | 1,05 |

These values refer to normal conditions of use with separate products (detergent, salt, rinsing product). They may vary according to the load, the temperature, if you use combined washing products, the water hardness and the supply voltage.

10/ WASHING PROGRAMMES

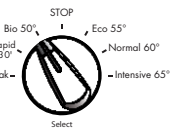

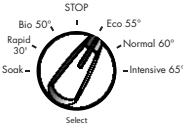
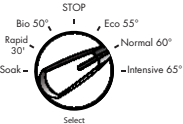
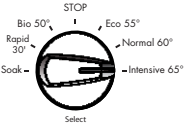
| Mixed | Mixed | Resistant |
|---|--|---|
| <p>Normally dirty A normal amount of dried-on and greasy residue on everyday items. Faster, but consumes more energy.</p>  | <p>Normally dirty A normal amount of dried-on, adhering residue on everyday items.</p>  | <p>Very dirty A large amount of dried-on residue, baked-on stains, grease, residue from frying, cooked cheese, sauce, etc.</p>  |
| Eco 55° | Normal 60° | Intensive |
| Hot Pre-wash | | Hot Pre-wash |
| Washing at 55°C | Washing at 60°C | Washing at 65°C |
| Rinse | Rinse | Rinse |
| Hot rinse | Hot rinse | Hot rinse |
| Drying by condenser | Drying by condenser | Drying by condenser |
| 130' 17 1,3 | 90' 17 1,5 | 115' 17 1,7 |

11/ PROGRAMMING

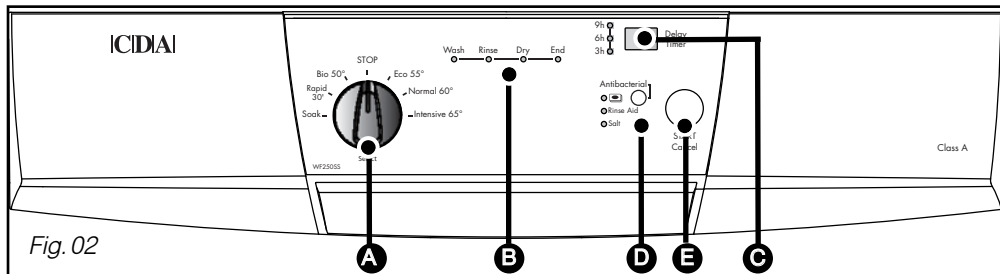

Advice: Consult the Programmes table on the preceding pages to determine the programme you need for the type of items, the quantity and the amount of food residue.

• **Running the programme immediately**
Select your programme by turning the selector switch **A**.

Press “Start” **E**: the programme begins.
The indicators light up as the programme progresses.

Note:
The electrical safety devices on the door may cause the indicators to light briefly when it is opened or closed, even if the selector switch is set to “STOP”.
This does not affect the operation of your appliance.
As required, and in particular after adjusting the water softener, the resins may be regenerated during the first three minutes of the programme.
There is no noise during this process.

• **Delaying a wash programme**
You can program a delayed start by pressing the “Delay Timer” **C** button.

Confirm by pressing “Start” **E**.

• **Switching the appliance off**
When the programme has finished, turn the selector switch to “STOP” **A**.

• **Cancelling a programme**
Press the “Start Cancel” button **E** and hold down for several seconds.

• **Antibacterial “4-in-1”:**
Use this button to optimize the dishwasher’s washing cycle depending on the type of multi-purpose tablet, and to ensure your dishwasher is treated for bacteria.



12/ CLEANING YOUR APPLIANCE

• CLEANING THE WASTE FILTERS

The filtration system consists of several elements:

- A** - The waste filter
- B** - The large main filter
- C** - The micro filter

The filters are located in the centre of the tub and must be washed regularly to obtain optimum washing results.

Actions :

- ① Before removing the filters, remove any waste on the large main filter **B** with a sponge so that the waste does not block the sprinkler arms. Rotate the spray arm as shown in the drawing. (Fig. 14)
- ② Loosen the waste filter a quarter of a turn and then remove it **A**
- ③ Remove the main filter **B**
- ④ Remove the micro filter **C**

- ⑤ Carefully clean filters **A**, **B** and **C** under running water (Fig. 15)

Re-installation:

Proceed in reverse order, inserting filters **C** and **B** and then **A**

! Important :

Remember to lock the waste filter **A in place by pushing it in fully and turning it a quarter turn.**

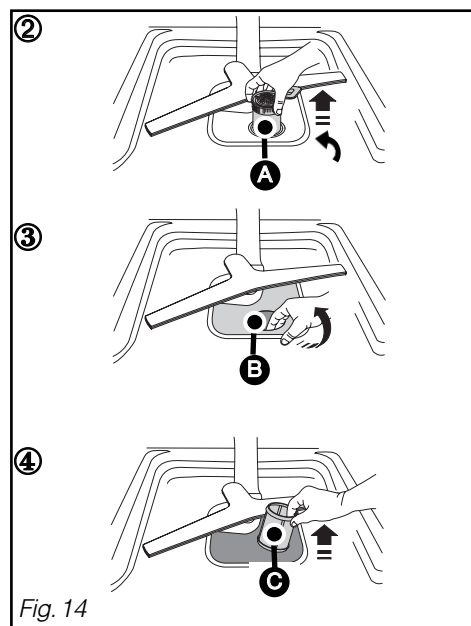
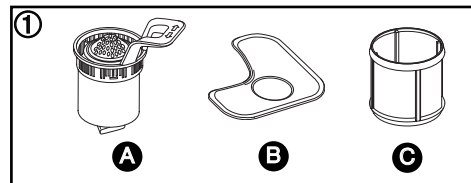

Fig. 14

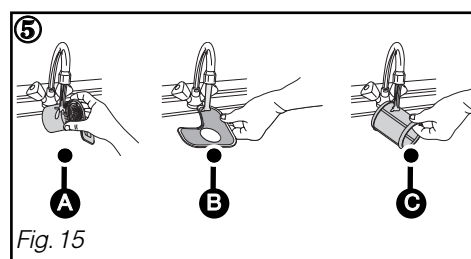

Fig. 15

12/ CLEANING YOUR APPLIANCE

- **Periodically**

Every 3 or 4 months, in order to remove any deposits, run a special maintenance programme, without any items in the machine, using a special dishwasher cleaning product.



Important :

Keep this product out of children's reach.

- **If not using your dishwasher for a prolonged period:**

Clean your dishwasher completely and then unplug it from the electricity supply and close the water tap. Protect your machine from potential frost.



Advice :

Do not use abrasive powders, metal sponges and alcohol-based or thinner-based products. Use a cloth or a sponge.

If you are moving house, run a soaking programme first of all, in order to avoid any water escaping.

13/ IF OPERATING ABNORMALITIES OCCUR

• SUMMARY OF THE FAULTS

| | |
|--------------------------------------|---|
| d01: water supply fault (tap) | d07: overflow / anti-leak fault |
| d02: draining fault | d08: sprinkling distribution fault |
| d03: heating fault | d11: pressure sensor fault |
| d04: temperature fault | d12: filling fault (water inlet detection system) |
| d05: fault – motor under load | d13: overheating fault |
| d06: fault - motor overload | d14: installation fault : (incorrect drainage connection or inadequate flow rate and tap). |

• BEFORE CALLING FOR SERVICE

| Problem | Possible causes | What to do? |
|--|---|--|
| The door catches when closing | - Appliance not stable - Door not centred on the tub | - Adjust the feet. - Re-centre by adjusting the rear feet. |
| The upper basket does not stay in the high position | - Poor manipulation (the basket is being pulled upwards too quickly) | - Act more progressively (see instructions), one side and then the other. |
| Small leak around or under the appliance (move the appliance to locate the leak) | - Leak from the tap. - Leak from the appliance. (Cf. table fault d07). | - Check that a seal is fitted and retighten the nut. - Close the water tap and call a technician. |
| Small leak at the door | - Appliance not stable or not level - Door not centred on the tub. | - Adjust the feet. - Re-centre by adjusting the rear feet. |

13/ IF OPERATING ABNORMALITIES OCCUR

• THE INDICATOR LIGHTS

| Problem | Possible causes | What to do? |
|--|---|---|
| The salt light does not go out | - No salt or an insufficient quantity of salt in the tank to trigger the float. | - Refill the tank and wait for the cycle to end. If you have soft water that requires no salt, the light is constantly lit. |
| The lights all light up one after the other | - Wrong programme. | - Cancel the current programming by holding down the Start button for 3 seconds and then re-programme. |
| A light flashes and the programme does not start | - Programme selector wrongly positioned (between two notches) | - Reposition the selector on a programme. |

• RELATING TO PROGRAMMING, DISPLAY

| Problem | Possible causes | What to do? |
|---|---|--|
| The cycle lasts too long | - The energy-saving programmes last longer because the agitation and drying times are longer to compensate for the lower washing and drying temperatures | - Use these programmes preferably at night when it is not so important how long the programme lasts or when it ends. |
| The appliance trips the circuit breaker | - Insufficient amperage to supply all the appliances being operated simultaneously. - Internal fault in the appliance. | - Check the socket's amperage (10A minimum) and the meter's capacity. - Call a technician. |
| The appliance does not start | - No mains power to the socket. - Tap closed (Cf. table fault d01). - Water supply hose kinked. - Selection error or programme blocked. - Start button pressed too long (greater than 2 secs). - Appliance in Safety mode (anti-leak) (Cf. table fault d07). | - Check the socket and the fuse - Check the tap is open. - Check the hose line is OK. - Cancel by holding down Start for 3 secs and re-programme. - Just press Start briefly to start the programme. - Call a technician. |

13/ IF OPERATING ABNORMALITIES OCCUR

| Problem | Possible causes | What to do? |
|--|---|--|
| The appliance will not restart | - Door opened during a washing cycle. | - Wait for the time delay to end (controlled internally by the appliance). |
| The appliance does not drain (Cf. table fault d02). | - The cover has not been removed from the sink's U-bend. - Drain hose kinked. - Filters totally blocked. - Pump blocked. | - Remove the cover. - Check the drain hose line behind the machine is OK. - Remove and clean the filters and the drain. - Initiate a Soaking programme If the fault persists, call a technician. |
| The appliance will no longer function (see table, fault 14). | - installation of non-compliant drainage system: drainage too low down or pipe pushed too far in. - siphoning: the appliance is emptying as the same time as it is filling up. | - adhere to the drainage tube installation dimensions. |

• POOR WASHING RESULTS

| Problem | Possible causes | What to do? |
|---|---|--|
| Food traces and deposits in the glasses | - Items poorly arranged (masked by another larger item or situated underneath it, items nested or jammed together). - Upper spray arm blocked by cutlery or a dish etc. - Filter poorly locked and lifting during washing. - Micro filter screen clogged. - One or more holes in the spray arm blocked. | - Arrange the items properly. Use the most appropriate areas and accessories for each type of item (see instructions). - Check that the spray arm rotates freely. Set the basket in the high position if necessary. - Check the filter's facing and that the filter is locked in place (push it in fully, turning it to the right). - Remove all the filters and clean them (in warm water), including the micro filter's screen (once a month). - Remove the spray arm by turning the lever a quarter of a turn and clean it under the tap (do not use any tool that could damage the holes). Re-install the spray arm. |
| Traces of grease | - Detergent dose too low; inefficient detergent; stale product. - Inappropriate programme (temperature too low; duration too short). | - Increase the dose; try another detergent. - Select a programme with a higher temperature. |

13/ IF OPERATING ABNORMALITIES OCCUR

• POOR WASHING RESULTS..

| Problem | Possible causes | What to do? |
|--------------------------------------|---|---|
| White marks (identify what type) | <ul style="list-style-type: none"> - Chalky film (removable with vinegar). - Traces of salt (items have a salty taste). | <ul style="list-style-type: none"> - Check that there is salt in the tank (light unlit = OK). - Check the water hardness at the tap and that the water softener is set correctly. Adjust it to a higher level if necessary. - Water too hard for using a "4-in-1" detergent without the addition of salt. - Check that the stopper on the salt container is closed correctly. |
| White marks (identify what type) | <ul style="list-style-type: none"> - Glass cloudy because water too soft (cannot be removed). | <ul style="list-style-type: none"> - Check the water hardness at the tap and that the water softener is set correctly. Some detergents in pellet form are more aggressive to glasses and decorations (change the product and use a protective product if necessary). |
| Coloured marks (tea, wine, coffee) | <ul style="list-style-type: none"> - Items poorly arranged - Detergent dose too low; inefficient detergent - Programme temperature too low. - If you use a multifunction product. | <ul style="list-style-type: none"> - Turn the cavities in the items towards the jets. - Increase the dose; try another detergent. - Select a more suitable programme with a higher temperature. - Use the "4-in-1" option (depending on the model). |
| Streaks or dried droplets on glasses | <ul style="list-style-type: none"> - Lack or insufficient amount of rinsing product. - Rinsing product out-of-date or inefficient. - If you use a multifunction product. | <ul style="list-style-type: none"> - Check the indicator light and fill the tank completely. Adjust the dispensing unit to a higher position if necessary. - Use a recent product (a good product dilutes easily and foams in cold water). - Use the "4-in-1" option with a setting prioritizing drying (parametering from the menu – depending on the model). |
| Dried-on marks on glasses, dullness. | <ul style="list-style-type: none"> - If you use a multifunction product. | <ul style="list-style-type: none"> - Use the "4-in-1" option with a setting prioritizing brilliance (parametering from the menu – depending on the model). |

13/ IF OPERATING ABNORMALITIES OCCUR

• POOR OPERATION

| <i>Problem</i> | <i>Possible causes</i> | <i>What to do?</i> |
|---|---|---|
| Constant filling A lot of waste on the large filter at the end of the cycle. | - Drain hole situated too low for the appliance (Cf. table fault d012). - The filters and drain outlets are blocked with too much residue. | - Drain wand has fallen on the floor. - Remove and clean the filters and the bottom of the drain outlets. Remove large residue from the plates before putting them in the machine. |
| Traces of rust on stainless steel | - Quality of the stainless steel ; not dishwasher-safe (knives in particular) | - Use "special dishwasher-safe" cutlery. - Check that the lid on the salt container is closed correctly. |

• POOR DRYING RESULTS

| <i>Problem</i> | <i>Possible causes</i> | <i>What to do?</i> |
|---|--|--|
| A lot of droplets on the glasses | - Lack or insufficient amount of rinsing product. - The dose has not been distributed. - Positioning of the items. | - Check the indicator light and fill the tank completely. - If the tank is not empty after approximately 60 washings, call a technician. - Arrange the items to restrict water retention as much as possible. Leave the door ajar for a few minutes, if possible |
| Droplets on plastic items, Tefal coatings, etc. | - These items have a low caloric mass. | - Arrange the items in the upper basket. |
| Poorer drying on rapid programmes | - On rapid programmes, the drying temperature and drying period are reduced to cut down the duration of the cycle as much as possible. | - Leave the door ajar for a few minutes. |
| Condensation on the wall of the inside door or the tub. | - Condensation may form on the walls, particularly after the appliance has cooled down (sound insulation increases this occurrence) | |

• **INTERVENTION WORK**

Any intervention work on your appliance must be performed by a qualified professional approved by the manufacturer. When you call, please mention the full reference for your appliance (model, type and serial number). This information is shown on the description plate (see Fig. 16)

ORIGINAL PARTS

When maintenance is being carried out, ask for only certified original spare parts to be used.

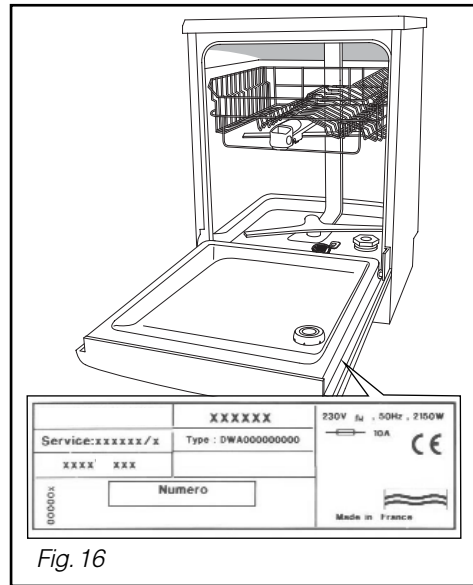

Fig. 16

14/ INDICATIONS FOR THE TESTING LABORATORIES

• **Details common to all models**

- Washing capacity ----- 12 standard place settings
- Arrangement of the items ----- Figs. A-B-C; see next page
- Loading as per the indications on next page, without side shelves
or stemmed glass support, and 5 cup/saucer supports
(4 for 12 saucers & 1 for 2 cups)
- Setting for upper basket ----- Low position
- Setting for rinsing product distributor ----- 3
- Adjusting the water softener ----- 0-10°F

For detailed information on the comparison tests regarding the level of soiling, the types of crockery and cutlery, etc., contact the equipment manufacturer before commencing the tests.

• **Tests to Standard EN 50242:**

- Recommended programme ----- "Bio"
- Dosage of detergent ----- 30 g of detergent B

• **Tests according to the mixed IEC 436/DIN 44990 method**

- Recommended programme ----- "Eco"
- Dosage of detergent ----- 5 + 25 g of detergent B

NB: When conducting tests using a multi-function tablet:

- Check that the water softener is correctly set for the water hardness (Cf.: Chapter 5 / DETERGENT PRODUCTS AND ADJUSTING THE WATER SOFTENER ? • FOR MULTI-FUNCTION PRODUCTS)
- Pull out the detergent distribution drawer and place the tablet in the interior compartment.

14/ INDICATIONS FOR THE TESTING LABORATORIES

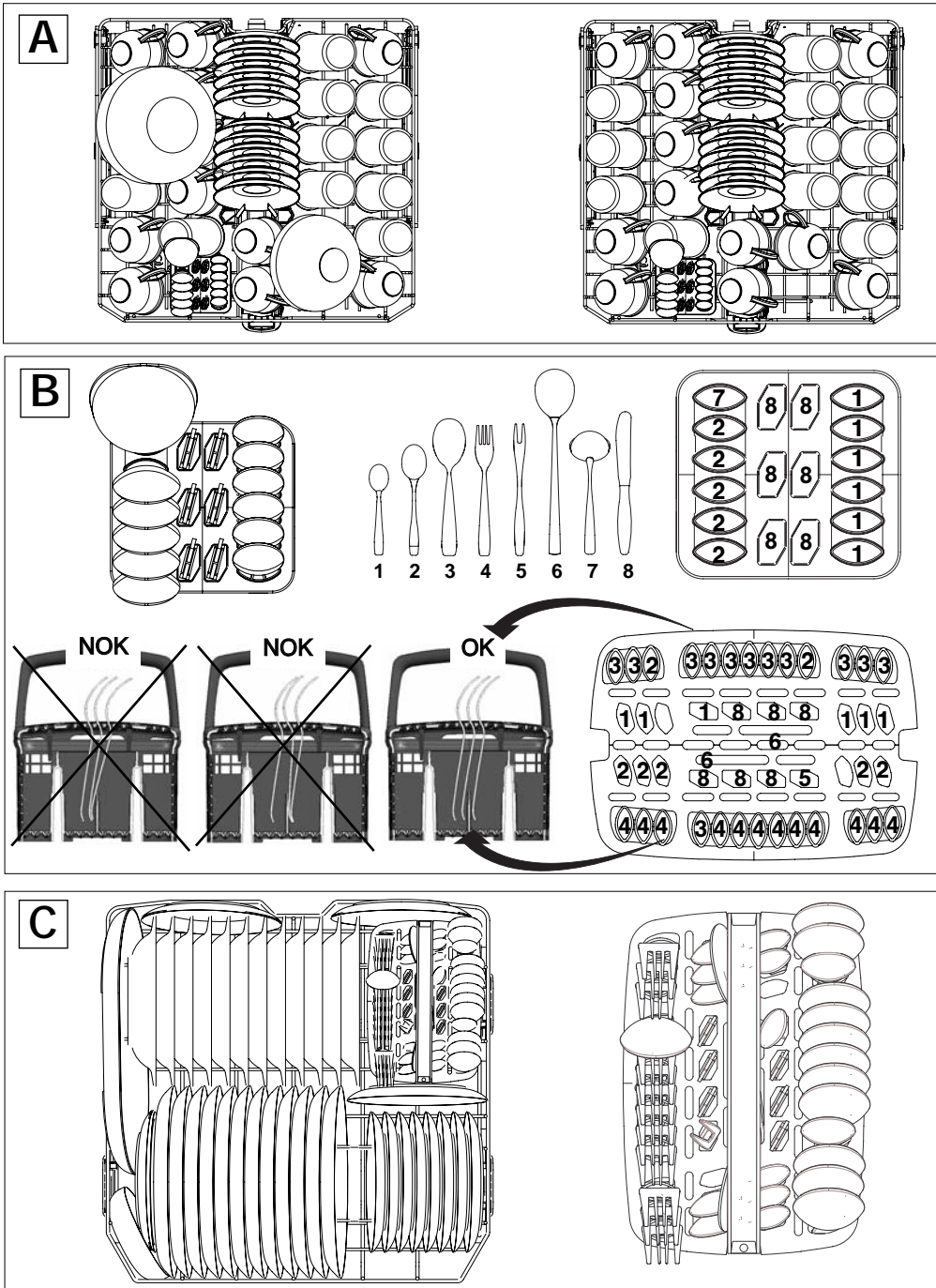

Free Manuals Download Website

<http://myh66.com>

<http://usermanuals.us>

<http://www.somanuals.com>

<http://www.4manuals.cc>

<http://www.manual-lib.com>

<http://www.404manual.com>

<http://www.luxmanual.com>

<http://aubethermostatmanual.com>

Golf course search by state

<http://golfingnear.com>

Email search by domain

<http://emailbydomain.com>

Auto manuals search

<http://auto.somanuals.com>

TV manuals search

<http://tv.somanuals.com>