

DC730.. - Built Under Double Ovens
Manual for Installation, Use and Maintenance

CDA

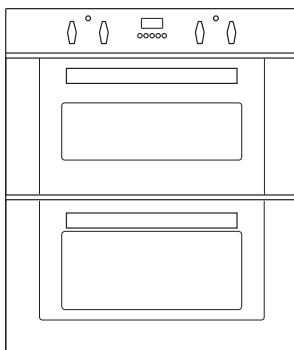

CE

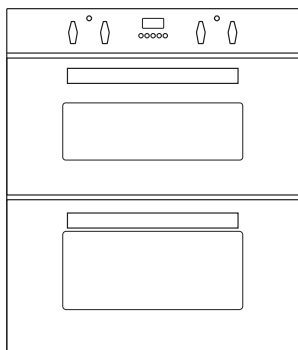

Important

This appliance is designed and manufactured solely for the cooking of domestic (household) food and is not suitable for any non domestic application and therefore should not be used in a commercial environment.

The appliance guarantee will be void if the appliance is used within a non domestic environment i.e. a semi commercial, commercial or communal environment.

The CDA Group Ltd cannot be held responsible for injuries or losses caused by incorrect use or installation of this product. Please note that CDA reserve the right to invalidate the guarantee supplied with this product following incorrect installation or misuse of the appliance.

Appliance Information:

Please enter the details on the appliance rating plate below for reference, to assist CDA Customer Care in the event of a fault with your appliance and to register your appliance for guarantee purposes.

Appliance Model	<input type="text"/>
-----------------	----------------------

Serial Number	<input type="text"/>
---------------	----------------------

Declaration of CE Conformity

This double oven has been designed, constructed and marketed in compliance with:

- Safety requirements of EU Directive "Low Voltage" 2006/95/EC;
- Protection requirements of EU Directive "EMC" 2004/108/EC;
- Requirements of EU Directive 93/68/EEC.

Important Information for Correct Disposal of the Product in Accordance with EC Directive 2002/96/EC.

At the end of its working life, the product must not be disposed of as urban waste. It must be taken to a special local authority differentiated waste collection centre or to a dealer providing this service.

Disposing of a household appliance separately avoids possible negative consequences for the environment and health deriving from inappropriate disposal and enables the constituent materials to be recovered to obtain significant savings in energy and resources. As a reminder of the need to dispose of household appliances separately, the product is marked with a crossed-out wheeled dustbin.



Before Using for the First Time

- Read the instructions carefully before installing and using the appliance.
- After unpacking the appliance, check that it is not damaged. In case of doubt, do not use the appliance and contact your supplier or a qualified engineer.
- Remove all the packing materials (i.e. plastic bags, polystyrene foam, etc.) and do not leave it around within easy reach of children, as these may cause serious injuries. The packaging materials are recyclable.
- Do not attempt to modify the technical characteristics of the appliance, as it may become dangerous to use.
- The appliance should be installed and all the electrical connections made by a qualified engineer in compliance with local regulations in force and following the manufacturer's instructions.

Important Precautions and Recommendations for Use of Electrical Appliances

Use of any electrical appliance implies the necessity to follow a series of fundamental rules. In particular:

- never touch the appliance with wet hands or feet;
- do not operate the appliance barefooted;
- do not allow children or disabled people to use the appliance without your supervision.

The manufacturer cannot be held responsible for any damages caused by improper, incorrect or unreasonable use of the appliance.

Using the Double Oven for the First Time

You are advised to carry out the following operations:

- Assemble the interior of the top and the lower ovens as described under the heading "Cleaning and maintenance"
- Switch the empty ovens ON at maximum temperature for about two hours to eliminate traces of grease and smell from the components.
- Let the ovens cool down, switch off the electrical supply, then clean the inside of the ovens with a cloth soaked in water and neutral detergent and dry thoroughly.

Important Safeguards and Recommendations

- Do not carry out any cleaning or maintenance without first disconnecting the appliance from the electrical supply.
- During and after use of the double oven, certain parts will become very hot. Do not touch hot parts.
- After use always ensure that the control knobs are in the **OFF** position (■ - □).
- Household appliances are not intended to be played with by children.
- Keep children away from the oven during use.
- Children, or persons with a disability which limits their ability to use the appliance, should have a responsible person to instruct them in its use. The instructor should be satisfied that they can use the appliance without danger to themselves or their surroundings.
- **WARNING**
When correctly installed, your product meets all safety requirements laid down for this type of product category. However special care should be taken around the rear or the underneath of the appliance as these areas are not designed or intended to be touched and may contain sharp or rough edges, that may cause injury.
- **Fire Risk!** Do not store inflammable materials inside the ovens.
- Always use oven gloves when removing the shelves and food trays from the oven whilst hot.
- Clean the ovens regularly and do not allow fat or oils to build up in the oven base or trays. Remove spillages as soon as they occur.
- Do not line the oven walls with aluminium foil. Do not place baking trays or the drip tray on the base of the oven chambers.
- Always stand back from the double oven when opening the oven doors to allow steam and hot air to escape before removing the food.
- Do not hang towels, dishcloths or other items on the double oven or its handles – as this could be a fire hazard.
- Make sure that electrical cords connecting other appliances in the proximity cannot become entrapped in the oven doors.
- Before disposing of an unwanted appliance, it is recommended that it is made inoperative and that all potentially hazardous parts are made harmless.
- **Important:** This appliance has been designed for domestic use only. The appliance is **NOT** suitable for use within a semi-commercial, commercial or communal environment.
- **Safe food handling:** leave food in the oven for as short a time as possible before and after cooking. This is to avoid contamination by organisms which may cause food poisoning. Take particular care during warmer weather.
- Do not operate your appliance by means of an external timer or separate remote-control system.

Control Panel

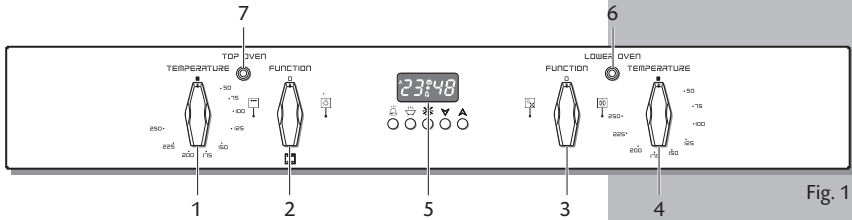

Fig. 1

Controls Description

1. Oven temperature knob (Top oven)
2. Function selector knob (Top oven)
3. Function selector knob (Lower main oven)
4. Oven temperature knob (Lower main oven)
5. Digital electronic programmer (Lower main oven only)

Warning Lights:

6. Main oven temperature indicator light
7. Top oven temperature indicator light

Please Note: Your appliance has been fitted with a cooling fan to achieve optimum efficiency of the controls and to ensure lower surface temperatures are maintained.

When the top oven is operating the cooling fan motor is always ON.

When only the bottom main oven is operating the cooling fan motor switches ON/OFF depending on temperature.

Depending on cooking temperatures and times, the cooling fan may run on even after appliance oven has been switched off. The duration of this time is dependent on previous cooking temperature and duration.



Top Natural Convection Oven

General Features

This oven features 2 different thermostatic control functions to satisfy all cooking requirements, provided by 3 heating elements:

- Upper element, 700 W
- Lower element, 1000 W
- Grill element, 2000 W

Note:

When using for the first time, you are advised to operate the oven at maximum temperature (thermostat knob on the maximum position) for approximately one hour in the  mode and for another 15 minutes in the  mode in order to eliminate any traces of grease from the electrical elements.

Operating Principles

Heating and cooking in the natural convection oven are obtained:

a. by Normal Convection

The heat is produced by the upper and lower heating elements.

b. by Radiation

The heat is radiated by the infra red grill element.

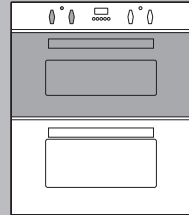

How to Use the Top Oven

WARNING:

The door is hot, use the handle.

ATTENTION - MOST IMPORTANT

Pay special attention not to touch the hot heating element inside the oven cavity.

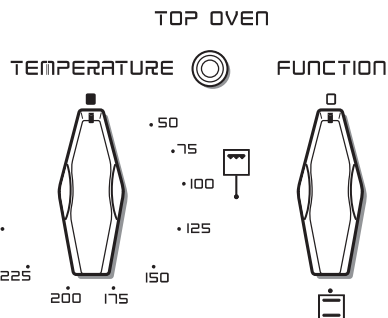

Fig. 2

Fig. 3

Thermostat Knob (Fig. 2)

This only sets the cooking temperature and does not switch the oven on.

Rotate clockwise until the required temperature is reached (from 50 °C to 250 °C).

The thermostat indicator light will illuminate when the oven is switched on and turns off when the oven reaches the correct temperature.

The light will cycle on and off during cooking in line with the oven temperature.

Function Selector Knob (Fig. 3)

Rotate the knob clockwise to set the oven for one of the following functions:



Oven Light

By turning the function selector knob to this setting, the oven light will illuminate in the oven cavity. The oven light will operate on all selected functions.



Traditional Convection Cooking

The upper and lower heating elements come on. The heat is dispersed by natural convection and the temperature must be set to between 50 °C and 250 °C with the thermostat knob.

The oven must be preheated before cooking.

Recommended for:

Food that requires the same degree of cooking both inside and out, for example roasts, spare pork ribs, meringues etc.



Traditional Grilling

The infrared grill element comes on. The heat is dispersed by radiation.

Use with the oven door closed and the thermostat knob to position **225 °C** for max 15 minutes, then to position **175 °C**.

For cooking hints, see the chapter "USE OF THE GRILL".

Recommended for:

Intense grilling, browning, cooking au gratin and toasting etc.

It is recommended that you do not grill for longer than 30 minutes at any one time.

Caution: the oven door becomes very hot during operation. Keep children well out of reach.

Oven Cooking

Before introducing the food, preheat the oven to the desired temperature.

For a correct preheating operation, it is advisable to remove the tray from the oven and introduce it together with the food, when the oven has reached the desired temperature.

Check the cooking time and turn off the oven 5 minutes before the theoretical time to recuperate the stored heat.

Use of the Grill

- Preheat the oven for about 5 minutes with the door **closed**.
- Introduce the food to be cooked, positioning the rack as close to the grill as possible.
- The dripping pan should be placed under the rack to catch the cooking juices and fats.

Grilling with the oven door closed.

It is recommended that you do not grill for longer than 30 minutes at anyone time.

Attention: the oven door becomes very hot during operation.

Keep children away.

The external parts of the oven become hot during operation.

Keep children well out of reach.

Lower Main Fan Oven

General Features

The heating and cooking in electrical hot air ovens take place by forced convection.

The element which make this process take place is:

- Circular element 1900 W

Note:

Upon first use, it is advisable to operate the oven at the maximum temperature (thermostat knob on the maximum position) for 60 minutes in the position  to eliminate possible traces of grease on the heating element.

Operating Principles

Heating and cooking in the fan oven are obtained in the following ways:

a. by Ventilation

The food is defrosted by using the fan only function without heat.

b. by Forced Convection

A fan sucks in the air contained in the oven, which circulates it through the circular heating element and then forced back into the oven by the fan. Before the hot air is sucked back again by the fan to repeat the described cycle, it envelops the food in the oven, provoking a complete and rapid cooking. It is possible to cook several dishes simultaneously.

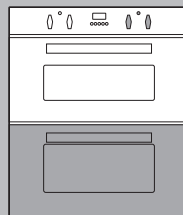

How to Use the Lower Oven

WARNING:

The door is hot, use the handle.

ATTENTION - MOST IMPORTANT

Pay special attention not to touch the hot heating element inside the oven cavity.

Thermostat Knob (Fig. 5)

This only sets the cooking temperature and does not switch the oven on.

Rotate clockwise until the required temperature is reached (from 50 °C to 250 °C).

The thermostat indicator light will illuminate when the oven is switched on and turns off when the oven reaches the correct temperature.

The light will cycle on and off during cooking in line with the oven temperature.

Function Selector Knob (Fig. 4)

Rotate the knob clockwise to set the oven for one of the following functions:



Oven Light and Defrost

By turning the function selector knob to this setting, the oven light and the oven fan come on. The oven light will operate on all selected functions.

Defrost: To be used with the thermostat knob in the "■" OFF position because the other positions have no effect. The defrosting is done by simple ventilation without heat.

Recommended for:

To rapidly defrost frozen foods; 1 kilogram requires about one hour.

The defrosting times vary according to the quantity and type of foods to be defrosted.



Hot Air Cooking

The circular element and fan come on. The heat is dispersed by forced convection and the temperature can be regulated to between 50 °C and 250 °C via the thermostat knob. The oven does not require preheating.

Recommended for:

Food which has to be well-cooked outside and soft or rosy inside, for example lasagne, lamb, roast beef, whole fish etc.

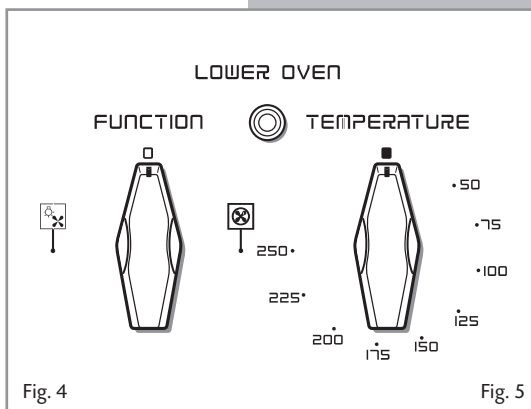

Lower Oven Cooking Advice

Cooking with Forced Air

Fan cooking is more economical and quicker than cooking in a conventional oven. The moving hot air surrounds the food and penetrates it more quickly than in a conventional oven.

The oven can be filled with different dishes all requiring the same cooking temperature. Subtract 10 minutes per hour for every dish requiring a cooking time of more than 1 hour and reduce the heat by 10-20°C; the hotter the oven, the more the temperature can be reduced.

Generally, there is no need to pre-heat the oven, but it is advisable to pre-heat for about 5 minutes to ensure the best results; use the indicator light as a guide, it goes out when the set temperature is reached.

Fan cooking is ideal for gelatine based dishes and softening ice cream - a microwave oven is much too strong for these dishes. Cooking yeast based dishes is also speeded up this way. If the oven door has been opened, the oven quickly regains its temperature once the door is closed.

Sterilization

Sterilization of foods to be conserved, in full and hermetically sealed jars, is done in the following way:

- Set the switch to position .
- Set the thermostat knob to position 175 °C and preheat the oven.
- Fill the dripping pan with hot water.
- Set the jars onto the dripping pan making sure they do not touch each other and the door and set the thermostat knob to position 125 °C.

When sterilization has begun, that is, when the contents of the jars start to bubble, turn off the oven and let cool.

Regeneration

Set the switch to position  and the thermostat knob to position 150 °C.

Bread becomes fragrant again if wet with a few drops of water and put into the oven for about 10 minutes at the highest temperature.

Roasting

To obtain classical roasting, it is necessary to remember:

- That it is advisable to maintain a temperature between 180 °C and 200 °C.
- That the cooking time depends on the quantity and the type of foods.

Simultaneous Cooking of Different Foods

With the function selector in position  the ventilated oven allows you to cook different types of food at the same time.

Fish, cakes and meat can be cooked together without the smells and flavours mixing.

The only precautions required are the following:







- The cooking temperatures must be as close as possible with a maximum difference of 20 - 25 °C between the different foods.
- Different dishes must be placed in the oven at different times according to the cooking time required for each one. This type of cooking obviously provides a considerable saving on time and energy.

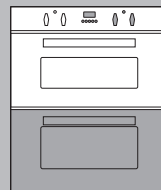

Electronic Programmer (Lower Main Oven only)

The electronic programmer is a device that groups together the following functions:



- 24 hour clock with illuminated display
- Timer (up to 23 hours and 59 minutes)
- Programme for automatic oven cooking
- Programme for semi-automatic oven cooking.



Description of the Buttons:	
Symbols	Description
	Timer
	Cooking time
	End of cooking time
	simultaneously: Switching to manual and program reset.
	To increase the numbers on the digital display
	To decrease the numbers on the digital display.

Description of the Illuminated Symbols:	
Symbols	Description
A flashing	Programmer in automatic position but not programmed.
A always lit	Programmer in automatic position with program set.
	Automatic cooking taking place.
	Timer in operation
 and A flashing	Program error. (The time of day lies between the calculated cooking start and end time).

Note:

Select a function by the respective button and, in 5 seconds, set the required time with the / buttons ("one-hand" operation).

After a power cut the display resets to zero and cancels the set programs.

Caution: If the electricity supply is cut off (the display numbers will flash), the clock will reset and all the programs entered will be cancelled.







Fig. 6

Setting Time of Day (fig. 7)



The programmer is provided with an electronic clock with luminous figures showing the hour and minutes.

The first time the oven is connected up to the electricity supply and after a power cut, three zeroes will flash on the programmer display.



To adjust the time, the two buttons   must be pressed simultaneously and then the button  or  until the correct time is set.

Setting speed automatically increases if you keep the setting buttons pressed.

Manual Operation

To use the oven manually, i.e. without the programmer, you must cancel the flashing **A** by pressing the two buttons   simultaneously (the letter **A** will go out and the symbol  will come on).

Cancelling a Programme

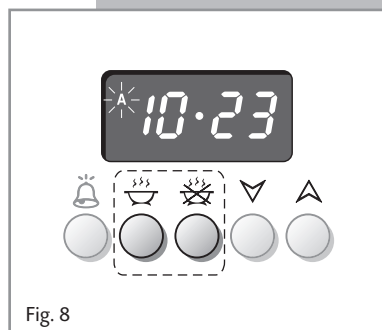
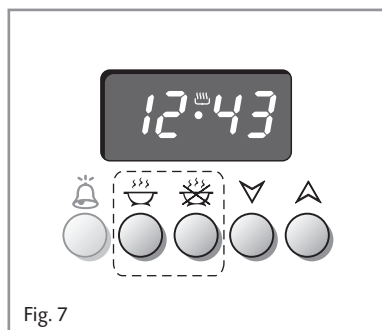

If the letter **A** is not flashing (which means that a cooking program has already been set) by pressing the two buttons   simultaneously you will cancel the program and switch to manual.

If the oven is on, you must switch it off manually.



Minute Minder

The minute counter function consists simply of an acoustic signal which can be set for a maximum of 23 hours 59 minutes.

If the letter **A** is flashing, press the two buttons   simultaneously.

To set the time, press button  and then button  or  until the required time appears on the display (Fig. 9).

The symbol  will come on.

Countdown will begin immediately and can be seen on the display at any time by simply pressing button .

When the time expires, the symbol  will go out and an intermittent acoustic signal will come on which can be switched off by pressing any of the buttons.

Audible Signal

The audible signal sounds at the end of a minute minder cycle or of a cooking programme for a period of 7 minute.

The signal can be cancelled by pressing any function button.

Pressing the  button without having previously selected a function the frequency of the signal change. You can choose from three variations.



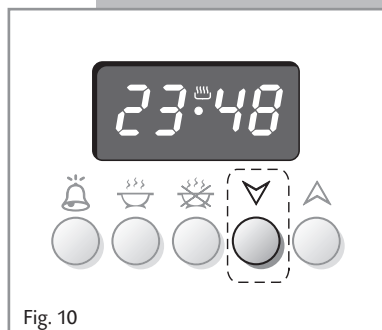
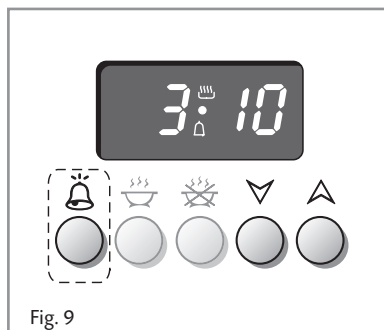

The selected signal is audible as long as the  button is pressed.







Semi - Automatic Cooking

This automatically switches the oven off after the required cooking time. There are two methods of semi-automatic cooking:

1. METHOD: Programming the cooking time (Fig. 11)





- Set the cooking time by pressing button  and then button  to move forward or  to move back if you have gone beyond the required time.
The letter **A** and the symbol  will appear.

2. METHOD: Programming the end of cooking time (Fig. 12)

- Set the cooking time by pressing button  and then button  to move forward or  to move back if you have gone beyond the required time.
The letter **A** and the symbol  will appear.



Having programmed according to one of the above methods, set the temperature and function via the function selector and thermostat knob (see specific chapters).



The oven will come on immediately and when the set time or programmed end of cooking time expires, it will automatically switch off.



During cooking the letter **A** and the symbol  remains on; press button  to display the remaining time until end of cooking or press button  to display the end of cooking time.
The cooking program can be cancelled at any time by pressing the two buttons   simultaneously.

At the end of cooking, turn the oven knob to the off position the  symbol will go out.

The letter **A** will flash and the acoustic signal will come on - this can be switched off by pressing any of the buttons.

Reset the function selector and thermostat knob and set the programmer to manual by pressing the two buttons   simultaneously.

Important: Also if oven is turned off automatically by the programmer, remember to turn to the off position the function selector and the thermostat knob. If not, when pressing two buttons   simultaneously for manual use, the oven will start to operate.

Remember to press the two buttons   simultaneously to be able to use the oven in manual setting.

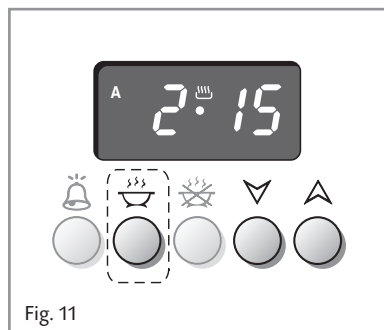

Fig. 11

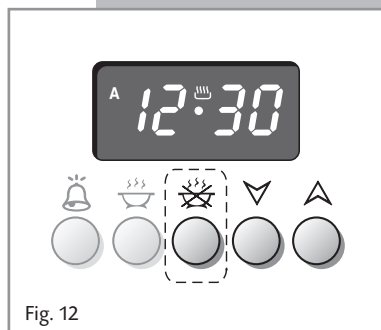









Fig. 12







Automatic Cooking

To cook in the oven in automatic mode follow the instructions below:



1. Set the cooking time
2. Set the end of cooking time
3. Set the cooking temperature and function



These operations are carried out as follows:



1. Set the cooking time by pressing button  and then  to move forward or  to move back if you have gone beyond the required time (fig. 13).
The letter **A** and the symbol  appear.
2. Press button ; the cooking time already added to the clock time appear.
Set the end of cooking time by pressing button  if you go beyond the required time, you can go back by pressing button .
The symbol  go out and the letter **A** remains on (fig. 14).
If during the setting the letter **A** begins to flash on the display and the acoustic signal comes on, this indicates a programming error, i.e. the cooking cycle has been superimposed on the clock time. In this case alter the end of cooking time or the cooking time as above.
3. Set the cooking temperature and function via the function selector and thermostat knob (see specific chapters). The oven is now programmed and everything will work automatically; the oven will come on as required and finish cooking at the programmed time.

At the start of the cooking the symbol  appears.
During cooking the letter **A** and the symbol  remains on; press button  to display the remaining time until end of cooking or press button  to display the end of cooking time.
The cooking program can be cancelled at any time by pressing the two buttons   simultaneously.

At the end of cooking, the oven switches off, the symbol  goes out, the letter **A** flashes and the acoustic signal comes on - this can be switched off by pressing any of the buttons.

Reset the function selector and thermostat knob and set the programmer to manual by pressing the two buttons   simultaneously.

Important: Also if oven is turned off automatically by the programmer, remember to turn to the off position the function selector and the thermostat knob. If not, when pressing two buttons   simultaneously for manual use, the oven will start to operate.

Remember to press the two buttons   simultaneously to be able to use the oven in manual setting.

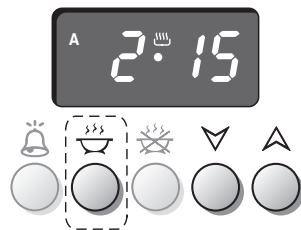

Fig. 13

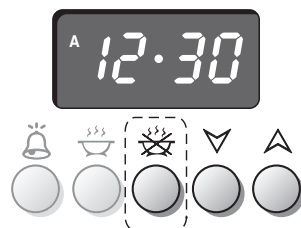

Fig. 14

Do's and do not's

- Do always grill with the oven door closed.
- Do read the user instructions carefully before using the double oven for the first time.
- Do allow the double oven to heat for one and a half hours, before using for the first time, in order to expel any smell from the new oven insulation, without the introduction of food.
- Do clean your double oven regularly.
- Do remove spills as soon as they occur.
- Do always use oven gloves when removing food shelves and trays from the ovens.
- Do not allow children near the double oven when in use.
- Do not allow fat or oils to build up in the oven trays, or oven base.
- Do not place cooking utensils or plates directly onto the oven base.
- Do not grill food containing fat without using the grid.
- Do not cover the grilling grid with aluminium-foil.
- Do not use the oven tray for roasting.
- Do not place hot enamel parts in water. Leave them to cool first.
- Do not allow vinegar, coffee, milk, saltwater, lemon or tomato juice to remain in contact with enamel parts (inside the oven and on the oven tray).
- Do not use abrasive cleaners or powders that will scratch the surfaces and the enamel.
- Do not attempt to repair the internal workings of your oven.
- Do remove the protective film before the first use.
- **Fire risk!** Do not store flammable material in the ovens.

For Your Safety

The product should only be used for its intended purpose which is for the cooking of domestic foodstuffs.

Under no circumstances should any external covers be removed for servicing or maintenance except by suitably qualified personnel.

Important Notes

Installation, and any demonstration, information or adjustments are not included in the warranty.

The oven must be installed by a suitably qualified and registered person in accordance with the relevant Standards.

ATTENTION:
The appliance gets very hot, mainly around the cooking areas. It is very important that children are not left alone in the kitchen when you are cooking.

Care and Maintenance

It is advisable to clean when the appliance is cold and especially for cleaning the enamelled parts.

Avoid leaving alkaline or acidic substances (lemon juice, vinegar, etc.) on the surfaces.

Avoid using cleaning products with a chlorine or acidic base.

WARNING

When correctly installed, your product meets all safety requirements laid down for this type of product category. However special care should be taken around the rear or the underneath of the appliance as these areas are not designed or intended to be touched and may contain sharp or rough edges, that may cause injury.

Inside of Oven

The oven should always be cleaned after use when it has cooled down.

The cavity should be cleaned using a mild detergent solution and warm water. Suitable proprietary chemical cleaners may be used after first consulting with the manufacturers recommendations and testing a small sample of the oven cavity. Abrasive cleaning agents or scouring pads/cloths should not be used on the cavity surface.

NOTE: The manufacturers of this appliance will accept no responsibility for damage caused by chemical or abrasive cleaning.

Enamelled Parts

All the enamelled parts must be cleaned with a sponge and soapy water only or other non-abrasive products.

Dry preferably with a micro fibre or soft cloth.

Stainless Steel, Aluminium, Painted Parts and Silk-screen Printed Surfaces

Clean using an appropriate product. Always dry thoroughly.

Stainless steel surfaces: can be cleaned with an appropriate stainless steel cleaner.

IMPORTANT: these parts must be cleaned very carefully to avoid scratching and abrasion. You are advised to use a soft cloth and neutral soap.

IMPORTANT:

Before any operation of cleaning and maintenance disconnect the appliance from the electrical supply.

ATTENTION:

Let the oven cool down and pay special attention no to touch the hot heating elements inside the oven cavity.

CAUTION:

Do not use abrasive substances or non-neutral detergents as these will irreparably damage the surface.

CAUTION:

Do not use a steam cleaner because the moisture can get into the appliance thus make it unsafe.

CAUTION:

Do not store flammable material in the oven.

CAUTION:

Do not use harsh abrasive cleaners or sharp metal scrapers to clean the oven door glass since they can scratch the surface, which may result in shattering of the glass.

Replacing the Oven Lights

WARNING: Ensure the appliance is switched off before replacing the lamp to avoid the possibility of electric shock.

- Let the oven cavity and the heating elements to cool down;
- Switch off the electrical supply;
- Unscrew the protective cover **C** (fig. 15);
- Unscrew and replace the bulb **B** with a new one suitable for high temperatures (300°C) having the following specifications: 230V, E14 and same power (check watt power as stamped in the bulb itself) of the replaced bulb.
- Refit the protective cover.

NOTE: Oven bulb replacement is not covered by your guarantee.

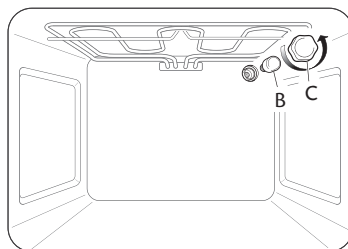
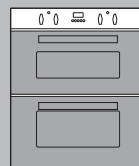
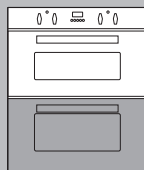
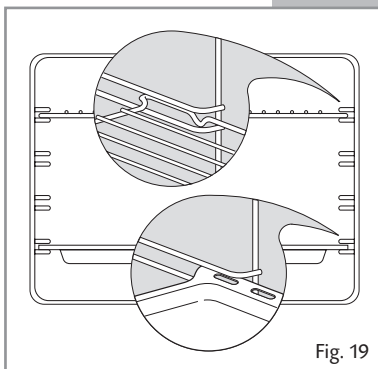
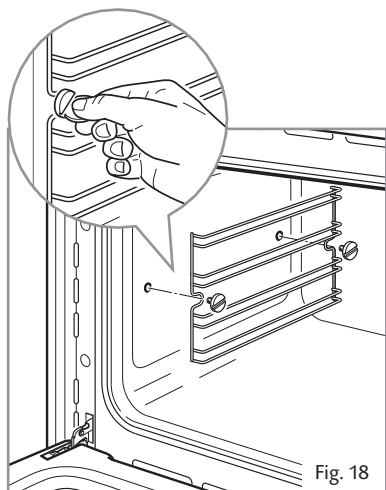
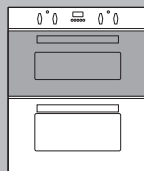
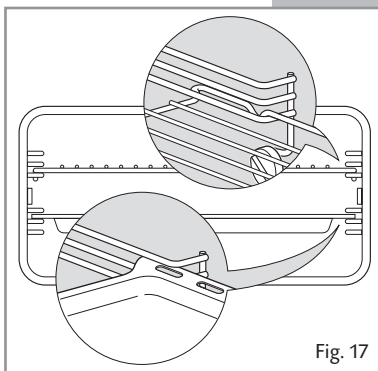
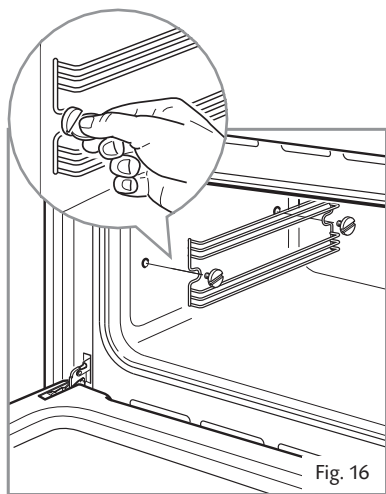

Fig. 15

Assembling and Dismantling of the Side Runner Frames

- Assemble the wire racks to the oven walls using the 2 screws (Figs. 16-18).
- Slide the tray and rack into the runners (Figs. 17-19). The rack must be fitted so that the safety catch, which stops it sliding out, faces the inside of the oven.
- To dismantle, operate in reverse order.



Oven Doors

Removing the Oven Doors

The oven doors can easily be removed as follows:

- Open the door to the full extent (fig. 20a).
 - Open the lever **A** completely on the left and right hinges (fig. 20b).
 - Hold the door as shown in fig. 20.
 - Gently close the door (fig. 20c) until left and right hinge levers **A** are hooked to part **B** of the door (fig. 20b).
 - Withdraw the hinge hooks from their location following arrow **C** (fig. 20d).
 - Rest the door on a soft surface.
- To replace the door, repeat the above steps in reverse order.

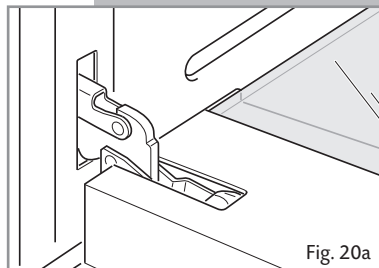
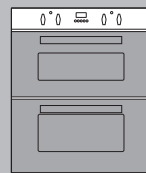

Fig. 20a

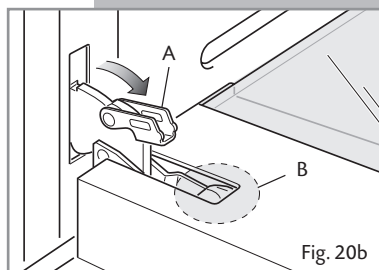

Fig. 20b

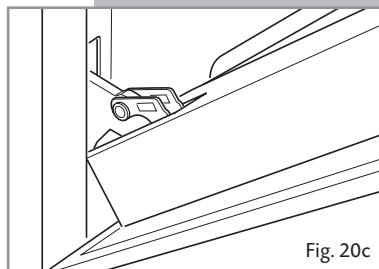

Fig. 20c

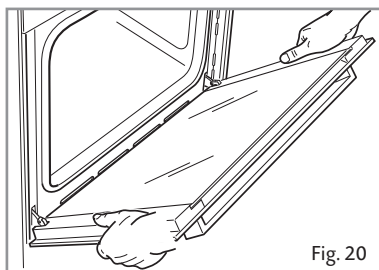

Fig. 20

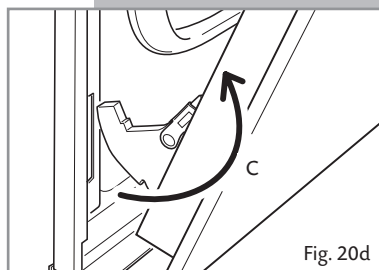

Fig. 20d

Oven Doors - Removable Inner Pane of Glass

Cleaning the Panes of Glass

The oven doors are fitted with no. 2 panes:

- no. 1 outside;
- no. 1 inner;

To clean the panes on both sides it is necessary to remove the inner pane as follows.

Do not use harsh abrasive cleaners or sharp metal scrapers to clean the oven door glass since they scratch the surface, which may result in shattering of the glass.

Removing the Inner Pane of Glass

The oven door has two panes. To clean these, you need to remove the inner pane.

1. Lock the door open:
 - Fully open the oven door (fig. 21).
 - Fully open the lever **A** on the left and right hinges (Fig 22).
 - Gently close the door (Fig. 23) until the left and right hinges are hooked to part **B** of the door (Fig. 22).
2. Remove the inner pane:
 - Top oven door only: remove the seal **G** by unhooking the no. 3 fixing hooks (fig. 24).
 - Gently pull out the inner pane of glass (Fig. 25).
 - Clean the glass with an appropriate cleaner. Dry thoroughly, and place on a soft surface.

Now you can also clean the inside of the outer glass.

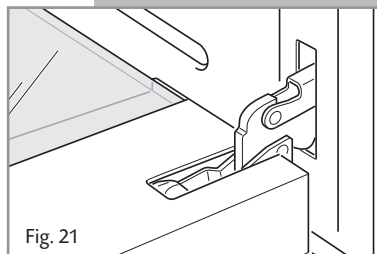
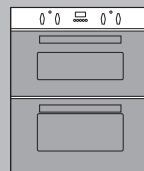

Fig. 21

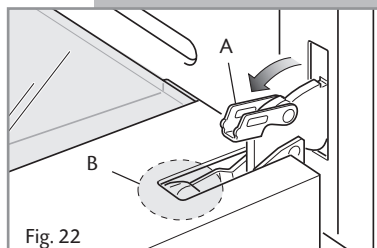

Fig. 22

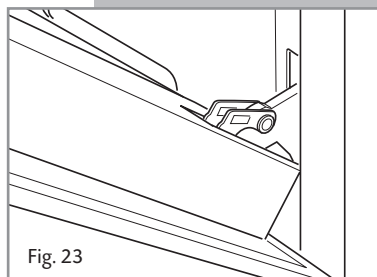

Fig. 23

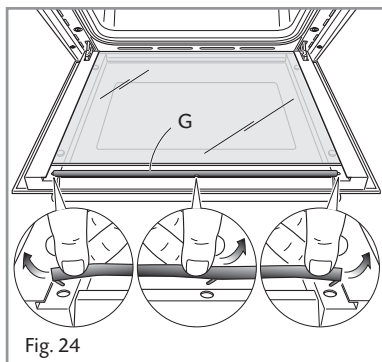

Fig. 24

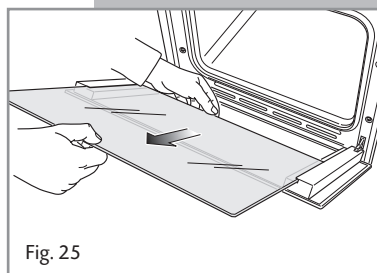

Fig. 25

Replacing the Inner Pane of Glass

1. Make sure the door is locked open (see fig. 23).
2. Replace the inner pane:
 - Check that the four rubber pads are in place (**D** in Fig. 26).
 - Insert the pane in the left **E** and right **F** slide guides (fig. 27), and gently slide it to the retainers **H** (fig. 28).
 - Top oven door only: reassemble the seal **G** in the correct way (fig. 29) by hooking the no. 3 fixing hooks in the proper holes (fig. 30).
 - Unlock the oven door by opening it completely and closing the lever **A** on the left and right hinges (Fig. 31).

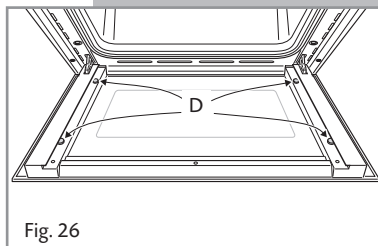

Fig. 26

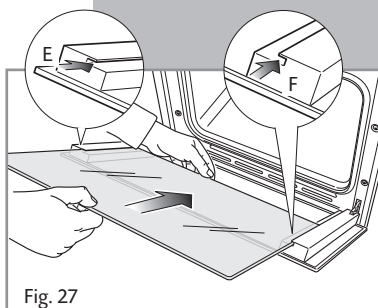

Fig. 27

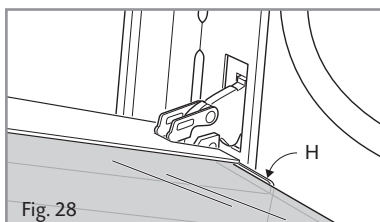

Fig. 28

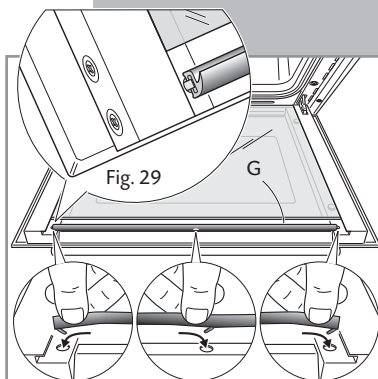
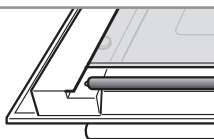

Fig. 29



Fig. 30

The top oven door has a sealed gasket in the top part.



It is normal the opened gap between the top edge of the inner glass and the sealed gasket. This allows the cooling air circulation.

The bottom oven door has not a sealed gasket in the top part.

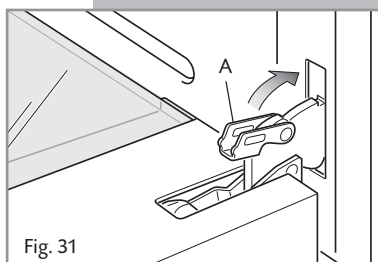
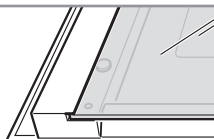

Fig. 31

ADVICE FOR THE INSTALLER

Important

Appliance installation and maintenance must only be carried out by QUALIFIED TECHNICIANS and in compliance with the local safety standards.

- Failure to observe this rule will invalidate the warranty.
- Always disconnect the appliance from the electrical supply before carrying out any maintenance operations or repairs.
- The walls surrounding the oven must be made of heat-resistant material.
- Taking care NOT to lift the oven by the door handle.

WARNING

When correctly installed, your product meets all safety requirements laid down for this type of product category.

However special care should be taken around the rear or the underneath of the appliance as these areas are not designed or intended to be touched and may contain sharp or rough edges, that may cause injury.

To Build in the Double Oven

- **The appliance should be installed by a QUALIFIED INSTALLATION TECHNICIAN. The appliance must be installed in compliance with regulations in force.**

The built under double oven shall be fitted under the working surface into a kitchen base unit (width and depth 60 cm) but you must ensure that it is properly ventilated.

Installation requires a compartment as illustrated and described in next chapters:

- **Installation "A" between Existing Side Cabinets (560 or 600 mm GAP) (figs. 32, 33, 34, 36)**
- **Installation "B" between Side Cabinets by Removing Previous Housing (figs. 35, 36)**
- **Installation "C" by Using Housing Unit (figs. 37, 38, 39)**

CAUTION: Do not lift the double oven by the door handles.

WARNING !

- We would point out that the adhesive which bonds the plastic laminate to the furniture must withstand temperatures not less than 150° C to avoid delamination.
- The appliance must be housed in heat resistant units.
- The walls of the units must be capable of resisting temperatures of 75° C above room temperature.

Installation "A" between Existing Side Cabinets (560 or 600 mm GAP) (figs. 32, 33, 34, 36)

- Mount the 2 (two) metal supports "B" (supplied with the appliance in a separate kit) as indicated in Figs. 33 or 36).
- Fig. 36 only - prepare 2 wood uprights "A" (width 20-50 mm, thickness 18 mm, length 650 mm); mount the 2 wood uprights "A" to the cabinet walls as indicated in figure.
- Build in the double oven making it slide on the metal supports "B".

Installation "B" between Side Cabinets by Removing Previous Housing (figs. 35, 36)

- Remove previous housing.
- Mount the 2 (two) metal supports "B" (supplied with the appliance in a separate kit) as indicated in Fig. 36.
- Prepare 2 wood uprights "A" (width 20-50 mm, thickness 18 mm, length 650 mm); mount the 2 wood uprights "A" to the cabinet walls as indicated in figure.
- Build in the double oven making it slide on the metal supports "B".

Installation "A"

560 mm Gap

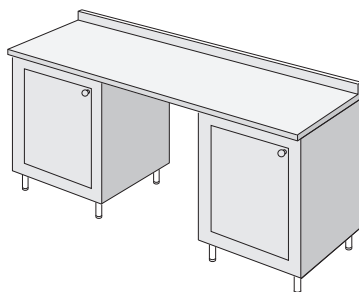
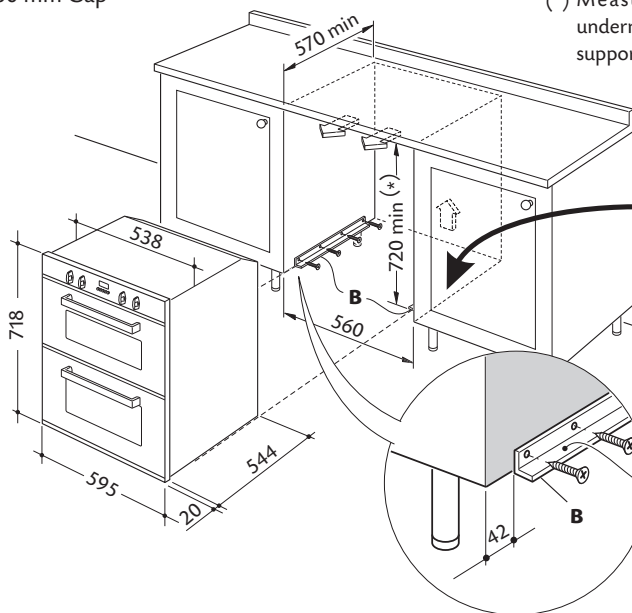

Fig. 32

560 mm Gap



(*) Measure calculated from the underneath of the worktop to the top support base of the "B" supports.

**WARNING !
VERY IMPORTANT**
The underside of the cabinet shall be opened to allow correct air circulation.

Support base

Fig. 33

Installation "A"

600 mm Gap

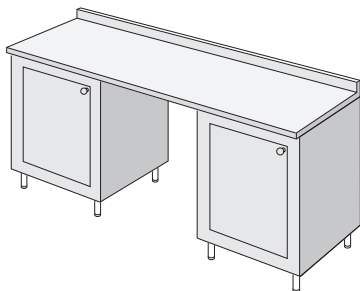

Fig. 34

Installation "B"

Pre existing
600 mm cabinetry

Fig. 35

600 mm Gap

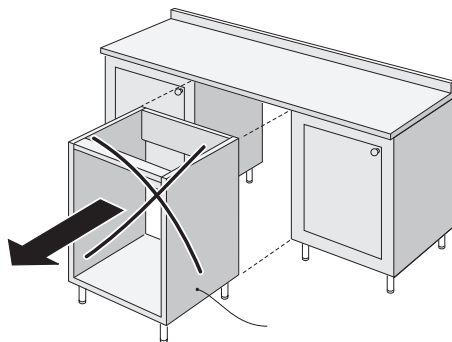
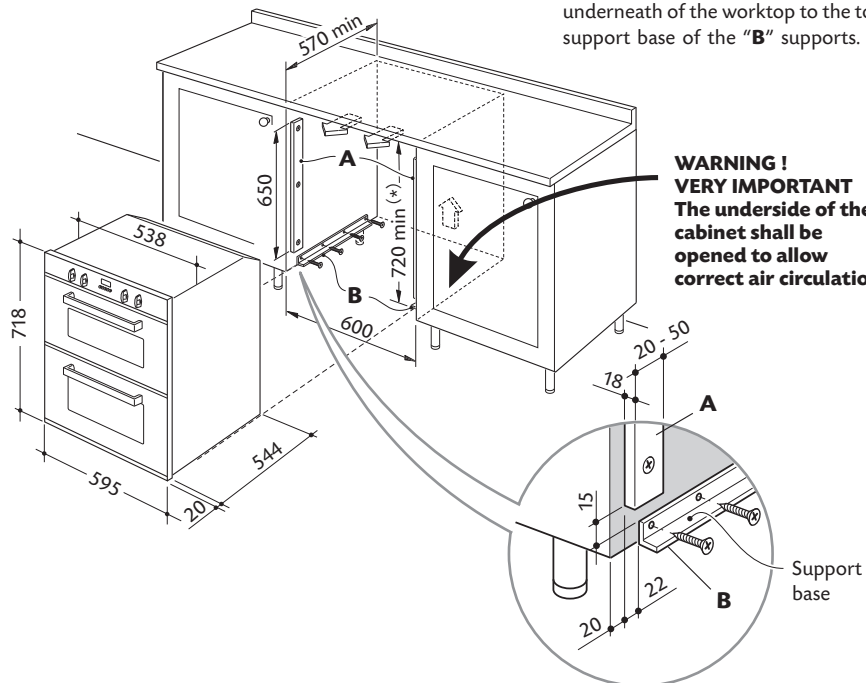

(*) Measure calculated from the underneath of the worktop to the top support base of the "B" supports.

Fig. 36

Installation "C" By Using Housing Unit (figs. 37, 38, 39)

- Remove the single oven shelf, if fitted, as indicated in figure 37.
- Remove the upper cross member support as indicated in figure 38.
- Cut the bottom of the housing as indicated in figure 38.
- Screw oven base housing to adjoining cabinetry by suitable screws (not supplied) as indicated in figure 39.
- Check the position of the cabinet legs to ensure the cut-out does not interfere with the legs support. Otherwise the cabinet may have to be removed as in INSTALLATION TYPE "B".
- Mount the 2 (two) metal supports "B" (supplied with the appliance in a separate kit) as indicated in Figs. 39).
- Build in the double oven making it slide on the metal supports "B".

Installation "C"

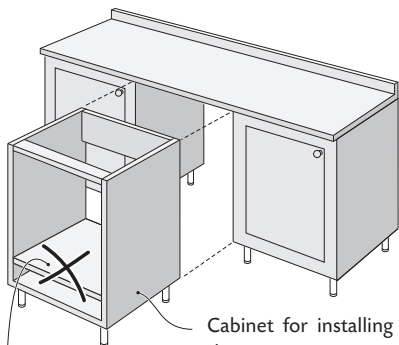

Remove single oven shelf, if fitted.

Fig. 37

Measure calculated from the underneath of the worktop to the top support base of the "B" supports.

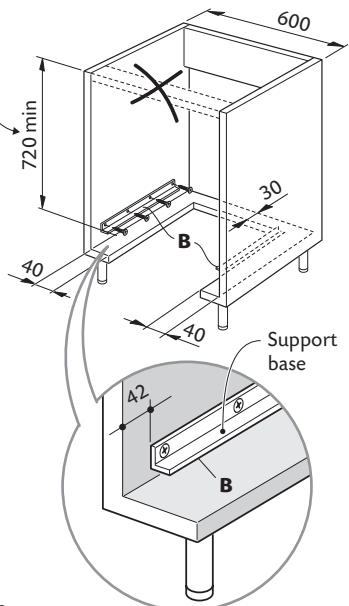

Fig. 38

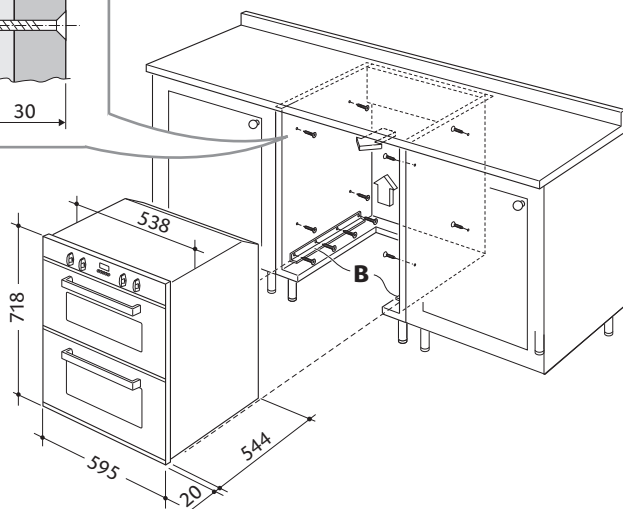
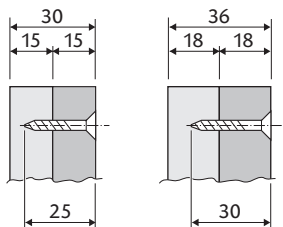

Fig. 39

Fixing the Double Oven

The double oven should then be secured by 6 screws (not supplied) fitted into the holes provided at the sides of the oven (Fig. 40). If you open the oven doors, you will see some screw holes.

Remember the housing should not be free standing but be secured to the wall and/or adjacent fittings.

Note: It is essential that when installing your double oven, adequate air circulation is available within the installation. Inadequate air circulation may greatly impair the performance of your double oven and may affect adjacent cabinets due to an increase in temperature.

Adjust the hinges of furniture door adjacent to the double oven to allow a 5 - 7 mm gap between the furniture door and the oven frame.

IMPORTANT:

If installing a base panel leave a space as indicated in fig. 41 to allow air circulation.

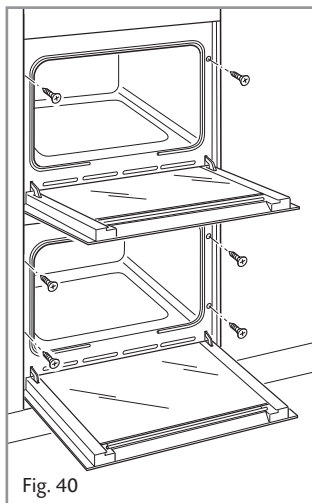

Fig. 40

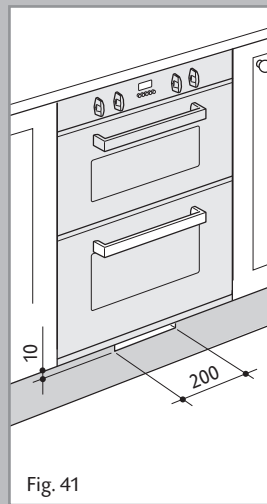

Fig. 41



**KEEP ATTENTION !
STAND AWAY FROM LOUVERS POSITIONED
BELOW THE CONTROL PANEL.
HOT AIR WHICH ESCAPES CAN CAUSE BURNS
TO HANDS, FACE, END/OR EYES.
KEEP CHILDREN AWAY.**

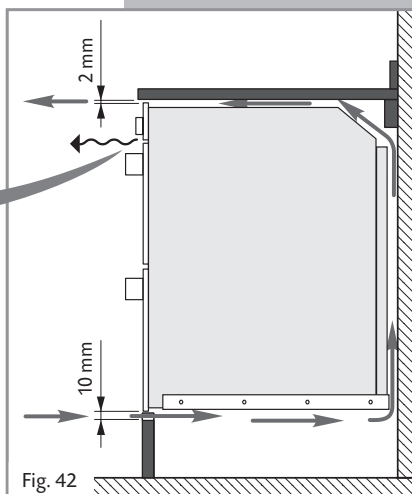

Fig. 42

IMPORTANT:

- To avoid damage to the lower trim please note the following instructions.
- The lower trim is designed to allow for good air circulation and the correct opening of the oven door.
- To ensure the trim is not damaged due to the appliance being placed on the floor, the appliance should be suitably supported as in below illustrations.
- After installation the appliance door should be slowly opened to ensure no damage has occurred.
- **No responsibility for lower trim damage will be accepted if these instructions have not been followed.**

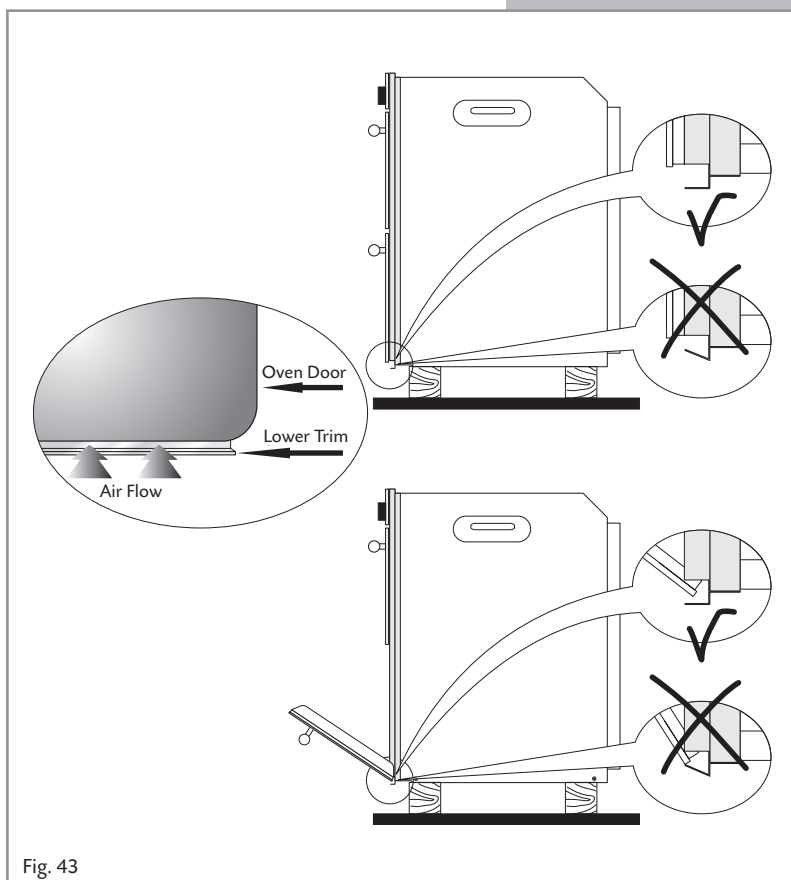

Fig. 43

Electrical Installation

For your safety please read the following information:

WARNING! Before effecting any intervention on the electrical parts the appliance must be disconnected from the network.

IMPORTANT: The oven must be installed in accordance with the manufacturer's instructions. Incorrect installation, for which the manufacturer accepts no responsibility, may cause damage to persons, animals and things.

General

- The connection to the electrical network must be carried out by qualified personnel and must be according to existing norms.
- The appliance must be connected to the electrical network verifying above all that the voltage corresponds to the value indicated on the specifications plate and that the cables section of the electrical plant can bear the load which is also indicated on the plate.
- The appliance can be connected directly to the mains placing an omnipolar switch with minimum opening between the contacts of 3 mm between the appliance and the mains.
- The power supply cable must not touch the hot parts and must be positioned so that it does not exceed 75°C at any point.
- Once the appliance has been installed, the switch must always be accessible.
- If the power supply cable is damaged it must be substituted by a suitable cable.

IMPORTANT: this double oven must be connected to a suitable double pole control unit adjacent to the oven.

NO DIVERSITY CAN BE APPLIED TO THIS CONTROL UNIT.

Feeder Cable Section

Type HO5RR-F or HO5VV-F

230 V~ 3 x 2.5 mm² (**)

(**) – Connection to wall-mounting distribution panel.

The connection of the appliance to the grounding unit is mandatory. The manufacturer declines every responsibility for any inconvenience resulting from the inobservance of this condition.

Connection the Double Oven Mains Cable

Important!

This oven must be connected to the mains power supply only by a suitably qualified person.

Unscrew the screws **A** securing the cover plate **B** behind the oven (fig. 44).

- Remove the cover plate **B**.
- Remove the screws **C** from the cable clamp (fig. 45).
- Insert the mains cable (type H05RR-F or H05VV-F - 3x2,5 mm² section) into the cable protector **P**.
- Connect the phase and earth cables to the mains terminal connection block **D**.

	EARTH
N	NEUTRAL
L	LIVE

- Refit the cable clamp so that it clamps the outer sleeving of the cable, and screw the screws **C**.
- Refit the cover plate **B** and fix it with the screws **A**.

WARNING: This appliance must be earthed

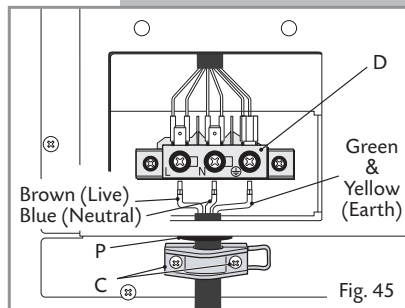
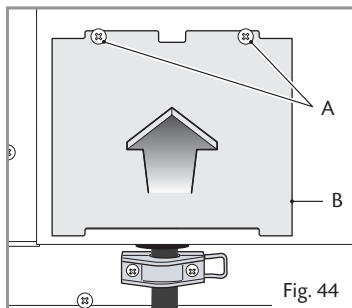

Appliance Servicing

CDA provide a quality and effective after-sales service to cover all your servicing needs.

Please attach your receipt to this page for safekeeping.

Please help us to help you by having the following information available when booking a service-call:

1. Model type, make and model – see the product data plate.
2. Evidence of installation / purchase date
3. Retailer where appliance was purchased
4. Clear and concise details of the fault
5. Full address including postcode and any contact phone numbers

Contact telephone numbers

CDA Customer Care Department

– Telephone: 01949 862012

– Fax: 01949 862003

– Email: service@cda.eu

Guarantee

CDA appliances carry a five-year parts and a one-year labour guarantee.

CDA will repair or replace any defect or part attributable to faulty material or workmanship. Within the first year this will be free of both labour and parts charges. After the first year and within five years, the parts will be supplied free of charge provided that the repair is carried out by an agent authorised by CDA and the labour will be charged at the commercial rate applicable at the time of repair.

The appliance must have been installed by a suitably qualified person and in accordance with the manufacturer's instructions and current legislation. The guarantee does not cover faults caused by the incorrect fitting of appliances.

Limit of Cover

- The guarantee does not cover cosmetic damage e.g. discolouration or oxidation.
- Proof of purchase or installation date must be produced before a service-call will be booked.
- The appliance must be used for domestic purposes only. Appliances used for commercial or professional purposes are not covered by the guarantee. Commercial warranty is available at extra cost.
- The appliance must not be modified or tampered with or repair attempted by any unauthorised person.
- The guarantee does not cover damage caused in transit or by misuse, accident, abuse or neglect.
- The guarantee does not cover routine maintenance.
- Use of parts not supplied or recommended by |C|D|A| will invalidate the warranty.
- Rubber seals, filters, removable glass parts, control knobs and buttons, fuses and light bulbs will need replacing periodically and are not covered by the guarantee.
- Second-hand or reconditioned appliances are not covered by the guarantee.

The conditions under which this guarantee is offered are in addition to the statutory rights of the domestic purchaser and these statutory rights are not affected by this guarantee.

CDA reserve the right to change specification without prior notice.



To contact our Customer Care Department, or for Service,
please contact us on the details below.

Free Manuals Download Website

<http://myh66.com>

<http://usermanuals.us>

<http://www.somanuals.com>

<http://www.4manuals.cc>

<http://www.manual-lib.com>

<http://www.404manual.com>

<http://www.luxmanual.com>

<http://aubethermostatmanual.com>

Golf course search by state

<http://golfingnear.com>

Email search by domain

<http://emailbydomain.com>

Auto manuals search

<http://auto.somanuals.com>

TV manuals search

<http://tv.somanuals.com>