

HCG450

Manual for Installation, Use and Maintenance

CDA



Dear Customer,

Thank you for choosing our product. This appliance is easy to use; read this handbook carefully before installing and using it, however. You will find the correct indications for the best installation, use and maintenance of the product.

- Very important: keep this instruction booklet with the appliance in case you pass it on to someone else.
- **This appliance is designed for non professional use by private individuals at home. It must be used by conscious adults, do not allow children to play with it. The front accessible parts of the equipment could overheat during use.**
- **Supervise children and non self-sufficient people when it is being used so that they do not touch hot surfaces and are not near the appliance while it is in use.**
- The product installation, both gas and electric, must be performed by competent and qualified installers who are aware of the installation regulations in force.
- Before switching the appliance on check that it is correctly regulated for the type of gas available (see relevant section).
- Before maintenance or cleaning disconnect the appliance from the mains and wait for it to cool down.
- When the burners are lit check that the flame is always regular. Before removing the saucepans turn the burners off.
- The user must not change the appliance supply cable (for models which have one). For replacement contact only a qualified engineer.
- The use of a gas appliance produces heat and humidity in the room where it is installed. Make sure that the room is well ventilated, keeping the natural ventilation outlets open or installing a ventilation hood with drain duct.

- If a gas appliance is used for a long time it may require extra ventilation (opening a window or increase of the forced exhaust).
- Be careful not to place saucepans with unstable or deformed bottoms on the burner to avoid accidents by overturning or spilling over of liquid.
- If a burner is turned off accidentally turn off the control knob and try to light it again after waiting at least a minute.
- For any repairs always contact an authorised Technical Customer Service Centre and ask for original spare parts. Repairs by untrained people can lead to damage.
- These instructions are valid only for the countries of destination, the symbols of which appear on the cover and on the appliance.
- The appliance is not intended to be operated by means of an external timer or separate remote-control system.
- This product is for cooking and heating food. Do not use it for other purposes.

This appliance complies with the following directives:

- 2006/95/CE (low voltage)
- 2004/108/CE (electromagnetic compatibility)
- 89/109/CE (foodstuffs)
- 2009/142/CE ex 90/396/CE (gas fittings)
- 2002/96/CE (WEEE)
- 2005/32/CE (EuP)

Description of the main parts of the appliance

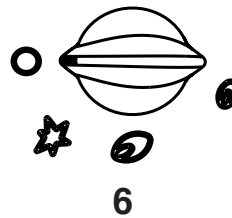
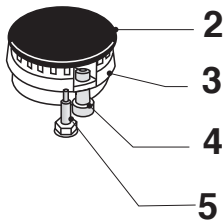
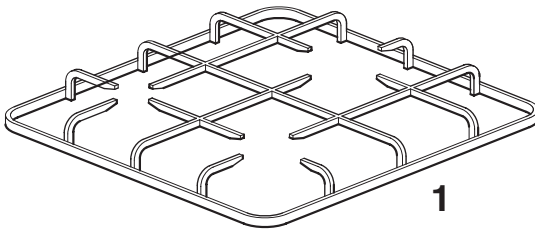



- 1 = grid
- 2 = cover
- 3 = spreader
- 4 = ON spark plug
- 5 = safety valve (for models equipped with a safety valve)
- 6 = knob for burner ignition and adjustment

The hob control area houses the devices and knobs for operation of the gas burners.

Operation of gas burners

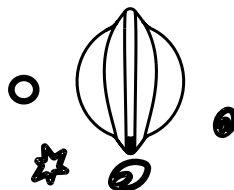
In order to ignite a burner, it is necessary to depress the knob while rotating it anticlockwise, till the index is aligned with the position corresponding to the maximum gas delivery (i.e. the large flame symbol). As far as the models equipped with a safety valve are concerned, once the flame is lit hold the knob depressed for about 3-4 seconds, till the device keeps the burner automatically lit. At this moment it is possible to adjust the flame intensity by rotating the knob anticlockwise from such maximum position to the minimum one (i.e. the small flame symbol).



In order to turn the burner off, rotate the knob clockwise bringing the index back to the position corresponding to the closure symbol  .

RECOMMENDATIONS

In case of electric power failure, it is necessary to carry out the above-described operations by putting a gas lighter or a flame near the burner (in such an event, pay the utmost attention not to burn yourself).

The safety valve (for models where such item is provided) intervenes in case of accidental flame failure, blocking the gas delivery (e.g.: air draughts, spillage of liquids, etc.).

In any case, the ignition device must not be actuated for longer than 15 seconds. Should the ignition manoeuvre fail, or should the burner be accidentally turned off, immediately close the actuation knob and repeat the ignition after one minute at least.

Once the ignition has taken place, adjust the flame according to your needs.

Advice on the use of gas burners

For lower gas consumption and a better yield, use saucepans with diameter suitable for the burners, avoiding the flame coming up round the side of the saucepan (see the Container Table). Use only flat-bottomed pans.

As soon as a liquid starts to boil, turn the flame down to a level sufficient to maintain boiling.

During cooking, when using fats and oils, be very careful because if they overheat they could catch fire.

Take care that the containers don't escape from the edges of the plan and don't invade the control panel.

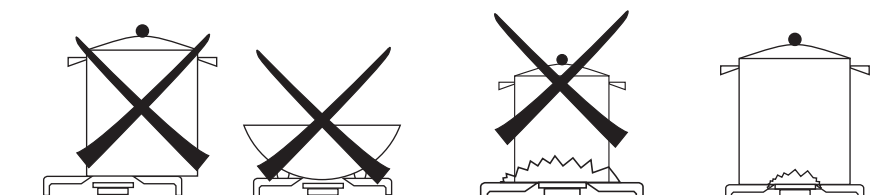

Container table (use flat-bottomed saucepans)

Burners (heights cover) mm	Ø min. Saucepan (mm)	Ø max. Saucepan (mm)
Auxiliary (Ø = 55)	90	160
Medium quick (Ø = 75)	130	180
Quick (Ø = 100)	150	260
Triple ring (Ø = 105)	150	260

Maintenance and cleaning

Do not use jet of steam for cleaning.

Before any operation disconnect the appliance electrically. Wash the enamelled parts with lukewarm water and detergent. Do not use abrasive products.

Wash the burner spreader frequently with boiling water and detergent being sure to remove any deposits which could block the flame outlet. Rinse the stainless steel parts well with water and dry them with a soft cloth.

To clean the hob use slightly damp sponges and wiping cloths: if too much water is used it could penetrate the internal parts and damage electrical parts.

The grids of the hob can be washed in the dishwasher.

For persistent stains use normal non-abrasive detergents, specific products commonly available on the market or a little hot vinegar. Clean the glass hob with hot water, avoiding the use of rough cloths.

Do not use stainless steel pads or acids for cleaning.

To prevent lighting difficulties, carefully clean the lighting spark plugs regularly (ceramic and electrode).

Periodically, or if the knobs become difficult to turn, contact a qualified engineer to lubricate the taps.

Contact a qualified engineer to deal with any other problems which may arise during use.

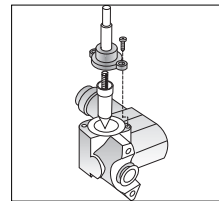

Important. IN CASE OF BURNERS REMOVAL FOR CLEANING PURPOSES, WE RECOMMEND TO MAKE SURE THAT ALL PARTS ARE CORRECTLY POSITIONED BEFORE IGNITING THE BURNERS AGAIN.

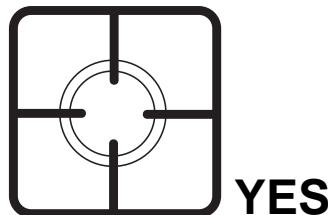
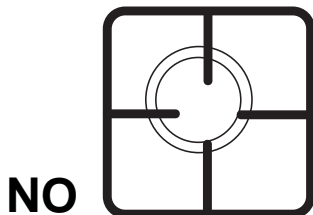

Below we give the instructions for qualified installers so that the installation, setting and maintenance operations are performed correctly and according to the regulations in force.

Positioning

This appliance isn't connected to any scavenging devices of combustion products.

The appliance can only be installed and operate in permanently ventilated rooms according to the local regulations in force.

The natural flow of air must be direct through permanent holes made in the walls of the room to be ventilated leading to the outside, or through single or collective branched ventilation ducts.

The ventilation openings must have a effective cross-section of at least 100 cm² and must be protected against accidental blocking (protection with metal grills or grids). For appliances without safety valve on the hob, the opening section is doubled with a minimum of 200 cm².

There may also be an indirect flow of air from rooms next to that where the appliance is installed, as long as these rooms have direct ventilation, there is no fire risk in these rooms and they are not bedrooms.

The flow of air between adjacent room and the room where it is installed must be free through permanent openings (which may be obtained by making the gap between door and floor larger).

In the room where it is installed there must be a system for leading the combustion fumes to the outside. This may be with a hood or an electric fan which switches on when the appliance is switched on.

Gas connection

The appliance must be connected to the gas supply or the cylinder according to the specifications of the standards in force and after checking that it is adjusted for the type of gas available.

The appliance is set up to operate with the gas specified on the calibration label placed both on the packaging and on the back of the appliance.

When the type of gas available does not correspond to that for which the appliance is set up, replace the corresponding injectors (provided), being careful to put on the new calibration label (provided) and remove the old one.

To perform these operations the qualified installer will follow the indications given in the "Adaptation to the various types of gas" section.

For safety operation make sure that the supply pressure respects the values given in the "Table of burner and injector characteristics".

If the appliance is supplied with liquid cylinder gas, make sure that the cylinder pressure regulator conforms to the local regulations in force.

The appliance must be connected to the gas system by a rigid metal pipe (copper or steel) or continuous wall stainless steel flexible hose in such a way that the appliance is not stressed in any way.

The appliance gas inlet tube has an end nut to which is connected the elbow union (supplied; 1/2 thread male gas). It can be turned depending on installation needs.

The rigid or flexible metal supply pipe (l max = 2mt) is connected to the part opposite the elbow union. Remember to put the gaskets supplied at the two ends of the elbow union.

When these parts are disassembled and reassembled, always replace the gaskets with new ones.

Once the appliance is installed, check that the gas pipe is not pinched or damaged by mobile parts.

Important: when installation is complete, check that all the gaskets are leaktight using a soap-based solution, never a flame.

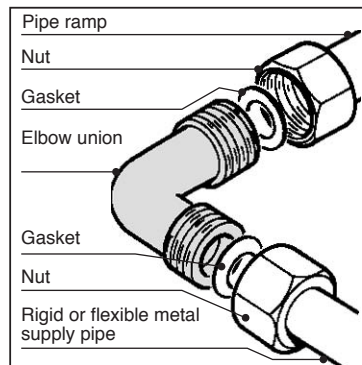

ELECTRICAL CONNECTION

The appliances are provided with a three-pole feeding cable and work with alternate current and single-phase voltage indicated on the “rating plate of the product “report at the end of the instruction manual and on the product. The grounding conductor of the cable is marked with the colours yellow/green.

CONNECTION OF THE FEEDING CABLE TO THE MAINS

Connect the feeding cable to a plug suitable for the load indicated on the rating plate of the product. In case of a direct connection to the mains (cable without plug), it is necessary to insert a suitable omnipolar switch before the appliance, with minimum opening between contacts of 3 mm (the grounding wire should not be interrupted by the switch).

Before connecting to the mains, make sure that:

- the electrical counter, the safety valve, the feeding line and the socket are adequate to withstand the maximum load required (see rating plate).
- the supply system is regularly grounded, according to the regulations in force.
- the socket or the omnipolar switch can easily be reached after the installation
- after carrying out the connection to the mains, check that the supplying cable does not come into contact with parts subject to heating.
- never use reductions, shunts, adaptors which can cause overheating or burning.

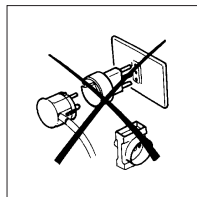

When the appliance is to be installed above a built-in oven, the two appliances must be connected separately, to make it easier to take the appliances out and for electrical safety.

The manufacturer is not liable for any direct or indirect damage caused by faulty installation or connection. It is therefore necessary that all installation and connection operations are carried out by qualified personnel complying with the local and general regulations in force.

Adaptation to different types of gas

To adapt the appliance to a gas different from that for which it was set up (see label on both the packaging and the bottom of the appliance) proceed as follows:

- remove the grids
- remove the covers and the spreaders
- with a 7 mm socket spanner unscrew and remove the injectors.
- replace the injectors with those supplied corresponding to the gas available (see burner and injector characteristics Table)
- replace the various parts proceeding in reverse.
Remember to replace the old rating plate with the new one (supplied).

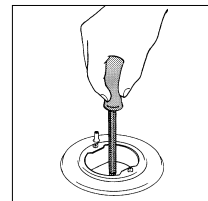
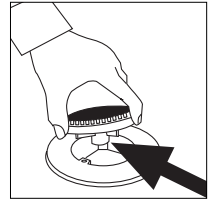

Whenever the gas pressure used is different (or variable) from that used, install a pressure regulator which conforms to the local regulations in force on the input pipe.

Setting the minima

The flame on the small output is regulated in the factory. When the injectors have been replaced or there are special mains pressure conditions, it may be necessary to regulate the minimum again. The operations necessary to perform this operation are the following:

- light the burner
- turn the knob to the minimum position
- take out the knob (and gasket if there is one)
- using a suitably sized screwdriver turn the regulation screw inside or by the side of the tap shaft until a small regular flame is obtained
- put the knob back on and turn it quickly from the maximum position to the minimum position, checking that the flame does not go out
- for burners with safety valve make sure that the regulation obtained is sufficient to maintain heating of the thermocouple. If it is not increase the minimum.

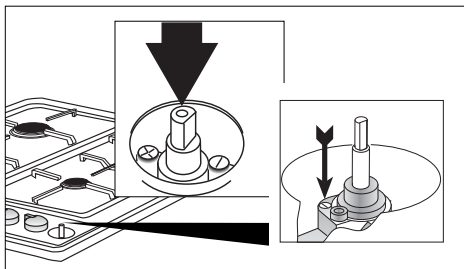

Regulation of minimum for LPG

To regulate the minimum for LPG, completely tighten (clockwise) the screw inside or next to the gas tap pin.

The operations described above can easily be performed whatever the positioning or fastening of the hob to the cabinet.

THE BURNERS REQUIRE NO REGULATION OF THE PRIMARY AIR.

Burner and nozzle characteristic table

CAT. II 2H3 +

Burner (heights cover) (mm)	By pass 1/100 mm	Thermal power (*) (kW)		Liquid gas		Natural gas	
		Rated	Reduced	Output (g/h) G30 - G31	Injector 1/100mm	Output (l/h) G20	Injector 1/100mm
Triple ring (Ø = 105)	55	G20=2,5 G30=2,6	1,2	182 - 179	82	238	115
Quick (Ø = 100)	44	3	0,9	218 - 214	85	286	115
Medium quick (Ø = 75)	34	1,75	0,6	127 - 125	65	167	95
Auxiliary (Ø = 55)	29	1	0,45	73 - 71	50	95	69
Rated supply pressure (mbar) (1 mbar \approx 10,197mm H ₂ O)				G30 = 28 - 30 G31 = 37		G20 = 20	
(*) = With dry gas and with greater calorific power (H _S) at 15°C and 1013,25 mbar							

Instructions for building in the units

The appliance is of class 3. It can be installed with just one side part (to right or left of the hob) higher than the cooking hob and placed at a minimum distance as shown in figure.

It can be built into all units whose walls withstand a temperature 65°C higher than room temperature (UNI EN 30-1-1 e/o CEI EN 60335-2-6).

Avoid installing the appliance near inflammable materials (e.g. curtains, cloths, etc.).

The dimensions of the openings for building in are given in the figure which also gives the minimum distances to be respected between the hole for building in and the side and back walls.

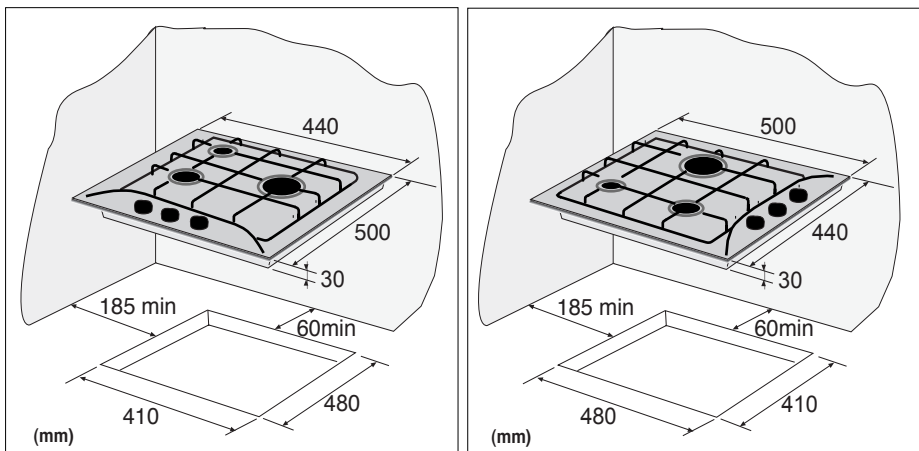

- Position the special sealed gasket (provided) on the edge of the hob making sure that the ends meet without one lying on top of the other.
- Put the hob in the unit opening making sure that it is centred.
- Fasten the hob to the unit with the fastening brackets. The traction of the screws will be enough to cut the sealing gasket so that the excess can easily be removed.

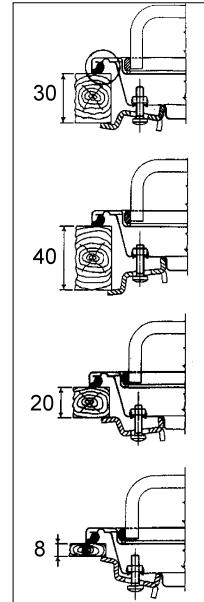

Warnings

If there is a hanging unit over the cooking hob it must be at least 600 mm away from it.

In order to avoid excessive overheating, even if there is no oven below, it is necessary to provide a separating space having at least the size of the embedment hole.

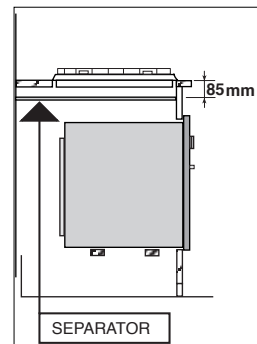

Free Manuals Download Website

<http://myh66.com>

<http://usermanuals.us>

<http://www.somanuals.com>

<http://www.4manuals.cc>

<http://www.manual-lib.com>

<http://www.404manual.com>

<http://www.luxmanual.com>

<http://aubethermostatmanual.com>

Golf course search by state

<http://golfingnear.com>

Email search by domain

<http://emailbydomain.com>

Auto manuals search

<http://auto.somanuals.com>

TV manuals search

<http://tv.somanuals.com>