

CI240 Integrated Washing Machine
Manual for Installation, Use and Maintenance

|C|D|A|



Contents

Page 1	Important information
Page 2	Warnings
Page 3	Washing machine specifications
Page 4	Unpacking the washing machine and removing the transit bolts
Page 5	Connecting to the mains water supply
Page 6-7	Levelling and electrical information
Page 8	Before first use
Page 9	Preparing garments for washing
Page 10	Detergents and additives
Page 11-12	Selecting the wash programme
Page 13-14	Programmes
Page 15	Spin speed and anti-crease
Page 16	Time delay
Page 17	Starting up
Page 18	Wash programme phases and power cuts
Page 19-20	Maintenance and cleaning
Page 21-22	Troubleshooting

Important

This appliance must only be used for the purpose for which it is intended, i.e. domestic use. Any other use could be dangerous and may lead to premature failure of the appliance.

The CDA Group Ltd cannot be held responsible for injuries or losses caused by incorrect use or installation of this product. Please note that CDA reserve the right to invalidate the guarantee supplied with this product following incorrect installation or misuse of the appliance.

Under no circumstances should any external covers be removed for servicing or maintenance except by suitably qualified personnel.

Appliance information:

Please enter the details on the appliance rating plate below for reference, to assist CDA Customer Care in the event of a fault with your appliance and to register your appliance for guarantee purposes.

Appliance Model	
-----------------	--

Serial Number	
---------------	--

CE Declarations of Conformity:

This appliance has been designed, constructed and marketed in compliance with safety requirements of EEC Directive 2006/95/EEC (Low voltage) and requirements of EMC Directive 2004/108/EEC.

IMPORTANT INFORMATION FOR CORRECT DISPOSAL OF THE PRODUCT IN ACCORDANCE WITH EC DIRECTIVE 2002/96/EC.

At the end of its working life, the product must not be disposed of as urban waste. It must be taken to a special local authority differentiated waste collection centre or to a dealer providing this service.

Disposing of a household appliance separately avoids possible negative consequences for the environment and health deriving from inappropriate disposal and enables the constituent materials to be recovered to obtain significant savings in energy and resources. As a reminder of the need to dispose of household appliances separately, the product is marked with a crossed-out wheeled dustbin. 

Warnings

To avoid the risk of fire, electric shocks, injury or damage when using your washing machine, please take the following precautions:

- Please read all the instructions before using the washing machine.
- Do not wash items that have previously been cleaned, washed, soaked or treated with petrol, solvents for dry cleaning, other inflammable substances or explosives, as they produce fumes that could catch fire or explode.
- Do not add petrol, solvents for dry cleaning or other inflammable or explosive substances to the wash water as they produce fumes that could catch fire or explode.
- Do not repair or replace any part of the washing machine or try to carry out any type of servicing unless it is recommended in the maintenance instructions in the manual.
- Do not climb onto the machine or stand on the open porthole door.
- Do not use an extension lead or adaptor to connect your washing machine to the mains supply.
- Follow the washing instructions recommended by the manufacturer of the garment to be washed.
- Do not turn your washing machine on until you are sure that:
It has been installed in accordance with the installation instructions.

All the water, drainage, mains electricity and earth connections meet the local regulations and/or other applicable regulations.

Important: Ensure that the transit bolts have been removed prior to using the machine.

Washing Machine Specifications

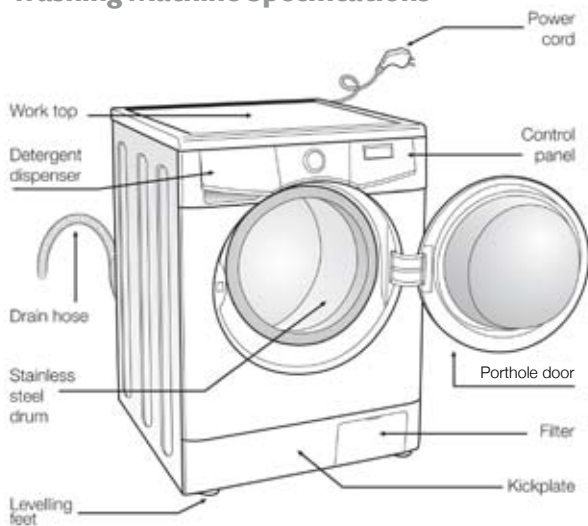

Accessories



Rear plugs



Drain pipe bender

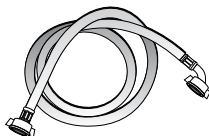

Water inlet hose

Unpacking the Washing Machine

- Remove the base, corner protectors and top cover (Figure 1).

Removing the Transit Bolts

- Remove the screws holding the plastic covers to the back of the washing machine (Figure 2 and 3).
- Loosen and remove the 3 transit bolts (Figure 3).
- Cover the holes with the plastic plugs supplied.

Do not throw the transit bolts away. If you need to move the washing machine after installation you should first replace the transit bolts.

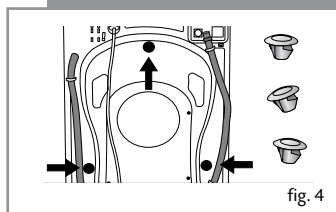
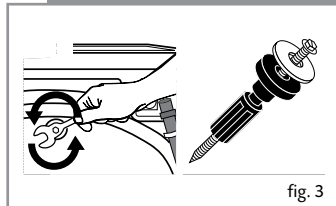
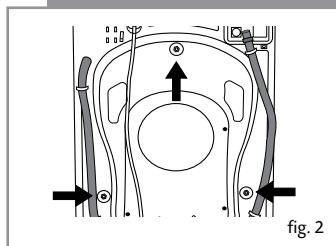
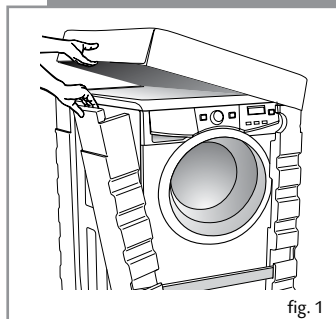

Connecting to the Mains Water Supply

The water supply hose is located inside the drum.

- Connect the bent end of the hose to the threaded inlet of the electrovalve located at the rear of the washing machine.
- Connect the other end of the hose to the water intake. Then securely tighten the connecting nut.

The drain hose must be securely fastened to the outlet to prevent any risk of the drain hose becoming detached and causing flooding.

The washing machine must be connected to the mains water supply, using the new supply hoses supplied with the appliance. Do not use water supply hoses that have been used previously.

For your washing machine to work properly, the mains water pressure must be between 0.05 and 1MPa (0.1 - 10 bar).

Drainage Connection

- It is recommended that you have a fixed drainage outlet 50 to 70 cm from the floor.
- Avoid the drain hose being too tight, kinked or restricted.
- The water outlet can either be connected to a water drain or to a sink outlet spigot. This connect should be a minimum of 50cm and a maximum of 110cm from the floor. The drain hose should be no longer than 4m in length to ensure good performance from the dishwasher.
- After connecting the water supply, check to ensure there are no leaks.

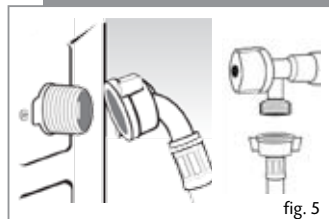

fig. 5

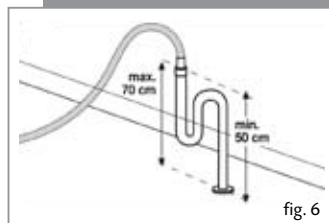

fig. 6

Levelling

- To reduce the noise level from the washing machine and to prevent unnecessary movement during use, you should ensure the washing machine is level using the adjustable feet.
- First, fix and level the rear feet. When they are properly fixed, secure the metal locknut tightly against the underside of the washing machine.
- Put the washing machine into its required position.
- Then level the front feet in the same way as the front feet.

Please note: Raising the washing machine too high can affect the stability of the appliance.

Electrical Connection

- Check the rating plate located on the porthole door of the washing machine before connecting the appliance to the power supply. Ensure that the voltage reaching the plug is the same as that on the plate.

Do not remove the rating plate. The information on it is important.

Do not plug the washing machine plug into the socket with wet or damp hands.

To remove the power cord, pull on the body of the plug, not the cable.

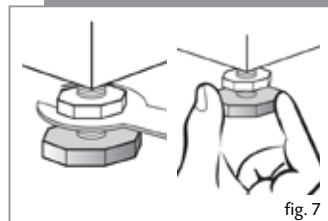

Electrical information

Warning! This appliance must be earthed.

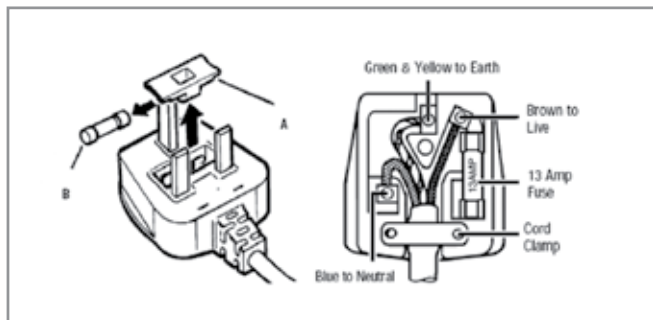

The mains lead of this appliance has been fitted with a BS 1363A 13 amp fused plug. To change a fuse in this type of plug, follow the steps below:

1. Remove the fuse cover and fuse.
2. Fit replacement 13A fuse, ASTA approved to BS 1362 type, into the fuse cover.
3. Replace fuse cover.

Important: Do not use the appliance without the fuse cover in position.

How to connect an alternative plug

If the fitted plug is not suitable for your socket outlet, then it should be cut off and disposed of safely to avoid the risk of electric shock. A suitable alternative plug of at least 13 Amp rating to BS 1363 should be used.

As the colours of the wires in the mains lead of this appliance may not correspond with the coloured markings identifying the terminals in your plug, proceed as follows:-

- The wire which is coloured GREEN and YELLOW must be connected to the terminal which is marked with letter (E) or by the Earth symbol \perp or coloured GREEN and YELLOW.
- The wire which is coloured BLUE must be connected to the terminal which is marked with the letter (N), or coloured BLACK or BLUE.
- The wire which is coloured BROWN must be connected to the terminal which is marked with the letter (L) or coloured RED or BROWN.

If in doubt regarding the electrical connection of this appliance, consult a qualified electrician. Do not shorten the supply cable, the appliance may require removing for servicing.

N.B. Ensure that the plug socket is situated in an easily accessible place.

Before First Use

- When your washing machine has been correctly installed, we recommend that you pre-clean the machine.

This is to check that the installation, the connections and the drainage are all correct, and to thoroughly clean the inside of the washing machine before any wash programmes are run (see the operating instructions on the following pages).

- Prior to pre-cleaning you should ensure the transit bolts have been removed.
- Select the normal programme at 60°C (Figure 9).
- Press the Start/Pause button (Figure 9).

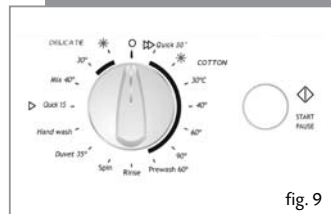

fig. 9

Preparing Garments for Washing

Preparation

- Before placing the clothes in the drum, make sure all the pockets are empty (Figure 10). Any small objects may block the drain pump.

Sorting the Clothes

Sort the clothes according to fabric and how they are made:

- We recommend using the delicate programmes for sensitive fabrics (Figure 11).
- Sort clothes according to how soiled they are (Figure 12).

Wash lightly soiled garments using a short programme.

Use a programme without prewash for medium-soiled garments.

Wash heavily soiled garments using a long programme with prewash.

Sort your clothes according to colour (Figure 13).

Wash white and coloured loads separately.

We recommend loading the washing machine to its full capacity for best water and energy efficiency.

Whenever possible, we recommend that you wash garments of different sizes within the same wash programme. This improves the washing action and also aids the correct distribution of the garments in the drum when spin-drying, and the washing machine will therefore be quieter.

We recommend that small garments are placed in a wash bag.

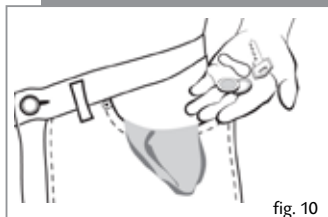

fig. 10

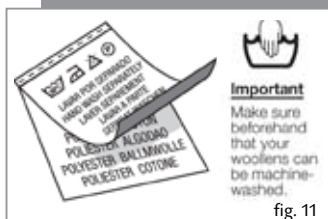

fig. 11

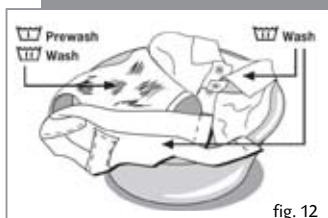

fig. 12

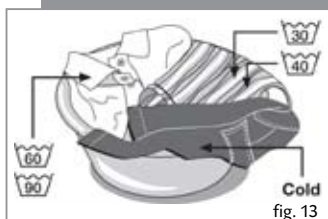

fig. 13

Detergents and Additives

Your washing machine's detergent dispenser has three compartments.

- Add the detergent or additive to the detergent dispenser before starting the wash programme (Figure 14).

The detergent dispenser is designed to allow the use of liquid detergents rather than adding them to the drum. You should ensure that you close the wash compartment flap before adding the liquid detergent.

- To do so, hold the blue tab at the back of the dispenser and pull it forwards until it is fully extended.
- Then release the flap so that it drops down at the back of the dispenser. This will stop the liquid detergent from escaping from the compartment before it is needed.
- To use powder detergents again, then lift the blue tab back up and relocate it by pushing it back into the dispenser housing.

The level of liquid must never be higher than the MAX mark printed on the dispenser wall.

Remember that the amount of detergent to be used will always depend on:

- The amount of clothes to be washed.
- How heavily the clothes are soiled.
- The hardness of the water (Information on water hardness in your area can be obtained from your local water board).

We recommend the use of a decalcifying product if the water hardness is high in your area.

Eco Note

The use of more detergent than necessary will not improve your washing results, and will have a negative effect on the preservation of the environment.

We therefore recommend you follow the detergent manufacturer's instructions.

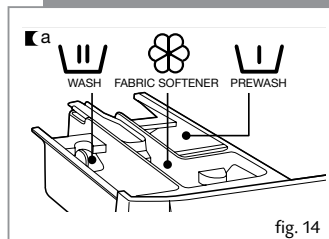

fig. 14

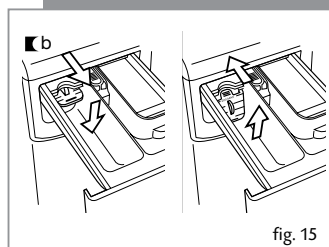

fig. 15

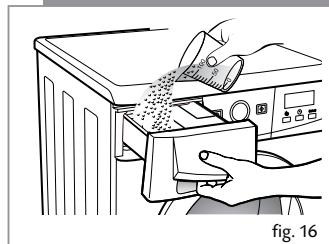

fig. 16

Selecting the Wash Programme

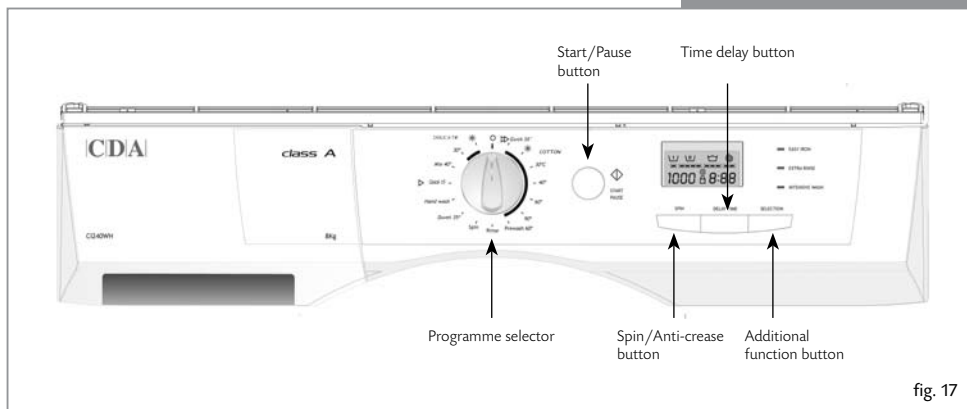

fig. 17

To select a wash programme:

- Turn the programme selector dial clockwise to the desired function.
- The display on the control panel will light up.
- Press the Start/Pause button to begin the programme.

Selecting the Wash Programme

When you select the programme, the following information will be displayed:

- Wash programme phases:
 - Prewash
 - Wash
 - Rinse
 - Spin-drying and draining
- Spin speed
- Programme number (for a few seconds) and then programme duration.
- Additional functions:
 - Easy iron
 - Extra rinse
 - Intensive wash

There are four types of programme:

Normal programmes

Delicate programmes

Wool programme

Auxiliary programmes

Normal	Delicate	Wool	Auxiliary
1 Normal cold	8 Delicate cold	12 Wool cold	14 Rinses
2 Quick 30°C	9 Delicate 30°C	13 Wool 35°C	15 Spin-drying
3 Normal 30°C	10 Delicate 40°C		16 Drain/End
4 Normal 40°C	11 Delicate 60°C		
5 Normal 60°C			
6 Normal 90°C			
7 Prewash 60°C			

Eco Note

We recommend you choose a wash programme without prewash whenever possible. This will save you money and help protect the environment.

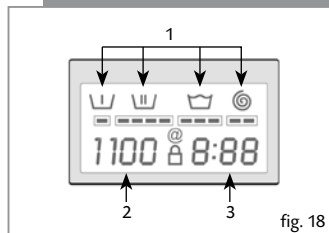

fig. 18

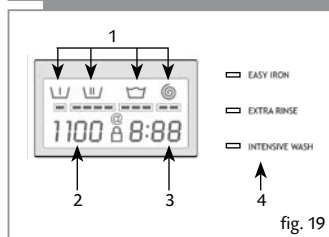



















fig. 19

Washing Machine Programmes

	Programme	Recommended temperature	Fabric type	Possible option buttons						Max. load of clothes (Kg)
				Extra rinse	Intensive wash	Easy iron	Spinlock button	No spin	Refresh	
Normal programmes	1 Normal cold	Cold	Cotton/Linen delicate colours very light soil	YES						
	2 Quick 30°C		Cotton/Linen whites/colours very light soil	YES	NO	YES				
	3 Normal 30°C		Cotton/Linen delicate colours light soil	YES						
	4 Normal 40°C		Cotton/Linen fast colours light soil	YES						
	5 (*) Normal 60°C		Cotton/Linen fast colours medium soil	YES						
	6 Normal 90°C		Cotton/Linen whites heavy soil	YES						
	7 Prewash 60°C		Cotton/Linen whites/fast colours heavy soil	YES						
Delicate programmes	8 Delicate cold	Cold	Synthetic/mix cotton delicate colours very light soil	YES						
	9 Delicate 30°C	 	Synthetic/mix cotton delicate colours light soil	YES						
	10 Delicate 40°C	 	Synthetic/mix cotton delicate colours medium soil	YES						
	11 Delicate 60°C		Synthetic/mix cotton white/fast colours medium soil	YES						
Wool prog.	12 Wool cold	WOOL Cold	Wool/wool mix white/colour very light soil	YES	NO	YES				
	13 Wool 35°C	WOOL 35	Wool/wool mix white/colour light soil	YES	NO	YES				
Auxiliary prog.	14 Rinses	-	Cotton/cotton mix Synthetic/Delicate Wool/wool mix	YES	NO	YES				
	15 Spin-drying	-	Cotton/cotton mix Synthetic/Delicate Wool/wool mix	NO		YES		NO		
	16 Drain /End	-	Cotton/cotton mix Synthetic/Delicate Wool/wool mix	NO						

Washing Machine Programmes

Programme	Max. load of clothes (Kg)	Wash product compartment	Programme description	TURBO TIME PLUS		
				Total consumption kWh/rinses	Approx. duration (minutes)	
	8		Normal wash, rinses, automatic additive absorption if desired and long final spin	0,10/59	50	
	2		SHORT wash, rinses, automatic additive absorption if desired and final long spin	0,25/30	30	
	8			Normal wash, rinses, automatic additive absorption if desired and long final spin	0,30/59	52
	8				0,60/59	57
	8				1,52/59	80
	8				2,20/64	110
	8		Prewash, normal wash, rinses, automatic additive absorption if desired and long final spin	1,50/64	100	
	3,5		Delicate wash, rinses, automatic additive absorption if desired and gentle final spin	0,10/45	50	
	3,5			0,20/45	50	
	3,5			0,40/45	55	
	3,5			1,00/45	70	
	2			WOOL wash, rinses, automatic additive absorption if desired and gentle final spin	0,05/55	30
	2	0,45/55			40	
	8		Rinses, automatic additive absorption if desired and long final spin	0,05/25	23	
	8	-	Drain and final long spin	0,05/0	10	
	8	-	Drain and end of programme. Takes programme to final position	0,00/0	2	

Spin Speed Selection and Anti-Crease

You should first select the wash programme and then select the wash options (Changing the programme cancels the preset selected options).

Each selected programme has its own preset spin speed.

Spin speed

- You can reduce the spin speed or remove it completely by pressing the spin button (Figure 20).
- The spin speed will gradually reduce each time the spin button is pressed at 100 r.p.m. intervals to a minimum of 400 r.p.m (Figure 21).

No spin 0

- Press the spin button again to get to the no spin option and the display will show "0" (Figure 22).
- A programme without a final spin is used to prevent creasing when washing special fabrics.

Anti-crease option 8

- Pressing the spin button again will select the anti-crease option (Figure 23).
- The wash programme stops on the last rinse, with the clothes left in water.
- When the option is deactivated, the washing machine continues the programme, draining and spin-drying.
- It is used, for example, when you are not at home and want to delay the spin drying until you get home, to prevent the clothes creasing after spin-drying and being left in the drum to be removed.

For added safety, the porthole door does not open immediately at the end of programme. There is a time delay of approximately two minutes before you can open the door.

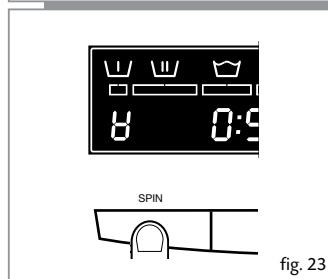
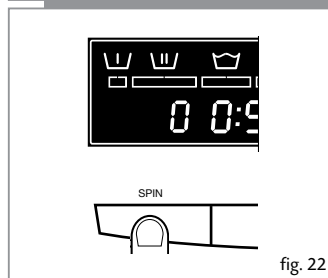
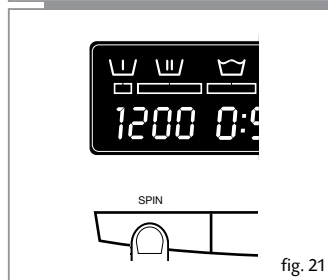
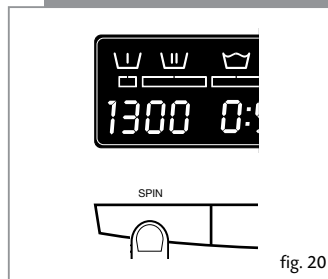

Time Delay

Time delay selection button

- A delay of up to 24 hours can be selected. The delay must be selected after choosing the wash programme.
- To select the hours of delay, press the time delay button (Figure 24). Each time the button is pressed the delayed start of washing is increased by one hour.

Cancelling the delay

- To cancel the delay, press the time delay button repeatedly to cycle through the full 24-hours, and then press again.
- The delay will be cancelled when 24 hours have been reached and the button is pressed once more. If the programme is changed the delay is also cancelled.

Additional functions

Additional function selection button depending on programmes.

- There are 3 options: easy iron, extra rinse and intensive wash.
- Press the button and the desired option will be displayed (Figure 25).
- By pressing the button several times you can choose between several combinations of one, two and up to three additional functions at the same time depending on the programme selected (Figure 26).

Option 1: Easy-iron

This option prevents garments from creasing by means of carrying out a special programme with special turns to fluff out the garments after spin-drying and make them easier to iron.

Option 2: Extra rinse

Increases the level of the final rinse obtained in the clothes; suitable for large loads and garments belonging to people with sensitive skin. However, this option will increase your water consumption.

Option 3: Intensive wash

This option, specially recommended for heavily soiled or stained clothes, achieves better results by extending the normal wash cycle.

If during the additional function selection, the programme is changed or the Start/Stop button is pressed, all the functions selected until then are cancelled.

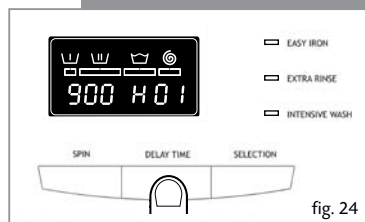

fig. 24

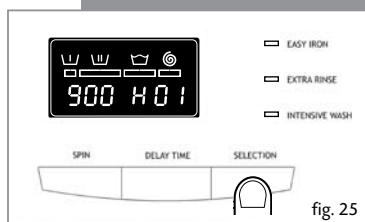

fig. 25

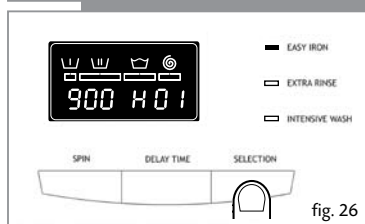

fig. 26

Starting Up

Start/Pause button

- To start up the washing machine you have to press the Start/Pause button (Figure 27).
- The time remaining (in minutes) until the end of the programme will appear on the display at all times.

Lock Function

Lock function selection

- The lock function ensures that the programme will not be affected if any buttons are pressed. It is used when children could press the buttons, etc.
- The lock function should be activated after the wash programme has been selected together with all its options.

Activating the lock function

- The lock function is activated by pressing the Start/Pause button and holding it down for at least 3 seconds (Figure 28).
- The display will show the lock symbol if it is activated.

Deactivating the lock function

- The lock function is cancelled when the wash programme comes to an end (Figure 29).
- If you want to deactivate the lock function before the end of the programme, you have to hold the Start/Pause button down again for at least 3 seconds.
- After 3 seconds, the lock function indicator will disappear from the display, and it will go into pause status.
- The Start/Pause button does not cancel the lock function.

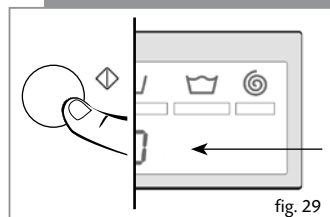
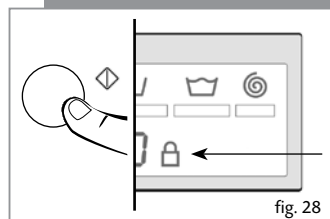
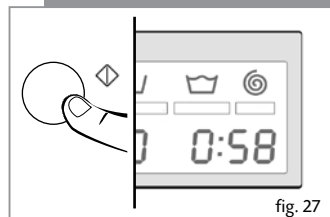

Wash Programme Phases and Power Cuts

Programme Phases

- When the programme is running, the programme phase and the time remaining will appear on the display (Figure 30).
- The active phases will appear successively at the top of the display as the programme progresses (Figure 30). The time remaining until the end of the programme will also appear on the display. It updates at regular intervals, but not minute by minute.
- Any option button can be selected provided the wash phase in which it takes effect has not been passed and when the programme accepts the option.
- Pressing the time delay button during washing will have no effect on the wash programme.
- Pressing the Start/Pause button during the wash activates the PAUSE function.

If the programme is changed on the selector dial during the washing and drying process, the washer will go onto PAUSE status and the programme will be cancelled.

If you need to add or remove a garment, press the Start/Stop button and make sure that the water level is not above the door overflow level and that the temperature inside is not high. Press the Start/Stop button again to restart the wash from the same cycle phase it had stopped at.

Power Cuts

- If there is a power cut, when the electricity comes back on the washing machine will continue to run from where it left off (it has several hours of memory).

Warnings and Advice

- Try to wash clothes of different sizes in the same wash programme to favour the distribution of the clothes inside the drum during spin-drying.
- All the models have a safety system for spin-drying that prevents spin drying from being carried out if the distribution of the clothes inside the drum is too concentrated. This prevents the appliance from vibrating too much.
- If you find that the clothes are not properly wrung out, try spin-drying them again after having distributed the clothes more evenly in the drum.



fig. 30

Maintenance

- After each wash, leave the door open for a while to allow the air to circulate freely inside the machine.
- From time to time, depending on the hardness of your water, it is recommendable to run a full wash cycle using a decalcifying product. This will extend the life of your washing machine.

Cleaning the Detergent Dispenser

- Clean the detergent dispenser whenever there is any washing product residue left inside.
- Pull outwards on the detergent dispenser to remove it completely (Figure 32).
- Use warm water and a brush to clean the compartments (Figure 33).
- Also clean the additive compartment siphons, having removed them first. Once they have been cleaned, put them back making sure that they fit right in to the back (Figure 33).
- Put the dispenser back into the washing machine.

The washing machine should be disconnected from the mains electricity supply before any cleaning or maintenance is carried out.

A dirty or incorrectly fitted siphon will prevent the detergents from being taken in and leave water inside the compartment at the end of the wash.

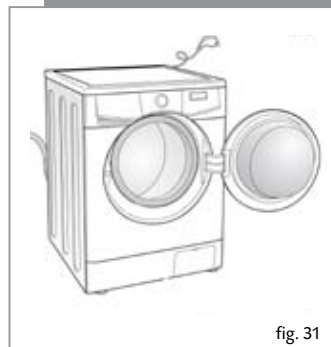

fig. 31

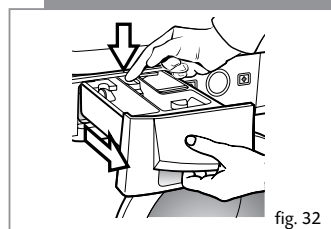

fig. 32

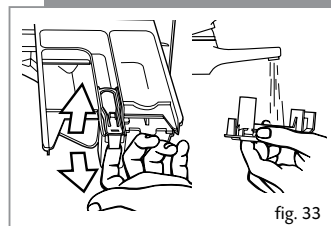

fig. 33

Cleaning the Filter

- Clean the accessible filter if the drain pump is blocked by any foreign objects.
- Open the kickplate cover with the aid of a coin and by gently pulling open (Figure 34).
- Place a container under the drain pump filter to collect any water that comes out of it (Figure 35).
- Remove the drainpipe, place it on the container and open the cover. Water will start to come out.
- Half- or quarter-turn the filter to the left (Figure 36).
- Water will start to come out.
- When all the water has drained out of the washing machine, turn the filter several times until it can be completely removed by gently pulling on it (Figure 36).
- Remove the objects or fluff caught in the filter or the drain pump (Figure 37).
- Put the filter and the filter cap back in place.

To avoid risk of scalding, do not carry out this operation when the wash water is at a temperature of over 30°C.

Cleaning the Outside of the Washing Machine

- The outside of the washing machine should be cleaned with warm soapy water or a gentle cleaning agent. Do not use abrasive cleaning products or solvents.
- It should then be thoroughly dried with a soft cloth.

Wipe any detergent spills immediately to minimise the risk of damage to the cabinet of your washing machine.

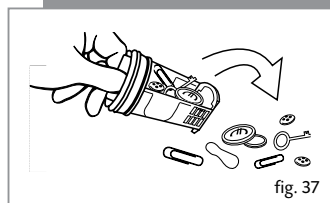
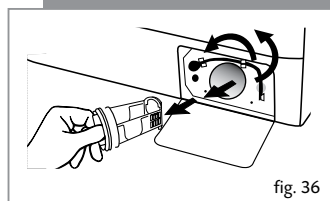
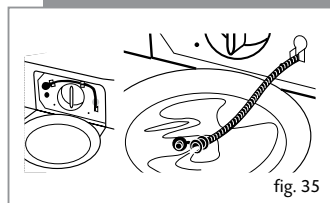
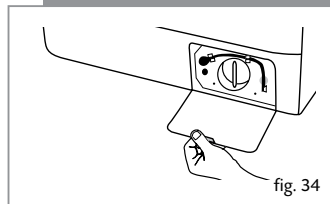

Safety and Troubleshooting

- If you detect any problems with your washing machine, you will probably be able to rectify them yourself by consulting the following instructions.
- If this is not the case, unplug the appliance and contact the technical assistance number.

Do not open up the washing machine. It does not contain any fuses or similar components than can be replaced.

Indicator	Problems
F01	No water coming in
F02	Does not drain or spin-dry
C03	Does not spin-dry
F04	Does not start
F05 - F10	Call the Technical Assistance Team

Problems

Why won't the washing machine start?

This may be due to the following:

- Check the door is properly shut.
- The washing machine is not plugged into the mains or there is no voltage in the mains supply.
- The Start/Pause button has not been pressed.
- If the washing machine door is not properly shut, F04 will appear on the display.

Why is the washing machine vibrating or making too much noise?

This may be due to the following:

- The blocking and transport screws have not been removed.
- The washing machine has not been correctly levelled.
- On spin-drying, the motor makes a kind of whistling noise. This is due to the mechanical action of the motor itself and is perfectly normal.

Why doesn't the washing machine take in water?

- If F01 shows on the display this may be caused by a cut in the water supply, a tap turned off or a blocked water inlet filter.
- The possible solutions are as follows: wait for the water supply to be reconnected, turn on the tap, or remove the water inlet hose and clean the filter.



Problems

Why doesn't the washing machine drain or spin-dry?

- If this failure is detected, F02 will appear on the display.

The reasons for the F02 indicator may be the following:

- The washing machine drain pump blocked, building drainage pipes blocked, or incorrect pump electrical connection.
- Solution: if the pump is blocked, gain access to it as described in section 2, maintaining and cleaning the appliance.

Why doesn't the washing machine spin-dry?

This may be due to the following:

- If this failure is detected, C03 will appear on the display.
- This may be due to an uneven distribution of clothes in the drum and may cause an excessive level of vibrations.
- The solution is to select a spin-drying programme.

Why can't I see any water in the drum during the wash?

- This is due to the fact that the washing machine is provided with a system which is able to adapt to the load and type of fabrics, adjusting the levels of water and energy used, in order to preserve the environment. So, although the water level you can see through the hatch may look low, there is no cause for concern as washing and rinsing efficiency will still be optimum.

Why is there still some water in the dispenser?

- This may be because the dispenser needs cleaning. This simple operation is described in Maintaining and cleaning the appliance.

Why can't I open the porthole door immediately after the wash has finished?

- Washing machines today are provided with safety systems for users. One of these is that the washing machine cannot be opened until it is certain that the drum is quite still. This is why the hatch cannot be opened for 2 minutes.

Other indications

- The washing machine can detect other indications. When this happens a number of other indicators appear on the display: F05, F06..., F10. If this happens, call CDA Customer Care.



To contact our Customer Care Department, or for Service,
please contact us on the details below.

Free Manuals Download Website

<http://myh66.com>

<http://usermanuals.us>

<http://www.somanuals.com>

<http://www.4manuals.cc>

<http://www.manual-lib.com>

<http://www.404manual.com>

<http://www.luxmanual.com>

<http://aubethermostatmanual.com>

Golf course search by state

<http://golfingnear.com>

Email search by domain

<http://emailbydomain.com>

Auto manuals search

<http://auto.somanuals.com>

TV manuals search

<http://tv.somanuals.com>