

Operation Guide ID-25B

ILLUSTRATION

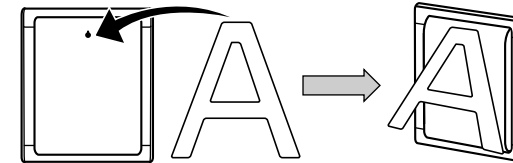

- A sticker is affixed to the glass of this clock when you purchase it. Be sure to remove the sticker before using the clock.
- Depending on the clock model, the configuration of your clock may differ somewhat from that shown in the illustration.

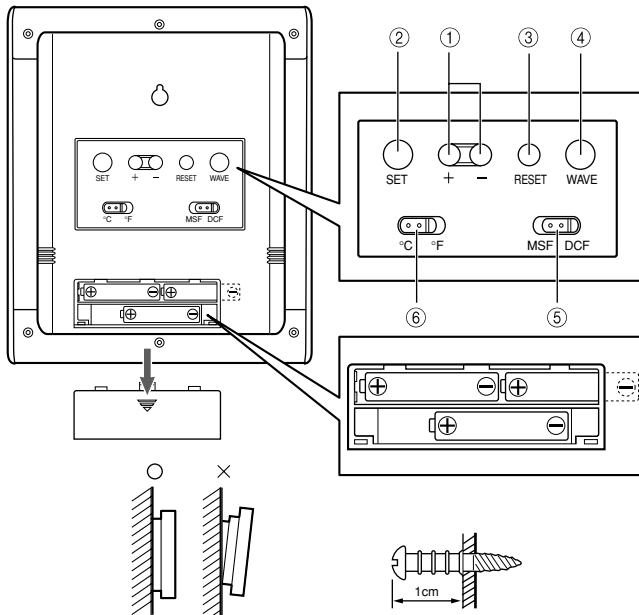
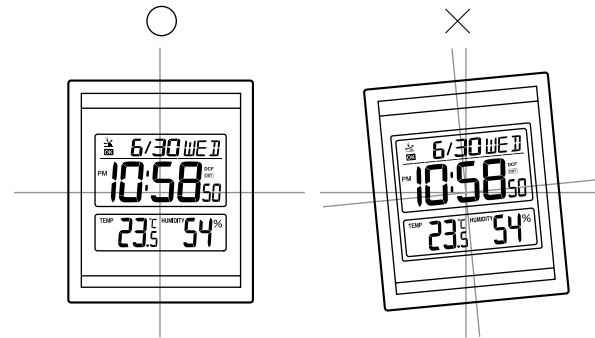
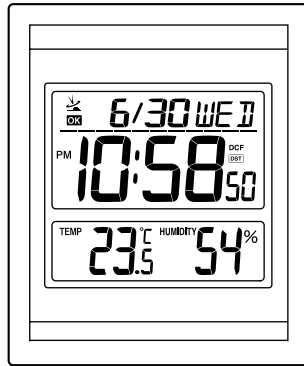
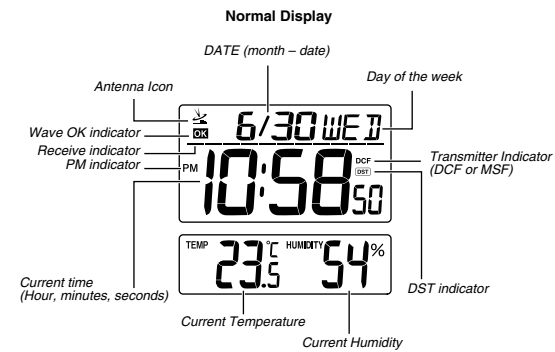

GENERAL GUIDE

① Time Set buttons

Use these buttons to set the current time.

② SET button

Use this button when setting the current time.

③ RESET button

Press this button to reset the clock after replacing its batteries.

④ WAVE button

Press this button to receive the time calibration signal and adjust timekeeping.

⑤ Transmitter switch

Slide this switch to toggle between the two receivable time calibration signal transmitters.

DCF : Mainflingen, German transmitter (Clock displays German time.)

MSF : Rugby, England transmitter (Clock displays U.K time.)

*Note that there is one hour difference between German time and U.K time.

Make sure you select the correct setting for your region.

⑥ °C/°F switch

Slide to toggle the temperature unit between Celsius and Fahrenheit.

TIME CALIBRATION SIGNAL RECEPTION PRECAUTIONS

This clock is able to receive the time calibration signals in Mainflingen, Germany or in Rugby, England. You can select which transmitter should be used for reception by sliding the transmitter switch to the setting you want.

Mainflingen: Signal reception is possible within approximately 1800 km of the transmitter.

Rugby: Signal reception is possible within approximately 1800 km of the transmitter.

- Even when the clock is within the reception range, signal reception is impossible if the signal is blocked by mountains or other geological formations between the clock and signal source.
- Signal reception is affected by weather, atmospheric conditions, and seasonal changes.
- The time calibration signal is bounced off the ionosphere. Because of this, such factors as changes in the reflectivity of the ionosphere, as well as movement of the ionosphere to higher altitudes due to seasonal atmospheric changes or the time of day may change the reception range of the signal and make reception temporarily impossible.
- Reception is best when the back of the clock is facing in the direction of the selected transmitter. Note, however, that moving the clock while the time calibration signal receive operation is taking place will make stable reception impossible.
- Think of the clock as acting like a TV or radio when it is receiving the calibration signal. When receiving indoors, move to a location as near as possible to a window. Proper signal reception can be difficult or even impossible under the conditions listed below.

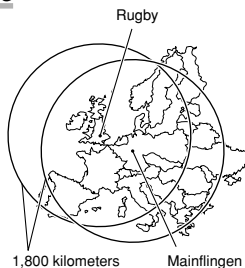

Inside, among buildings, or near neon signs



Inside a vehicle



Near refrigerators or other household appliances, near office equipment, mobile phones or wireless LAN devices.



Near a construction site, airport, or other sources of electrical noise, underground or in tunnels, near railroads, highways, or radio stations with interfering frequencies.



Near high-tension power lines



Among or behind mountains

- Signal reception is normally better at night than during the day.
- Radio interference can make signal reception impossible.
- Strong electrostatic charge can result in the wrong time being set.

USING THE CLOCK

Selecting a Transmitter

Slide the **Transmitter switch** (5) to specify Mainflingen, Germany (DCF) or Rugby, England (MSF) as the transmitter to be used for reception.

DCF: Select this setting to receive the Mainflingen, German transmitter signal. You should select this setting when you live outside of the U.K.

MSF: Select this setting to receive the Rugby, England transmitter signal. You should select this setting if you live in the U.K.

Any of the following procedures can be used to set current date and time.

- Auto receive of the time calibration signal
- Manual receive of the time calibration signal
- Manual setting without using the time calibration signal

Auto Receive

- This clock performs a 1-minute receive operation each hour.
- A signal receive operation takes from two to fourteen minutes under good signal conditions.
- A receive indicator shows the current status of the receive operation.
- More bars in the receive indicator during signal reception indicate better signal reception.

Antenna Icon

The antenna icon appears when at least one signal receive operation is successful during a day. The antenna icon is cleared at 2 a.m. and 3 a.m. each day, and will reappear as soon as a subsequent signal receive operation is successful.

Wave OK Indicator

The Wave OK indicator is displayed when there has been a successful receive operation within the last hour. This indicator disappears at the top of each hour, or when you perform a manual receive operation.

Unsuccessful Signal Reception

The antenna icon disappears from the display if no signal receive operation is successful during a continuous 24-hour period. If this happens, try changing the position or orientation of the clock, and press the **WAVE button** (4) to receive again.

Manual Receive

- Press the **WAVE button** (4) to start a calibration signal receive operation.
- Use the **WAVE button** (4) to perform a receive operation after replacing the clock's batteries or if the auto receive operation was not performed correctly for some reason.
- The antenna icon appears when signal reception triggered by the **WAVE button** (4) is successful.

Important!

- Do not perform any button or switch operation while a signal receive operation is in progress.
- The time calibration signal includes both Standard Time and Daylight Saving Time (summer time) data.
- The DST indicator appears on the display when Daylight Saving Time (summer time) data is received.
- Note that Daylight Saving Time (summer time) is turned on and off in accordance with the received time calibration signal only. You cannot turn it on or off manually.

Setting the Time and Date Manually

- When using the clock in an area that is outside of the range of the transmitter or in an area where signal reception is impossible for some reason, you need to manually adjust the time setting as required.

1. Press the **SET button** (2) to cycle through the setting screens as shown below.

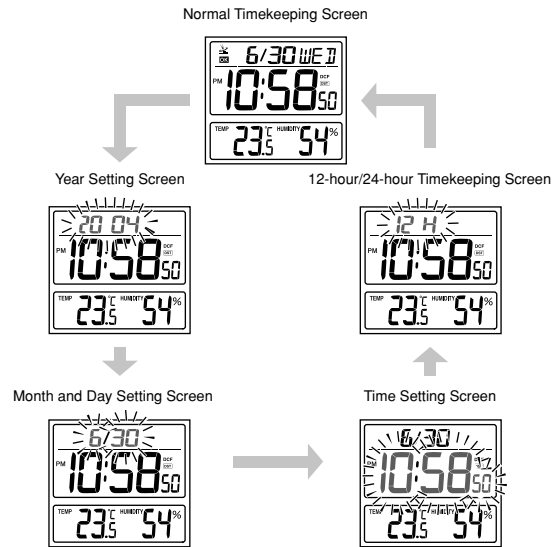

2. While the screen you want is on the display, use the **Time Set buttons** (1) to change the digits that are flashing.

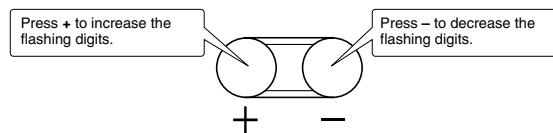

- Holding down + or - changes the flashing digits at high speed.
 - You can set the year in the range of 2000 to 2039. The day of the week is set automatically in accordance with the date setting.
 - Pressing + or - while the Time Setting Screen is on the display causes the seconds count to be reset to 00.
 - Each press of + or - while the 12-hour/24-hour Timekeeping Screen is on the display toggles between 12-hour and 24-hour timekeeping.
3. After making the settings you want, use the **SET button** (2) to display the Normal Timekeeping Screen.
- The clock automatically returns to the Normal Timekeeping Screen if you leave a setting screen on the display for about three minutes without performing any operation.

THERMOMETER FUNCTIONS

- A built-in sensor measures temperature and shows the measured value on the display. The readout from the temperature sensor can also be switched between Celsius (°C) and Fahrenheit (°F).
- The temperature display shows "LO" for temperatures below -50°C (-58°F) and "HI" for temperatures above 70°C (158°F).
- Though temperature readings are displayed up to 0°C (32°F) and greater than 40.1°C (104°F), note that such readings are actually outside the guaranteed temperature range of this clock.

Switching between Celsius and Fahrenheit

- Slide the °C / °F switch (6) to specify Celsius (°C) or Fahrenheit (°F) as the temperature unit.

HYGROMETER FUNCTION

- A built-in sensor measures humidity and shows the measured value on the display.
- The humidity display shows "LO" for humidity below 10% and "HI" for humidity above 95%.

BATTERY REPLACEMENT

Replace batteries whenever the display of the clock becomes dim and difficult to read.

- Pressing down lightly on the battery compartment cover, slide it downwards and remove it.
- Remove all of the old batteries.
- Load a full set of new batteries. Make sure that their positive (+) and negative (-) ends face in the correct directions. If you load batteries incorrectly, they can burst and damage the clock.
- Replace the battery compartment cover.
- Press the **RESET button** (3). Be sure to press the **RESET button** (3) after replacing batteries.

Battery precautions

- Keep batteries out of the reach of small children. If a battery is accidentally swallowed, contact your physician immediately.
- Be sure to load the batteries with their positive (+) and negative (-) ends facing correctly.
- Never mix old and new batteries, or batteries of different brands.
- Never charge the batteries that come with the clock.
- Should batteries ever leak while in the clock, wipe out the fluid with a cloth, taking care not to let any get onto your skin.
- Replace the batteries at least once a year, even if the current batteries are working properly.
- The batteries that come with the clock lose some of their power during transport and storage.

Free Manuals Download Website

<http://myh66.com>

<http://usermanuals.us>

<http://www.somanuals.com>

<http://www.4manuals.cc>

<http://www.manual-lib.com>

<http://www.404manual.com>

<http://www.luxmanual.com>

<http://aubethermostatmanual.com>

Golf course search by state

<http://golfingnear.com>

Email search by domain

<http://emailbydomain.com>

Auto manuals search

<http://auto.somanuals.com>

TV manuals search

<http://tv.somanuals.com>