

LCD Digital Camera

# QV-2300UX / QV-2800UX

## User's Guide

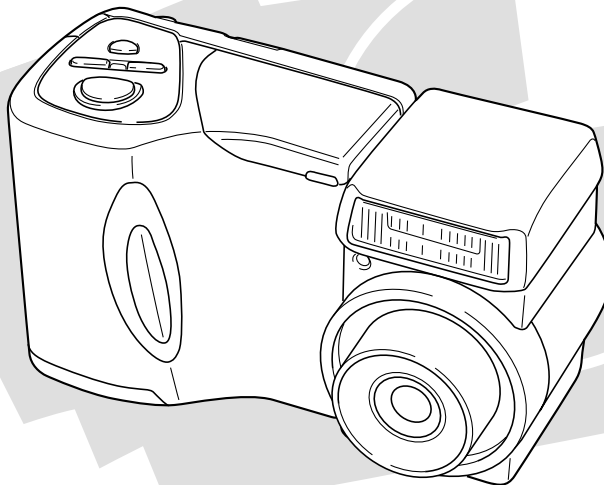

QV-2300UX

All example procedures in this User's Guide are based on the QV-2300UX. The same procedures also apply to the QV-2800UX, unless specifically noted otherwise.

English

Download from [Www.Somanuals.com](http://www.Somanuals.com). All Manuals Search And Download.

**CASIO**®

# INTRODUCTION

To get the most out of your new CASIO Digital Camera, make sure you carefully read this manual and keep it on hand for future reference.

## Unpacking

Check to make sure that all of the items shown below are included with your camera. If something is missing, contact your dealer as soon as possible.

QV-2300UX

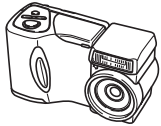

*Camera*

QV-2800UX

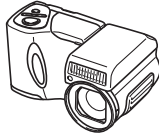

*Soft case*

QV-2300UX



QV-2800UX

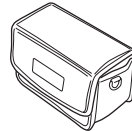

*Strap*

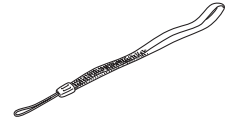

*Lens cap/cap holder*

The lens cap should be affixed to the lens of the camera when you unpack it.



*Memory card (8 MB CompactFlash card)*

Loaded in the camera when you purchase it.



*Special video cable*



*Alkaline batteries (4 AA-size batteries)*



*Soft case strap (QV-2800UX only)*

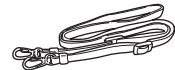

*CD-ROM disc*



*Special USB cable*



*Data Transfer Cable*

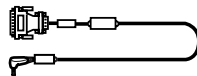

*Wired remote controller (QV-2800UX only)*



*Basic Reference*

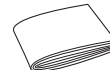

*Bundled Software User's Manual*

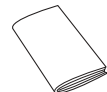

## Contents

**E-2 INTRODUCTION**

|                                 |      |
|---------------------------------|------|
| Unpacking .....                 | E-2  |
| Contents .....                  | E-3  |
| Quick Reference .....           | E-7  |
| Getting Ready .....             | E-7  |
| Recording an Image .....        | E-8  |
| Playback .....                  | E-9  |
| Deleting Images .....           | E-10 |
| Features .....                  | E-12 |
| Recording Features .....        | E-13 |
| Precautions .....               | E-15 |
| General Precautions .....       | E-15 |
| Operating conditions .....      | E-16 |
| Condensation .....              | E-16 |
| About the camera's backlight... | E-17 |

**E-18 GETTING ACQUAINTED**

|                           |      |
|---------------------------|------|
| General Guide .....       | E-18 |
| Front .....               | E-18 |
| Back .....                | E-19 |
| Terminals and Ports ..... | E-20 |
| Bottom .....              | E-20 |

|   |      |
|---|------|
| Lens .....                                    | E-21 |
| Changing the Lens Angle .....                 | E-21 |
| Installing a Conversion Lens .....            | E-22 |
| Lens Precautions .....                        | E-23 |
| Monitor Screen Indicators .....               | E-24 |
| REC mode .....                                | E-24 |
| PLAY mode .....                               | E-25 |
| Operation Indicator Lamp .....                | E-26 |
| REC mode .....                                | E-27 |
| PLAY mode .....                               | E-27 |
| Using the Bundled Accessories .....           | E-28 |
| Using the Lens Cap .....                      | E-28 |
| Attaching the Strap .....                     | E-28 |
| Using the Soft Case .....                     | E-29 |
| Power Requirements .....                      | E-31 |
| Loading Batteries .....                       | E-31 |
| Battery Handling Precautions .....            | E-34 |
| Low Battery Indicator .....                   | E-34 |
| Using AC Power .....                          | E-35 |
| Turning the Camera On and Off .....           | E-36 |
| Power Save Settings .....                     | E-36 |
| Memory Cards .....                            | E-38 |
| Inserting a Memory Card into the Camera ..... | E-38 |
| Removing a Memory Card from the Camera .....  | E-39 |
| Formatting a Memory Card .....                | E-40 |
| Memory Card Precautions .....                 | E-41 |
| IBM Microdrive Precautions .....              | E-41 |
| Menu Screens .....                            | E-43 |

|   |      |
|---|------|
| Setting the Current Date and Time ..... | E-44 |
| Setting the Date and Time .....         | E-44 |
| Selecting the Date Format .....         | E-45 |
| Time Stamp .....                        | E-46 |

**E-47 BASIC IMAGE RECORDING**

|   |      |
|---|------|
| Recording a Simple Snapshot .....             | E-47 |
| About the REC Mode Monitor Screen .....       | E-49 |
| About Auto Focus .....                        | E-49 |
| Recording Precautions .....                   | E-49 |
| Image Recording when the Battery is Low ..... | E-50 |
| Using Zoom .....                              | E-50 |
| Using Optical Zoom .....                      | E-50 |
| Using Digital Zoom .....                      | E-51 |
| Using the Flash .....                         | E-52 |
| Flash Status Indicators .....                 | E-53 |
| Adjusting the Flash Intensity .....           | E-53 |
| Precautions when Using Flash .....            | E-54 |
| Selecting the Focus Mode .....                | E-55 |
| Using the Auto Focus Mode .....               | E-55 |
| Using the Macro Mode .....                    | E-56 |
| Using the Infinity Mode .....                 | E-57 |
| Using the Manual Focus Mode .....             | E-57 |
| Using Focus Lock .....                        | E-58 |
| Specifying Image Size and Quality .....       | E-59 |
| Using the Self-timer .....                    | E-60 |
| Exposure Compensation .....                   | E-61 |

**E-63 OTHER RECORDING FUNCTIONS**

|  |      |
|--|------|
| Shooting Portraits .....                         | E-63 |
| Shooting Landscapes .....                        | E-64 |
| Shooting Night Scenes .....                      | E-65 |
| Instant Setup Using the Scene Mode .....         | E-66 |
| Registering Your Own Scene Setups .....          | E-68 |
| Recording a Movie .....                          | E-69 |
| To record a movie using the normal mode .....    | E-70 |
| To record a movie using the past mode .....      | E-70 |
| Shooting Panoramas .....                         | E-71 |
| Shooting at Fixed Intervals .....                | E-72 |
| Canceling an Interval Mode Timer Operation ..... | E-74 |
| Specifying the Exposure Mode .....               | E-74 |
| Program AE .....                                 | E-74 |
| Aperture Priority AE .....                       | E-75 |
| Shutter Speed Priority AE .....                  | E-76 |
| Manual Exposure .....                            | E-78 |
| Quick Exposure Mode Selection .....              | E-79 |
| Selecting the Metering Mode .....                | E-80 |
| Quick Metering Mode Selection .....              | E-81 |
| Setting the Sensitivity Level .....              | E-81 |
| Using the Filter Function .....                  | E-82 |
| Selecting White Balance .....                    | E-83 |
| Adjusting White Balance Manually .....           | E-83 |
| Quick White Balance Selection .....              | E-84 |

|   |      |
|---|------|
| Enhancing Certain Colors .....                      | E-85 |
| Turning the On-screen Grid On and Off .....         | E-86 |
| Specifying Outline Sharpness .....                  | E-87 |
| Specifying Color Saturation .....                   | E-87 |
| Specifying Contrast .....                           | E-88 |
| Specifying Power On Default Settings .....          | E-88 |
| Resetting the Camera .....                          | E-89 |
| Using the Camera's Shortcut Features .....          | E-90 |
| Changing REC mode FUNCTION Menu Settings            |      |
| Using the Shortcut Buttons .....                    | E-90 |
| To assign REC mode FUNCTION menu items              |      |
| to shortcut buttons .....                           | E-91 |
| Directly Accessing the REC mode FUNCTION Menu ..... | E-93 |

**E-94 PLAYBACK**

|  |       |
|--|-------|
| Basic Playback Operation .....                       | E-94  |
| Playing a Movie .....                                | E-95  |
| Playing a Panorama .....                             | E-96  |
| Enlarging the Playback Image .....                   | E-97  |
| Displaying the 9-image View .....                    | E-98  |
| Selecting a Specific Image in the 9-image View ..... | E-99  |
| Using the Slide Show Feature .....                   | E-100 |

**E-101 DELETING IMAGES**

|   |       |
|---|-------|
| Deleting the Displayed Image .....            | E-101 |
| Deleting Selected Images .....                | E-102 |
| Deleting All Images in Selected Folders ..... | E-103 |
| Deleting All Unprotected Images .....         | E-104 |

**E-105 MANAGING IMAGES**

|  |       |
|--|-------|
| Folders and Files .....                            | E-105 |
| Folders .....                                      | E-105 |
| Files .....  | E-106 |
| Selecting a Folder for Playback .....              | E-107 |
| Protecting Images Against Deletion .....           | E-107 |
| Protecting Selected Images .....                   | E-107 |
| Protecting and Unprotecting All Images in Selected |       |
| Folders .....                                      | E-108 |
| Protecting and Unprotecting All Images .....       | E-109 |
| DPOF .....   | E-110 |
| Making DPOF Settings for Particular Images .....   | E-110 |
| Making DPOF Settings for Particular Folders .....  | E-111 |
| Making DPOF Settings of All Images                 |       |
| on the Memory Card .....                           | E-112 |

**E-113 OTHER SETTINGS**

Turning the Monitor Screen Indicators On and Off ... E-113  
 Changing the Display Language ..... E-114  
 Turning the Confirmation Beep On and Off ..... E-115

**E-116 CONNECTING TO EXTERNAL EQUIPMENT**

Connecting to a Television ..... E-117  
     Selecting the Video Output Signal Mode E-118  
 Connecting the Wired Remote Controller  
 to the Camera ..... E-119  
 Connecting an External Flash Unit  
 (QV-2800UX Only) ..... E-119  
     External Flash Unit Requirements E-119  
     Attaching an External Flash Unit E-120  
 Connecting to a Computer ..... E-122  
     USB Port Connection (Windows, Macintosh) E-123  
     Using a Serial Port Connection E-124  
 Using a Memory Card to Transfer Image Data ..... E-125  
     Memory Card Data E-126  
     DCF Protocol E-126  
     Memory Card File Structure E-127  
     Image Files Supported by the Camera E-128  
     Precautions when Using a Memory Card  
     on a Computer E-128

Using the HTML Card Browser ..... E-130  
     Specifying the Card Browser Type E-130  
     Viewing Card Browser File Contents E-132  
     Saving Card Browser Files E-135

**E-136 REFERENCE**

Camera Menus ..... E-136  
     REC mode E-136  
     PLAY mode E-137  
 Scene List ..... E-138  
 Scene Mode Camera Setups ..... E-140  
 Mode Settings ..... E-142  
     Settings in Each Mode E-142  
     Recording Mode + Exposure Mode Combinations E-143  
 Troubleshooting ..... E-144  
     Messages E-147  
 Specifications ..... E-149

## Getting Ready

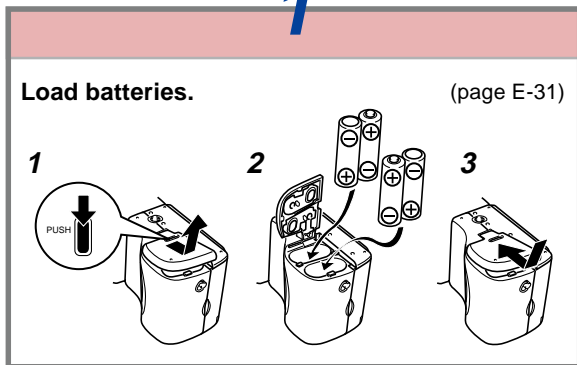
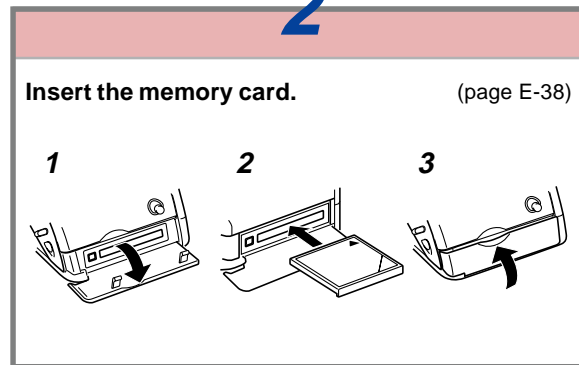
**1****2****3**

## Recording an Image (page E-47)

**3**

Point the camera at the subject, compose the image on the monitor screen, and press the shutter release button half way to focus the image.

**4**

Press the shutter release button all the way down to record the image.

**1**

Slide the **POWER ON/OFF** switch to the right to turn on the camera.

**2**

Slide the **REC/PLAY** selector to "REC".

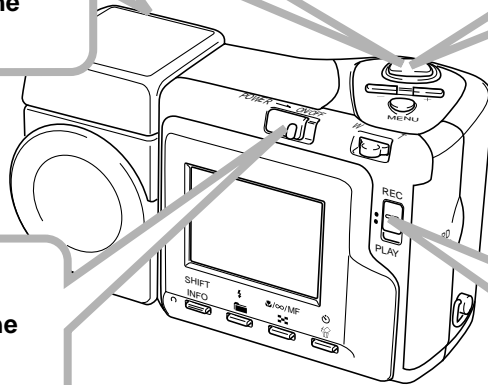



## Playback (page E-94)

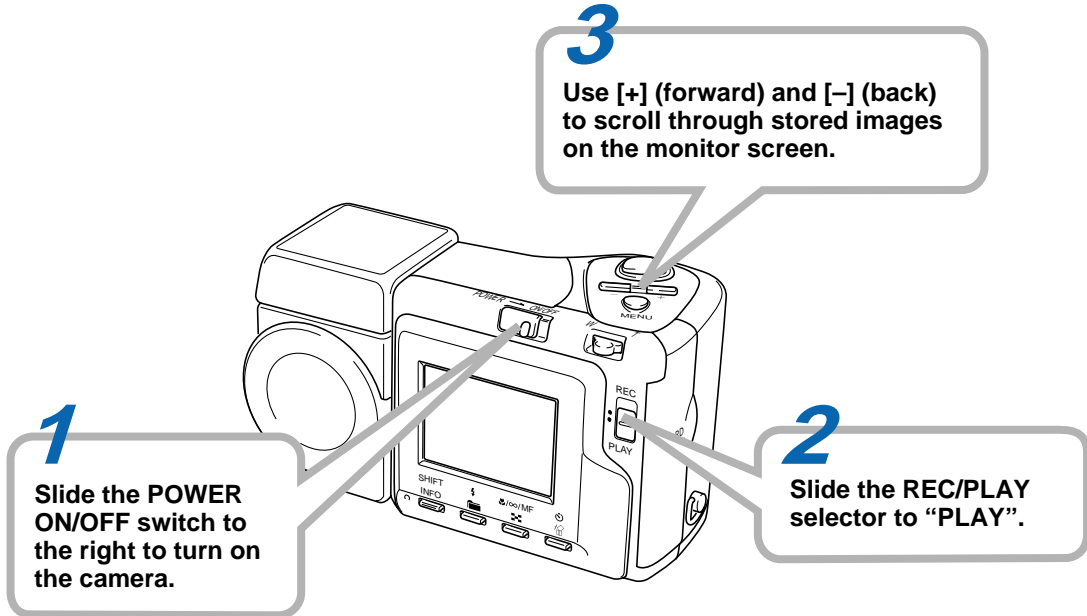

## Deleting Images (page E-101)

1

Slide the **POWER ON/OFF** switch to the right to turn on the camera.

3

Use **[+]** (forward) and **[-]** (back) to scroll through stored images and display the one you want to delete.

6

Use **[+]** and **[-]** to move the cursor to "Yes" and then press the shutter release button to delete the image you selected.

5

Double check to make sure you really want to delete the image you selected.

- You can exit the image delete operation by pressing MENU.

2

Slide the **REC/PLAY** selector to "PLAY".

4

Press  .

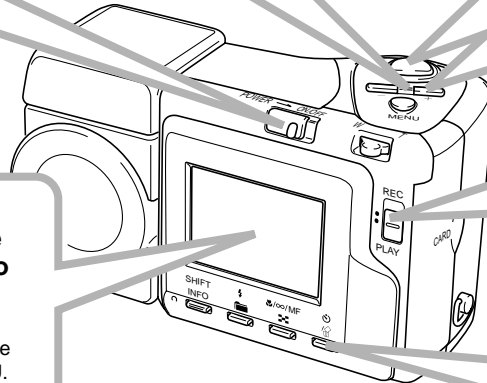

- CASIO COMPUTER CO., LTD. assumes no responsibility for any damage or loss resulting from the use of this manual.
- CASIO COMPUTER CO., LTD. assumes no responsibility for any loss or claims by third parties which may arise through the use of the QV-2300UX or the QV-2800UX.
- CASIO COMPUTER CO., LTD. assumes no responsibility for any damage or loss caused by deletion of data as a result of malfunction, repairs, or battery replacement. Be sure to back up all important data on other media to protect against its loss.
- *Windows and Internet Explorer are registered trademarks of Microsoft Corporation.*
- *Macintosh is a registered trademark of Apple Computer, Inc.*
- *CompactFlash™ and  logo are registered trademarks of SanDisk Corporation.*
- *The USB driver uses software by Phoenix Technologies Ltd.,  
Compatibility Software Copyright © 1997  
Phoenix Technologies Ltd., All Rights Reserved.*
- *IBM is a registered trademarks of International Business Machines Corporation.*
- *Other company, product and service names used herein may also be trademarks or service marks of others.*

## Features

- High-resolution 2.11-megapixel CCD
- 1.8-inch low-glare color LCD (HAST)
- 12X zoom: 3X optical zoom, 4X digital zoom (QV-2300UX)  
32X zoom: 8X optical zoom, 4X digital zoom (QV-2800UX)
- Swivel lens mechanism  
Shoot from the angle you want without moving the camera body.
- External flash connectability (QV-2800UX only)
- Memory card image storage  
Supports CompactFlash cards (CF TYPE I/II) and the IBM microdrive.
- Digital Print Order Format (DPOF)  
Images can be printed easily in the sequence you want using a DPOF compatible printer. DPOF can also be used when specifying images and quantities for printing by professional print services.
- DCF Data Storage  
DCF (Design rule for Camera File system) data storage protocol provides image inter-compatibility between the digital camera and printers.
- VIDEO OUT terminal  
Connect to your TV for big-screen viewing of images.

- USB compatibility  
Connect to your computer for quick and easy image exchanged.
- HTML File Card Browser  
Images are displayed on your computer screen in a convenient format.  
You can view a gallery of image thumbnails on your computer screen.

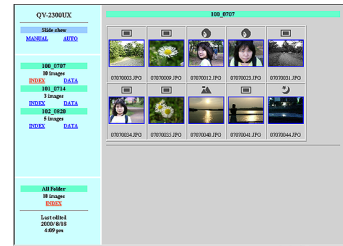

- Image management and manipulation software  
The QV-2300UX comes bundled with a CD-ROM disc that's packed with useful software. Photo Loader automates uploading of images to your computer, and Panorama Editor lets you stitch images together into panorama scenes. Other bundled applications include Internet Explorer (Web browser), Outlook Express (e-mail software), and QuickTime (movie viewer). You also get a copy of the Adobe Acrobat Reader PDF file reader for reading the user documentation on the CD-ROM disc.

## Recording Features

### Portrait Mode

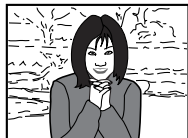

page E-63

### Scene Mode



page E-66

### Landscape Mode

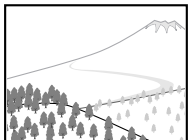

page E-64

### Movie Mode



page E-69

### Night Scene Mode

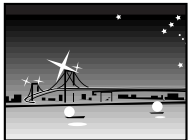

page E-65

### Panorama Mode



page E-71

### Interval Mode



page E-72

### Four exposure modes

Program AE, aperture priority AE, shutter speed priority AE, manual exposure

pages E-74 to E-79

### Three metering modes

Multi-pattern, center weighted, spot

pages E-80 to E-81

### Four focus modes

Auto focus, macro, infinity, manual

pages E-55 to E-58

## Precautions

### General Precautions

Be sure to observe the following important precautions whenever using the QV-2300UX or the QV-2800UX.

All references in this manual to “this camera” and “the camera” refer to the CASIO QV-2300UX or QV-2800UX Digital Camera.

- Never try to take pictures or use the built-in display while operating a motor vehicle or while walking. Doing so creates the danger of serious accident.
- Never try to open the case of the camera or attempt your own repairs. High-voltage internal components create the risk of electrical shock when exposed. Always leave maintenance and repair work up to authorized CASIO service providers.
- Never fire the flash in the direction of a person operating a motor vehicle. Doing so can interfere with the driver’s vision and create the danger of accident.
- Never fire the flash while it is too close to the subject’s eyes. Intense light from the flash can cause eye damage if it is fired too close to the eyes, especially with young children. When using the flash, the camera should be at least one meter from the eyes of the subject.
- Keep the camera away from water and other liquids, and never let it get wet. Moisture creates the danger of fire and electrical shock. Never use the camera outdoors in the rain or snow, at the seashore or beach, in the bathroom, etc.

- Should foreign matter or water ever get into the camera, immediately turn power off, unplug the AC adaptor from the power outlet, and contact your dealer or nearest CASIO service provider. Using the camera under these conditions creates the danger of fire and electrical shock.
- Should you ever notice smoke or a strange odor coming out of the camera, immediately turn power off and unplug the AC adaptor from the power outlet. Using the camera under these conditions creates the danger of fire and electrical shock. After making sure there is no more smoke coming from the camera, take it to your nearest CASIO service provider for repair. Never attempt your own maintenance.
- At least once a year, unplug the AC adaptor from the power outlet and clean the area around the prongs of the plug. Dust build up around the prongs can create the danger of fire.
- If the camera’s case should ever become cracked due to dropping it or otherwise subjecting it to rough treatment, immediately turn power off, unplug the AC adaptor from the power outlet, and contact your nearest CASIO service provider.
- Never use the camera inside of an air craft or in any other areas where its use is prohibited. Doing so can result in an accident.
- Physical damage and malfunction of this camera can cause the image data stored in its memory to be deleted. Be sure to always keep backup copies of data by transferring them to personal computer memory.

- Never open the battery compartment cover, disconnect the AC adaptor from the camera or unplug it from the wall socket while recording images. Doing so will not only make storage of the current image impossible, it can also corrupt other image data already stored in camera memory.

## Operating conditions

- This camera is designed for use in temperatures ranging from 0°C to 40°C.
- Do not use or keep the camera in the following areas.
  - In areas subject to direct sunlight
  - In areas subject to high humidity or dust
  - Near air conditioners, heaters, or other areas subject to temperature extremes
  - Inside of a closed vehicle, especially one parked in the sun
  - In areas subject to strong vibration

## Condensation

- When you bring the camera indoors on a cold day or otherwise expose it to a sudden change of temperature, there is the possibility that condensation can form on the exterior or on interior components. Condensation can cause malfunction of the camera, so you should avoid exposing it to conditions that might cause condensation.
- To keep condensation from forming, place the camera into a plastic bag before moving it into a location that is much warmer or colder than your current location. Leave it in the plastic bag until the air inside the bag has a chance to reach the same temperature as the new location. If condensation does form, remove the batteries from the camera and leave the battery compartment cover open for a few hours.



## About the camera's backlight...

- The camera is equipped with a fluorescent light source to provide the back lighting for its LCD.
- The normal service life of the backlight is approximately six years, when the camera is used for about two hours a day.
- Should the LCD image appear abnormally dark, take the camera to your dealer or an authorized CASIO service provider to have the light source replaced. Note that you will be charged for this replacement.
- Under very cold conditions, the backlight may require more time than normal to light, or reddish bands may appear in the displayed image. These conditions do not indicate malfunction, and normal operation should return at higher temperatures.



# GETTING ACQUAINTED

This section contains important information you should know when trying to operate the camera.

## General Guide

The following illustrations show the names of each component, button, and switch on the camera.

### Front

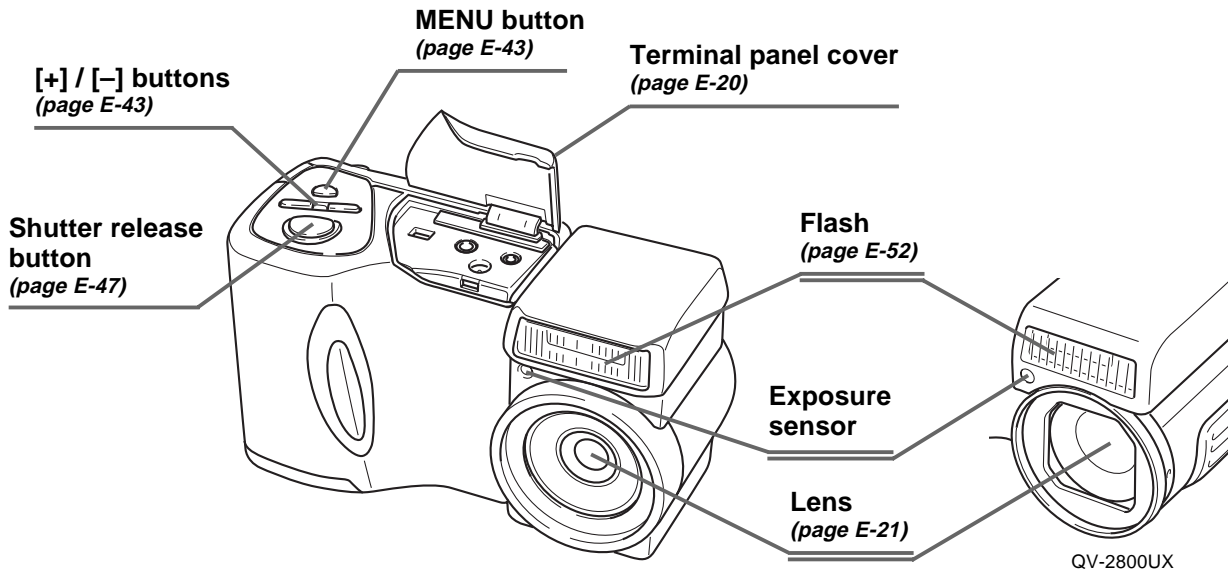

## Back

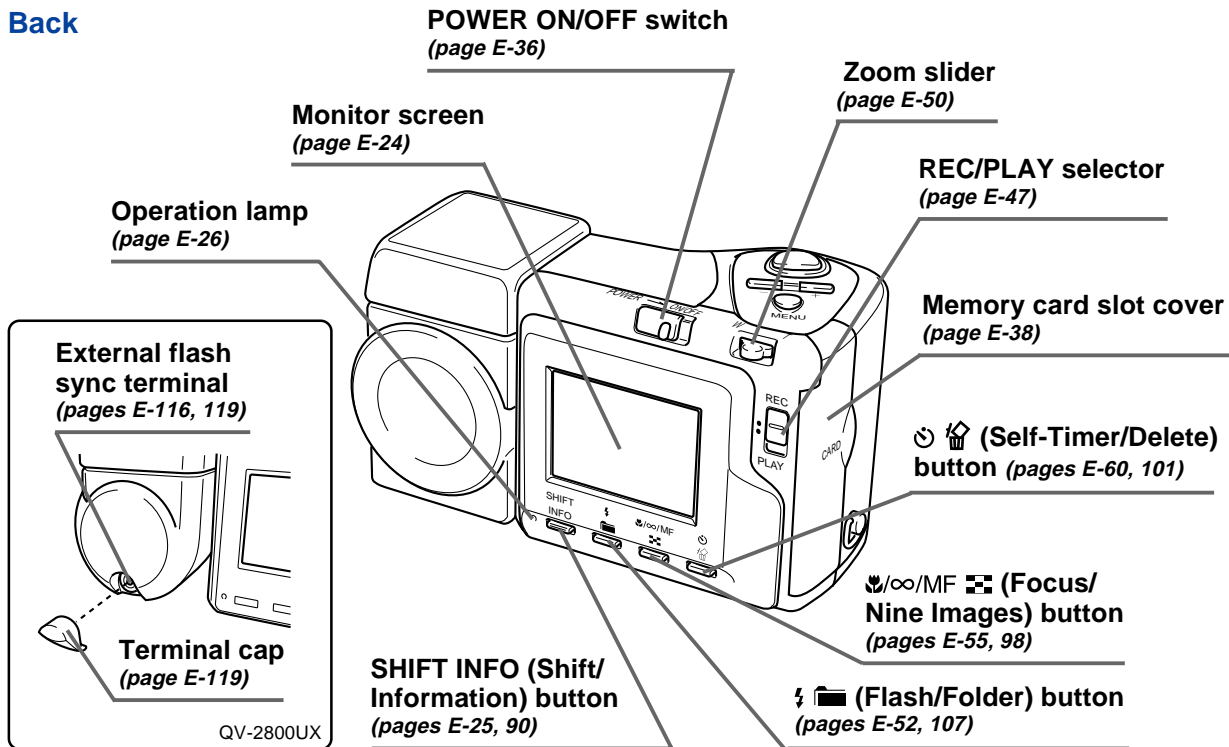

## Terminals and Ports

**VIDEO OUT terminal**  
(page E-116)

**DIGITAL terminal**  
(page E-116)

**USB port**  
(page E-116)

**DC IN 6V terminal**  
(page E-35)

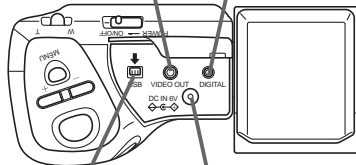

## Bottom

**Tripod screw hole**

**Release button**  
(page E-31)

**Battery compartment cover**  
(page E-31)

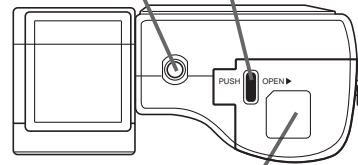

**Open Terminal Panel Cover**

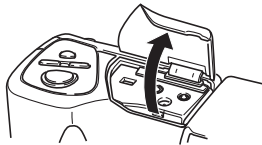

## Lens

The swivel lens mechanism lets you easily aim at the angle you want, without changing the position of the camera body.

### Changing the Lens Angle

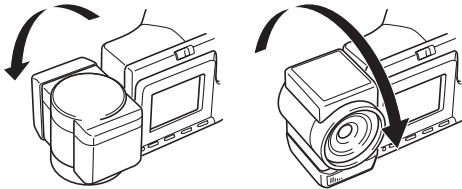

- Whenever you swivel the lens so it is pointing in the direction of the back of the camera, the image on the monitor screen is automatically adjusted so it shows a mirror image of what it picked up by the lens. This makes self-portrait images appear with the correct orientation when viewed on a display.

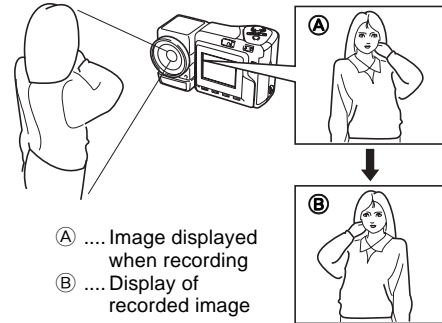

### IMPORTANT!

- Do not use undue force when rotating the lens mechanism and never try to force it past the point where rotation stops naturally. Rough handling can cause the lens mechanism to break and other damage to the camera.
- The proper orientation of the lens when you store the camera in its case depends on your camera model.
  - \* QV-2300UX: Lens should be pointed forward.
  - \* QV-2800UX: Lens should be pointed up.
- Never set the camera down while the lens is pointed downwards. Doing so can cause bending or other damage to the area around the lens.
- Always leave the lens cap on the lens except when you are actually recording images.

## Installing a Conversion Lens

Optionally available conversion lenses change the focal distance, which provides enhanced telephoto or wide-angle capabilities. The method you should use to install a conversion lens depends on your camera model.

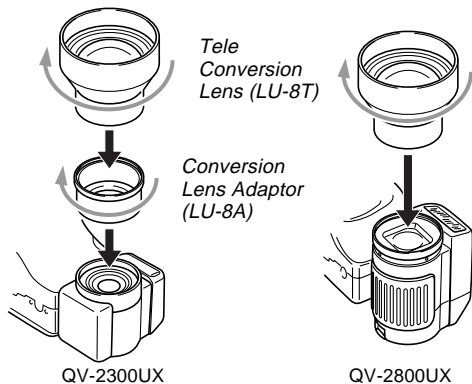

- QV-2300UX: You must install an optionally available lens adaptor (LU-8A) in order to use a conversion lens or a commercially available lens filter.
- QV-2800UX: A conversion lens or a commercially available lens filter can be installed directly, without an adaptor.
- Tele Conversion Lens LU-8T: 1.5X
- Focusing distance when installed  
 QV-2300UX: Approximately 1m to  $\infty$   
 QV-2800UX: Approximately 2.5m to  $\infty$

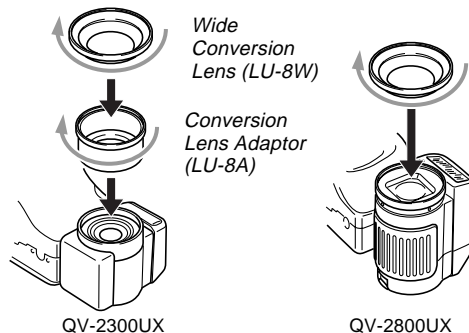

- Wide Conversion Lens LU-8W: 0.7X
- Focusing distance when installed  
 QV-2300UX/QV-2800UX: Approximately 1cm to  $\infty$



**IMPORTANT!**

- Be sure to use the Conversion Lens Adaptor whenever you install a conversion lens or filter. If you don't, the lens will come into contact with the conversion lens or filter when it extends from the camera, resulting in malfunction. (QV-2300UX only)
- Flash is disabled while a conversion lens is being used.
- Setting the camera to wide-angle zoom while the Tele Conversion Lens causes shadows around the periphery of the image. This is because the frame of the attached filter or lens blocks some of the light coming into the lens. Because of this, you should always use telephoto zoom whenever you are using the Tele Conversion Lens.
- The effects of hand shake are magnified while the Tele Conversion Lens is being used. Whenever you are using a conversion lens, install the cushion that comes with it and mount the camera on a tripod so it is secure.
- Due to certain characteristics of the Wide Conversion Lens, you may notice some slight distortion in images recorded with it installed.
- Make sure that  (Macro Mode) is selected as the focus mode whenever you are using the Wide Conversion Lens.
- Note that optical zoom is restricted as shown below in the Macro Mode .
  - \* QV-2300UX: 1X fixed (QV-2300UX)
  - \* QV-2800UX: 1X to 1.6X (QV-2800UX)
- Use of the flash while a commercially available lens hood is installed may not produce desired results.

**Filters**

- The designs of some filters can cause shadows around the periphery of the image.
- Auto focus and flash may not produce desired results while a filter is on the lens.
- Filters do not produce exactly the same results as those obtained with a film-based camera.
- Do not use multiple filters in combination.

**Lens Precautions**

- Fingerprints, dust, or any other soiling of the lens can interfere with proper image recording. Never touch the lens with your fingers. You can remove dust particles from the lens surface by using a lens blower to blow them off. Next, wipe the surface of the lens with a soft lens cloth.
- The lens of this camera extends from its body when you turn on power and retracts when you turn off power. Take care not to subject the lens to undue force or impact, and never set the camera face down so the lens is in contact with a tabletop, etc. Be sure to remove the lens cap before turning on the camera.
- Never remove the camera's batteries or unplug its AC adaptor while the lens is extended. Doing so leaves the lens extended, and creates the risk of lens damage.

## Monitor Screen Indicators

The following describes the different indicators and markings that appear on the camera's monitor screen.

### REC mode

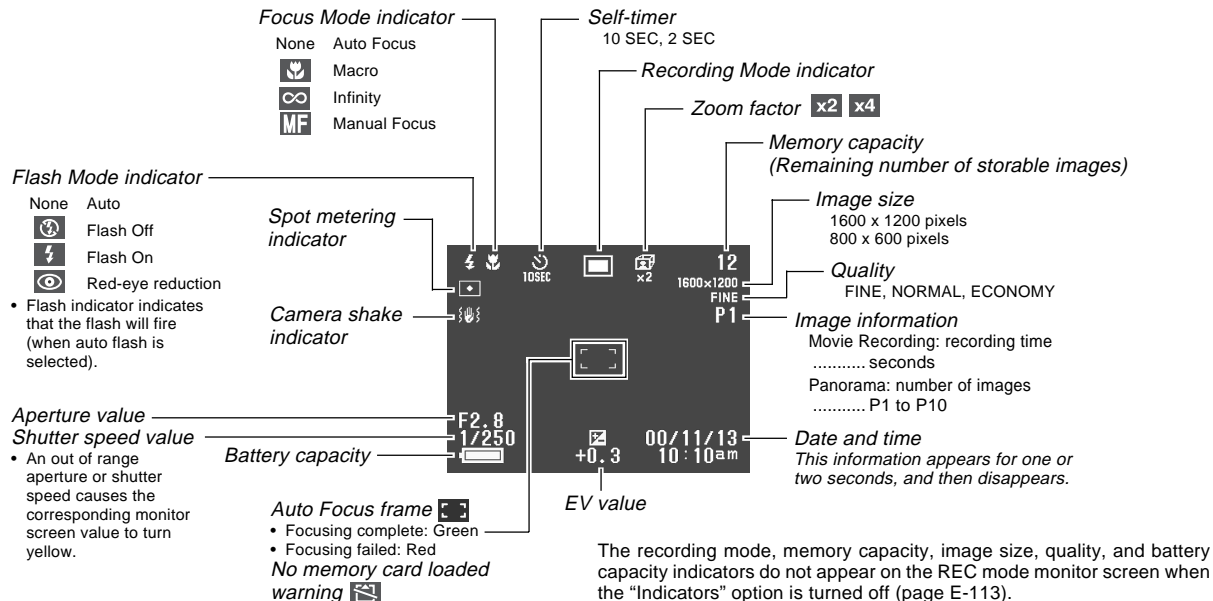

The recording mode, memory capacity, image size, quality, and battery capacity indicators do not appear on the REC mode monitor screen when the "Indicators" option is turned off (page E-113).



## ■ Screen when SHIFT INFO is pressed

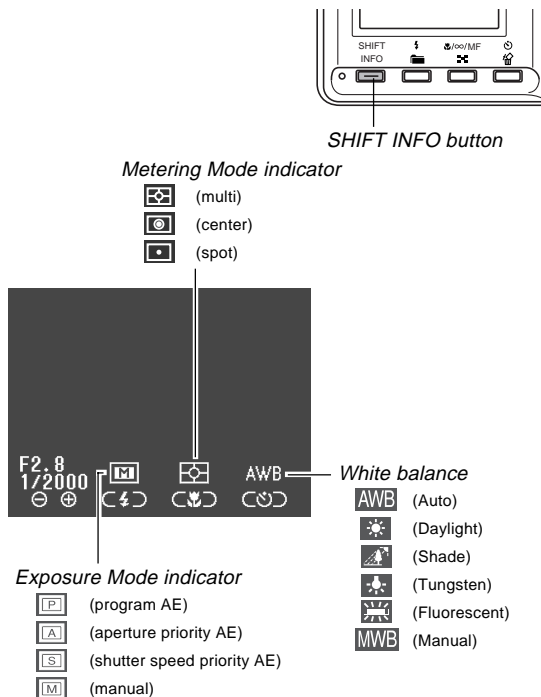

## PLAY mode

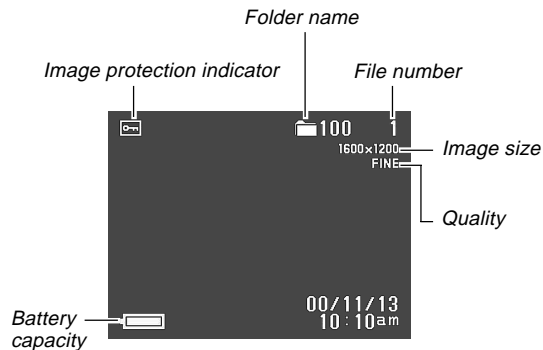

The above indicators do not appear on the PLAY mode monitor screen when the “Indicators” option is turned off (page E-113).

### ■ Screen when SHIFT INFO is pressed

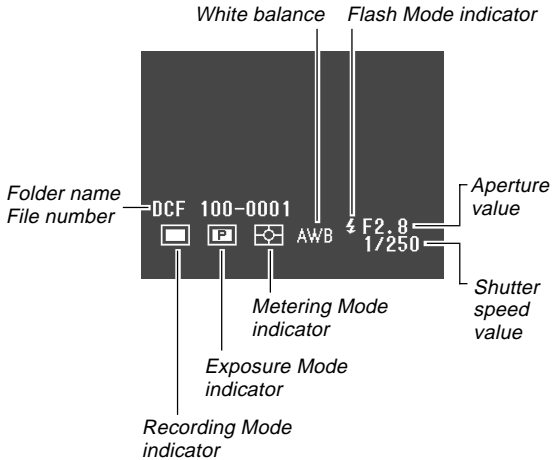

### IMPORTANT!

- The above indicators may not appear when viewing images recorded using a different digital camera model.

### Operation Indicator Lamp

The Operation lamp shows the operational status of the camera as described below.

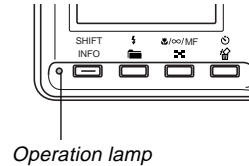

## REC mode

| Lamp Color | On  | Flashing                          |
|------------|---|-----------------------------------|
| Green      | Auto focus operation complete                           | Please Wait (after power on)      |
|            | Monitor screen turned off due to sleep state activation | Image store operation in progress |
|            |   | Movie store operation in progress |
|            |   | Self-timer countdown in progress  |
|            |   | Low battery                       |
|            |   | Format operation in progress      |
|            |   | Please Wait (after power off)     |
| Amber      | Exposure warning  | Flash is charging.                |
| Red        | Cannot focus  | Memory card error                 |
|            | Memory full   | Memory card is not formatted      |
|            | Data save error   | Cannot charge the flash           |

- The camera is ready to record when the lamp is off.

## PLAY mode

| Lamp Color                   | On | Flashing                               |
|------------------------------|----|--|
| Green                        | –  | Please Wait (after power on)           |
|                              |    | Delete operation in progress           |
|                              |    | Image protection operation in progress |
|                              |    | Making DPOF settings                   |
|                              |    | Low battery                            |
|                              |    | Format operation in progress           |
|                              |    | Please Wait (after power off)          |
|                              |    | Red                                    |
| Memory card is not formatted |    |  |
| No memory card in the camera |    |  |

## Using the Bundled Accessories

### Using the Lens Cap

Always keep the lens cap on the lens whenever you are not using the camera.

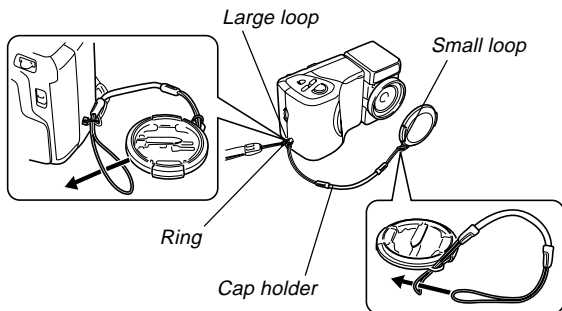

Attach the lens cap holder to the ring. This protects against accidental loss of the lens cap.

#### ■ QV-2300UX Users

- Be sure to turn off camera power and let the lens retract into the camera before attaching the lens cap.
- Never turn on camera power with the lens cap affixed to the lens.

### Attaching the Strap

Attach the strap as shown in the illustration below.

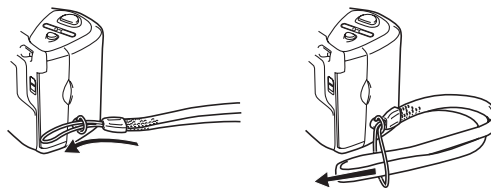

#### IMPORTANT!

- Be sure to keep the strap around your wrist when using the camera to protect against accidentally dropping it.
- The supplied strap is intended for use with this camera only. Do not use it for any other application.
- Never swing the camera around by the strap.

## Using the Soft Case

Keep the camera in its soft case to protect it when not in use.

### ■ QV-2300UX

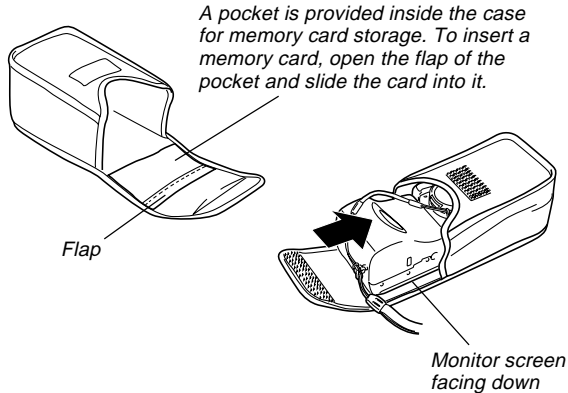

### IMPORTANT!

- Never put any other objects besides the camera into the soft case.

### ■ QV-2800UX

Attach the neck strap to the ring on the soft case as shown in the illustration.

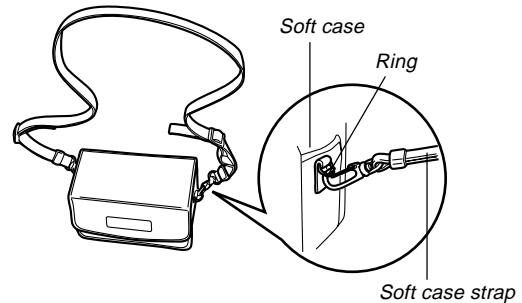

Use the buckle on the soft case strap to adjust the length of the soft case strap.

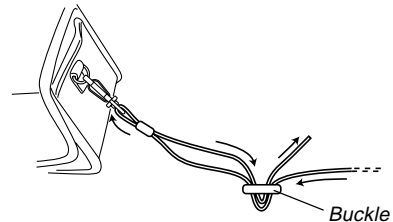

*A pocket is provided inside the case for memory card storage. To insert a memory card, open the flap of the pocket and slide the card into it.*

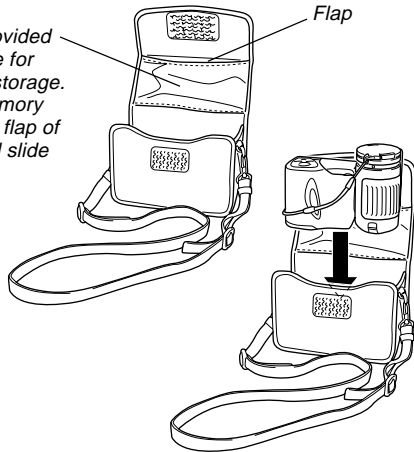

When inserting the camera into the soft case, make sure the lens is facing upwards and the monitor screen is facing in the direction shown in the illustration.

### IMPORTANT!

- Never put any other objects besides the camera into the soft case.
- The strap that comes with the camera is intended for use with the soft case only. Never use it for any other purpose.
- Never swing the camera around by the soft case strap.
- Handling the camera from your neck by the soft case strap creates the risk of damage to the camera by striking surrounding objects, and the risk of personal injury due to the camera being caught in a door, etc.
- Keep the soft case out of the reach of small children. The soft case strap can become wound around the neck and create the risk of personal injury.

## Power Requirements

Your camera features a two-way power supply that lets you use either AA-size batteries or household AC current. A set of AA-size alkaline batteries is supplied with the camera. The other items listed below are available separately.

### ■ Batteries

- Four AA-size alkaline batteries: LR6
- Four AA-size lithium batteries: FR6
- Four AA-size nickel metal hydride rechargeable batteries: NP-H3

### ■ Household Current

- AC Adaptor: AD-C620
- AC Adaptor/Charger: BC-3HA

## Loading Batteries

Make sure that camera power is turned off whenever loading or replacing batteries.

1. While holding down the release button on the battery compartment cover (on the bottom of the camera), slide the cover in the direction indicated by the arrow in the nearby illustration and open the cover.

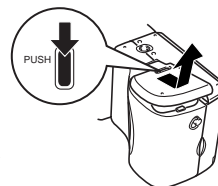

2. Load batteries with their  $\oplus/\ominus$  ends facing as shown in the nearby illustration.

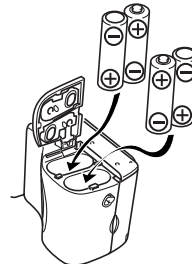

3. While holding down the release button, slide the battery compartment cover back to its original position to close it.



### IMPORTANT!

- Never use manganese batteries. Use only the battery types specifically mentioned in this User's Guide.

### ● Battery Life Guidelines

The battery life guideline values given below indicate the amount of time at standard temperature (25°C) until power automatically turns off due to battery failure. They do not guarantee that batteries will provide the amount of service indicated. Low temperatures and continued use reduce battery life.

| Type of Operation    | AA-size Alkaline Batteries LR6 | AA-size Lithium Batteries FR6 | AA-size Ni-MH Batteries NP-H3 |
|----------------------|--------------------------------|-------------------------------|-------------------------------|
| Continuous Playback  | 170 minutes                    | 300 minutes                   | 180 minutes                   |
| Continuous Recording | 80 minutes (480 shots)         | 200 minutes (1200 shots)      | 120 minutes (720 shots)       |

- The above figures are approximations only.
- The above guidelines are based on the following battery types:  
Alkaline: MX1500 (AA) DURACELL ULTRA  
Lithium: Energizer  
\* Battery life varies with brand.
- Figures are based on continuous recording under the following conditions.  
Flash turned off  
One zoom slider switching between T (Telephoto) and W (Wide-angle)

Recording one image per minute under the above conditions reduces battery life to about one sixth of that noted above. Battery life is greatly affected by how much you use flash, zoom and other functions, and how long you leave power turned on.

### ● Tips for Prolonging Battery Life

- Use the  button to turn off the flash when you are not using it.
- You can also use the power save settings (page E-36) to protect against wasting battery power when you forget to turn off the camera.

### ● Alkaline Battery Life

The actual life of alkaline batteries is affected by a variety of factors, including the battery manufacturer, the amount of time the batteries spend in storage before you use them, temperature while you are recording, and photographic conditions. As a rule, we recommend the use of lithium batteries or Ni-MH batteries, which have longer lives than alkaline batteries.



The following examples show how alkaline battery life changes under different conditions.

photographic conditions → shooting conditions

Example 1: Intermittent use of the camera shortens battery life.

Conditions

- Temperature: 25°C
- Repeat of a cycle of recording of one shot per minute for 10 minutes, followed by one minute of playback, and a nine minutes of power off (power on, full lens extension, half lens contraction, full lens extension, image recording, power off)
- Flash on

Approximate Battery Life: 50 minutes (46 shots)

Example 2: Low temperatures shorten battery life.

Conditions

- Temperature: 0°C
- Repeat of a cycle of recording of one shot per minute for 10 minutes, followed by one minute of playback, and a nine minutes of power off (power on, full lens extension, half lens contraction, full lens extension, image recording, power off)
- Flash on

Approximate Battery Life: 12 minutes (11 shots)

### ● About rechargeable batteries

Use only the nickel-metal hydride batteries (NP-H3) that are available from your dealer as options for this camera. Proper camera operation is not guaranteed when other rechargeable batteries are used.

AC Adaptor/Charger : BC-3HA

Nickel-metal hydride batteries (4-battery set)/Quick Charger Set : BC-1HB4

Nickel-metal hydride batteries (4-battery set) : NP-H3P4

### IMPORTANT!

- Be sure to keep all four batteries together as a set at all times, for both charging and powering the camera. Mixing batteries from different sets can shorten overall battery life and cause malfunction of the camera.
- Rechargeable batteries cannot be charged while they are loaded in the camera.

## Battery Handling Precautions

Incorrect use or handling of batteries can cause them to leak or burst and create the danger of serious damage to your camera. Be sure to note the following important precautions to avoid problems with batteries.









CAUTION

- Use only LR6 (AM-3) type alkaline or FR6 type lithium or Ni-MH (nickel-metal hydride) dry cell batteries with this camera. Never mix old batteries with new ones. Doing so can result in bursting or leaking of batteries, creating the danger of fire or personal injury.
- Always make sure that the plus (+) and minus (-) ends of the batteries are facing correctly, as noted by the markings on the camera itself. Improper loading of batteries can result in bursting or leaking of batteries, creating the danger of personal injury or soiling of objects nearby.
- Remove batteries from the camera if you do not plan to use it for more than two weeks.
- Never recharge batteries, never allow direct connection between two ends of a battery, and never try to take batteries apart.
- Do not expose batteries to direct heat or dispose of them by burning. Doing so can create the danger of explosion.
- Never mix batteries of different types.

- Dead batteries are susceptible to leakage, which can cause serious damage to your camera. Remove batteries from the camera as soon as you notice they are dead.
- The batteries that power the camera normally become warm as they discharge.

## Low Battery Indicator

The following shows how the battery capacity indicator on the monitor screen and the indicator display changes as battery power is used. Replace all four batteries as soon as possible after they go dead. If you continue to use the camera while the battery level is  or , camera power will automatically turn off.

|                  |  |
|------------------|--|
| Battery Capacity | High ←————→ Low  |
| Monitor Screen   |  →  →  →  |

## Using AC Power

Use the adaptor as shown below to power the camera from a household power outlet.

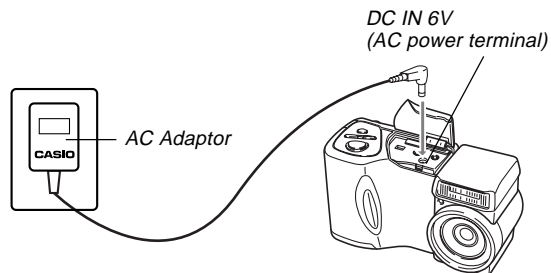

- AC Adaptor: AD-C620 (Option)
- AC Adaptor/Charger: BC-3HA (Option)  
The BC-3HA functions both as an AC adaptor and as a charger unit for AA-size nickel metal hydride batteries. It comes complete with four rechargeable nickel metal hydride batteries. This AC adaptor/charger unit can be used with any household power outlet rated for 100V to 240V AC.



## AC Adaptor precautions

- Never use an electrical outlet whose voltage is outside the rating marked on the AC adaptor. Doing so can create the danger of fire or electrical shock. Use only the optional AC adaptor specified for this camera.
- Do not allow the AC adaptor power cord to become cut or damaged, do not place heavy objects on it, and keep it away from heat. A damaged power cord creates the risk of fire and electrical shock.
- Never try to modify the AC adaptor power cord, or subject it to severe bending, twisting, or pulling. Doing so creates the risk of fire and electrical shock.
- Never touch the AC adaptor while your hands are wet. Doing so creates the risk of electrical shock.
- Do not overload extension cords or wall outlets. Doing so creates the danger of fire and electrical shock.
- Should the cord of the AC adaptor become damaged (exposed internal wiring), request a replacement from an authorized CASIO service provider. A damaged AC adaptor cord creates the danger of fire or electrical shock.

- Be sure to turn off power before connecting or disconnecting the adaptor.
- Always turn camera power off before disconnecting the AC adaptor, even if the camera has batteries installed. If you don't, the camera will turn off automatically when you disconnect the AC adaptor. You also run the risk of damaging the camera whenever you disconnect the AC adaptor without first turning power off.
- The AC adaptor may become warm to the touch after extended periods of use. This is normal and is not cause for alarm.
- After using the camera, turn it off and unplug the adaptor from the AC outlet.
- The camera automatically switches over to AC adaptor powered operation whenever the AC adaptor is plugged into the camera.
- Always use the AC adaptor to power the camera whenever it is connected to a computer.

## Turning the Camera On and Off

Sliding the POWER ON/OFF switch to the right toggles camera power on and off.

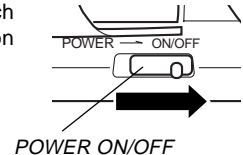

## Power Save Settings

The settings described below let you specify sleep and auto power off trigger times that help to conserve valuable battery power.

### AUTO POWER OFF

Auto Power Off turns off camera power if no operation is performed for five minutes in the PLAY mode. In the REC mode, you can specify an Auto Power Off trigger time of two or five minutes.

### SLEEP

The monitor screen enters a sleep state if no operation is performed for a specified amount of time in the REC mode. Pressing any button immediately wakes up the monitor and restores normal operation. You can specify 30 seconds, 1 minute, or 2 minutes before the sleep state is triggered, or you can turn off this setting entirely.

## To power save settings

1. Turn on the camera and slide the REC/PLAY selector to "REC".
2. Press MENU.
3. Use [+] (down) and [-] (up) to select "FUNCTION", and then press the shutter release button.
4. Use [+] (down) and [-] (up) to select the item whose settings you want to change, and then press the shutter release button.
  - To make auto power off settings, select "Auto Power Off".
  - To make sleep settings, select: "Sleep".
5. On the screen that appears, use [+] and [-] to make the setting you want, and then press the shutter release button.

Auto power off settings: "2 min" "5 min"

Sleep settings: "Off" "30 sec" "1 min" "2 min"

- In the PLAY mode, Auto Power Off trigger time is fixed at five minutes.
- Sleep is disabled in the PLAY mode.
- Performing any button operation while the monitor is asleep immediately wakes it up and restores normal operation.
- The Auto Power Off setting is given priority if you have "2 min" set for both Sleep and Auto Power Off. This means that the camera turns off if you do not perform any operation for about two minutes in the REC mode.
- Auto Power Off is automatically disabled when under any one of the following conditions.
  - While a slideshow is playing
  - When you are performing operations on a computer, printer, or other external device connected to the camera's DIGITAL terminal or USB port.
  - While the AC adaptor is connected to the camera

## Memory Cards

This camera uses a memory card (CompactFlash <CF TYPE I/II> card or microdrive) for image storage.

### IMPORTANT!

- Make sure that the power of the camera is turned off before you insert or remove a memory card.
- When inserting a memory card into the camera, make sure that the card is oriented correctly. Make sure that the correct side of the card is facing up, and that you insert the correct end of the card into the camera.

## Inserting a Memory Card into the Camera

1. Open the memory card slot cover.

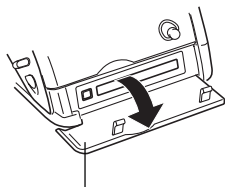

Memory card slot cover

2. As shown in the illustration, slide the memory card into the slot and push it in as far as it will go.

- If the Eject button is extended, press it in before sliding the memory card into the slot.

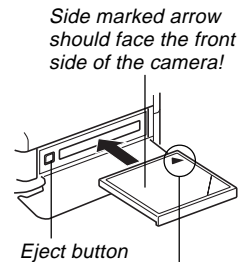

Side marked arrow should face the front side of the camera!

Eject button

Side marked with arrow

3. Close the memory card slot cover.

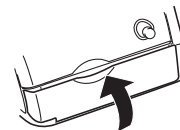

## Removing a Memory Card from the Camera

1. Open the memory card slot cover.

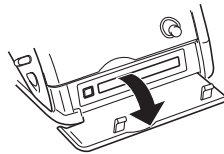

2. Press the eject button so it extends from the camera.

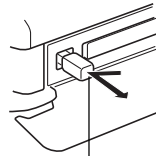

*Eject button*

3. Press the eject button once again to eject the card.

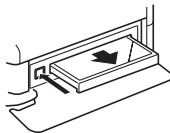

4. Remove the memory card.

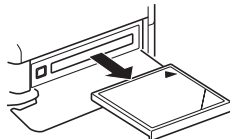

5. Close the memory card slot cover.

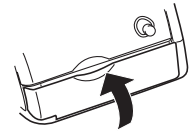

### IMPORTANT!

- Insert only memory cards into the memory card slot. Inserting any other type of card can cause malfunction.
- Should water or any other foreign matter get into the memory card slot, immediately turn off power, unplug the AC adaptor, and contact your original retailer or nearest CASIO Service Provider.
- Never eject the CompactFlash card while the card slot is facing downwards. Doing so creates the danger of the CompactFlash card falling, which can corrupt image data on the card.
- Never remove the memory card from the camera while the operation lamp or card access lamp is flashing. Doing so can cause loss of recorded images or corruption of memory card data.

## Formatting a Memory Card

You can format a memory card to delete all of the data stored on it.

### IMPORTANT!

- Formatting a memory card deletes all images on the card, even if some or all of the images are protected (page E-107).
- Data deleted by a memory card format operation cannot be recovered! Be sure to carefully check and confirm that you no longer need the data stored in a memory card before formatting it.

1. Turn on the camera, and then use the REC/PLAY selector to select either “REC” or “PLAY”.
2. Select “Format” using one of the following two key operations, and then press the shutter release button.

| If you are here | Select this on the menu screen   |
|-----------------|----------------------------------|
| REC mode        | “FUNCTION” → “SET UP” → “Format” |
| PLAY mode       | “SET UP” → “Format”              |

- Use [+] and [-] to select each menu item, and press the shutter release button to advance to the next menu.

3. In response to the confirmation message that appears, use [+] and [-] to select “Yes” to format or “No” to exit, and then press the shutter release button.



## Memory Card Precautions

- Images cannot be recorded with this camera unless a memory card is installed in it.
- Be sure to use only CASIO brand CompactFlash cards. Proper operation with other memory cards is not guaranteed.
- Static electricity, electrical noise, and other electrical phenomena can cause corruption or even total loss of the data stored on a memory card. Because of this, you should always make backup copies of important images on other media (magnetic optical disk, floppy diskette, computer hard disk, etc.).
- Memory card problems can be corrected by reformatting the memory card. Reformatting a memory card deletes all images stored on the card, but you can use a computer to copy the images you want to keep to the computer's hard disk before reformatting your card. If you plan to be recording images where you do not have access to a computer, it is a good idea to take along an extra memory card or two just in case you experience an unexpected memory card problem.

- Formatting is recommended for any memory card that you suspect contains corrupted image data (due to a DECODE ERROR, strange image colors, malformed images) or newly purchased memory cards.
- Before starting a format operation, load a full set of new batteries (alkaline or lithium) into the camera or connect the AC adaptor to power the camera. Interruption of camera power during the format operation results in improper formatting, making it impossible to use the memory card.

## IBM Microdrive Precautions

Compatibility of the camera with the IBM microdrive has been confirmed by CASIO. However, you should note the following important points whenever using the IBM microdrive.

- Be sure to carefully read all of the documentation that comes with the microdrive before using it.
- Note that the microdrive becomes hot during normal use. Take care when removing it from the camera.
- Take care to avoid strong pressure on the label side of the microdrive when it is removed from the camera. Strong pressure can damage internal components and cause malfunction.

- Never turn off camera power or subject the camera to impact while the card access lamp is flashing. Doing so can cause malfunction of the microdrive.
- The microdrive is a very high precision device. Dropping the camera can result in malfunction of the microdrive, even though the camera is undamaged. Take extra care when handling the camera while the microdrive is installed.
- The microdrive has very large storage capacity. Because of this, certain operations can take a relatively long time to perform.
- The microdrive may not operate properly in areas where barometric pressure is low. Because of this, you should avoid using it at high altitudes.
- A microdrive consumes much more electrical power than a CompactFlash card. Depending on how a microdrive is used, it can greatly reduce battery life. When using alkaline batteries, certain operating conditions and certain battery brands can result in batteries going dead right after you install new ones. Whenever using a microdrive, we recommend that you use rechargeable nickel metal hydride batteries or lithium batteries to power the camera.
- When battery power is low, the amount of time required between shots may become longer. This longer interval is designed to protect the microdrive.

### **In case of microdrive malfunction....**

- Contact your original microdrive retailer or the contact point noted in the microdrive documentation.
- CASIO does not provide any servicing or maintenance support for the microdrive.
- Note that CASIO assume no responsibility for any data loss you may suffer while using the microdrive.
- This camera supports use of both a CompactFlash card and the microdrive. Note, however, that ejecting a microdrive from the camera is relatively more difficult than ejecting a CompactFlash card.

## Menu Screens

Pressing MENU displays the menu screen. The contents of the menu screen depend on whether you are in the PLAY mode or REC mode. The following procedure shows operation in the REC mode as an example.

1. Slide the **POWER ON/OFF** switch to the right to turn on the camera.
2. Slide the **REC/PLAY** selector to “REC”.
  - To perform a menu operation in the PLAY mode, slide the REC/PLAY selector to “PLAY”.
3. Press **MENU**.
4. Use **[+]** and **[-]** to select the item you want, and then press the shutter release button.
  - Make setting in accordance with the guidance messages that appear on the monitor screen.

[+] [-]: Item selection, page scrolling  
 Shutter release button: Applies displayed setting  
 MENU: Returns to previous screen

## Example Displays

REC mode, page 1

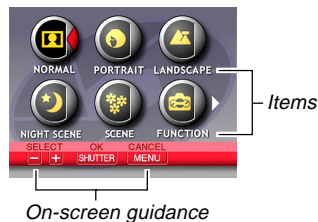

REC mode FUNCTION menu, page 2

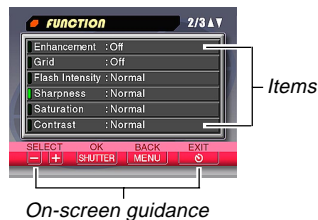

- Pressing the button is sometimes required to exit certain setting screens.
- See the “Camera Menus” on page E-136 for more information about menu contents.

## Setting the Current Date and Time

Use the following procedures to set the current date and time, and to select the date format.

When you record an image, the time and date the image was shot is registered in accordance with data from the camera's built-in clock. You can even use the time stamp function to "stamp" the date and time inside the image.

### IMPORTANT!

- The time and date settings are cleared if the camera is left for about 24 hours without battery and AC power being supplied. If this happens, restore power and make new time and date settings before using the camera again.
- A flashing time display indicates that the time and date (clock) settings have been cleared. Use the procedure on this page to make the correct time and date settings.
- If you do not set the camera's built-in clock to the current date and time, all images are recorded with the default date and time, which probably is not your correct current date and time. Be sure to correctly set the clock before you use the camera.

## Setting the Date and Time

1. Turn on the camera, and then use the REC/PLAY selector to select either "REC" or "PLAY".
2. Press MENU.
3. Select "Date/Time" using one of the following two key operations, and then press the shutter release button.

| If you are here | Select this on the menu screen      |
|-----------------|-------------------------------------|
| REC mode        | "FUNCTION" → "SET UP" → "Date/Time" |
| PLAY mode       | "SET UP" → "Date/Time"              |

- Use [+] and [-] to select each menu item, and press the shutter release button to advance to the next menu.

4. Select and change the digits on the screen to set the current date and time.

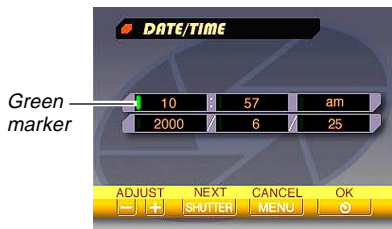

Shutter release button: Moves the green marker.  
 [+] / [-]: Increases and decreases the currently selected digit.

5. Press to apply your settings.

## Selecting the Date Format

You can use the following procedure to select one of the three different date formats.

1. Turn on the camera, and then use the REC/PLAY selector to select either “REC” or “PLAY”.
2. Press MENU.
3. Select “Date Style” using one of the following two key operations, and then press the shutter release button.

| If you are here | Select this on the menu screen       |
|-----------------|--------------------------------------|
| REC mode        | “FUNCTION” → “SET UP” → “Date Style” |
| PLAY mode       | “SET UP” → “Date Style”              |

- Use [+] and [-] to select each menu item, and press the shutter release button to advance to the next menu.

4. Use [+] and [-] to select the setting you want to use, and then press the shutter release button to apply it.

Example: October 18, 2000

Year/Month/Day: 00/10/18

Day/Month/Year: 18/10/00

Month/Day/Year: 10/18/00

## Time Stamp

When it is turned on, the time stamp function digitally stamps the recording date and time in the lower right corner of each image as it is recorded. Note that once an image is stamped, the date and time cannot be deleted.

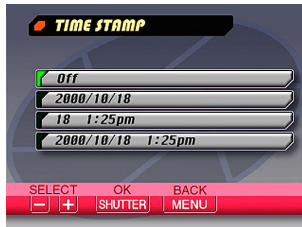

1. Turn on the camera and then slide the REC/PLAY selector to “REC”.
2. Press MENU.
3. Select “FUNCTION” → “Time Stamp”, and then press the shutter release button.
4. Use [+] and [-] to select the setting you want, and then press the shutter release button to apply it.

Example:

Date: October 18, 2000

Time: 1:25pm

Off : No time stamping

2000/10/18 : Year/Month/Day

18 1:25pm : Day Hour:Minutes

2000/10/18 1:25pm : Year/Month/Day Hour:Minutes

# BASIC IMAGE RECORDING

This section describes the basic procedure for recording an image.

## Recording a Simple Snapshot

The camera's Program AE Mode (P Mode) is for simple snapshots. In this mode, the camera automatically sets the shutter speed and aperture for you in accordance with subject brightness.

1. Before turning on the camera, remove its lens cap.

2. Slide the POWER ON/OFF switch to the right to turn on the camera.

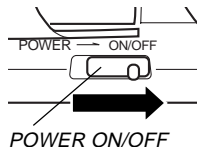

3. Slide the REC/PLAY selector to "REC".

REC : REC mode for recording images  
PLAY : PLAY mode for playing back images

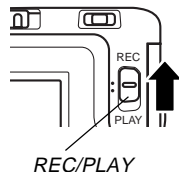

4. Compose the image on the monitor screen so the point on which you want to focus is inside the Focus frame.

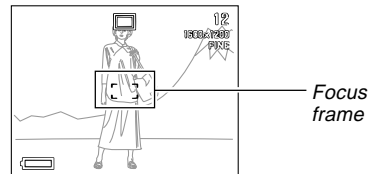

5. Press the shutter release button about half way and hold it there to perform auto focus.

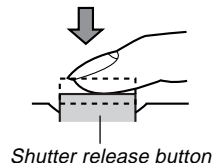

- You can find out the status of the Auto Focus operation by checking the color of the focus frame and the status of the operation lamp.

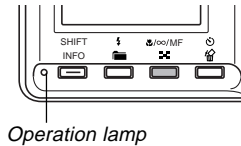

| If you see this                            | It means this              |
|--|----------------------------|
| Green focus frame and green operation lamp | The image is in focus.     |
| Red focus frame and red operation lamp     | The image is not in focus. |

- Take care that you do not block the lens or the sensors with your fingers as you hold the camera.

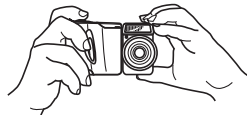

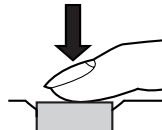

- 6. After confirming that the image is in focus, press the shutter release button all the way down to record the image.**



- Recorded images are temporarily stored in a buffer, from which they are stored to the memory card installed in the camera. You can continue to store images as long as there is space available in the buffer.
- The number of images you can store in the camera depends on the storage medium and the image quality setting (page E-59) you are using.
- To avoid hand movement, press the shutter release button gently.
- Use of a tripod is recommended for slow shutter speeds and telephoto shots to avoid blurring of the image due to camera movement.

### ■ Camera Shake Indicator

The  (camera shake indicator) appears on the monitor screen when the zoom slider is set to T (telephoto) or when a slow shutter speed is being used.

- If the camera shake indicator  appears, use a tripod and the wired remote controller to avoid camera movement.



## About the REC Mode Monitor Screen

- The image shown on the monitor screen in the REC mode is a simplified image for composing purposes. The actual image is recorded in accordance with the image quality setting currently selected on your camera. The image recorded on the memory card has much better resolution and detail than the REC mode monitor screen image.
- Certain levels of subject brightness can cause the response of the REC mode monitor screen to slow down, which causes some static noise in the monitor screen image.

## About Auto Focus

Auto Focus tends not to work well with the following types of subjects. If you experience problems with obtaining good results with Auto Focus, try using manual focus (page E-57).

- Solid color walls or objects with little contrast
  - Strongly backlit objects
  - Polished metal or other brightly reflective objects
  - Venetian blinds or other horizontally repeating patterns
  - Multiple images that are varying distances from the camera
  - Subjects in poorly lit areas
- Auto Focus also may not work properly when the camera is unsteady or shaking.







## ■ Fixed Focusing Distances



- The following are the fixed focusing distances when Auto Focus is unable to focus properly.
  - Well-lit Location: 1.5 meters minimum
  - With Flash : Approximately 2 meters
- Depending on actual conditions, a green operation indicator and focus frame do not necessarily guarantee that the image is in focus.

## Recording Precautions

- Never open the battery compartment cover, disconnect the AC adaptor from the camera, or unplug the adaptor from the wall socket while the operation lamp and the card access lamp are flashing green. Doing so will not only make storage of the current image impossible, it can also corrupt other image data already stored on the camera's memory card.
- Never remove batteries, unplug the AC adapter, or remove the memory card while the camera is saving images.
- Fluorescent lighting actually flickers at a frequency that cannot be detected by the human eye. When using the camera indoors under such lighting, you may experience some brightness or color problems with recorded images.

## Image Recording when the Battery is Low

To protect against unexpected loss of image data, images are recorded one-by-one whenever the battery level is indicated as  or lower. The message “Press  to cancel save.” appears on the monitor screen during the save operation under this condition. As long as you do not press  , the save operation continues and takes a few seconds to complete. Be sure to replace all four batteries as soon as possible after this message starts to appear. Pressing   while the “Press  to cancel save.” is on the monitor screen cancels the image save operation.

- If you have a microdrive loaded in the camera, the above message appears whenever the battery level is indicated as  or lower.
- The message “Press  to cancel save.” also appears momentarily during save operations in the Panorama Mode and Movie Mode. In this case, this message does not indicate that battery power is low.

## Using Zoom

Your camera is equipped with both optical zoom and digital zoom capabilities.

### Using Optical Zoom

Optical zoom enlarges the image by changing the focal distance of the lens. The optical zoom range depends on your camera model.

- QV-2300UX: 1X to 3X
- QV-2800UX: 1X to 8X

1. Enter the REC mode.
2. Move the zoom slider towards T (telephoto) to zoom in on the subject, or W (wide-angle) to zoom out.

T (TELE): Telephoto  
W (WIDE): Wide-angle

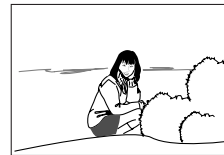
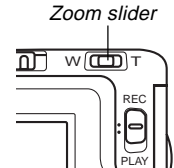

W (WIDE)



T (TELE)

**NOTES**

- Changing the optical zoom factor also affects the lens aperture value.
- The lens aperture value indicated on the camera is the aperture when optical zoom is 1X. Using a higher optical zoom setting results in a higher aperture value (smaller aperture).
- Use of a tripod is recommended for telephoto shots to avoid blurring of the image due to camera movement.

**Using Digital Zoom**

With digital zoom, you can enlarge the image on the monitor screen by zoom factors of 2X or 4X before storing it.

- 1. Enter the REC mode.**
- 2. Press MENU.**
- 3. Select “FUNCTION” → “Digital Zoom”, and then press the shutter release button.**



- 4. Select the setting you want, and then press the shutter release button to apply it.**

| To do this   | Select this |
|--|-------------|
| Turn off digital zoom  | Off         |
| Toggle between 2X and 4X digital zoom whenever the zoom slider is slid to the maximum T (telephoto) setting. | Auto        |
| Always use 2X digital zoom   | X2          |
| Always use 4X digital zoom   | X4          |



- A frame appears on the monitor screen whenever 4X digital zoom is in use. Only the area of the image within the frame is recorded, with the resulting image measuring 800 x 600 pixels.
- 4X digital zoom is not available in the Movie Mode and Panorama Mode.
- 2X and 4X digital zoom are disabled while the composition outline is displayed in the Scene Mode.

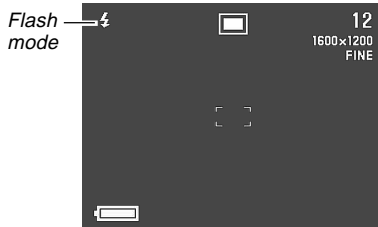
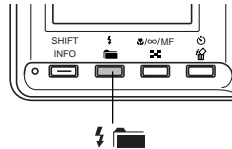

## Using the Flash

The following describes various flash settings you can make to suit the type of image you are trying to record.

1. Enter the REC mode.
2. Press   to cycle through the available flash modes until the indicator for the one you want is on the monitor screen.



- Each press of   cycles through the available flash modes described below.

| To do this   | Select this setting   |
|--|---|
| Have the flash fire automatically when required (Auto Flash)   | No display  |
| Turn off the flash (Flash Off)   |  |
| Always fire the flash (Flash On)   |  |
| Fire a pre-flash followed by image recording with flash, reducing the chance of red-eye in the image (Red-eye Reduction) |  |

## Flash Status Indicators

You can check the current flash unit status by checking the monitor screen indicator and operation lamp while the shutter release button is pressed about half way down.

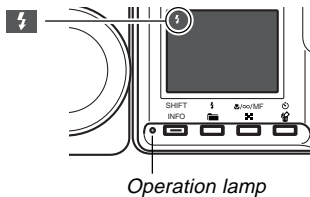

### ■ Operation lamp

| If the operation lamp is doing this | It means this                                |
|-------------------------------------|--|
| Flashing amber                      | Flash unit is charging                       |
| Flashing red                        | Flash unit cannot be charged for some reason |

### ■ Monitor screen

When you have Auto Flash or Red-Eye Reduction selected as the flash mode, the indicator  appears on the display when you press the shutter release button about half way down to indicate that available light is insufficient and the flash will be fired.

## Adjusting the Flash Intensity

Use the following procedure to adjust the intensity of the flash when it fires.

1. Enter the REC mode.
2. Press MENU.
3. Select “FUNCTION” → “Flash Intensity”, and then press the shutter release button.
4. Select the setting you want, and then press the shutter release button to apply it.



| To do this                           | Select this setting |
|--------------------------------------|---------------------|
| Fire the flash with strong intensity | Strong              |
| Fire the flash with normal intensity | Normal              |
| Fire the flash with weak intensity   | Weak                |

## Precautions when Using Flash

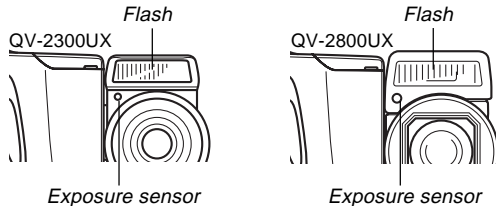
- Make sure that you do not touch or block the flash or the exposure sensor with your fingers. Doing so can soil these components and interfere with correct flash operation.



- The effective range for the built-in flash depends on your camera model.
  - \* QV-2300UX: Approximately 0.5m to 2m (at full aperture)
  - \* QV-2800UX: Approximately 0.5 to 2.5m (at full aperture)
 Note that you may not be able to obtain the desired flash result outside the ranges noted above.
- Depending on operating conditions (type of batteries being used, temperature, etc. ), it may take up to 10 seconds for the flash unit to charge.
- The flash is disabled during movie recording, which is indicated by the  (Flash Off) icon on the monitor screen.

- The flash unit does not charge when battery power is too low to charge the flash. The  (Flash Off) indicator appears to warn you that the flash will not fire correctly, which may affect exposure of the image. Replace batteries as soon as possible when this happens.
- Red-eye reduction  may not work well when the camera is not pointed directly at the subject or when the subject is far from the camera.
- In the Red-eye Reduction Mode , the flash is fired automatically in accordance with exposure. Because of this, the flash does not fire if the subject is well-lit.
- White balance is fixed while the flash is being used, so sunlight, fluorescent lighting, or other sources of illumination in the immediate area may affect the coloring of the recorded image.

## Selecting the Focus Mode

You can use the following procedure to select from among four different focus modes: Auto Focus, Macro, Infinity, and Manual Focus.

1. Enter the REC mode.
2. Press /∞/MF to cycle through the available focus mode settings.

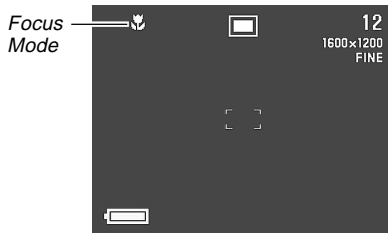
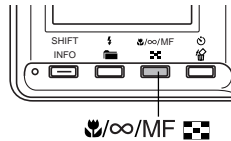

Each press of /∞/MF cycles through the focus modes in the following sequence.

Auto Focus (no indicator) → Macro () → Infinity () → Manual Focus ()

## Using the Auto Focus Mode

As its name suggests, the Auto Focus Mode adjusts focus automatically whenever you press the shutter release button about half way down. The following shows the relationship between optical zoom factor and the focusing distance for Auto Focus.

|           | Optical Zoom Factor | Focusing Distance |
|-----------|---------------------|-------------------|
| QV-2300UX | 1X                  | 10cm to ∞         |
|           | 3X                  | 50cm to ∞         |
| QV-2800UX | 1X                  | 40cm to ∞         |
|           | 8X                  | 1m to ∞           |

1. Press /∞/MF to cycle through the focus mode settings until there is no focus mode indicator on the display. This indicates the Auto Focus Mode.
2. Compose the image to the object you want within the focus frame, and then press and hold the shutter release button about half way down.

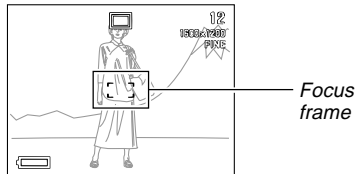

- You can find out the status of the Auto Focus operation by checking the color of the focus frame and the status of the operation lamp.

| If you see this                            | It means this                               |
|--|---|
| Green focus frame and green operation lamp | The image is in focus.                      |
| Red focus frame and red operation lamp     | Auto Focus is not possible for some reason. |

- Press the shutter release button the rest of the way down to record the image.

## Using the Macro Mode

The Macro Mode automatically sets the focus for close-up shooting. Focus adjustment starts automatically whenever you press the shutter release button about half way down. The following shows the relationship between optical zoom factor and the focusing distance for the Macro Mode.

|           | Optical Zoom Factor | Focusing Distance |
|-----------|---------------------|-------------------|
| QV-2300UX | 1X                  | 1cm to 50cm       |
| QV-2800UX | 1 to 1.6X           | 1cm to 50cm       |

- Press /  $\infty$  / MF to cycle through the focus mode settings until the indicator appears on the display. This indicates the Macro Mode.

- Compose the image and record it.

- See “Using the Auto Focus Mode” on page E-55 for information about how the camera focuses an image automatically.
- You can check the current status by looking at the operation lamp and focus frame. See “Using the Auto Focus Mode” on page E-55 for more information.

### IMPORTANT!

- The focusing range is the distance from the lens surface to the subject.
- Optical zoom is disabled in the Macro Mode.



## Using the Infinity Mode

The Infinity Mode sets the focus near infinity. It is a good choice for scenery and other far-off subjects. Focus adjustment starts automatically whenever you press the shutter release button about half way down.

1. Press  $\infty$ /MF  $\square$  to cycle through the focus mode settings until the  $\infty$  indicator appears on the display. This indicates the Infinity Mode.
2. Compose the image and record it.
  - See “Using the Auto Focus Mode” on page E-55 for information about how the camera focuses an image automatically.
  - You can check the current status by looking at the operation lamp and focus frame. See “Using the Auto Focus Mode” on page E-55 for more information.



## Using the Manual Focus Mode

With Manual Focus, you make the required focus settings by hand. The following shows the relationship between optical zoom factor and the focusing distance for the Manual Focus Mode.

|           | Optical Zoom Factor | Focusing Distance |
|-----------|---------------------|-------------------|
| QV-2300UX | 1X                  | 1cm to $\infty$   |
|           | 3X                  | 50cm to $\infty$  |
| QV-2800UX | 1X                  | 1cm to $\infty$   |
|           | 8X                  | 1m to $\infty$    |

1. Press  $\infty$ /MF  $\square$  to cycle through the focus mode settings until the MF indicator appears flashing on the display. This indicates the Manual Focus Mode.
2. While the MF indicator is flashing, use [+] and [-] to focus the image.
  - If you do not perform any focus operation for about two seconds, the MF indicator stops flashing.
  - You can press  $\infty$ /MF  $\square$  while the MF indicator is on the monitor screen to change to another focus mode, if you want.



### 3. Press the shutter release button to stop the MF indicator flashing and fix the image focus at its current level.

- After MF stops flashing, you can use [+] and [-] to adjust exposure compensation (EV).
- If MF stops flashing before you have a chance to focus, press /∞/MF  to make it flash again.

### 4. Press the shutter release button to record the image.

- The focus frame does not appear when you press the shutter release button half way down while in the Manual Focus Mode.

## Using Focus Lock

Normally, Auto Focus automatically focuses on the object that is inside the focus frame. Focus lock is a technique you can use in the Auto Focus, Macro() and Infinity () modes that lets you lock the focus on a subject and then move the camera so the focus frame is pointed at another subject when you record. This keeps the original subject in focus, even though a different object is within the focus frame.

### 1. Align the focus frame with the subject you want to lock on and press the shutter release button half way down.

- The focus frame turns green when the image is in focus.

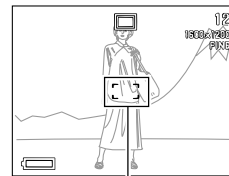

Focus frame

- While keeping the shutter release button depressed half way, move the camera and compose the image as you want.

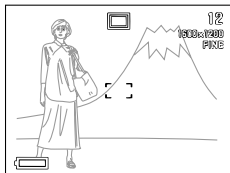

- Press the shutter release button the rest of the way down to record the image.

**NOTE**

- Locking the focus also locks the exposure setting.

## Specifying Image Size and Quality

You can specify the image size and image quality to suit the type of image you are recording.

- Enter the REC mode.
- Press MENU.
- Select “FUNCTION” → “Size/Quality”, and then press the shutter release button.
- Select the size and quality setting you want, and then press the shutter release button.

### ■ Size/Quality Setting and Image Capacity



| Image size (pixels) | Quality | File size | Number of images |                  |                  |
|---------------------|---------|-----------|------------------|------------------|------------------|
|                     |         |           | 8MB memory card  | 64MB memory card | 340MB Microdrive |
| 1600 x              | FINE    | 850KB     | 8                | 71               | 401              |
|                     | NORMAL  | 600KB     | 11               | 99               | 562              |
| 1200 x              | ECONOMY | 350KB     | 19               | 167              | 943              |
| 800 x               | FINE    | 200KB     | 33               | 282              | 1587             |
|                     | NORMAL  | 150KB     | 43               | 365              | 2054             |
| 600 x               | ECONOMY | 120KB     | 53               | 443              | 2494             |

**IMPORTANT!**

- The values in the table below are all approximate, and are affected by the types of images you record and other factors.
- To determine the number of images that can be stored on a memory card of a different capacity, multiply the capacities in the table below, by the appropriate value.
- Note that the maximum number of images that can be stored in a single folder is 250. Because of this, even if you are using a card that allows storage of more than 250 images, the camera's monitor screen will show its capacity for up to 250 images only.
- The number of images that can be recorded may differ from the values shown above when you use Card Browser (page E-130).



**Using the Self-timer**

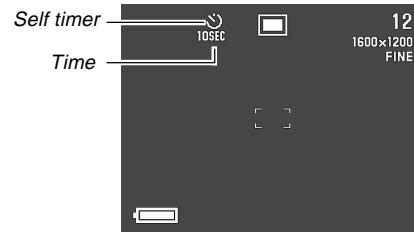
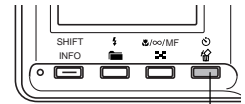

You can set the self-timer to either one of two starting times.

1. Enter the REC mode.
2. Press the   button to select the self-timer time you want.



Self-timer Time Settings:

Each press of   cycles through the available self-timer settings described below.

| To do this   | Select this setting   |
|--|---|
| Turn the self-timer off  | No display  |
| Record 10 seconds after the shutter release button is pressed  |  |
| Record two seconds after the shutter release button is pressed |  |

### 3. Press the shutter release button to start the self-timer countdown.

- The seconds are counted down on the monitor screen.
- To stop a countdown part way through, press the shutter release button.

#### NOTE

- You can rotate the lens mechanism so the lens points in the same direction as the camera's monitor screen. This makes it possible for you to watch the self-timer countdown on the monitor screen.

## Exposure Compensation

Whenever program AE, shutter speed priority AE, or aperture priority AE is selected as the exposure mode, you can adjust the exposure compensation value (EV value) within the range shown below in order to compensate for current lighting conditions. This setting can be used to obtain better results when shooting with backlighting, indirect indoor lighting, a dark background, etc.

EV Value Range:  $-2EV$  to  $+2EV$

Steps:  $1/3EV$

1. Select program AE, shutter speed priority AE, or aperture priority AE as the exposure mode. See page E-74.
2. Use **[+]** and **[-]** to change the exposure compensation value (EV shift).

- The current EV value is shown on the monitor screen.

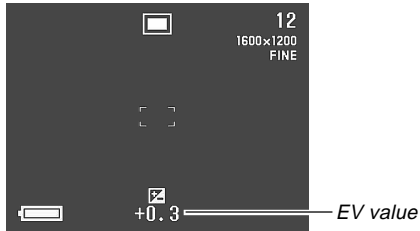

[+]: Increases the EV value. A higher EV value is best for light colored subjects and backlit subjects.

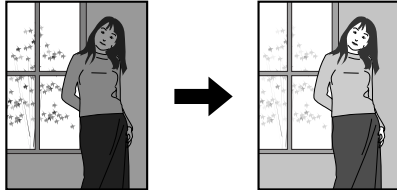

[-]: Decreases the EV value. A lower EV value is best for dark color subjects and for shooting outdoors on a clear day.

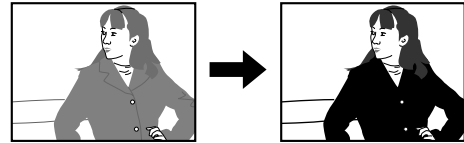

3. After the EV value is the way you want, press the shutter release button to record the image.

**IMPORTANT!**

- When shooting under very dark or very bright conditions, you may not be able to obtain satisfactory results even after performing exposure compensation.
- An EV value setting you make remains in effect until you change it. To reset the EV value to zero, use [+] and [-] to return the display value to zero, which is indicated when  is not on the monitor screen. Note that turning off the camera also resets the EV value to zero.
- In the Panorama Mode, the exposure compensation setting you make for the first image of the panorama is fixed for all the other images.

# OTHER RECORDING FUNCTIONS

This section describes more advanced recording operations that are also provided by this camera.

## Shooting Portraits

The Portrait Mode blurs the background slightly, which makes the foreground subject stand out better.

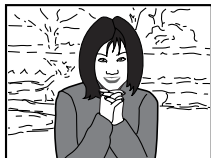

1. Enter the REC mode.
2. Press MENU.
3. Select “PORTRAIT” (Portrait Mode), and then press the shutter release button.
4. Press the shutter release button to record the image.

### NOTE

- You can blur the background even more by using the zoom slider adjust to maximum telephoto.

## Shooting Landscapes

The Landscape Mode brings everything from distant scenery to close foreground objects into focus.

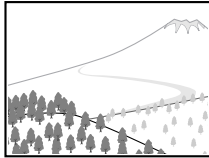

1. Enter the REC mode.
2. Press MENU.
3. Select “LANDSCAPE” (Landscape Mode), and then press the shutter release button.
4. Press the shutter release button to record the image.

### NOTES

- You can add more depth from the foreground to background, and also create a greater feeling of horizontal expanse by using the zoom slider to adjust to maximum wide-angle.
- Using the Landscape Mode indoors, in a shaded location, or in any other areas where lighting is dim can result in distant objects being out of focus.



## Shooting Night Scenes

The Night Scene Mode uses longer exposure to produce beautiful night scene images.

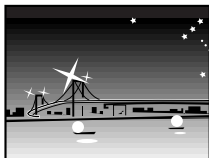

1. Enter the REC mode.
2. Press MENU.
3. Select “NIGHT SCENE” (Night Scene Mode), and then press the shutter release button.
4. Press the shutter release button to record the image.

### NOTE

- You can use the Night Scene Mode in combination with flash for slow sync shooting of people against a twilight or night scene background.

### IMPORTANT!

- The shutter speed is quite slow in the Night Scene Mode, so be sure to use a tripod to hold the camera steady.
- Auto Focus is difficult in the dark. If you experience problems, use manual focusing (page E-57). There may be some blurring of the image in cases where the subject is moving quickly.
- Slow shutter speed also causes slow monitor screen refresh. Because of this, the image recorded may be slightly different from the image that was on the monitor screen when you pressed the shutter release button.
- The contrast of Night Scene Mode images is not affected by changes made in contrast settings (page E-88).

## Instant Setup Using the Scene Mode

The Scene Mode comes with a library of 28 different images. Simply select the image whose effects are the one you want, and the settings of the camera automatically change to the same setup that was used to record the selected image.

### ■ Instant Setup Using the Scene Mode



Sunset



Dancing Lights

See the “Scene List” on page E-138 for a full list of available scenes.

### ■ Composition Outline

With certain Scene Mode images, a composition outline appears on the monitor screen to aid you when composing your image. The Auto Focus Frame is also adjusted on the monitor screen, so it is in the appropriate location to suit the composition outline.

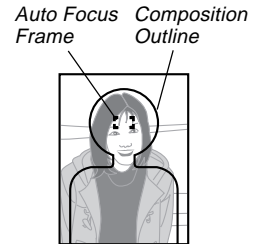

Example: Face and Chest

- This camera does not support Camera Orientation Detection, which stores camera orientation information along with image data so images are oriented automatically when displayed using Photo Loader. Images recorded with the camera oriented sideways are displayed sideways by Photo Loader. Use commercially available image editing software to change the orientation of images on your computer screen.

1. Enter the REC mode.
2. Press MENU.
3. Select “SCENE” (Scene Mode), and then press the shutter release button.



4. Select the scene you want, and then press the shutter release button.
  - You can register your own scenes and settings for scene numbers 29 to 31. See “Registering Your Own Scene Setups”.
5. Press the shutter release button to record the image.

## NOTES

- Scene Mode images are not images recorded using this camera. They are intended for reference purposes only.
- The actual conditions that are present when you record your image may make it impossible to correctly obtain all of the effects of the Scene Mode image you select.
- After selecting an image in the Scene Mode, you can adjust camera settings manually as you normally do.
- The first scene that appears is the one that was selected when you last exited the Scene Mode. Note, however, that scene number 01 appears first following a camera reset (page E-89).

## Registering Your Own Scene Setups

You can register the settings of any image recorded with a CASIO QV-2300UX camera as a “user setup” for the Scene Mode (page E-66). After you register a user setup, you can recall it just as you do with other scenes in the Scene Mode.

### ■ User Setup Parameters

Focus mode, aperture (A and M only), shutter speed (S and M only), exposure compensation, sensitivity, filter setting, exposure mode, metering mode, white balance, enhancement, flash intensity, sharpness, saturation, contrast, flash mode

### ■ Supported Camera Models

- QV-2300UX user setups can be registered using images recorded with a QV-2300UX only.
- QV-2800UX user setups can be registered using images recorded with a QV-2800UX only.

### ■ Number of User Setups

You can register up to three user setups.

1. Enter the REC mode.
2. Press MENU.
3. Select “SCENE” (Scene Mode), and then press the shutter release button.



4. Select the scene number where you want to store the setup and then press .

  - Scene numbers 29 to 31 can be used to store user setups.

5. Select the scene you want to import, and then press the shutter release button.

6. The camera returns to the REC mode after registration is complete. Now you can use the procedure under “Instant Setup Using the Scene Mode” on page E-66 to select a scene and record an image.

### NOTES

- The first scene that appears is the one that was selected when you last exited the Scene Mode. Note, however, that scene number 01 appears first following a camera reset (page E-89).
- Once you register a user setup, it cannot be deleted. You can, however, overwrite a user setup with another user setup.
- After you select a Scene Mode image, you can see the camera setup by displaying the various menus you normally use when setting up the camera manually.

## Recording a Movie

You can record movies that are approximately 16 seconds long. There are two movie recording modes: past and normal. The past mode lets you capture images of events that occurred before you pressed the shutter release button while the normal mode records what happens after you press the shutter release button.

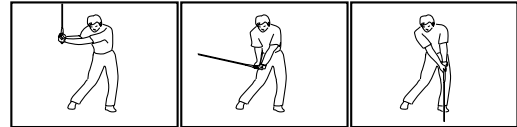

### ■ File Format: AVI

AVI format is the Motion JPEG format standard advocated by the Open DML Consortium.

### ■ Size: 320 x 240 pixels

### ■ Movie Memory Requirements

Approximately 300KB/second

### ■ Maximum Movie Length

16 seconds

## To record a movie using the normal mode

1. Enter the REC mode.
2. Press MENU.
3. Select “MOVIE” (Movie Mode), and then press the shutter release button.
4. Point the camera at the subject, and then press the shutter release button about half way down.
  - Auto Focus continues to adjust the focus as the subject moves.
5. Press the shutter release button all the way down to start recording.
  - Recording continues for 16 seconds.
  - To record a movie that is shorter than 16 seconds, press the shutter release button again when you want to stop recording.

## To record a movie using the past mode

1. Enter the REC mode.
2. Press MENU.

3. Select “MOVIE (PAST)” (Movie Past Mode), and then press the shutter release button.
4. When you are ready to record, press the shutter release button all the way down.
  - Auto Focus continues to adjust the focus as the subject moves.
5. Follow the subject with the camera, and press the shutter release button all the way down when you want to record.
  - Pressing the shutter release button the second time records everything that went on in front of the lens during the 16-second period before you pressed the shutter release button the first time in step 4.
  - Pressing the shutter button before 16 seconds have passed after you pressed the shutter release button the first time in step 4 records everything that went on in front of the lens during the period from when you pressed the shutter release button the first time, up to the point when you pressed it the second time.

### IMPORTANT!

- Flash is disabled during movie recording.
- To view an AVI file on your computer, install QuickTime from the CD-ROM disc that comes bundled with the camera.

## Shooting Panoramas

The Panorama Mode lets you digitally stitch together multiple images to create a sweeping panorama.

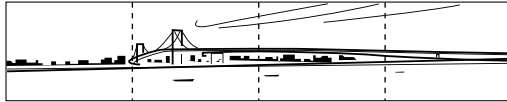

1. Enter the REC mode.
2. Press MENU.
3. Select "PANORAMA" (Panorama Mode), and then press the shutter release button.



4. Press the shutter release button to record the first image.

- The right edge of the first image remains on the left side of the monitor screen to help you compose the second image of the panorama.

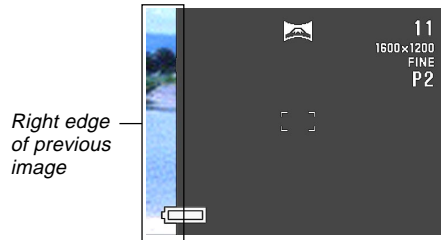

5. Shoot the other images that will make up the panorama, each time using the right edge of the previous image to compose the next image correctly.
6. After recording the images you want, press MENU.
  - You can group up to 10 images into a panorama.

**NOTE**

- The camera uses the same exposure and white balance settings in effect when the first image of the panorama is recorded for recording all of the other images of the panorama.

**Shooting at Fixed Intervals**

The Interval Mode lets you specify the number of images you want to shoot, the interval between shots, and the time to start shooting. It provides you with the following three types of interval shooting.

- Interval Shooting: Multiple shots at fixed intervals starting from now
- Timer Shooting: Single shot at a specific time
- Interval + Timer Shooting: Multiple shots at fixed intervals starting at a specific time

1. Enter the REC mode.
2. Press MENU.
3. Select “INTERVAL” (Interval Mode), and then press the shutter release button.





**4. Specify a value for “Shots” and then press the shutter release button.**

- You can skip this step if you want to shoot only a single image.
- Select “MAX shots” when you want the camera to keep recording images until its memory card becomes full.

**5. Specify the “Interval” in minutes, and then press the shutter release button.**

- You can specify an interval value within the range of 1 minute to 60 minutes, in one-minute steps.

**6. Specify the “Hour” part of the “Start Time” setting, and then press the shutter release button.**

- The “Start Time” specifies the time when shooting begins.
- You can specify a time that is within 24 hours of your current time (as kept by the camera’s built-in clock).
- If you want the image shooting to begin immediately when you press the shutter release button, select “Now” and continue from step 8.

**7. Specify the “Minutes” part of the “Start Time” setting, and then press the shutter release button.**

**8. Make exposure mode, metering mode, white balance, and other image settings you want.**

**9. Compose the image so the subject is in the focus frame, and press the shutter release button all the way down.**

- When the time you set in steps 6 and 7 is reached, the operation lamp lights and shooting begins.
- If you selected “Now” in step 6, shooting starts as soon as you press the shutter release button in step 9.

**IMPORTANT!**

- The “BULB” shutter speed setting is automatically disabled in the Interval Mode. If “BULB” is selected, entering the Interval Mode automatically switches over to a shutter speed setting of 1 second.
- When the shutter speed is set to 20 seconds or longer, the camera may not be able to record at 1-minute intervals in the Interval Mode.

## Canceling an Interval Mode Timer Operation

Sliding the POWER ON/OFF switch to the right to turn on the camera while an Interval Mode timer operation is being performed cancels the operation, which is indicated by the message “Interval operation cancelled” on the monitor screen.

## Specifying the Exposure Mode

You can select from among the four exposure modes listed below. You can change the shutter mode setting while in any of the record modes.

- P Mode : Program AE
- A Mode : Aperture priority AE
- S Mode : Shutter speed priority AE
- M Mode : Manual

## Program AE

In the P Mode (program AE), shutter speed and aperture settings are made automatically in accordance with the brightness of the subject.

- 1. Enter the REC mode.**
- 2. Press MENU.**
- 3. Select “FUNCTION” → “Exposure Mode”, and then press the shutter release button.**
- 4. Select “P” (Program), and then press the shutter release button.**
- 5. Press the shutter release button to record the image.**

## Aperture Priority AE

The A Mode (aperture priority AE) is the opposite of the S Mode. It lets you specify an aperture setting and automatically adjusts shutter speed accordingly. A larger aperture decreases depth of field, which is the zone of sharp focus in a scene. Conversely, a smaller aperture increases depth of field.

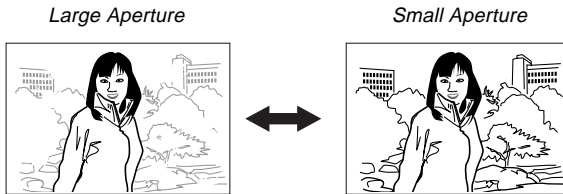

- Note that a smaller number indicates a larger aperture, and a larger number indicates a smaller aperture.

### ■ Aperture Settings

| Aperture  | Larger | ↔        | Smaller |
|-----------|--------|----------|---------|
| QV-2300UX | F2.8   | •        | F5.6    |
| QV-2800UX | F3.2   | • F4.8 • | F8      |

1. Enter the REC mode.
2. Press MENU.
3. Select “FUNCTION” → “Exposure Mode”, and then press the shutter release button.
4. Select “A” (Aperture priority), and then press the shutter release button.
5. While holding down SHIFT INFO, use [+] and [-] to select the aperture value you want.

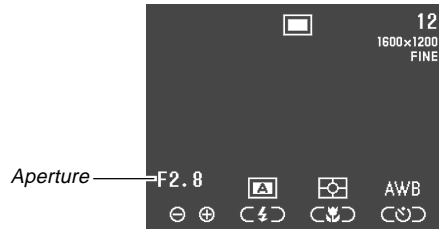

| To do this        | Press this button |
|-------------------|-------------------|
| Decrease aperture | [+]               |
| Increase aperture | [-]               |

## 6. Press the shutter release button to record the image.

### IMPORTANT!

- It is often difficult to obtain proper brightness when shooting a subject that is very dark or very light. In such a case, try different aperture settings to find the one that produces the best results.

## Shutter Speed Priority AE

The S Mode (shutter speed priority AE) lets you specify a shutter speed and automatically adjusts aperture accordingly.

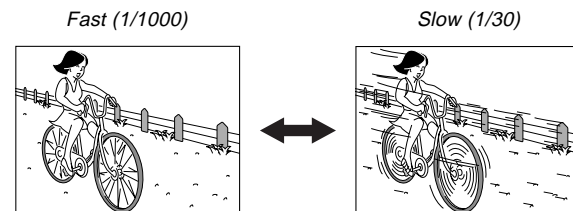

### Shutter Speed Settings

|               |                                   |
|---------------|-----------------------------------|
| Shutter Speed | Slow ↔ Fast                       |
|               | BULB, 60 seconds to 1/2000 second |

- Enter the REC mode.
- Press MENU.

3. Select “FUNCTION” → “Exposure Mode”, and then press the shutter release button.
4. Select “S” (Shutter speed priority), and then press the shutter release button.
5. While holding down SHIFT INFO, use [+] and [-] to specify the shutter speed.

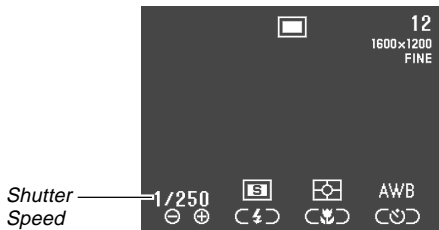

| To do this             | Press this button |
|------------------------|-------------------|
| Increase shutter speed | [+]               |
| Decrease shutter speed | [-]               |

6. Press the shutter release button to record the image.

**IMPORTANT!**

- It is often difficult to obtain proper brightness when shooting a subject that is very dark or very light. In such a case, try different shutter speed settings to find the one that produces the best results.
- When the Shutter Speed is set to “BULB”, exposure continues as long as you depress the shutter button. Because of this, use of the wired remote control unit is recommended whenever using the “BULB” setting.
- The self-timer is disabled while the Shutter Speed is set to “BULB”.
- The slowest shutter speed when “BULB” is selected is 60 seconds.
- Note that using a slower shutter speed increases the chance of static being present in your image, and the amount of static visible in an image is inversely proportional to the shutter speed.
- At shutter speeds of one second or slower, the camera automatically performs internal data processing intended to limit image static, so the image record operation takes longer at slow shutter speeds. At shutter speeds of one second or greater, doubling the shutter speed setting tells you about how long it takes for an image to be recorded. For example, image recording with a shutter speed of one second takes about two seconds.

- A shutter speed slower than 1/8 second can cause the brightness of the image on the monitor screen to be different from the brightness of the image that is recorded. Slower speeds can also cause exposure of the image to be outside the AE range, making it impossible to achieve a proper aperture setting.

## Manual Exposure

The M Mode (manual) lets you make the shutter speed and aperture settings you want.

- The shutter speed settings you can make are the same as those for shutter speed priority AE (page E-76).
- The aperture settings you can make are the same as those for aperture priority AE (page E-75).

1. Enter the REC mode.
2. Press MENU.
3. Select “FUNCTION” → “Exposure Mode”, and then press the shutter release button.

4. Select “M” (Manual), and then press the shutter release button.
5. Use [+] and [-] to specify the shutter speed.

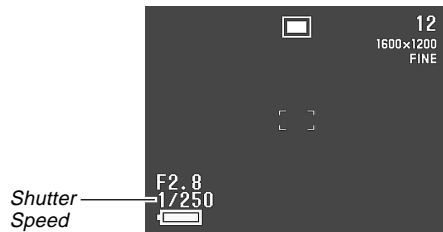

| To do this             | Press this button |
|------------------------|-------------------|
| Increase shutter speed | [+]               |
| Decrease shutter speed | [-]               |

6. While holding down **SHIFT INFO**, use **[+]** and **[-]** to select the aperture value you want.

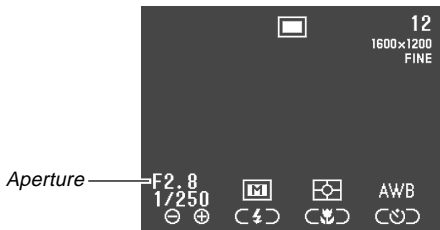

| To do this        | Press this button |
|-------------------|-------------------|
| Decrease aperture | [+]               |
| Increase aperture | [-]               |

7. Press the shutter release button to record the image.

### IMPORTANT!

- A shutter speed slower than 1/8 second can cause the brightness of the image on the monitor screen to be different from the brightness of the image that is recorded.

## Quick Exposure Mode Selection

You can also use the following procedure to change the exposure mode, without going through the menu.

1. Enter the REC mode.
2. While holding down **SHIFT INFO**, press **⚡** **📷** to cycle through the exposure mode icons on the monitor screen in the sequence shown below.
  - **[P]** (program AE) → **[A]** (aperture priority AE) → **[S]** (shutter speed priority AE) → **[M]** (manual)

## Selecting the Metering Mode

Use the following procedure to specify multi metering, spot metering, or center-weighted metering as the metering mode.

1. Enter the REC mode.
2. Press MENU.
3. Select "FUNCTION" → "Metering", and then press the shutter release button.
4. Select the metering mode you want and then press the shutter release button.

### Multi:

This mode takes readings across the entire image, and provides balanced exposure settings.



### Center:

This mode takes readings at the center of the image.



### Spot:





This mode takes readings at a very limited spot at the center of the screen. It is not affected by light around the outer periphery of the image, which means that exposure can be set according to the illumination of a particular subject.





## Quick Metering Mode Selection

You can also use the following procedure to change the metering mode, without going through the menu.

1. Enter the REC mode.
2. While holding down SHIFT INFO, press /∞/MF  to cycle through the metering mode icons on the monitor screen in the sequence shown below.
  -  (multi) →  (center) →  (spot)

## Setting the Sensitivity Level

Use the following procedure to specify the sensitivity level.

1. Enter the REC mode.
2. Press MENU.
3. Select “FUNCTION” → “Sensitivity”, and then press the shutter release button.
4. Select the setting you want, and then press the shutter release button.

| If you want to set sensitivity at this level | Select this |
|--|-------------|
| ISO 80 equivalent                            | ISO 80      |
| ISO 160 equivalent                           | ISO 160     |
| ISO 320 equivalent                           | ISO 320     |

**IMPORTANT!**

- Higher sensitivity can increase the chance of noise in the image.
- Higher sensitivity can make it difficult to obtain proper focus using Auto Focus. It does not change the minimum brightness required for Auto Focus.
- Regardless of the setting you make here, a sensitivity setting of ISO 80 is used automatically whenever you shoot with flash and whenever the S Mode (shutter speed priority AE) is selected.

**Using the Filter Function**

The camera's filter function lets you filter the image with one of a selection of different colors.

- 1. Enter the REC mode.**
- 2. Press MENU.**
- 3. Select "FUNCTION" → "Filter", and then press the shutter release button.**
- 4. Select the setting you want, and then press the shutter release button.**
  - Available filter settings are: Off, B/W, Sepia, Red, Green, Blue, Yellow, Pink, Purple

**NOTES**

- The filter function produces the same effect as if a piece of colored cellophane paper were held in front of the lens of the camera. Color enhancement (page E-85), on the other hand, alters the characteristics of the image to enhance specific color components.
- If color enhancement (page E-85) and the filter function are both turned on at the same time, the filter function is given priority (color enhancement is not performed).

## Selecting White Balance

Selecting the right type of white balance can help to make the colors of a subject appear most natural under the type of lighting that is available.

1. Enter the REC mode.
2. Press MENU.
3. Select “FUNCTION” → “White Balance”, and then press the shutter release button.
4. Select the type of white balance you want, and then press the shutter release button.

| To do this  | Select this |
|---|-------------|
| Let the camera adjust white balance automatically           | Auto        |
| Shoot outdoors  | Daylight    |
| Shoot in shady conditions                                   | Shade       |
| Shoot under incandescent (light bulb) lighting              | Tungsten    |
| Shoot under fluorescent lighting                            | Fluorescent |
| Adjust white balance normally for a particular light source | Manual      |

### NOTE

- Use “Daylight” for shooting in the Night Scene Mode. You can also use manual white balance if the “Daylight” setting does not produce the desired results.



## Adjusting White Balance Manually

Under some light sources, automatic white balance under the “Auto” setting can take a long time to complete. Also, the auto white balance range (color temperature range) is limited. Manual white balance helps to ensure that colors are recorded correctly for a particular light source.

Note that manual white balance requires you to point the camera at a piece of white paper or other similar object so it completely fills the monitor screen.

1. Enter the REC mode.
2. Press MENU.
3. Select “FUNCTION” → “White Balance”, and then press the shutter release button.
4. Select “Manual”, and then press the shutter release button.

## 5. Point the camera at a piece of white paper or other similar object so it completely fills the monitor screen, and then press the shutter release button.







- This performs white balance adjustment and returns to the REC mode screen.
- Pressing   without pressing the shutter release button first restores the setting obtained the last time you performed manual white balance.
- Dark lighting or pointing the camera at a dark object can cause manual white balance to take a very long time to complete. Avoid such conditions when performing manual white balance adjustment.

### NOTE

- Even if you turn off the camera or change its white balance back to “Auto” or another white balance setting, the last value obtained by manual white balance is retained in memory and restored the next time you select “Manual” for the white balance. The last value obtained by manual white balance is retained, regardless of the mode memory setting (page E-88).

## Quick White Balance Selection

You can also use the following procedure to change the white balance, without going through the menu.

1. Enter the REC mode.
2. While holding down **SHIFT INFO**, press   to cycle through the white balance icons on the monitor screen in the sequence noted below.
  - **AWB** (Auto) →  (Daylight) →  (Shade) →  (Tungsten) →  (Fluorescent) → **MWB** (Manual)
  - For manual white balance, display the **MWB** icon, point the camera at a white piece of paper, hold down **SHIFT INFO**, and press the shutter release button.

## Enhancing Certain Colors

Use the following procedure when you want to enhance a particular color in your recorded image.

1. Enter the REC mode.
2. Press MENU.
3. Select "FUNCTION" → "Enhancement", and then press the shutter release button.
4. Select the setting you want, and then press the shutter release button.

| To do this                 | Select this |
|----------------------------|-------------|
| Turn off color enhancement | Off         |
| Enhance reds               | Red         |
| Enhance greens             | Green       |
| Enhance blues              | Blue        |
| Enhance flesh tones        | Flesh Tones |

## NOTES

- The filter function (page E-82) produces the same effect as if a piece of colored cellophane paper were held in front of the lens of the camera. Color enhancement, on the other hand, alters the characteristics of the image to enhance specific color components.
- If color enhancement and the filter function (page E-82) are both turned on at the same time, the filter function is given priority (color enhancement is not performed).

## Turning the On-screen Grid On and Off

You can display gridlines on the monitor screen to help you compose your images before recording them.

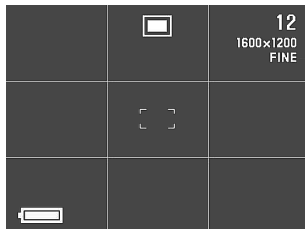

1. Enter the REC mode.
2. Press MENU.
3. Select “FUNCTION” → “Grid”, and then press the shutter release button.

4. Select the setting you want, and then press the shutter release button.

| To do this        | Select this |
|-------------------|-------------|
| Turn the grid off | Off         |
| Turn the grid on  | On          |

### Specifying Outline Sharpness

Use the following procedure to control the sharpness of image outlines.

1. Enter the REC mode.
2. Press MENU.
3. Select “FUNCTION” → “Sharpness”, and then press the shutter release button.
4. Select the setting you want, and then press the shutter release button.

| To do this                 | Select this |
|----------------------------|-------------|
| Make outlines sharp        | Hard        |
| Leave outlines as they are | Normal      |
| Make outlines soft         | Soft        |

### Specifying Color Saturation

Use the following procedure to control the saturation of image colors.

1. Enter the REC mode.
2. Press MENU.
3. Select “FUNCTION” → “Saturation”, and then press the shutter release button.
4. Select the setting you want, and then press the shutter release button.

| To do this               | Select this |
|--------------------------|-------------|
| Make colors more intense | High        |
| Leave colors as they are | Normal      |
| Make colors less intense | Low         |

### Specifying Contrast

Use the following procedure to control the difference between the light areas and dark areas of the image.

1. Enter the REC mode.
2. Press MENU.
3. Select “FUNCTION” → “Contrast”, and then press the shutter release button.
4. Select the setting you want, and then press the shutter release button.

| To do this              | Select this |
|-------------------------|-------------|
| Increase contrast       | High        |
| Leave contrast as it is | Normal      |
| Decrease contrast       | Low         |

#### NOTE

- The contrast setting you make is not used in the Night Scene Mode.

### Specifying Power On Default Settings

Configuring the camera’s “mode memory” controls power on default settings. Turning a mode memory item on specifies that the setting of the item when the camera is turned off should be restored when the camera is turned back on again. Turning a mode memory item off specifies that its factory default setting should be used whenever the camera is turned on.

1. Enter the REC mode.
2. Press MENU.
3. Select “FUNCTION” → “Mode Memory”, and then press the shutter release button.
4. Select the item whose mode memory status you want to change, and then press the shutter release button.
5. Select the setting you want, and then press the shutter release button.



| To do this when the camera is turned on                   | Select this   |
|---|---------------|
| Restore the item's last setting when power was turned off | On            |
| Restore the item's factory default setting                | Off (default) |

### ■ Mode Memory Items and Settings

| Item            | Memory Mode Status    |                |
|-----------------|-----------------------|----------------|
|                 | On                    | Off            |
| Recording Mode  | Setting at power off. | Normal         |
| Sensitivity     |                       | ISO 80         |
| Exposure Mode   |                       | P (Program AE) |
| Metering        |                       | Multi          |
| White Balance   |                       | Auto           |
| Flash           |                       | Auto           |
| Focus           |                       | Auto           |
| Digital Zoom    |                       | Auto           |
| Flash Intensity |                       | Normal         |

## Resetting the Camera

Use the following procedure to reset all of the camera's settings to their initial defaults as shown under "Camera Menus" on page E-136.

1. Enter the REC mode or PLAY mode.
2. Press MENU.
3. Select "Restore" using one of the following two key operations, and then press the shutter release button.

| If you are here | Select this on the menu screen    |
|-----------------|-----------------------------------|
| REC mode        | "FUNCTION" → "SET UP" → "Restore" |
| PLAY mode       | "SET UP" → "Restore"              |

4. In response to the confirmation message that appears, use [+] and [-] to select "Yes" to reset or "No" to exit, and then press the shutter release button.

6. Press  .

## Using the Camera's Shortcut Features

The shortcut features of the camera help to make it quicker and easier to obtain the REC mode setup you want. There are three shortcut procedures that you can use.

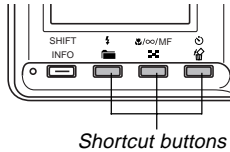

### ■ Changing specific REC mode FUNCTION menu settings using the shortcut buttons

The shortcut buttons are the three buttons to the right of the SHIFT INFO button below the monitor screen. You can cycle through REC mode FUNCTION menu settings by holding down SHIFT INFO and pressing the shortcut buttons. See page E-91.

### ■ Direct access to the FUNCTION menu

This shortcut lets you display the FUNCTION menu with the press of a button. See page E-93.

### ■ Cycling through settings on the FUNCTION menu

This shortcut lets you cycle through the settings of the currently selected FUNCTION menu item, without advancing to the item's setting screen.

## Changing REC mode FUNCTION Menu Settings Using the Shortcut Buttons

Changing REC mode FUNCTION Menu settings is normally a multi-step process: Press MENU, use [+] and [-] to select "FUNCTION", press the shutter release button, use [+] and [-] to select the item, and then use [+] and [-] to change the setting. This shortcut lets you change the settings of specific REC mode FUNCTION menu items without displaying the FUNCTION menu.

















### To change settings using the shortcut buttons

#### 1. Enter the REC mode.

#### 2. Hold down SHIFT INFO.

- This causes icons that identify the FUNCTION menu items assigned to the shortcut buttons to appear on the monitor screen above each button.

3. While holding down **SHIFT INFO**, press one of the shortcut buttons to cycle through the settings of the item assigned to the button. The current setting of each button is indicated by an icon above the button.

| Button  | REC mode<br>FUNCTION<br>Menu Item | Icon  | Setting                      |
|---|-----------------------------------|---|------------------------------|
|  | Exposure<br>Mode<br>(page E-79)   |  | Program AE                   |
|   |                                   |  | Aperture Priority AE         |
|   |                                   |  | Shutter Speed<br>Priority AE |
|   |                                   |  | Manual                       |
|  | Metering<br>(page E-81)           |  | Multi                        |
|   |                                   |  | Center                       |
|   |                                   |  | Spot                         |
|  | White<br>Balance<br>(page E-84)   |  | Auto                         |
|   |                                   |  | Daylight                     |
|   |                                   |  | Shade                        |
|   |                                   |  | Tungsten                     |
|   |                                   |  | Fluorescent                  |
|   |                                   |  | Manual                       |

## To assign REC mode FUNCTION menu items to shortcut buttons

1. Enter the REC mode.
2. Press **MENU**.
3. Use **[+]** and **[-]** to select “FUNCTION”, and then press the shutter release button.
4. Use **[+]** and **[-]** to select the item you want to assign to a shortcut button and then press the shutter release button to display its setting screen.

- The following example shows the Filter setting screen.

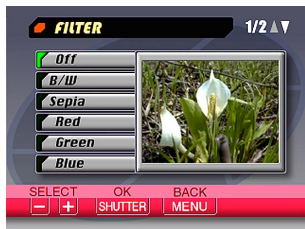

- You can assign any of the items marked with “○” in the table under “Camera Menus” on page E-136 to a shortcut button.

**5. While holding down SHIFT INFO, press the shortcut button to which you want to assign the item you selected in step 4.**

- This assigns the item and returns to the REC mode screen.
- You can assign only one menu item to each of the three shortcut buttons.

- Assigning a menu item to a shortcut button changes the icon that appears above the button when SHIFT INFO is pressed in the REC mode as shown below.

| Button | Default Setting Icon | Icon After Assignment |
|--------|----------------------|-----------------------|
|        |                      | SET 1                 |
|        |                      | SET 2                 |
|        |                      | SET 3                 |

- Repeat the above procedure when you want to restore the default shortcut button assignments. You need to assign the following items to the shortcut buttons indicated to restore the default assignments.

| Button | Assigned Item (Default) |
|--------|-------------------------|
|        | Exposure Mode           |
|        | Metering                |
|        | White Balance           |

- Default shortcut button assignments are also restored automatically by a Camera Reset (page E-89).

## Directly Accessing the REC mode FUNCTION Menu

When in the REC mode, you can hold down SHIFT INFO and press MENU to display the FUNCTION menu.



### Cycling through REC mode FUNCTION Menu Settings

You can use this shortcut to cycle through the settings of REC mode FUNCTION menu items without displaying the setting screen for the item.

1. Enter the REC mode.
2. Display the FUNCTION menu and select the item whose setting you want to change.

3. While holding down SHIFT INFO use [+] (forward) and [-] (back) to cycle through the settings of the currently selected item.



4. Repeat steps 2 and 3 for other items.
5. When everything is the way you want, press   to exit the FUNCTION menu.

# PLAYBACK

You can use the camera's built in monitor screen to play back recorded images.

## Basic Playback Operation

Use the following procedure to scroll through recorded images stored in the camera's memory.

### 1. Slide the REC/PLAY selector to "PLAY".

PLAY: PLAY mode for playing back images

### 2. Use [+] and [-] to scroll through the images on the monitor screen.

| To do this      | Press this button |
|-----------------|-------------------|
| Scroll forward  | [+]               |
| Scroll backward | [-]               |



## NOTES

- Holding down [+] or [-] scrolls images at high speed.
- In order to allow for faster playback image scrolling, the image that initially appears on the monitor screen is a preview image, which is of somewhat lower quality than the actual display image. The actual display image appears about three seconds after the preview image. This does not apply to images copied from another digital camera.

## Playing a Movie

Use the following procedure to play back a movie recorded in the Movie Mode.

1. Enter the PLAY mode.
2. Use [+] and [-] to scroll through the images on the monitor screen until the movie you want to play is displayed.



### 3. Press the shutter release button to start playing the movie.

- The following describes operations that are available during movie playback.

| If you want to do this                                       | Press this button      |
|--|------------------------|
| Toggle the movie between full screen and quarter screen view | SHIFT INFO             |
| Playback forward   | [+]                    |
| Playback in reverse  | [-]                    |
| Pause playback   | Shutter release button |
| Skip to the next frame while playback is paused              | [+]                    |
| Skip to the previous frame while playback is paused          | [-]                    |
| Exit movie playback  | MENU                   |

## Playing a Panorama

Use the following procedure to play back a panorama recorded in the Panorama Mode.

1. Enter the **PLAY** mode.
2. Use **[+]** and **[-]** to scroll through the images on the monitor screen until the panorama you want to play is displayed.

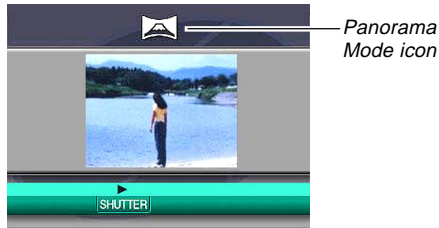

### 3. Press the shutter release button to start playing the panorama.

- The following describes operations that are available during panorama playback.

| If you want to do this                                      | Press this button      |
|---|------------------------|
| Toggle the panorama between full screen and compressed view | SHIFT INFO             |
| Scroll forward  | [+]                    |
| Scroll back   | [-]                    |
| Pause playback  | Shutter release button |
| Skip to the next image while playback is paused             | [+]                    |
| Skip to the previous image while playback is paused         | [-]                    |
| Exit panorama playback                                      | MENU                   |



## Enlarging the Playback Image

Use the following procedure to enlarge the playback image on the screen. You can select either 2X or 4X enlargement.

1. Enter the PLAY mode.
2. Use [+] and [-] to display the image you want to enlarge.
3. Press MENU.
4. Select "ZOOM", and then press the shutter release button to enlarge the image.



- The following describes operations that are available while an enlarged image is on the playback screen.

| If you want to do this  | Do this                           |
|---|-----------------------------------|
| Display on-screen guidance messages                               | Press SHIFT INFO.                 |
| Shift the view right  | Press [+].                        |
| Shift the view left   | Press [-].                        |
| Shift the view upwards  | Press /∞/MF .                     |
| Shift the view downwards  | Press  .                          |
| Cycle the enlargement in the sequence: 1X → 2X → 4X → normal size | Operate the zoom slider.          |
| Return the image to normal size                                   | Press the shutter release button. |

**IMPORTANT!**

- You cannot enlarge movie or panorama images.
- You can use the zoom slider at any time to cycle through the enlargement settings in the PLAY mode without selecting "ZOOM" on the menu.

## Displaying the 9-image View

The following procedure displays nine images on the monitor screen at the same time.

1. Enter the PLAY mode.
2. Press /∞/MF .

- The first of the nine images that appear on the monitor screen is the one that was displayed when you pressed /∞/MF .

|   |   |   |     |     |    |    |    |     |     |    |    |    |
|---|---|---|-----|-----|----|----|----|-----|-----|----|----|----|
| 1 | 2 | 3 | [+] | →   | 10 | 11 | 12 | [+] | →   | 19 | 20 | 21 |
| 4 | 5 | 6 |     |     | 13 | 14 | 15 |     |     | 22 | 23 | 24 |
| 7 | 8 | 9 | ←   | [-] | 16 | 17 | 18 | ←   | [-] | 25 |    |    |

- The following describes operations that are available while the 9-image view is on the monitor screen.

| To do this   | Press this button                      |
|--|--|
| Scroll forward   | [+]                                    |
| Scroll backward  | [-]                                    |
| Display the selection pointer (See following section.) | SHIFT INFO                             |
| Exit the 9-image view                                  | Any button other than the above three. |

## Selecting a Specific Image in the 9-image View

1. Display the 9-image view.
2. Press **SHIFT INFO**.

- This causes a pointer to appear in the upper left corner of the monitor screen.

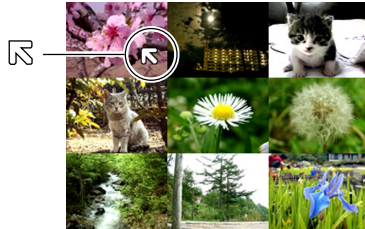

3. Use **[+]** and **[-]** to move the pointer to the image you want to select, and then press the shutter release button.
  - This displays the single-image view of the selected image.



## Using the Slide Show Feature

Slide Show automatically plays back images in sequence at a fixed interval.



- 1. Enter the PLAY mode.**
- 2. Press MENU.**
- 3. Select “SLIDE SHOW”, and then press the shutter release button.**
  - This starts the slide show.
  - Pressing MENU at this point displays a screen for setting the interval between image changes within the range of three to 30 seconds.
- 4. To stop Slide Show, press any button besides the shutter release button.**

### IMPORTANT!

- Auto Power Off (page E-36) is disabled whenever Slide Show is being used. This means you should not leave Slide Show running when using batteries to power the camera. Doing so can rundown batteries. Be sure to stop Slide Show and turn off the camera after you are finished.
- Note that all buttons are disabled while an image change is in progress. Wait until an image is stopped on the monitor screen before performing a button operation, or hold down the button until the image stops.
- Images copied from another digital camera or a computer may take longer time to appear than the Slide Show interval time you select.

# DELETING IMAGES



Your camera lets you use any one of the following four methods to delete images from its memory. You can delete the currently displayed image, one or more selected images, all the images in one or more selected folders, or all the images in the camera's memory.

## IMPORTANT!

- Image deletion cannot be undone. Before deleting an image, make sure you no longer need it or you have a back-up copy saved on your computer, on diskette, or on some other medium. Be especially careful with "Deleting All Unprotected Images" operation, which deletes all unprotected images in memory.
- A protected image cannot be deleted. See "Protecting Images Against Deletion" on page E-107 for details on protecting and unprotecting images.
- Delete operations are disabled when all of the images on the camera's memory card are protected.

## Deleting the Displayed Image

Use the following procedure when you want to delete the image that is currently on the monitor screen.

- 1. Enter the PLAY mode.**
- 2. Use [+] and [-] to scroll through images and display the image you want to delete.**
- 3. Press  .**
- 4. In response to the confirmation message that appears, use [+] and [-] to select "Yes".**
  - If you change your mind and do not want to delete the image, select "No" instead.
- 5. Press the shutter release button.**
  - Displaying a panorama or movie image in step 2 of the above procedure causes all of the images that make up the panorama or movie to be deleted.

### NOTE

- The camera does not maintain open spaces in its memory. Deleting an image causes images following the deleted image to be shifted up to fill in the empty space created by the deletion.

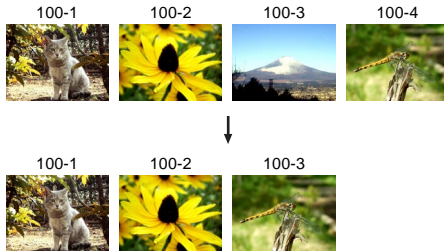



### Deleting Selected Images

The following procedure lets you select one or more image for deletion.

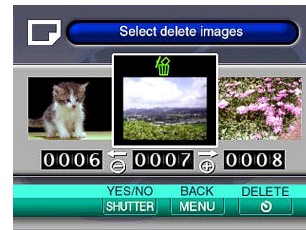
- 1. Enter the PLAY mode.**
- 2. Press MENU.**
- 3. Select “DELETE” → “Select”, and then press the shutter release button.**
- 4. Use [+] and [-] to display the image you want to delete.**
- 5. Press the shutter release button to toggle the displayed image’s icon on and off.**



- Any image marked with the  icon is marked for deletion. It will be deleted when you perform the next step of this procedure.
- Note that the image that was on the monitor screen when you pressed MENU in step 2 appears first with its  icon turned on.
- You can repeat steps 4 and 5 to mark and unmark multiple images if you want.

6. Press  .

7. In response to the confirmation message that appears, use [+] and [-] to select “Yes”.

- If you change your mind and want to cancel the delete, select “No” instead.



8. Press the shutter release button.

### Deleting All Images in Selected Folders

Use the following procedure to select one or more folder for deletion of all their images.

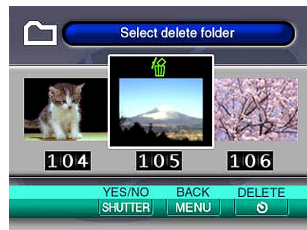
1. Enter the PLAY mode.
2. Press MENU.
3. Select “DELETE” → “Folder”, and then press the shutter release button.
4. Use [+] and [-] to display the folder whose images you want to delete.
5. Press the shutter release button to toggle the displayed folder’s  icon on and off.



- Any folder with the  icon is marked for deletion. All its images will be deleted when you perform the next step of this procedure.
- Note that the folder whose image was on the monitor screen when you pressed MENU in step 2 appears first with its  icon turned on.
- You can repeat steps 4 and 5 to mark and unmark multiple folders if you want.

**6.** Press  .

**7.** In response to the confirmation message that appears, use [+] and [-] to select “Yes”.

- If you change your mind and want to cancel the delete, select “No” instead.

**8.** Press the shutter release button.

## Deleting All Unprotected Images

Use the following procedure when you want to delete all of the images currently on the camera’s memory card.

**1.** Enter the **PLAY** mode.

**2.** Press **MENU**.

**3.** Select “**DELETE**” → “**All**”, and then press the shutter release button.

**4.** In response to the confirmation message that appears, use [+] and [-] to select “**Yes**”.

- If you change your mind and want to cancel the delete, select “No” instead.

**5.** Press the shutter release button.



# MANAGING IMAGES

The image management capabilities of the camera make it easy to keep track of images. You can protect images against deletion, and even use its DPOF feature to specify images for printing.

## Folders and Files

Whenever you shoot an image, the camera automatically creates a folder for the current date (as kept by the camera's built in clock). Any images you shoot on a particular day are all stored as image files inside the same folder.

- For full details about the organization of folders on the memory card, see "Using a Memory Card to Transfer Image Data" on page E-125.

## Folders

A folder is created automatically whenever you shoot the first image on a particular date. The name assigned to the folder is based on the current date, as described below. You can have up to 900 folders on a memory card at the same time (subject to storage capacity restrictions).

Example: Folder created on July 19, which is the 100th folder on the memory card

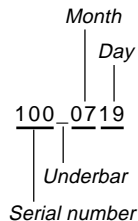

- The actual number of files you will be able to store on a memory card depends on the capacity of the card, image quality settings, etc.

## Files

Each folder can contain up to 250 image files. If you try to save the 251st image to a folder, the camera automatically creates a new folder and stores the image there. The names assigned to files are based on the current date, as shown below.

Example: 26th image shot on November 7

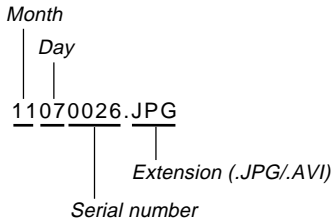

- In addition to image files, memory cards also contain a number of other files used by the system for image data management.
- The actual number of files you will be able to store on a memory card depends on the capacity of the card, image quality settings, etc.
- Panorama images are stored as groups of multiple individual images.
- If there are more than 250 image files in a folder (due to copying from another digital camera or other source), only the first 250 (in name sequence) can be played back.

### Selecting a Folder for Playback

Use the following procedure to select a particular folder and play back the image files it contains.

1. Enter the **PLAY** mode.
2. Press **⏮**.
3. Use **[+]** and **[-]** to select the folder you want, and then press the shutter release button.
  - This displays the image of the first file (in name sequence) contained in the folder you selected.

### Protecting Images Against Deletion





Image protection guards against accidental deletion of images stored on the camera's memory card. A protected image cannot be deleted until it is unprotected (page E-101). You can protect and unprotect a single specific image, all the images in a particular folder, or all images currently on the memory card.

### Protecting Selected Images

1. Enter the **PLAY** mode.
2. Press **MENU**.
3. Select **"PROTECT"** → **"Select"** and then press the shutter release button.
4. Use **[+]** and **[-]** to display the image you want to protect.

5. Press the shutter release button to toggle the displayed image's  icon on and off.







- Any image marked with the  icon is marked for protection. It will be protected when you perform the next step of this procedure. Any image without the  icon will be unprotected.
  - You can repeat steps 4 and 5 to turn on the  icon for multiple images if you want.
6. Press   to protect all the images marked for protection, and unprotect the unmarked images.

## Protecting and Unprotecting All Images in Selected Folders

1. Enter the PLAY mode.
2. Press MENU.
3. Select "PROTECT" → "Folder", and then press the shutter release button.
4. Use [+] and [-] to display the folder whose images you want to protect.
5. Press the shutter release button to toggle the displayed folder's  icon on and off.



- Any folder with the  icon is marked for protection. All its images will be protected when you perform the next step of this procedure. All images in any folder without the  icon will be unprotected.
  - You can repeat steps 4 and 5 to turn on the  icon for multiple folders if you want.
- 6. Press   to protect the images in all the folders marked for protection, and unprotect the images in the unmarked folders.**

## Protecting and Unprotecting All Images

- 1. Enter the PLAY mode.**
- 2. Press MENU.**
- 3. Select “PROTECT” → “All”, and then press the shutter release button.**
- 4. Select the memory protection setting you want, and then press the shutter release button to apply it.**

| To do this                              | Select this |
|---|-------------|
| Protect all images on the memory card   | On          |
| Unprotect all images on the memory card | Off         |

## DPOF

The letters “DPOF” stand for “Digital Print Order Format”, which is a format for recording on a memory card or other medium which digital camera images should be printed and how many copies of the image should be printed. Then you can print on a DPOF-compatible printer or at a professional print service from the memory card in accordance with the file name and number of copies settings recorded on the card.



### ■ DPOF Settings

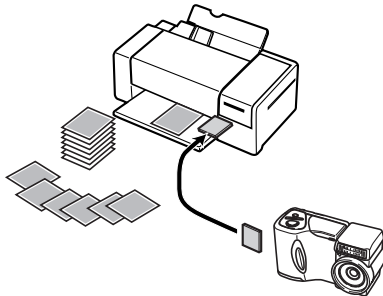

File Name, number of copies, date





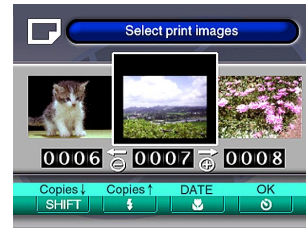

## Making DPOF Settings for Particular Images



1. Enter the **PLAY** mode.
2. Press **MENU**.
3. Select “DPOF” → “Select”, and then press the shutter release button.
4. Use **[+]** and **[-]** to display the image you want to print.
5. Use the button operations described below to make the DPOF settings you want.



| To do this                                       | Press this button   |
|--|---|
| Decrease the number of copies value              | SHIFT INFO  |
| Increase the number of copies value              |  |
| Toggle printing of the recording date on and off |  |



- An image selected for printing is marked by the  icon.
  - An image for which printing of the recording date is turned on is marked with the  icon.
  - You can repeat steps 4 and 5 to make DPOF settings for multiple image files, if you want.
- 6. After you are finished making the settings you want, press   to complete the procedure.**

## Making DPOF Settings for Particular Folders

- 1. Enter the PLAY mode.**
- 2. Press MENU.**
- 3. Select “DPOF” → “Folder” and then press the shutter release button.**
- 4. Use [+] and [-] to display the folder whose images you want to print.**
- 5. Use the same procedures as those described in step 5 under “Making DPOF Settings for Particular Images” on page E-110 to make the DPOF settings you want.**
- 6. After you are finished making the settings you want, press   to complete the procedure.**

## Making DPOF Settings of All Images on the Memory Card

1. Enter the PLAY mode.
2. Press MENU.
3. Select “DPOF” → “All”, and then press the shutter release button.
4. Use the button operations described below to make the DPOF settings you want.

| To do this                                    | Press this button   |
|---|---|
| Decrease the number of copies value           | SHIFT INFO  |
| Increase the number of copies value           |  |
| Toggle printing of recording dates on and off |  |



5. After you are finished making the settings you want, press   to complete the procedure.



# OTHER SETTINGS

## Turning the Monitor Screen Indicators On and Off

You can use the procedure below to turn the following monitor screen indicators on and off: exposure mode, memory capacity, image size, image protection indicator, folder name, file number, battery capacity.

1. Enter the REC mode or PLAY mode.
2. Select “Indicators” using one of the following two key operations, and then press the shutter release button.

| If you are here | Select this on the menu screen       |
|-----------------|--------------------------------------|
| REC mode        | “FUNCTION” → “SET UP” → “Indicators” |
| PLAY mode       | “SET UP” → “Indicators”              |

3. Select the setting you want, and then press the shutter release button.

| To do this                  | Select this setting |
|-----------------------------|---------------------|
| Turn on display indicators  | On                  |
| Turn off display indicators | Off                 |

## Changing the Display Language

Use the following procedure to switch the display language between English and Japanese.

1. Enter the REC mode or PLAY mode.
2. Press MENU.
3. Select “Language” using one of the following two key operations, and then press the shutter release button.

| If you are here | Select this on the menu screen     |
|-----------------|------------------------------------|
| REC mode        | “FUNCTION” → “SET UP” → “Language” |
| PLAY mode       | “SET UP” → “Language”              |

4. Select the setting you want, and then press the shutter release button.

| To do this                         | Select this setting |
|------------------------------------|---------------------|
| Display on-screen text in English  | English             |
| Display on-screen text in Japanese | Japanese            |

## Turning the Confirmation Beep On and Off

Use the following procedure to turn the beep that sounds each time you press a button on and off.

1. Enter the REC mode or PLAY mode.
2. Press MENU.
3. Select “Beep” using one of the following two key operations, and then press the shutter release button.

| If you are here | Select this on the menu screen |
|-----------------|--------------------------------|
| REC mode        | “FUNCTION” → “SET UP” → “Beep” |
| PLAY mode       | “SET UP” → “Beep”              |

4. Select the setting you want, and then press the shutter release button.

| To do this                     | Select this setting |
|--------------------------------|---------------------|
| Turn on the confirmation beep  | On                  |
| Turn off the confirmation beep | Off                 |

# CONNECTING TO EXTERNAL EQUIPMENT

Your camera has three terminals for connection to external equipment: a VIDEO OUT terminal, a DIGITAL terminal, and a USB port. You can use these terminals to connect the camera to a television, VCR, computer, or other external equipment. The QV-2800UX also includes an external flash sync terminal that can be used to connect a commercially available flash unit.

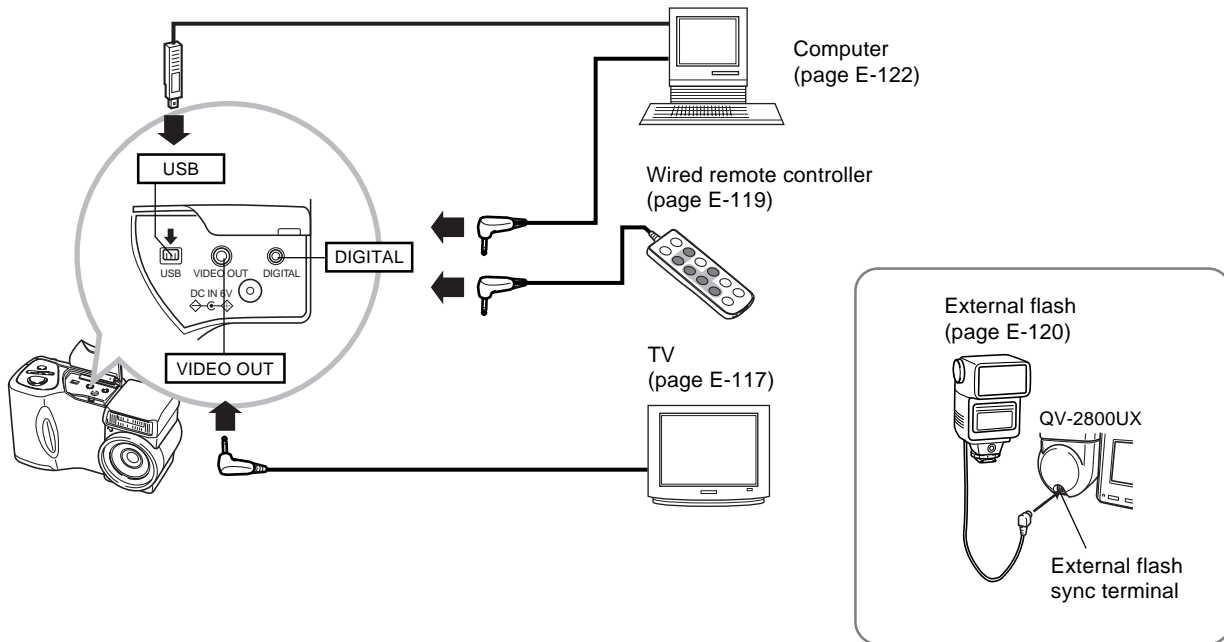

**IMPORTANT!**

- Be sure to turn off both the camera and the other equipment before making any connections.
- Check the documentation that comes with your other equipment for information you may need to know when making connections.
- Leaving the same image displayed on a television or computer display screen for very long periods can cause the image to be “burned in” on the screen. When this happens, a faint after-image remains on the screen, even after you disconnect the camera. To avoid this, you should not leave the same image displayed on such a screen for very long periods.
- This camera does not support cable transfer of data with other CASIO digital cameras.

**Connecting to a Television**

Images being displayed on the camera’s monitor screen, whether for recording or playback can also be displayed on the screen of a connected television. Connect the camera to a TV as illustrated below.

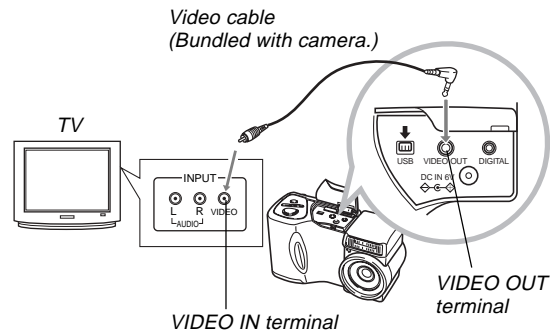

1. Use the video cable to connect the camera to the television as shown in the illustration.
2. Perform the required operation on the TV to set it up for video input.
  - See the documentation that comes with your television for information about how to do this.
3. Perform normal playback and recording operations on the camera.

**IMPORTANT!**

- Icons and other indicators that normally appear on the camera's monitor screen will also appear on the screen of the connected TV.

## Selecting the Video Output Signal Mode

Your camera supports both NTSC (used in U.S., Japan, and other countries) and PAL (used in Europe and other areas) video output signal systems. The video system you should use depends on the country of origin of the equipment you are connecting to the camera's VIDEO OUT terminal.

**IMPORTANT!**

- When you have PAL selected as the video signal output mode, the monitor screen is turned off when you connect the cable to the VIDEO OUT terminal.

1. Enter the REC mode or PLAY mode.
2. Press MENU.
3. Select "VIDEO OUT" using one of the following two key operations, and then press the shutter release button.

| If you are here | Select this on the menu screen      |
|-----------------|-------------------------------------|
| REC mode        | "FUNCTION" → "SET UP" → "VIDEO OUT" |
| PLAY mode       | "SET UP" → "VIDEO OUT"              |

4. Use [+] and [-] to select "NTSC" or "PAL", and then press the shutter release button.





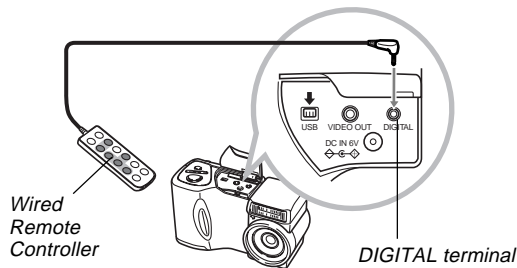

## Connecting the Wired Remote Controller to the Camera

The optionally available wired remote controller lets you operate the camera with touching it. This capability helps to avoid the effects of unintended camera movement when shooting at slow shutter speeds or with high telephoto settings with the camera mounted on a tripod. You can also use it to scroll through images during presentations on a TV screen. For more information about using the wired remote controller, see the instructions that come with it.

### Wired Remote

Controller Model: WR-1C (QV-2300UX option, QV-2800UX bundled accessory)



- You can perform the following operations using the wired remote controller: shutter release, zoom slider, MENU,    [+], [-], SHIFT INFO, , , .

## Connecting an External Flash Unit (QV-2800UX Only)

Use of a commercially available flash unit makes it possible to obtain a higher level of brightness (guide number) than you get when using the built-in flash alone. An external flash also makes it possible to extend the effective range of flash photography.

- The guide number of the internal flash is 9 (ISO 100/m).

## External Flash Unit Requirements

The external flash unit you use with your camera must satisfy the following requirements.

- Configuration: tripod hole mountable grip type with sync cable; or tripod hole mountable with grip-equipped bracket and sync cable
- Coverage Angle: Coverage of 40mm equivalent 35mm focal length lens (without wide conversion lens)
- Some flash performance may be lost when using a ring flash or other type of unit with a long flash time.
- The aperture values and ISO sensitivity available with some flash units may not match the values supported by your camera. In such a case, make adjustments in the aperture and ISO sensitivity settings of the external flash and the camera until proper brightness is achieved.
- Some flash performance may be lost when using a zoom flash.

## Attaching an External Flash Unit

Always make sure that the external flash unit is turned off before attaching it to detaching it from the camera. Leaving the flash unit on can cause it to fire unexpectedly.

1. Point the lens of the camera straight forward, so it matches the optical axis of the external flash.
2. Attach the external flash unit to its bracket, and affix the bracket to the camera's tripod hole.
  - If you are using a grip type flash unit, affix the flash unit directly to the camera's tripod hole.
3. Remove the terminal cap and attach the flash unit's sync cable to the external flash sync terminal.

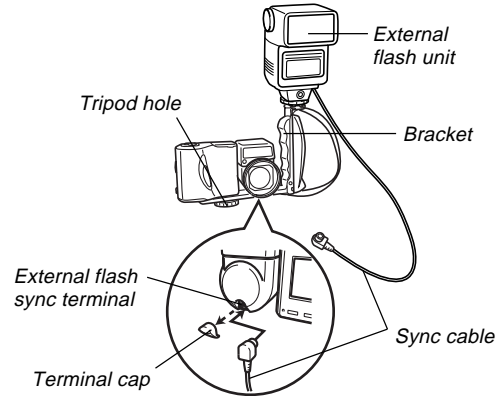

- Make sure you do not misplace the terminal cap. Always keep the terminal covered when an external flash unit is not connected.



#### 4. Turn on camera power and make the required camera settings.

- Exposure Mode: M (Manual Exposure)
- Shutter Speed: Around 1/60 (Actual setting should be in accordance with aperture setting.)
- For maximum brightness of areas that are not reached by flash illumination, use the camera's maximum aperture opening (F3.2).
- White Balance: Sunlight
- Flash Mode:  (Off)

#### 5. Turn on the external flash unit and set it up for the camera's aperture (F) value and sensitivity value (page E-78).

- Depending on shooting conditions, proper exposure may not be obtained even if you properly set the auto aperture (F) value and ISO sensitivity of the flash unit to match those of the camera. If this happens, adjust the aperture value and ISO sensitivity settings of the flash unit and camera.

#### IMPORTANT!

- The external flash connected to the external flash sync terminal always fires. To record an image without using external flash, disconnect the sync cable from the terminal or turn off external flash unit power.
- After recording an image, check it on the monitor screen. If it is not what you expected, use the controls on the external flash unit to adjust flash intensity, and adjust the aperture and ISO sensitivity settings on the camera. Note that you cannot control external flash unit intensity using camera settings.
- Close up images often tend to be overexposed. If you are having overexposure problems, try adjusting the aperture and ISO sensitivity settings of the external flash unit and the camera. You can also try using the camera's built in flash to correct for overexposure.
- Note that the camera's built in flash fires whenever its Flash Mode setting is something other than  (Off). The camera's sensitivity is fixed at ISO 80 when the built-in flash is turned on.
- Improper installation of an external flash unit can cause it to fire unexpectedly or to misfire. Make sure you install the external flash unit correctly.

- Camera aperture (F) values are based on the widest optical zoom (1X). Using telephoto can cause slight lens darkness. Adjust the aperture and ISO sensitivity settings of the external flash unit and the camera as required when using optical zoom.
- When using a zoom flash, set the coverage angle of the flash for a focal distance of 40mm or less.
- The optical axis of the lens may not match that of the external flash unit, even if the lens is pointed straight forward. If this happens, try expanding the coverage angle (decreasing the guide number) of the flash unit.
- ISO sensitivity values for a digital camera are slightly different from those for silver oxide film. Because of this, you may have to make adjustments of the ISO setting of your external flash unit to obtain the desired results.

### Connecting to a Computer

The CD-ROM disc that comes bundled with your camera includes special software (Photo Loader) that makes transfer of images from the camera to a computer quick and easy. The following types of computer connections are supported.

#### ■ Windows

- USB port connection
- Serial port (RS-232C) connection

#### ■ Macintosh

- USB port connection
- Photo Loader does not run on the Apple Macintosh. You can, however, use the USB cable to connect the camera to a Macintosh and upload images manually.

## USB Port Connection (Windows, Macintosh)

The camera's USB port and accessories make it easy to connect to a computer equipped with a USB port for image data uploading and downloading. First install the USB driver software from the bundled CD-ROM disc on your computer, and then use its special USB cable to connect. Once connected, your computer recognizes the camera as an external storage device.

- See the documentation on "Bundled Software User's Manual" for full details about connections, installing the USB driver, minimum computer system requirements, and other information.

### ■ Connecting to a Computer with the USB Cable

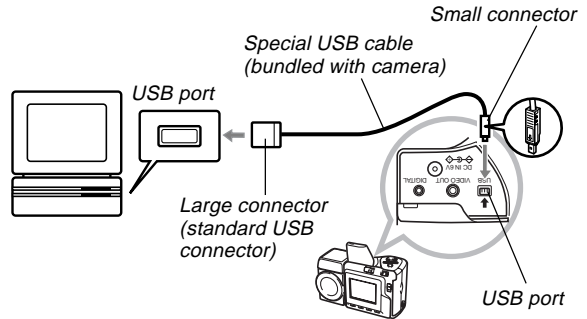

- Whenever connecting the USB cable to the camera, make sure the arrow mark on the plug is aligned properly with the arrow mark on the side of the camera's terminal.
- Plug the USB connectors into the ports as far as they will go. Incorrect connection can result in improper operation.
- The camera is not supplied power by the USB cable. Be sure to use the optional AC adaptor to power the camera whenever using a USB cable connection.
- Your camera requires a special QV Camera USB cable. Connection using a standard USB cable is not supported.

- Never disconnect the USB cable while a data communication operation is in progress. Doing so can corrupt memory data.
- USB data communication is supported in both the REC mode and PLAY mode.
- Be sure to disconnect the USB cable from the camera and computer after you are finished exchanging data.
- You cannot turn off the camera while the USB cable is connected. Disconnect the USB cable first when you want to turn off the camera.

## Using a Serial Port Connection

You can connect a computer to the camera's DIGITAL terminal for image data uploading and downloading. For such a connection, you must install the Photo Loader software from the bundled CD-ROM disc on your computer, and use a separately available CASIO data transfer cable to make the connection. The type of cable you should use depends on what kind of computer you are connecting to.

- This manual covers actual physical connection procedures. See the documentation on the Bundled Software User's Manual for full details about connections, installing Photo Loader, and other information.

### ■ Windows

The Data Transfer Cable connects to an IBM PC/AT or compatible equipped with a D-Sub 9-pin RS-232C serial port, as shown below.

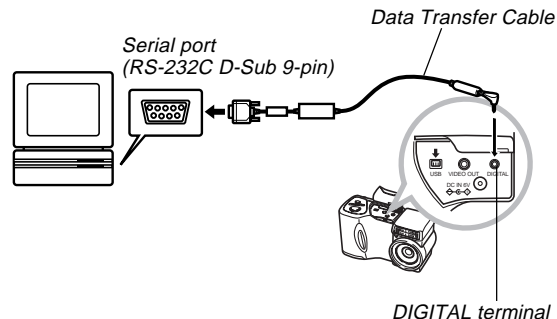

**IMPORTANT!**

- Be sure to turn off the camera, computer, and all peripherals connected to the computer (monitor, hard disk, etc.) before connecting the camera to the computer.
- After connecting the camera to the computer, slide the REC/PLAY selector to "PLAY", and then turn on the camera. Data communication with a computer is disabled while the camera is in the REC mode.
- Never connect or disconnect the cable while a data communication operation is in progress. Doing so can cause problems with program execution, can corrupt data, and can damage the camera and your computer.
- Data transfer while camera batteries are low can result in unexpected shutdown of the camera. Because of this, use of the optional AC adaptor is recommended whenever performing data communication with the camera.
- This camera does not support data communication with any of the optionally available CASIO PC link software applications: LK-1, LK-1A, LK-10V, LK-11W, LK-2, LK-2A, LK-2V, LK-21.

**Using a Memory Card to Transfer Image Data**

In addition to the cable connections described in the previous sections, you can also exchange data between your camera and computer by reading it directly from the memory card. The Photo Loader software that comes on the bundled CD-ROM disc automatically reads the images from the memory card and stores them in folders on your computer's hard disk.

The following provides general information about how to directly read images from a memory card. Certain details may be different depending on the type of computer you are using.

**■ Computer Equipped with a CompactFlash Card Slot**

Simply insert the memory card into your computer's CompactFlash card slot.

### ■ Computer Equipped with a PC Card Slot

For this configuration, you will need to purchase a separately available CASIO PC Card Adapter (CA-10). See the instructions that come with the PC Card Adapter for information about how to use it.

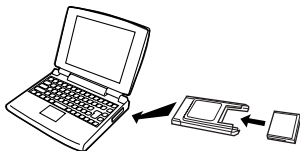

### ■ Another Computer

To access the contents on the memory card on a computer that does not have a CompactFlash card slot or PC card slot, use a commercially available PC card reader/writer in combination with a separately available CASIO PC Card Adapter (CA-10). See the instructions that come with the PC card reader/writer and the PC Card Adapter for information about how to use them.

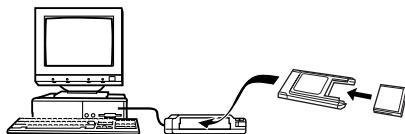

## Memory Card Data

Images recorded with this camera and other data is stored on the memory card using DCF (Design rule for Camera File system) protocol. DCF protocol is designed to make it easier to exchange image and other data between digital cameras and other devices.

## DCF Protocol

DCF devices (digital cameras, printers, etc.) can exchange images with each other. DCF protocol defines the format for image files data and the directory structure for the memory card, so images can be viewed using another manufacturer's DCF camera or printed on a DCF printer. In addition to support for the DCF protocol, your CASIO digital camera also use dates in image folder names and image file names, which helps to make data management easier.

## Memory Card File Structure

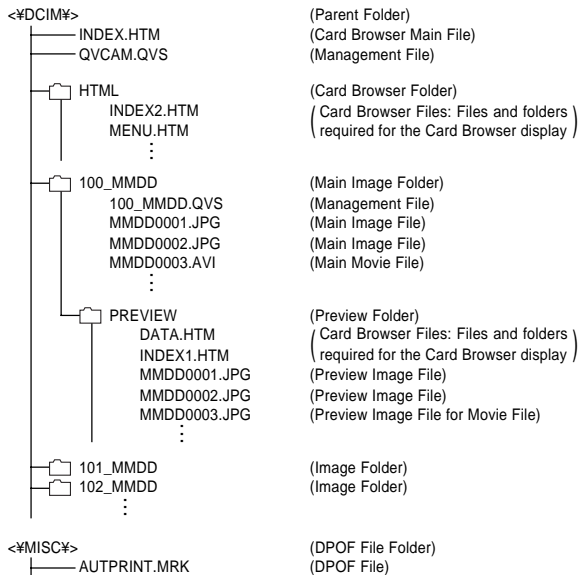

### Folder and File Contents

- Parent Folder  
Contents: All files used by the digital camera
- Card Browser Main File  
Contents: Template for card browser, which is used for viewing image previews with a web browser
- Management File  
Contents: Information about folder management, image sequence, etc.
- Card Browser Folder  
Contents: Files used by the card browser
- Card Browser File  
Contents: Data used by the card browser
- Main Image Folder  
Contents: Image files recorded by the camera
- Main Image File  
Contents: Still image file recorded by the camera
- Main Movie File  
Contents: Movie file recorded by the camera
- Preview Folder  
Contents: Preview images

- Preview Image File  
Contents: Preview images of still image and movie files used for temporary playback and card browser previews
- DPOF File Folder  
Contents: DPOF files

**NOTE**

- A memory card's actual file structure may differ somewhat in accordance with the type of Card Browser you are using (page E-130).

## Image Files Supported by the Camera

- Image files recorded with the CASIO QV-2300UX or QV-2800UX Digital Camera
- DCF protocol image files
- Image file containing an image with a maximum width of 1,600 pixels and maximum height of 1,200 pixels.
- Maximum image file size of 1 Mbytes.

Certain DCF functions may not be supported.

## Precautions when Using a Memory Card on a Computer

- This camera uses management files to manage the sequence and attributes of image files. Because of this, if you use your computer to modify or delete memory card files, to change management file contents, or to change image file sequence and attributes and then transfer the images back to the camera, you may end up with the wrong image sequence, ungrouped panorama images, and slow image scrolling.
- When transferring memory card contents to a hard disk, floppy diskette, MO disk, or other external storage, keep the contents of each DCIM folder together, and never use your computer to edit or delete the management files (those whose file names have the extension .QVS). Changing the name of the DCIM folder to a date is a good way to keep track of your images. However, be sure to change the name of this folder back to DCIM if you ever copy it back to the memory card for playback on the camera. The camera does not recognize any folder name besides DCIM.
- The above is also true about the names of folders inside the DCIM folder. These folders must be returned to the names assigned to them by the camera whenever you copy the folder back to the memory card for playback on the camera.



- We also strongly recommend that after transferring data from a memory card to other external storage that you reformat the memory card and delete its contents before using it to record more images.
- The camera formats memory cards using ATA format, which means that a Macintosh sees all memory card files as text files. To view memory card files on a Macintosh, use PC Exchange to associate the files on the memory card (which are JPEG files) with an application that is able to open JPEG files.



## Using the HTML Card Browser

The camera's Card Browser generates HTML files that let you see a table of image thumbnails for easy selection, and even view the properties of each image.

- Card Browser files can be viewed using the Web browsers listed below. Movie files require QuickTime.

Microsoft Internet Explorer 4.01 or later  
Netscape Communicator 4.5 or later

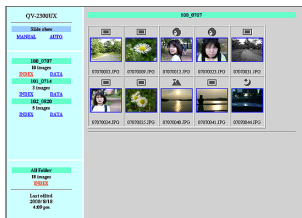

## Specifying the Card Browser Type

1. Enter the **REC** mode or **PLAY** mode.
2. Press **MENU**.
3. Select **"Card Browser"** using one of the following two key operations, and then press the shutter release button.

| If you are here | Select this on the menu screen         |
|-----------------|--|
| REC mode        | "FUNCTION" → "SET UP" → "Card Browser" |
| PLAY mode       | "SET UP" → "Card Browser"              |

#### 4. Select the Card Browser setting you want.

| When you want this  | Select this |
|---|-------------|
| To turn off the Card Browser (no HTML files generated)  | Off         |
| Maximum performance, including access to image properties and slideshow capabilities <ul style="list-style-type: none"> <li>This format uses high-level Java Script, and requires Microsoft Internet Explorer 4.01 or later or Netscape Communicator 4.5 or later.</li> </ul> | Type1       |
| Light image viewing with access to image properties   | Type2       |
| Basic image viewing with slideshow capabilities <ul style="list-style-type: none"> <li>This format uses high-level Java Script, and requires Microsoft Internet Explorer 4.01 or later or Netscape Communicator 4.5 or later.</li> </ul>                                      | Type3       |
| Basic image viewing   | Type4       |

#### 5. After selecting the setting you want, press the shutter release button.

- When a Card Browser type is selected, a file named "INDEX.HTM" is created inside the "DCIM" folder whenever you turn off the camera. Other files are also created and stored on the memory card at this time.
- Pressing  in place of the shutter release button in step 5 immediately starts creation of Card Browser files, which is indicated by the message "One moment please..." on the monitor screen. Never turn off camera power while this message is on the display.

#### NOTE

- If the memory card in the camera has a large number of files on it, it may take quite a bit of time for the camera to create the required HTML files and turn off. Because of this, we recommend that you normally leave the Card Browser turned off. We suggest that you turn off the Card Browser if you normally do not need to use it. The power down routine performed by the camera is much shorter when the Card Browser is turned off.

**IMPORTANT!**

- When the Card Browser is turned on, the monitor screen goes blank when you turn off the camera, but the operation lamp continues to flash for some time as the camera internally creates Card Browser files. Performing any of the operations listed below while the operation lamp is flashing not only stops creation of Card Browser files, it can also result in corruption of the image data on the memory card.
  - Opening the memory card slot cover
  - Unplugging the AC adaptor
  - Removing the camera's batteries
  - Other actions similar to those above
- Note that Card Browser files may be corrupted if batteries go low or if the memory card becomes full during file generation.
- You can specify the language for the Card Browser's on-screen text using the procedure under "Changing the Display Language" (page E-114).

**Viewing Card Browser File Contents**

Use your computer's Web Browser to view the contents of the Card Browser files.

- 1. Transfer the image data from the camera to your computer by cable (page E-122) or by accessing the memory card from your computer (page E-125).**
- 2. On the memory card, open the folder named "DCIM".**

### 3. Use your Web browser to open the file named "INDEX.HTM".

- This displays a gallery of thumbnails for all the images contained in the oldest image folder on the memory card.

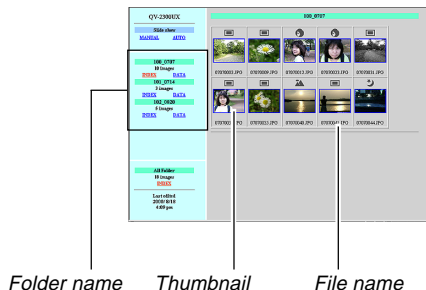

### 4. You can click the following items on the screen to perform the operations described below.

| To do this   | Click here |
|--|------------|
| Start an automatic slideshow of full-screen size images (5-second interval)    | AUTO       |
| Start a manual slideshow of full-screen size images (image changes with click) | MANUAL     |

- Tapping an image on the INDEX screen or DATA screen displays a 640 x 480-pixel version of the image. Clicking the full-screen images displays the image in the size at which it was recorded.

#### IMPORTANT!

- Slideshow images are displayed in full-screen size, regardless of the size at which they were recorded.
- The thumbnail gallery uses the contents of the Preview Folder (page E-127). Images copied from another digital camera or a computer do not have preview images associated with them, so their thumbnails do not appear in the thumbnail gallery. If this happens, scroll through the images on the camera's monitor screen until the copied image appears. At this time, the camera automatically generates a preview image, which will now appear in the Card Browser thumbnail gallery.

## CONNECTING TO EXTERNAL EQUIPMENT

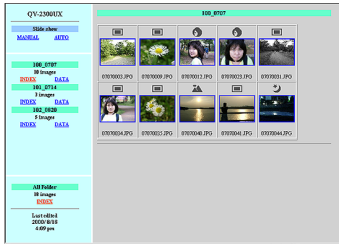

INDEX

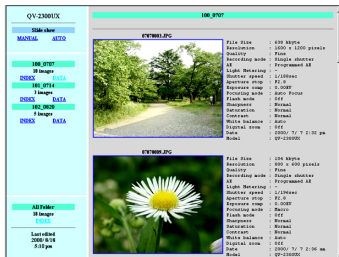

DATA

### • Image Properties

The following is the information provided by the Image Properties screen.

- File Size : File size
- Resolution : Resolution
- Quality : Quality
- Recording mode : Recording mode
- AE : Exposure mode
- Light metering : Metering mode
- Shutter speed : Shutter speed
- Aperture stop : Aperture stop
- Exposure comp : Exposure compensation
- Focusing mode : Focusing mode
- Flash mode : Flash mode
- Sharpness : Sharpness
- Saturation : Saturation
- Contrast : Contrast
- White balance : White balance
- Sensitivity : Sensitivity
- Filter : Filter setting
- Enhancement : Enhancement setting
- Flash intensity : Flash intensity
- Digital zoom : Digital zoom setting
- Date : Recording date and time
- Model : Camera model name

**5. To exit the Card Browser, simply quit your Web browser.**

## **Saving Card Browser Files**

- To save Card Browser files, use a USB cable connection (page E-123) or memory card transfer (page E-125) to copy the folder named “DCIM” on the memory card to a hard disk, floppy diskette, MO disk, or other external storage. Never use your computer to edit or delete files, to add new images, or to delete images. Doing so will make it impossible to view image normally using the Card Browser.
- Never edit or delete any of the files inside the “DCIM” folder. You can use the Photo Loader application contained on the bundled CD-ROM disc to save Card Browser files. See the documentation that comes with Photo Loader on the disc for full details.
- We also strongly recommend that after transferring data from a memory card to other external storage that you re-format the memory card and delete its contents before using it to record more images.

# REFERENCE

## Camera Menus

The following shows lists of menus that appear in the REC mode and PLAY mode, and their settings.

- The settings that are underlined in the following table are initial defaults.
- “○” indicates items that can be included as part of a short-cut (page E-91).

## REC mode

|              |              |   |   |
|--------------|--------------|---|---|
| NORMAL       |              |   |   |
| PORTRAIT     |              |   |   |
| LANDSCAPE    |              |   |   |
| NIGHT SCENE  |              |   |   |
| SCENE        |              |   |   |
| MOVIE        |              |   |   |
| MOVIE (PAST) |              |   |   |
| PANORAMA     |              |   |   |
| INTERVAL     |              |   |   |
| FUNCTION     | Size/Quality | 1600 x 1200 / <u>Fine</u><br>1600 x 1200 / Normal<br>1600 x 1200 / Economy<br>800 x 600 / Fine<br>800 x 600 / Normal<br>800 x 600 / Economy | ○ |

|               |                 |   |                 |   |
|---------------|-----------------|---|-----------------|---|
| FUNCTION      | Sensitivity     | ISO <u>80</u> / ISO 160 / ISO 320   | ○               |   |
|               | Filter          | <u>Off</u> / B/W / Sepia / Red / Green / Blue / Yellow / Pink / Purple                  | ○               |   |
|               | Exposure Mode   | <u>P</u> / A / S / M  | ○               |   |
|               | Metering        | <u>Multi</u> / Center / Spot  | ○               |   |
|               | White Balance   | <u>Auto</u> / Daylight / Shade / Tungsten / Fluorescent / Manual                        | ○               |   |
|               | Enhancement     | <u>Off</u> / Red / Green / Blue / Flesh Tones   | ○               |   |
|               | Grid            | <u>Off</u> / On   | ○               |   |
|               | Flash Intensity | Strong / <u>Normal</u> / Weak   | ○               |   |
|               | Sharpness       | Hard / <u>Normal</u> / Soft   | ○               |   |
|               | Saturation      | High / <u>Normal</u> / Low  | ○               |   |
|               | Contrast        | High / <u>Normal</u> / Low  | ○               |   |
|               | Time Stamp      | <u>Off</u><br>Year / Month / Day<br>Day Hour:Minutes<br>Year / Month / Day Hour:Minutes | ○               |   |
|               | Digital Zoom    | Off / <u>Auto</u> / X2 / X4   | ○               |   |
|               | Sleep           | Off / 30sec / <u>1min</u> / 2min  | ○               |   |
|               | Auto Power Off  | <u>2min</u> / 5min  | ○               |   |
|               | Mode Memory     | Recording Mode  | <u>Off</u> / On | ○ |
|               |                 | Sensitivity   | <u>Off</u> / On | ○ |
|               |                 | Exposure Mode   | <u>Off</u> / On | ○ |
|               |                 | Metering  | <u>Off</u> / On | ○ |
| White Balance |                 | <u>Off</u> / On   | ○               |   |
| Flash         | Off / <u>On</u> | ○   |                 |   |



|          |             |                 |  |   |
|----------|-------------|-----------------|--|---|
| FUNCTION | Mode Memory | Focus           | Off / On   | ○ |
|          |             | Digital Zoom    | Off / <u>Qn</u>  | ○ |
|          |             | Flash Intensity | Off / On   | ○ |
|          | SET UP      | Indicators      | Off / <u>Qn</u>  | ○ |
|          |             | Card Browser    | Off /<br>Type1 / Type2 /<br>Type3 / Type4                      | ○ |
|          |             | Beep            | Off / <u>Qn</u>  | ○ |
|          |             | Date Style      | Year / Month / Day<br>Day / Month / Year<br>Month / Day / Year | ○ |
|          |             | Date / Time     | Time setting   | ○ |
|          |             | Language        | English / Japanese   | ○ |
|          |             | Format          | No / Yes   | ○ |
|          |             | VIDEO OUT       | NTSC / PAL   | ○ |
|          |             | LINK*           | Off / Mode1 /<br>Mode2 / Mode3                                 | ○ |
|          |             | Restore         | No / Yes   | ○ |

\* This function is not available with this model.

## PLAY mode

|            |                       |  |
|------------|-----------------------|--|
| ZOOM       |                       |  |
| DELETE     | Select / Folder / All |  |
| DPOF       | Select / Folder / All |  |
| PROTECT    | Select / Folder / All |  |
| SLIDE SHOW |                       |  |
| SET UP     | Indicators            | Off / <u>Qn</u>  |
|            | Card Browser          | Off / Type1 / Type2 /<br>Type3 / Type4                         |
|            | Beep                  | Off / <u>Qn</u>  |
|            | Date Style            | Year / Month / Day<br>Day / Month / Year<br>Month / Day / Year |
|            | Date / Time           | Time setting   |
|            | Language              | English / Japanese   |
|            | Format                | No / Yes   |
|            | VIDEO OUT             | NTSC / PAL   |
|            | LINK*                 | Off / Mode1 / Mode2 /<br>Mode3                                 |
|            | Restore               | No / Yes   |

\* This function is not available with this model.

## Scene List

The following list shows all of the scenes that are available in the Scene Mode.

| No. | Scene                   | Remarks   |
|-----|-------------------------|---|
| 1   | Landscape with People   | Displays a composing frame.   |
| 2   | Landscape with People   | Displays a composing frame.   |
| 3   | Face                    | Displays a composing frame. Blurs the background.   |
| 4   | Face and Chest          | Displays a composing frame. Blurs the background.   |
| 5   | Full Front              | Displays a composing frame. Blurs the background.   |
| 6   | Two Subjects            | Displays a composing frame. Blurs the background.   |
| 7   | Floral Close Up         | Macro Mode with high saturation   |
| 8   | Flower Field            | High saturation   |
| 9   | Forest                  | Hard sharpness, high saturation, enhanced greens  |
| 10  | Autumn Leaves           | Hard sharpness, high saturation, enhanced reds  |
| 11  | Blue sky                | $\infty$ focus, enhanced blues  |
| 12  | Sunset                  | $\infty$ focus, red filter, daylight white balance  |
| 13  | Bright Beach            | Enhanced blues  |
| 14  | Night Scene             | Slow shutter speed, $\infty$ focus, daylight white balance Use of a tripod recommended.           |
| 15  | Night Scene with People | Slow shutter speed, flash on, daylight white balance Use of a tripod recommended.                 |
| 16  | Night Scene with People | Slow shutter speed, flash on, daylight white balance Use of a tripod recommended.                 |
| 17  | Fireworks               | Small aperture, bulb shutter, $\infty$ focus, daylight white balance Use of a tripod recommended. |
| 18  | Dancing Lights          | Small aperture, bulb shutter, $\infty$ focus, daylight white balance Use of a tripod recommended. |
| 19  | Flowing Water – Soft    | Slow shutter speed On an overcast day, use an ND filter.  |
| 20  | Flowing Water – Stopped | Fast shutter speed Dim lighting may result in underexposure.                                      |
| 21  | Stopped Action          | Fast shutter speed Dim lighting may result in underexposure.                                      |

## REFERENCE

| No. | Scene                          | Remarks   |
|-----|--------------------------------|---|
| 22  | Structures                     | Hard sharpness  |
| 23  | Food                           | Macro Mode with high saturation                       |
| 24  | Text                           | Macro mode, B/W filter, hard sharpness, high contrast |
| 25  | Special Effects 1              | Blue filter   |
| 26  | Special Effects 2 (Night Mood) | Negative EV shift, blue filter                        |
| 27  | Special Effects 3              | High contrast, B/W filter                             |
| 28  | Special Effects 4              | Low contrast, sepia filter                            |
| 29  | User Setup                     | Records images using a set up you saved.              |
| 30  | User Setup                     | Records images using a set up you saved.              |
| 31  | User Setup                     | Records images using a set up you saved.              |

## Scene Mode Camera Setups

| No. | Settings     |               |          |          |             |        |               |          |
|-----|--------------|---------------|----------|----------|-------------|--------|---------------|----------|
|     | Focus Mode   | Shutter Speed | Aperture | EV Shift | Sensitivity | Filter | Exposure Mode | Metering |
| 1   | Auto Focus   | Auto          | Auto     | 0        | ISO 80      | Off    | P             | Multi    |
| 2   | Auto Focus   | Auto          | Auto     | 0        | ISO 80      | Off    | P             | Multi    |
| 3   | Auto Focus   | Auto          | Auto     | 0        | ISO 80      | Off    | P             | Multi    |
| 4   | Auto Focus   | Auto          | Auto     | 0        | ISO 80      | Off    | P             | Multi    |
| 5   | Auto Focus   | Auto          | Auto     | 0        | ISO 80      | Off    | P             | Multi    |
| 6   | Auto Focus   | Auto          | Auto     | 0        | ISO 80      | Off    | P             | Multi    |
| 7   | ☑ (Macro)    | Auto          | Auto     | 0        | ISO 80      | Off    | P             | Multi    |
| 8   | Auto Focus   | Auto          | Auto     | 0        | ISO 80      | Off    | P             | Multi    |
| 9   | Auto Focus   | Auto          | Auto     | -0.7     | ISO 80      | Off    | P             | Center   |
| 10  | Auto Focus   | Auto          | Auto     | 0        | ISO 80      | Off    | P             | Multi    |
| 11  | ∞ (Infinity) | Auto          | Auto     | 0        | ISO 80      | Off    | P             | Multi    |
| 12  | ∞ (Infinity) | Auto          | Auto     | 0        | ISO 80      | Red    | P             | Multi    |
| 13  | Auto Focus   | Auto          | Auto     | +0.7     | ISO 80      | Off    | P             | Center   |
| 14  | ∞ (Infinity) | Auto          | Auto     | 0        | ISO 160     | Off    | P             | Center   |
| 15  | Auto Focus   | Auto          | Auto     | 0        | ISO 80      | Off    | P             | Center   |
| 16  | Auto Focus   | Auto          | Auto     | 0        | ISO 80      | Off    | P             | Center   |
| 17  | ∞ (Infinity) | BULB          | Small    | 0        | ISO 80      | Off    | M             | Center   |
| 18  | ∞ (Infinity) | BULB          | Small    | 0        | ISO 80      | Off    | M             | Center   |
| 19  | Auto Focus   | 1/30          | Auto     | 0        | ISO 80      | Off    | S             | Center   |
| 20  | Auto Focus   | 1/1000        | Auto     | 0        | ISO 80      | Off    | S             | Center   |
| 21  | Auto Focus   | 1/1000        | Auto     | 0        | ISO 80      | Off    | S             | Center   |
| 22  | Auto Focus   | Auto          | Auto     | 0        | ISO 80      | Off    | P             | Multi    |
| 23  | ☑ (Macro)    | Auto          | Auto     | 0        | ISO 80      | Off    | P             | Multi    |
| 24  | ☑ (Macro)    | Auto          | Auto     | +1       | ISO 80      | B/W    | P             | Center   |
| 25  | Auto Focus   | Auto          | Auto     | 0        | ISO 80      | Blue   | P             | Multi    |
| 26  | Auto Focus   | Auto          | Auto     | -2       | ISO 80      | Blue   | P             | Center   |
| 27  | Auto Focus   | Auto          | Auto     | 0        | ISO 80      | B/W    | P             | Multi    |
| 28  | Auto Focus   | Auto          | Auto     | 0        | ISO 80      | Sepia  | P             | Multi    |
| 29  |              |               |          |          |             |        |               |          |
| 30  |              |               |          |          |             |        |               |          |
| 31  |              |               |          |          |             |        |               |          |

## REFERENCE

| No. | Settings      |             |                 |           |            |          |            |                     |
|-----|---------------|-------------|-----------------|-----------|------------|----------|------------|---------------------|
|     | White Balance | Enhancement | Flash Intensity | Sharpness | Saturation | Contrast | Flash Mode | Composition Outline |
| 1   | Auto          | Off         | Normal          | Normal    | Normal     | Normal   | Auto       | Yes                 |
| 2   | Auto          | Off         | Normal          | Normal    | Normal     | Normal   | Auto       | Yes                 |
| 3   | Auto          | Flesh Tones | Normal          | Soft      | Normal     | Normal   | Auto       | Yes                 |
| 4   | Auto          | Flesh Tones | Normal          | Soft      | Normal     | Normal   | Auto       | Yes                 |
| 5   | Auto          | Flesh Tones | Normal          | Soft      | Normal     | Normal   | Auto       | Yes                 |
| 6   | Auto          | Flesh Tones | Normal          | Normal    | Normal     | Normal   | Auto       | Yes                 |
| 7   | Auto          | Off         | Weak            | Normal    | High       | Normal   | Auto       | No                  |
| 8   | Auto          | Off         | Normal          | Normal    | High       | Normal   | Auto       | No                  |
| 9   | Auto          | Green       | Normal          | Hard      | High       | Normal   | Auto       | No                  |
| 10  | Auto          | Red         | Normal          | Hard      | High       | Normal   | Auto       | No                  |
| 11  | Auto          | Blue        | Normal          | Normal    | Normal     | Normal   | Auto       | No                  |
| 12  | Daylight      | Off         | Normal          | Normal    | High       | Normal   | Auto       | No                  |
| 13  | Auto          | Blue        | Normal          | Normal    | Normal     | Normal   | Auto       | No                  |
| 14  | Daylight      | Off         | Normal          | Normal    | Normal     | Normal   | ☒ (Off)    | No                  |
| 15  | Daylight      | Off         | Normal          | Normal    | Normal     | Normal   | ☒ (On)     | Yes                 |
| 16  | Daylight      | Off         | Normal          | Normal    | Normal     | Normal   | ☒ (On)     | Yes                 |
| 17  | Daylight      | Off         | Normal          | Normal    | Normal     | Normal   | ☒ (Off)    | No                  |
| 18  | Daylight      | Off         | Normal          | Normal    | Normal     | Normal   | ☒ (Off)    | No                  |
| 19  | Auto          | Off         | Normal          | Normal    | Normal     | Normal   | ☒ (Off)    | No                  |
| 20  | Auto          | Off         | Normal          | Hard      | Normal     | Normal   | Auto       | No                  |
| 21  | Auto          | Off         | Normal          | Normal    | Normal     | Normal   | Auto       | No                  |
| 22  | Auto          | Off         | Normal          | Hard      | Normal     | Normal   | Auto       | No                  |
| 23  | Auto          | Off         | Weak            | Normal    | High       | Normal   | Auto       | No                  |
| 24  | Auto          | Off         | Normal          | Hard      | Normal     | High     | ☒ (Off)    | No                  |
| 25  | Auto          | Off         | Normal          | Normal    | Normal     | Normal   | Auto       | No                  |
| 26  | Auto          | Off         | Normal          | Normal    | Normal     | Normal   | Auto       | No                  |
| 27  | Auto          | Off         | Normal          | Normal    | Normal     | High     | Auto       | No                  |
| 28  | Auto          | Off         | Normal          | Normal    | Normal     | Low      | Auto       | No                  |
| 29  |               |             |                 |           |            |          |            |                     |
| 30  |               |             |                 |           |            |          |            |                     |
| 31  |               |             |                 |           |            |          |            |                     |

## Mode Settings

## Settings in Each Mode

○ : Available   △ : Partially available   – : Not available

|                |                | Partial Shutter Release Button Press |         | Flash Mode | Self-timer | Focus Frame Display |
|----------------|----------------|--------------------------------------|---------|------------|------------|---------------------|
|                |                | AF Lock                              | AE Lock |            |            |                     |
| Recording Mode | Normal         | ○                                    | ○       | ○          | ○          | ○                   |
|                | Portrait       | ○                                    | ○       | ○          | ○          | ○                   |
|                | Landscape      | ○                                    | ○       | ○          | ○          | ○                   |
|                | Night Scene    | ○                                    | ○       | ○          | ○          | ○                   |
|                | Scene          | ○                                    | ○       | ○          | ○          | ○                   |
|                | Movie (Normal) | ×                                    | ×       | ×          | ○          | ×                   |
|                | Movie (Past)   | ×                                    | ×       | ×          | ×          | ×                   |
|                | Panorama       | ○                                    | ○       | ○          | ○          | ○                   |
|                | Interval       | ○                                    | ○       | ○          | ×          | ○                   |
| Exposure Mode  | P Mode         | ○                                    | ○       | ○          | ○          | ○                   |
|                | A Mode         | ○                                    | ○       | ○          | ○          | ○                   |
|                | S Mode         | ○                                    | ○       | ○          | △          | ○                   |
|                | M Mode         | ○                                    | ○       | ○          | △          | ○                   |

△ : The camera will not enter the Self-timer Mode while the shutter speed is set to "BULB".

## Recording Mode + Exposure Mode Combinations

The following table shows to what extent each recording mode can be used in combination with each exposure mode.

○ : Available   △ : Partially available   – : Not available

|                |                | Exposure Mode |        |        |        |
|----------------|----------------|---------------|--------|--------|--------|
|                |                | P Mode        | A Mode | S Mode | M Mode |
| Recording Mode | Normal         | ○             | ○      | ○      | ○      |
|                | Portrait       | ○             | ○      | ○      | ○      |
|                | Landscape      | ○             | ○      | ○      | ○      |
|                | Night Scene    | ○             | ○      | ○      | ○      |
|                | Scene          | ○             | ○      | ○      | ○      |
|                | Movie (Normal) | ○             | ○      | ×      | ×      |
|                | Movie (Past)   | ○             | ○      | ×      | ×      |
|                | Panorama       | ○             | ○      | ○      | ○      |
|                | Interval       | ○             | ○      | △      | △      |

△ : Entering the Interval Mode while "BULB" is selected as the shutter speed automatically changes the shutter speed to 1 second.

## Troubleshooting

|              | Symptom   | Probable Cause   | Action  |
|--------------|---|--|---|
| Power Supply | No power  | <ol style="list-style-type: none"> <li>1. Batteries are not oriented correctly.</li> <li>2. Batteries are dead.</li> <li>3. Using the wrong AC adaptor.</li> </ol>   | <ol style="list-style-type: none"> <li>1. Load batteries correctly (page E-31).</li> <li>2. Replace batteries with a full set of new ones (page E-31).</li> <li>3. Use only the specified AC adaptor.</li> </ol>  |
|              | Sudden loss of power  | <ol style="list-style-type: none"> <li>1. Activation of Auto Power Off (page E-36).</li> <li>2. Dead batteries</li> </ol>  | <ol style="list-style-type: none"> <li>1. Turn power back on.</li> <li>2. Replace batteries with a full set of new ones (page E-31).</li> </ol>   |
|              |  indicator on the monitor screen | Batteries are low.   | Replace batteries with a full set of new ones (page E-31).  |
| Recording    | No recording when the shutter release button is pressed   | <ol style="list-style-type: none"> <li>1. The REC/PLAY selector is set to "PLAY".</li> <li>2. Flash unit is charging.</li> <li>3. The message "MEMORY FULL" is on the monitor screen.</li> <li>4. No memory card loaded in the camera</li> </ol> | <ol style="list-style-type: none"> <li>1. Slide to REC/PLAY selector to "REC".</li> <li>2. Wait until flash unit charging is finished.</li> <li>3. Delete images you no longer need from camera memory or change to another memory card.</li> <li>4. Load a memory card.</li> </ol> |
|              | Unable to focus properly with Auto Focus  | <ol style="list-style-type: none"> <li>1. Dirty lens</li> <li>2. Subject is outside the focus frame.</li> <li>3. Conditions make it impossible to obtain proper focus.</li> <li>4. Camera is unsteady or shaking.</li> </ol>                     | <ol style="list-style-type: none"> <li>1. Clean the lens.</li> <li>2. Compose the image so the subject is inside the focus frame.</li> <li>3. Switch to the Manual Mode and focus manually (page E-57).</li> <li>4. Use a tripod.</li> </ol>  |
|              | Recorded image is blurred.  | Improper focus   | Make sure the subject on which you want to focus is inside the focus frame.   |



## REFERENCE

|                  | Symptom   | Probable Cause  | Action  |
|------------------|---|---|---|
| <b>Recording</b> | Power failure during self-timer operation.  | Batteries are dead.   | Replace batteries with a full set of new ones (page E-31).  |
|                  | Monitor screen image is out of focus.   | <ol style="list-style-type: none"> <li>Poor focusing in the manual focus mode.</li> <li>Attempting to record scenery or portraits in the Macro Mode.</li> <li>Attempting to use the Auto Focus mode for a subject that is too close.</li> </ol> | <ol style="list-style-type: none"> <li>Focus the image (page E-57).</li> <li>Use Auto Focus for scenery and portraits.</li> <li>Use the Macro Mode for close ups.</li> </ol>            |
|                  | Recorded image is not saved.  | <ol style="list-style-type: none"> <li>Batteries going low before the image save operation is complete.</li> <li>Opening of the memory card slot cover before the image save operation is complete.</li> </ol>                                  | <ol style="list-style-type: none"> <li>Replace batteries with a full set of new ones.</li> <li>Keep the memory card cover closed until the image save operation is complete.</li> </ol> |
| <b>Playback</b>  | Colors of recorded image are different from those on the monitor screen.            | <ol style="list-style-type: none"> <li>Direct sunlight or light from another source shining into the lens.</li> <li>Image quality setting</li> </ol>  | <ol style="list-style-type: none"> <li>Reorient the camera so that light is not shining directly into lens.</li> <li>Change to a higher image quality for recording.</li> </ol>         |
|                  | [+] and [-] operations do not work while the 9-image view is on the monitor screen. | You are operating the [+] and [-] buttons while the scroll operation is still being performed.  | Wait until image scrolling is complete before pressing [+] or [-].  |
|                  | Cannot display a particular image.  | Memory card images recording using a camera that does not support DCF.  | The file management systems of cameras that do not support DCF are different from the one used by this camera. This camera cannot read cards recorded with such cameras.                |

## REFERENCE

|          | Symptom  | Probable Cause   | Action   |
|----------|--|--|--|
| Playback | Monitor screen contents do not appear on the screen of a connected TV. | <ol style="list-style-type: none"> <li>1. Incorrect camera-TV connection</li> <li>2. Wrong TV settings</li> <li>3. Wrong video signal output mode</li> </ol>                     | <ol style="list-style-type: none"> <li>1. Connect correctly using the video cable (page E-117).</li> <li>2. Check the documentation that comes with the TV and set it up correctly for video input.</li> <li>3. Select the video output mode that suits the type of equipment you are using (page E-118).</li> </ol> |
|          | Cannot access the delete screen.                                       | All images on the memory card are protected.   | Unprotect the images you want to delete (page E-107).  |
| Other    | Cannot select menu items in the PLAY mode.                             | <ol style="list-style-type: none"> <li>1. Some functions cannot be selected for playback of certain types of images.</li> <li>2. No images stored on the memory card.</li> </ol> | <ol style="list-style-type: none"> <li>1. Select a different function or change to another image.</li> <li>2. Record an image to make the functions available.</li> </ol>  |
|          | All buttons and switches are dead.                                     | Circuit damage due to static electrical charge from connected device or due to strong impact.  | Remove batteries and disconnect the AC adaptor if you are using one. Restore power and turn the camera on. If this does not work, contact your dealer or an authorized CASIO service provider.   |
|          | Nothing appears on the monitor screen.                                 | <ol style="list-style-type: none"> <li>1. The monitor is asleep.</li> <li>2. Communication over the USB cable is in progress.</li> </ol>   | <ol style="list-style-type: none"> <li>1. Wake up the monitor (page E-36).</li> <li>2. After the communication operation over the USB cable is complete, unplug the USB cable from the camera.</li> </ol>  |

## Messages

**RECORD ERROR** Some problem occurred when compressing image data to save it on the memory card. Shoot the image again.

**There are no images on this memory card!** There is no image data stored on the memory card.

**This camera cannot display the image you selected!** The image file you are trying to view is corrupted, or it was recorded with a camera whose image file format is not supported by this camera.

**REPLACE BATTERY!** Battery power is low. Camera power turns off automatically shortly after this message appears.

**NO FORMAT → MENU** The memory card you are using is not formatted. You must format the memory card before you can use it to store images (page E-40).

**CF ERROR** There is some problem with the memory card you are using. Perform the following procedure to correct the problem.

**You must format the CompactFlash card before using it with this camera.**

**FORMAT → MENU**

### Warning!

The following procedure deletes all files currently stored on the memory card. Before proceeding, try to back up the contents of the memory card onto your computer's hard disk drive or some other type of external storage medium.

1. Press MENU.



2. Use [+] and [-] to select "Yes", and then press the shutter release button.

- To cancel this procedure, press MENU.
- Whenever formatting a memory card, be sure to use the AC adaptor to power the camera or replace its batteries with a full set of new alkaline or lithium batteries before starting. Unexpected loss of power can result in incomplete formatting and improper operation of the memory card.
- The message "There are no images on this memory card!" appears on the monitor screen after formatting is complete.



### Insert memory card!

There is no memory card loaded in the camera. Load a memory card (page E-38).

### MEMORY FULL Change quality or delete unneeded images

There is not enough memory to record an image with your current quality and size settings. Change the image quality and size settings and try again, or delete some images from the memory card (page E-101).

---

**MEMORY FULL**  
**Delete unneeded**  
**images**

- There is not enough memory for further recording. Delete some images you don't need from memory card (page E-101).
  - The DCIM folder or other file (page E-127) cannot be created due to insufficient memory when downloading data from a computer to the memory card. Use your computer to delete unneeded images to free up memory card space for the images you are downloading. You could also press the MENU button and format the memory card in the camera, but doing so deletes all image files currently stored on the memory card.
-

## Specifications

**Description** ..... Digital camera

**Model** ..... QV-2300UX/QV-2800UX

### Recorded Image

**File Format** ..... Still images (including panoramas):  
JPEG (Exif. Ver. 2.1), DCF standard  
(Design rule for Camera File system),  
DPOF compatible, Movies: AVI

**Recording Medium** ..... CompactFlash card (Type I/II)

**Recorded Image Size** ..... 1600 x 1200 pixels, 800 x 600 pixels

### Standard Memory Capacity, Number of Image Files, Computer Output Image Size

| Still               |         |              |                  |                  |                  |
|---------------------|---------|--------------|------------------|------------------|------------------|
| Image size (pixels) | Quality | File size    | Number of images |                  |                  |
|                     |         |              | 8MB memory card  | 64MB memory card | 340MB Microdrive |
| 1600 x 1200         | FINE    | 850 KB/image | 8 images         | 71 images        | 401 images       |
|                     | NORMAL  | 600 KB/image | 11 images        | 99 images        | 562 images       |
|                     | ECONOMY | 350 KB/image | 19 images        | 167 images       | 943 images       |
| 800 x 600           | FINE    | 200 KB/image | 33 images        | 282 images       | 1587 images      |
|                     | NORMAL  | 150 KB/image | 43 images        | 365 images       | 2054 images      |
|                     | ECONOMY | 120 KB/image | 53 images        | 443 images       | 2494 images      |

| Movie            |                            |
|------------------|----------------------------|
| Storage Capacity | Approximately 300KB/second |
| Recording Time   | 16 seconds per movie       |

- The above figures are approximations only.

**Image Deletion** ..... Single image; all images in a folder; all images in memory (with image protection)

**Imaging Element** ..... 1/2.7-inch CCD (Total Pixels: 2.11 million, Effective Pixels; 2.02 million)

**Lens** ..... • QV-2300UX  
F2.8 to 4.5; f = 6.2 to 18.6mm (equivalent to 41 to 123mm lens for 35mm film)  
• QV-2800UX  
F3.2 to 3.5; f = 6 to 48mm (equivalent to 40 to 320mm lens for 35mm film)

**Zoom** ..... • QV-2300UX  
Optical zoom, 3X; Digital zoom: 12X (in combination with optical zoom)  
• QV-2800UX  
Optical zoom, 8X; Digital zoom: 32X (in combination with optical zoom)  
Image size is 800 x 600 pixels when 4X digital zoom is used.

**Focusing** ..... Contrast-detect Auto Focus; manual focus with macro mode and focus lock

**Focus Range** ..... • QV-2300UX  
Normal focus: 10cm to ∞ (1X zoom)  
50cm to ∞ (3X zoom)  
Macro focus: 1cm to 50cm (1X zoom)  
Manual focus: 1cm to ∞ (1X zoom)  
50cm to ∞ (3X zoom)

## REFERENCE

- QV-2800UX  
Normal focus: 40cm to ∞ (1X zoom)  
1m to ∞ (8X zoom)
  - Macro focus: 1cm to 50cm  
(1 to 1.6X zoom)
  - Manual focus: 1cm to ∞ (1X zoom)  
1m to ∞ (8X zoom)
- The focusing range is the distance from the lens surface to the subject.

### Exposure Control

- Light Metering: ..... Multi-pattern, center point, spot by CCD
- Exposure: ..... Program AE, Aperture priority AE, Shutter priority AE
- Exposure Compensation: ..... -2EV to +2EV (1/3EV units)

**Shutter** ..... CCD electronic shutter; mechanical shutter, BULB, 60 to 1/2000 second

**Aperture** ..... • QV-2300UX  
F2.8, F5.6, auto switching or manual switching

• QV-2800UX  
F3.2, F4.8, F8, auto switching or manual switching

**White Balance** ..... Automatic, fixed (4 modes), manual switching

**Self-timer** ..... 10 seconds, 2 seconds

### Built-in Flash

- Flash Modes: ..... AUTO, OFF, ON, Red eye reduction
- Flash Range: ..... • QV-2300UX  
Approximately 0.5 to 2 meters
- QV-2800UX  
Approximately 0.5 to 2.5 meters

**Recording Functions** ..... Normal, movie, panorama, landscape, night scene, portrait, self-timer, macro, scene

**Monitor** ..... 1.8" TFT, low-glare color HAST LCD (122,100 pixels, 555 x 220)

**Viewfinder** ..... LCD Monitor or optical viewfinder

**Clock** ..... Built-in quartz digital timepiece for time and date recording and storage with image data; auto calendar up to 2049

**Input/Output Terminals** .... DIGITAL IN/OUT, USB port (special mini port), AC adaptor connector, VIDEO OUT (NTSC, PAL), External flash sync terminal (QV-2800UX)

**Power Supply** ..... Four AA-size alkaline or lithium batteries  
Four AA-size nickel-metal hydride rechargeable batteries (NP-H3)  
AC adaptor (AD-C620)  
AC adaptor charger (BC-3HA)

### Battery Life

The values noted below indicate the number of hours before battery failure under normal operating temperature (25°C). These values are for reference only, and do not guarantee that any particular set of batteries actually will provide the service life indicated. Low temperatures shorten battery life.

| Type of Operation    | AA-size Alkaline Batteries LR6 | AA-size Lithium Batteries FR6 | AA-size Ni-MH Batteries NP-H3 |
|----------------------|--------------------------------|-------------------------------|-------------------------------|
| Continuous Playback  | 170 minutes                    | 300 minutes                   | 180 minutes                   |
| Continuous Recording | 80 minutes (480 shots)         | 200 minutes (1200 shots)      | 120 minutes (720 shots)       |

- The above figures are approximations only.
- The above guidelines are based on the following battery types:  
 Alkaline: MX1500 (AA) DURACELL ULTRA  
 Lithium: Energizer
- Battery life varies with brand.

Continuous recording values show the number of shots without using the flash. The number of shots depends on use of the flash and whether flash is turned on or off.

- Power Consumption** ..... • QV-2300UX Approximately 5.3W  
 • QV-2800UX Approximately 5.8W
- Dimensions** ..... • QV-2300UX 118(W) x 67(H) x 54(D) mm  
 • QV-2800UX 121(W) x 80.5(H) x 66(D) mm
- Weight** ..... • QV-2300UX Approximately 245g  
 • QV-2800UX Approximately 295g (excluding batteries)
- Standard Accessories** ..... 8MB CompactFlash memory card, Strap; lens cap; cap holder; soft case; USB cable; video cable; data transfer cable; CD-ROM; four LR6 alkaline batteries; Basic Reference, Bundled Software User's Manual; Soft case strap (QV-2800UX); Wired remote controller (QV-2800UX)

- This camera does not have a separate battery to power its clock. Clock settings are cleared whenever power to the camera is cut off (by batteries going dead while the camera is not connected to an AC power outlet with the AC adaptor) for about 24 hours. After power is resumed, either by loading fresh batteries or connecting to an AC power outlet, you will have to set the correct time and date again.
- The liquid crystal panel built into this camera is the product of precision engineering, with a pixel yield of 99.99%. This also means, however that 0.01% of the pixels can be expected to fail to light or to remain lit at all times.

## Free Manuals Download Website

<http://myh66.com>

<http://usermanuals.us>

<http://www.somanuals.com>

<http://www.4manuals.cc>

<http://www.manual-lib.com>

<http://www.404manual.com>

<http://www.luxmanual.com>

<http://aubethermostatmanual.com>

Golf course search by state

<http://golfingnear.com>

Email search by domain

<http://emailbydomain.com>

Auto manuals search

<http://auto.somanuals.com>

TV manuals search

<http://tv.somanuals.com>