

# CTK-2090 CTK-2400

EN/ES

English

Español

## USER'S GUIDE

Please keep all information for future reference.

### Safety Precautions

Before trying to use the Digital Keyboard, be sure to read the separate "Safety Precautions".

## GUÍA DEL USUARIO

Guarde toda información para tener como referencia futura.

### Precauciones de seguridad

Antes de intentar usar el teclado digital, asegúrese de leer las "Precauciones de seguridad" separadas.

CTK2400-ES-1A

**CASIO**<sup>®</sup>

## NOTICE

This equipment has been tested and found to comply with the limits for a Class B digital device, pursuant to Part 15 of the FCC Rules. These limits are designed to provide reasonable protection against harmful interference in a residential installation. This equipment generates, uses and can radiate radio frequency energy and, if not installed and used in accordance with the instructions, may cause harmful interference to radio communications. However, there is no guarantee that interference will not occur in a particular installation. If this equipment does cause harmful interference to radio or television reception, which can be determined by turning the equipment off and on, the user is encouraged to try to correct the interference by one or more of the following measures:

- Reorient or relocate the receiving antenna.
- Increase the separation between the equipment and receiver.
- Connect the equipment into an outlet on a circuit different from that to which the receiver is connected.
- Consult the dealer or an experienced radio/TV technician for help.

## FCC CAUTION

Changes or modifications not expressly approved by the party responsible for compliance could void the user's authority to operate the equipment.

## Declaration of Conformity

Model Number: CTK-2090/CTK-2400

Trade Name: CASIO COMPUTER CO., LTD.

Responsible party: CASIO AMERICA, INC.

Address: 570 MT. PLEASANT AVENUE, DOVER, NEW JERSEY 07801

Telephone number: 973-361-5400

This device complies with Part 15 of the FCC Rules, Operation is subject to the following two conditions:

(1) This device may not cause harmful interference, and (2) this device must accept any interference received, including interference that may cause undesired operation.

## Important!

Please note the following important information before using this product.

- Before using the optional AD-E95100L Adaptor to power the unit, be sure to check the AC Adaptor for any damage first. Carefully check the power cord for breakage, cuts, exposed wire and other serious damage. Never let children use an AC adaptor that is seriously damaged.
- Never attempt to recharge batteries.
- Do not use rechargeable batteries.
- Never mix old batteries with new ones.
- Use recommended batteries or equivalent types.
- Always make sure that positive (+) and negative (-) poles are facing correctly as indicated near the battery compartment.
- Replace batteries as soon as possible after any sign they are getting weak.
- Do not short-circuit the battery terminals.
- The product is not intended for children under 3 years.
- Use only CASIO AD-E95100L adaptor.
- The AC adaptor is not a toy.
- Be sure to disconnect the AC adaptor before cleaning the product.



This mark applies in EU countries only.



Manufacturer:

CASIO COMPUTER CO., LTD.

6-2, Hon-machi 1-chome, Shibuya-ku, Tokyo 151-8543, Japan

Responsible within the European Union:

CASIO EUROPE GmbH

Casio-Platz 1, 22848 Norderstedt, Germany

- Any reproduction of the contents of this manual, either in part or its entirety, is prohibited. Except for your own, personal use, any other use of the contents of this manual without the consent of CASIO is prohibited under copyright laws.
- IN NO EVENT SHALL CASIO BE LIABLE FOR ANY DAMAGES WHATSOEVER (INCLUDING, WITHOUT LIMITATION, DAMAGES FOR LOSS OF PROFITS, BUSINESS INTERRUPTION, LOSS OF INFORMATION) ARISING OUT OF THE USE OF OR INABILITY TO USE THIS MANUAL OR PRODUCT, EVEN IF CASIO HAS BEEN ADVISED OF THE POSSIBILITY OF SUCH DAMAGES.
- The contents of this manual are subject to change without notice.
- The actual appearance of the product may be different from that shown in the illustrations in this User's Guide.
- Company and product names used in this manual may be registered trademarks of others.

# Contents

## General Guide .....EN-2

- Using the 10-key Pad (15) .....EN-4
- Using the FUNCTION Button (3) .....EN-4

## Getting Ready to Play .....EN-5

- Preparing the Music Stand .....EN-5
- Power Supply .....EN-5

## Playing the Digital Keyboard...EN-6

- Turning on Power and Playing .....EN-6
- Using Headphones .....EN-6
- Using the Metronome .....EN-7

## Controlling the Keyboard Sounds .....EN-8

- Select from a variety of musical instrument sounds .....EN-8
- Using Reverb .....EN-9
- Using a Pedal .....EN-9
- Changing the Pitch (Transpose, Tuning) .....EN-10

## Sampling a Sound and Playing it on the Keyboard (Sampling) .....EN-11

- Playing the SAMPLING DEMO .....EN-11
- Sampling a Sound and Playing It .....EN-11
- Sounding Sampled Sounds .....EN-13
- Applying an Effect to a Sound Sample .....EN-14
- Using a Sampled Sound in a Rhythm (VOICE PERCUSSION) .....EN-15
- Starting a Sampling Operation Manually .....EN-15
- Deleting Sampled Data .....EN-15
- Enabling or Disabling the Sampling Play Back...EN-16
- Enabling or Disabling Auto Incrementing during Short Sampling .....EN-16

## Playing Built-in Songs ..... EN-17

- Playing the Demo Songs .....EN-17
- Playing Back a Particular Song .....EN-17

## Using Built-in Songs to Master Keyboard Play ..... EN-21

- Phrases .....EN-21
- Step Up Lesson Flow .....EN-21
- Selecting the Song, Phrase, and Part You Want to Practice .....EN-22
- Lessons 1, 2, and 3 .....EN-23
- Lesson Settings .....EN-24
- Using Auto Step Up Lesson .....EN-25

## Using Auto Accompaniment ..... EN-27

- Playing the Rhythm Part only .....EN-27
- Playing All Parts .....EN-28
- Using Auto Accompaniment Effectively .....EN-30
- Using One-Touch Preset .....EN-31

## Connecting External Devices ..... EN-32

- Connecting a Computer .....EN-32
- MIDI Settings .....EN-33
- Connecting to Audio Equipment .....EN-35

## Reference ..... EN-36

- Troubleshooting .....EN-36
- Specifications .....EN-38
- Operating Precautions .....EN-39
- Song List .....EN-40
- Fingering Guide .....EN-41
- Chord Example List .....EN-42

## MIDI Implementation Chart

### Included Accessories

- Music Stand
- Song Book
- Leaflets
  - Safety Precautions
  - Appendix
  - Other (Warranty, etc.)

Items included as accessories are subject to change without notice.

### Separately Available Accessories



- You can get information about accessories that are separately for this product from the CASIO catalog available from your retailer, and from the CASIO website at the following URL.





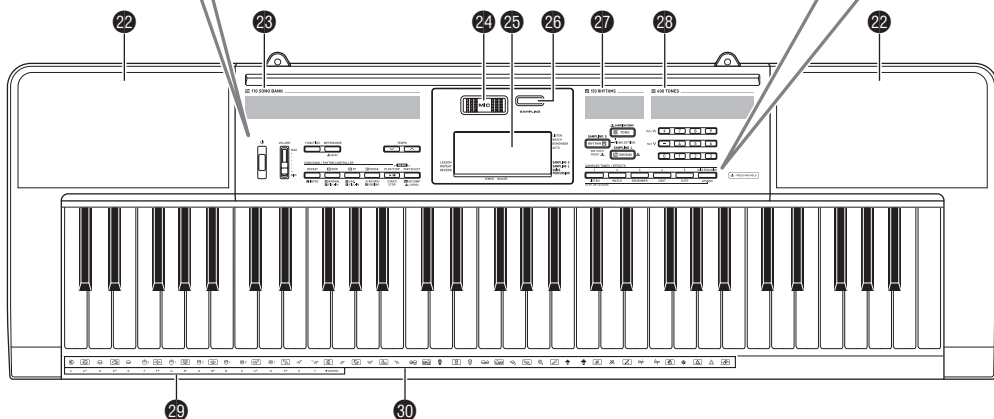
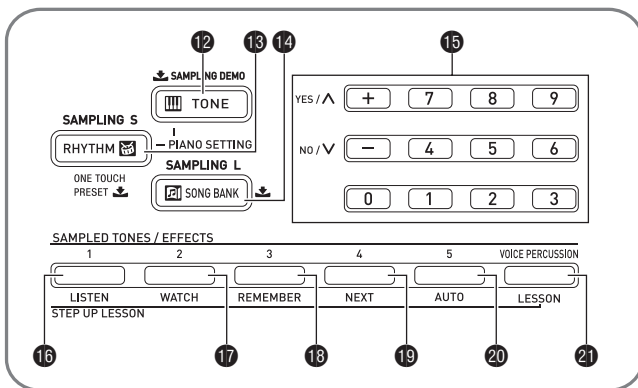
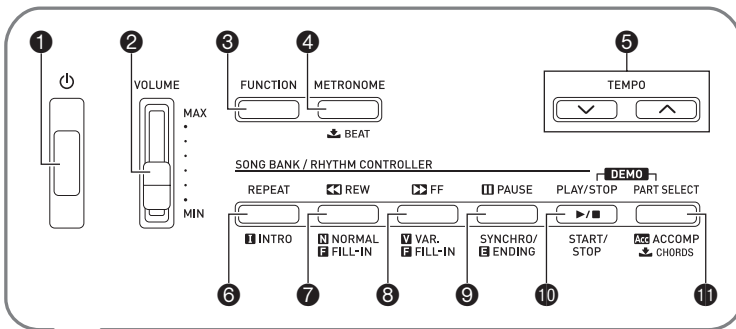























<http://world.casio.com/>

# General Guide

- In this manual, the term “Digital Keyboard” refers to the CTK-2090/CTK-2400.
- Illustrations in this User’s Guide show the CTK-2400.
- **In this manual, buttons and other controllers are identified using the numbers shown below.**



- The following explains the meaning of the  symbol that appears on the product console and with the key names below.
-  : Indicates a function that is enabled by holding down the button for some time.

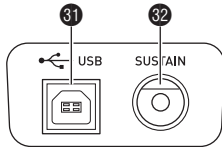

- 1  (POWER) button  EN-6
- 2 VOLUME slider  EN-6
- 3 FUNCTION button  EN-4
- 4 METRONOME,  BEAT button  EN-7
- 5 TEMPO buttons  EN-7, 19, 31
- 6 REPEAT, INTRO button  EN-18, 30
- 7 REW, NORMAL/FILL-IN button  EN-18, 30
- 8 FF, VAR./FILL-IN button  EN-18, 30
- 9 PAUSE, SYNCHRO/ENDING button  EN-18, 30
- 10 PLAY/STOP, START/STOP button  EN-11, 17, 27
- 11 PART SELECT, ACCOMP/ CHORDS button  EN-20, 28
- 12 TONE, SAMPLING DEMO button  EN-8, 11
- 13 RHYTHM, ONE TOUCH PRESET  button  EN-12, 27, 31
- 14 SONG BANK button  EN-11, 17
- 15 Number buttons, [-]/[+] keys  EN-4
- 16 SAMPLED TONES/EFFECTS 1, LISTEN button  EN-14, 23
- 17 SAMPLED TONES/EFFECTS 2, WATCH button  EN-14, 23
- 18 SAMPLED TONES/EFFECTS 3, REMEMBER button  EN-14, 24
- 19 SAMPLED TONES/EFFECTS 4, NEXT button  EN-14, 22
- 20 SAMPLED TONES/EFFECTS 5, AUTO button  EN-14, 25
- 21 VOICE PERCUSSION, LESSON button  EN-15, 22
- 22 Speakers
- 23 Song Bank list
- 24 Built-in microphone
- 25 Display
- 26 SAMPLING button  EN-11
- 27 Rhythm list
- 28 Tone list
- 29 CHORD root names  EN-28
- 30 Percussion instrument list  EN-8

■ Back

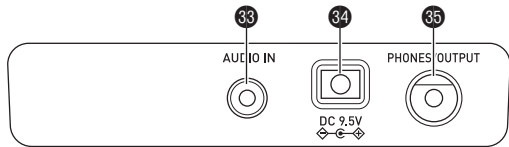

- 31 USB port  EN-32
- 32 SUSTAIN jack  EN-9



- 33 AUDIO IN jack  EN-11, 35
- 34 DC 9.5V terminal  EN-5
- 35 PHONES/OUTPUT jack  EN-6, 35

## Using the 10-key Pad (15)

Use the number buttons and the [-] and [+] keys to change the settings of the parameters that appear in the upper left area of the display.

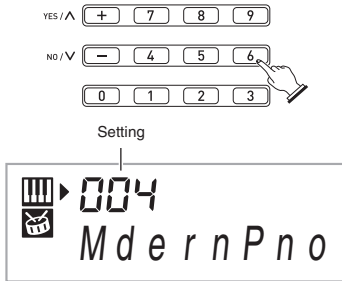

### Number Buttons

Use the number buttons to enter numbers and values.

- Enter the same number of digits as the currently displayed value.

*Example:* To enter tone number 004, input 0 → 0 → 4.

#### NOTE

- Negative values cannot be input using the number buttons. Use [+] (increase) and [-] (decrease) instead.

### [-] and [+] Keys

You can use the [+] (increase) and [-] (decrease) keys to change the displayed number or value.

- Holding down either key scrolls the displayed setting.
- Pressing both keys at the same time will revert to the initial default setting or the recommended setting.

## Using the FUNCTION Button (3)

Use the FUNCTION button (3) to access settings that let you select the reverb type, pedal effect, etc.

### 1. Press 3 (FUNCTION).

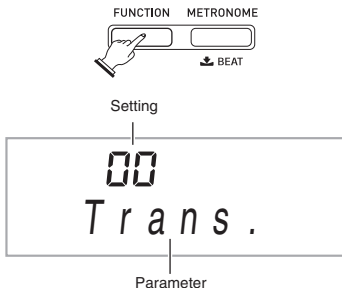

### 2. Next press 3 (FUNCTION) until the parameter whose setting you want to change is displayed.

- Each press of 3 (FUNCTION) cycles through the available parameters.
- To scroll backwards through parameters, hold down 3 (FUNCTION) as you press 4 (METRONOME).

	Parameter	Display	See Page
1	Transpose	Trans.	EN-10
2	Accompaniment Volume	AcompVol	EN-31
3	Song Volume	Song Vol	EN-19
4	Tuning	Tune	EN-10
5	Reverb	Reverb	EN-9
6	Voice Fingering Guide	Speak	EN-24
7	Note Guide	NoteGuid	EN-25
8	Performance Evaluation	Scoring	EN-25
9	Phrase	PhraseLn	EN-25
10	Sampling Start	SampAuto	EN-15
11	Sampling Play Back	SampPB	EN-16
12	Auto Incrementing during Short Sampling	AutoIncr	EN-16
13	Keyboard Channel	Keybd Ch	EN-33
14	Navigate Channels	Navi. Ch	EN-33
15	Local Control	Local	EN-34
16	Accomp Out	AcompOut	EN-34
17	Pedal Effect	Jack	EN-9

### 3. When the parameter you want is displayed, use

#### 15 (10-key) to change its setting.

- The parameter setting will disappear from the upper left area of the screen if you do not perform any operation for some time.

### IMPORTANT!

- The tone and other parameters revert to their initial defaults whenever you turn on power (page EN-6).

# Getting Ready to Play

## Preparing the Music Stand

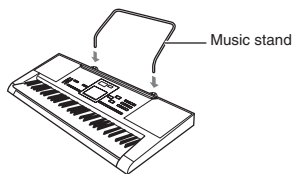

## Power Supply

Either an AC adaptor or batteries can be used to power this Digital Keyboard. Normally, use of AC adaptor power is recommended.

- The AC adaptor does not come with this Digital Keyboard. Purchase it separately from your retailer. See page EN-1 for information about options.

## Using the AC Adaptor

Make sure that you use only the AC adaptor specified for this Digital Keyboard. Use of a different type of AC adaptor can cause malfunction.

**Specified AC Adaptor: AD-E95100L**  
(JEITA Standard plug)

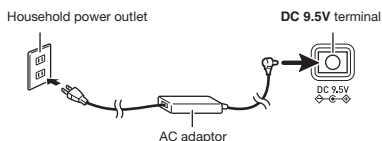

## IMPORTANT!

- Be sure to turn off Digital Keyboard power before connecting or disconnecting the AC adaptor.
- The AC adaptor will become warm to the touch after very long use. This is normal and does not indicate malfunction.
- To prevent breaking of the wire, take care to avoid putting any type of load on the power cord.

No bending!



No winding!

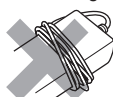

- Never insert metal, pencils, or any other objects into the product's 9.5V DC terminal. Doing so creates the risk of accident.

## Using Batteries

### IMPORTANT!

- Be sure to turn off power before loading batteries.
- It is up to you to prepare six commercially available AA-size batteries. Do not use oxyride batteries or any other nickel based batteries.

1. Open the battery cover on the bottom of the Digital Keyboard.

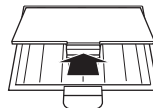

2. Load six AA-size batteries into the battery compartment.

Make sure the positive  $\oplus$  and negative  $\ominus$  ends of the batteries are facing as shown in the illustration.

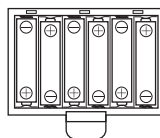

3. Insert the tabs of the battery cover into the holes on the side of the battery compartment, and close the cover.

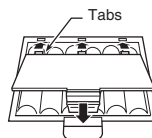

### Low Battery Indication

The indicator shown below starts to flash to let you know when battery power is low. Replace the batteries with new ones.

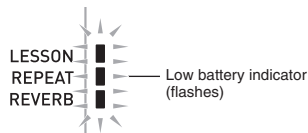

# Playing the Digital Keyboard

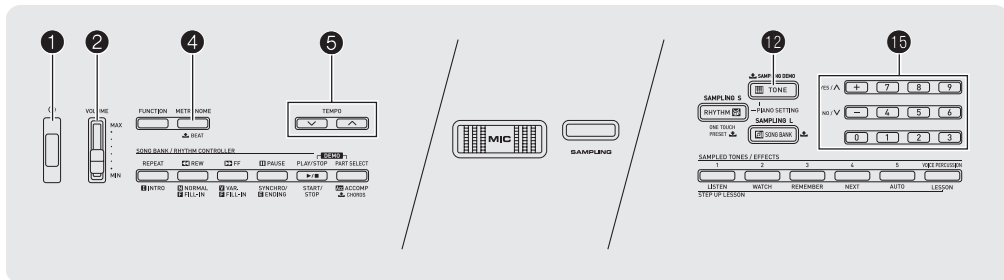

## Turning on Power and Playing

### 1. Press 1.

This turns on power.

- To turn off the Digital Keyboard, press 1 again.

### 2. Try playing something on the keyboard. Use 2 to adjust volume.



## IMPORTANT!

- Turning off the Digital Keyboard power causes all current settings to be cleared. The Digital Keyboard will revert to initial default settings the next time you turn it on.
- The message "Pls wait" will remain on the display while a data save operation is in progress. Do not perform any other operation while it is displayed. Turning off the Digital Keyboard can cause Digital Keyboard data to be deleted or become corrupted.

## Auto Power Off

If you do not perform any operation on the Digital Keyboard for one of the trigger times noted below, Auto Power Off will turn off power.

- During battery operation : 6 minutes
- During AC adaptor operation : 30 minutes

## Disabling Auto Power Off

You can disable Auto Power Off to ensure that power is not turned off automatically during a concert, etc.

### 1. While holding down 12 (TONE), turn on power.

Auto Power Off will be disabled.

## Using Headphones

Using headphones cuts off output from the built-in speakers, which means you can practice playing even late at night without disturbing others.

- Be sure to turn down the volume level before connecting headphones.

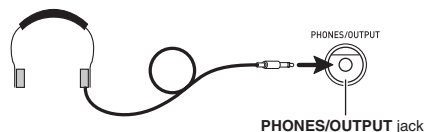

## NOTE

- Headphones do not come with the Digital Keyboard.
- Use commercially available headphones. See page EN-1 for information about options.

## IMPORTANT!

- Do not listen to very high volume output over headphones for long period. Doing so creates the risk of hearing damage.
- If you are using headphones that require an adaptor plug, make sure you do not leave the adaptor plugged in when removing the headphones.



## Using the Metronome

The metronome lets you play and practice along with a steady beat to help keep you on tempo.

### Start/Stop

#### 1. Press **4**.

This starts the metronome.

This pattern changes with each beat.



TEMPO MEASURE

#### 2. Press **4** again to stop the metronome.

### Changing the Beats per Measure

You can configure the metronome to use a bell sound for the first beat of each measure of the song you are playing.

- You can specify 0, or a value from 2 to 6 as the number of beat per measure.
- When playing a built-in song, the beats per measure setting (which determines when the bell sounds) is configured automatically for the currently selected song.

#### 1. Hold down **4** until the beats per measure setting screen appears on the display.



- If you do not perform any operation for after the beats per measure setting screen appears, the display will return to the screen displayed before you pressed **4**.

#### 2. Use **15** (10-key) to enter the number of beats per measure.

- The bell will not sound if you specify 0 for this setting. In this case, all beats are indicated by a click sound. This setting lets you practice with a steady beat, without worrying how many beats there are in each measure.

## Changing the Metronome Tempo

Use the following procedure to change the tempo of the metronome.

#### 1. Press **5**.

Use **∇** (slower) and **∧** (faster) to change the tempo setting. Holding down either button changes the setting at high speed.

- Pressing **∇** and **∧** at the same time will initialize the tempo setting in accordance with the currently selected song or rhythm.
- Pressing **5** causes the tempo value to flash on the display. While the tempo value is flashing, you can use **15** (10-key) to change it. Note that you must input leading zeros, so 89 is input as 089.
- The tempo value will stop flashing if you do not perform any operation for a short while.

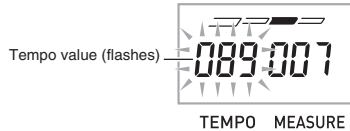

## Changing the Metronome Sound Volume

The metronome volume setting is changed automatically with the volume level of the currently selected Auto Accompaniment or song. The metronome volume cannot be adjusted independently.

- For information about changing the Auto Accompaniment volume, see page EN-31.
- For information about changing the song volume, see page EN-19.

### NOTE

- You cannot adjust the balance between the metronome and note volume during Auto Accompaniment and built-in tune play.

# Controlling the Keyboard Sounds

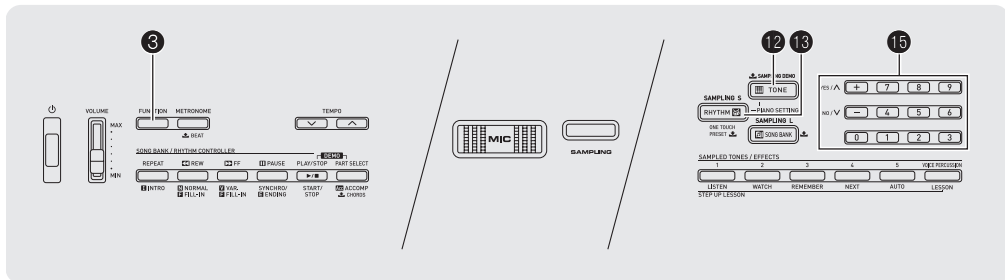

## Select from a variety of musical instrument sounds

Your Digital Keyboard lets you select tones for a wide variety of musical instrument sounds, including violin, flute, orchestra, and more. Even the same song sound takes on a different feel by changing the instrument type.

### To select an instrument for playing

#### 1. Press **12** (TONE).

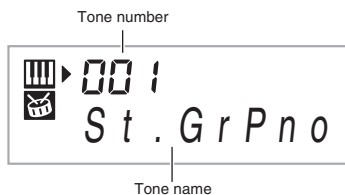

#### 2. Use **15** (10-key) to select the tone number you want.

The corresponding tone number and tone name will appear on the screen.

- Use the number buttons to enter the tone number.
- Specify three digits for the tone number.

*Example:* To select 001, enter 0 → 0 → 1.

#### NOTE

- See the separate "Appendix" for a complete list of available tones.
- When one of the drum sets is selected (tone numbers 395 through 400), each keyboard key is assigned a different percussion sound.

#### 3. Try playing something on the keyboard.

The tone of the instrument you selected will sound.



### Playing with a Piano Tone (Piano Setup)

Press **12** (TONE) and **13** (RHYTHM) at the same time. This selects the grand piano tone.

#### Settings

Tone Number: "001"  
 Reverb: "06"  
 Transpose: "00"  
 Pedal Effect: SUS  
 Rhythm Number: "131"  
 Accompaniment: Rhythm part only  
 Local Control: On  
 Voice Percussion: Off

## Using Reverb

Reverb adds reverberation to notes. You can change the duration of the reverb.

1. Press **F** (FUNCTION) a number of times until "Reverb" appears on the display (page EN-4).



2. Use **15** (10-key) [-] and [+] keys to select the reverb setting you want.

Off (off)	Turns off reverb.
1 to 10	The larger the number selected, the longer the reverb duration.



LESSON  
REPEAT  
REVERB

Indicator disappears when reverb is turned off.

## Using a Pedal

A pedal can be used to change notes in various ways while playing.

- A pedal unit does not come with the Digital Keyboard. Purchase one separately from your retailer. See page EN-1 for information about options.

### Connecting a Pedal Unit

Connect an optional pedal unit.



### Selecting the Pedal Effect

1. Press **F** (FUNCTION) a number of times until "Jack" appears on the display (page EN-4).

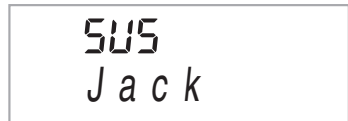

2. Use **15** (10-key) [-] and [+] keys to select the pedal effect you want.

- The following shows the available pedal effects.

<b>Sustain (SUS)</b>	Sustains notes played while the pedal is depressed. Organ and other similar tone notes are sustained even if the pedal is not pressed.
<b>Sostenuto (SoS)</b>	Sustains notes that are playing when the pedal is depressed before the keyboard keys are released.
<b>Soft (SFt)</b>	Slightly softens notes played while the pedal is depressed.
<b>Rhythm (rHy)</b>	Pressing the pedal starts and stops Auto Accompaniment or song playback.

## Changing the Pitch (Transpose, Tuning)

### Changing the Pitch in Semitone Steps (Transpose)

The transpose feature lets you change the pitch, in semitone steps. A simple operation lets you instantly change the pitch to match that of a singer.

- The transpose setting range is -12 to +12 semitones.

**1. Press **F** (FUNCTION).**



**2. Use **15** (10-key) [-] and [+] keys to select the transpose setting you want.**

### Fine Tuning (Tuning)

Use the tuning feature when you need to adjust the pitch slightly to play along with another musical instrument. Also, some artists perform their music with slightly altered tuning. You can use the tuning feature to adjust tuning so it exactly matches a performance on a CD.

- The tuning feature specifies the frequency of the A4 note. You can set a frequency within the range of 415.5 to 465.9 Hz. The initial default setting is 440.0 Hz.

**1. Press **F** (FUNCTION) a number of times until "Tune" appears on the display (page EN-4).**



**2. Use **15** (10-key) [-] and [+] keys to adjust the tuning.**

- Performing this step causes the display to change from "Tune" to a value that indicates the current frequency setting as shown below. You can change the frequency in 0.1Hz steps.



- Even if you do not perform a **15** (10-key) operation to adjust the tuning, the current frequency setting will appear automatically after a few seconds.

# Sampling a Sound and Playing it on the Keyboard (Sampling)

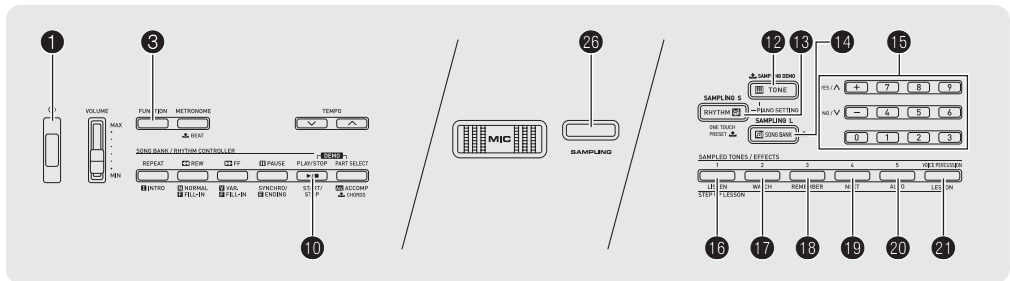

You can use the digital keyboard's built-in microphone to record a sound and then play it with the keyboard keys. The sampling feature is a great way to create your own original sounds.

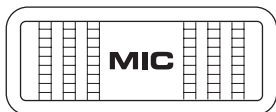

## Playing the SAMPLING DEMO

Use the procedure below to play a demo tune that features sampled sounds.

### 1. Hold down 12 (SAMPLING DEMO).

This starts playback.

### 2. To stop demo play, press 13 or 10.

## IMPORTANT!

- Sampled sounds are recorded in monaural.
- The built-in microphone is only for inputting and recording external sounds for use with the sampling function. Sounds input with the built-in microphone are not output through the speakers.
- You cannot sample sounds input through the AUDIO IN jack.

## Sampling a Sound and Playing It

There are two sampling methods: long sampling and short sampling. Long sampling is used for sampling in the Song Bank Mode, while short sampling is used for sampling in the Rhythm Mode.

### Long Sampling

This method allows sampling of a single sound with a duration of two seconds.

## IMPORTANT!

- Sampling a new sound overwrites all previously recorded data (including data recorded with short sampling).

### 1. Press 14 (SONG BANK).

### 2. Press 26 (SAMPLING) and release it.

This enters sampling standby.

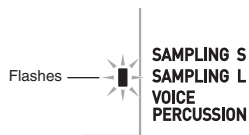

**3. Produce the desired sound in the direction of the built-in microphone.**

Sampling will start automatically.



- Sampling will not start if the volume level of the sound being sampled with the microphone is too low.
- Sampling will stop automatically two seconds after it starts, or if the sound being input through the microphone stops before then.

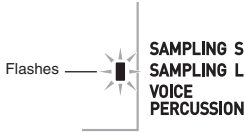

- Random phrases using the sampled sound will play back to indicate that sampling is complete.
- What you sample is stored as tone number 401.

**4. Press a keyboard key.**

This will play the recorded sound.

**■ Short Sampling**

With short sampling, you can record up to five samples, each with a length of up to approximately 0.4 seconds. Short samples are assigned rhythm parts, and can be sounded as voice percussion. For details, see "Using a Sampled Sound in a Rhythm (VOICE PERCUSSION)" (page EN-15).

**⚠ IMPORTANT!**

- **Sampling a new sound overwrites all previously recorded data (including data recorded with long sampling).**

**1. Press **13** (RHYTHM).**

- If you want to use a rhythm for sampling, select it here.

**2. Press **26** (SAMPLING) and release it.**

This enters sampling standby.

- At this time tone number 412 (which is short sampling 1 tone) is selected.

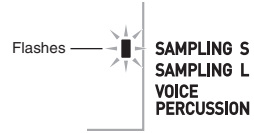

**3. Produce the desired sound in the direction of the built-in microphone.**

Sampling will start automatically.



- Sampling will not start if the volume level of the sound being sampled with the microphone is too low.
- Sampling will stop automatically 0.4 seconds after it is started.

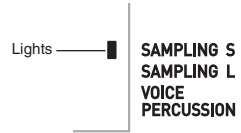

- The sampled sound is assigned a rhythm number and start to play to indicate that sampling is complete.
- What you sample is stored as tone number 412.

**4. Press a keyboard key.**

This will play the recorded sound.

## 5. Press (SAMPLING).

- At this time tone number 415 (which is short sampling 2 tone) is selected.
- Each subsequent short sampling operation is automatically assigned to the next sequential tone number. After sampling reaches tone number 424 (short sampling 5 tone), it cycles back to tone number 412 (short sampling 1 tone).
- If you want to assign a sample to a specific number manually, press the **SAMPLED TONES/EFFECTS** button (1 to 5) that corresponds to the number you want before pressing the **SAMPLING** button. This will perform short sampling and assign the result to the number that corresponds to the button you press.

## 6. Repeat steps 2 through 5 as many times as necessary to perform the short sampling you want.

## Sounding Sampled Sounds

### ■ Long Sample

In the Song Bank Mode, the five **SAMPLED TONES/EFFECTS** buttons have the functions described below.

- 1: Sounds the original sampled tone as-is.
- 2 to 5: Select effects.

### NOTE

- The SAMPLING L indicator appears on the display when there is a long sample (sample created with long sampling) available.

### ■ Short Sample

In the Rhythm Mode, the five **SAMPLED TONES/EFFECTS** button can be used to select short sample tones.

- 1: Tone number 412
- 2: Tone number 415
- 3: Tone number 418
- 4: Tone number 421
- 5: Tone number 424

### NOTE

- The SAMPLING S indicator appears on the display when there is one or more sample (sample created with short sampling) available.

## Applying an Effect to a Sound Sample

Use the procedure below to apply effects to a sample that was recorded using either long sampling or short sampling.

### 1. Press one of the five **16** - **20** (SAMPLED TONES/EFFECTS) buttons to cycle through available effects.

Example: Button 1 (tone number 412)

Original tone → Loop 1 → Loop 2 → Original tone →

See the "Sampled Sound Tone Numbers" table below for details about the effects that are assigned to each button.

#### ■ Sampled Sound Tone Numbers

The original sampled sound and its modified (by effects) versions are assigned to sequential tone numbers (the same as built-in tones). This makes it easy to select a version of a sampled sound using **16** (10-key).

SAMPLED TONES/ EFFECTS button	Tone No.	Effect Name	Description
1	401	Original Long	–
	402	Loop 1 Long	Loops the sampled sound.
	403	Loop 2 Long	Loops the sample sound and raises the pitch of the resonating sound when the keyboard key is released.
2	404	Loop 3 Long	Loops the sample sound and lowers the pitch of the resonating sound when the keyboard key is released.
	405	Pitch 1 Long	Changes the pitch from low to high, at an increasing rate.
3	406	Pitch 2 Long	Changes pitch from high to low, at a decreasing rate.
	407	Pitch 3 Long	Changes pitch from high to low, at a decreasing rate, and then raises the pitch when the key is released.
4	408	Tremolo Long	Alternates volume between high and low.
	409	Funny 1 Long	Adds vibrato and changes pitch by a gradually increasing amount.
5	410	Funny 2 Long	Alternates between high pitch and low pitch.
	411	Funny 3 Long	Adds vibrato and changes pitch from low to high.
1	412	Original Short 1	–
	413	Loop 1 Short 1	Loops the sampled sound.
	414	Loop 2 Short 1	Loops the sample sound and raises the pitch of the resonating sound when the keyboard key is released.
2	415	Original Short 2	–
	416	Loop 3 Short 2	Loops the sample sound and lowers the pitch of the resonating sound when the keyboard key is released.
3	417	Pitch 1 Short 2	Changes the pitch from low to high, at an increasing rate.
	418	Original Short 3	–
	419	Pitch 2 Short 3	Changes pitch from high to low, at a decreasing rate.
4	420	Pitch 3 Short 3	Changes pitch from high to low, at a decreasing rate, and then raises the pitch when the key is released.
	421	Original Short 4	–
5	422	Tremolo Short 4	Alternates volume between high and low.
	423	Funny 1 Short 4	Adds vibrato and changes pitch by a gradually increasing amount.
5	424	Original Short 5	–
	425	Funny 2 Short 5	Alternates between high pitch and low pitch.
	426	Funny 3 Short 5	Adds vibrato and changes pitch from low to high.



## Using a Sampled Sound in a Rhythm (VOICE PERCUSSION)

Use the following procedure to replace a percussive instrument with a sampled sound you sampled with short sampling and play auto accompaniment rhythms (page EN-27) with it.

### 1. Each press of **21** (VOICE PERCUSSION) button toggles between the VOICE PERCUSSION mode and the normal rhythm mode.

- The VOICE PERCUSSION indicator will be on the display while the VOICE PERCUSSION mode is selected.



### 2. Start rhythm play (page EN-27).

- Some rhythm part sounds are replaced by sampled sounds you sampled with short sampling.

#### NOTE

- In the VOICE PERCUSSION mode, the rhythm accompaniment volume level is balanced with the volume of the sampled sound. Because of this, the rhythm accompaniment (chords and obbligato) volume level will be lowered automatically.

## Starting a Sampling Operation Manually

### 1. Press **3** (FUNCTION) a number of times until "SampAuto" appears on the display (page EN-4).



### 2. Press **15** (10-key) [-] key to select the OFF setting.

This enables manual sampling. When this setting is selected, sampling starts as soon as you release **26** in step 2 under "Long Sampling" (page EN-11) or step 2 under "Short Sampling" (page EN-12).

#### IMPORTANT!

- When the above setting is "oFF", sampling starts when you release **26**, not when you press it. Sampling will not start if you keep **26** depressed.

## Deleting Sampled Data

### To delete all sampled data

- Press **1** to turn off power.
- While holding down **14** (SONG BANK) and **15** (10-key) [0] button, press **1** to turn power back on again.

#### NOTE

- Make sure the digital keyboard is not connected to a computer when performing the above steps. Otherwise, data may not be deleted correctly.

### To delete the long sample

- Press **14** (SONG BANK).
- Hold down **15** (SAMPLED TONES/EFFECTS 1).
  - This will cause the confirmation message "Sure?" to appear.
- Press **15** (10-key) [YES] key to delete the data or **15** (10-key) [NO] key to cancel.

### To delete the data for a specific short sample number

- Press **13** (RHYTHM).
- Hold down the SAMPLED TONES/EFFECTS button (**15** to **20**) whose data you want to delete.
  - This will cause the confirmation message "Sure?" to appear.
- Press **15** (10-key) [YES] key to delete the data or **15** (10-key) [NO] key to cancel.

## Enabling or Disabling the Sampling Play Back

Use the procedure below to enable or disable the auto playback routine (song or rhythm using sampled sound) that is performed after sampling is complete.

1. Keep pressing **3** (FUNCTION) until “SampPB” appears on the display.
2. Press **15** (10-key) [-] key to disable the demo routine.
  - While the demo routine is disabled, the playback in step 3 at the end of long sampling and short sampling is not performed.

## Enabling or Disabling Auto Incrementing during Short Sampling

Use this procedure to enable or disable auto incrementing of the short sampling number during short sampling.

1. Keep pressing **3** (FUNCTION) until “AutoIncr” appears on the display.
2. Press **15** (10-key) [-] key to disable short sample number incrementing.

When short sample number incrementing is turned off, short sampling is repeated using the number (number does not change) selected with the **SAMPLED TONES/EFFECTS** (1 to 5) button. To change short sampling to another number, you need to press a different **SAMPLED TONES/EFFECTS** (1 to 5) button before pressing the **SAMPLING** button.

# Playing Built-in Songs

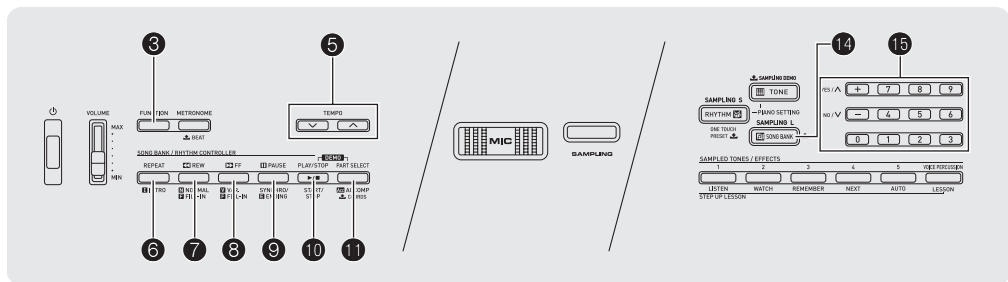

With this Digital Keyboard, built-in tune data is referred to as “songs”. You can listen to the built-in songs for your own enjoyment, or you can play along with them for practice.

## NOTE

- In addition to simple listening enjoyment, the built-in songs can be used with the lesson system (page EN-21) for practice.

## Playing the Demo Songs

Use the following procedure to play back built-in songs (001 to 090).

### 1. Press **10** and **11** at the same time.

- This will start playback of the demo songs. Demo playback continues until you stop it.
- See page EN-40 for a complete list of available songs.
- Demo playback always starts from song number 001.

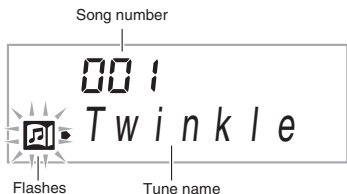

### 2. To change to another song while demo playback is in progress, use **15** (10-key) [-] and [+] keys to enter the song number you want (page EN-4).

- This will cause demo playback to jump to the song whose number you entered.
- You cannot use **15** (10-key) number buttons to select a song.

### 3. To stop demo playback, press **10**.

Demo playback continues until you stop it by pressing **10**.

## Playing Back a Particular Song

Use the procedure below to play back one of the built-in songs. You can play along on the keyboard with song playback.

### Start/Stop

#### 1. Press **14** (SONG BANK).

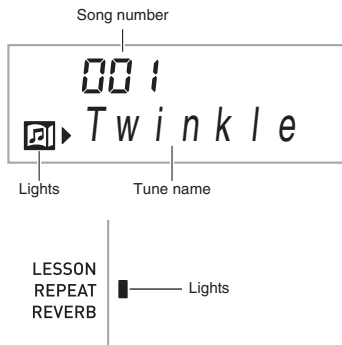

#### 2. Use **15** (10-key) to enter the number of the song you want.

- See page EN-40 for a complete list of available songs.
  - Use the number buttons to enter the song number. Specify three digits for the song number.
- Example:* To select 001, enter 0 → 0 → 1.

### 3. Press 10.

This starts playback of the song.

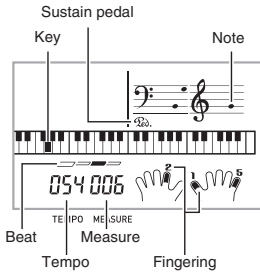

### 4. Press 10 again to stop playback.

Song playback will continue (repeat) until you press 10 to stop it. You can cancel song repeat by pressing 6.

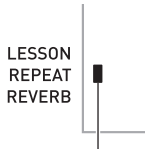

Indicator disappears when song repeat is turned off.

### ■ Skip Forward

#### 1. Press 8.

This skips song playback forward to the next measure. Each press of 8 skips ahead one measure. Holding down 8 skips forward at high speed until you release it.

- Pressing 8 while song playback is stopped performs lesson function phrase skip forward (page EN-22).

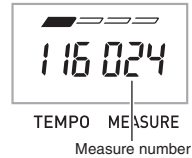

### ■ Skip Back

#### 1. Press 7.

This skips song playback back to the previous measure. Each press of 7 skips back one measure. Holding down 7 skips back at high speed until you release it.

- Pressing 7 while song playback is stopped performs lesson function phrase skip back (page EN-22).

### Repeating Playback of Specific Measures

You can use the procedure in this section to repeat particular measures for practice playing along until you master it. You can specify the start measure and the end measure of the section you want to play and practice.

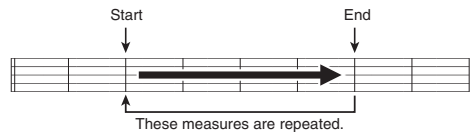

#### 1. Press 6 to temporarily turn off song repeat.

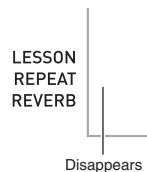

### Pause, Skip Forward, Skip Back

Use the operations in this section to perform pause, skip forward, and skip back operations.

#### ■ Pause

##### 1. Press 9.

This pauses song playback.

##### 2. Press 9 again to resume playback from the point where you paused it.

## 2. When song playback reaches the measure you want to specify as the start measure, press **6**.

This specifies the measure as the start measure.

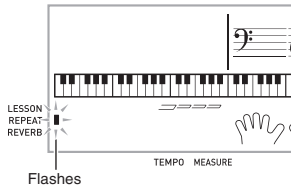

## 3. When playback reaches the measure you want to select as the end measure, press **6** again.

This specifies the measure as the end measure and starts repeat playback of the measures in the specified range.

- During repeat play you can use **9** to pause playback, **8** to skip forward, or **7** to skip back.

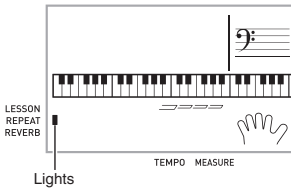

## 4. Pressing **6** again returns to normal playback.

Changing the song number clears the start measure and end measure of the repeat operation.

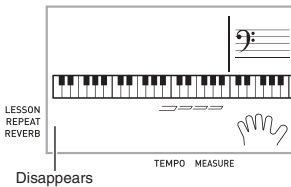

## Changing Playback Speed (Tempo)

You can use the following procedure to change the speed (tempo) in order to slow down playback to practice difficult passages, etc.

### 1. Press **5**.

Use **∇** (slower) and **∧** (faster) to change the tempo setting. Holding down either button changes the setting at high speed.

- Pressing **∇** and **∧** at the same time will return the current song to its original default tempo.
- Pressing **5** causes the tempo value to flash on the display. While the tempo value is flashing, you can use **15** (10-key) to change it. The tempo value will stop flashing if you do not perform any operation for a short while.
- Changing the song number will return the song to its original default tempo.

## Adjusting the Song Volume

Use the following procedure to adjust the balance between the volume of what you play on the keyboard and song playback volume.

### 1. Press **3** (FUNCTION) a number of times until "Song Vol" appears on the display (page EN-4).

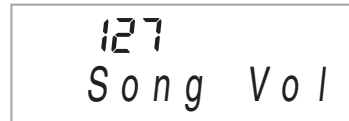

### 2. Use **15** (10-key) [-] and [+] keys to adjust the song volume.

## Playing with the Tone as Song Playback

The procedure below lets you select the same keyboard tone as the one being used in the song and play along with your favorite tunes.

1. After selecting a song, hold down **14** (SONG BANK) for about two seconds until the displayed tone name changes to the tone name of the song.

- If your currently selected tone is the same as the song tone, the display contents will not change.

2. Play along with song playback.

### NOTE

- If you select a song that uses different tones for left and right hand play, the right hand part tone is assigned to the keyboard.

## Turning Off the Part of One Hand for Practice (Part Select)

You can turn off the right hand part or the left hand part of a song during playback and practice playing the along with the remaining part.

1. Press **11** to select the part you want to turn off.

Each press of **11** cycles through the settings shown below.

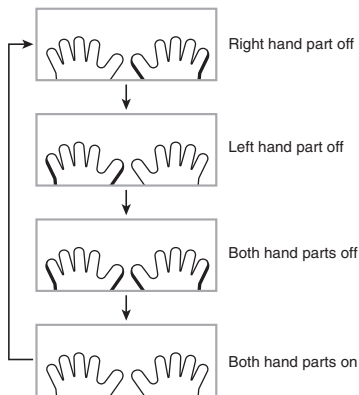

2. Press **10**.

This starts playback in accordance with the setting you selected in step 1.

### NOTE

- During playback with one part turned off, only the notes of the part that is turned off are shown on the display.

# Using Built-in Songs to Master Keyboard Play

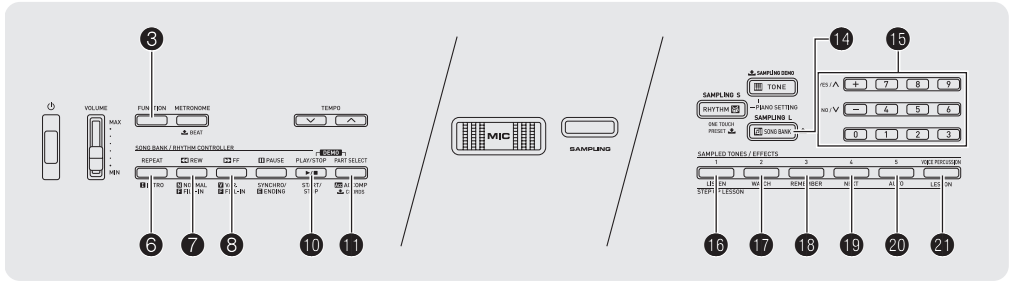

To master a song, it is best to break it up into shorter parts (phrases), master the phrases, and then put everything together. Your Digital Keyboard comes with a Step Up Lesson feature that helps you to do just that.

## Phrases

The built-in songs are pre-divided into phrases to help you master keyboard play.

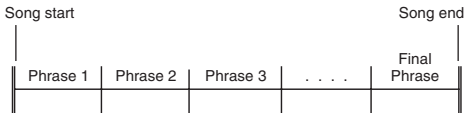

## Step Up Lesson Flow

Step Up Lesson takes you through practice of the right hand part, left hand part, and both hand parts for each phrase of a song. Master all of the phrases and you master the song.

### Phrase 1

- Right Hand Lesson 1, 2, 3
- Left Hand Lesson 1, 2, 3
- Both Hand Lesson 1, 2, 3



Repeat the above to practice phrase 2, 3, 4, and so on, until you reach the final phrase of the song.

After mastering all of the phrases, practice the entire song.

Now you have mastered the entire song!



## Messages that Appear during Lessons

The following are the messages that appear on the display during Step Lessons.

Message	Description
<Phrase>	Appears when you select a phrase, when a lesson starts, etc. <ul style="list-style-type: none"> <li>Note that certain phrases will cause "&lt;Wait&gt;" to appear instead of "&lt;Phrase&gt;".</li> </ul>
<Wait>	Appears when the lesson starts with an intro or fill-in phrase that is not included in the phrases to be practiced. Play toll advance automatically to the next phrase after the un-included phrase plays, so wait until then to start playing on the keyboard.
NextPhrs	Appears when advancing automatically to the next phrase. This message appears following a phrase for which "<Wait>" (see above) is displayed, and during an Auto Step Up Lesson (page EN-25).
From Top	This message appears during Auto Step Up Lesson (page EN-25) immediately before practice from Phrase 1 up until the phrase currently being practiced.
Complete	Appears at the end of Auto Step Up Lesson (page EN-25).

## To turn lesson function on or off

### 1. Press **14** (SONG BANK).

### 2. Press **21** (LESSON) to turn on the lesson function.

This causes the LESSON indicator to appear on the display.



### 3. To turn off the lesson function, press **21** (LESSON).

This causes the LESSON indicator to disappear on the display.



## Selecting the Song, Phrase, and Part You Want to Practice

First, select the song, phrase, and part you want to practice.

### 1. Select the song you want to practice (page EN-17).

This will select the first phrase of the song.

### 2. Press **19** (or **8**) to move forward one phrase, or **7** to move back one phrase.

- Holding down **8** or **7** scrolls through phrases at high speed.
- The Digital Keyboard remembers the last phrase you practiced for up to 20 songs. To recall the last practice phrase for the current song (if it is available), hold down **19**.

Phrase number



First measure of the selected phrase

### 3. Press **11** to select the part you want to practice.

Each press of **11** cycles through the settings shown below.

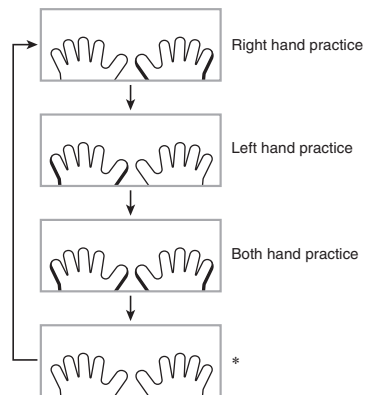

\* This indicator (setting) is skipped if you press **11** while a lesson is in progress.

### 4. Hold down **14** (SONG BANK) for about two seconds.

The same tone used for song playback will be assigned to the keyboard (page EN-20).



## Lessons 1, 2, and 3

Now it is time to start the lessons. First, select the song and part you want to practice.

### Lesson 1: Listen to the song.

First, listen to the example a few times to familiarize yourself with what it sounds like.

#### 1. Press **16**.

This starts example play.



#### 2. To stop Lesson 1, press **16** or **10**.

### Lesson 2: Watch how the song is played.

Play the song on the keyboard. During this lesson, the display shows the key you need to press next. Voice fingering guide also uses a simulate voice to announce which finger you should use. Follow the instructions to press the correct keyboard keys and play the notes. Don't worry if you play the wrong note. Song playback will wait until you play the correct note. Take your time and play at your own pace.

#### 1. Press **17**.

This starts Lesson 2.



#### 2. Play notes on the keyboard in accordance with the instructions provided on the display and by voice fingering guide.

During this lesson, the display shows the key you need to press next. Voice fingering guide uses a simulate voice to announce which finger you should use.

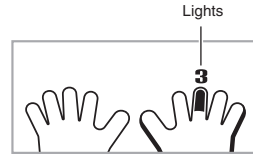
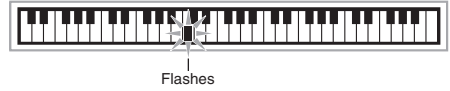

#### <Lesson 2 Guidance>

Master playing the correct note with the correct finger as instructed by the guidance. Practice playing with the correct timing.



Song playback will wait for you to play the correct note.

- Keyboard key goes from flashing to lit.
- Note guide sounds the correct note to be played.
- Voice Fingering Guide tells you what finger to use.



Pressing the correct keyboard key causes song playback to resume and the key for the next note flashes.

#### 3. To stop Lesson 2, press **17** or **10**.

- If you complete Lesson 2 play to the end, a score that rates your play appears on the screen.

Bravo!	You pass! Advance to the next lesson.
Again!	Go back and try again.

### Lesson 3: Remember what you learned as you play.

Though song playback stands by waiting for you to press the correct keys as in Lesson 2, the Digital Keyboard does not provide any guidance about what note you need to play next. Remember everything you have learned up to Lesson 2 as you play.

#### 1. Press **18**.

This starts Lesson 3.



#### 2. Play the song along with the song playback.

##### <Lesson 3 Guidance>

Press the keyboard keys you learned in Lesson 2.



Song playback will wait for you to play the correct note.

- Note guide sounds the correct note to be played.



If you are still unable to press the correct keyboard key, the Digital Keyboard will display keyboard guidance and voice fingering guide will tell you what finger to use, just as in Lesson 2.



Pressing the correct key will cause song playback to resume.

#### 3. To stop Lesson 3, press **18** or **10**.

- If you complete Lesson 3 play to the end, a score that rates your play appears on the screen the same as with Lesson 2.

### Playing a Particular Song All the Way Through

After you successfully complete all of the phrases in Lessons 1, 2, and 3, it is time to try playing the entire song from beginning to end.

#### 1. Use **11** to turn off both hand parts and then press **10**.

Try playing with both hands and find out how the Digital Keyboard evaluates your effort.

### Lesson Settings

#### Playing without Phrase Repeat

You can turn off phrase repeat for Lessons 1, 2, and 3.

#### 1. Press **6**.

This disables phrase repeat play.



LESSON REPEAT REVERB — Disappears

#### Turning Off Voice Fingering Guide

Use the following procedure to turn off voice fingering guide, which tells you which finger to use to play each note in Lesson 2 and Lesson 3.

#### 1. Press **3** (FUNCTION) a number of times until "Speak" appears on the display (page EN-4).



#### 2. Press the **15** (10-key) [-] key to select the OFF setting.

## Turning Off Note Guide

Use the following procedure to turn off note guide, which sounds the note to be played next in Lesson 2 and Lesson 3.

1. Press **3** (FUNCTION) a number of times until "NoteGuid" appears on the display (page EN-4).



2. Press the **15** (10-key) [-] key to select the OFF setting.

## Turning Off Performance Evaluation

Use the following procedure to turn off performance evaluation, which evaluates your performance and displays a score in Lesson 2 and Lesson 3.

1. Press **3** (FUNCTION) a number of times until "Scoring" appears on the display (page EN-4).



2. Press the **15** (10-key) [-] key to select the OFF setting.

## Lesson Play without Dividing Songs into Phrases

When the phrase function is turned off, lessons go through an entire song from beginning to end, without dividing it up between phrases.

1. Press **3** (FUNCTION) a number of times until "PhraseLn" appears on the display (page EN-4).

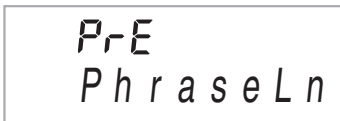

2. Press the **15** (10-key) [-] key to select the OFF setting.

## Using Auto Step Up Lesson

With Auto Step Up Lesson, the Digital Keyboard advances through each lesson automatically.

1. Select the song and part you want to practice (page EN-17).
2. Press **20**.

Listen to the first phrase in Lesson 1.

- In Lesson 1, the sample phrase is played only once before advancing to Lesson 2.

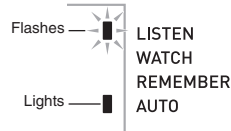

3. Auto Step Up Lesson stops automatically after you are able to get through all of the lessons successfully.

- In Lesson 2 and Lesson 3, the Digital Keyboard advances to the next lesson if you are able to achieve the "Bravo!" evaluation result.
- To cancel a lesson, press **20** or **10**.

### NOTE

- You can change the step and phrase during Auto Step Up Lesson using **7**, **8**, and **16** to **19**.
- Starting Auto Step Up Lesson turns on Phrase Repeat (page EN-24), Note Guide (page EN-25) and Performance Evaluation (page EN-25) automatically. These features cannot be turned off during lessons.

■ Auto Step Up Lesson Procedure

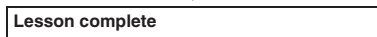
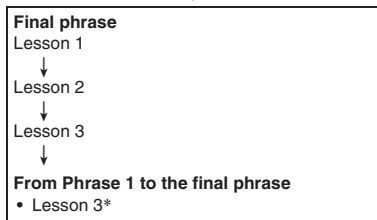
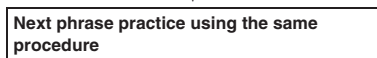
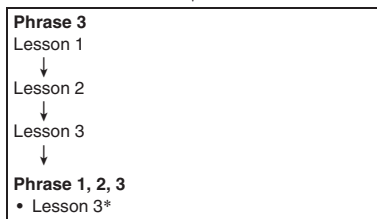
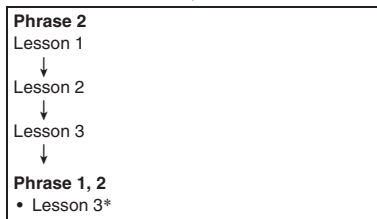

\* Auto Step Up Lesson advances to the next phrase, regardless of whether the "Bravo!" result is attained.

# Using Auto Accompaniment

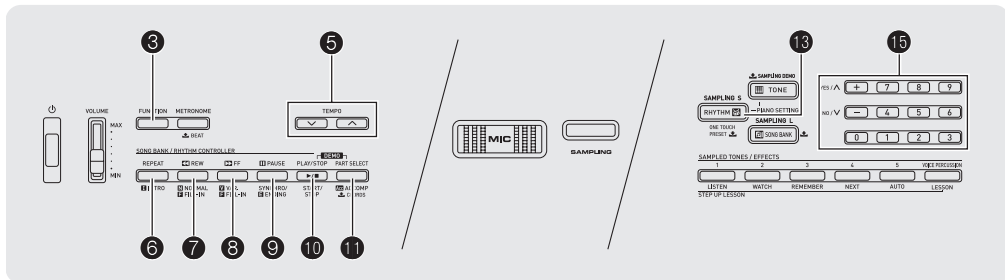

With Auto Accompaniment, simply select an accompaniment pattern. Each time you play a chord with your left hand the appropriate accompaniment will play automatically. It's like having a personal backup group along with you wherever you go.

## NOTE

- Auto Accompaniments are made up of the following three parts.
  - (1) Rhythm
  - (2) Bass
  - (3) Harmony

You can have only the rhythm part play, or you can have all three parts play at the same time.

## Playing the Rhythm Part only

The rhythm part is the foundation each Auto Accompaniment. Your Digital Keyboard comes with a variety of built-in rhythms, including 8-beat and waltz. Use the following procedure to play the basic rhythm part.

## Starting and Stopping the Rhythm Part only

- Press **13** (RHYTHM).

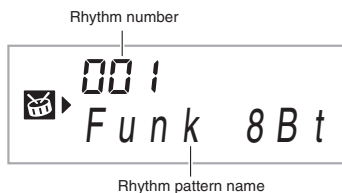

- Use **15** (10-key) to select the rhythm number you want.

- See the separate "Appendix" for information about individual rhythms.
- Use the number buttons to enter the rhythm number. Specify three digits for the rhythm number.  
*Example:* To select 001, enter 0 → 0 → 1.

## NOTE

- With rhythms 140, and 142 to 150, nothing will sound until you play a chord on the keyboard.

- Press **10** or **7**.

This starts the rhythm.

This pattern changes with each beat.



- Play along with the rhythm.

- To stop the rhythm, press **10** again.

## Playing All Parts

### Auto Accompaniment with Chords

Playing a chord with your left hand automatically adds bass and harmony accompaniment parts to the currently selected rhythm. It is just like having your own personal back up group on call.

#### 1. Start play of the Auto Accompaniment rhythm part.

#### 2. Press **11**.

This enables chord input on the accompaniment keyboard.

Accompaniment keyboard

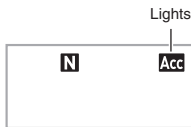

#### 3. Use the accompaniment keyboard to play chords.

This will cause bass and harmony Auto Accompaniment parts to be added to the rhythm part.

Chords  
(no melody played)

Melody

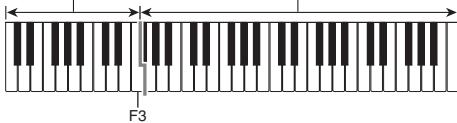

Example: Pressing D-F#-A-C on the accompaniment keyboard

Accompaniment for the D-F#-A-C chord (D7) sounds.



#### 4. Play other chords with left hand as you play the melody with your right hand.

#### 5. Pressing **11** again returns to rhythm only accompaniment.

#### NOTE

- For information about starting Auto Accompaniment as soon as a chord is played, see "Using Synchro Start" on page EN-31.

### Selecting a Chord Input Mode

You can select from among the following five chord input modes.

- FINGERED 1
- FINGERED 2
- FINGERED 3
- CASIO CHORD
- FULL RANGE CHORD

#### 1. Hold down **11** until the chord input mode selection screen appears on the display.

Chord input mode



#### 2. Use **15** (10-key) [-] and [+] keys to select the chord input mode you want.

- If you do not perform any operation after the chord input mode selection screen appears, the display will return automatically to the screen that was displayed before you held down **11**.

### ■ FINGERED 1, 2, and 3

With these three input modes, you play chords on the accompaniment keyboard using their normal chord fingerings. Some chord forms are abbreviated, and can be fingered with one or two keys.

See page EN-41 for information about chords that are supported and how they are fingered on the keyboard.

Accompaniment keyboard



#### ● FINGERED 1

Play the component notes of the chord on the keyboard.

F1

#### ● FINGERED 2

Unlike FINGERED 1, 6th input is not possible. m7 or m7<sup>b5</sup> is input.

F2

#### ● FINGERED 3

Unlike FINGERED 1, allows input of fraction chords with the lowest keyboard note as the bass note.

F3

### ■ CASIO CHORD

With CASIO CHORD, you can use simplified fingerings to play the four types of chords described below.

Accompaniment keyboard



### CASIO CHORD Fingering

Chord Type	Example
<b>Major Chords</b> Letters above the accompaniment keyboard indicate the chord assigned to each key. Pressing a single accompaniment area key in the CASIO CHORD mode will play the major chord whose name is marked above the key. All of the accompaniment area keys that are marked with the same chord name play exactly the same chord.	C (C Major) 
<b>Minor Chords</b> To play a minor chord, press the accompaniment area key that corresponds to the major chord, while also pressing one other accompaniment area key to the right.	Cm (C Minor) 
<b>Seventh Chords</b> To play a seventh chord, press the accompaniment area key that corresponds to the major chord, while also pressing two other accompaniment area keys to the right.	C7 (C Seventh) 
<b>Minor Seventh Chords</b> To play a minor seventh chord, press the accompaniment area key that corresponds to the major chord, while also pressing three other accompaniment area keys to the right.	Cm7 (C Minor Seventh) 



#### NOTE

- When playing a minor, seventh, or minor seventh chord, it makes no difference whether the additional keys you press are black or white.

### ■ FULL RANGE CHORD

With this mode, you can use the full range of the keyboard to play chords and the melody.

See page EN-41 for information about chords that are supported.

F-C

Accompaniment keyboard / Melody keyboard



## Using Auto Accompaniment Effectively

### Auto Accompaniment Pattern Variations

Use the following procedures to play intro and ending patterns, to play fill-in patterns, and to play variations of basic Auto Accompaniment patterns.

#### ■ Auto Accompaniment Variation

Each Auto Accompaniment pattern has a basic “normal pattern” as well as a “variation pattern”.

##### 1. Press **8**.

This starts the variation pattern.

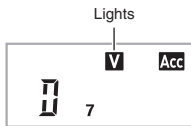

##### 2. Pressing **7** returns to normal pattern.

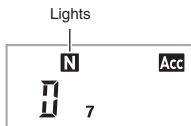

#### ■ Auto Accompaniment Intro

Use the following procedure to play an intro of a few measures.

##### 1. Press **6**.

This starts the intro pattern. Normal pattern play will start when the intro pattern is finished.

- If you press **8** while an intro pattern is being played, the variation pattern will start when the intro pattern is finished.

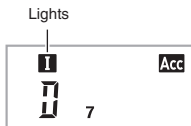

#### ■ Auto Accompaniment Fill-in

Use the procedure below to play a fill-in pattern during a performance.

- A “fill-in” is a short phrase played where you want to change the mood of a piece. A fill-in pattern can be used to create a link between two melodies or an accent.
- Normal and variation patterns have their own unique fill-in patterns.

##### ● Normal Pattern Fill-in

##### 1. While a normal pattern is playing, press **7**.

This plays the fill-in for the normal pattern.

- Normal pattern play will resume after the fill in pattern is complete.

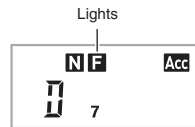

##### ● Variation Pattern Fill-in

##### 1. While a variation pattern is playing, press **8**.

This plays the fill-in for the variation pattern.

- Variation pattern play will resume after the fill in pattern is complete.

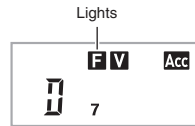

#### ■ Auto Accompaniment Ending

Use the following procedure to play an ending of a few measures.

##### 1. While an Auto Accompaniment is playing, press **9**.

This will play the ending pattern and then stop Auto Accompaniment play automatically.

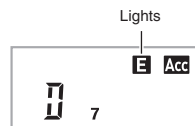



## ■ Using Synchro Start

Use the following procedure to configure the Digital Keyboard to start Auto Accompaniment play as soon as you press a keyboard key.

### 1. Press **9**.

This enters accompaniment start standby.

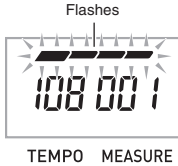

### 2. Play a chord on the keyboard.

This will start full part accompaniment (normal).

Any of the following operations can be performed while in synchro standby to start a non-normal pattern.

- To start with intro pattern, press **6**.
- To start with variation pattern play, press **8**.

## Changing Auto Accompaniment Speed (Tempo)

Use the following procedure to change Auto Accompaniment speed to a level that suits you.

### 1. Press **5**.

Use **∇** (slower) and **∧** (faster) to change the tempo setting. Holding down either button changes the setting at high speed.

- Pressing **∇** and **∧** at the same time will initialize the rhythm setting in accordance with the currently selected rhythm.
- While the tempo value is flashing, you also can use **15** (10-key) to change it.
- If you do not perform any operation for after the tempo setting screen appears, the display will return to the screen displayed before you pressed **5**.



## Adjusting the Accompaniment Volume

Use the following procedure to adjust the balance between what you are playing on the keyboard and the volume of the Auto Accompaniment.

### 1. Press **3** (FUNCTION) a number of times until "AcompVol" appears on the display (page EN-4).

AcompVol

### 2. Use **15** (10-key) [-] and [+] keys to adjust the accompaniment volume.

## Using One-Touch Preset

With One-Touch Preset, the Digital Keyboard automatically configures optimal tone, tempo, and other settings in accordance with the rhythm pattern you select.

### 1. Hold down **13** (RHYTHM) until the current tone screen appears on the display.

This will automatically apply the One-Touch Preset settings in accordance with the rhythm pattern that is currently selected.

### 2. Play a chord on the keyboard.

This will start accompaniment automatically.

# Connecting External Devices

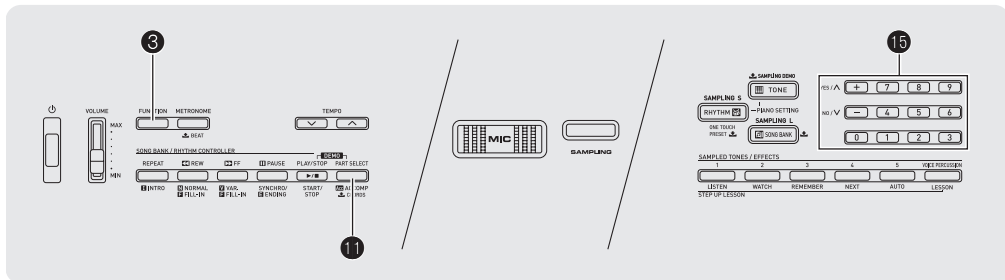

## Connecting a Computer

You can connect the Digital Keyboard to a computer and exchange MIDI data between them. You can send play data from the Digital Keyboard to music software running on your computer, or you can send MIDI data from your computer to the Digital Keyboard for playback.

### Minimum Computer System Requirements

The following shows the minimum computer system requirements for sending and receiving MIDI data. Check to make sure that your computer complies with these requirements before connecting the Digital Keyboard to it.

#### Operating System

- Windows® XP (SP2 or later) \*1
- Windows Vista® \*2
- Windows® 7 \*3
- Windows® 8 \*4
- Windows® 8.1 \*5
- Mac OS® X (10.3.9, 10.4.11, 10.5.X, 10.6.X, 10.7.X, 10.8.X, 10.9.X)

- \*1: Windows XP Home Edition  
Windows XP Professional (32-bit)
- \*2: Windows Vista (32-bit)
- \*3: Windows 7 (32-bit, 64-bit)
- \*4: Windows 8 (32bit, 64bit)
- \*5: Windows 8.1 (32bit, 64bit)

#### USB port

### IMPORTANT!

- Never connect to a computer that does not conform to the above requirements. Doing so can cause problems with your computer.

## Connecting the Digital Keyboard to Your Computer

### IMPORTANT!

- Make sure you follow the steps of the procedure below exactly. Connecting incorrectly can make data send and receive impossible.

1. Turn off the Digital Keyboard and then start up your computer.
  - Do not start up the music software on your computer yet!
2. After starting up your computer, use a commercially available USB cable to connect it to the Digital Keyboard.

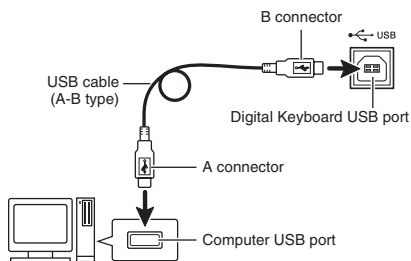

3. Turn on the Digital Keyboard.

- If this is the first time you are connecting the Digital Keyboard to your computer, the driver software required to send and receive data will be installed on your computer automatically.

4. Start up your computer's music software.

## 5. Configure the music software settings to select one of the following as the MIDI device.

CASIO USB-MIDI: For Windows 8.1, Windows 8, Windows 7, Windows Vista, Mac OS X

USB Audio Device: For Windows XP

- For information about how to select the MIDI device, see the user documentation that comes with the music software you are using.

### IMPORTANT!

- Be sure to turn on the Digital Keyboard first before starting up your computer's music software.
- USB send and receive is disabled during playback of a Song Bank song (page EN-17).

### NOTE

- Once you are able to connect successfully, there is no problem with leaving the USB cable connected when you turn off your computer and/or Digital Keyboard.
- This Digital Keyboard conforms to General MIDI Level 1 (GM).
- For detailed specifications and connections that apply to MIDI data send and receive by this Digital Keyboard, see the latest support information provided by the website at the following URL.

<http://world.casio.com/>

## MIDI Settings

### Keyboard Channel

A keyboard channel is the channel used for sending Digital Keyboard data to a computer. You can select the channel you want for sending Digital Keyboard data to a computer.

- The keyboard channel setting range is 01 to 16.

1. Press **(FUNCTION)** a number of times until "Keybd Ch" appears on the display (page EN-4).



2. Use **(10-key) [-]** and **[+]** keys to change the keyboard channel.

### Navigate Channels

The navigate channels can be used to display only the notes of a particular channel (part) as on-screen guide information from among the note information of a tune sent from the computer.

#### ■ Specifying the Navigate Channels

From among the 16 available channels (numbered 1 to 16), you can specify any two neighboring channels (such as 05 and 06) as navigate channels. The smaller numbered channel is the navigate (L) channel, while the larger numbered channel is the navigate (R) channel. Specifying the navigate (R) channel will automatically configure the navigate (L) channel as well.

1. Press **(FUNCTION)** a number of times until "Navi. Ch" appears on the display (page EN-4).



2. Use **(10-key)** to specify the navigate (R) channel.

This will also automatically configure the next lower channel number as the navigate (L) channel.

**Turning Off the Navigate Channel Sound and Playing the Part on the Keyboard**

You can turn off the sound on one or both of the navigate channels and play the cancelled part on the keyboard yourself.

**1. Press **F1** to select the channel setting you want to turn off.**

Each press of **F1** cycles through settings (1) through (4) described below.

- If you turn off one channel, you can play the cancelled part on the keyboard using the same tone as the channel you turned off. If you turn off both channels (option (3)), what you play on the keyboard sounds using the tone of the navigate (R) channel.

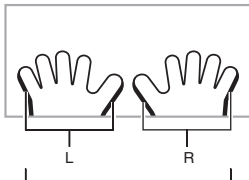

Selected channel indicator appears.

	Navigate (L) Channel		Navigate (R) Channel	
	Sound	On-screen Guide	Sound	On-screen Guide
(1) R only displayed	○	×	×	○
(2) L only displayed	×	○	○	×
(3) LR displayed	×	○	×	○
(4) LR not displayed	○	○	○	○

**Local Control**

There are times when exchanging data with a computer when you may not want the Digital Keyboard to sound notes you play on its keyboard. The local control setting lets you do just that.

**1. Press **F3** (FUNCTION) a number of times until “Local” appears on the display (page EN-4).**



**2. Use **F15** (10-key) [-] and [+] keys to specify the local control setting.**

**Accomp Out**

Enabling the Accomp Out setting causes Auto Accompaniment data to be sent to the computer.

**1. Press **F3** (FUNCTION) a number of times until “AccompOut” appears on the display (page EN-4).**



**2. Use **F15** (10-key) [-] and [+] keys to turn Accomp Out on or off.**

## Connecting to Audio Equipment

This Digital Keyboard can be connected to commercially available stereo, amplifier, or recording equipment, to a portable audio player or other equipment.

### Outputting Digital Keyboard Notes to Audio Equipment

Connection requires commercially available connecting cords, supplied by you. The connecting cords should have a stereo standard plug on one end and a plug that matches the configuration of the external device on the other end.

#### IMPORTANT!

- Turn off the external device when making connections. After connecting, turn down the Digital Keyboard and external device volume levels whenever turning power on or off.
- After connecting, turn on the Digital Keyboard and then the external device.
- If Digital Keyboard notes sound distorted when they are sounded from external audio equipment, lower the Digital Keyboard's volume setting.

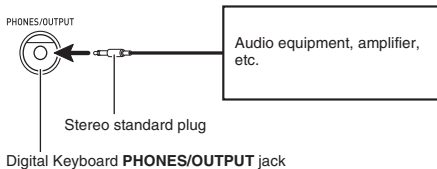

### Playing an External Device from the Digital Keyboard

Connection requires commercially available connecting cords, supplied by you. The connecting cords should have a stereo mini plug on one end and a plug that matches the configuration of the external device on the other end.

#### IMPORTANT!

- Turn off the Digital Keyboard when making connections. After connecting, turn down the Digital Keyboard and external device volume levels whenever turning power on or off.
- After connecting, turn on the external device and then the Digital Keyboard.
- If notes are distorted when they are sounded on the external device, lower the volume setting of the external device.

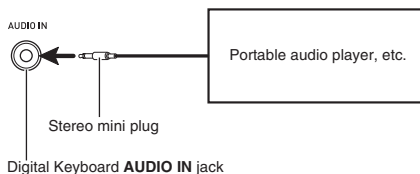

## Troubleshooting

Symptom	Action
<b>Included Accessories</b>	
I can't find something that should be here.	Carefully check inside all of the packing materials.
<b>Power Requirements</b>	
Power will not turned on.	<ul style="list-style-type: none"> <li>• Check the AC adaptor or make sure that the batteries are facing correctly (page EN-5).</li> <li>• Replace the batteries with new ones or switch over to AC adaptor power (page EN-5).</li> </ul>
The Digital Keyboard outputs a loud sound and then suddenly powers down.	Replace the batteries with new ones or switch over to AC adaptor power (page EN-5).
The Digital Keyboard suddenly powers down after a few minutes.	This happens when Auto Power Off (page EN-6) is triggered.
<b>Display</b>	
The display keeps going out or are flashing.	Replace the batteries with new ones or switch over to AC adaptor power (page EN-5).
On-screen keyboard keys or notes remain on the display.	A Step Up Lesson is in progress and the Digital Keyboard is waiting for you to play the next note in the song. To stop this from happening, cancel the lesson (page EN-23).
Screen contents are visible only from straight ahead.	This is dues to production limitations. It does not indicate malfunction.
<b>Sound</b>	
Nothing happens when I press any keyboard key.	<ul style="list-style-type: none"> <li>• Adjust the main volume setting (page EN-6).</li> <li>• Check if something is plugged into the <b>PHONES/OUTPUT</b> jack (35) on the back of the Digital Keyboard.</li> <li>• Turn power off and then back on to initialize all Digital Keyboard settings (page EN-6).</li> </ul>
Nothing happens or notes do not play normally when I play notes on the left side of the keyboard.	Press <b>(11)</b> to disable chord input in the accompaniment keyboard area (page EN-28).
Nothing happens when I start an Auto Accompaniment.	<ul style="list-style-type: none"> <li>• With rhythms 140, and 142 to 150, nothing will sound until you play a chord on the keyboard. Try playing a chord (page EN-28).</li> <li>• Check and adjust the accompaniment volume setting (page EN-31).</li> <li>• Turn power off and then back on to initialize all Digital Keyboard settings (page EN-6).</li> </ul>
Nothing happens when I start playback of a built-in song.	<ul style="list-style-type: none"> <li>• It takes a little time after you press the button until the song starts to play. Wait for a moment for the song to start.</li> <li>• Check and adjust the song volume (page EN-19).</li> <li>• Turn power off and then back on to initialize all Digital Keyboard settings (page EN-6).</li> </ul>
The metronome does not sound.	<ul style="list-style-type: none"> <li>• Check and adjust the accompaniment volume setting (page EN-31).</li> <li>• Check and adjust the song volume (page EN-19).</li> <li>• Turn power off and then back on to initialize all Digital Keyboard settings (page EN-6).</li> </ul>
Notes keep sounding, without stopping.	<ul style="list-style-type: none"> <li>• Turn power off and then back on to initialize all Digital Keyboard settings (page EN-6).</li> <li>• Replace the batteries with new ones or switch over to AC adaptor power (page EN-5).</li> </ul>

Symptom	Action
Some notes are cut off while they are playing.	Notes are cut off whenever the number of notes being sounded exceeds the maximum polyphony value of 48 (24 for some tones). This does not indicate malfunction.
The volume or tone setting I made has changed.	<ul style="list-style-type: none"> <li>Adjust the main volume setting (page EN-6).</li> <li>Turn power off and then back on to initialize all Digital Keyboard settings (page EN-6).</li> <li>Replace the batteries with new ones or switch over to AC adaptor power (page EN-5).</li> </ul>
In certain keyboard ranges, the volume and tone quality sound are slightly different from those in other keyboard ranges.	This is due to system limitations. It does not indicate malfunction.
With some tones, octaves do not change at the far ends of the keyboard.	This is due to system limitations. It does not indicate malfunction.
The pitch of the notes does not match other accompanying instruments or sounds strange when played long with other instruments.	<ul style="list-style-type: none"> <li>Check and adjust the transpose (page EN-10) and tuning settings (page EN-10).</li> <li>Turn power off and then back on to initialize all Digital Keyboard settings (page EN-6).</li> </ul>
The reverb of notes seems to change suddenly.	<ul style="list-style-type: none"> <li>Check and adjust the reverb setting (page EN-9).</li> <li>Turn power off and then back on to initialize all Digital Keyboard settings (page EN-6).</li> </ul>
Sounds I sampled were deleted.	Be sure to press the power button to turn off power. Unplugging or disconnecting the AC adaptor without first pressing the power button to turn off power will cause sampled sounds to be deleted.
Even though I didn't input anything with the built-in microphone, the message "Sampled!" appears on the display when I release the <b>SAMPLING</b> button.	<ul style="list-style-type: none"> <li>Perform the sampling operation where it is quiet.</li> <li>You may be making noise, which is picked up as sampled sound, when releasing the <b>SAMPLING</b> button release operation. If this is the case, release the <b>SAMPLING</b> button carefully to avoid making noise.</li> <li>Use the procedure under "Starting a Sampling Operation Manually" (page EN-15) to turn off SampAuto, and then try manual sampling.</li> </ul>
Rhythms played in the VOICE PERCUSSION Mode sound strange and unnatural.	In order to assure proper balance for the rhythm, be sure to record all five short samples. Playing a rhythm in the VOICE PERCUSSION Mode while there is no short sample will cause a preset sample to sound. If there is even a single short sample recorded, rhythm instruments will sound only for the recorded short sample.
<b>Operation</b>	
When I perform a skip forward or skip back operation, the skip operation moves multiple song measures instead of only a single measure.	While song playback is stopped or a Step Up Lesson is in progress, skip forward and skip back operations are performed in phrase units (page EN-18).
<b>Computer Connection</b>	
I can't exchange data between the Digital Keyboard and a computer.	<ul style="list-style-type: none"> <li>Check to make sure that the USB cable is connected to the Digital Keyboard and computer, and that the device is selected correctly with your computer's music software settings (page EN-32).</li> <li>Turn off the Digital Keyboard and then exit the music software on your computer. Next, turn the Digital Keyboard back on and then restart the music software on your computer.</li> </ul>

## Specifications

<b>Model</b>	CTK-2090/CTK-2400
<b>Keyboard</b>	61 standard-size keys
<b>Maximum Polyphony</b>	48 notes (24 for certain tones)
<b>Tones</b>	
Built-in Tones	400
Sampling Tones	1 (Long Sampling) or 5 (Short Sampling) Sampling Time: 2 second (Long Sampling) or approximately 0.4 seconds each (Short Sampling) Effects: 5 types Sampling Demo Tune: 1
<b>Reverb</b>	1 to 10, Off
<b>Metronome</b>	
Beats per Measure	0, 2 to 6
Tempo Range	30 to 255
<b>Song Bank</b>	
Tunes	110
<b>Step Up Lesson</b>	
Lessons	5 (Listen, Watch, Remember, Next, Auto)
Lesson Part	L, R, LR
Functions	Repeat, Voice Fingering Guide, Note Guide, Performance Evaluation
<b>Auto Accompaniment</b>	
Rhythm Patterns	150
One Touch Presets	150
<b>Other Functions</b>	
Transpose	±1 octaves (-12 to +12 semitones)
Tuning	A4 = 415.5 to 465.9 Hz (Initial Default: 440.0 Hz)
<b>MIDI</b>	16 multi-timbre received, GM Level 1 standard
<b>Musical Information Function</b>	Tone, Rhythm, Song Bank numbers and names, staff notation, fingering, pedal operation, tempo, measure and beat number, chord name, etc.
<b>Inputs/Outputs</b>	
USB port	TYPE B
Sustain jack	Standard jack (sustain, sostenuto, soft, rhythm)
Phones/Output jack	Stereo standard jack Output Impedance: 200Ω, Output Voltage: 4.5V (RMS) MAX
Audio In jack	Stereo mini jack Input Impedance: 9kΩ, Input Sensitivity: 200mV
Built-in microphone	
<b>Power Jack</b>	9.5V DC
<b>Power Supply</b>	2-way
Batteries	6 AA-size zinc-carbon batteries or alkaline batteries
Battery Life	Approximately 3 hours continuous operation on alkaline batteries
AC Adaptor	AD-E95100L
Auto Power Off	Approximately 6 minutes (during battery operation) or 30 minutes (during AC adaptor operation) without any operation
<b>Speakers</b>	10cm × 2
Output	2W + 2W
<b>Power Consumption</b>	9.5V --- 7.7W
<b>Dimensions</b>	94.6 × 30.7 × 9.2 cm (37 1/4 × 12 1/16 × 3 5/8 inch)
<b>Weight</b>	Approximately 3.4kg (7.5 lbs) (without batteries)

- Design and specifications are subject to change without notice.



## Operating Precautions

Be sure to read and observe the following operating precautions.

### ■ Location

Avoid the following locations for this product.

- Areas exposed to direct sunlight and high humidity
- Areas subjected to temperature extremes
- Near a radio, TV, video deck, or tuner

The above devices will not cause malfunction of the product, but interference from the product can cause audio or video interference of a nearby device.

### ■ User Maintenance

- Never use benzine, alcohol, thinner, or other chemical agents to clean the product.
- To clean the product or its keyboard, wipe with a soft cloth moistened in a weak solution of water and a mild neutral detergent. Wring all excess moisture from the cloth before wiping.

### ■ Included and Optional Accessories

Use only accessories that are specified for use with this product. Use of unauthorized accessories creates the risk of fire, electric shock, and personal injury.

### ■ Weld Lines

Lines may be visible on the exterior of the product. These are "weld lines" that result from the plastic molding process. They are not cracks or scratches.

### ■ Musical Instrument Etiquette

Always be aware of others around you whenever using this product. Be especially careful when playing late at night to keep the volume at levels that do not disturb others. Other steps you can take when playing late at night are closing the window and using headphones.

## Song List

### SONG BANK

WORLD	
001	TWINKLE TWINKLE LITTLE STAR
002	LIGHTLY ROW
003	LONG LONG AGO
004	ON TOP OF OLD SMOKEY
005	SAKURA SAKURA
006	WHEN THE SAINTS GO MARCHING IN
007	AMAZING GRACE
008	AULD LANG SYNE
009	COME BIRDS
010	DID YOU EVER SEE A LASSIE?
011	MICHAEL ROW THE BOAT ASHORE
012	DANNY BOY
013	MY BONNIE
014	HOME SWEET HOME
015	AURA LEE
016	HOME ON THE RANGE
017	ALOHA OE
018	SANTA LUCIA
019	FURUSATO
020	GREENSLEEVES
021	JOSHUA FOUGHT THE BATTLE OF JERICHO
022	THE MUFFIN MAN
023	LONDON BRIDGE
024	UNDER THE SPREADING CHESTNUT TREE
025	SIPPIN' CIDER THROUGH A STRAW
026	GRANDFATHER'S CLOCK
027	ANNIE LAURIE
028	BEAUTIFUL DREAMER
029	IF YOU'RE HAPPY AND YOU KNOW IT, CLAP YOUR HANDS
030	MY DARLING CLEMENTINE
031	LITTLE BROWN JUG
032	HOUSE OF THE RISING SUN
033	SHE WORE A YELLOW RIBBON
034	YANKEE DOODLE
035	MY OLD KENTUCKY HOME
036	SZLA DZIEWECZKA
037	TROIKA
038	WALTZING MATILDA
039	ON THE BRIDGE OF AVIGNON
040	I'VE BEEN WORKING ON THE RAILROAD
041	OH! SUSANNA
042	CAMPTOWN RACES
043	JEANNIE WITH THE LIGHT BROWN HAIR
044	TURKEY IN THE STRAW
045	JAMAICA FAREWELL

EVENT	
046	SILENT NIGHT
047	WE WISH YOU A MERRY CHRISTMAS
048	JINGLE BELLS
049	JOY TO THE WORLD
050	O CHRISTMAS TREE
PIANO/CLASSICS	
051	MARY HAD A LITTLE LAMB
052	LE CYGNE FROM "LE CARNAVAL DES ANIMAUX"
053	JE TE VEUX
054	SONATA op.13 "PATÉTIQUE" 2nd Mov.
055	HEIDENRÖSLEIN
056	AIR FROM "SUITE no.3"
057	SPRING FROM "THE FOUR SEASONS"
058	HABANERA FROM "CARMEN"
059	BRINDISI FROM "LA TRAVIATA"
060	HUNGARIAN DANCES no.5
061	MINUET IN G MAJOR
062	MUSETTE IN D MAJOR
063	GAVOTTE (GOSSEC)
064	ARABESQUE (BURGMÜLLER)
065	CHOPSTICKS
066	DECK THE HALL
067	ODE TO JOY
068	AVE MARIA (GOUNOD)
069	SONATINA op.36 no.1 1st Mov.
070	PRELUDE op.28 no.7 (CHOPIN)
071	RÉVERIE
072	GYMNOPÉDIÉS no.1
073	GOING HOME FROM "FROM THE NEW WORLD"
074	FÜR ELISE
075	TURKISH MARCH (MOZART)
076	SONATA op.27 no.2 "MOONLIGHT" 1st Mov.
077	ETUDE op.10 no.3 "CHANSON DE L'ADIEU"
078	THE ENTERTAINER
079	WEDDING MARCH FROM "MIDSUMMER NIGHT'S DREAM"
080	AMERICAN PATROL
081	FRÖHLICHER LANDMANN
082	LA CHEVALERESQUE
083	SONATA K.545 1st Mov.
084	LA PRIÈRE D'UNE VIERGE
085	VALSE op.64 no.1 "PETIT CHIEN"
086	LIEBESTRÄUME no.3
087	JESUS BLEIBET MEINE FREUDE
088	CANON (PACHELBEL)
089	SERENADE FROM "EINE KLEINE NACHTMUSIK"
090	MARCH FROM "THE NUTCRACKER"
EXERCISE	
091-100	EXERCISE I
101-110	EXERCISE II

## Fingering Guide

### Fingered 1, Fingered 2 Chords

<b>C</b>	
<b>Cm</b>	
<b>Cdim</b>	
<b>Caug</b> *3	
<b>Csus4</b> *3	
<b>Csus2</b> *3	
<b>C7</b>	
<b>Cm7</b> *3	
<b>CM7</b>	
<b>Cm7<sup>b5</sup></b> *3	
<b>C7<sup>b5</sup></b> *3	
<b>C7sus4</b>	
<b>Cadd9</b>	
<b>Cmadd9</b>	
<b>CmM7</b>	
<b>Cdim7</b> *3	
<b>C69</b> *3	
<b>C6</b> *1 *3	
<b>Cm6</b> *2 *3	

\*1 With Fingered 2, interpreted as Am7.

\*2 With Fingered 2, interpreted as Am7<sup>b5</sup>.

\*3 Inverted form not supported in some cases.

### Fingered 3, Full Range Chords

In addition to the chords that can be fingered with Fingered 1 and Fingered 2, the following chords also are recognized.

$\frac{C\#}{C}$	$\frac{D}{C}$	$\frac{E}{C}$	$\frac{F}{C}$	$\frac{G}{C}$	$\frac{A^b}{C}$	$\frac{B^b}{C}$	$\frac{B}{C}$	$\frac{C\#m}{C}$	$\frac{Dm}{C}$	$\frac{Fm}{C}$
$\frac{Gm}{C}$	$\frac{Am}{C}$	$\frac{B^bm}{C}$	$\frac{Ddim}{C}$	$\frac{A^b7}{C}$	$\frac{F7}{C}$	$\frac{Fm7}{C}$	$\frac{Gm7}{C}$	$\frac{A^badd9}{C}$		

#### NOTE

- With Fingered 3, the lowest note fingered is interpreted as the base note. Inverted forms are not supported.
- With Full Range Chord, when the lowest note fingered is a certain distance from the neighboring note, the chord is interpreted as a fraction chord.
- Unlike Fingered 1, 2, and 3, Full Range Chord requires pressing of at least three keys to form a chord.

Chord Example List

Root Chord Type	C	C <sup>♯</sup> (D <sup>♯</sup> )	D	(D <sup>♯</sup> )/E <sup>♯</sup>	E	F	F <sup>♯</sup> (G <sup>♯</sup> )	G	(G <sup>♯</sup> )/A <sup>♯</sup>	A	(A <sup>♯</sup> )/B <sup>♯</sup>	B
M												
m												
dim												
aug												
sus4												
sus2												
7												
m7												
M7												
m7 <sup>♯5</sup>												
7 <sup>♯5</sup>												
7sus4												
add9												
madd9												
mM7												
dim7												
69												
6												
m6												

• Since the chord input range is limited, this model may not support some of the chords shown above.

# MIDI Implementation Chart

Function	Transmitted	Recognized	Remarks
<b>Basic Channel</b> Default Changed	1 1 - 16	1 - 16 1 - 16	
<b>Mode</b> Default Messages Altered	Mode 3 X * * * * * * * * * *	Mode 3 X * * * * * * * * * *	
<b>Note Number</b> True voice	36 - 96 * * * * * * * * * *	0 - 127 0 - 127 *1	
<b>Velocity</b> Note ON Note OFF	0 9nH v = 100 X 9nH v = 0	0 9nH v = 1 - 127 X 9nH v = 0, 8nH v = **	**:.no relation **:.sin relación
<b>After Touch</b> Key's Ch's	X X	X O	
<b>Pitch Bender</b>	X	O	
<b>Control Change</b> 0, 32 1 6, 38 7 10 11	O X X O O X	O (MSB only) O O *2 O O O O	Bank select Modulation Data entry Volume Pan Expression

64 66 67 91 100, 101	O *3 O *3 O *3 X X	O *3 O *3 O *3 X X	O O O O O *2	Hold 1 Sostenuto Soft pedal Reverb send RPN LSB, MSB
<b>Program Change</b> : True #	O 0 - 127 * * * * * * * * * *	O 0 - 127 * * * * * * * * * *	O 0 - 127	
<b>System Exclusive</b>	O *2	O *2	O *2	
<b>System Common</b> : Song Pos : Song Sel : Tune	X X X	X X X	X X X	
<b>System Real Time</b> : Clock : Commands	O O	O O	X X	
<b>Aux Messages</b> : All sound off : Reset all controller : Local ON/OFF : All notes OFF : Active Sense : Reset	X O X O X X	X O X O X X	O O X O O X	
<b>Remarks</b>	*1: Depends on tone. *2: For details about NRPN, RPN, and system exclusive messages, see MIDI Implementation at <a href="http://world.casio.com/">http://world.casio.com/</a> . *3: In accordance with pedal effect setting.			

Mode 1 : OMNI ON, POLY  
Mode 2 : OMNI ON, MONO  
Mode 3 : OMNI OFF, POLY  
Mode 4 : OMNI OFF, MONO

O : Yes  
X : No



This recycle mark indicates that the packaging conforms to the environmental protection legislation in Germany.

Esta marca de reciclaje indica que el empaquetado se ajusta a la legislación de protección ambiental en Alemania.

# CASIO®

 MA1402-A Printed in China



CTK2400-ES-1A

**CASIO COMPUTER CO., LTD.**  
6-2, Hon-machi 1-chome  
Shibuya-ku, Tokyo 151-8543, Japan

© 2014 CASIO COMPUTER CO., LTD.

## Free Manuals Download Website

<http://myh66.com>

<http://usermanuals.us>

<http://www.somanuals.com>

<http://www.4manuals.cc>

<http://www.manual-lib.com>

<http://www.404manual.com>

<http://www.luxmanual.com>

<http://aubethermostatmanual.com>

Golf course search by state

<http://golfingnear.com>

Email search by domain

<http://emailbydomain.com>

Auto manuals search

<http://auto.somanuals.com>

TV manuals search

<http://tv.somanuals.com>