

# FIVA

## User's Guide

(MPC-501 series)

FIVA

Thank you for purchasing the CASIO FIVA MPC-501.  
This guide describes the basic operations of the product.

Read this guide in its entirety before handling or operating the product, and keep it close at hand so it can be easily referenced.

**CASIO**®

## **International ENERGY STAR® Program**

As a member of the International ENERGY STAR® Program, CASIO products have been judged to meet International ENERGY STAR® standards.

ENERGY STAR® is a U.S. registered mark.



## **Power Plug and AC Adaptor**



AC cord plug and wall outlet illustrated in this User's Guide shows the two-pin plug type. It may not be the same shape of AC cord plug used in your area.

FIVA's AC adaptor has an automatic voltage switching circuit (input: 100 to 240VAC, 50/60Hz) and lets you use your FIVA under AC power virtually anywhere in the world without having an extra power-transformer.

Note, however, that AC cord plug shape differs according to area you are in. Make sure that the AC cord you will use can fit into wall outlet and is compliance with the local electric safety standard.

- 
- Microsoft, MS-DOS and Windows are registered trademarks of Microsoft Corporation in the United States and/or other countries.
  - PS/2 is a registered trademark of International Business Machines Corporation in the United States.
  - smARTwriter, smARTscribble and Quick Trainer are trademarks or registered trademarks of Advanced Recognition Technologies in the United States.
  - Other company, product and service names used herein may also be trademarks or service marks of respective companies.

# Packing List

Thank you for purchasing the CASSIOPEIA FIVA MPC-501 series. A list of the items included with this product is given below. Confirm that nothing is missing or damaged. If anything is missing or damaged, contact the dealer from which you purchased this product.

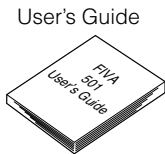
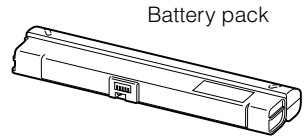
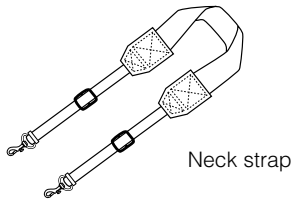
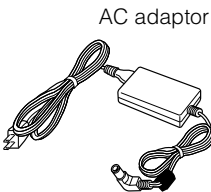
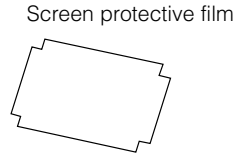
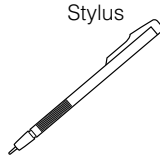
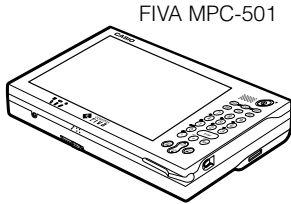

Keep in a safe place

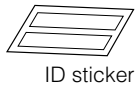

(Not included with the MPC-501M630)

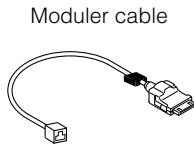

(Standard with the MPC-501M62E)

- Do not dispose of the box and packing materials. Use the box and packing materials for storage and transport.

# Safety Precautions

- To use this product safely and correctly, read this User's Guide thoroughly and operate as instructed. After reading this guide, keep it close at hand for easy reference. Please keep all informations for future reference.
- Always observe the warnings and cautions indicated on the product.
- If this guide is misplaced or damaged so as to be unreadable, a new one can be ordered. To obtain a new User's Guide, contact the dealer from which this product was purchased.

## About the icons

In this guide various icons are used to highlight safe operation of this product and to prevent injury to the operator and other personnel and also to prevent damage to property and this product. The icons and definitions are given below.

 **Warning!** Indicates that there is a risk of severe injury or death if used incorrectly.

 **Caution!** Indicates that injury or damage may result if used incorrectly.

### *Icon examples*

To bring attention to risks and possible damage, the following types of icons are used.



The  symbol indicates that it includes some symbol for attracting attention (including warning). In this triangle the actual type of precautions to be taken (electric shock, in this case) is indicated.



The  symbol indicates a prohibited action. In this symbol the actual type of prohibited actions (disassembly, in this case) will be indicated.



The  symbol indicates that a restriction. In this symbol the type of actual restriction (removal of the power plug from an outlet, in this case) is indicated.

## Warning!

### Handling FIVA

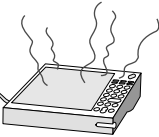

Should FIVA malfunction, start to emit smoke or a strange odor, or otherwise behave abnormally, immediately shut down the power, remove batteries, and unplug the AC adaptor from the power outlet. Continued use creates the danger of fire and electric shock.

- Contact your original retailer or authorized distributor.



Do not place containers of liquids near FIVA and do not allow any foreign matter to get into it. Should water or other foreign matter get into FIVA, immediately shut down the power and unplug the AC adaptor from the power outlet. Continued use creates the danger of shorting, fire and electric shock.

- Contact your original retailer or authorized distributor.



Never bring in FIVA a bathroom or any other location where the possibility of splashing or high humidity exists. Use of FIVA in such an area creates the danger of electric shock. Be especially carefully when using FIVA while rain or snow is falling, or in beach areas.

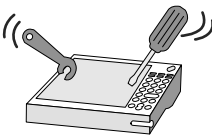

Never try to take FIVA apart or modify it in any way. High-voltage components inside FIVA create the danger of fire and electric shock.

- Contact your authorized distributor for all repair and maintenance.

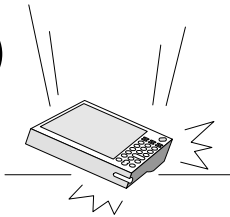

Should you drop FIVA and damage it, immediately shut down the power and unplug the AC adaptor from the power outlet. Continued use creates the danger of shorting, fire and electric shock.

- Attempting to repair FIVA yourself is extremely dangerous. Contact your authorized distributor for all repair and maintenance.

## **Warning!**

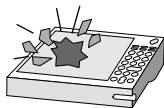

**The liquid inside the LCD is harmful to humans. Never touch it or allow it to get in your mouth.**

- Should liquid from the LCD panel accidentally get into your mouth immediately wash out your mouth with clean water. If it gets onto your skin, immediately rinse for at least 15 minutes with clean tap water. In either case, consult a physician.

### **Power Plug and AC Adaptor**



AC cord plug and wall outlet illustrated in this User's Guide shows the two-pin plug type. It may not be the same shape of AC cord plug used in your area.

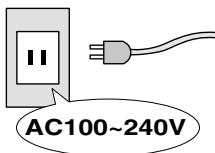

**Use only a proper AC electric outlet (100V~240V) when powering FIVA with the AC adaptor. Use of an outlet with a different voltage from the rating creates the danger of malfunction, fire, and electric shock. Overloading an electric outlet creates the danger of overheating and fire.**

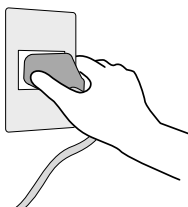

**Make sure the power plug and AC adaptor plug are inserted as far as they will go. Loose plugs create the danger of electric shock, overheating, and fire.**

- Do not use the adaptor if the plug is damaged. Never connect to a power outlet that is loose.

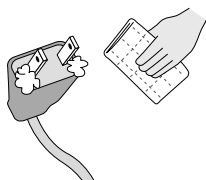

**Use a dry cloth to periodically wipe off any dust built up on the prongs of the plug. Humidity can cause poor insulation and create the danger of electric shock and fire if dust stays on the prongs.**

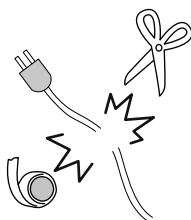

**Do not allow the power cord or plug to become damaged, and never try to modify them in any way. Continued use of a damaged power cord can cause deterioration of the insulation, exposure of internal wiring, and shorting, which creates the danger of electric shock and fire.**

- Contact your authorized distributor whenever the power cord or plug requires repair or maintenance.

## **Warning!**

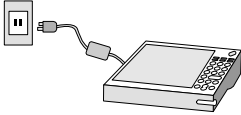

Use only the AC adaptor specified by CASIO for this product. Use of another type of AC adaptor creates the danger of fire.

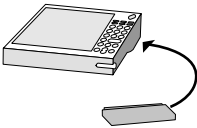

Use only the battery pack that comes with FIVA. When the battery pack reaches the end of its life, replace it with a new battery pack as specified by CASIO. Other types of batteries have different voltage rating and polarity, which creates the danger of fire and bursting of the batteries.

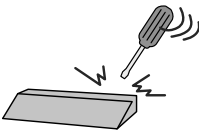

Never try to take the battery pack apart or modify it in any way. Doing so creates the danger of overheating, fire, and bursting of the battery pack.



Never throw the battery pack into fire or otherwise expose it to direct flame. Doing so creates the danger of fire and explosion.

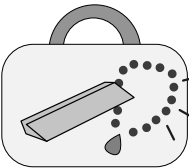

Never allow the positive (+) and negative (-) poles of the batteries to become connected by metal. Do not store or transport the battery pack together with metal necklaces, hairpins, or other metal items. Connection of the battery pack poles creates the danger of overheating, fire, and explosion.

- When transporting or storing the battery pack, wrap it in plastic to keep the poles away from metal items that might cause a short.

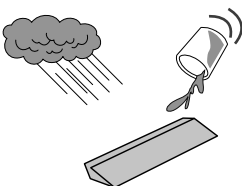

Never allow the battery pack to be exposed to water or moisture. Moisture creates the danger of overheating, fire, and explosion. Should the battery pack ever become wet, immediately stop using it.

## **Caution!**

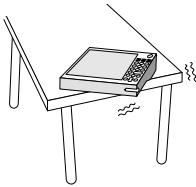

**Do not place FIVA on an unstable or uneven surface. Doing so can cause FIVA to fall, creating the danger of malfunction, fire, and electric shock.**

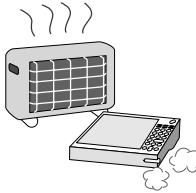

**Do not leave FIVA in the following areas.**

- Areas where FIVA will be subject to large amounts of humidity or dust, or directly exposed to hot or cold air.
- Areas exposed to direct sunlight, in a close motor vehicle, or any other area subject to very high temperatures.

**The above conditions can cause malfunction or deformation of FIVA, which creates the danger of fire.**



**When transporting FIVA, take care to avoid subjecting it to vibration and impact. This unit contains a hard disk and other precision components that can be damaged by rough handling.**

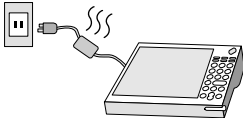

**The AC adaptor normally becomes warm during use. Avoid allowing the AC adaptor to rest on your lap or other part of your body when using it for long period. Long term with the AC adaptor creates the danger of burns.**

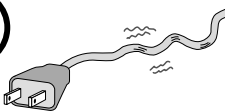

**Do not overly bend the power cord, do not allow it to be caught between desks or other furniture, and never place heavy objects on top of the power cord. Doing so can cause shorting or breaking of the power cord, creating the danger of fire and electric shock.**



## **Caution!**

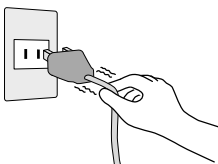

**Be sure to grasp the plug when unplugging the power cord from the wall outlet. Pulling on the cord can damage it, break the wiring, or cause short, creating the danger of fire and electric shock.**

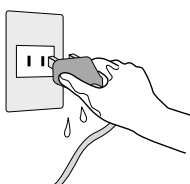

**Never touch the plug while your hands are wet. Doing so creates the danger of electric shock. Pulling on the cord can damage it, break the wiring, or cause short, creating the danger of fire and electric shock.**



**Avoid use in areas where the brightness around the display is very different from surrounding lighting, or where the sunlight is shining directly on the display. Such conditions can cause eye fatigue.**

## Before Using FIVA

---

- This product has been designed and manufactured under stringent quality control. Should you suspect FIVA is defective or malfunctioning, contact your original dealer or authorized distributor. Repair and maintenance are subject to the terms and conditions of the Warranty.
- CASIO COMPUTER CO., LTD. shall not be held liable for any loss or claims due to using this product except as instructed to do so in this User's Guide.
- CASIO COMPUTER CO., LTD. shall not be held liable for any loss or claims (lost profits, interruption of business, corruption or loss of memory data, etc.) by you or any third party due to the use of this product or the inability to use this product for a specific purpose, except as specifically stipulated by law.
- Unauthorized copying of this product or its software is prohibited.
- This product is guaranteed only when operating under the version of Windows 98 that comes bundled with it.

### ***Product Application***

- This product is intended for use as a general office computing device.
- CASIO makes no warranties that this product is fault-tolerant. It is not designed, manufactured or intended for use in any equipment or system (such as traffic control devices, safety devices, medical devices, etc.) where the malfunction or misoperation of FIVA could lead directly to death, personal injury, or serious damage to physical assets.

### ***System Recovery***

- This product comes with Windows 98 and a collection of utility software pre-installed on its hard disk. Should the system start to malfunction or produce errors, you can use the "Product Recovery CD-ROM" that comes with FIVA to restore the factory default system. This returns FIVA the same settings and state it was in when you originally purchased it.



**Note**

Windows 98 and other software are not pre-installed in the MPC-501M63O.

## **Computer Viruses**

### ***Avoiding Computer Viruses***

A computer virus is a program. It gets installed on your system without you being aware of it, and can do anything from displaying strange messages to destroying your data and other programs. A virus can enter your system via a floppy diskette or network. Taking the following precautions are normally sufficient to protect against having a virus invade your system.

- Write protect the master copies of your programs and data files.
- Never open data files or run programs of unknown origin.
- Use a commercially available virus checker to check new programs, and periodically check your system for virus contamination.

### ***Use the latest version of a commercially available virus checker to check your system.***

An immediate virus check is recommended in the following cases.

- Check your system each time you start up your computer.
- Check any data file or program you received on a floppy diskette or other external media, over a network, from a BBS or the Internet, via e-mail, etc. before opening the file or running the program.

## FIVA

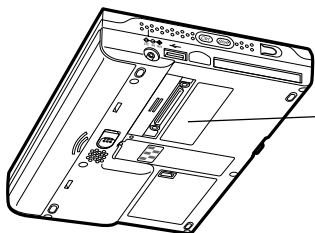

### Caution

- Turn off this product before connecting or disconnecting peripherals.
- Never apply impact or vibration.
- Never take this product apart.
- Use only the specified AC adaptor.
- The bottom of this product becomes warm during use. Avoid using it in your lap for a long period.

### Precaution Label

- The label shown above is affixed to the bottom of FIVA. Be sure to carefully observe these precautions at all times. Never remove this label. Should this label ever start to come off or should its contents become unreadable, contact your original dealer or authorized distributor.

### Power Requirements

- Plug the AC adaptor into a power outlet rated for 100V to 240V AC, 50/60Hz only.
- Do not connect FIVA to the same outlet of another device that generates electrical noise. Such a device can corrupt data in FIVA.

### Turning Off Power

- Never unplug the power cord or otherwise cut off power to FIVA while the system is starting up or while a program is running. Doing so can cause data to be lost or corrupted, and can lead to malfunction of FIVA.
- Do not turn power off and then suddenly back on again. Doing so can cause data to be lost or corrupted, and can lead to malfunction of FIVA.

### Cables

- Use only the cables that come with FIVA to connect it to other optional equipment.
- Never pull on cable or place a heavy object on it. Doing so can cause the cable to break or short.

### ***Avoid Strong Vibration and Impact***

- Strong vibration or impact can cause malfunction. Be particularly careful when FIVA is turned on. Vibration and impact can cause corruption of data on built-in hard disk.

### ***Transporting FIVA***

- Be sure to shut down the power and disconnect all options (port replicator, CD-ROM drive, etc.) before removing FIVA. Leaving cables connected while removing FIVA can damage the cables and creates the danger of accident.
- Store FIVA in its case whenever you are transporting it or not using it. Doing so protects FIVA against damage.

### ***Avoid Water and Moisture***

- FIVA is not water resistant. Never use or store FIVA where there is the danger it might become exposed to water or moisture.

## ***Options***

- Be sure to carefully follow the procedures provided in the applicable User's Guides whenever connecting or disconnecting peripherals. Failure to do so can damage FIVA or the peripheral.

#### ***AC adaptor: WARNING***

- Use AC adaptor type MPC-577ADP (SQS45W16P-02).

#### ***Main battery: WARNING***

- Replace this main battery with Model MPC-173BAT or MPC-174LBAT.

Use of another battery may present a risk of fire or explosion.

- This battery pack is suitable for use only with MPC-501 series.
- Keep away from children.
- Dispose of used batteries according to the manufacturer's instruction.

### ***Non-CASIO options***

- Check with each manufacturer for compatibility before using any non-CASIO options with this unit.
- CASIO assumes no responsibility for any loss (including but not limited to personal injury, material loss, damage to FIVA) suffered by you or other arising out of the use of a non-CASIO option.

### ***Use Only as Directed***

- Be sure to connect or disconnect an option only as expressly directed in the documentation that comes with the option.
- Incorrect use of options can cause malfunction and serious damage to FIVA, which can required extensive repair work to correct.

## ***Floppy Diskette and Hard Disk Data***

### ***Disk Operations***

- A lit hard disk drive or floppy disk drive access lamp indicates that a disk operation is being performed.
- Never shut down while a hard disk drive or floppy disk drive operation is being performed. Also, never eject the floppy diskette while a floppy disk drive operation is being performed. Doing so can make data or applications on the disk unusable.

### ***Backup Data***

- You should occasionally back up data on the hard disk by copying it to floppy diskette. This ensures that you always have backup data on hand in case of accidental data deletion or corruption caused by mis-operation, malfunction, maintenance, etc.

***Note that CASIO is not liable for any losses suffered by you or any third party due to the loss of data stored on FIVA's hard disk.***

### ***Formatting a Floppy Diskette***

- Formatting a floppy diskette deletes all data stored on it.
- Be sure to check the contents of a floppy diskette before formatting it.

## ***CD-ROM***

### ***Protecting CD-ROMs from Dirt and Dust***

- Keep CD-ROMs in their original cases, and store them in a safe place.
- Handle CD-ROMs by pinching between two fingers, one inside the center hold and one on the outside edge of the disk.
- Never bend a CD-ROM, write on its surface, or allow its surface to become damaged.
- Do not affix labels to a CD-ROM.
- Keep CD-ROMs out of direct sunlight and areas exposed to extreme heat or cold.
- To clean a CD-ROM, wipe it with a soft dry cloth. Wipe from the center outwards to the edge.

### ***Consumables***

The following items are consumables.

You will need to inform your original dealer or authorized distributor of the model number of your unit when purchasing the stylus, screen protective film, and battery pack.

### **Stylus**

- Purchase a new stylus whenever the tip of your stylus becomes damaged.

### **Screen Protective film**

- Purchase a new screen protective film when the one on your FIVA becomes scratched to the point that it makes display contents difficult to see.

### **Standard Battery Pack**

- Long use of the battery pack causes it to deteriorate and lose its ability to recharge. If you feel your battery pack is not providing enough operating time, it may be time to contact your dealer or authorized distributor about purchasing a new one.

### **Disposal**

When it comes time to dispose of your FIVA, do so in accordance with local regulations in your area. Contact your local government authorities for details about proper disposal methods.

## **Maintenance and Care**

---

### **Normal Care**



**Shut down the power and unplug the power cord from the power outlet before cleaning FIVA. Cleaning FIVA with the power on creates the danger of electric shock.**

- Clean FIVA by wiping it with a soft, dry cloth. If FIVA is very dirty, wipe it with a cloth that has been moistened with a weak solution of water and a mild neutral detergent. Wring out all excess of moisture before wiping. Take particular care to keep the contacts on the bottom of the FIVA clean. Dirty contacts can lead to malfunction.
- Clean the LCD by wiping it with a soft, dry cloth. Never use water, detergent, or chemical agents to clean the LCD. The surface of the LCD is easily scratched. Never apply excess pressure when wiping it.
- Also, use a soft cloth to clean the tip of the stylus. Take care that you do not misplace your stylus.
- Thinner, benzene, or other organic agents can cause deformation or discoloration of FIVA's case, and even malfunction of FIVA. Never use such agents when cleaning FIVA.

- Keep the tip of the stylus free of dirt by wiping it periodically with a soft cloth. Also take care that you do not misplace or lose the stylus.
- Clean the FIVA screen by wiping it with a soft, clean cloth. Never use water, neutral detergents, or chemically treated cloths to clean the screen. A dirty screen can interfere with response to stylus operations, and smooth movement of the stylus tip. The screen is easily scratched, so take care that you do not apply too much pressure when cleaning it.

### ***Maintenance***



**Never remove FIVA'S outer cover or otherwise try to take it apart or modify it in any way. High voltage inside the case creates the danger of electric shock.**

Whenever you notice any of the following symptoms, immediately shut down the power, unplug the AC adaptor from the power outlet, and contact your original dealer or authorized distributor.

- Damaged power cord or plug
- Liquid leaking from FIVA
- Exposure of FIVA to water or rain
- Unit being dropped
- Damaged unit cover
- Very abnormal function
- Abnormal operation

Never try to make any adjustments except as specifically instructed by this User's Guide. Improper adjustment or modification of FIVA can permanently damage it and make it impossible to restore normal operation.

Never attempt to repair or modify this unit in any way.



The CE marking below applies to the EU region. Declarator of conformity is as follows:



**CASIO ELECTRONICS CO. LTD.**

Unit 6, 1000 North Circular Road, London NW2 7JD

**GUIDELINES LAID DOWN BY FCC RULES FOR USE OF THIS UNIT IN THE U.S.A.  
(not applicable to other areas.)**

**NOTICE**

This equipment has been tested and found to comply with the limits for a Class B digital device, pursuant to Part 15 of the FCC Rules. These limits are designed to provide reasonable protection against harmful interference in a residential installation. This equipment generates, uses and can radiate radio frequency energy and, if not installed and used in accordance with the instructions, may cause harmful interference to radio communications. However, there is no guarantee that interference will not occur in a particular installation. If this equipment does cause harmful interference to radio or television reception, which can be determined by turning the equipment off and on, the user is encouraged to try to correct the interference by on or more of the following measures:

- Reorient or relocate the receiving antenna.
- Increase the separation between the equipment and receiver.
- Connect the equipment into an outlet on a circuit different from that to which the receiver is connected.
- Consult the dealer or an experienced radio/TV technician for help.

**FCC WARNING**

Changes or modifications not expressly approved by the party responsible for compliance could void the user's authority to operate the equipment.

**Declaration of Conformity**

Model Number: MPC-501M63E, MPC-501M63O, MPC-501M62E  
Trade Name: CASIO  
Responsible party: CASIO INC.  
Address: 570 Mt. Pleasant Avenue, Dover, New Jersey 07801.  
Telephone number: 973-361-5400

This device complies with part 15 of the FCC Rules. Operation is subject to the following two conditions: (1) This device may not cause harmful interference, and (2) this device must accept any interference received, including interference that may cause undesired operation.

# Contents

<b>Packing List</b> .....	<b>1</b>
<b>Safety Precautions</b> .....	<b>2</b>
<b>Before Using FIVA</b> .....	<b>8</b>
<b>About This User's Guide</b> .....	<b>19</b>
<b>Chapter 1 Getting Ready</b> .....	<b>21</b>
<b>Features</b> .....	<b>23</b>
Front .....	24
Back .....	25
<b>Keyboard</b> .....	<b>26</b>
Key Combinations .....	27
<b>Before Using FIVA for the First Time</b> .....	<b>28</b>
Connecting the Neck Strap .....	28
Affixing the Screen Protective Film .....	28
Pulling out the Stylus .....	28
Connecting the AC Adaptor .....	29
<b>Power Supply</b> .....	<b>29</b>
Attaching and Removing the Battery Pack .....	29
Charging the Battery Pack .....	31
<b>Turning on Power</b> .....	<b>33</b>
To turn on the power .....	33
<b>Shutting Down the Power</b> .....	<b>34</b>
To shut down Windows 98 from the Start menu .....	35
To enter the Standby Mode from the Start menu .....	36
To enter the Hibernation Mode with the power switch .....	37
<b>Chapter 2 Using FIVA</b> .....	<b>39</b>
<b>Using the Stylus</b> .....	<b>41</b>
To calibrate the screen .....	41
Pen Operations .....	42
<b>Using the Keyboard</b> .....	<b>43</b>
Keyboard Types .....	43
Changing the Mobile Keyboard Size .....	44
Moving the Mobile Keyboard on the Screen .....	44
<b>Inputting Text with the Mobile Keyboard</b> .....	<b>45</b>

<b>Using handwriting input (smARTwriter)</b> .....	<b>47</b>
How does it work? .....	47
Training smARTwriter .....	47
Achieving Good Recognition .....	48
Using Quick Trainer .....	48
Using the Euro Trainer .....	49
Using smARTwriter .....	50
Using Gestures .....	52
Activating the Correction Box .....	52
The smARTwriter Menu .....	54
Train .....	55
Character .....	55
Macros & Gestures .....	57
Application Shortcuts .....	58
Library .....	60
Library Manager .....	60
Using the Libraries Window .....	62
Properties .....	63
Quitting smARTwriter .....	66
<b>Using smARTscribble</b> .....	<b>67</b>
Basic Concepts .....	67
Starting Up smARTscribble .....	67
Working with Images .....	67
Working with Text .....	68
Ink .....	70
smARTscribble Documents .....	71
Navigating Around a Document .....	71
Guidelines .....	71
Page Size .....	72
Previewing a Document .....	72
<b>Using Mobile Cockpit</b> .....	<b>73</b>
① Toolbar Switch .....	74
② Starting Up a System Tool .....	75
③ Making Mobile Cockpit Settings .....	79
④ Making Power Management Settings .....	81
⑤ Adjusting Display Brightness .....	84
⑥ Changing the CPU Clock Speed .....	84
⑦ Adjusting Speaker Volume .....	85
⑧ Power Management for Specific Hardware .....	86
⑨ Show Properties .....	87
⑩ Displaying the Battery Report .....	87
⑪ Battery Level Indicator .....	88
⑫ Putting the System Into the Standby Mode .....	88
⑬ Entering the Hibernation Mode .....	89
⑭ Using Mobile Cockpit Help .....	89

<b>Using the Battery Pack .....</b>	<b>90</b>
Checking the Current Charge Level of the Battery Pack .....	90
Using the Battery Pack Effectively .....	91
Using the Large-capacity Battery Pack .....	92

## **Chapter 3   Supplementary Information ..... 93**

---

<b>Connecting a Peripheral to FIVA .....</b>	<b>95</b>
Connecting to the Communication Port .....	95
Infrared Data Communication .....	96
USB Connection  .....	97
<b>Loading PC Card and Expansion Memory .....</b>	<b>98</b>
Using a PC Card .....	98
<b>Using the Port Replicator .....</b>	<b>99</b>
Using the Floppy Disk Drive .....	101
Using an External Monitor .....	102
Connecting a Mouse or External Keyboard .....	104
Connecting a USB Device .....	104
Connecting an RS-232C Peripheral .....	104
Connecting a Printer .....	104
<b>Troubleshooting .....</b>	<b>105</b>
<b>Using the Terminal Equipment MBH7MD23-8556CA .....</b>	<b>114</b>
<b>Specifications .....</b>	<b>122</b>
<b>Options List .....</b>	<b>124</b>

# About This User's Guide

---

This User's Guide is divided into the five sections shown below. Be sure you read the section titled [“Before Using FIVA” starting from page 8](#) before you do anything else.

## **Before Using FIVA**

This section provides important safety precautions and things you need to know to use FIVA correctly.

## **Chapter 1 Getting Ready**

This chapter provides you with general description of functions and part names. It also explains required procedures for turning power on and off for the first time.

## **Chapter 2 Using FIVA**

This chapter explains how to turn on power and perform a number of basic computer operations.

## **Chapter 3 Supplementary Information**

This chapter contains information about how to connect peripherals and what to do when you experience problems.

### **Important**



This mark indicates important cautions and things to which you need to pay attention when you operate the FIVA.



This mark indicates that you need to memorize.

The words “Windows 98” and “Windows” used in this user's guide simply refer to the “Microsoft® Windows® 98 Second Edition” operating system.

# Chapter 1

## Getting Ready

**This chapter provides you with general description of functions and part names. It also explains required procedures for turning power on and off for the first time.**



## Features

---

The MPC-501 Series is a lightweight and compact pen type computer.

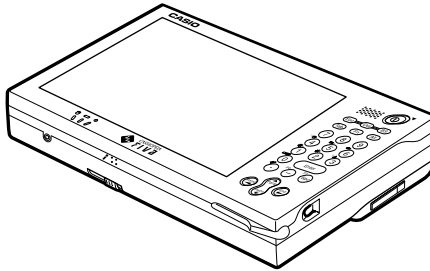

### **6.7-inch SVGA (800 × 600) TFT LCD**

- High-precision, high-resolution CASIO Hyper Amorphous Silicon TFT (HAST) LCD
- Thin display design contributes to overall compact and lightweight configuration.

### **Highly mobile A5 size**

- Compact 870g\*, A5 size goes along anywhere.
- Comes with 32MB of memory as standard (96MB maximum) and a 10 or 15GB hard disk built in.
- Two-way power supply operates on batteries or AC for operation just about anywhere. Power management functions include standby and hibernation modes
- Built-in Windows 98\* lets you take your desktop files along everywhere.

### **Versatile Stylus Interface**

- Pointing is performed by touching the screen with a stylus.
- Highly efficient handwriting recognition

### **Versatile Networking**

- Use of a LAN card, SS wireless LAN card, or other card provides quick and easy networking.
- Connection to remote networks using the built-in modem\* or cellular phone data communication card.

\* Varies depending on the model. ([See page 122](#))



The part names introduced in this chapter are used throughout the rest of this User's Guide.

## Front

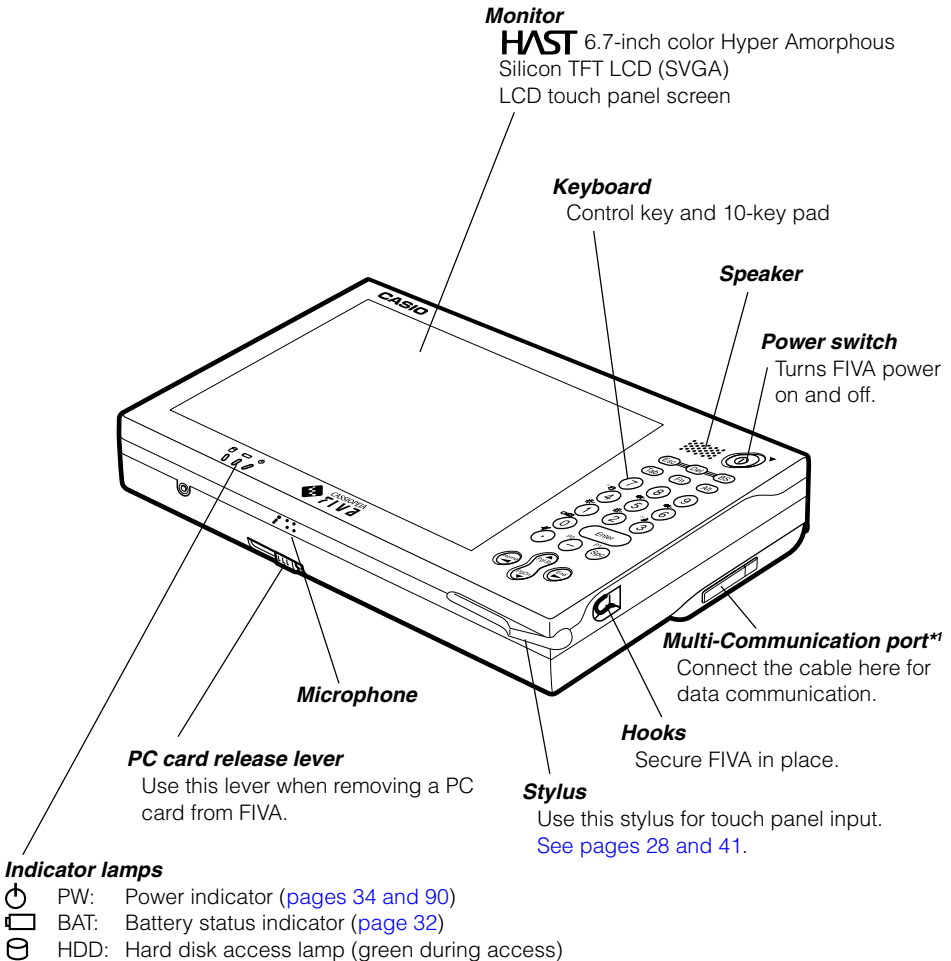

\*1 Multi-communication port is not equipped in some models.

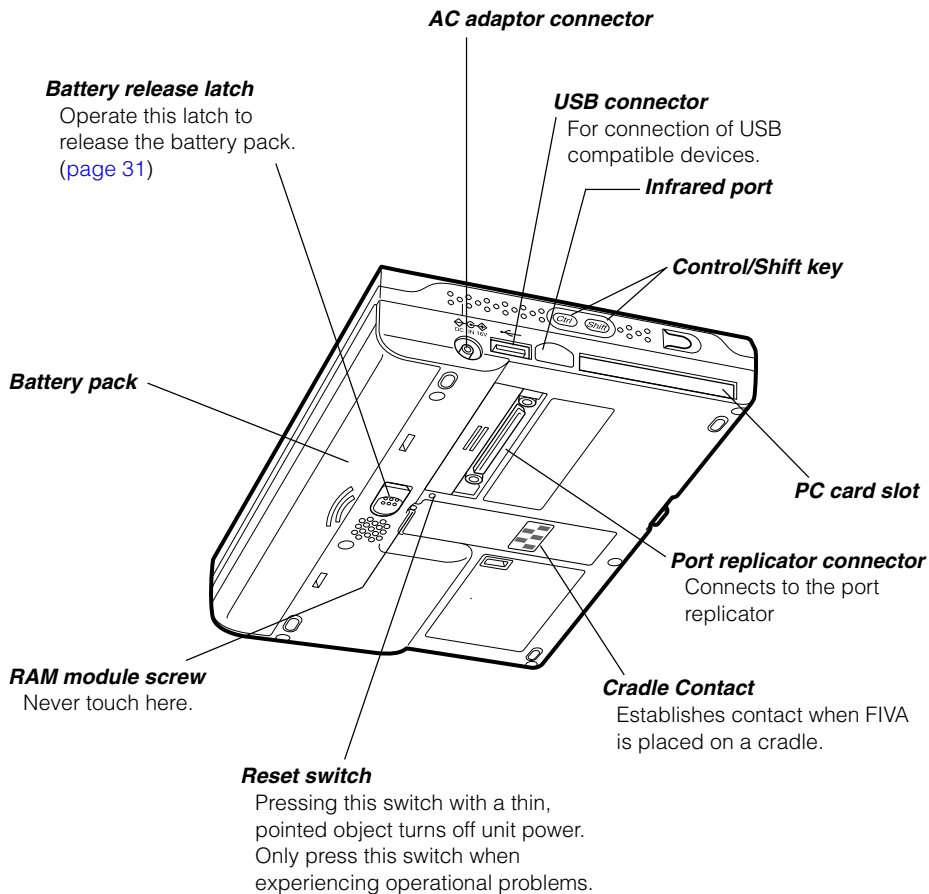

# Keyboard

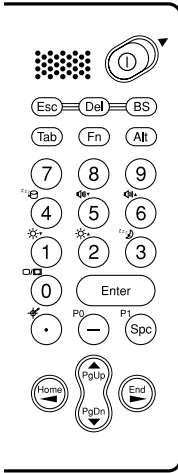









This section describes the basic functions of the keyboard. Actual keyboard functions may differ in accordance with the application you are using.

- Keyboard keys are grouped according to function: control keys, 10-key pad, and arrow keys. The (Shift) and (Ctrl) keys are located on the left side of the FIVA unit.

Function	Key	Key Name	Description
Control Keys	(Esc)	Escape	Cancels an operation.
	(Del)	Delete	Deletes the character to the right of the cursor.
	(BS)	Backspace	Deletes the character to the left of the cursor.
	(Tab)	Tab	Inputs a tab operation.
	(Fn)	Fn	Activates certain "hot keys" functions.
	(Alt)	Alternate	Used in combination with other keys to perform operations and execute commands.
	(Ctrl)	Control	Used in combination with other keys to perform operations and execute commands.
	(Shift)	Shift	Shifts the keyboard between upper case and lower case.
10-key Pad	(0) ~ (9)	10 keys	Inputs numbers (0 to 9).
	(Enter)	Enter (Return)	Enters data or inserts a carriage return.
	(.)	Decimal point	Inputs a decimal point.
	(-)	Hyphen	Inputs a hyphen or a minus sign.
	(Spc)	Space	Inputs a blank space.
Arrow Keys	(Home) (PgUp) (PgDn) (End)	Cursor	Moves the cursor on the screen.

## Key Combinations

- Key combinations where you must hold down one key and press a second are indicated by a plus symbol.
- The following shows the key combinations that are available with the **Fn** key. This is called the “hot keys” function.

	Description
<b>Fn</b> + “1” 	Decreases LCD brightness. (page 84)
<b>Fn</b> + “2” 	Increases LCD brightness. (page 84)
<b>Fn</b> + “3” 	Puts FIVA into <b>Standby</b> Mode. (page 88)
<b>Fn</b> + “4” 	Puts FIVA into <b>Hibernation</b> Mode. (pages 88 and 89)
<b>Fn</b> + “5” 	Decreases speaker sound volume. (page 85)
<b>Fn</b> + “6” 	Increases speaker sound volume. (page 85)
<b>Fn</b> + “0” 	Cycles through monitor function in the following sequence: LCD(FIVA) → CRT* → CRT* and LCD(FIVA) → LCD(FIVA).
<b>Fn</b> + <b>Del</b> + <b>Alt</b>	Places a displayed image of the active window onto the clipboard.
<b>Ctrl</b> → <b>Alt</b> → <b>Del</b>	Restarts the system without turning off power.
<b>Fn</b> + “.” 	Launches the screen calibration routine. (page 41)
<b>Fn</b> + “_” P0	The SOFT KEYBOARD will appear on the FIVA display.
<b>Fn</b> + <b>Spc</b> P1	Launch previously defined applications. For an application to be launched, it must be compatible with the special application software. Check with the producer of the application for details.
<b>Fn</b> + 	Perform page operations (PgUp, PgDn, Home, End).

CRT\* = External monitor

## Before Using FIVA for the First Time

### Connecting the Neck Strap

Connect the supplied neck to the hook on the left side of the FIVA unit.

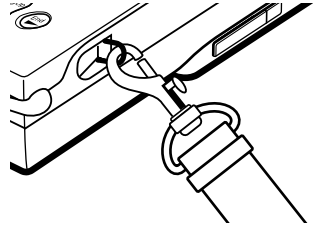

### Affixing the Screen Protective Film

The screen protective film protects the display surface from scratches.

1. Peel the screen protective film from the back surface of the display protector sheet.
2. Bow the screen protective film in the middle and insert its edges on either side of the FIVA display.

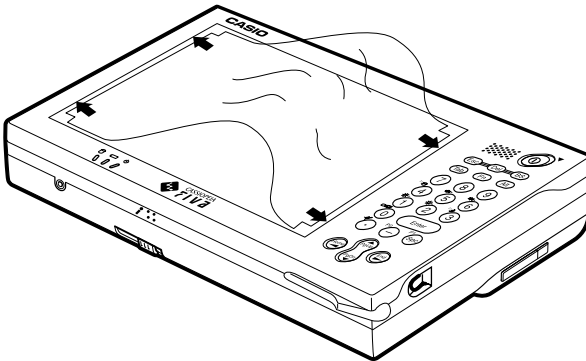

### Pulling out the Stylus

Use your finger to slide the stylus into its storage slot on the front of the FIVA unit. To replace the stylus, slide it carefully back into the slot so the raised part of the stylus enters the slit.

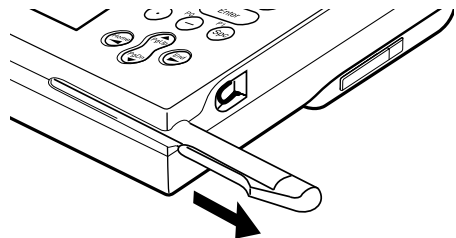

#### Important



- Take care to avoid misplacing the stylus.
- Take care to avoid damaging or breaking the tip of the stylus.
- Keep the tip of the stylus and the FIVA screen clean and free of dirt. Performing stylus operations when the stylus or screen is dirty can damage the screen.

## Connecting the AC Adaptor

Connect the AC adaptor to FIVA as shown in the illustration below. You can connect the AC adaptor with the battery pack in place. To prevent unnecessary consumption of electrical power, do not leave the AC adaptor plugged into the power outlet when it is not connected to FIVA.

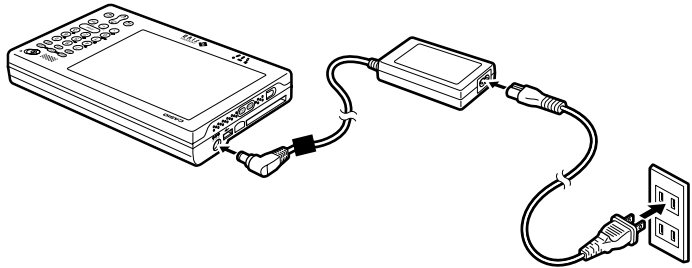

## Power Supply

This section describes how to set up, remove, and charge the battery pack.

### Attaching and Removing the Battery Pack

Though operation is possible using the AC adaptor only, it is a good idea to attach the battery pack and charge it before using FIVA for the first time.

#### Important



Battery packs can also be charged using a separately available charger unit (MPC-570CHG).



#### Note

- The supplied battery pack is not charged when you purchase your FIVA. Note that the battery pack takes about four hours to reach a full charge, certain condition can cause charging to take even longer. A battery taking a long time to reach full charge does not indicate malfunction.



**Use only the battery pack that comes with FIVA or a battery pack specified in this User's Guide. Use of another type of battery pack creates the danger of fire.**

### **To set the battery pack**

1. Turn over the FIVA.
2. Carefully slide the battery pack onto FIVA as shown in the illustration until you hear it clicks securely into place. If you have trouble getting the battery pack to connect to FIVA, try sliding the battery release latch. Do not turn on FIVA yet.

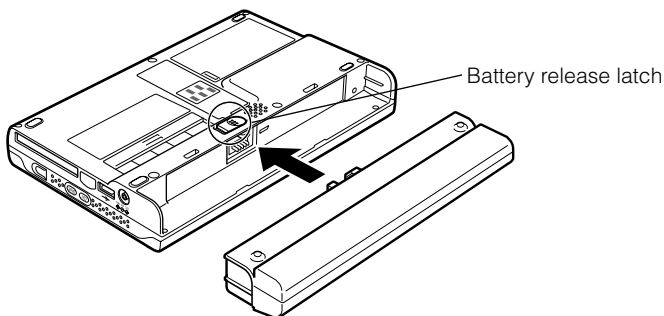

- Pressing the reset switch automatically turns off FIVA power. To protect against losing unsaved data, make sure that FIVA power is turned off when you start the above procedure.
- The battery pack discharges naturally even when you do not use FIVA. Be sure to charge the battery pack before using FIVA for the first time after a long period of non-use.



**Make sure the battery pack is set securely to FIVA. Make sure you attach the battery pack securely to FIVA. An incorrectly attached battery pack can fall off, creating the danger of accident and personal injury.**

### **To remove the battery pack**

1. Turn over the FIVA.
2. While sliding the battery release latch in the direction indicated in the illustration below, pull the battery pack from FIVA.

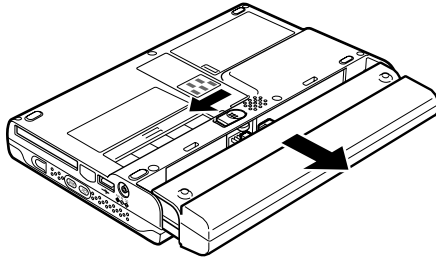

**Make sure you have a firm grasp of the battery pack when you pull it from FIVA. Dropping the battery pack can cause it to fall on your foot or otherwise cause personal injury.**

### **Charging the Battery Pack**

You can use either of the following two methods to charge the battery pack.

#### **With the battery pack attached to FIVA**



The battery pack is charged while the AC adaptor is connected and plugged into a power outlet, regardless of whether or not the FIVA is turned on.

Turn off FIVA and charge the battery pack for about two hours.

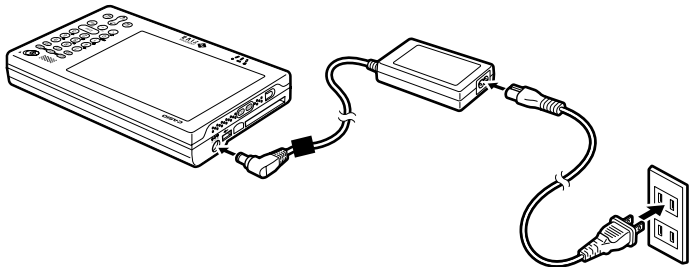
Turning on FIVA power before full charge is attained can result in only a partial charge.





FIVA's  lamp lights amber when charging starts, and turns green when charging is complete. If the  lamp goes out during charging, it can mean that FIVA's protection circuit has cancelled the charge operation. If this happens, remove the battery pack from FIVA and then reattach it to resume charging. The  lamp going out frequently during charging indicates malfunction, and you should contact your original dealer or authorized distributor.



Battery Indicator Lamp	Meaning
Green	Full charge
Amber	Charging
Off at start of charge	Charging is disabled. Try charging again in an area where temperature is within allowable range.
Off during charge	Charge was aborted. Remove battery pack from unit and check it for external abnormality.

### With the special charger unit

See the instructions that come with the charger unit for information about how to charge the battery pack.

#### Important



- If the battery pack is attached to FIVA, do not unplug the AC adaptor until the  indicator lamp turns green (full charge). This helps to extend battery pack life.
- The battery pack requires period replacement. The end of a battery pack's service life is indicated when the battery pack powers FIVA for a relatively short period after a full charge. When this happens, replace the battery pack with a new one.
- Locate the AC adaptor power cord in a place where it will not be tripped over.
- Charge the battery pack in an area where the temperature is within the range of 5°C to 35°C (41°F to 95°F). The battery pack may fail to reach a full charge at temperatures outside this range. In this case the  indicator lamp does not light.
- Charging of a battery pack you have not used for a long time may not start (the BAT-LED does not light amber) when you connect the AC adaptor. If this happens, leave the battery pack attached and hold down the RESET switch on the bottom of FIVA for about 10 seconds.



- [See page 90](#) for information about battery pack life and charging capacity.

# Turning on Power

## To turn on the power

Though it may take a few moments before anything appears on the display, you do not need to keep the power switch depressed. Simply press it once and release it.

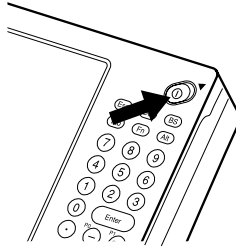

After waiting for a few minutes, “Welcome” dialogue message appears followed by “Windows Product Key” dialogue message. By pushing the **[Fn]** and **–** keys at the same time the Mobile Keyboard pops up on the screen. Enter each requested user’s information by using this keyboard and the 10-key pad.

### Important



Do not shut down the power once the Windows 98 setup procedure starts. Also, be sure to power FIVA with its AC adaptor while performing the setup procedure. After turning power off, wait for at least 10 seconds before turning it back on again.

The first time you turn on the power, you must perform a Windows 98 setup procedure.

Consult your original detailer for information about the setup procedure.

You need to perform this procedure only once. After that, Windows 98 will boot up automatically when you turn on the power.

### Note

- The screen goes through a number of changes and may even flicker while Windows 98 is starting up. This is normal and does not indicate malfunction of FIVA.
- FIVA’s is equipped with “power management” functions that automatically go into a low-power standby or hibernation mode if you do not perform any screen touch or keyboard operation for about 10\* minutes. Input data on the screen when the low-power **Standby** or **Hibernation** is entered is automatically saved, so the screen reappears on the display when you recover from a low power mode.

- \* You can change the trigger time setting using the Power Management settings under Mobile Cockpit. [See page 79.](#)
- If power does not turn on when you press the power button, [see the troubleshooting guide on page 105.](#)

## Shutting Down the Power

---

Power can be turned off using any of the methods listed below.

- Shutting down Windows 98 from the Start menu.
- Entering the **Standby** Mode from the Start menu.
- Pressing the power switch. (Enters the **Hibernation** Mode.)

These methods differ in the amount of power consumed while power is off and the amount of time it takes before Windows 98 is ready to be used from any of the power off states. An understanding of these differences will help you decide which one you should use.

Mode	Storage for state	Time Unit Recovery	Power Consumption	Indicator Lamp
①Power Off	None	Long (restart)	Almost zero	Off
②Standby	Memory	Fast	Yes	Flashing
③Hibernation	Hard Disk	Long	Almost zero	Off

Shut down Windows from the Start menu or press the power switch to enter the **Hibernation** Mode if you do not plan to use FIVA for a long time (i.e. until the following day).

## To shut down Windows 98 from the Start menu

1. Tap the **Start** button on the Taskbar.

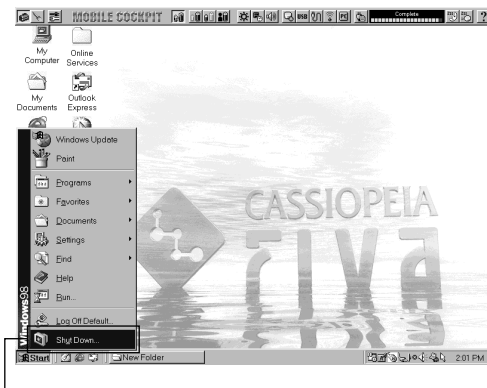

Choose this command.

2. Choose **Shut Down...**
3. Tap the option button next to “Shut down” and then tap the **OK** to shut down the computer.

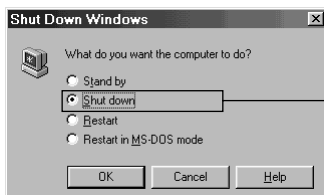

Choose this option.  
To turn power back on again, press the power switch.

In this mode, Windows 98 is completely shut down and FIVA is consuming almost no battery power. This mode extends battery life but requires that Windows 98 be restarted from the very beginning to restore power. This means that the status of Windows 98 or any application that is running is not maintained in memory when the **Power Off** Mode is entered. Enter the **Power Off** Mode if you do not plan to use FIVA for a long time and before installing expansion memory.

## To enter the Standby Mode from the Start menu

1. Tap the **Start** button on the Taskbar.
2. Choose **Shut Down....**

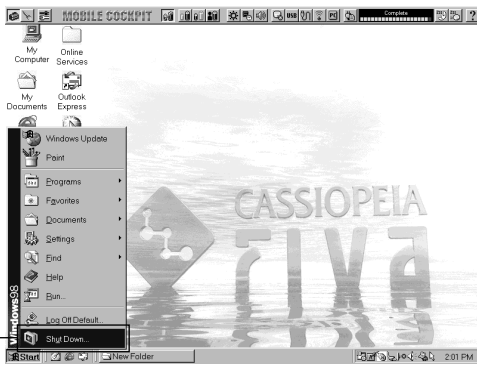

Choose this command.

3. Tap the option button next to “Stand by” and then tap **OK** to enter the Standby Mode.

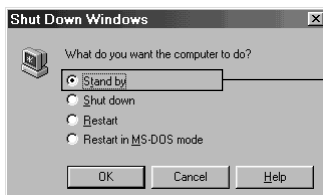

Choose this option.

To restore power, press any key or button.

In the **Standby** Mode, the LCD and other devices are put into a suspend state. The status of Windows 98 and any applications that are running is retained in memory, so they can be restored and used immediately after leaving the **Standby** Mode. This means that Windows 98 is restored within the shortest time from this mode, but it also means that this mode requires more power consumption than that of the other two modes. The **Standby** Mode is best when you plan to be away from the computer for only a short time and need to immediately pick up from where you last left off when you return. Tapping the keyboard or other controls on FIVA automatically recovers from the **Standby** Mode.



- When you need to leave FIVA on for a long time while using battery power only, shut down Windows 98 from the Start menu or press the power switch to enter the **Hibernation** Mode.

## To enter the Hibernation Mode with the power switch

Holding down the power switch for more than one second enters the **Hibernation Mode**.

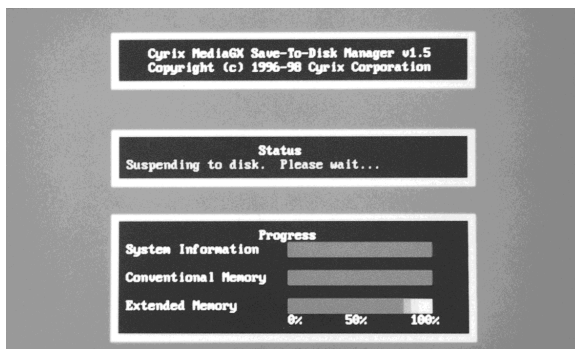

Windows 98 data and data for the application you are using are written to FIVA's hard disk. This process takes some time to complete, after which FIVA powers down automatically after which FIVA enters the **Hibernation Mode**, and almost all power is cut off.

Press the power switch again to recover from the **Hibernation Mode**. This causes the CASIO logo to appear, followed by the Windows 98 screen that was saved to the hard disk.

The **Hibernation Mode** is recommended when you do not plan to use your computer for a long time, but you want to restore the status of Windows 98 and your applications when you return.

### Important



- Avoid entering the **Hibernation Mode** while a communication operation is in progress, or while a peripheral (disk, printer, etc.) is in use. Entering the **Hibernation Mode** while a communication operation is in progress will cause an error on the other computer.
- The **Standby Mode** and **Hibernation Mode** are disabled in the **MS-DOS** mode.
- You can reset FIVA and force power to turn off by holding down the power switch for 10 seconds (until FIVA beeps five times). Note that FIVA does not beep if sound output is muted. Use this method to reset FIVA only when operation locks up and nothing else works.

# Chapter 2

## Using FIVA

**This chapter explains how to turn on power and perform a number of basic computer operations.**





# Using the Stylus

Before actually using the stylus to perform screen operations, be sure to first clean the tip of the stylus and the screen. Performing stylus operations when the stylus or screen is dirty can damage the screen and interfere with stylus input.

Use only the stylus that comes with FIVA to perform screen operations. Never use a pencil, a mechanical pencil, or any other pointed object. Such objects can damage the display.

When you touch the screen with the stylus, a pointer ( ↖ ) appears on the display to indicate the point you touched. If the pointer appears at a location that is different from where you touched, use the procedure described below to calibrate the screen.

## To calibrate the screen

1. Open the Taskbar, touch **Start, Programs, FIVA TOOLS**, and then **Calibration Tool**. This causes the calibration screen shown below to appear, with a cross mark in the upper left corner.

- You can also display the calibration screen by pressing **[Fn] + " "**.

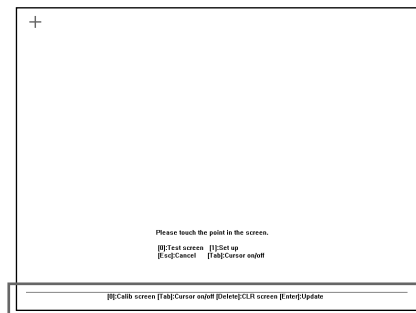

This bar shifts upward and downward by each pressing **Del**.

2. Tap the cross marks with the stylus in the sequence they appear on the screen.
3. After you tap the final cross mark, a title bar appears in the title bar at the bottom of the screen. Use the stylus to draw something on the screen. Check to make sure line drawn on the screen appears where you drag the pen on the screen.
  - If the line appears in the correct location, press **Enter** to exit the calibration procedure.
  - Pressing **Del** deletes the line drawn with the pen and moves the title bar display up and down.
  - If the location of the line is not correct, press **0** and go back to step 2 of the above procedure.

## Pen Operations

With FIVA, you can perform all the operations you need by lightly touching the screen. The following provides descriptions and examples of a number of basic functions.

### ① Double-click

Tap twice on the screen in quick succession to accomplish the same result as double clicking with a mouse.

### ② Drag

Touching an icon causes it to change colors. Holding the stylus against the icon and dragging causes the icon to move along with the stylus.

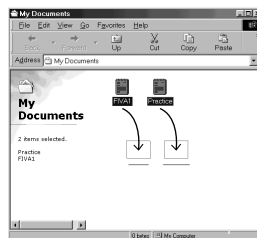

### ③ Drag and Drop

Drag and drop lets you move a selected range of text from one location on the screen to another.

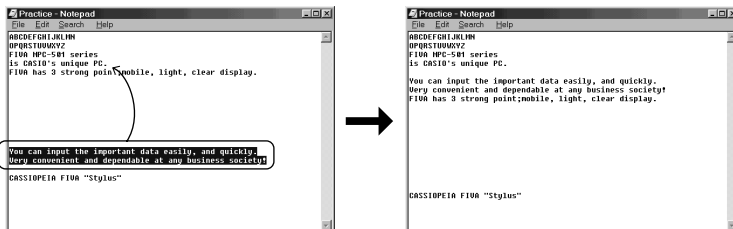

- Touch and hold the beginning of the range of text you want to select, and drag stylus to the end of the range. Remove the stylus from the screen when all the text you want is selected. Selected text is highlighted on the screen as shown above.
- Holding the stylus anywhere inside the highlighted text, drag it to the location to which you want to move it, and then remove the stylus from the screen.

### ④ Right Click

Touch the  icon on the lower right of the screen. The next time you touch the screen with the stylus performs a right-click operation.



Some applications do not allow right clicking while a range of text is selected (highlighted).

# Using the Keyboard

## Keyboard Types

### FIVA Hard Keyboard

The keys to the right of the FIVA display are grouped according to function: control keys, 10-key pad, and arrow keys. Pressing the function key **[Fn]** and then another key performs a hot key function. [See page 27](#) for a complete list of hot key combinations.

### Text Input Panel

There are two types of text input panels: Mobile Keyboard and smARTwriter (a handwriting input panel). The most appropriate keyboard for the type of operation you are performing appears list, but you can switch between keyboards at anytime.

- **smARTwriter (handwriting input panel)**

Use this input panel to input text by hand writing directly on the screen. smARTwriter cannot be used in combination with the Mobile Keyboard.



- **Mobile Keyboard**

Use this keyboard when setting up the system and performing other input. Press the function keys **[Fn]** and “-” to display the Mobile Keyboard.

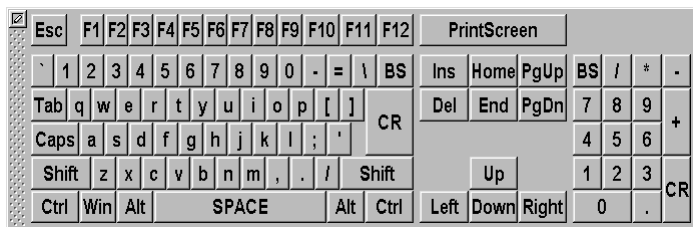
The Mobile Keyboard has the same configuration as a computer keyboard. You cannot use the Mobile Keyboard and the smARTwriter at the same time.



### ***Changing the Mobile Keyboard Size***

Touch and hold the lower right corner of the keyboard with the stylus so the pointer changes from  to . Drag the stylus on the screen to change the size of the keyboard. Note that the size of the smARTwriter handwriting input panel cannot be changed.

### ***Moving the Mobile Keyboard on the Screen***

Hold and tap the  area on the left side of the keyboard and drag it to the location you want.

# Inputting Text with the Mobile Keyboard

There are five different Mobile Keyboard configurations. Try them out and find the one that suits you best. To change the configuration of the Mobile Keyboard, tap the  icon in the upper left corner of the current keyboard, and then select the keyboard you want from the menu that appears.

## ① Full Qwerty key

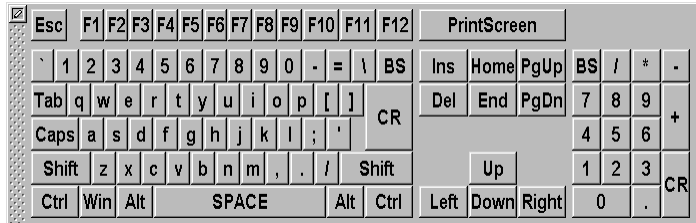

## ② Middle Qwerty key

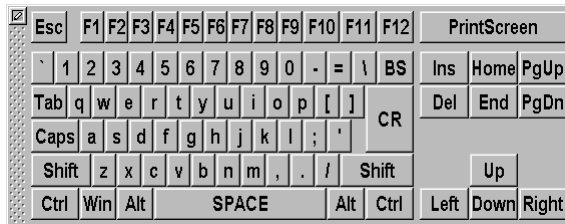

## ③ Small Qwerty key



## ④ ABC key

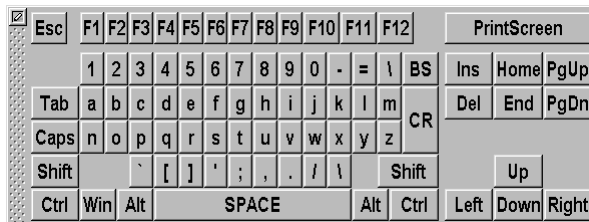

⑤ Ten key



## Using handwriting input (smARTwriter)

FIVA comes with smARTwriter handwriting recognition software. You can find detailed information about all of the features and functions in the online help that is available while smARTwriter is running. The following explains of smARTwriter Plus Ver.3.5.

smARTwriter is a pre-installed handwriting recognition application that lets you input text into an active application, launch applications, open documents and more by writing with the stylus directly on the FIVA screen.

Writing on any part of the FIVA screen creates “electronic ink,” which is then recognized and interpreted by smARTwriter. Finally, the results are sent to the active application as if they were typed using a keyboard.

### ***How does it work?***

“Electronic ink” appears as you write on the FIVA screen. When a timeout occurs (when you lift the pen for a certain time interval), smARTwriter passes the recognized output to the active application. The recognition process is performed by comparing the symbols you write against a set of defined smARTwriter symbols. This set of symbols is called a Library. The Library contains shapes of letters, digits, punctuation marks, etc.

The Library can contain more than one version of a letter or symbol. The letter “G,” for example may be written as shown below:



smARTwriter has a generic library containing common handwriting styles for characters, so your handwriting probably will be easily recognized the first time you use smARTwriter.

### ***Training smARTwriter***

Training lets you teach smARTwriter your own handwriting style, which improves the recognition rate. You can train smARTwriter using any of the methods listed below.

- Quick Trainer. This is an automatic tool for adding letter models to the Library ([page 48](#)).
- On-the-spot training. You can correct a recognition error whenever one occurs.

## ***Achieving Good Recognition***

Following the tips listed below helps to improve the handwriting recognition rate.

- Write without stopping. There is no need to wait for smARTwriter to recognize text.
- Write using printed (not connected or cursive) characters.
- Do not use delayed strokes. Dot your “i” and cross “t” characters immediately.
- Avoid touching the screen with your hand while writing. Doing so can leave unwanted ink on the screen.
- Avoid writing small characters. Doing so can cause loss of resolution and character recognition errors.
- After using smARTwriter for a few days, we recommended that you edit the Library and delete any redundant or incorrect models. [See “Library” on page 60](#) for more information.

## ***Using Quick Trainer***

Quick Trainer is an application you can use to teach smARTwriter your particular style of writing, which helps to improve recognition results. It takes less than five minutes to complete one Quick Trainer session.

### **To run Quick Trainer**

1. Start up Quick Trainer by selecting: **Start** → **Programs** → **smARTwriter for Windows** → **Quick Trainer**.
2. A prompt appears asking if you want to train Western European characters.
  - If you want to train using standard English characters, tap **No** and then tap **OK**.
  - If you want to train using other (non-standard English) characters, tap **Yes** and then select the language from the pull down menu on the right. Next, tap **OK**.



3. The Quick Trainer window appears, showing a passage of text.

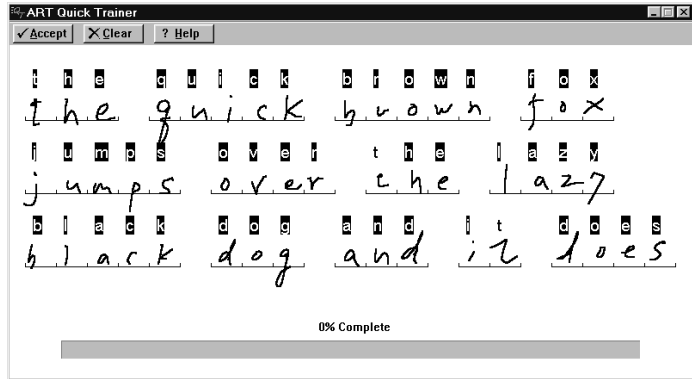

4. Copy each character into the slot or box directly under it, one character in each slot. If you make a mistake, re-write the letter or character. You can re-write a letter or character as many times as you need. Make sure you write characters in all the slots provided. Letters that smARTwriter immediately recognizes will be highlighted. The rest will be learned by the recognition system when you tap the **Accept** button.  
The bar at the bottom of the window indicates the progress of the session.
5. After you finish writing all the characters, tap the **Accept** button. If you want to clear the screen and start over, tap the **Clear** button.



- You can repeat Quick Trainer sessions as often as you want. Repeating sessions improves recognition results even more.

### Using the Euro Trainer

Using the Euro Trainer, you can train smARTwriter to recognize your handwriting in Western European languages other than English. To launch training for non-English Western European characters, select **Start** → **Programs** → **smARTwriter for Windows** → **Euro Trainer**.

A prompt asks you to choose a Western European language. Select a language, and tap **OK**. Then follow the instructions described above in Using the **Quick Trainer**.

## Using smARTwriter

This section explains what you need to know in order to actually set up and use smARTwriter on your FIVA.

### Starting Up smARTwriter

smARTwriter always starts up automatically every time you turn on FIVA. You can, however, quit smARTwriter manually (selecting **Exit** from the smARTwriter menu option), and then start it back up manually the next time you want to use it.

### To start up smARTwriter manually

1. On your FIVA, select: **Start** → **Programs** → **smARTwriter for Windows**, and then tap the **smARTwriter** shortcut icon.
2. The above step causes the smARTwriter control icon to appear in the icon tray in the bottom right corner of the screen. This indicates that smARTwriter is active.

### smARTwriter Modes

You can control pen operations and handwriting recognition using the smARTwriter icon in the bottom right corner of the screen.

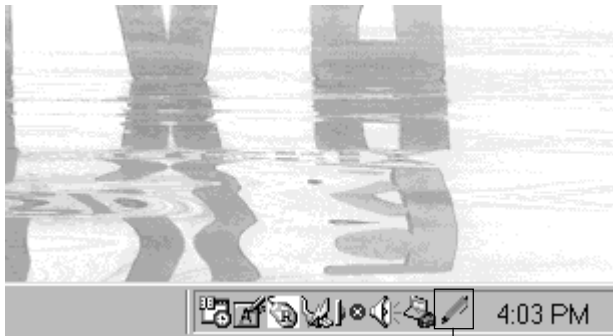

smARTwriter tray icon  
(Writing Mode)

The shape of the icon indicates the current mode.

- Pointing Mode (☒)

This icon indicates that the stylus operates as a pointing or selection device.

- Writing Mode (✍)

This mode indicates that the stylus operates as a writing device.



Tapping the icon toggles between the modes.

Double-tapping the icon or holding down the Alt key and tapping the icon, opens the smARTwriter menu.

- Pen-Aware mode 

This is an automatic mode used by applications with several input fields. Pen-aware applications (such as ART's Quick Trainer) switch back and forth between the Writing and Pointing modes according to the pen's position on the screen.

### **First Steps in Writing with smARTwriter**

1. Switch to Pointing Mode  and then start up an application, such as Word.
2. Switch to Writing Mode  and tap in the input area of the application so the insertion cursor appears. You are ready to start writing on the screen.
3. Using the stylus, write a few words in the Pocket Word document area. Write continuously. It is not necessary to pause after each letter. smARTwriter reads the "ink," recognizes it, and converts it into printed text.
4. The recognized text appears at the insertion point.



- Recognized text is always inserted to the left of the cursor in the active window.

## Using Gestures

A “gesture” is a symbol you draw to activate a special function or enter a special character, like a backspace, new line, etc. The following are the gestures available with smARTwriter.

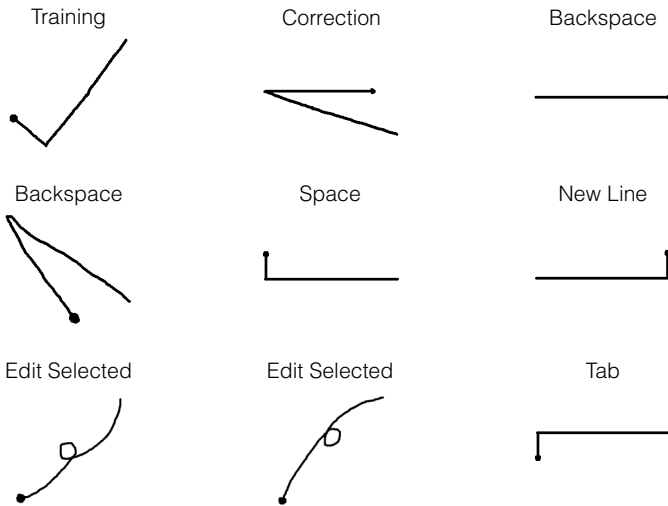

- The heavy dot indicates the starting point of each gesture.

For example, the following describes the steps you should perform when you want to use the Backspace gesture.

1. Switch to the Writing Mode (.
2. Draw the Backspace gesture on the screen.
3. This causes the character to the left of the cursor position to be deleted.

## Activating the Correction Box

The Correction Box is a built-in tool that makes it easy to correct misrecognized text. You can use any of the three different procedures to activate the Correction Box.

### To activate the Correction Box with the Correction gesture

1. Write until a recognition error occurs.
2. Draw the Correction gesture over the word you want to correct.

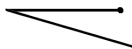

- This selects the word and activates the Correction Box with the misrecognized word inside it.

### To activate the Correction Box with the menu

1. Write until a recognition error occurs.
2. Select (highlight) the misrecognized word.
3. Tap the smARTwriter icon and then select **Correct...** from the smARTwriter menu.
  - This activates the Correction Box with the misrecognized word inside it.

### To activate the Correction Box with an Edit Selected gesture

1. Write until a recognition error occurs.
2. Select (highlight) the misrecognized word.
3. Draw either of the **Edit Selected** gestures.

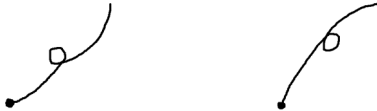

- This activates the Correction Box with the misrecognized word inside it.

### Using the Correction Box

The Correction Box displays the characters that make up the selected word with a down arrow underneath each one.

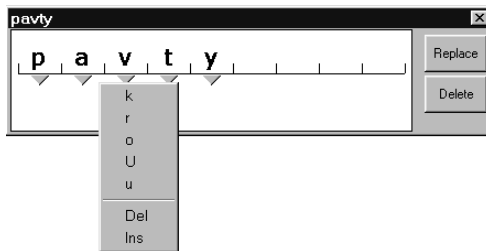

### To make corrections

1. Tap the down arrow under the character you want to change. This displays a menu of other possibilities for the character.
2. Choose the character you want by tapping it. You can also change a character by writing the new character directly into the box or slot on the Correction box.



- The menu that appears when you tap a down button also contains two commands. Tapping **Ins** inserts a space in front of the current character, while **Del** deletes the current character or space.
3. Tap the **Replace** button to replace the original word with your corrected version. To delete the word from your input, tap the **Delete** button.

## The smARTwriter Menu

Tapping the smARTwriter icon opens the smARTwriter menu, which provides access to the main functions of smARTwriter.

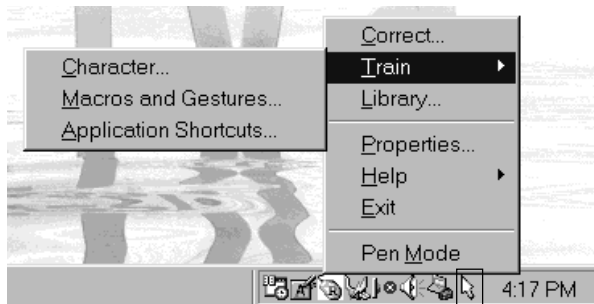

Tap here.

### **Correct**

Activates the Correction Box. See [“Using the Correction Box” on page 53](#).

### **Train**

Opens the Trainer dialog box so you can “teach” smARTwriter your handwriting style. See [“Training smARTwriter” on page 47](#).

### **Library**

Opens the Library Manager. See [“Library Models” on page 61](#).

### **Properties**

Displays the smARTwriter Properties dialog box. See [“Properties” on page 63](#).

### **Help**

Displays smARTwriter online help or copyright and version information.

### **Exit**

Tap here when you want to manually shutdown smARTwriter.

### **Pen mode**

Toggles between the smARTwriter Writing mode (✍) and Pointing mode (👉). See [“smARTwriter Modes” on page 50](#).

## Train

You can train smARTwriter to recognize your own individual handwriting style for characters, strings, macros, gestures, or application shortcuts.



- Training improves the handwriting recognition rate because it teaches smARTwriter how to recognize your particular writing style. See [“Using Quick Trainer” on page 48](#) for information about how to use another training tool named Quick Trainer.

To access training while you are inputting text, tap the smARTwriter icon in the icon tray, select **Train** from the smARTwriter Menu, and then select one of the training options: **Character...**, **Macros and Gestures...**, or **Application Shortcuts...**

## Character

This option opens the Trainer dialog box. You can also draw the gesture shown below to open the Trainer dialog box.



When the Trainer dialog box opens, it shows the last ink pattern you wrote or selected. Use this dialog box to teach smARTwriter to interpret the pattern (or a part of it) as a single character.

### To teach smARTwriter a character

1. Display the Trainer dialog box by tapping the smARTwriter icon and then selecting **Train** → **Character...**
- The last ink pattern you drew is shown in the upper part of the Trainer dialog box.



2. In the upper part of the Trainer dialog box, select the segments or parts of the ink pattern that you want to use as a character.



- Tap the ink pattern to select it, tap it again to deselect. If there is more than one stroke, make sure you select all the strokes that are part of the character. The strokes you select appear in the Trainer dialog box, which shows the ink pattern that will be used for recognition.
3. Tap the down arrow next to the **As** box and select the character from the list that appears.
    - If you cannot find the character you want in the list, select **Other**. See “Other Symbols” below.
    - You can also use the stylus to write the text character you want directly into the **As** box.
    - No matter how you specify a character, the character in the **As** box will be associated with the ink pattern in the Trainer dialog box.
  4. Tap the **Train** button to train the character and save your changes to the Library of Models.
  5. Tap the close box to close the Trainer dialog box.

#### Other Symbols

If the character you want is not in the list, select **Other** from the list to open the Train Symbol dialog box.

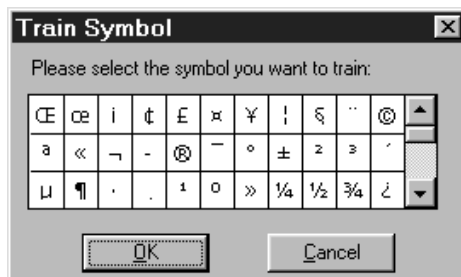

The Train Symbol dialog box provides a selection of non-standard and international symbols. Tap the character you want on the Train Symbol dialog box to select it, and then tap **OK**.

The following functions are also available on the Trainer dialog box.

- Tap the **Undo** button if you made a mistake and want to “untrain” the character.
- Tap the **Macro** button when you want to train the selected ink pattern as a character string, macro, or gesture. Tapping **Macro** displays the Train Macro Wizard, which shows the selected ink pattern. See “Macros & Gestures” on page 57 for more information about this dialog box.





- If you open the Trainer dialog box while text is selected in a document, the selected text is automatically replaced by the newly trained character when you close the Trainer dialog box.

## Macros & Gestures

This option opens the Train Macro Wizard dialog box with the last ink pattern you wrote or selected. Use this dialog box to teach smARTwriter to interpret the pattern as a character string, macro, or gesture.

### To teach smARTwriter a character string, macro, or gesture

1. Display the Train Macro Wizard dialog box by tapping the smARTwriter icon and then selecting **Train** → **Macros & Gestures**.
- The last ink pattern you drew is shown in the **Draw Macro Ink** box.



- You can use this pattern as it is, or you can replace it with another pattern by tapping the **Clear Ink** button and then drawing another ink pattern.
2. When the ink pattern is the way you want, tap the **Next** button to continue.
- To cancel training, tap the **Cancel** button.
3. In response to the prompt that appears, tap **New Macro** if you are creating a new macro, or **Existing Macro or Gesture** to associate the ink pattern with an existing macro. Next, tap **Next** to continue.

What happens next depend on whether you selected **New Macro** or **Existing Macro or Gesture** in step 3 of the above procedure.

### New Macro

1. In response to the prompt that appears, use the stylus to enter a name for the macro or gesture. The name you enter appears in the **Enter Macro Name** box. After you are finished, tap **Next** to continue.
2. Use the stylus to enter the macro sequence or character string.
  - Characters are displayed as characters.
  - Functions are displayed as the functions they represent. For example, a tab operation appears as <TAB>.

3. Tap **Finish** to save the macro and close the Train Macro Wizard.

### Existing Macro

1. On the dialog box that appears, select the macro or gesture you want from the list.

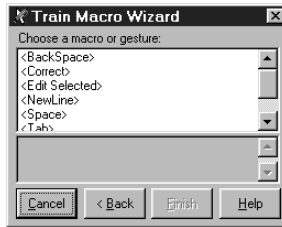

- The lower part of the dialog box shows the sequence currently assigned to the selected macro or gesture.
2. Tap the **Finish** button to save your changes and close the Train Macro Wizard.

### Application Shortcuts

This option opens the Train Shortcut Wizard dialog box with the last ink pattern you wrote or selected. Use this dialog box to teach smARTwriter to interpret the pattern as a shortcut to launch an application.

#### To teach smARTwriter an application shortcut

1. Display the Train Macro Wizard dialog box by tapping the smARTwriter icon and then selecting **Train** → **Application Shortcuts**.
- The last ink pattern you drew is shown in the **Draw Macro Ink** box.



- You can use this pattern as it is, or you can replace it with another pattern by tapping the **Clear Ink** button and then drawing another ink pattern.
2. When the ink pattern is the way you want, tap the **Next** button to continue.
- To cancel training, tap the **Cancel** button.

- In response to the prompt that appears, tap **New Shortcut** if you are creating a new shortcut, or **Existing Shortcuts** to associate the ink pattern with an existing shortcut. Next, tap **Next** to continue.



- The prompt described in step 3 appears only when one or more application shortcut already exists. If there are no application shortcuts yet, the New Shortcut option is selected automatically. What happens next depend on whether you selected **New Shortcut** or **Existing Shortcuts** in step 3 of the above procedure.

### New Shortcut

- Tap the **Browse** button. On the dialog box that appears, select the application for which you want to create a shortcut and then tap **OK**.



- The path to the application you selected appears in the **Shortcut command line** box, and the name of the application appears in the **Shortcut name** box.
- Tap **Finish** to save the shortcut and close the Train Shortcut Wizard.

### Existing Shortcuts

- On the dialog box that appears, select the shortcut you want from the list.



- The lower part of the dialog box shows the path to the application currently assigned to the selected shortcut.
- Tap the **Finish** button to save your changes and close the Train Shortcut Wizard.

## Library

The collection of characters and shapes recognized by smARTwriter is called the Library of Models. smARTwriter contains a pre-defined Library of Models with over 371 distinct characters. smARTwriter recognizes handwriting primarily by comparing the shape and direction of flow of individual characters you write to a set of character shapes (models) stored in the Library of Models. Every time you train smARTwriter, you add character models to the Library of Models. To improve recognition, you should periodically use Library Manager to delete redundant or unnecessary models from the library.

## Library Manager

Library Manager lets you maintain the list of character shapes and symbols in a specific Library of Models. This is especially useful if your FIVA is used by more than one person. You can create a Library of Models for each user, so smARTwriter can recognize each individual's personal handwriting style.

### To open Library Manager

Tap the smARTwriter icon and then select **Library...** from the menu.

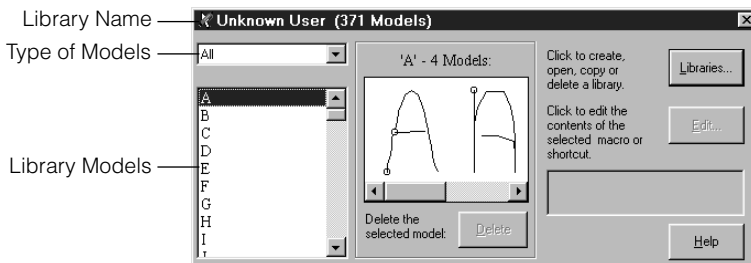

### Library Name

This is the name of the currently active library. It also shows the total number of models in the library. Normally, the Library Name is the same as the user name.

### **Type of Models**

Use this box to specify the category of models you want to view. Tap the down arrow and select one of the categories listed below.

<b>To view:</b>	<b>Select:</b>
All characters in the Library of Models	All
Lower case characters only	Lower
Upper case characters only	Upper
Numbers only	Digits
Symbols and punctuation marks only	Punc.
Gestures only	Gestures
Macros only	Macros
Shortcuts only	Shortcuts

You cannot use this box to view macros and shortcuts.

### **Library Models**

This box lists all the characters, gestures, macros, and shortcuts in the library. It lets you select a specific character and review its associated models. To view the models associated with a specific character, select a category from Type of Models list. Then tap a character in the Library Models list. The database of models for the character you select appears in the Models Box.

### **Models Box**

This box shows the models assigned to character. The total number of models assigned to the selected character is shown above the Models Box.

Use the scroll bar to view the different character models assigned to the selected character. The leftmost model is the last model assigned to the character.

To select a model, tap it once.

### **Delete Button**



- This button is dimmed (unavailable) unless a macro or a shortcut model is selected in the Models Box.

Tap this button to delete the selected model from the library.

### **Libraries Button**

Tap this button to display the Libraries Window.

## Using the Libraries Window

Use the Libraries Window to create new libraries, open an existing library (change the active library), and to copy and delete libraries. The icons on the top of the Libraries Window represent **New** (create), **Open** (change), **Copy**, and **Delete**.

### Creating a New Library

If more than one person uses the FIVA, it is a good idea if each user creates a personal Library of Models.

#### To create a new library

1. Tap the New button ()
2. In response to the prompt that appears, enter the name you want to give the new library, and then tap **OK**.
  - Normally, you should use the name of the user as the name of the library.
3. On the New Library dialog box that appears on the display, select one of the followings as the type of Library you want to create.

When you want to:	Select:
Load the standard smARTwriter library, with the full range of default model samples	Standard default library.
Load all punctuation marks and predefined gestures and shortcuts only. <ul style="list-style-type: none"><li>• This case, you must train smARTwriter to recognize your handwriting style. See <a href="#">“Training smARTwriter” on page 47</a>, and <a href="#">“Using Quick Trainer” on page 48</a>.</li></ul>	Minimal library.

#### 4. Tap **OK**

- Whenever you create a minimal library, smARTwriter automatically launches Quick Trainer. See [“Using Quick Trainer” on page 48](#).



#### To open an existing library and change the active library

1. On the Libraries Window, select the library you want to open from the list of libraries.
2. Tap the Open button ()

#### To copy a library and save it under a different name

1. On the Libraries Window, select the library you want to copy from the list of libraries.
2. Tap the Copy button () to display the Copy Library dialog box.
3. Enter the name you want to assign to the copy of the library.
4. Tap the **OK** button to save the copy.



### To delete a library

- Make sure that the library you are deleting is not the active library. If it is, change the active library.
1. On the Libraries Window, select the library you want to delete from the list of libraries.
  2. Tap the Delete button (X).

## Properties

This menu option displays a dialog box for setting the properties of smARTwriter. The Properties dialog box contains the following tabs.

### General

This tab contains settings for customizing smARTwriter behavior.



### Timeout

Sets the time smARTwriter waits from the moment you lift the pen from the screen before it begins recognition of the “ink” pattern. The range is from 0.1 to 1.5 seconds.

### Enhanced recognition of English

Checking this box enables the smARTwriter linguistic layer, which allows smARTwriter to recognize rules and guidelines for the English language. For example, if the “g” in “reading” is written very similar to a “y,” the linguistic layer knows that “iny” is not a common ending in English and that “ing” is a more probable combination. Therefore, smARTwriter outputs “reading” as the recognized word.

Enhanced Recognition of English is checked by default. You should disable this option if you are not writing standard or plain English text.

### Space after recognition

When this option is checked, smARTwriter adds a space after each set of characters recognized (after each timeout).

### Enable Sounds

When this option is checked, smARTwriter plays error and warning sounds through the FIVA’s speaker.

## Ink

The settings on this tab control the way the electronic ink is displayed on the FIVA screen.

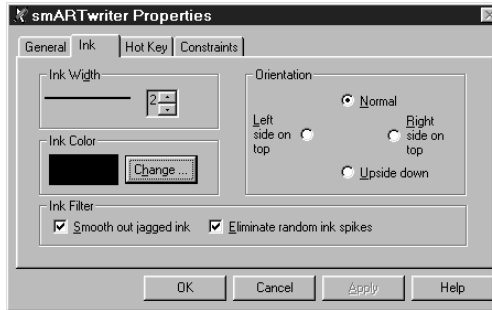

### Ink Width

Use this setting to change the width of the ink. Tap the up or down arrow to change the width within the range of 1 to 5 points.

### Ink Color

This area shows a sample of the color currently selected for the ink, and provides a button for changing the color.

### To change the color of the ink

1. Tap the **Change...** button to display the Color dialog box, which is a standard Windows color palette.

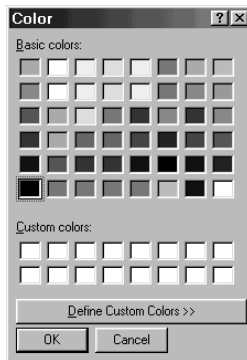

2. Select the color you want to use for the electronic ink.



**Note**

- Refer to your Windows documentation for more information about using this dialog box.





## Orientation

- This option affects smARTwriter only. The screen orientation of your other applications does not change.

These settings let you adjust the position of the screen for use as a writing board. They define the writing orientation so smARTwriter can recognize the electronic ink pattern.

## Ink Filter

Use these settings to correct ink patterns and help improve recognition.



- Smooth out jagged ink

Check this option to eliminate “dotting” and make electronic ink appear smooth. For optimal recognition, make sure that this setting is the same for both writing and training sessions.

- Eliminate random ink spikes

Check this option to remove sharp ink edges, making the edges of the electronic ink appear rounded. For optimal recognition, make sure that this setting is the same for both writing and training sessions.

## Hot Key

Use this tab to create a hot key or shortcut that toggles between the Writing Mode () and Pointing Mode (). You can tap a radio button to select a predefined hot key, or select **Other** to define your own shortcut. When you specify one of the **Ctrl** and **Shift** options, the toggle is performed after you press and release the applicable key.

- You cannot select **Right Shift** and **Right Ctrl** options with FIVA MPC-501.

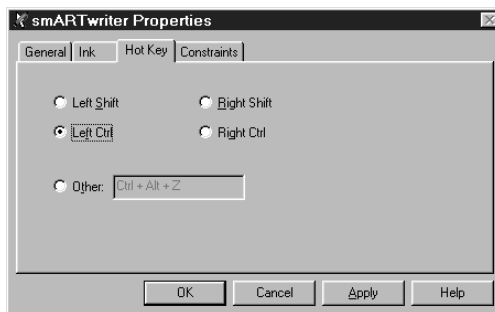

## Constraints

This tab lets you turn recognition filters on and off. Turning on filters helps to improve recognition.

As explained previously, smARTwriter searches through a large number of symbols in the Library of Models to find a match for each character you write. If you are inputting only characters from a certain group (lower case, numerals, etc.), you can constrain (limit) the search to those character groups and minimize recognition errors. To constrain the search, uncheck the character set(s) you are not using. You may check or uncheck any combination of sets to fit your writing style.



**Note**

- For every recognition operation, smARTwriter searches through all the character sets that are checked on the **Constraints** tab.

The following is an example of using Constraints.

1. Tap the smARTwriter icon in the icon tray and select **Properties...**  
Next, display the **Constraints** tab.

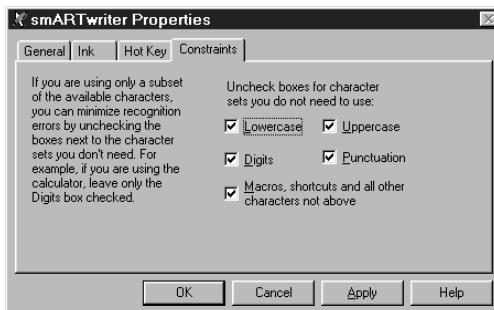

2. On the **Constraints** tab, uncheck all sets except **Lowercase** and then tap **OK**.
  - Now anything you write will be interpreted as lower case letters.

## Quitting smARTwriter

Use the following procedure to manually quit smARTwriter when necessary.

### To quit smARTwriter

1. Tap the smARTwriter icon in the icon tray.
2. Select **Exit** from the Menu.
3. On the confirmation dialog box confirming whether you want to quit smARTwriter, tap **Yes**.

# Using smARTscribble

---

## **Basic Concepts**

### **About smARTscribble**

smARTscribble is a sketching application you can use to draw on the screen and capture the ink pattern. The resulting image is a set of stylus strokes you can edit later. smARTscribble also lets you add text to the image.

The following are just some of the ways you can use smARTscribble.

- Taking handwritten notes - instantly put your ideas in writing.
- Drawing images, sketches, road maps, etc. with explanatory text.
- Combining any part of the ink or text with other Windows applications such as Microsoft Word.

## **Starting Up smARTscribble**

Select **Start** → **Programs** → **smARTwriter for Windows** and then tap the **smARTscribble** shortcut icon.

## **Working with Images**

### **To draw an image**

Simply use the stylus to draw on the screen of the FIVA as if you were drawing on paper.

### **To edit an image**

Use standard Windows editing procedures to edit images with smARTscribble. In other words, select the image and then edit it using **Cut**, **Copy**, **Paste** or **Delete**. You can access editing features by selecting them on the smARTscribble Edit menu or by using keyboard shortcuts.

You can also use the editing features of smARTscribble to paste images copied or cut from one document into another document.

## **Selecting Images**

### **To select a single image**

1. Tap the Selection Boundary button () on the smARTscribble tool bar. The button remains pressed until the selection procedure is complete.
2. Drag the stylus diagonally across the area containing the image you want to select. A selection boundary appears on the screen where you drag the stylus.

3. Lift the stylus from the screen. All the strokes contained within the selection boundary become highlighted. Strokes that are partially within the selection boundary are also highlighted.



- Selecting an area or image automatically cancels any previous selection on the screen.

### To select all the images on the screen

On the Edit menu, tap **Select All**.

### To delete an image

Select the image and then tap the Delete button ()

### To cut an image

Select the image and then tap the Cut button ()

. This deletes the image from the screen and places it onto the clipboard.

### To copy an image

Select the image and then tap the Copy button ()

. This places a copy of the image onto the clipboard without affecting the original image.

- Copied images can be pasted into documents created with other applications, such as Word.

### To paste an image from the clipboard

1. Tap the Paste button ()
2. Drag the pasted image (which is surrounded by a selection boundary) to the location you want it.
3. Tap anywhere outside the selection boundary to deselect the pasted image.

### To move an image

1. Select the image.
2. Drag the image to its new location with the stylus.

## Working with Text

With smARTscribble, you can add text anywhere in a smARTscribble document. Each text line you enter is considered a separate object containing a single line of text.

### To add new text

1. Tap the Text button () to switch to the text mode.
2. Tap the location in the document where you want to place the new text, and a text box appears on the screen.
3. Enter text into the text box.
4. After you are finished, tap anywhere outside the text box or tap the Text button again to finish entering text.

### To modify existing text

1. Tap the Text button () to switch to the text mode.
2. Tap the text item you want to edit.
3. Make any changes you want.
4. After you are finished, tap anywhere outside the text box or tap the Text button again to finish entering text.

### Editing Text

Use standard Windows editing procedures to edit text with smARTscribble. In other words, select the text and then edit it using **Cut**, **Copy**, **Paste** or **Delete**. You can access editing features by selecting them on the smARTscribble Edit menu or by using keyboard shortcuts.

### To select text

- To select a whole word, double-tap the word.
- To select a string of consecutive letters or words, drag the stylus across the text you want to select.

### To delete text

Select the text and then tap the Delete button ()

### To cut text

Select the text and then tap the Cut button ()

. This deletes the text from the screen and places it onto the clipboard.

### To copy text

Select the text and then tap the Copy button ()

. This places a copy of the text onto the clipboard without affecting the original text.

Note

- Copied text can be pasted into documents created with other applications, such as Word.

### To paste an image from the clipboard

Open the text box where you want to paste the text and then tap the Paste button ()

.

Note

- Text copied from other applications can be pasted into a smARTscribble text box.

### To insert the date and time into a page

On the File menu, tap **Time Stamp** to paste the date and time into the upper right corner of the active page.

To remove the date and time, deselect the **Time Stamp** option on the File menu.

## **Ink**

### ***Changing the Ink color***

#### **To change the color of the ink**

1. On the Edit menu, tap **Pen Color** to display the Color dialog box, which is a standard Windows color palette.

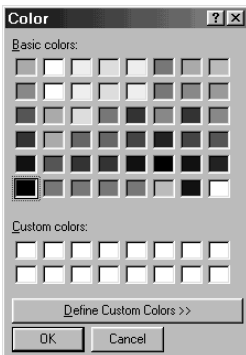

2. Select the color you want to use for the ink.



- For more information about using this dialog box, refer to your Windows documentation.

### ***Changing the Ink width***

smARTscribble supports three ink widths: thin, medium and thick. The currently selected width is always shown on the toolbar in the Ink Width box.

#### **To change the ink width**

1. Tap the **Ink Width** down arrow.



2. This displays the three available width options. Tap the width you want to select it.

## smARTscribble Documents

### Creating, Saving and Opening Documents



smARTscribble documents can be saved as files.

- smARTscribble document files have names that end with the extension INK. Any file with this extension is automatically associated with smARTscribble.
- To create a new smARTscribble document, tap **New** on the File menu.
- To save a smARTscribble document under its current name, tap **Save** on the File menu.
- To save a smARTscribble document under a different name, tap **Save As** on the File menu.
- To open an existing smARTscribble document, tap **Open** on the File menu.
- To save the current page in bitmap format (that you can print), select **Export Page as Bitmap** on the File menu.

### Navigating Around a Document

A smARTscribble document can have up to 20 pages of ink (images) and text. To scroll through the pages of a document, tap the ◀ or ▶ button. The number between the buttons indicates the current document page number.

### Guidelines

smARTscribble lets you display guidelines to help you align your images and text. You can select either gridlines or horizontal lines.

#### To show guidelines

On the View menu, tap either of the followings

- Grid: Displays a grid of dashed guides.
- Lines: Displays thin horizontal guides.

#### To hide guidelines

On the View menu, tap the currently selected guideline style (Grid or Lines) to deselect it.

## **Page Size**

Each new smARTscribble document page is sized to fit the FIVA screen. Use the Expand () to expand the size of the document page.

- To lengthen the size of a page, tap the Expand () button. This causes the page to expand downwards. You can view the area of the page off the bottom of the screen by using the vertical scrollbar on the right of the page.
- When you switch between pages, smARTscribble automatically adjusts the page size so all the data fits on the page.



## **Previewing a Document**

**To preview the current page:**

1. On the View menu, select **Page Preview**.
  - This displays the Page Preview window, which shows the contents of the entire page.
2. To close the Page Preview window, tap the **Close** button.



## Using Mobile Cockpit

Your FIVA comes with Mobile Cockpit pre-installed, an original CASIO application that makes operation quicker and easier. To start up Mobile Cockpit, tap the  on the Task Bar.

Mobile Cockpit can be displayed as a toolbar along the top of the display, which gives you quick and easy one-touch access to its functions.

### System Management Toolbar

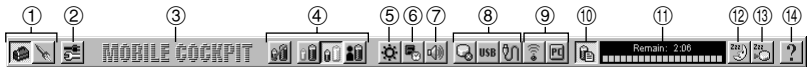

No.	Name	Description	Page
①	Toolbar Switch	Tap these buttons to switch between the System Management Toolbar and the Application Startup Toolbar.	74
②	System Tool Startup	Tap this button to access Power Management Tools and BIOS Tools.	75
③	Mobile Cockpit Settings	Right-tap here to display a menu for controlling icon size, hiding of the toolbar, etc.	79
④	Power Management Settings	Tap these buttons to switch between <b>Economy</b> , <b>Normal</b> , and <b>User Defined</b> Modes.	81
⑤	LCD Brightness	Tap this button to display a slider that controls display brightness.	84
⑥	CPU Clock Speed	Tap this button to display a slider that controls CPU Clock Speed.	84
⑦	Sound Volume	Tap this button to display a slider that controls speaker volume.	85
⑧	Hardware Power Management	Tap these buttons to cut off power to the hard disk, USB, multi-communication port.	86
⑨	Show Properties	Tap these buttons to display the properties of the infrared port or PC card.	87
⑩	Battery Report	Tap this button to display the battery report.	87
⑪	Battery Status	Tap this button to display the current battery status.	88
⑫	Standby Mode	Tap this button to enter the <b>Standby</b> Mode.	88
⑬	Hibernation Mode	Tap this button to enter the <b>Hibernation</b> Mode.	88,89
⑭	Help	Tap this button to display on-line help.	89

## ① Toolbar Switch

There are two different Mobile Cockpit toolbars, a System Management toolbar and an Application Startup Toolbar. Only one of these toolbars can be displayed at any time. Tapping the Toolbar Switch toggles between the System Management toolbar and Application Startup Toolbar.

### • **System Management Toolbar**

This toolbar makes it easy to set up the FIVA operating environment. Tapping an icon displays a setup dialog box, which you can use to make settings as indicated on the screen.

### • **Application Startup Toolbar**

Once you assign an application to the Application Startup Toolbar, you can start it up by simply tapping its icon. Use this toolbar for easy access to your frequently used applications.

### **About the Application Startup Toolbar**

Tap the Toolbar Switch to display the Application Startup Toolbar.

### **Assigning an Application to the Application Toolbar**

#### **To assign an application to the Application Toolbar from the Start menu**

On the Windows 98 Taskbar, tap **Start**, point to **Programs**, and drag the application you want from the **Start** menu and drop it on the Application Toolbar.

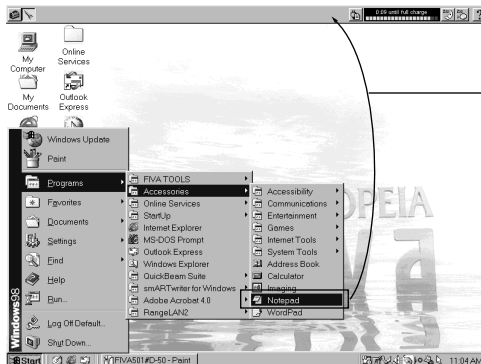

Drag and drop any applications.

### **To assign an application to the Application Toolbar from the My Computer folder**

Drag the application you want from the Windows 98 My Computer folder and drop it on the Application Toolbar.

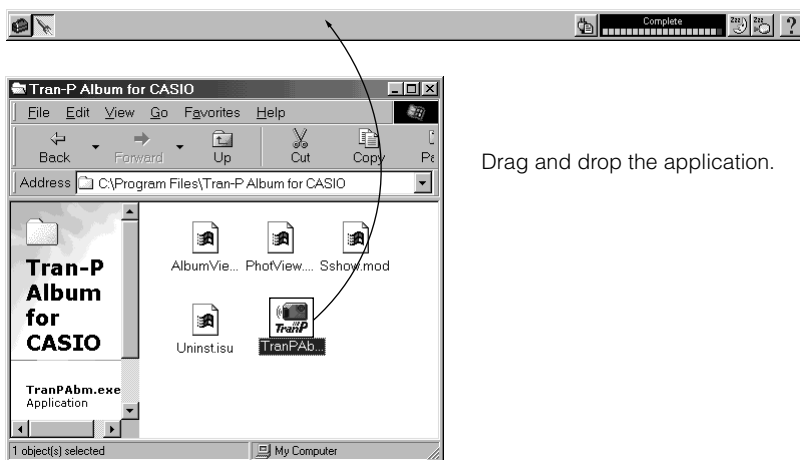

Drag and drop the application.

### **To launch an application from the Application Toolbar**

Tap the icon of an application to launch it.

### **To remove an application from the Application Toolbar**

Right-tap the icon of the application you want to remove (page 42).

Right-tap the applications's icon.



The above procedure simply removes the application's icon from the Application Toolbar. It does not uninstall the application.

## **② Starting Up a System Tool**

Tap the  icon on the System Management Toolbar. On the dialog box that appears, start up either Power Management Setup Tool or BIOS Startup Tool.

See “④ Making Power Management Settings” on page 81 for information about using Power Management Setup Tool.

Starting up BIOS Startup Tool displays the BIOS Settings dialog box.

## Displaying Current BIOS Settings

Mobile Cockpit lets you view the BIOS settings of your FIVA, and even make certain changes to them. Though the BIOS settings of FIVA are set to their optimal values at the factory, there may be special occasions when you need to change them.

### Important



- When you are unable to start up in the **Safe Mode** correctly for some reason, execute setup default from the BIOS Set UP UTILITY by holding down **Del** key while FIVA is starting up. Start up may be impossible if BIOS settings are not correct.



“BIOS” stands for Basic Input/Output System, which is the name of software that controls certain basic functions of your system.

Tap the Mobile Cockpit **Tools** icon.

Tap here.



Select this item.

## To display BIOS settings

Use the following procedure to check current BIOS settings.

On the menu that appears, click **BIOS Setup Tool**.

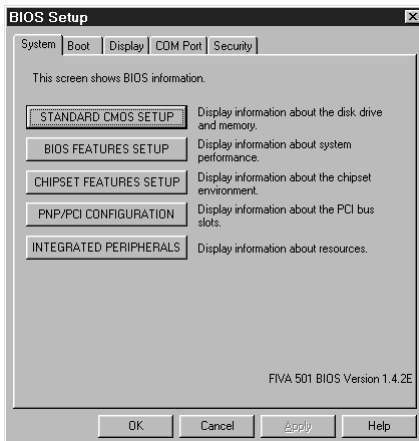

## Changing BIOS Settings

The following procedures can be used to change certain BIOS settings. The following describes the BIOS settings you can change and when you should change them.

- **CD-ROM Startup**

Whenever you want to use the “Product Recovery CD-ROM” to restore the hard disk drive to its initial factory setup, you need to first change the BIOS settings to allow startup from the CD-ROM.

- **Replicator COM Port Settings**

COM Port 1 normally is assigned as the Multi-Communication Port. Do not change these settings.

### 1) To specify CD-ROM startup

To use the “Product Recovery CD-ROM” to return hard disk settings to their initial factory defaults, you must first change the BIOS settings to enable system startup from the connected CD-ROM drive.

On the BIOS Settings screen, tap the **Boot** tab.

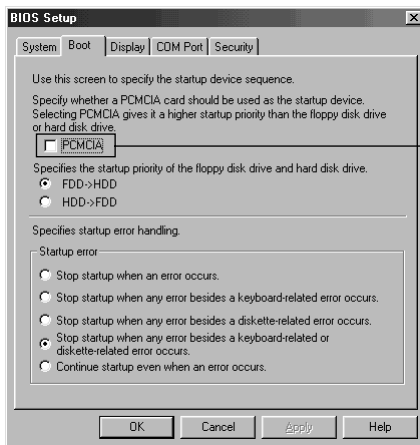

Check this item.

Check the checkbox next to “PCMCIA”.

Tap the **OK** button.

Now FIVA, it will start up from the CD-ROM.

## 2) To change replicator COM port settings

The factory default setting for the COM1 Port setting of a model equipped with a built-in modem is “Multi-Communication Port.” When using FIVA with an optionally available port replicator, you must change the COM1 Port setting to “Port Replicator” before connecting a peripheral device to the replicator’s serial port.

On the BIOS Settings screen, tap the **COM Port** tab.

Under COM Port 1, tap the selection button next to “Port Replicator”.

To use the built-in modem, you must first change the COM1 Port setting back to “Multi-Communication Port.”

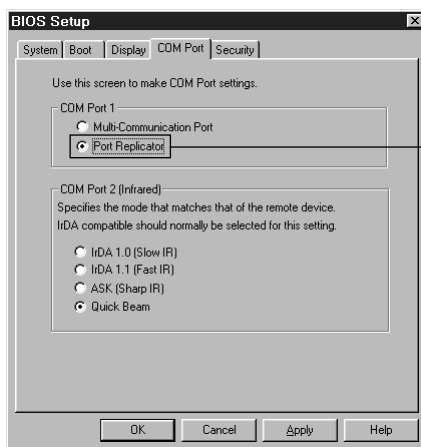

Check this item.

Tap the **OK** button.

## 3) Password Settings

You can register a password up to eight characters long to keep others away from using FIVA. Once you register a password, a prompt for password input will appear any time you turn on power or return to Windows 98 from the **Hibernation** Mode. In such cases, FIVA cannot be used until the correct password is input.

### Important



- If you forget your password, you will no longer be able to startup FIVA. Make sure you keep a separate record of the password or that you use a password you can remember easily.

On the BIOS Settings screen, tap the **Security** tab.  
You can specify separate passwords for **User** and **Supervisor**.

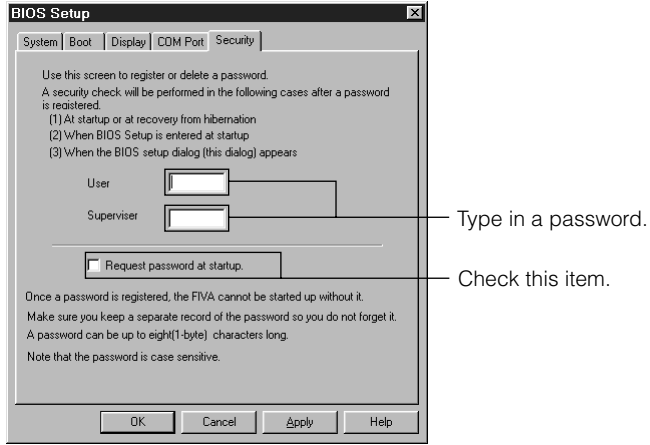

Check the checkbox next to “Request password at startup”.  
Tap the **OK** button.

### ③ Making Mobile Cockpit Settings

Right-tap on the MOBILE COCKPIT logo to display a menu of settings that control the size of buttons, and more. You can also display the Mobile Cockpit menu by clicking the **Mobile Cockpit** icon on the Toolbar.

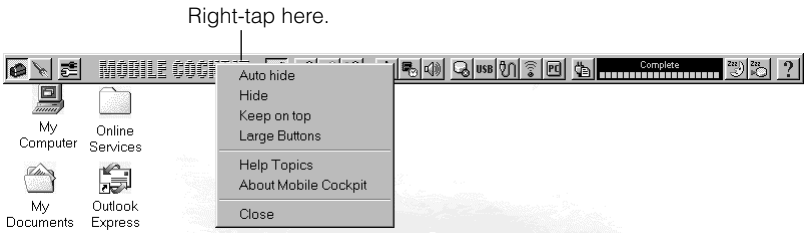

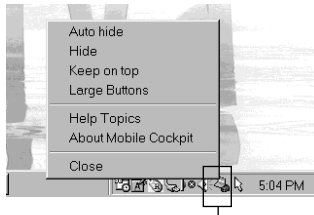

Tap the **Mobile Cockpit** icon.

The following describes the settings you can make with the Mobile Cockpit menu.

Menu Item	Description
Auto hide	Select this option when you want the Mobile Cockpit toolbar to hide automatically when it is not in use. The toolbar reappears automatically whenever you move the mouse pointer to the top of the display.
Hide	Select this option when you want to keep the Mobile Cockpit toolbar hidden. To make it reappear, tap the <b>Mobile Cockpit</b> icon on the toolbar, and then select <b>Hide</b> again.
Keep on top	Select this option when you want the Mobile Cockpit to always be on top of the windows currently on the display.
Large Buttons	Select this option to increase the size of the buttons that appear in the toolbar.
Help Topics	Tap this button to display on-line help about Mobile Cockpit.
About Mobile Cockpit	Tap this button to display Mobile Cockpit version information.
Close	Tap this button to exit Mobile Cockpit.



## ④ Making Power Management Settings

Power Management lets you control the amount of power supplied to the CPU, LCD, hard disk, and other peripherals in order to extend battery life. The followings are the available **Power Management** modes.

- **Economy** Mode
- **Normal** Mode
- **User Defined** Mode

The **User Defined** Mode lets you specify a number of Power Management parameters, including those listed below.

- Amount of time to allow after the last operation before the system goes into the **Standby** Mode
- Method for alerting the user to low battery power
- CPU Clock Speed
- LCD Brightness

### To change the Power Management Mode



Tapping the **Economy** Mode, **Normal** Mode, or **User Defined** Mode button changes to the corresponding mode. The following shows the settings that are made when the **Economy** Mode or **Normal** Mode is entered.

	<b>Normal Mode</b>	<b>Economy Mode</b>	<b>Power Management Off</b>
CPU Clock Speed	100%	50%	100%
Hard Disk Power Off	5 minutes	1 minute	No power off
LCD Brightness	90%	50%	100%
Time to Standby	10 minutes	2 minutes	No standby
Time to Hibernation	10 minutes	5 minutes	No Hibernation



Power Management is turned off automatically whenever the AC adaptor is connected to FIVA.

## To make user settings

1. Tap the Mobile Cockpit **Tools** icon.



Tap this icon.

2. On the menu that appears, tap **Power Management Setup Tool**.



Tap **Power Management Setup Tool**.

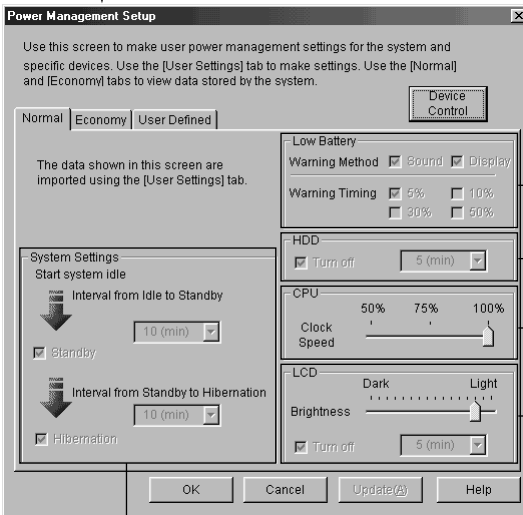

**System Settings**

**Low Battery**

**HDD**

**CPU**

**LCD**

Tap the User Defined tab on the Power Management Setup dialog, make the user settings you want, and then tap **OK**. You must restart FIVA before the settings you made take effect.



Item	Description
System Settings	Use the settings in this area to specify the amount of time that should pass after the last operation before the system goes into the <b>Standby</b> Mode, and the amount of time before it goes into the <b>Hibernation</b> Mode. For each of these settings, you can select 1, 2, 5, 10, 20, or 50 minutes.
Low Battery	Use the settings in this area to specify the level at which a battery warning operation should be performed. You can also specify whether the warning should be by audible alarm, dialog, or both.
HDD	Use this setting to specify the amount of time that should pass after the last operation before power to the hard disk is cut off. You can specify 15, 30 seconds, 1, 2, 5, 10, or 15 minutes. Power is automatically restored whenever the hard disk is accessed.
CPU	Use this slider to specify the CPU Clock Speed as 50%, 75%, or 100%. Slowing down the CPU reduces system performance, but it also extends battery life.
LCD	Use the settings in this area to specify the brightness of the LCD. Dimming the backlight extends battery life. You can also specify the amount of time that should pass after the last operation before power to the display is cut off. You can specify 1, 2, 5, 10, or 15 minutes.

## ⑤ Adjusting Display Brightness

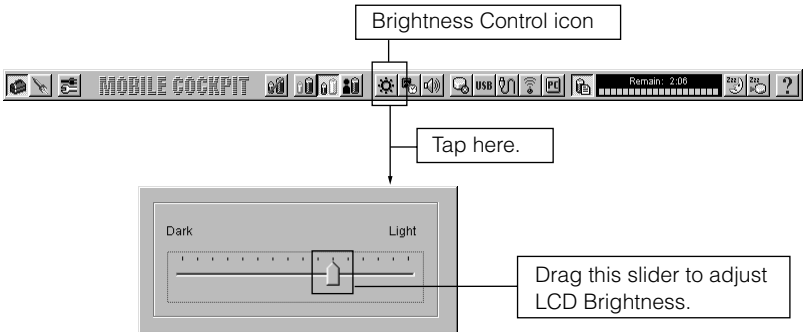
Tap the  button on the System Management Toolbar and make the settings on the dialog box that appears.



You can also make LCD brightness settings from the keyboard. See [page 27](#).

Press **[Fn] + "1"** (  ) to make the screen darker, and **[Fn] + "2"** (  ) to make it brighter.

## ⑥ Changing the CPU Clock Speed

Controlling the CPU clock speed reduces power consumption and helps to extend the life of the battery pack.

On the System Management Toolbar, tap the  button and make the settings you want on the dialog box that appears. You can select one of three CPU clock speed settings: 50%, 75%, or 100%.

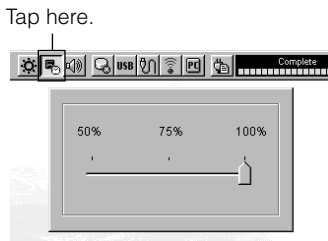

## ⑦ Adjusting Speaker Volume

Use the following procedure to adjust the sound output volume.

### **To adjust volume from Mobile Cockpit**

Tap the Mobile Cockpit **Volume Control** icon to open the volume control panel.

Drag the Volume Control slider up and down to adjust speaker volume.

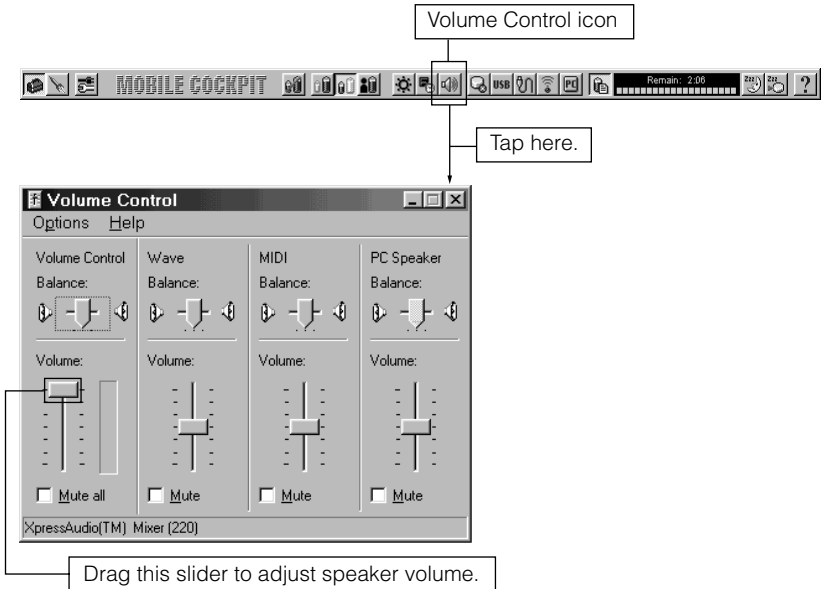

### To adjust volume from the Taskbar

Tap the **Volume Control** icon on the right side of the Taskbar to display the Volume Control panel. Drag the slider up and down to adjust speaker volume.

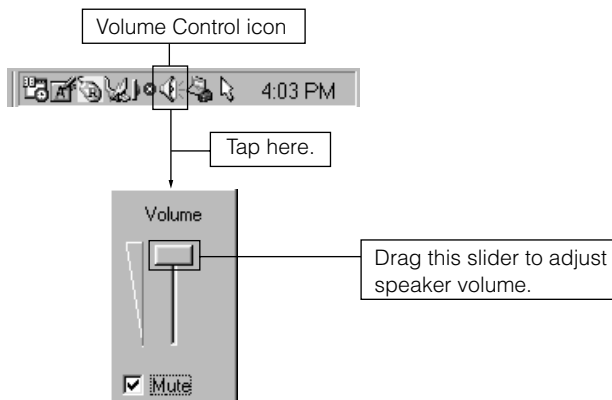





### To adjust volume using hot keys

Press **Fn** + "**5**" (🔊)▼ to decrease speaker volume, and **Fn** + "**6**" (🔊)▲ to increase it.

## ⑧ Power Management for Specific Hardware

You can use the following procedure to cut off power to the hard disk, USB, multi-communication port. Cutting off power to hardware reduces power consumption and helps to extend the life of the battery pack.

On the System Management Toolbar, touch the , , or  button to cut off power to the corresponding hardware. Before cutting off power to USB or the multi-communication port () , make sure first that the hardware is not in use. Power to the disk () is automatically turned back on when the disk is accessed. To resume power to the USB or the multi-communication port, tap the corresponding button again.

Tap one of these icons.





## 9 Show Properties



Tap here.

Tap these buttons to display the properties of the infrared port or PC card.

On the System Management Toolbar, tap the  button to display infrared port properties or  to displays PC card properties. The properties dialog box shows the settings and status of the infrared port and PC card. See [page 96](#) for information about the infrared port, and [page 98](#) for information about the PC card.

## 10 Displaying the Battery Report

Battery Report Tool shows the current status of the battery.

On the System Management Toolbar, tap the  button to display information about the connected battery pack. See “[Charging the Battery Pack](#)” on [page 31](#).

When the battery pack is being used alone, the Battery Report shows the estimated amount of operation time remaining with the battery pack.

When the AC adaptor is connected to FIVA, the Battery Report shows the amount of time until battery is fully charged.

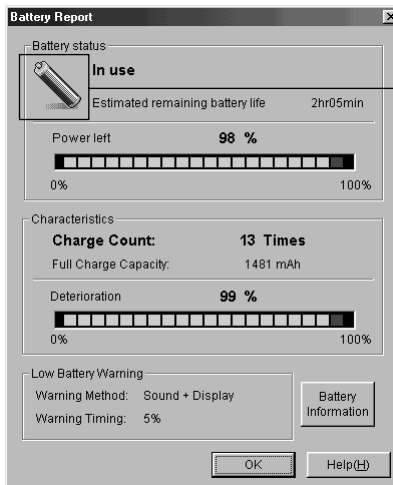

Indicates battery power only.

The screen in the left shows that your FIVA is under battery power only.

Battery Report under battery power only.

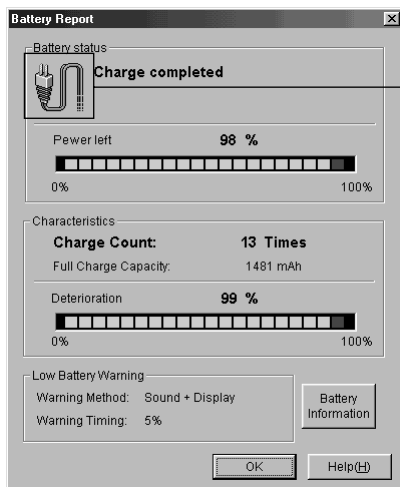

Indicates AC adaptor in use.

The values shown by the battery report tool differ according to the operating environment.

Battery Report when AC adaptor is connected.



## 11 Battery Level Indicator

The Mobile Cockpit also includes a green graphic meter that shows the current battery status. When the battery pack is being used alone, this meter shows the estimated amount of operation time remaining with the battery pack. When the AC adaptor is connected to FIVA, the meter shows the amount of time until a full charge is reached.



Battery status meter

## 12 Putting the System Into the Standby Mode

Tapping the Mobile Cockpit  icon puts the system into the **Standby Mode**, while the  icon puts the system into the **Hibernation Mode**.



Standby Mode  
Hibernation Mode

You can also enter the **Standby Mode** or **Hibernation Mode** using the following procedure.

Entering the **Standby Mode** or **Hibernation Mode** from the Keyboard Press **[Fn] + "3"** to enter the **Standby Mode** or **[Fn] + "4"** to enter the **Hibernation Mode**.



## 13 Entering the Hibernation Mode

See 12 above.

## 14 Using Mobile Cockpit Help

To display on-line help for Mobile Cockpit, select **Mobile Cockpit Help** from the Mobile Cockpit menu or tap the **?** button on the toolbar.

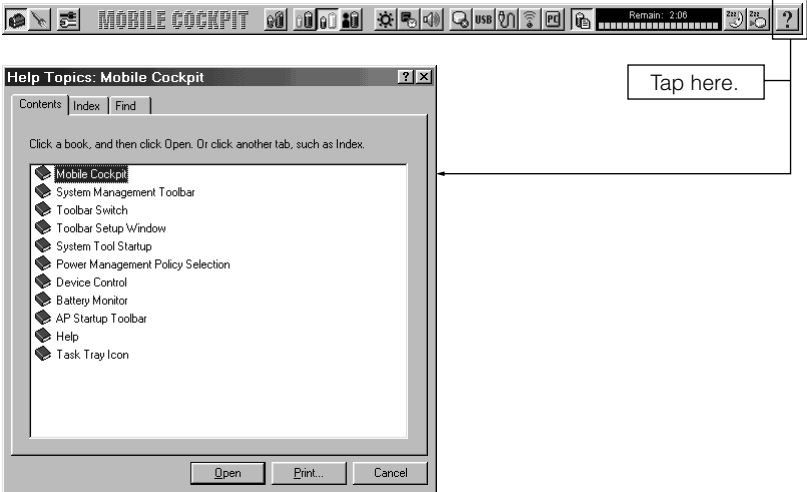

## Using the Battery Pack

---

A charged battery pack lets you run FIVA without connecting the AC adaptor. The following describes various power management functions that help to make battery pack operation more efficient.



- See [page 29](#) for information about attaching and removing the battery pack. See [page 31](#) for information about charging the battery pack.
- The battery pack naturally discharges even when you are not using it. To avoid problems due to premature rundown of the battery pack, charge it just before you plan to use it or charge the battery pack as you use it.

### **Checking the Current Charge Level of the Battery Pack**

The battery pack discharges naturally even when you are not using it. Make sure you charge the battery pack fully before trying to use it to power FIVA.

You can use any of the following three methods to check the current charge level of the battery pack.

#### **Checking the Power Indicator Lamp Color**

The  indicator lamp flashes amber if the battery charge level drops while FIVA is operating under battery power only. When this happens, connect the AC adaptor and charge the battery. If you continue to use FIVA under the low power condition, FIVA will automatically enter the **Hibernation** Mode when the battery charge level drops more. See [page 37](#).

#### **Important**



- You can specify the trigger level at which the low battery warning appears. See [page 82](#) for details.
- Turning on power while battery power is below the trigger level for low battery warning causes the warning message to appear on the display (Battery power is below XX%.) and power to turn off automatically. When this happens, connect the AC adaptor to power FIVA.



Battery charging is performed any time the AC adaptor is connected, even while FIVA is turned on. Note, however, that a full charge is attained more quickly when FIVA is turned off.

 <b>Power Indicator</b>	<b>Meaning</b>
Lit Amber	FIVA being powered by battery pack.
Flashing Amber	When using battery power only, indicates the <b>Standby Mode</b> .
Flashing Red	When using battery power only, indicates low battery power.
Lit Green	FIVA being powered by AC adaptor.
Flashing Green	<b>Standby Mode</b> (AC adaptor is used)

### ***Checking the Battery Indicator Lamp Color***

A green  indicator lamp is lit while FIVA is being powered by the AC adaptor indicates that the battery is fully charged. Charging is in progress when the  indicator lamp is amber. [See pages 87 to 88.](#)

### ***Checking with Mobile Cockpit***

Mobile Cockpit's battery monitor function lets you graphically view the charge level of the battery at any time. [See page 87.](#)

## ***Using the Battery Pack Effectively***

The amount of operating time you get from the battery pack is greatly affected by operating conditions and how you use it.

FIVA's mobile computing Power Management functions help to ensure that you get maximum power out of the battery pack.

### ***Forced Hibernation Mode***

To help ensure that you do not lose application data files, FIVA goes into forced **Hibernation** mode whenever the battery charge level drops below a certain point. When this happens, connect the AC adaptor and press the power switch to recover from the **Hibernation** mode. [See page 37.](#)

## When to Replace the Battery Pack

The battery pack is a consumable item, and after long use the amount of operating time provided by a fully charged battery can become quite short. This indicates it is time to replace the battery pack with a new one.

When the “Deteriorate Rate” of the Battery Report reads less than 30%, it is probably time to replace the battery pack.

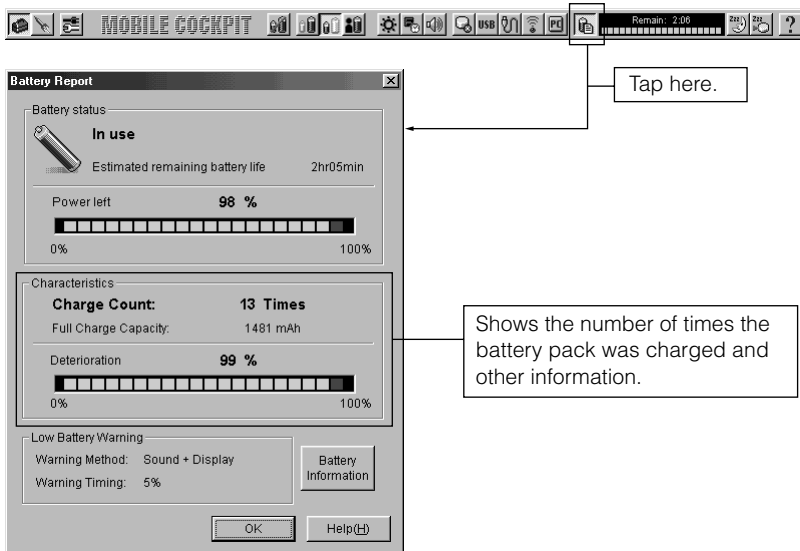

### Important



The values that appear in the Battery Report are provided for general reference only. Actual operability of the battery is affected by operating environment and other conditions.

## Using the Large-capacity Battery Pack

Use the optionally available battery pack (MPC-173BAT or MPC-174LBAT) when you need to operate FIVA for longer periods without AC adaptor power. The large-capacity battery pack provides about four hours of continuous operation on a full charge. The operation of the standard battery pack and the large-capacity battery pack included in standard is the same. (Attaching/Removing)

### Important



Be sure you use the correct battery pack. On the “Options List” ([page 124](#)), find the battery pack whose model number matches the number marked on the battery pack.

# Chapter 3

## Supplementary Information

**This chapter contains information about how to connect peripherals and what to do when you experience problems.**



Note the following important points before connecting a peripheral.

- **Some peripherals require changes in FIVA settings.**

Some peripherals require certain settings to be made before they can be used.

- **Use only special cables for connections.**

Use only the specified cables to connect peripherals. Even if the shape of a connector on a cable appears the same as that for the specified cable, it may not work properly. Carefully check to make sure you are using the correct cables.

- **Carefully read the documentation that comes with the peripheral.**

The peripheral connections described in this user's guide are general examples. Actual connection methods and settings depend on the peripheral. When connecting a peripheral, use the procedures provided in this user's guide in combination with the documentation that comes with the peripheral.

## Connecting a Peripheral to FIVA

A "peripheral" is a device, like a printer or external floppy disk drive that you connect to FIVA. The following procedure describes how to connect a peripheral to FIVA and how to install a PC card.

**Important**



For information about peripherals that are not explained in this user's guide, see a documentation that comes with the peripheral.

### **Connecting to the Communication Port**

Remove the connector cover from the right side of FIVA, and plug in the connector of the cable as far as it will go.

If your FIVA has a built-in fax modem, it can perform high-speed data communication, and send and receive faxes. Connect the supplied modular cable to the communication port to perform these functions.

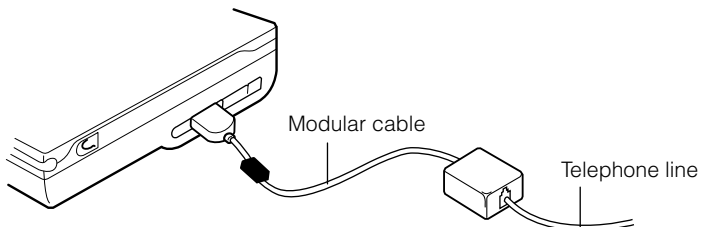



Never move FIVA with the communication cable connected to the communication port. Doing so can damage the communication port or cause the communication to bread. etc.

## Infrared Data Communication

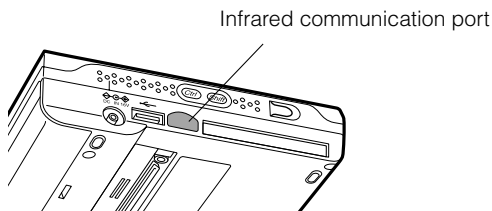

To exchange data, you have to start up the pre-installed infrared software.

1. On the Taskbar, tap the **Infrared Monitor** icon to open the Infrared Monitor screen.

Infrared Monitor icon (infrared disabled)



2. Tap the **Options** tab, and then check the checkbox next to the “**Enable infrared communication on**”.

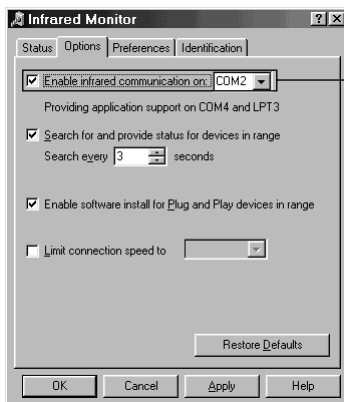

Check this option.

3. Tap the **OK** button.



4. On the Taskbar, check the **Infrared Monitor** icon to make sure that it has changed to the form that indicates infrared communication is enabled.

Infrared Monitor icon (infrared enabled)



FIVA comes with software named **Quick Beam**, for data exchange using the optional cradle. See the documentation that comes with the cradle for information about how to use it.

### Important



Leaving the infrared monitor on battery life. Be sure to power FIVA using the AC adaptor whenever performing infrared communications.

### USB Connection

The USB (Universal Serial Bus) lets you connect or disconnect peripherals without turning off FIVA power. There is one USB connector built into FIVA and one more on the port replicator or cradle.

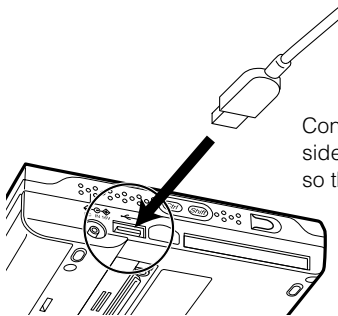

Connect the USB cable to the USB port on the side of FIVA. Orient the connector of the cable so the side marked  is facing upwards.

USB devices include the mouse, keyboard, printer, etc. Each requires a USB cable for connection. Use the appropriate cable for the device you are connecting.

A peripheral connected to the USB port draws power from the port. Click the USB icon and enable power before connecting a peripheral to the USB port. See “[⑧ Power Management for Specific Hardware](#)” on page 86 for more information.

# Loading PC Card and Expansion Memory

---

## Using a PC Card

FIVA has one “PC Card Standard PCMCIA TYPE II” PC card slot. The following describes the types of PC card that can be used.

- **LAN card**

This type of card makes it possible to interconnect multiple computers and exchange data using Ethernet.

- **Other SS wireless cards**

**Important**



- Long term use of PC card that generates a lot of heat can cause unstable card operation and malfunction.
- Never install or remove a PC card while an application is running.
- Never install or remove a PC card while system operation is suspended or in **Hibernation** Mode. Doing so can cause data to be deleted.



You can use the “Product Recovery CD-ROM” that comes bundled with FIVA to restore the hard disk. Use the optional CASIO MPC-142CDDE CD-ROM drive to access the CD-ROM.

A PC card must be oriented correctly when you insert it into the slot. Forcing a card into the slot upside-down can damage its connectors. Always make sure the card oriented correctly when inserting it into the slot.

**Important**



- Make sure you insert the PC card into the slot as far as it will go. An incorrectly inserted card can result in incorrect installation of the card's driver and malfunction.

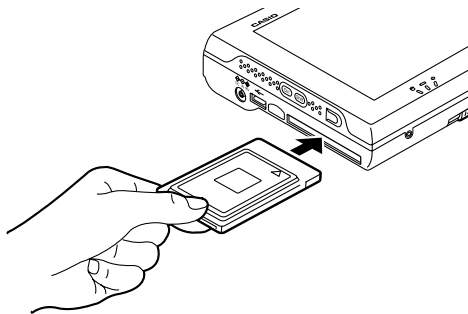

Normally when you insert a PC card, FIVA detects it automatically loads the required software. If automatic installation is not performed, follow the instructions that appear on the screen to install the software.

- Before removing the PC card from the slot, first tap the Mobile Cockpit **PC Card** button to disable the PC card and then remove it.

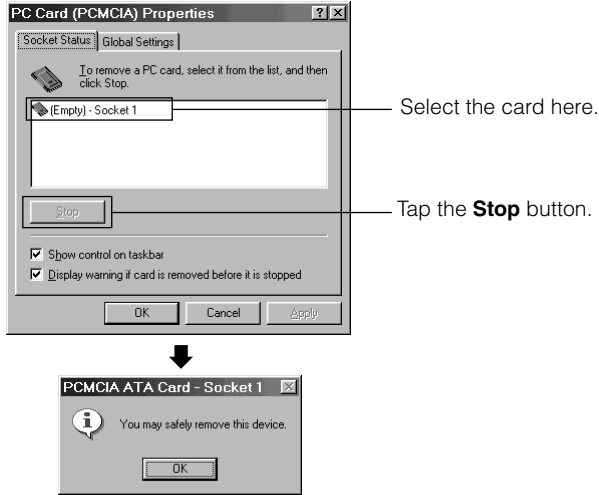

## Using the Port Replicator

The optionally available port replicator (MPC-160PR) provides connection ports for a PS/2 device (for mouse or keyboard), a USB device, a monitor, an RS-232C port device, a printer, and an external floppy disk drive.

### **To connect FIVA to the port replicator**

1. Quit all applications and shut down the system.
2. Disconnect the AC adaptor and all peripheral cables.

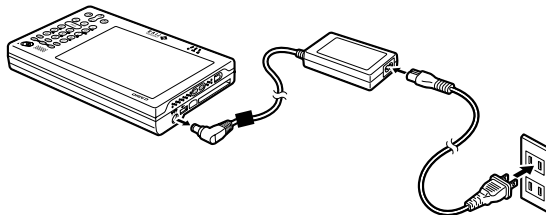

3. Turn over the FIVA.

4. Aligning the replicator connector on the bottom of FIVA with the connector on the port replicator, lower FIVA onto the port replicator. Make sure the hooks on the replicator fit into the holes on the bottom of FIVA. FIVA is properly attached to the replicator when the eject lever is fully extended.

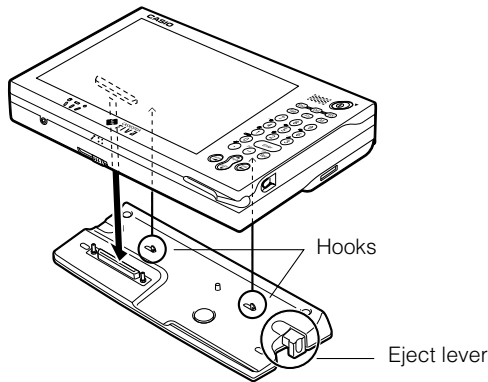

#### ***To remove FIVA from the replicator***

1. Quit all applications and shut down the system.
2. Disconnect the AC adaptor and all peripheral cables.
3. Pressing the port replicator's eject lever, lift FIVA from the port replicator.

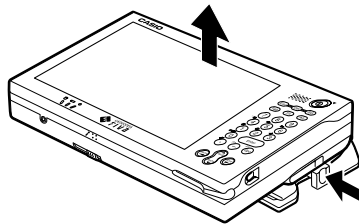

#### **Important**



- Never transport FIVA while it is mounted on the port replicator. If you do, FIVA may suddenly fall off and become damaged.
- Using a number of peripherals in combination with the port replicator can put large power demands on the FIVA power supply. Because of this, you have to use the AC adaptor whenever FIVA is connected to the port replicator.

## Using the Floppy Disk Drive

Connecting the optionally available floppy disk drive (MPC-140FDDE) lets you use both 720KB and 1.44MB floppy diskettes. A floppy disk drive lets you store your data on diskettes, and exchange data with another computer. FIVA is set up so you can use the external disk drive as soon as you connect it.

### To connect the floppy disk drive

1. Connect FIVA to the port replicator ([page 99](#)).
2. While FIVA is shut down, connect the floppy disk drive to the appropriate connector of the port replicator.

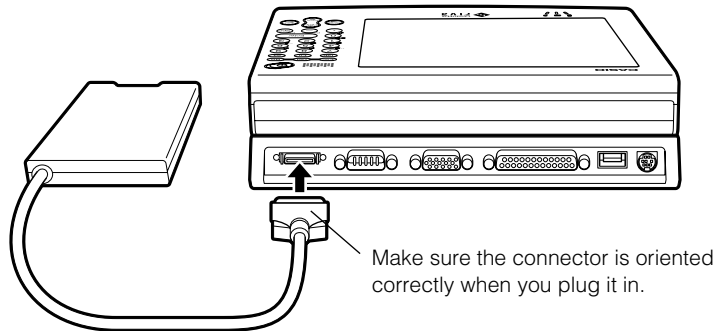

Press the connector in until the locks on both sides engage. The access lamp on the floppy disk driver lights or flashes whenever data is being written to or recalled from a disk. Never remove the floppy disk from the drive while the access lamp is lit or flashing. Doing so can cause data to be corrupted, or even lost data entirely.

### To write protect a floppy disk

Floppy disks have a write protect tab that you can use to protect the data on it from accidental deletion or change.

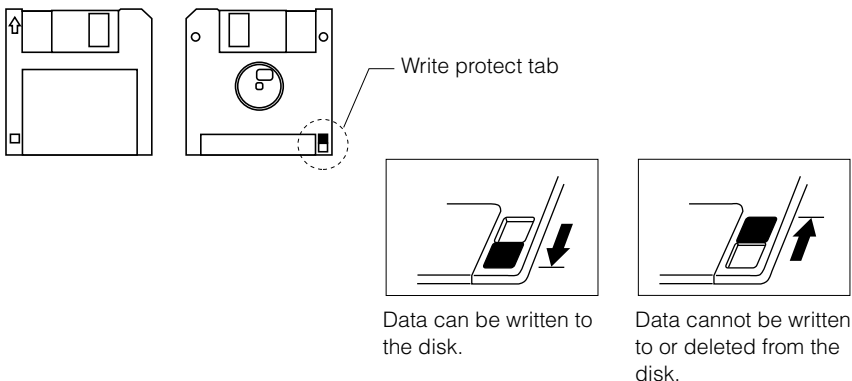

## Using an External Monitor

Use the following procedures to connect a CRT or LCD monitor to FIVA for big-screen viewing. Changing the display mode enables use of a mouse or other pointing device in place of the stylus.

### To connect a monitor

1. Connect FIVA to the port replicator ([page 99](#)).
2. While FIVA is shut down, connect the monitor to the appropriate connector of the port replicator.

Making sure the connector is oriented correctly, connect the cable from the monitor to the appropriate port on the port replicator.

Plug the power cord of the monitor into a wall outlet. See the documentation that comes with the monitor for details on its use.

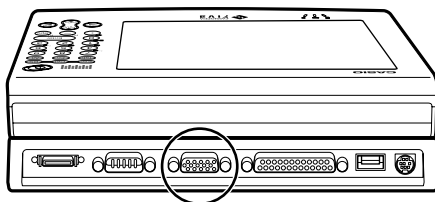

3. Turn on FIVA and start up Windows 98.
4. Press **[Fn] + "0"** to switch to the external monitor  
Each press of **[Fn] + "0"** cycles through monitor functions in the following sequence: LCD → CRT\* → LCD and CRT\* → LCD.  
CRT\* = External monitor

**Important**

The display screen momentarily goes blank whenever you change from one monitor function to another. This is normal and does not indicate malfunction.



You can specify the resolution and number of colors when using an external monitor alone. Right tap on the Windows 98 desktop, and on the menu that appears select **Properties**.

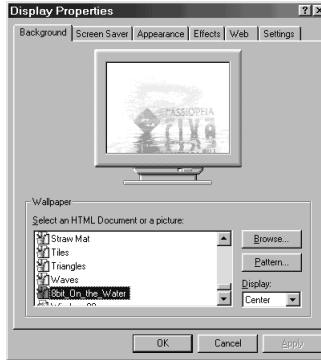

- Tap the **Settings** tab, and then make the **Colors** and **Screen area** settings you want.

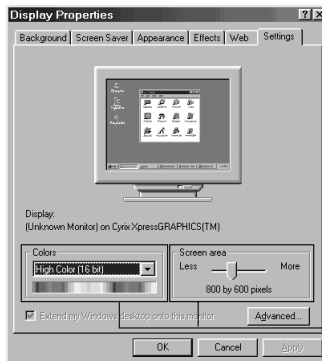

Change these settings.

The following table shows the setting combinations that can be made for **Colors** and **Screen area**.

Colors	Size (Pixels)
16-bit	640×480/800×600/1024×768
256 Colors	640×480/800×600/1024×768
16 Colors	640×480/800×600/1024×768

- The actual **Colors** and **Screen area** settings you will be able to make depend on the type of monitor you are using.

### **Connecting a Mouse or External Keyboard**

You can connect a mouse or external keyboard to the PS/2 port. Use the standard Windows 98 properties screen to make mouse settings.

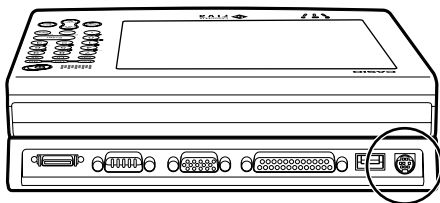

### **Connecting a USB Device**

Use the USB port to connect separately available USB compatible device.

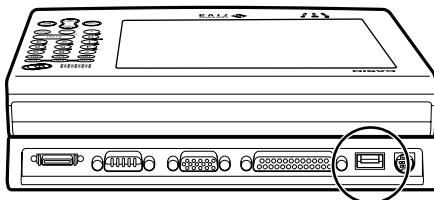

### **Connecting an RS-232C Peripheral**

The RS-232C port, which is named COM1 under Windows 98, can be used to connect serial device. Note that you cannot use the RS-232C port while the built-in modem is enabled. Use Mobile Cockpit to switch between the built-in modem and the RS-232C port.

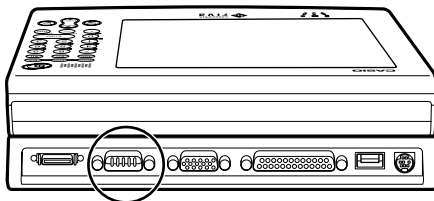

### **Connecting a Printer**

Use the parallel port to connect a separately available printer or other parallel device. This port is named LPT1 under Windows 98.

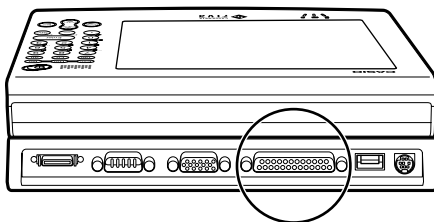



# Troubleshooting

---

This section describes what you should do whenever you start to experience problems with operation of FIVA, its peripherals, or the applications you are running.

## ***Basic Troubleshooting***

***Note the following important points whenever you are experiencing problems.***

**1. Take your time.**

If the system seems to hang up, resist the urge to turn off power, click things on the display, or press keyboard keys. The operation you are performing may simply require a bit more time.

**2. Take notes of information that appears on the display.**

Message, numbers, and codes that appear on the display may provide hints to the cause of the problem and what you need to overcome it. Keep notes of such information when it appears on the display.

**3. Try to determine the possible cause of the problem.**

If FIVA is the source of the problem, or is it being caused by a peripheral or application? Does the same operation or conditions always cause the same problem?

Is there something distinctive about the problem?

**4. Check the documentation and on-line help.**

You may be able to find information that leads to the solution of the problem in the documentation or on-line help of FIVA, its peripherals, or your applications.

## System Outline

Have the following information handy whenever you request user support.

### Memo about your system

<b>FIVA</b>	Model	
	Serial Number (on the bottom panel)	
	Memory Capacity(MB)	
	Hard Disk Capacity (GB)	
	Hard Disk Free Space (MB)	
	Battery Pack (Used/No Used)	
<b>Peripherals</b>	External Monitor	
	Printer	
	PC Card	
	Other Peripherals	
<b>Software</b>	Windows Version	
<b>Remarks</b>	All applications running when problem occurred	

Other information about FIVA can be found by visiting the CASSIOPEIA Website at: <http://www.casio.co.jp/English/system/>

## **FIVA Malfunction**

<b>Symptom</b>	<b>Recommended Action</b>
FIVA is emitting smoke and heat.	Immediately turn off power and unplug the AC adaptor from the wall outlet.
FIVA malfunction	Contact your original dealer or authorized distributor. Have the following information on hand. <ul style="list-style-type: none"><li>• Product name and model number</li><li>• Date of purchase</li><li>• Current status and the names of applications being used</li></ul>
You don't know what to do.	Contact your authorized distributor. Have the following information on hand. <ul style="list-style-type: none"><li>• Product name and model number</li><li>• Date of purchase</li><li>• Current status and the names of applications being used</li></ul>

## Power Supply

Symptom	Recommended Action
<p>Power does not turn on.</p> <ul style="list-style-type: none"> <li>• Power indicator lamp is flashing red.</li> <li>• Power turns on but immediately turns off.</li> <li>• Nothing happens when the power switch is pressed.</li> </ul>	<p>Use the AC adaptor to power FIVA.</p> <ul style="list-style-type: none"> <li>• Use a fully charged battery pack. If the battery pack has small charge when power is turned on, a warning message appears momentarily and power turns off.</li> </ul>
<p>Power turns on, but the system does not start up.</p> <ul style="list-style-type: none"> <li>• The system does not start up when power is turned on in the <b>Hibernation Mode</b>.</li> </ul>	<p>Leaving power turned on, press the RESET switch on the bottom of FIVA. Note that the RESET operation will result in loss of any data saved by the <b>Hibernation Mode</b>.</p>
<p>Power turns off.</p> <ul style="list-style-type: none"> <li>• FIVA suddenly goes into the <b>Hibernation Mode</b> and power turns off while you are using it.</li> </ul>	<p>Wait for a while to allow the interior of FIVA to cool off. See the  at the bottom of this page.</p> <p>Use the AC adaptor or a fully charged battery pack to power FIVA. A low battery pack can cause power to suddenly turn off.</p>
<p>Battery pack does not supply much operation time, even after a full charge.</p>	<p>Open the Mobile Cockpit Battery Report and check the battery inferior rate. If it is below 30%, you may need to replace the battery pack with a new one.</p>



For safety reasons, FIVA is designed so CPU Clock Speed slows down whenever internal temperature rises above a certain level. If operation continues, FIVA automatically enters the **Hibernation Mode**.

## Display Problems

Symptom	Recommended Action
Nothing on the display, Power indicator lamp is not lit.	Press the power switch to turn on power.
Display has gone blank.	Press <b>[Shift]</b> . FIVA's power saving function causes the display to go blank if no operation is performed for some time. <a href="#">See page 88.</a>
The operator cannot remember the Windows 98 password.	Input a new user name in the Windows Log On screen, or restore the system to its factory defaults.
The operator cannot remember the password registered in the BIOS settings.	With your FIVA model number on hand, contact your original dealer or authorized distributor.
Display contents are difficult to see.	Reorient FIVA so you can view the display at a different angle.
Display is dim.	Use <b>[Fn] + "1"</b> or <b>[Fn] + "2"</b> to adjust display brightness. If the display remains dim at a bright setting, it may mean that it has reached the end of its service life. With your FIVA model number on hand, contact your original dealer or authorized distributor.
Nothing appears on the display.	Press <b>[Fn] + "0"</b> to cycle through monitor functions until the display you want to use it selected. <a href="#">See pages 27 and 102.</a>

## Software Problems

Symptom	Recommended Action
Cannot perform infrared data communication.	<p>Make the proper infrared port settings.</p> <ul style="list-style-type: none"> <li>• Make sure the data transfer speed set for FIVA is the same as that set on the other device.</li> <li>• Make sure there are no obstructions in the infrared path between the two devices.</li> </ul>
Cannot send data correctly using infrared data communication.	<p>Make sure the data transfer speed set for FIVA is the same as that set on the other device.</p> <ul style="list-style-type: none"> <li>• Change the distance between FIVA and the other device.</li> <li>• Move the two devices to an area that is not exposed to direct sunlight or fluorescent lighting.</li> </ul>
Sound output is too slow.	Turn off sound playback and then turn it back on again.
Sound output is broken.	<p>Tap the Mobile Cockpit <b>CPU</b> icon and then use the slider to set the CPU Clock Speed to 100%.</p> <ul style="list-style-type: none"> <li>• Quit other applications before the adjustment.</li> </ul>
Audio skips during audio playback or communication errors occur during communication from the multi-communication port.	<p>These conditions are caused by any of the followings.</p> <ul style="list-style-type: none"> <li>• Changing the power supply between AC adaptor power and battery pack power</li> <li>• Running the battery report</li> <li>• Large load on the FIVA CPU</li> <li>• Reduction of CPU clock speed due to internal overheating</li> </ul>
Occasional inability to record from the microphone or output sound from the speaker.	Change the volume control setting or re-start FIVA. See <a href="#">page 85</a> of this User's Guide for information about using the speaker.

Symptom	Recommended Action
<p>Built-in modem does not work. (MPC-501M62E only)</p>	<ul style="list-style-type: none"> <li>• On the BIOS Settings screen, change the COM1 Port setting to “Multi-Communication Port.” <a href="#">See page 78</a> of this User’s Guide.</li> <li>• Check the Mobile Cockpit screen to see if the Port Replicator icon is enabled. <a href="#">See page 79</a> of this User’s guide.</li> </ul>
<p>The microphone suddenly fails during recording or output from the speaker suddenly cuts off during playback</p>	<ul style="list-style-type: none"> <li>• Change the audio volume setting or restart the application.</li> </ul>

## General Operation Problems

Symptom	Recommended Action
Power indicator lamp flashes red immediately after charging.	Purchase a new battery pack and replace the current one. Battery packs tend to lose their ability to charge after long use.
FIVA beeps during operation.	Connect the AC adaptor and charge the battery. Beeping indicates low battery power.
FIVA suddenly hangs up.	<ul style="list-style-type: none"> <li>• If you suspect that the problem is due to low battery power, connect the AC adaptor and charge the battery.</li> <li>• If you suspect that the problem is being caused by the application you are using, press the RESET switch and restart Windows 98.</li> </ul>
System runs too slow (1).	<ul style="list-style-type: none"> <li>• Try turning power off and then back on again.</li> <li>• Memory may be low, which means you have to increase it by installing a separately available DIMM board.</li> </ul>
System runs too slow (2).	If Power Management is causing the system to go into the <b>Economy</b> Mode, try changing the <b>Normal</b> Mode or turning Power Management off. <a href="#">See page 81.</a>
System runs too slow (3).	Turn power off and wait a while. Normal operation should return after FIVA has a chance to cool off.
Displayed date and time are wrong.	<ul style="list-style-type: none"> <li>• Use the Control Panel to set the correct date and time.</li> <li>• If the date and time seem to require frequent setting, it may mean that the clock battery is low. Contact your original dealer or authorized distributor about having the clock battery replaced.</li> </ul>
The screen temporarily goes white when FIVA is starting up or when the display mode is changed.	This is normal and does not indicate any malfunction or problem.



## General Operation Problems (continued)

Symptom	Recommended Action
Hot keys do not work.	Tap the Taskbar's <b>Start</b> button and start up Mobile Cockpit from the Programs menu.
Mobile Cockpit is not displayed.	<ul style="list-style-type: none"><li>• If Mobile Cockpit is not running, tap the Taskbar's <b>Start</b> button and start up Mobile Cockpit from the Programs menu.</li><li>• If the Mobile Cockpit toolbar is hidden, tap the <b>Mobile Cockpit</b> icon on the Taskbar and then uncheck the Hide option on the menu that appears.</li></ul>
Windows 98 is hung up.	<ul style="list-style-type: none"><li>• Press <b>Ctrl</b> + <b>Alt</b> + <b>Del</b>, and then tap the <b>Shut Down</b> button. Next, restart Windows 98.</li><li>• If <b>Ctrl</b> + <b>Alt</b> + <b>Del</b> does not work, press the RESET switch and then restart the system.</li></ul>

The following explanation, pages 114 to 117, is about the Terminal Equipment (hardware modem) embedded in CASSIOPEIA FIVA series (models with the modem) and described by following the rules. The Terminal Equipment is operable and compliant with the regulations in the United States and Canada only. For users of CASSIOPEIA FIVA series resident in other countries and some models that do not embed the Terminal Equipment (models without the modem), the description and the instruction of the equipment are not applicable.

## **Using the Terminal Equipment MBH7MD23-8556CA**

---

**MBH7MD23-8556CA** is a hardware modem designed for being embedded in small personal computers such as a notebook computer.

About the actual operation and setting of hardware and software, refer to the user operation manual of the products which have an embed **MBH7MD23-8556CA**.

### ***For users in the United States***

This equipment complies with Part 68 of the FCC rules. On the back side of this equipment is a label that contains, among other information, the FCC registration number and ringer equivalence number (REN) for this equipment. If requested, this information must be provided to the telephone company.

USOC Jack,RJ11C is available to this equipment.

An FCC compliant telephone cord and modular plug is provided with this equipment. This equipment is designed to be connected to the telephone network or premises wiring using a compatible modular jack which is Part 68 compliant. See Installation Instructions for details.

The REN is used to determine the quantity of devices which may be connected to the telephone line. Excessive RENs on the telephone line may result in the devices not ringing in response to an incoming call. In most, but not all areas, the sum of RENs should not exceed five (5.0). To be certain of the number of devices that may be connected to a line, as determined by the total RENs, contact the local telephone company.

If the terminal equipment MBH7MD23-8556CA causes harm to the telephone network, the telephone company will notify you in advance that temporary discontinuance of service may be required. But if advance notice isn't practical, the telephone company will notify the customer as soon as possible. Also, you will be advised of your right to file a complaint with the FCC if you believe it is necessary.

The telephone company may make changes in its facilities, equipment, operations or procedures that could affect the operation of the equipment. If this happens the telephone company will provide advance notice in order for you to make necessary modifications to maintain uninterrupted service.

If trouble is experienced with this equipment MBH7MD23-8556CA, for repair or warranty information, please contact CASIO INC. (973-361-5400). If the equipment is causing harm to the telephone network, the telephone company may request that you disconnect the equipment until the problem is resolved.

This equipment cannot be used on public coin phone service provided by telephone company. Connection to party line service is subject to state tariffs. (Contact the state public utility commission, public service commission or corporation commission for information.)

The Telephone Consumer Protection Act of 1991 makes it unlawful for any person to use a computer or other electric device, including fax machines, to send any message unless such message clearly contains in a margin at the top or bottom of each transmitted page or on the first page of the transmission, the date and time it is sent and an identification of the business or other entity, or other individual sending the message and the telephone number of the sending machine or such business, other entity, or individual.

In order to program this information into your fax machine, you should see your FAX application software manual.

According to the FCC's electrical safety advisory, we recommend that you may install an AC surge arrestor in the AC outlet to which this equipment is connected. Telephone companies report that electrical surges, typically lightning transients, are very destructive to customer terminal equipment connected to AC power source and that this is a major nationwide problem.

This equipment is registered with the FCC under Part 68 as a component device for use with CASIO COMPUTER CO., LTD. models CASSIOPEIA FIVA Series. In order for the FCC registration of this product to be retained, all other products used in conjunction with this product must also be FCC Part 68 registered for use with this host. If any of these components are not registered, then you are required to obtain FCC Part 68 registration of the assemblies equipment prior to connection to the telephone network. Part 68 registration requires that you maintain this approval and as such are responsible for the following:

Any component added to your equipment, whether is bears component registration or not, will require a Part 68 compliance evaluation. You may need to test and make a modification filing to the FCC before that new component can be used;

Any modification/update made by a manufacturer to any registered component within your equipment, will require a Part 86 compliance evaluation. You may need to test and make a modification filing to the FCC before that modified component can be used;

If you continue to produce this component you are required to comply with the FCC's Continuing Compliance requirements.

Therefore is all recommended that only FCC Part 68 registered devices bearing the 'CN' or 'CE' equipment code as part of FCC registration number. be used. To determine if your particular component is appropriately approved, look for the FCC registration number on all components and ensure that the classification code '-CN-' or '-CE-' is part of that number. Refer to the FCC Registration number on this products as an example."

If the telephone Company requests that you supply the FCC Registration number and REN of the device you are connecting, please supply the FCC Registration numbers from all component and host devices that have a direct PSTN connection (i.e. have a REN stated on the label) and the highest REN.

### ***Notice Concerning FCC Redial Regulations***

Note that federal law prohibits you from using software that is not in compliance with FCC rules that regulate redialing on the computer or other device where this modem is installed.

### ***For users in Canada***

**NOTICE:** The Industry Canada label identifies certified equipment. This certification means that the equipment meets telecommunications network protective, Operational and safety requirements as prescribed in the appropriate Terminal Equipment Technical Requirements document(s). The Department does not guarantee the equipment will operate to the user's satisfaction.

Before installing this equipment, users should ensure that it is permissible to be connected to the facilities of the local telecommunications company. The equipment must also be installed using an acceptable method of connection. The customer should be aware that compliance with the above conditions may not prevent degradation of service in some situations.

Repairs to certified equipment should be coordinated by a representative designated by the supplier. Any repairs or alterations made by the user to this equipment, or equipment malfunctions, may give the telecommunications company cause to request the user to disconnect the equipment.

Users should ensure for their own protection that the electrical ground connections of the power utility, telephone lines and internal metallic water pipe system, if present, are connected together. This precaution may be particularly important in rural areas.

**Caution:** Users should not attempt to make such connections themselves, but should contact the appropriate electric inspection authority, or electrician, as appropriate."

**NOTICE:** The **Ringer Equivalence Number** (REN) assigned to each terminal device provides an indication of the maximum number of terminals allowed to be connected to a telephone interface. The Termination on an interface may consist of any combination of devices subject only to the requirement that the sum of the Ringer Equivalence Numbers of all the devices does not exceed 5."

The Ringer Equivalence Number of This terminal equipment is 0.4.

## **Main functions of the modem**

<b>Network control functions</b>	Automatic Send and Receive by built-in NCU
<b>Modem protocols</b>	Conforms to the following protocols and possible to communicate in full duplex V.21/V.22bis/V.32/V.32bis/V.34/V34bis/V.90/K56flex/V.27ter/V.29/V.17
<b>Data compression protocols</b>	Conforms to MNP 5, ITU-T V.42bis
<b>Error control protocols</b>	Conforms to MNP 4, ITU-V.42

Function	Protocol	Speed	Comment
Data communication (Send and Receive)	ITU-T V.21	300	
	ITU-T V22bis	2400, 1200	
	ITU-T V32	9600, 4800	
	ITU-T V32bis	14400, 12000, 9600, 7200, 4800	
	ITU-T V34	28800, 26400, 24000, 21600, 19200, 16800, 14400, 12000, 9600, 7200, 4800, 2400	
	V34bis	33600, 31200, 28800, 26400, 24000, 21600, 19200, 16800, 14400, 12000, 9600, 7200, 4800, 2400	
Data communication (Receive only)	V.90	56000, 54667, 53333, 52000, 50667, 49333, 48000, 46667, 45333, 42667, 41333, 40000, 38667, 37333, 36000, 34667, 33333, 32000, 30667, 29333, 28000	
	K56flex	56000, 54000, 52000, 50000, 48000, 46000, 44000, 42000, 40000, 38000, 36000, 34000, 32000	
FAX communication	ITU-T V.27ter	4800, 2400	
	ITU-T V.29	9600, 7200	
	ITU-T V.17	14400, 12000, 9600, 7200	There are two modes, Long and Short in each speed respectively

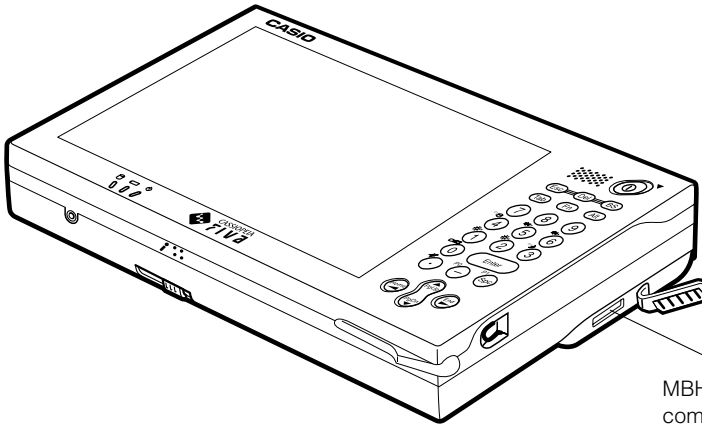

MBH7MD23-8556CA  
communication connector

### ***Connecting to telephone line***

The dedicated modular cable that comes with the modem shall be used to connect the modem to the telephone line.

In this case, if the telephone line is available through the modular jack, it is possible to connect the modem to the telephone line with the dedicated communication cable directly.

Otherwise, an adapter is required or modification of the telephone line socket might be necessary.

## Connecting to the FIVA

Turn off the power of the FIVA first and then connect as depicted below.

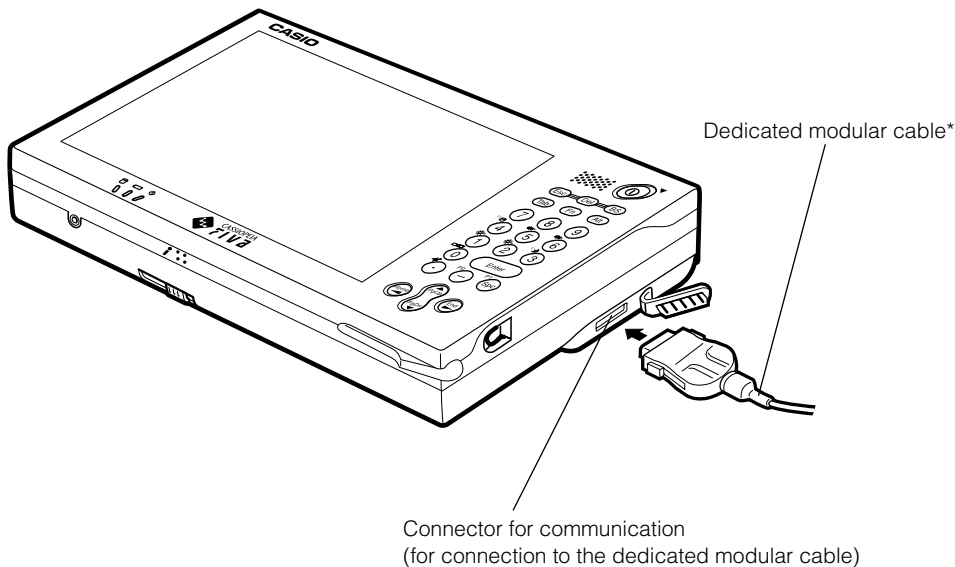

\* **Modular cable:**

Part No.: PX735-UL-MC

CASIO INC.

(Toll free: 973-361-5400)



For the connection to the telephone line, connect the modular jack directly as shown below or connect via Inline Coupler.

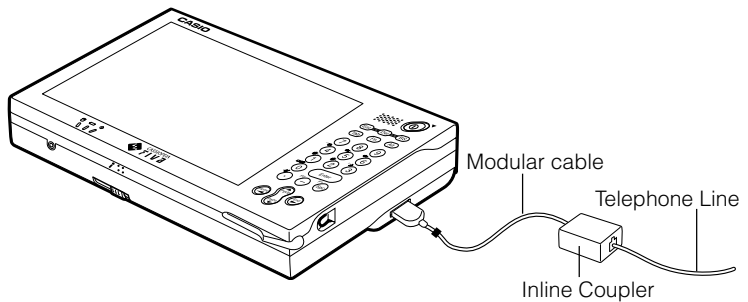
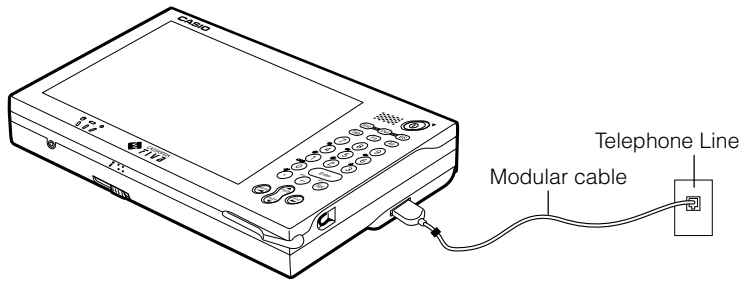

### ***Caution on operation of the product***

To use this product, operate as instructed below since this is designed to be embedded in the FIVA.

1. The product must be set in a case upon use.
2. Do not leave the product in the area such as hot and humid or exposed to direct sunlight since the product is precisely designed.
3. Do not spill any liquid such as water on the product.
4. Do not touch the electric terminals without discharging static fully otherwise it will cause electric static damage.
5. In case the product is used exceeding the maximum specification, there is possibility that LSIs inside might be damaged permanently. Therefore, it is favorable to use the product under the normal operation conditions. If the product is left above the normal operating conditions, it might be possible to affect to the reliability of the LSIs.

# Specifications

Model		MPC-501M62E	MPC-501M63E	MPC-501M63O
CPU		National Semiconductor Geode (MediaGX)		
CPU operating frequency/ Built-in Cache Memory		200MHz/16KB		
Memory	Main	32MB		
	Expanded Memory (RAM)	32/64MB (one expansion RAM slot, 96MB maximum total)		
	ROM	256KB (BIOS), supports plug and play		
	Video RAM	2.5MB (UMA)		
Hard Disk (Built-in)		10GB	15GB	
Monitor Functions	Monitor Device	6.7-inch HAST TFT color LCD (with backlight); touch panel screen		
	Resolution*1	SVGA (800 × 600 dots), 65,536 colors		
Input Device	Keyboard	10-key pad; arrow keys; control keys		
	Touch Screen	Analog film resistor touch panel		
	Sound Functions	Monaural speaker (built-in); monaural microphone (built-in); PCM (Sound Blaster 16 compatible) sound source		
Sound Functions		Monaural speaker (built-in)		
		Monaural microphone (built-in)		
		PCM (Sound Blaster 16 compatible) sound source		
Interfaces	Built-in	USB, 1 channel		
		IrDA1.1 compliant infrared port (Data Transfer Rate: 4Mbps, 115.2Kbps/ASK maximum)		
	Communi- cation Ports	Modem (56kpbs receive, V.90; FAX: 14.4kpbs)	Serial	
	With Port Replicator (option)	USB × 1		
		External FDD × 1		
		Serial (D-SUB 9-pin male) × 1		
		Parallel (D-SUB 25-pin female) × 1		
		Video (mini D-SUB 15-pin female) × 1		
		PS/2 × 1		
PC Card Slot		Type II × 1 slot (Card Bus compliant)		
Power Management		Auto or manual settings		
Timekeeping		Clock battery backup		
Security		Power on password		

<b>Battery Pack (Included)</b>	Type	Lithium ion battery (Rating: 11.1V, 3000mAh) (corresponds to the MPC-174LBAT)	
	Approximate Operation Time	6 hours • Actual times depend on operating conditions and connected peripherals.	
	Battery Charging Time	Power Off: Approximately 4 hours	
	Dimensions	206(W) × 46(D) × 25(H) mm (8.1"(W) × 1.81"(D) × 0.98"(H))	
	Weight	320g	
<b>Power by AC adaptor</b>	45W 16V AC adaptor (Input: 100 to 240V AC, 50/60Hz)		
<b>Dimensions with battery pack</b>	210(W) × 151(D) × 28(H) mm (8.3"(W) × 5.9"(D) × 1.1"(H)) (excluding projections)		
<b>Approximate weight with battery pack</b>	1020g (2.24lbs)	1005g (2.21lbs)	
<b>Operating Environment</b>	Temperature: 5°C to 35°C (41°F to 95°F); Humidity: 30 to 90% (non-condensation)		
<b>Standard Pre-installed Software</b>	Microsoft® Windows® 98 Second Edition	None	
<b>Applications</b>	Mobile Cockpit, Quick Beam Suite	None	

\*1 Resolution indicates the number of vertical and horizontal dots. Larger numbers indicate higher resolution, clearer images, and a larger display area.

Though the FIVA TFT LCD is a very high quality display device, there may be times that brightness is uneven and when fine specs appear on the screen. Also, some dots may not illuminate or some dots may stay illuminated at all times. All of this common for liquid crystal displays, and does not indicate malfunction.

## Options List

---

The useful options shown below are available for use with the FIVA MPC-501 Series.

**Memory Expansion DIMM Board**  
(Product No. MPC-151RAM) 32MB  
MPC-152RAM) 64MB

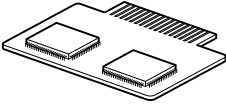

**Port Replicator**  
(Product No. MPC-160PR)

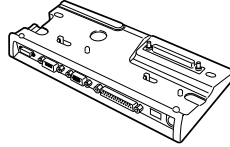

**Floppy Disk Drive**  
(Product No. MPC-140FDDE)

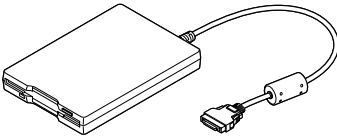

**CD-ROM Drive**  
(Product No. MPC-142CDDE)

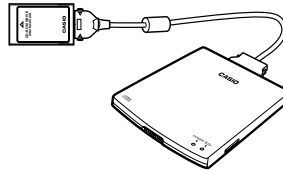

**Large-capacity Battery Pack**  
(Product No. MPC-174LBAT)

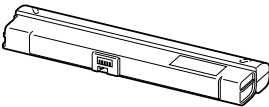

**Battery Pack**  
(Product No. MPC-173BAT)

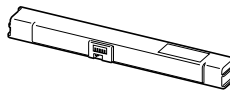

**AC Adaptor**  
(Product No. MPC-577ADPE)

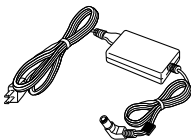

**Battery Pack Charger**  
(Product No. MPC-570CHG)

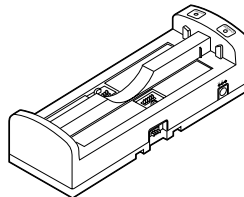

## **FIVA User's Guide**

(MPC-501 series)

1st. ed. 2001-09

### **CASIO COMPUTER CO., LTD.**

6-2, Hon-machi 1-chome  
Shibuya-ku, Tokyo 151-8543, Japan

#### **Notes**

- This guide cannot be reproduced or duplicated in any form, in part or in whole, without written permission from CASIO COMPUTER CO., LTD.
- The content of this guide is subject to change without notice.
- CASIO has, to the best of its ability, endeavored to make this guide as accurate as possible. However, if any unclear portions or omissions are found, please contact your dealer.

Descriptions and specifications furnished herein the User's Guide by CASIO Computer Co., Ltd. are believed to be accurate and reliable. However, CASIO reserves the right to make changes or improvements in the descriptions and specifications without any advanced notice. CASIO does not assume any liability arising from the use of the contents, nor for any infringements of patents or other rights of third parties which may result from the use of the contents.

© 2001 CASIO COMPUTER CO., LTD. All rights reserved.

**CASIO**<sup>®</sup>  
MPF0101098-01



CASSIOPEIA™  
71V2

**CASIO COMPUTER CO., LTD.**

6-2, Hon-machi 1-chome  
Shibuya-ku, Tokyo 151-8543, Japan



This document is printed using  
environmentally friendly soy ink.

Printed on recycled paper.

Printed in Japan

## Free Manuals Download Website

<http://myh66.com>

<http://usermanuals.us>

<http://www.somanuals.com>

<http://www.4manuals.cc>

<http://www.manual-lib.com>

<http://www.404manual.com>

<http://www.luxmanual.com>

<http://aubethermostatmanual.com>

Golf course search by state

<http://golfingnear.com>

Email search by domain

<http://emailbydomain.com>

Auto manuals search

<http://auto.somanuals.com>

TV manuals search

<http://tv.somanuals.com>