

KL-750E

User's Guide



Introduction

Congratulations on your selection of the CASIO KL-750E Label Printer. This CASIO Label Printer makes it possible for you to print adhesive labels for a wide variety of applications, such as: name tags, cassette tape labels, floppy disks, binders, and other applications.

You can produce attractive, original labels thanks to such features as:

- Variable tape sizes (6mm, 9mm, 12mm, 18mm)
- Attractive sans-serif font
- Font effects (shading, underline, box)
- Built-in symbols
- Text memory

You can even use tapes with optionally available holders to create your own stamps.

All of this makes the CASIO label Printer the perfect tool for just about all of your labeling needs!

Important!

- Contact a nearby dealer whenever you require servicing.
- Note that the manufacturer shall not be held liable for any loss or claims by third parties which may arise out of the use of this product.
- Note that the manufacturer shall not be held liable for any damages incurred as a result of data loss caused by malfunctions, repairs, or interruption of power supply.
- It is up to the user to keep backup records of important data.
- Keep this manual on hand for future reference.

Contents

Part 1 Getting Acquainted	2
Important Precautions	2
General Guide	3
Label Printer Menus	4
Part 2 Getting Ready	4
Power Supply	4
Replacing Batteries	4
To replace the batteries	5
AC Adaptor	5
To connect the AC adaptor	5
Turning Power On and Off	5
Resetting the Memory	5
To reset the memory	5
Auto Power Off Function	5
Tape Cartridges	5
To load a tape cartridge	6
Tape Width Specification	6
To specify 6mm tape width	6
Part 3 Inputting Characters and Symbols	7
Display Symbols and Indicators	7
Basic Alpha-Numeric Input	8
To input alpha-numeric characters	8
About the CODE key... ..	8
Special Symbols	8
To input special symbols	8
Part 4 Deleting and Inserting Characters	9
Moving the Cursor	9
To move the cursor	9
Deleting Individual Characters	9
To delete characters using the BS key	9
To delete characters using the DEL key	9
Clearing the Display	9
To clear the display	9
Text Editing	9
To insert new characters	9
To change existing characters to different ones	10

Part 5 Character Size and Text Effects	10
Character Size	10
To change the character size	10
Text Effects	11
To specify a text effect	11
Part 6 Printing	11
Printing a Tape	11
To print a tape	11
Stamp Printing	12
To print a stamp tape	12
Mirror Image Printing	12
To turn mirror image printing on and off	12
Other Printing Features and Operations	12
Auto Feed	13
To turn auto feed on and off	13
To manually feed tape	13
Print Density	13
To adjust the print density	13
Part 7 Memory	13
To store data	13
To recall text from memory	13
To delete text from memory	14
Part 8 Reference	14
Replacing the Tape Cutter Blade	14
To replace the tape cutter blade	14
Cleaning the Printer Head and Roller	15
To clean the printer head and roller	15
Initial Power On Settings	15
Initializing the Label Printer	15
To initialize the Label Printer	16
Troubleshooting	16
Specifications	17

Part 1 Getting Acquainted

This part of the manual provides you with important information you need to know in order to use the Label Printer to its full potential. Be sure to read it carefully before using the Label Printer for the first time.

Important Precautions

- Keep your Label Printer out of areas subject to temperature extremes, moisture and direct sunlight. The recommended temperature range is 10° to 35°C (50° to 95°F).
- Don't let coffee, juice or other liquids splash onto the Label Printer.
- Never let paper clips, pins or other foreign objects get into the tape outlet slot or printer of the Label Printer.
- Do not pile heavy objects on top of the Label Printer.
- Never try to take the Label Printer apart or attempt your own maintenance.
- Do not drop your Label Printer and avoid strong impact.
- Do not pull on the tape or try to force it back into the Label Printer.
- The yellow cutter cartridge inside the Label Printer contains a sharp blade for cutting the printed tape. Keep your fingers away from this cartridge and be especially careful to keep the cartridge away from small children.
- Do not operate the cutter lever without a tape cartridge loaded in the Label Printer. Doing so can damage the cutter blade.
- Do not apply excessive force to the tape cutter lever. Doing so can damage the Label Printer.
- Do not use benzene, thinner, or other volatile chemicals to clean the exterior of the Label Printer. Use a soft, dry cloth or a cloth dampened in a weak solution of a mild, neutral detergent and water. Wring the cloth out until all excess moisture is removed.
- A dirty printer head can cause printing to become smudged. When this happens, clean off the printer head by wiping it with a cotton swab moistened with alcohol (page 15).
- Use of the Label Printer next to a television or radio may interfere with reception.

General Guide

Front

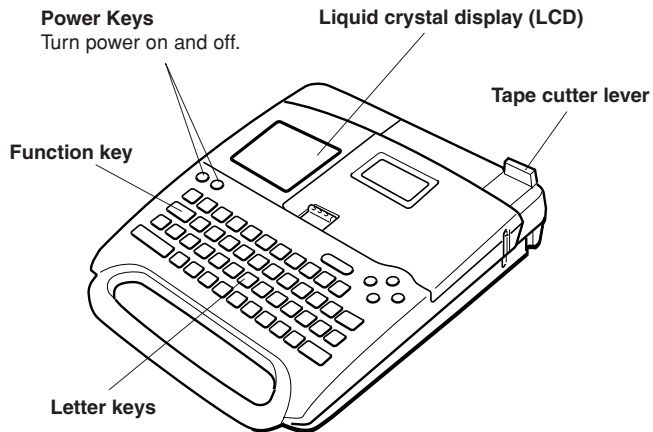

Back/Left Side

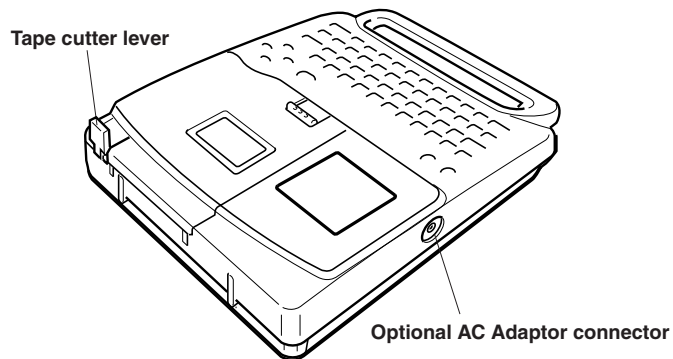

Battery compartment cover

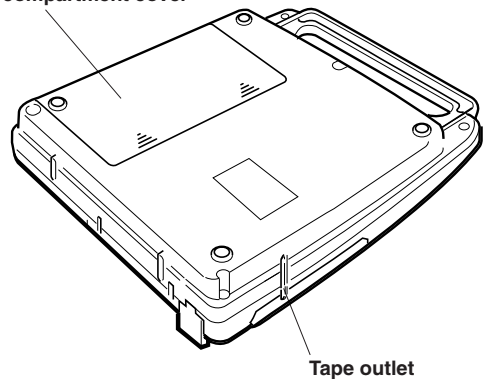

Tape Cutter Operation Precaution

Note the following important precautions when operating the tape cutter lever.

1. When operating the tape cutter lever, make sure you do not press it too hard.
2. Always return the tape cutter lever by hand back to its original position after the tape is cut.

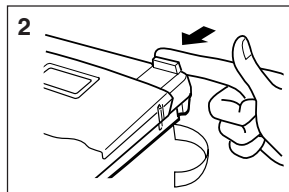
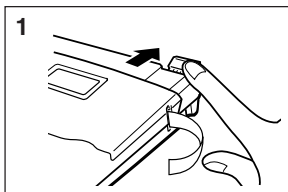

Label Printer Menus

Label Printer operation is designed to be as simple as possible, thanks to on-screen menus that you can use to select the settings you need. Each menu is described in detail in the sections that follow in this manual, but note the following general points when using them.

- The item that is underlined in a menu is the one that is currently selected.

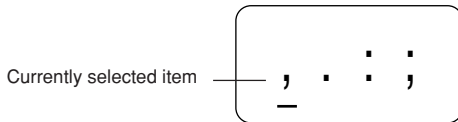

- Use ◀, ▶, ▲ and ▼ to move the underlining left, right, up and down and change the selected item.
- Press **SET** to execute the underlined item, or **ESC** to exit the displayed menu (and return to the previous menu or screen) without selecting anything.
- When you press **SET** to execute a menu item, the Label Printer either moves on to the next menu, or it executes the selected function and returns to the text input screen that you started from.

Part 2 Getting Ready

This part of the manual tells you how to load batteries and the tape cartridge, and how to perform other basic setups for the Label Printer.

Important!

- Be sure to read this section before attempting to use the Label Printer.

Power Supply

The Label Printer can be powered by eight AA-size batteries or an optional AC adaptor (AD-A95100).

Replacing Batteries

A handy low battery power indicator lets you know when battery power is getting too low for proper operation. The message "BATT" appears on the display if battery power is low when you perform any of the following operations.

- Turn power on
- Execute a print operation

Whenever the "BATT" message appears, press **SET** to clear it from the display. You should still be able to perform some Label Printer operations, but some power intensive operations (like printing) may become impossible if battery power is too low. In any case, you should replace batteries as soon as possible or switch to the AC adaptor as soon as possible after the "BATT" message appears.

Important!

- All data stored in memory is deleted whenever batteries go dead and when you replace batteries. Be sure to keep written backup copies of all important data (text and documents).
- Batteries can burst or leak and damage your unit if you do not use them correctly. Note the following important points.
 - Be sure that the plus (+) and minus (–) sides of each battery are facing correctly.
 - Never mix batteries of different types
 - Never leave dead batteries in the Label Printer.
 - Remove the batteries if you do not plan to use the Label Printer for a long time.
 - Replace the batteries at least once every 2 years.

Warning!

- Never use recharged batteries with the unit.
- Do not expose batteries to direct heat, do not short circuit them, and do not try to take them apart.
- **Keep batteries out of the reach of small children. If swallowed, consult with a physician immediately.**
- Be sure to replace the batteries in accordance with the battery life printed on the side of the battery itself.

To replace the batteries

1. Turn power off.
 - If you are using the optional AC adaptor for power, you should also unplug it from the Label Printer.
2. Open the battery compartment cover on the back of the Label Printer by sliding it in the direction indicated by the arrow.
3. Remove all eight of the old batteries.
4. Load a set of eight new batteries into the battery compartment, making sure that their positive (+) and negative (-) ends are facing in the correct directions.
5. Replace the battery compartment cover.

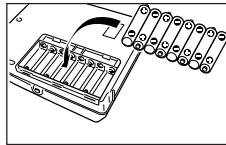
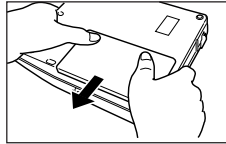

AC Adaptor

Note the following important precautions when using an AC adaptor to power your Label Printer.

- Use only a genuine CASIO AD-A95100 AC adaptor with the same voltage rating as the household current in your area. Using a wrong adaptor can damage your Label Printer.
- Be sure to turn the Label Printer off before you connect the adaptor. Do not turn power on until the adaptor is connected to the Label Printer and plugged into an AC outlet.
- Be sure to unplug the AC adaptor from the AC outlet whenever you are not using the Label Printer.

To connect the AC adaptor

Connect the adaptor to the Label Printer as illustrated nearby. Plug the other end into a standard household AC outlet.

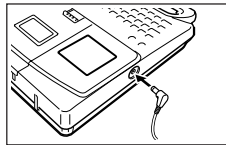

Turning Power On and Off

Press **ON** to turn power on, and **OFF** to turn power off.

Important!

- If you are using the Label Printer for the first time, you should reset it first.

Resetting the Memory

You should reset the memory of the Label Printer before using it for the first time, after you have not used it for a long time, or if nothing happens when you turn power on, even after you change the batteries.

Important!

- Resetting Label Printer memory clears its memory of all input data.

To reset the memory

1. Make sure that Label Printer power is off.
2. While holding down the **PRINT** and **ESC** keys, press **ON** to turn power on.
3. Keeping **PRINT** and **ESC** held down, release the **ON** key only.
4. Press **SET** to initialize the Label Printer or **ESC** to abort the reset operation without initializing anything.
 - See "Initializing the Label Printer" on page 15 for information on the initial default settings of the Label Printer following the reset operation.

INT?

Auto Power Off Function

If you do not perform any key operation for about six minutes, the Label Printer automatically turns power off. To restore power, press **ON**.

Tape Cartridges

Use the procedures described below to load a tape cartridge into the Label Printer. After you load the tape cartridge, be sure to use the procedure described under "Tape Width Specifications" on page 6 to tell the Label Printer what is the width of the tape you are using.

Important!

- Never try to push the tape back into the cassette. Once tape is out of the cassette, there is no way to wind it back in. Trying to do so can cause operational problems with the Label Printer.

To load a tape cartridge

1. Make sure that the Label Printer is turned off.
2. Open the tape cartridge compartment cover.
 - If there is a cartridge already in the Label Printer, remove it by grasping the cartridge on both sides with your thumb and forefinger, and lift straight up.

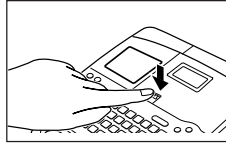

3. Remove the stopper from a new tape cartridge and check to see that the tape is ready to use.

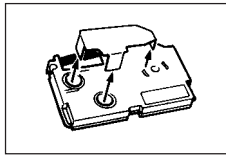

- Make sure that the tape is under the tape guide and that it is not bent or twisted.



- Make sure that the tape does not extend too far past the tape guide. If it does, cut off the end with a pair of scissors.

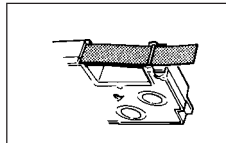

4. Use a pencil or some other thin object to take up slack in the ink ribbon as shown in the illustration. Note that the tape does not move at this time.

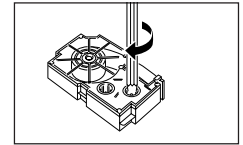

- If the ink ribbon is slack when you load it into the Label Printer, it can break or cause some other problem.
- Be sure to turn the ink ribbon take up spool only in the direction indicated by the arrow (a).
- Turn the spool until the other spool (b) starts turning in the direction noted by the arrow. This indicates there is no slack in the ribbon.

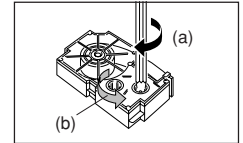

5. Load the tape cartridge into the Label Printer, making sure that the tape and ink ribbon pass between the head and roller.
6. Close the tape cartridge compartment cover.

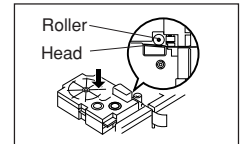

7. Turn on Label Printer power and press **FUNCTION** and then **PRINT** (FEED) two or three times to make sure that the tape comes out without any problem.
- If the tape does not come out normally, turn off power and start again from step 1 above.

Tape Width Specification

Important!

- When using 6mm tape, using certain character sizes can cause characters to run off the top or bottom of the tape. Be sure to use the following procedure to tell the Label Printer when you are using 6mm tape.

To specify 6mm tape width

1. Turn power on.
 2. Press **FUNCTION** and then **9** (6mm).
 3. Press **◀ ▶ ▲ ▼** to change the setting shown on the display between **ON** (6mm tape) and **OFF** (other tape width).
 4. When the tape width setting is the way you want it, press **SET** to register it.
- The tape width you set remains in effect until you change it, press **ON** or reset the Label Printer's memory.

Part 3 Inputting Characters and Symbols

This part of the manual tells you how to input characters. To make things easier to understand, we call everything you input a character, regardless of whether it is actually a letter, number, or symbol. Explanations here all use the default settings that are in effect from the initial power-on screen. For information on using other character styles, effects and sizes, see page 10.

Important!

- You can input up to 63 characters per label. Further input becomes impossible after you input the 63rd character.

Display Symbols and Indicators

Before getting into actual input, you should first become acquainted with the symbols and indicators used on the Label Printer display.

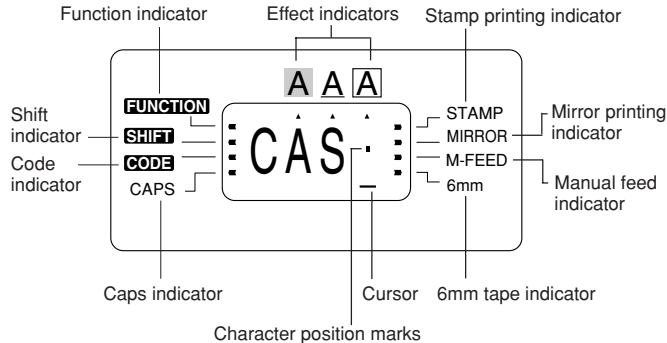

• Function indicator

This indicator appears when you press the **FUNCTION** key. Pressing a key while this indicator is on the display causes the function marked above that key to be executed.

• Shift indicator

This indicator appears when you press the **SHIFT** key. While this indicator is on the display, the keyboard is shifted, so the letter keys input upper-case alpha characters. The number keys input the punctuation symbols marked in the upper right corners of the keys.

If both the caps mode indicator and the shift indicator are shown on the display, the keyboard is shifted to lower-case input.

The keyboard automatically unshifts (and the shift indicator disappears) as soon as you input a character.

• Code indicator

This indicator appears when you press the **CODE** key. While this indicator is on the display, number keys **1** through **0** input the accents marked above them and the **U, O, P, A, S, J, K, L, Z, C** and **N** keys input the special characters marked in their lower right corners.

The keyboard automatically returns to normal (and the code indicator disappears) as soon as you input an accent.

• Caps indicator

This indicator appears when the Label Printer is in the caps (upper-case) mode. All letters you input in the caps mode are upper-case. When the caps mode indicator is not shown on the display, all letters are input as lower-case.

Note that the Label Printer stays in the caps mode until you press the **CAPS** key again.

If both the caps mode indicator and the shift indicator are shown on the display, the keyboard is shifted to lower-case input.

• Effect indicators

These indicators point to the character effect that is currently in use. You can select between shading, underline, and box.

• Stamp printing indicator

This indicator appears when the Label Printer is set up for stamp printing. Labels you create with stamp printing can be attached to an optionally available stamp holder and then used as a pre-inked stamp.

• Mirror image printing indicator

This indicator appears when the Label Printer is set up for mirror image printing. Normal (non mirror image) printing is performed when this indicator is not shown.

• Manual feed indicator

This indicator appears when you are using manual feed instead of auto feed. Auto feed is in effect when this indicator is not on the display.

Important!

• After you finish printing when using manual feed, be sure to always press **FUNCTION** and then **PRINT** (FEED) to feed the tape before cutting it. If you don't you will cut off part of the printed text.

• 6mm tape indicator

This indicator appears when you use the procedure on page 6 to specify you are using 6mm tape. No indicator is shown when you are using other (9mm, 12mm, 18mm) tape.

• Cursor

The cursor shows the next input position. Any character you input appears at the point where the cursor is located.

• Character position marks

These marks show where characters will appear as you input them. This part of the display is always blank when you turn power on.

Basic Alpha-Numeric Input

The following operation shows you the basic procedures for inputting letters and numbers. We will explain the procedure by inputting the following characters using the default initial power-on screen.

ABXYZ Computer Company
1234567890

Note

• If you hold down any key, it will repeat its operation or input at high speed until you release it.

To input alpha-numeric characters

1. Turn power on.
2. Input the first line of characters.
 - To input the upper-case letters, you can use either **SHIFT** or **CAPS**. With **SHIFT** you must shift the keyboard for each character. With **CAPS** the keyboard stays in upper-case until you press **CAPS** again.
 - Press **SPACE** to input spaces.

• If you input a wrong character, press **BS** to delete it and input again. See page 9 for other details on editing text.

3. When you reach the end of a line of text, press **↵** (the **▼** cursor key) to input a newline mark.

• A newline operation is indicated on the display by the **↵** symbol. This shows where you changed lines.

4. Input the characters in the second line.

5. To print the text that you input, press **PRINT**. For details on printing, see page 11.

About the CODE key...

The **CODE** key makes it possible to input punctuation needed for a number of different languages. The following shows the key operations you should use for each of the characters formed using the **CODE** key.

Key Operation	Input	Key Operation	Input	Key Operation	Input
CODE U	Ü	CODE L	Ø	CODE 4	~
CODE O	Œ	CODE Z	Ž	CODE 5	^
CODE P	À	CODE C	Ç	CODE 6	∨
CODE A	Æ	CODE N	Ñ	CODE 7	°
CODE S*	ß	CODE 1	˘	CODE 8	/
CODE J	Ö	CODE 2	˙	CODE 9	“
CODE K	Ä	CODE 3	˚	CODE 0	˘

* Lower case only.

Example: To input á.
CODE 1 A

Special Symbols

You can also access a menu of special symbols by pressing **FUNCTION 4** (SYMBOL).

To input special symbols

Example: To input the special symbol #.

1. With the cursor at the location where you want to input a special symbol, press **FUNCTION 4** (SYMBOL).

• The symbol that is underlined on the display is the one that is currently selected.

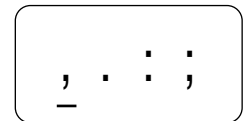

- Use the ◀▶ ▲ and ▼ cursor keys to move the underlining to the symbol you want.
 - Not all of the available symbols fit on the display. The menu will scroll when you press the cursor keys.
 - In this example, underline #.
- After you underline the symbol you want, press **SET**.
 - This returns to the input screen, with the symbol you selected input at the location where the cursor was located when you displayed the symbol list.



Part 4 Deleting and Inserting Characters

This section describes everything you need to know about deleting and editing characters you have already input.

Moving the Cursor

Use the cursor keys to move the cursor around the display and position it for deleting and editing characters.

To move the cursor

- Press ◀ to move the cursor to the left, and ▶ to move the cursor to the right.
- Press **FUNCTION** and then ◀ to make the cursor jump to the beginning (far left) of the characters on the display.
- Press **FUNCTION** and then ▶ to make the cursor jump to the end (far right) of the characters on the display.
- Holding down the ◀ or ▶ cursor key moves the cursor at high speed.

Deleting Individual Characters

You can delete individual characters with either the **BS** key or the **DEL** key (which is the ▲ cursor key). The only difference between the operation of these two keys is the location of the cursor.

To delete characters using the BS key

Example: To change the word “commmputer” to “computer”.

- Use ◀ and ▶ to move the cursor under “p”.



- Press **BS** twice to delete the two m's to the left of the cursor, shifting “puter” to the left as you do.
- Press **FUNCTION** and then ▶ to jump back to the end of the characters for more input.

To delete characters using the DEL key

Example: To change the word “commmputer” to “computer”.

- Use ◀ and ▶ to move the cursor under the first (far left) “m”.
- Press **DEL** twice to delete the two m's at the cursor's position, shifting “mputer” to the left as you do.
- Press **FUNCTION** and then ▶ to jump back to the end of the characters for more input.

Clearing the Display

Use the following procedure to clear all input text from the display.

To clear the display

Press **FUNCTION** and then **BS** (CLS).

At this time the message CLS? appears on the display to confirm that you want to clear the display. Press **SET** to clear or **ESC** to abort the operation without clearing anything.

Text Editing

You can use the following procedures to edit text on the display.

To insert new characters

Example: To change the text “ABCDEF” to “ABCXYZDEF”.

- With the original text on the display, move the cursor under the letter “D”.

2. Input the new characters (XYZ).

- Inputting the new characters causes them to be inserted at the cursor position. The existing characters are opened up to make room for the new characters.

To change existing characters to different ones

Example: To change the text "ABCDEF" to "XYZDEF".

1. With the original text on the display, use either the **BS** key or **DEL** key to delete the characters to be changed (ABC).
 - Remember to use the correct cursor location for the key you plan to use to delete the characters. See page 9 for details.
2. Input the new characters (XYZ).

Part 5 Character Size and Text Effects

This part of the manual explains how to change the size of characters. It also tells you how to assign text effects like underlining, shading, and box printing.

Character Size

The following table shows the six character sizes that are available.

Character Size Indicator	Actual Size (mm)
1×1	3×3
1×2	3×6
1×3	3×9
2×1	6×3
2×2	6×6
2×3	6×9

Character size changes are applied to printed text only. The size of the displayed text does not change.

Important!

- Any character size specification you make is applied to all the characters on the display. You cannot make multiple specifications for specific characters.
- The Label Printer automatically adjusts the character size whenever you input a ↵ symbol to create a 2-line label as shown below.

Initial Size	Size After ↵ Operation
2×1	1×1
2×2	1×2
2×3	1×3

Note that you cannot input a ↵ symbol if you are using 6mm wide tape.

To change the character size

Example: To input "ABXYZ" as 2×2 characters.

1. Input the text.
2. Press **FUNCTION 2 (SIZE)** to display the current character size setting.

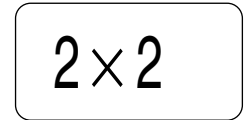

3. Use ▲ and ▼ to change the displayed size in the following sequence.

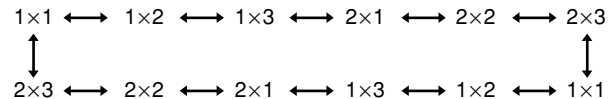

4. When the character size you want to specify is on the display, press **SET** to select it and return to the text display.



Note

- You could also perform the above procedure in reverse, specifying the character size first and then inputting the text.

Text Effects

There are three text effects that you can assign: shading, underlining, and boxed text. The following shows examples of each.

Shading: **ABC. XYZ**

Underlining: ABC. XYZ

Boxed Text: **ABC. XYZ**

Text effect changes are applied to printed text only. The appearance of the displayed text does not change, but the text effect indicators will show you when a text effect is being used.

Important!

- Any text effect specification you make is applied to all the characters on the display. You cannot make multiple specifications for specific characters.

To specify a text effect

Example: To shade the text "ABXYZ".

1. Input the text.
2. Press **FUNCTION 3** (EFFECT) to display a menu of text effects.

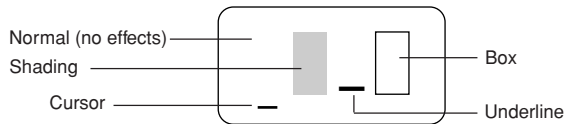

3. Use ◀ and ▶ to move the cursor to the effect you want to use.
4. When the cursor is located under the effect you want to specify, press **SET** to select it and return to the text display.

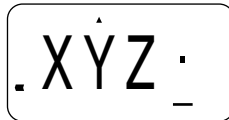

Note

- You could also perform the above procedure in reverse, specifying the text effect first and then inputting the text.

Part 6 Printing

This part of the manual includes all the information you need to print tapes. It also tells you how to print special stamp tapes that you can attach to an optional stamp holder to create your own original stamps.

Printing Precautions

- Never turn power off while printing is being performed.
- Make sure that the tape outlet is not blocked before you start printing.
- Never operate the tape cutter while printer is being performed (indicated by the message "PRNT" on the display).
- During printing at very high density, printing of very long text, or repeat printing of the same text a number of times, the Label Printer may stop printing for about five seconds. This is not a malfunction, and normal printing should resume shortly (indicated by the message "P B N I" on the display).

Printing a Tape

Printing a tape is as easy as pressing the **PRINT** key.

To print a tape

1. Press the **PRINT** key to print a tape of the text you have input and laid out.
 - To stop a print operation that is in progress, press **ESC**.
2. After the print operation is complete, press down on the tape cutter lever to cut the tape.
3. Use scissors to trim the tape to the size you want, if necessary.

- After you print a tape, you can peel off its paper backing and stick the tape onto the object you want. Note that the tape will not stick on coarse, wet, oily, or soiled surfaces. Also, you should not try to use the tape where it is exposed to direct sunlight or rain. Do not stick the tape onto human skin.

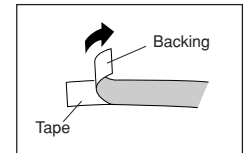

- An easy way to remove the backing from a tape and expose the adhesive surface is to bend the tape near one of its ends. This should cause the tape and its backing to separate, allowing you to pull them apart.

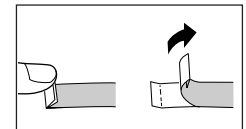

Stamp Printing

The stamp printing feature lets you print on special stamp tape. You can then attach the finished stamp tape to an optionally available stamp holder to create your own original pre-inked stamps. The following is the type of stamp holder currently available for use with stamp tapes.

Type	Maximum Stamp Size	Example
ST-15	5.5cm	

Note the following important points about stamp printing.

- Stamp printing prints text in mirror image.
- Stamp printing is impossible while 6mm is specified as the tape width.
- An error message (ERR!) appears on the display and the Label Printer refuses to print whenever you try to print text that is longer than the maximum length you specify.

To print a stamp tape

1. Input the text you want to print.
2. Press **FUNCTION** and then **5** (STAMP).

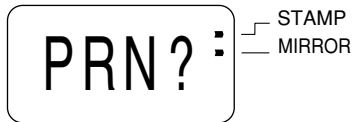

- A mark appears next to the STAMP indicator on the display when mirror printing is turned on.
 - If the text you input in step 1 is too long to fit within the maximum length you specified, an error message (page 16) appears when you press **SET**.
3. Press **SET** to print the stamp tape or **ESC** to abort the print operation and return to the text input display in step 1.
 - After the printing is complete, the Label Printer returns to the input display in step 1.
 4. Cut off the tape and affix it to the optional stamp holder.
 - See the instructions that come with the optional stamp holder for information about how to attach the stamp tape.

Mirror Image Printing

When you specify mirror image for text, it is printed in reverse image. Use mirror image when you plan to print on transparent tape, with the printing on the inside. When viewed through the transparent tape, the text will appear normal. You can also use mirror image printing when using iron-on transfer tape to print iron-on transfers.

Normal **ABC. XYZ**

Mirror Image **YX .CBA**

To turn mirror image printing on and off

1. Press **FUNCTION** and then **6** (MIRROR).



2. Press **◀ ▶ ▲ ▼** to change the setting shown on the display between ON (mirror printing) and OFF (normal).
3. When the mirror image printing setting is the way you want it, press **SET** to register it.
 - A mark appears next to the MIRROR indicator on the display when mirror printing is turned on.
 - After you turn printing on, input text and perform the print operation as you normally do (page 11) to produce mirror image tapes.

Other Printing Features and Operations

The following are other operations and settings that you may need to use when printing.

Auto Feed

You can turn the Label Printer's auto feed feature on and off. When auto feed is on, the Label Printer automatically feeds the tape about 12mm at the beginning and end of each print operation. This creates identical margins on both sides of your text.

Important!

- After you finish printing when using manual feed, be sure to always press **FUNCTION** and then **PRINT** (FEED) to feed the tape before cutting it. If you don't you will cut off part of the printed text.

To turn auto feed on and off

1. Press **FUNCTION** and then **7** (M-FEED).

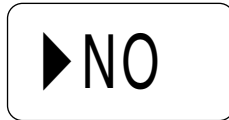

2. Press ◀ ▶ ▲ or ▼ to change the setting shown on the display between YES (manual feed) and NO (auto feed).
3. When the feed setting is the way you want it, press **SET** to register it.

To manually feed tape

Press **FUNCTION** and then **PRINT** (FEED) to feed the tape 13mm.

Print Density

The print density setting controls how darkly figures are printed on your tapes.

To adjust the print density

1. Press **FUNCTION** and then **8** (DENSITY).

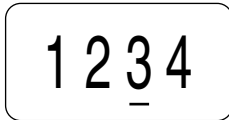

2. Use ◀ and ▶ to move the underlining to the density setting that you want.
 - The lightest setting is 1, while the darkest setting is 5. The standard setting is 3.
 - Only four of the five settings that are available can appear on the display. The display scrolls left and right when necessary to show all of the available settings.
3. When the density setting is the way you want it, press **SET** to register it.

Part 7 Memory

This part of the manual tells you how to store text data in memory for instant recall when you need it. You can store two blocks of text in memory, each containing up of 63 characters, for a total of 126 characters.

Important!

- All data stored in memory is deleted whenever batteries go dead and when you replace batteries. Be sure to keep written backup copies of all important data (text and documents).
- When using the optional AC adaptor, never disconnect the adaptor while batteries are not loaded in the Label Printer or when batteries are dead. Doing so causes all data stored in memory to be deleted.

To store data

1. Input the text you want to store.
2. Press **FUNCTION** and then **1** (MEMO).



3. Press **SET** to store the text in memory or **ESC** to abort the store procedure without storing anything.

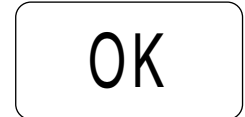

- If there is nothing in memory yet, your text is automatically stored in Area 1. If Area 1 already contains data, your new input is automatically stored in Area 2.
- If there is not enough room for your text to fit in memory, the message "FUL!" appears when you press **SET** in step 3.



To recall text from memory

Example: To recall the contents of Area 2 while memory contains the following text.

Area 1: ABCDEFG
Area 2: CASIO

1. While the input screen is on the display, press **FUNCTION** and then 1 (MEMO).

- Note that text recalled from memory will replace any text currently on the display.



2. Press ▼ to change to the text recall prompt.



3. Press **SET**.

- If all of the text does not fit on the display, you can use ◀ and ▶ to scroll it to the left and right.



Area 1 text

4. Press ▼ to change to Area 2.

- Use ▲ and ▼ to switch between Area 1 and Area 2.



Area 2 text

5. Press **SET** to recall the text from the area that is currently on the display.

- Note that recalling data from memory replaces anything that is currently on the input display. Memory text cannot be appended.



To delete text from memory

1. While the input screen is on the display, press **FUNCTION** and then 1 (MEMO).



2. Press ▼ twice to change to the text delete prompt.



3. Press **SET**.

- If all of the text does not fit on the display, you can use ◀ and ▶ to scroll it to the left and right.



Area 1 text

4. Use ▲ and ▼ to select Area 1 or Area 2 then press **SET**.

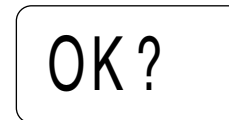

5. Press **SET** to delete the text from the area that is currently on the display.

Part 8 Reference

This section contains information about the Label Printer that you can use as reference when you need it.

Replacing the Tape Cutter Blade

The tape cutter blade is designed to provide approximately 3,000 cuts. Use the following procedure to replace the blade whenever it starts to cut poorly.

To replace the tape cutter blade

1. Make sure that the Label Printer is switched off.
2. Open the tape cartridge compartment cover.

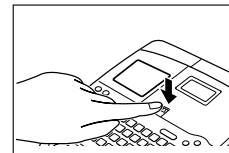

- If there is a cartridge already in the Label Printer, remove it by grasping the cartridge on both sides with your thumb and forefinger, and lift straight up.

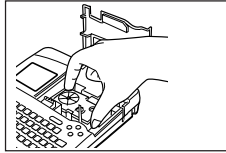

3. Use a thin, pointed object to lift the yellow cutter cartridge out of the Label Printer as shown in the illustration.

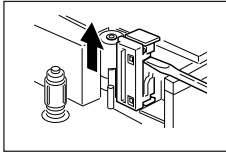

- The tape cutter blade comes out of the cutter cartridge if you press on the front of the cartridge. Be sure to take care to avoid cutting your fingers on the blade.

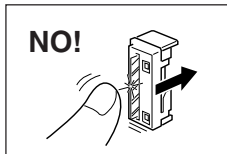

4. Install a new cutter cartridge by sliding it along the groove provided in the Label Printer.
- Contact your CASIO dealer to purchase a replacement cutter cartridge.
5. Replace the compartment cover.

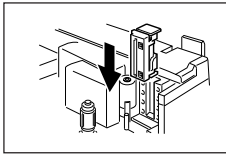

Cleaning the Printer Head and Roller

A dirty printer head and roller can result in poor printing quality. If you have problems with print quality, use the following procedure to clean the printer head and roller.

To clean the printer head and roller

1. Make sure the Label Printer is turned off.
2. Press the tape cartridge compartment cover release and open the compartment cover.
3. Remove the tape cartridge.

4. Use a cotton swab dipped in alcohol to clean the printer head and roller as shown in the illustration.

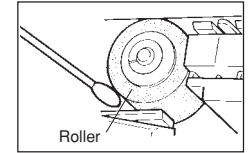
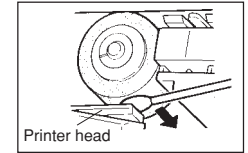

5. Replace the tape cartridge and close the compartment cover.

Initial Power On Settings

The following are the initial settings of the Label Printer whenever you turn it power on.

Item	Power On
SIZE	2×2
EFFECT	CANCEL
MIRROR	OFF
M-FEED	NO
6mm	OFF

Initializing the Label Printer

If you experience serious malfunction of the Label Printer or if operation fails completely, try performing the following operation to initialize the printer.

Important!

- Initializing the Label Printer deletes all memory contents. Make sure you have a back-up copy of text stored in memory if you need it.

To initialize the Label Printer

1. Turn power off.
2. While holding down the **PRINT** and **ESC** keys, press **ON** to turn power on.
3. Keeping **PRINT** and **ESC** held down, release the **ON** key only.
 - This prompt confirms whether or not you want to initialize the Label Printer.
4. Press **SET** to initialize the Label Printer or **ESC** to abort the reset operation.
 - The following table shows the initial settings.



Item	Reset
Display	Cleared
Memory	Cleared
EFFECT	CANCEL
M-FEED	NO
MIRROR	OFF
DENSITY	3
WIDTH	OFF

Troubleshooting

Problem	Possible Cause	Action
<p>ERR! message on the display.</p> <p>* This message appears on the screen for about one second.</p>	<ul style="list-style-type: none"> • Attempt to input two ↵ marks within the same text. • Attempt to input ↵ mark while 6mm is specified as the tape width. • Label text containing a ↵ mark was input and then tape width specification was changed to 6mm. (ERR! message appears when you try to perform a print operation.) • Text that is longer than 5.5cm when stamp printing is selected. • Attempt to print a stamp while 6mm is specified for the tape width. 	<ul style="list-style-type: none"> • Use only one ↵ mark. Only two lines of text can be input, so text can contain only one ↵ mark. • Do not use ↵ marks. 6mm tape can have only one line of text, so text cannot contain any ↵ marks. • Delete the ↵ mark to print on 6mm tape or switch back to a wider tape. • Shorten the text to be printed and try again. • Change the tape width setting to OFF and try printing the stamp again.
<p>FUL! message on the display.</p> <p>* This message appears on the screen for about one second.</p>	<ul style="list-style-type: none"> • Both text memory areas (AREA 1 and AREA 2) already contain text. 	<ul style="list-style-type: none"> • Delete text from one of the text memory areas and then store the new text.
<p>BATT message on the display.</p>	<ul style="list-style-type: none"> • Battery power is too low. 	<ul style="list-style-type: none"> • Replace batteries.
<p>ERR! message on the display.</p>	<ul style="list-style-type: none"> • Memory data has become corrupted for some reason. 	<ul style="list-style-type: none"> • Initialize the Label Printer.

Specifications

Model: KL-750E

Input

Keyboard Layout: Typewriter (QWERTY)

Character Types

Alpha (English and other languages): 151

Numbers: 10

Symbols: 41

Display

Type: Liquid crystal display

Columns: 4

Character matrix: 5×7-dot

Printing

Type: Thermal transfer

Speed: Approximately 6.67mm/second

Width: 4mm (6mm tape) or 8mm (other tape)

Character Matrix: 24×24-dot

Character font: Sans-serif

Character effects: Shade, underline, box

Character sizes: 1×1, 1×2, 1×3, 2×1, 2×2, 2×3

Number of lines: 1 (6mm tape); 1 or 2 (other tapes)

Memory

Text: Up to approximately 126 characters (total storage for AREA 1 and AREA 2)

General

Power supply: Eight AA-size batteries or optional AD-A95100 AC adaptor

Battery life: Approximately 1 tape cartridge (continuous printing)

Power consumption: 9W

Auto Power Off: Approximately six minutes after last key operation.

Dimensions: 44.6 (H) × 174 (W) × 212 (D)mm (1 3/4"H × 6 7/8"W × 8 3/8"D)

Weight: 452g (1lb)

Ambient Temperature: 10°C~35°C (50°F~95°F)

CASIO®

CASIO COMPUTER CO., LTD.

6-2, Hon-machi 1-chome
Shibuya-ku, Tokyo 151-8543, Japan

Free Manuals Download Website

<http://myh66.com>

<http://usermanuals.us>

<http://www.somanuals.com>

<http://www.4manuals.cc>

<http://www.manual-lib.com>

<http://www.404manual.com>

<http://www.luxmanual.com>

<http://aubethermostatmanual.com>

Golf course search by state

<http://golfingnear.com>

Email search by domain

<http://emailbydomain.com>

Auto manuals search

<http://auto.somanuals.com>

TV manuals search

<http://tv.somanuals.com>