

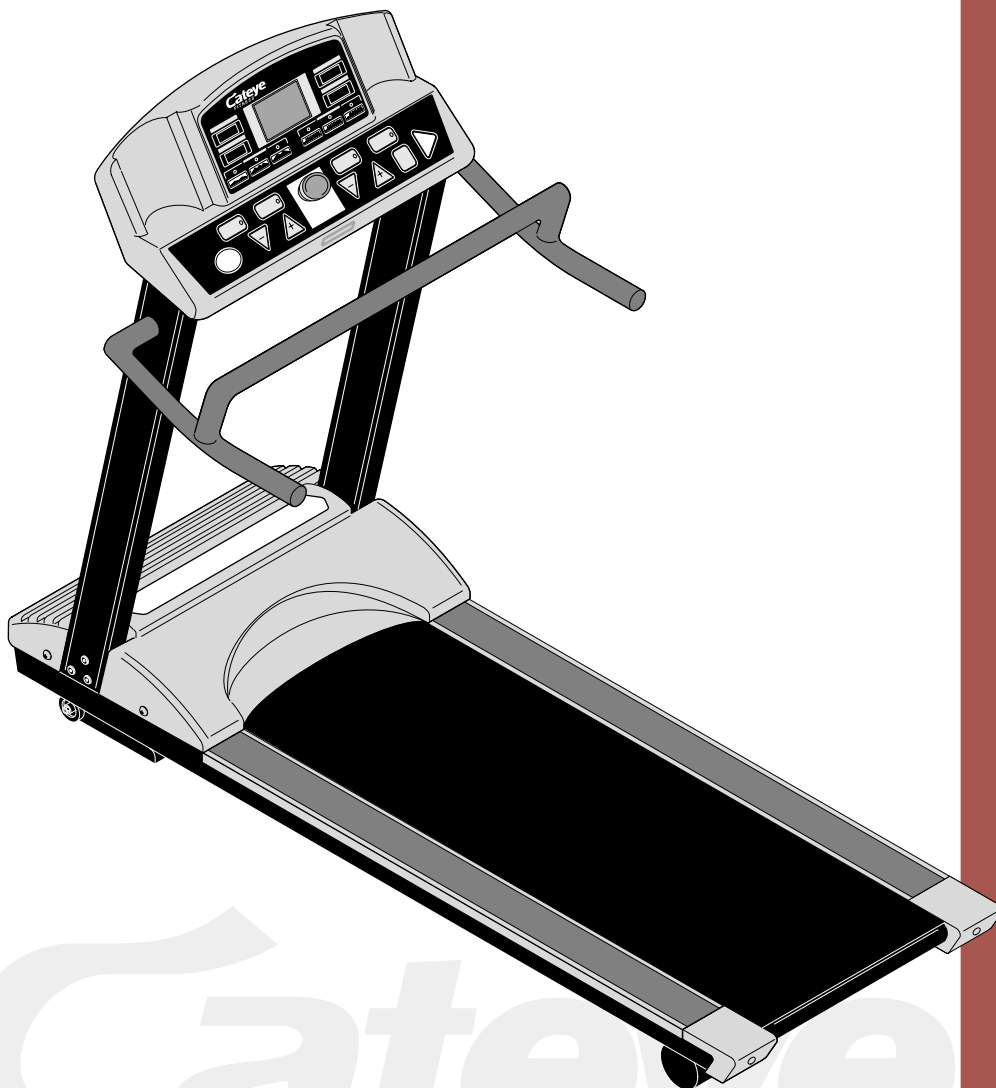

Cateye Treadmill

MODEL EC-T220

Instruction Manual



TRE
A
D
M
I
L
L
E
C
-
T
2
2
0

Cateye
FITNESS

HOW TO USE THIS MANUAL

After first reading the "Start Guide," assemble the machine and give the Model EC-T220 Treadmill type Cat eye Fitness a try.







Once you've become accustomed to the machine, read the "Operation Guide" and experiment with the EC-T220's wealth of functions.

Make use of the "Reference Guide" as needed.

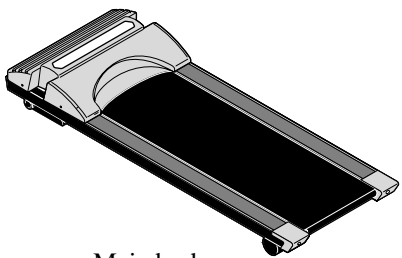
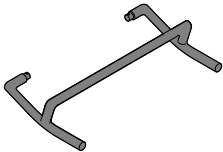
CONTENTS

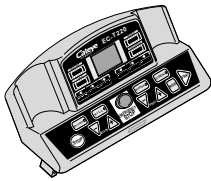
Start Guide	Operation Guide	Reference Guide
1 Starting with assembly 7	1 Training goals 22	1 Maintenance of the chest-belt heart rate sensor 38
2 Preparation and warnings before getting on the treadmill 11	2 Training program characteristics ... 24	2 Other useful functions 39
3 Putting on the chest-belt heart rate sensor 12	3 HR control training 26	3 Troubleshooting 40
4 Trying out the treadmill for the first time 13	4 Interval training 28	4 Handling warnings 41
5 The 4 kinds of programs 16	5 Hill profile training 30	5 Repair service warranty/ additional parts 42
6 Using the EC-T220 without a data card 18	6 Quick start (manual training) 32	6 Product specifications 43
	7 Making a Data Card 34	

Check that you have all the parts.

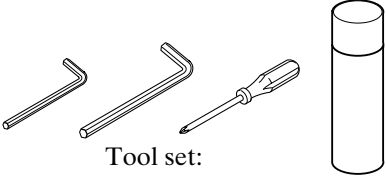
 Main body	 Handle	 Handle masts	 Control unit
 Data cards 10 Startcard 1	 Safetykey	 Instruction manual Warranty Certificate	
 <p>Installation screw set:</p> <ul style="list-style-type: none"> • A: Bolts by which the handle masts are attached 10 • B: Bolts by which the handle is attached 2 		 <p>Tool set:</p> <ul style="list-style-type: none"> • Wrenches (Small and big) • Screwdriver • Silicon grease 	

INTRODUCTION

Thank you very much for purchasing the Model EC-T220 Treadmill type Cat eye Fitness. The model EC-T220 is a new high-tech running exerciser with a built-in computerized training system designed specifically to promote cardiovascular fitness and overall endurance, the keystone of good health.

With its four training programs, the EC-T220 will help you to maintain or improve your physical condition in a fun and pleasant way. The pilot system with LCD leads you through your chosen program easily. We hope you will make good use of your Cateye Treadmill EC-T220 for years to come. Before using your new exerciser, please read this manual carefully. Then keep the manual in a safe place along with the warranty card.

Symbol marks used for safety precautions in this manual

The descriptions accompanying the following symbol marks in this manual refer to very important matters in terms of your safety and handling of the unit.

You are strongly urged to observe these precautions.

 **Warning** Failure to observe this warning could result in serious injury or death.

 **Caution** Failure to observe this warning could result in physical injury or damage to the treadmill.

Reference This symbol mark denotes helpful information or associated items.

FOR SAFE OPERATION

For safe use, always observe the following rules.

WARNING

- Before using the EC-T220, it is important to consult a medical specialist if you are suffering from any of the following: heart disease (angina pectoris, myocardial infarction), hypertension, diabetes, respiratory disease (asthma, chronic bronchitis, pulmonary emphysema, etc.), articular metamorphosis, rheumatism, gout, or other diseases and physical complaints. Pregnant women should also consult their doctor before commencing a training program.
- If you are not used to regular physical activity, it may be dangerous to suddenly engage in strenuous activity. Increase your exercise level gradually.
- If you feel sick or sense something is wrong with your body during exercise, stop immediately.
- Close supervision is necessary when this exerciser is used by, or near children, persons in poor health, or disabled persons.

CAUTION



Always unplug from the electrical outlet immediately after using and before cleaning. Do not leave plugged in.



Turn all controls to the off position before removing the plug from the outlet. Remove the plug without pulling the cord.



Do not operate where aerosol (spray) products are being used or where oxygen is being administered.



Keep the cord away from heated surfaces.



Do not use the unit if the cord or plug is damaged, when the unit does not operate normally, when it has been dropped or damaged, or when it is wet. If such events have occurred, contact our authorized dealer in your location.



Never operate the exerciser with the air vents blocked. Keep the air vents free of lint, hair, and the like.



Never drop or insert any object into an opening.



Avoid using the unit in manners other than those described in this manual. When repairing the unit, be sure to use genuine parts for Cateye Treadmill only.



Avoid using or storing the unit outdoors or in areas where it is exposed to direct sunlight.



Do not use the unit in areas where temperature or humidity are high.



Do not touch the main unit or plug if your hands are wet.



Close supervision is necessary when this exerciser is used by, or near children, persons in poor health, or disabled persons.

This equipment has been certified to comply with the limits for a Class B computing device, pursuant to Subpart J of Part 15 of FCC Rules. Only peripherals (computer input/output devices, terminals, printers, etc.) certified to comply with the Class B limits may be attached to this computer. Operation with non-certified peripherals is likely to result in interference to radio and TV reception.

PART NAMES

Main body

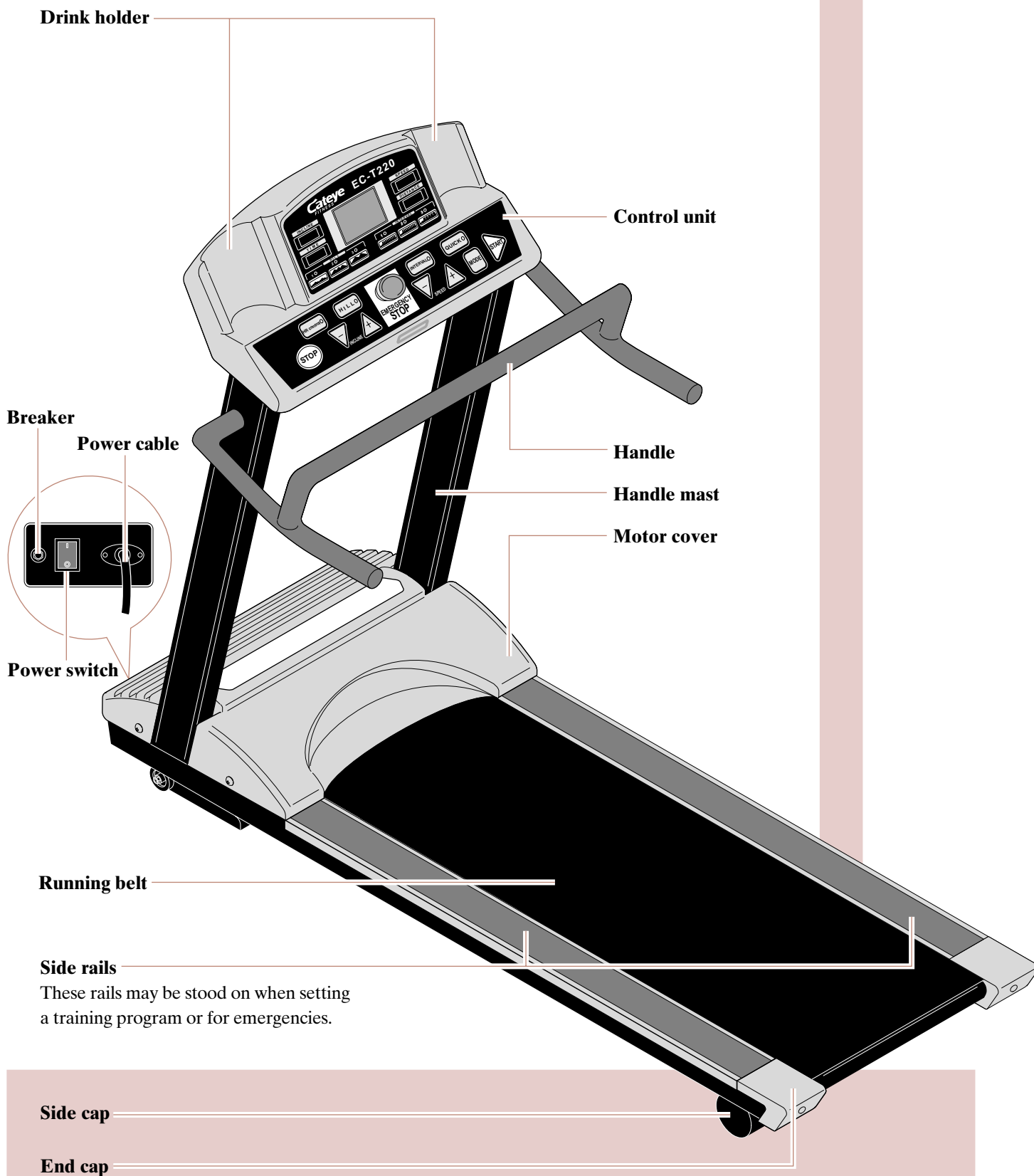

Control unit

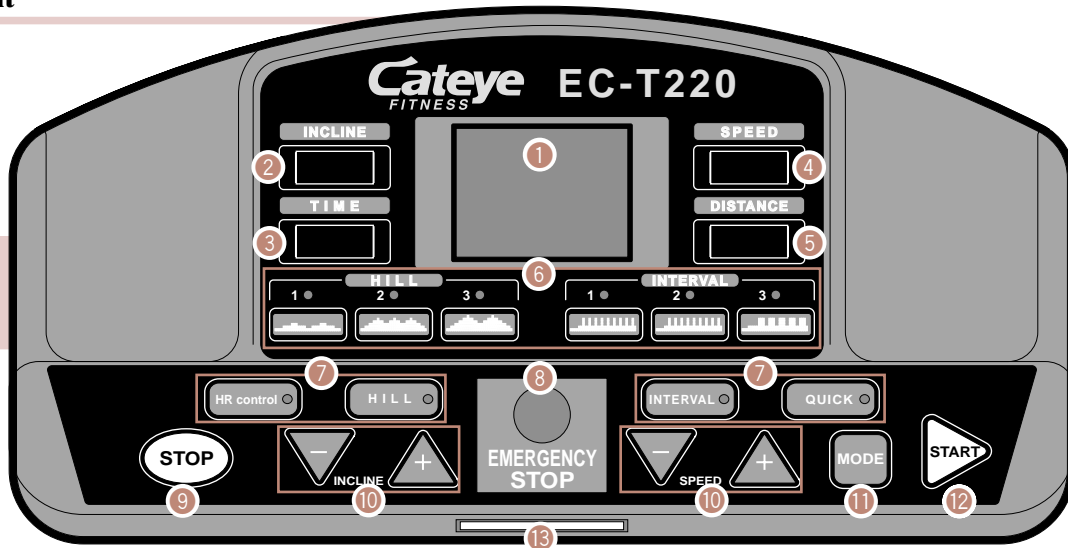

1 Liquid crystal display (LCD)

2 Incline display

Displays the changes of the hills you will pass over.

3 Time display

Displays the time elapsed since this training session was started.

4 Speed display

Displays your current speed.

5 Distance display

Displays the total distance traveled since this training session was started.

6 Pattern display

When hill profile training or interval training have been selected, the pattern (hill shape or training interval) which is set is indicated by a lamp.

7 Training select buttons

HR control HR control training is selected.

HILL Hill profile training is selected.

INTERVAL ... Interval training is selected.

QUICK Quick start (manual training) is selected.

8 EMERGENCY STOP button

If pressed during training, speed is quickly dropped to zero.

9 STOP button

This button ends the program. If it is pressed during a cool-down period, cool-down is ended.

10 Number +/- buttons

During input

Increases or decreases the value of the item being changed.

During training

Increases or decreases the speed or incline.

When training is completed.

You can check the progress of your training by using these buttons to scroll the graph of incline/speed changes on the LCD screen.

11 MODE button

Selects programs and switches between items to change.

12 START button

Sends the program to the next stage.

13 Card slot (Safety key slot)

Insert a data card.

Insert the safety key when the safety key function is activated.

LCD

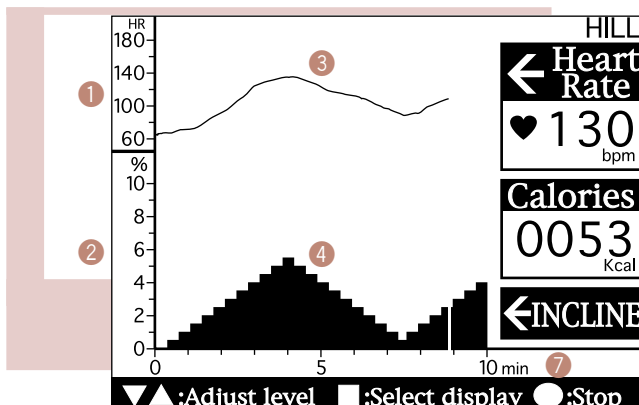

1 Heart rate (bpm)

2 Incline scale (%) / Speed scale (mph)

3 Graph of changes in pulse

4 Graph of changes in incline / graph of changes in speed

5 Heart rate (bpm)

6 Calories consumed (kcal)

7 Time scale (minutes)

START GUIDE

- 1 Starting with assembly 7
- 2 Preparation and warnings before getting on the treadmill 11
- 3 Putting on the chest-belt heart rate sensor..... 12
- 4 Trying out the treadmill for the first time 13
- 5 The 4 kinds of programs 16
- 6 Using the EC-T220 without a data card 18

1

STARTING WITH ASSEMBLY

Read this warning before assembling the unit:

Caution: Do not remove the wires which are wrapped around the handle masts before assembly.

Follow the steps starting from the next page and assemble the unit as shown in the figure below.

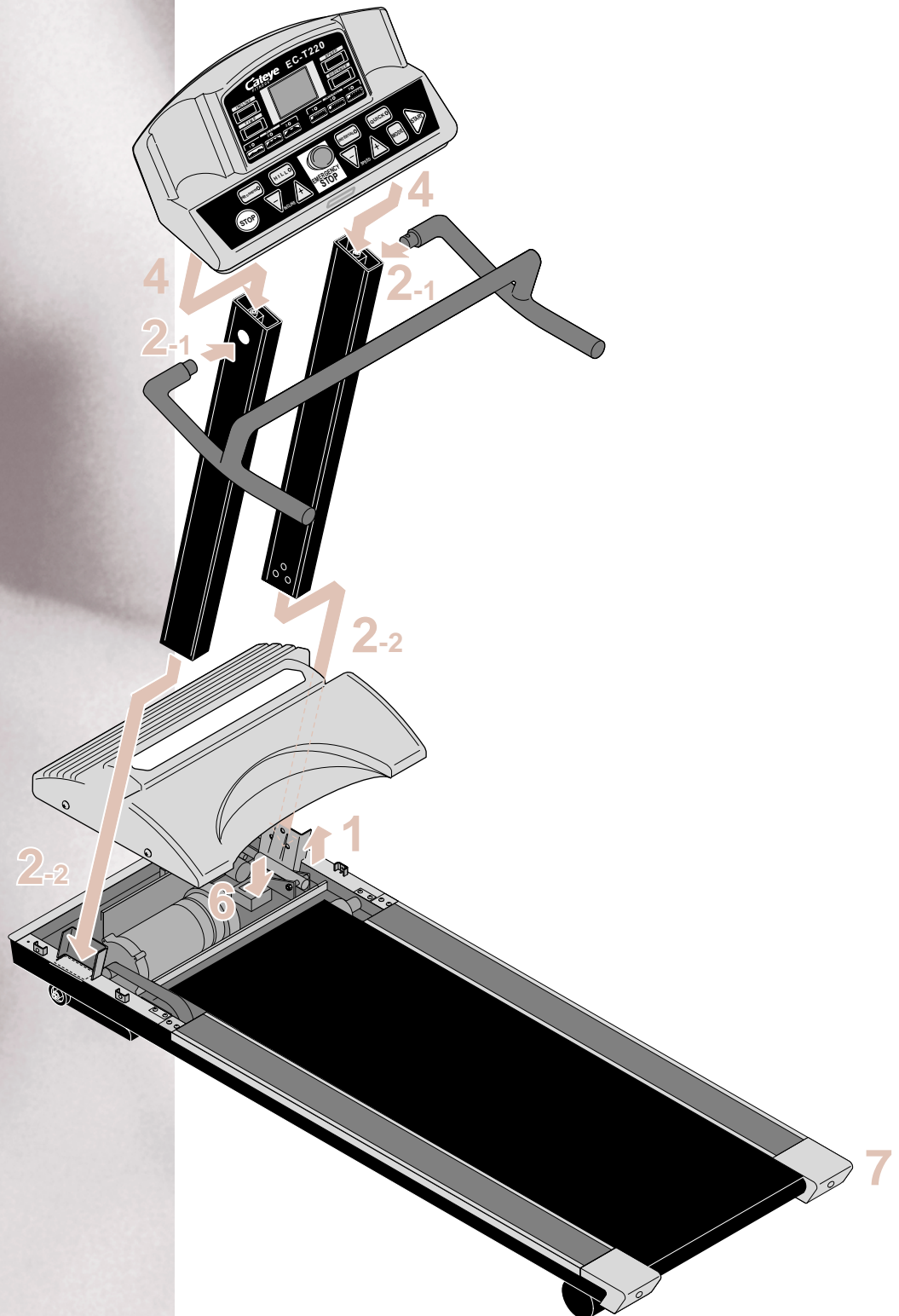

1

Remove the motor cover.

- The motor cover must be removed for assembly.

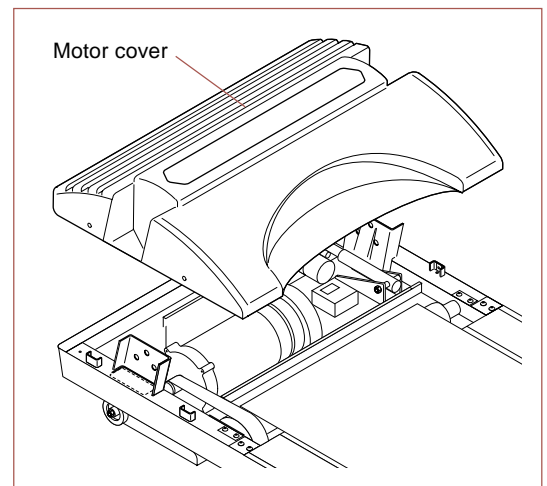

2

Attach the handle masts and handle.

- Insert the handle into the sides of the handle masts. Fix in place by screwing in the 2 bolts (B) from above.

Caution: • Be sure which handle mast is the left one and which is the right one before inserting the handle.

- Tighten the screws loosely at first. After the handle masts, handle, and main body are assembled together, firmly tighten all the screws.
- Stand the handle masts up on the main body and fix them in place with the six bolts (A).

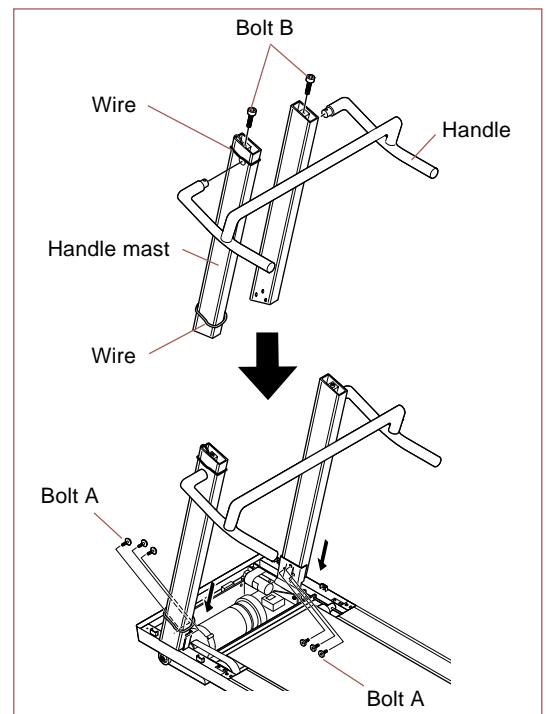

3

Put the cords through the handle mast.

- Remove the wire (upper side) which is wrapped around the handle mast.
- Wrap the same wire around the ends of the cords which come from the control unit.
- Insert the 3 cords with the wire wrapped around into the handle mast inside.

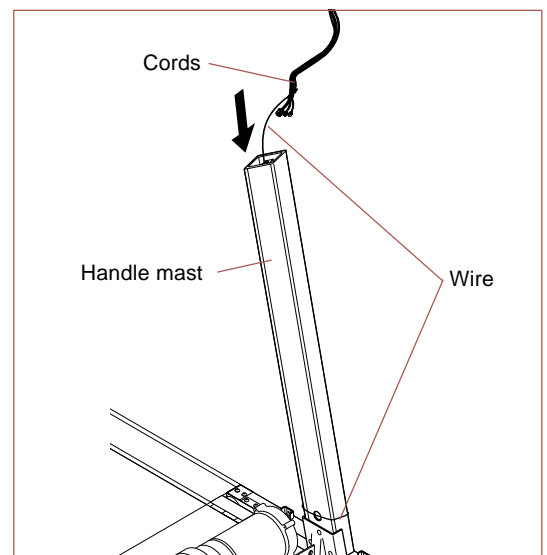

4

Attach the control unit base to the handle masts.

- Position the control unit cross to the handle masts, and then prepare to pass the cords through the handle mast inside.

Caution: Be careful that the control unit does not fall down.

- Remove the wire (lower side) which is wrapped around the handle mast.
- Through the lower opening, pull the wire which comes from the handle mast inside, and draw the 3 cords from the inside.

Caution: Do not pull the wire forcefully. Pull the cords gradually while the cords are sending from the upper part of the handle mast.

- Fit the control unit onto the handle masts and fix it using the 4 bolt As.

Caution: Be sure that the cords are not pinched when installing the control unit base onto the handle masts.

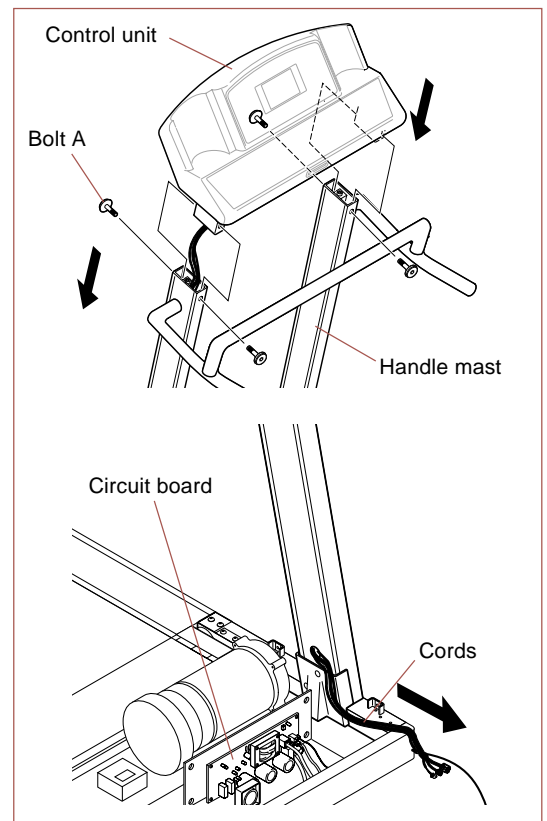

5

Attach the connectors on the 3 cord ends to the circuit board inside the main body.

- Connector (white) : ①
- Connector (big) : ③
- Connector (small) : ②

Caution: The shape of the connectors on each of the 3 cords is different. Be sure to connect each of them to the correct place.

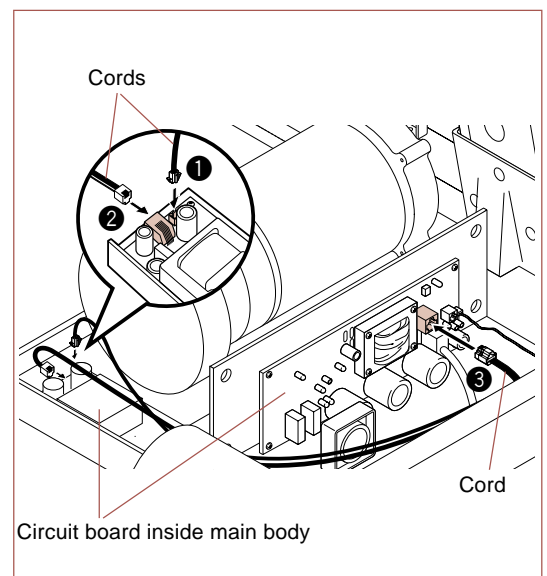

6

Attach the motor cover.

- Remove the 4 screws, put the motor cover in position, and replace the 4 screws to fix it in place.

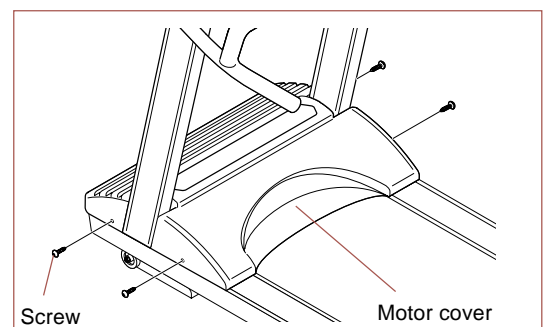

7 Adjust the running belt.

Caution:

- Do not operate the buttons while standing on the belt.
- When adjusting the belt, take care not to get your hands trapped or pinched.

- Turn the power switch on.

Caution: Connect the power plug directly to a power socket, for example one on the wall. If two or more machines are connected using an extension cord, etc, a power voltage failure may occur and the machine may not operate properly.

- Press the QUICK on the training select buttons.
- Press and hold the SPEED + button until the speed is around 2.5 mph [4.0 km/h].
- Let it run for a few moments. Be sure that the running belt is centered and does not tend toward one side or the other.
- If the running belt is too close to the right side, tighten the adjusting screw in the right end cap. If the belt is too close to the left side, tighten the adjusting screw in the left end cap.
- When the belt is centered, or if no tendency toward either side is seen, press the EMERGENCY STOP button to finish adjustment.

Selecting quick start

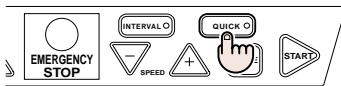

Speed increase

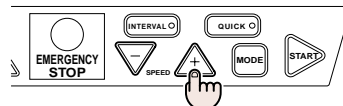

Reference: Using the provided silicon grease, lubricating the running belt inside evenly every month in daily maintenance extends the life of the running belt.

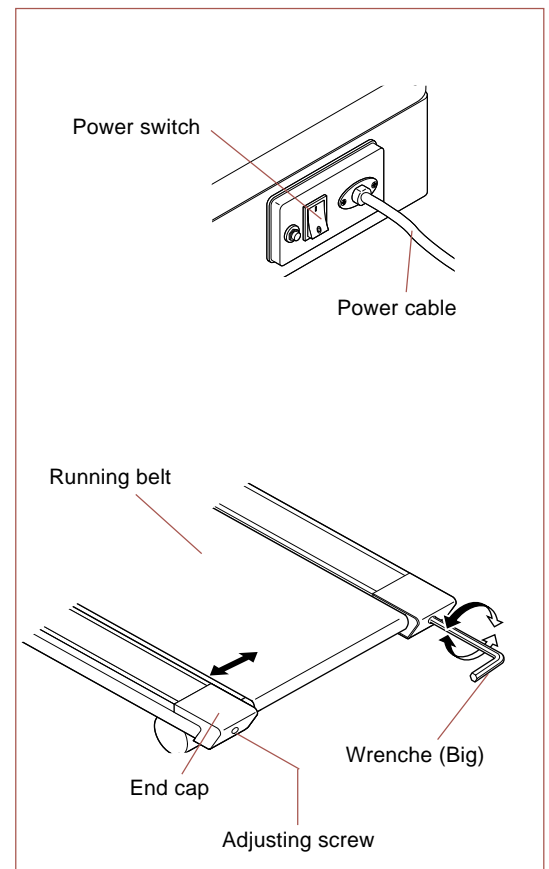

How to open the control unit

Remove the 10 screws of the control unit base, and then remove the control unit and the control unit base.

Caution: Since the cords are connected into the control unit inside, open the unit in the direction indicated by the arrows.

Reference: The following items can be changed by the dip switch settings in the control unit:

- Measurement unit (mph or km/h)
- Language: English, French, Spanish, or Japanese (or German)
- Safety key functions (Cancel or Active)

At the time of delivery, the settings are: Measurement unit - mph, Language - English, and Safety key function - Cancel.

When the dip switch settings are changed, turn off and back on the power again so that the setting changes take effect.

For further information relating to the setting changes for each item, refer to page 39 in the "Reference Guide".

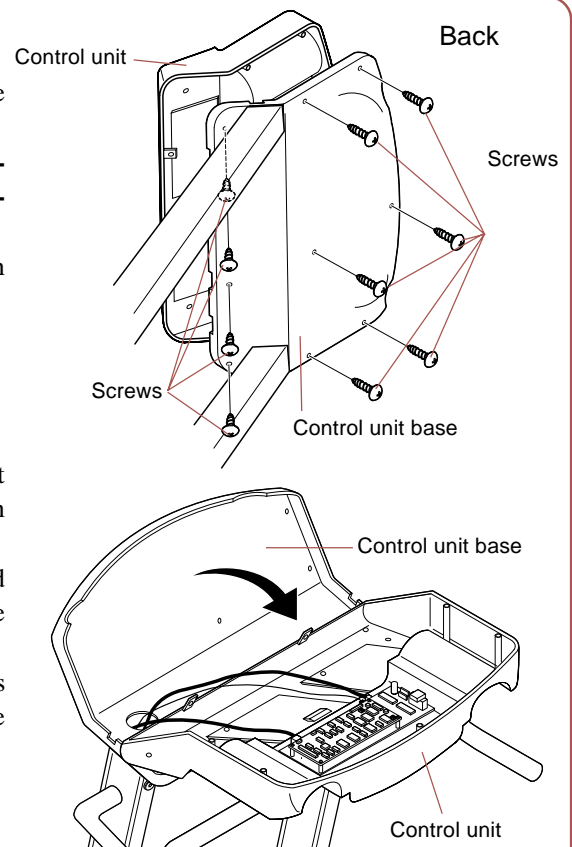

2

PREPARATION AND WARNINGS BEFORE GETTING ON THE TREADMILL



Warning

Be sure to securely stop the running belt by pressing either the **EMERGENCY** button or **STOP** button before you step up on the EC-T220.

1. Grip the handle securely until you are comfortable on the EC-T220.
2. When you are accustomed to exercise with EC-T220, you may exercise free from the handle, swinging your arms freely and naturally at your side.
3. Keep your track on the center part of the running tread.

Caution: While exercising, stepping on any part other than the running belt may cause you to fall.

4. After a few seconds of exercise, the running belt speed will become faster.
5. Keep your running within a distance where you can still reach the **EMERGENCY STOP** or **STOP** button and operate the treadmill.

Caution: Stay in the center part of running belt area for safest operation. Slow down or stop your exercise immediately if you are unable to keep up with the belt speed.

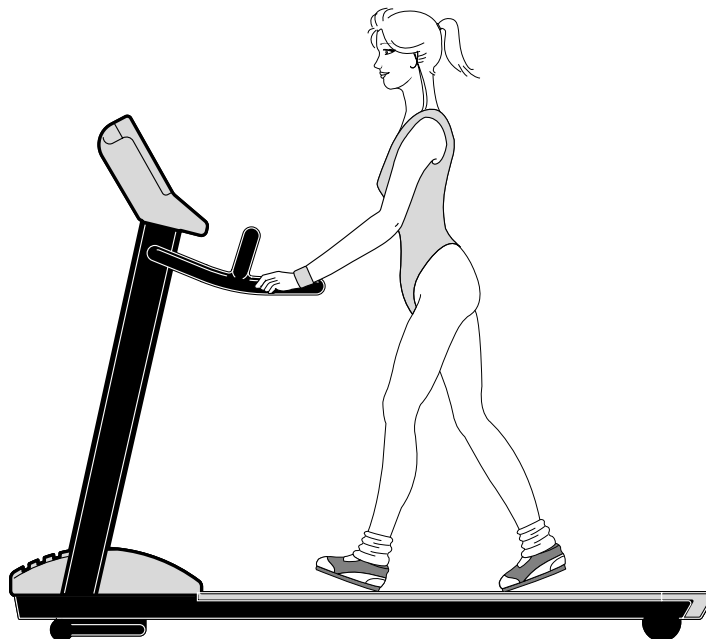

Safety Key Function

The card slot of this machine functions as a safety key when you change the setting of dip switch in the control unit.

Removing the safety key from the card slot will stop the treadmill as will pushing the emergency stop button.

The LCD screen lights up and then the program starts only when the safety key or card is inserted into the slot while the safety key function is activated. This allows you to use the function to prevent tampering.

For further information relating to the procedures for how to set the safety key function, refer to "Setting the Safety Key Function" in page 39 of the "Reference Guide"

Reference: The program will be initiated when a key is inserted to the card slot, and you can use the data card as a key to initiate the program.

Caution: For your safety, attach the clip end of the cable from the safety key to your clothes.

How to Use the Safety Key

(How to start the program when the safety key function is activated.)

1. Attach the clip end of the cable from the safety key to your clothes.

Caution: Check that the safety key will come out of the card slot when your body is away from the control unit.

Reference: When the data card is to be used as a safety key, fix the card to the cable.

2. Insert the safety key to the card slot.
3. Following the instructions on the screen, select the training program, set necessary conditions, and start your training.

Reference: The LCD screen lights up only when the safety key or card is inserted into the slot while the safety key function is activated.

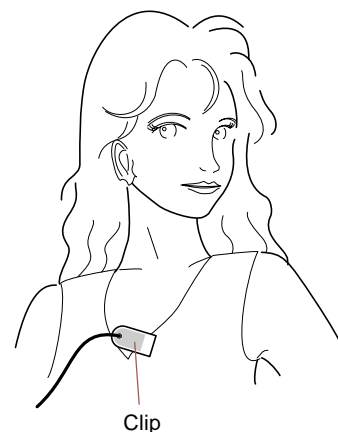

Clip

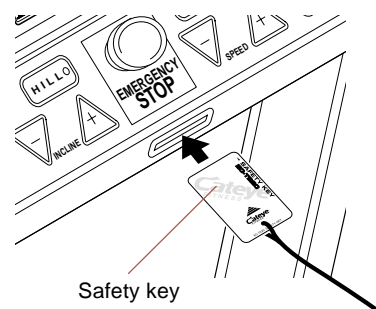

Safety key

PUTTING ON THE CHEST-BELT HEART RATE SENSOR

Your heart rate can be measured by the chest-belt heart rate sensor.

The EC-T220 treadmill receives and calculates the number of heartbeats which are transmitted from the wireless chest-belt. It is therefore possible to control your heart rate during exercise. Accurate heartbeat measurement is possible, even for those persons whose pulse is difficult to detect.

When a heart rate signal is received and calculated, a graph of the heart rate is displayed at the top of the LCD screen. The pulse itself is also displayed at the top right of the screen.

When the chest-belt is not worn, the graph and pulse displays are not shown.

The HR control training function will not operate if the chest-belt is not worn.

Function of the chest-belt heart rate sensor

The wireless chest-belt heart rate sensor uses a miniaturized and simplified version of the electrocardiography concept used in hospitals. For an electrocardiogram, multiple electrodes are attached to the body, and the electric potential difference between them is used to calculate the heart rate. The chest-belt heart rate sensor's two internal electrodes are applied to the body and detect the electric potential difference, providing a simpler way of detecting heartbeats. This information is sent to the control unit by radio waves, so even hard training is possible. The chest-belt heart rate sensor uses the chest-belt (transmitter) and the signal-receiving circuit board (receiver) contained in the control unit to read your heart rate and calculate and display your per-minute pulse.

Before putting on the chest-belt heart rate sensor



Warning Pace maker users should never use this device.

Caution:

- Put on the chest-belt heart rate sensor at the center of your chest and in contact with your skin.
- To increase measurement effectiveness, dampen the electrode area with water or electrocardiograph electrolyte cream.
- People with sensitive skin can put on the chest-belt over a thin shirt with electrode area dampened with water.
- Hair on the chest may interfere with accurate measurements.

Putting on the chest-belt heart rate sensor

Put it on following the procedure below.

1. Adjust the length of the attachment belt to fit your chest.

Caution: May be painful if tightened too much.

2. Hook the attachment belt to the electrode belt. Place the electrode area at the center of your chest. Be sure that the electrode area is held firmly against your skin.

Reference: When wearing the chest-belt heart rate sensor over a shirt it is necessary to moisten the electrode area for the better results. In the winter season when skin can be dried, errors may occur even when the electrodes are in direct contact with your skin. This can be improved by moistening the electrodes.

3. Adjust the belt so that the transmitter is at the center (just above your diaphragm) of your chest.

Reference: When wearing the chest-belt heart rate sensor over a shirt it is necessary to moisten the electrode area for the better results.

The chest-belt heart rate sensor uses a lithium battery. The lithium battery has a limited lifetime; when changing the battery, refer to the Reference Guide, page 38, "Maintenance of the chest-belt heart rate sensor."

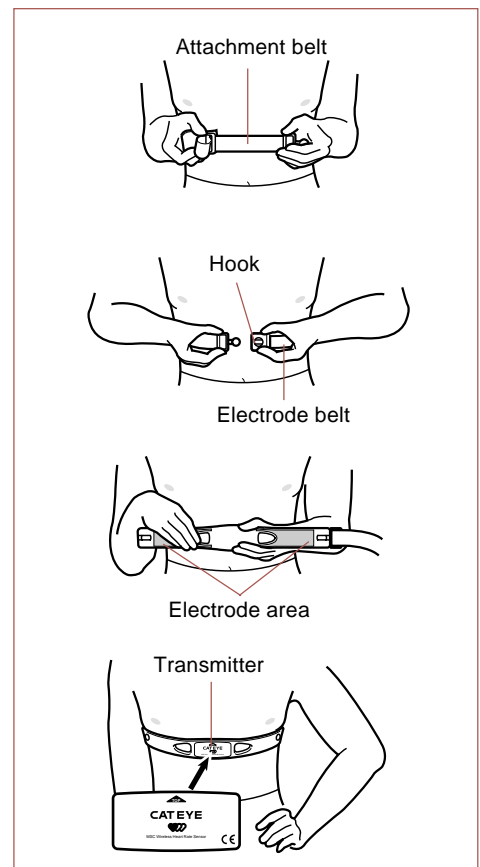

4

TRYING OUT THE TREADMILL FOR THE FIRST TIME

1 Put on the chest-belt heart rate sensor and turn on the power.

- Put the chest-belt heart rate sensor around your chest with the two electrodes at the center, in contact with your body, as per the instructions on page 12.
- Insert the power plug into any household AC outlet (120 V or 220 V). The power plug is attached to the front of the main body.

Warning Because of the danger of electric shock, do not insert the AC plug into an outlet if your hands are wet.

Caution: Connect the power plug directly to a power socket, for example one on the wall. If two or more machines are connected using an extension cord, etc, a power voltage failure may occur and the machine may not operate properly.

- Turn on the power switch.
- The control unit will display "Cateye EC-T220" and prompt you to insert a data card or select a training mode.

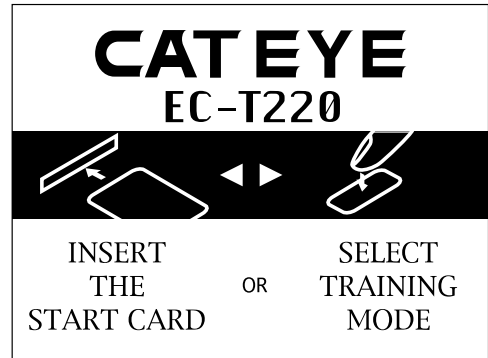
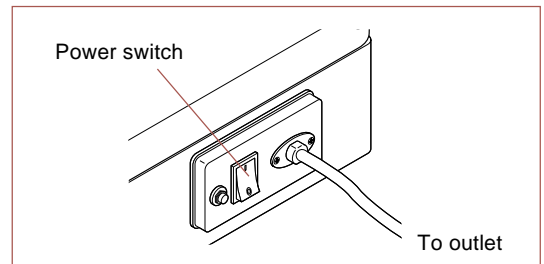

2 Insert the start card (the blue card provided).

- Find the blue card (start card) in the packaging of the exerciser. Insert this card into the slot of the control unit (card slot). If the card is upside-down, the unit will not work. Be sure to insert the card as shown in the figure.

Caution: Use only the blue card at this stage. It is a sample card with exercise data already stored in it. The unit will not work with the black cards since they do not contain any data yet. For information on how to make a data card, refer to page 34.

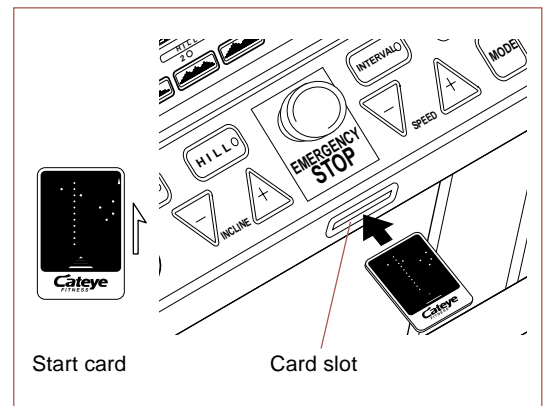

3 Check the screen display.

- The screen prompts you to press the START button, and the numeric display should be as shown in the figure. If these displays do not appear, pull the card out and slowly insert it again. The numbers in the display show the training conditions.

① "HILL" is short for "hill profile training," and shows the type of training to be engaged in. The incline will automatically change according to the hill shape.

② "15:00" is the exercise time (alarm time) display, and means 15 minutes.

③ "1" indicates the shape of the hill to be climbed. "1" is the gentlest slope.

Reference: The data on the screen can be revised at this stage. The +/- buttons will increase or decrease any of the above numbers. The screen can be changed back to the data input screen by pressing the MODE button. However, the purpose of this section is to get you acquainted with EC-T220, so if you have changed any of the numerical values, please return them to their original settings.

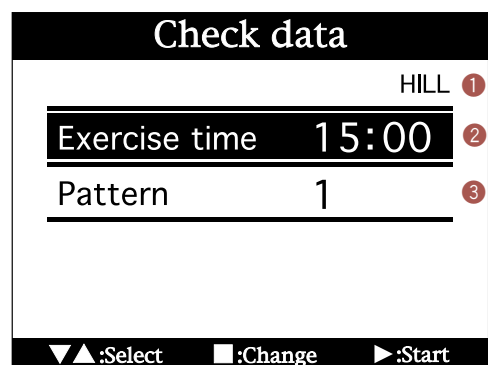

Increase or decrease numbers.

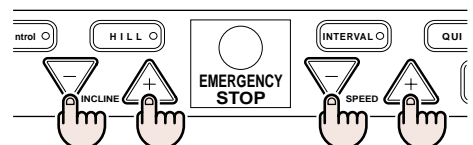

Change items to input.

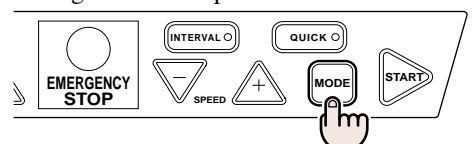

4

Start your exercise.

- Press the START button to start.
- **Caution: Grip the handle before pressing the START button.**
- After pressing the START button to begin the workout, the console will beep and show the shape of the hill pattern on the LCD.
- The belt will begin to move slowly. Begin your exercise now. The incline will gradually become steeper and you may change the speed at any time by pressing the SPEED +/- speed arrows.
- **Caution: Exercise at a suitable speed and incline.**
- The LCD screen and numeric display screen display data as shown in the figure. The data on the two screens shows your current conditions, which will keep changing as time passes.

Starting exercise

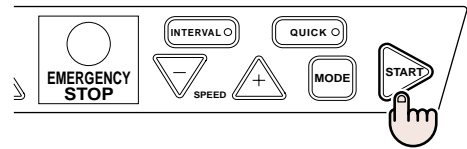

Increase or decrease of speed

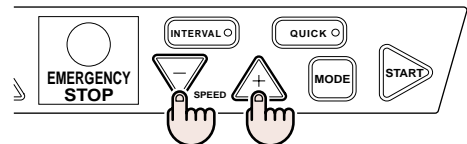

LCD

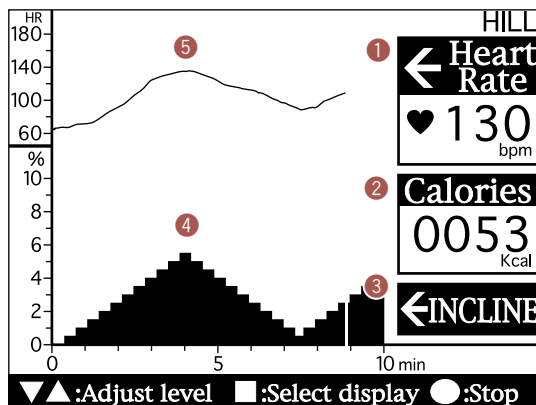

- 1 Current pulse rate, beats per minute.
- 2 Calories consumed during exercise.
- 3 The lower part of the LCD displays either the incline or the speed.
- 4 The display can be switched between speed and incline by pressing the MODE button.
- 5 The changes in pulse is displayed. The LCD screen will scroll to move the present position to the center of the screen after exercise.

Numeric Display

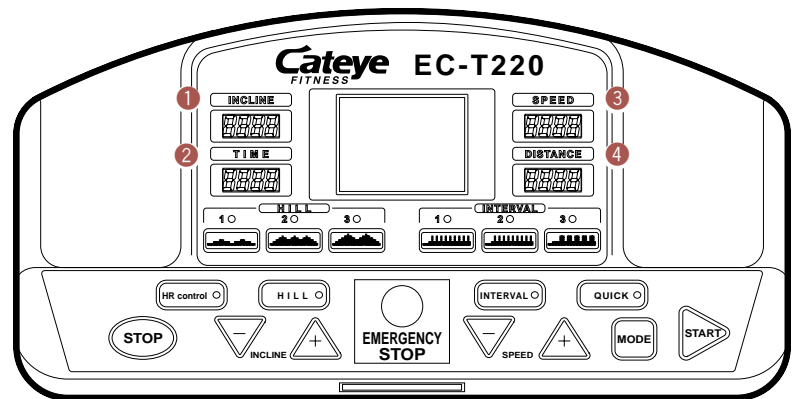

- 1 Current incline is displayed by %. You can adjust it by pressing the INCLINE +/- buttons during exercise.
- 2 Elapsed time since starting the current session.
- 3 Current speed.
- 4 Distance since starting the current session.

5 You can select a display of either incline or speed by pressing the MODE button.

- You can switch between the incline and speed displays by pressing the MODE button. You can still adjust the speed when the incline is displayed on the LCD. And you can still adjust the incline when the speed is displayed on the LCD.
- Keep on exercising for a while. The incline will change automatically and your calorie consumption and pulse rate can be seen. The Model EC-T220 offers programs to display the information you may need through your exercise.
- You can slow down your exercise speed by pressing the SPEED +/- buttons in case you are unable to keep up with the speed and incline. By pressing the - button one time, you will decrease the speed by 0.1 mph [0.1 km/h]. To enjoy your exercise with this treadmill, select exercise that is appropriate for your condition.

Selecting incline or speed during exercise

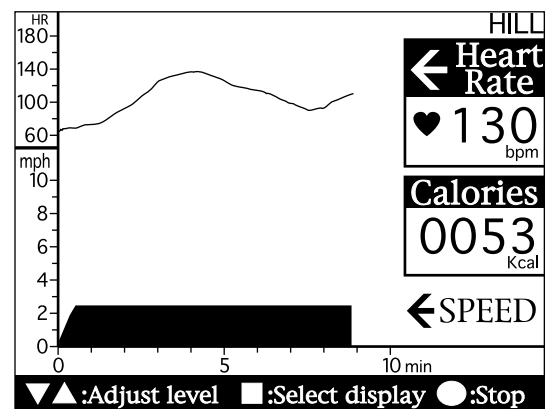
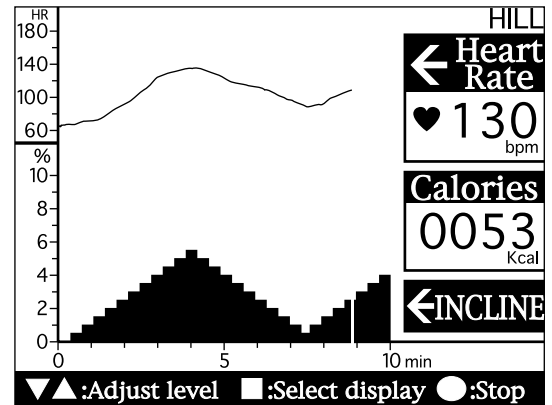
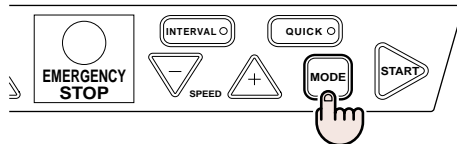

6 Finish your exercise.

- After 15 minutes of exercise, the buzzer will sound to inform you that the training will end.
- You can continue the training by not pressing anything, or you can finish the training by pressing the STOP button.
- You can stop your exercise during the 15-minute session by pressing the STOP button.
- After pressing the STOP button, the cool-down starts. It lasts 5 minutes and you can finish the exercise at any time by pressing the STOP button.
- After the exercise you can review your workout data on the screen. The display can be switched between incline and pulse display and speed display by pressing the MODE button. If you have worked out more than 15 minutes, you can use the SPEED or INCLINE +/- buttons. The - button will scroll the screen to the left and the + button will scroll the screen to the right.
- Press the STOP button to end the program completely and return the screen to the initial display.

Finishing training

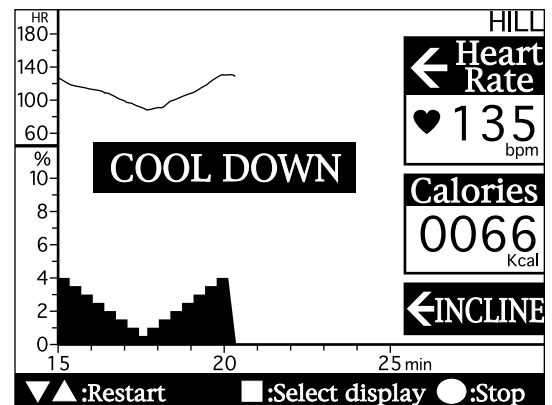
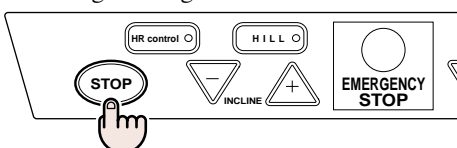

So far we have covered only the beginning of the Model EC-T220 Cateye Treadmill functions. Let us move on to an explanation of other functions.

HR control training (Training at a set pulse rate)

- You set a target pulse rate at which you want to exercise and the Model EC-T220 automatically adjusts the incline to maintain your pulse rate close to the desired level. This is ideal for effective aerobic training.
- As you continue to exercise at a certain pulse rate and make progress in your fitness level, you will be able to exercise more easily at the same pulse rate. Consequently, you will then be able to exercise at a higher target pulse rate.

Reference: The "HR" of HR training means "heart rate" (the same as pulse rate).

Interval training (Repetition of a pattern of exercise and rest, tailored for a serious workout)

- By switching back and forth between exercise and rest periods of varying length, interval training gives you the kind of program that serious athletes often use to build up their total power.
- On the model EC-T220, 3 patterns of interval training programs are available for developing sprint power, speed, and endurance respectively.

PRF-1: dash strength training (sprint power)

30 seconds of exercise followed by a 90-second rest.



PRF-2: speed training (anaerobic power)

60 seconds of exercise followed by a 120-second rest.



PRF-3: endurance training (aerobic power)

120 seconds of exercise followed by a 60-second rest.



- Choose one of the above patterns, and adjust the intensity by selecting your desired speed and incline.

Hill profile training (Casual mountain climbing)

- The incline changes to simulate the effects of climbing up and down mountains. The changing patterns of the incline are shown on the screen.
- The following three types of mountain profiles are programmed.

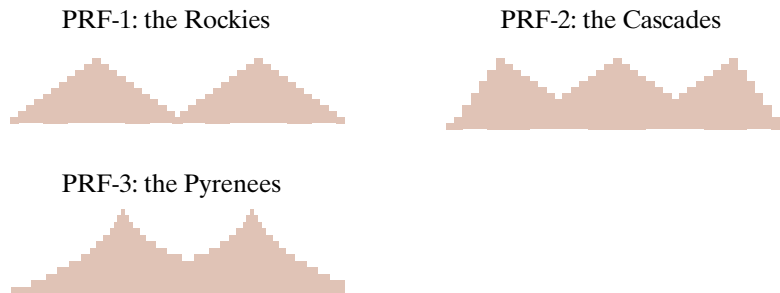

- The mountain profiles from 1 to 3 are arranged in order of difficulty. Try to start with a profile that looks easy enough for you.
- Choose one of the above patterns, and adjust the intensity by selecting your desired speed and incline. When you change the incline pattern, it will be reflected throughout the whole pattern.
- The preset training time is 15 minutes. If you set a longer training time, the same pattern will repeat to match the training time.

Quick start (Manual training - training at a set belt speed)

- You designate the belt speed and it stays constant regardless of your pulse rate. This is the basic, traditional way the treadmills have been utilized.
Setting range: 0.5 - 12 mph (Adjustment increment: 0.1 mph)
[1.0 - 18.0 km/h (Adjustment increment: 0.1 km/h)]
0 - 12% (Adjustment increment: 0.5%)

Upper pulse limit alarm

- For your safety, the upper pulse limit alarm is provided in all programs of the EC-T220. If your pulse rate exceeds this limit, the alarm buzzer sounds and the belt speed automatically drops to the minimum. This function urges the user to stop the exercise.
- When your pulse rate has dropped back to within the pulse rate upper limit, restart the exercise by pressing the START button and raising the speed manually.

6

USING THE EC-T220 WITHOUT A DATA CARD

The blue card you used for your first session serves to input the type and conditions of training. But it is also possible to do the same thing without the card, by using the buttons on the control unit.

You need the chest-belt heart rate sensor for the HR control training. You must put on the chest-belt heart rate sensor around your chest, as per the instruction on page 12.

1 Turn on the power supply.

- Insert the AC plug of the AC adapter into any household AC outlet.
- Turn on the power switch, located on the front of the main body.
- On the screen, the initial display is shown, and a message prompts the user to insert a data card or select a training mode.

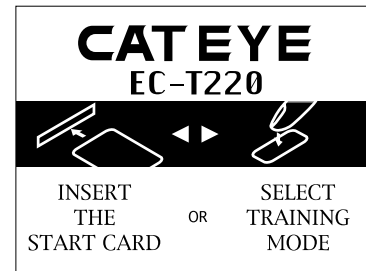

2 Select a training program.

- Select one mode from the four training modes when you see the message, "Select a training mode" at the lower right of the LCD.
- The four training program buttons are as follows (from left to right):
 - 1 HR control training
 - 2 Hill profile training
 - 3 Interval training
 - 4 Quick start (manual training)
- This time we will choose "HR control" as an example.
- Choose the program by pressing the HR control on the training select button.

Training mode

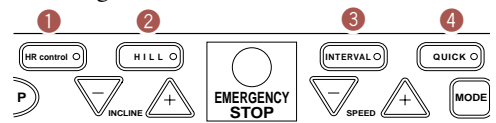

Selecting training mode

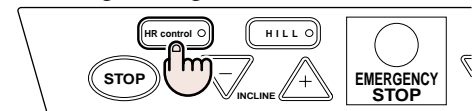

3 Input training conditions.

- The screen prompts you to set the training conditions.
- The screen changes as shown here, and the initial value for age (40) is shown.
- You can increase or decrease this number by pressing the SPEED or INCLINE +/- buttons. The value changes rapidly if either button is held down. For example, press the INCLINE + button to change the value for age from 40 to 52.

Caution: Do not press the START button before completely inputting the data. If you press the START button before completing data input, the skip function is activated, and exercise begins.

- After inputting your age, go on to the next screen by pressing the MODE button.

Caution: Input contents vary depending on the program.

- Try changing the displayed target pulse rate from 118 to 115.
- After finish inputting your target pulse rate, go to the next screen by pressing the MODE button.
- Input the exercise time.

Reference: The exercise time is equal to the alarm time. The alarm time does not mean the end. You can continue the exercise after the buzzer sounds.

- When the MODE button is pressed again, a screen appears for you to confirm the training conditions. Check the training conditions.
- If you will change your training conditions, highlight the items to adjust by pressing the SPEED or INCLINE +/- buttons and then press the MODE button. Then the screen returns to the input screen of the data you want to change.

Reference: The card is a tool to instantly set a program and training conditions. Usually you have to set such conditions by pressing buttons before each session, but the data card saves you the trouble. The age, upper pulse limit setting, and target pulse rate will be automatically entered. See "Making a Data Card" on page 34.

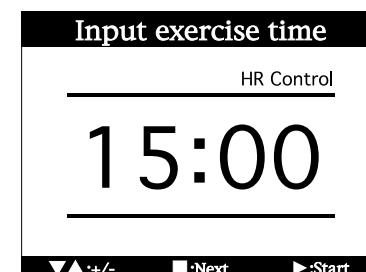
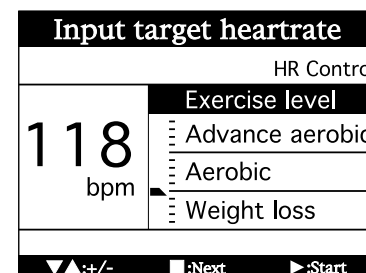
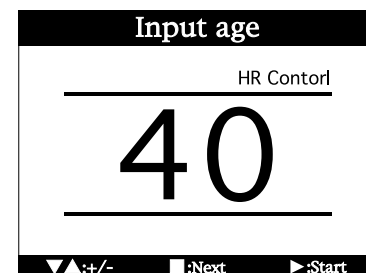

4 Start your exercise.

- After inputting the training condition, get on the running belt and press the START button. The message "Start warming-up" is displayed to announce that the HR control training program has started. Start walking slowly.

Caution: Begin running when the belt speed becomes too fast for walking.

- During or after warm-up, the speed can be adjusted manually, using the +/- buttons.
- The incline will be increased or decreased automatically in order to maintain your pulse rate close to target pulse rate.
- If you press the MODE button when the speed display screen is shown, the speed display is switched to the incline display screen. If you press the MODE button when the incline display screen is shown, the incline display is switched to speed display screen. You can see the track of your pulse rate on the upper part of the LCD.

Starting exercising

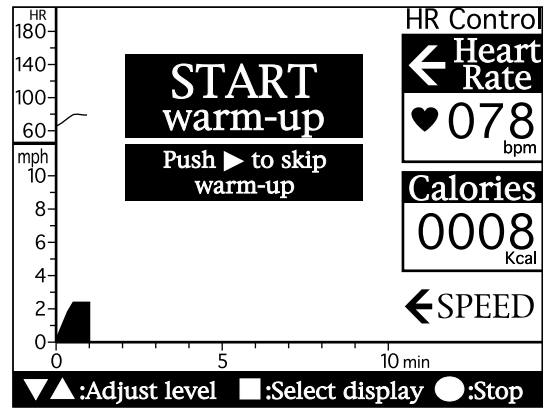
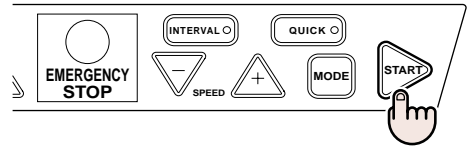

5 Finish your exercise.

- A buzzer will sound when the exercise time you set has elapsed. If you wish, you can continue training even after this buzzer sounds.
- Whenever you want to finish the exercise, before or after the buzzer sounds, press the STOP button.

The speed and incline drops to the minimum and the program comes to an end. The 5 minutes' cool-down starts.

- If you wish, you can continue training even after this buzzer sounds. During cool-down, the records, such as distance and calories consumed, will continue to be measured and displayed.
- If you do not need the 5 minutes' cool-down, it can be ended by pressing the STOP button.

Finishing exercising

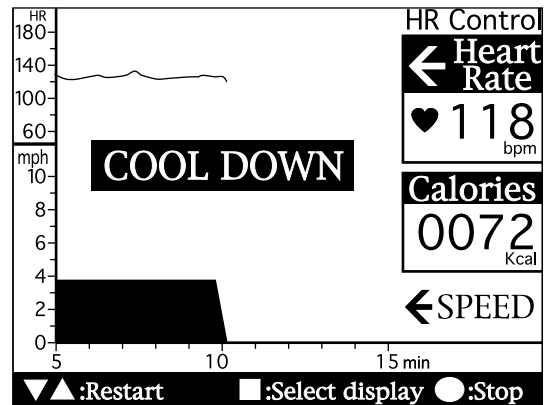
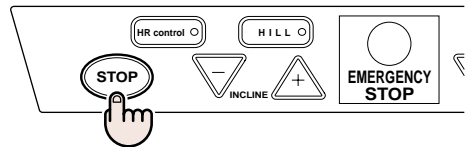

6 Check your exercise record by scrolling the screen.

- After cool-down you can check your exercise records for this session on the LCD. If your exercise time is 10 minutes or longer, press the SPEED or INCLINE +/- buttons to scroll the screen. You can use the +/- buttons to recall the data of past time frames. The - button will scroll the screen to the left and the + button to the right.
- After checking the exercise records, return to the initial screen by pressing the STOP button.

Scrolling screen

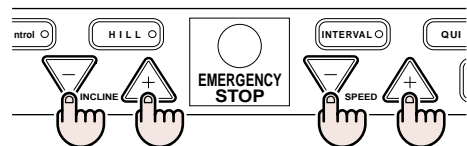

Ending program

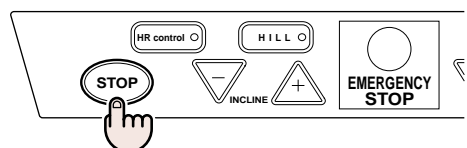

For further details about this product, proceed to the "Operation Guide" section once you are accustomed to using this unit.

OPERATION GUIDE

1	Training goals	22
2	Training program characteristics	24
3	HR control training	26
4	Interval training	28
5	Hill profile training	30
6	Quick start (manual training)	32
7	Making a Data Card	34



1 TRAINING GOALS

Training goals

- Do you feel out of breath after climbing up the stairs or after a brisk walk? While walking, running, or even sleeping, our body is taking in oxygen and generating energy. Oxygen taken in by the lungs is sent to the entire body via the circulatory system. If the function of the circulatory system, i.e. aerobic power, is insufficient, we may experience being "out of breath," or other physical problems.
- That's why we perform "health for the heart" (aerobic exercise), which causes the heart to work a little harder a few times a week, thus increasing the oxygen supply to the body via the circulatory system. The purpose of exercise with the EC-T220 is to improve both your physical condition and the function of the circulatory system - to improve your aerobic power.

Training plan

To effectively perform "health for the heart," it is necessary to find out the appropriate target pulse rate for your age and fitness level, and to exercise at a pulse rate close to that target. If the exercise intensity is beyond your current fitness level, you may damage your health, and if the exercise is below your target rate, you may not receive any benefit. The EC-T220 has 4 different types of exercise modes, including "HR control training," in which the incline is adjusted by the computer to keep your pulse rate close to your target.

How to determine your target pulse rate

- When you input your age, the EC-T220 automatically sets your target pulse rate by $[160 - \text{your age}]$. This target pulse rate corresponds to 50 - 60 % of the "exercise level" for people in their twenties, 40 - 50% for the forties and 30 - 40 % for the sixties. The older you are, the less intense the setting of your target pulse rate, according to the programming of the EC-T220. For a beginner, the exercise level automatically set by this unit could be too hard even for a young person. If you feel it is too hard, you can decrease the target pulse rate by 10 bpm from the original level. If you feel it is too easy, you can increase it by 10 bpm so that you can continue to exercise in the appropriate target zone, as shown in the illustration.
- At less than 30% of the exercise level, you can not exercise effectively. The desirable target pulse rate corresponds to 70% of the exercise level for people in their thirties or younger, 60-70% of the exercise level for the forties, 50-60% of the exercise level for the fifties, and 50% of the exercise level for people who are sixty or older.
- If you can continue your exercise at the target pulse rate of $[180 - \text{your age}]$, your exercise can be considered effective enough. Upgrade your exercise gradually so that you can reach the suggested final target of $[190 - \text{age}]$.

Exercise time for each session

- A minimum of 30 minutes of exercise is most effective for each session of exercise. A 5 minute warm up period, 20 minutes of exercise time, with a 5 minute cool-down period, is suggested for standard exercise.
- For weight-loss exercise, over 30 minutes exercise time at a comfortable level, with a 5-minute cool-down, is recommended.

Frequency of training

- A Minimum of two days of exercise a week is required just to maintain your present fitness level. With 3-4 days of exercise, you can expect improvement. Always consult with your doctor before proceeding with any exercise program. Concentrated and repeated exercise in a day may produce an adverse result.

For those who are confident of their exercises ability

- When an age which is younger than your actual age is selected, the target pulse rate calculated by the selected age can be set higher than that of your actual age. If the target pulse rate is raised according to the procedure above, the upper limit of the pulse rate is raised simultaneously. Be aware of your physical condition and start training.

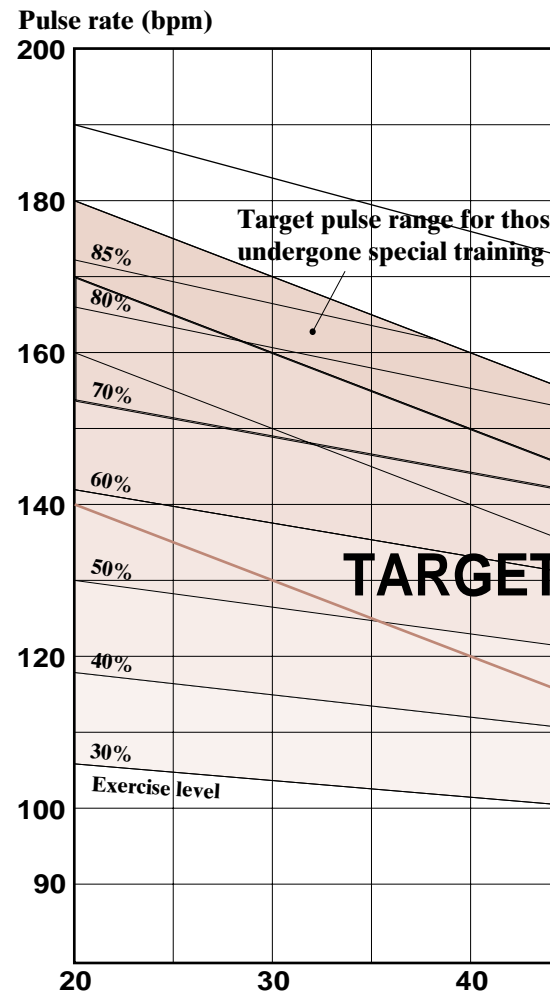

Target Pulse Rate Chart

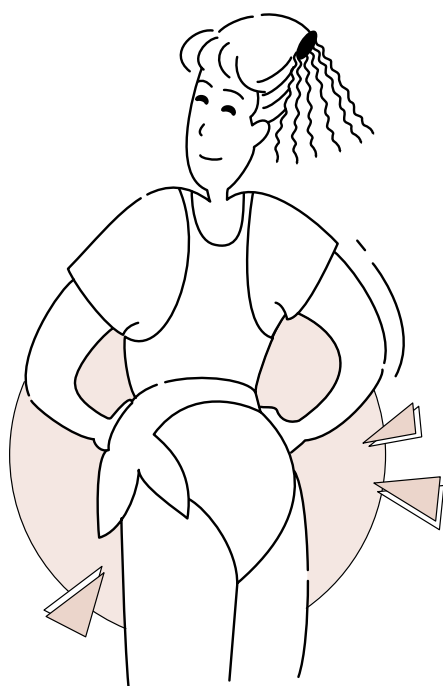
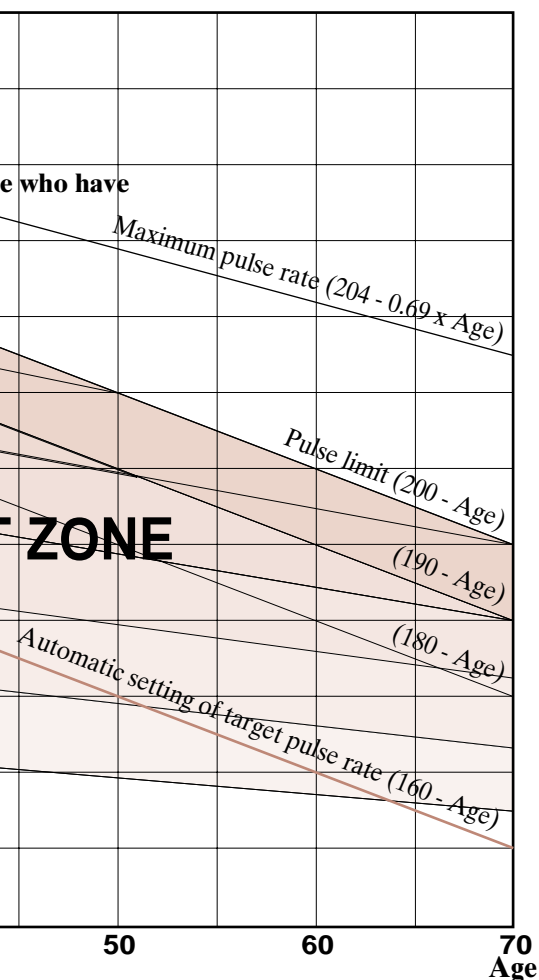

Terminology

Maximum Heart Rate

The heart rate increases according to the intensity of exercise, but there is a limit. The highest heart rate that a person can sustain is called the "maximum heart rate". Generally the maximum heart rate declines as we get older, however this differs between individuals, and is largely due to how much a person exercises.

The difference between heart rate and pulse rate

The heart rate is the number of heartbeats per minute measured by an electrocardiograph. On the other hand, the pulse rate is measured as follows.

- From the palpations of an artery near the skin surface, such as the carotid artery
- By passing a sensor light through an earlobe or fingertip, and measuring the pulse count via the subtle changes of the sensor light transmission caused by the heart beat

Although the measurement principle and method are different, both the heart and pulse rates have the same value per minute, and are therefore regarded as synonymous.

Pulse Limit

For the standard maximum heart rate, "220 - Age", "204 - 0.69 x Age", and other formulas are used. In the EC-T220, however, "200 - Age" is used, taking into account a certain safety margin, and is incorporated in the computer setting.

Target Pulse Rate

The pulse rate you should maintain during a workout is called the "target pulse rate". The automatic training program allows you to stay close to this target, but it is recommended that you always be conscious of your pulse rate, even when performing different types of training programs, by referring to the "Target Pulse Rate Chart". You can input a target pulse rate up to 85% of the maximum pulse rate.

Exercise Level Based on the Pulse Rate

Pulse rate increases according to the intensity of the exercise. In other words, the pulse rate during exercise is a measure for the exercise level. The exercise level can be expressed in percentages by using the following formula.

$$\text{Exercise level(\%)} = \frac{\text{Pulse rate during exercise} - \text{Pulse rate at rest}}{\text{Maximum heart rate} - \text{Pulse rate at rest}} \times 100$$

Therefore, if you want to determine the target exercise level (target pulse rate) from the pulse rate, you can calculate as follows.

$$\text{Target pulse rate} = (\text{maximum heart rate} - \text{pulse rate at rest}) \times \frac{\text{Exercise level(\%)}}{100} + \text{pulse rate at rest}$$

If you are a beginner, you can start the exercise with a target pulse rate of "160 - your age". If you can continue your exercise at the target pulse rate of "180 - your age," your exercise can be considered effective enough. Upgrade your exercise gradually so that you can reach the suggested final target of "190 - your age".

2 TRAINING PROGRAM CHARACTERISTICS

HR control training

- This training program is for exercising while maintaining a set pulse rate. The incline of the running belt will change automatically so that the set pulse rate is maintained. The speed can be adjusted however you like. If the chest-belt heart rate sensor cannot pick up your pulse rate, this program will not work.
- The exercise intensity is set by your target pulse rate (beats per minute = bpm). Select your target pulse rate from a lower position in the target zone for your age.
- If the target you select is difficult to achieve, reduce the target pulse rate by 10 bpm, and continue. Continuing is what is most important here. There is no reason to overdo it from the beginning.
- For those who are confident enough, the target pulse rate can be increased in 10 bpm increments. Refer to the target zone in the illustration on pages 22 and 23.
- The exercise time (alarm) is initially set for 20 minutes, but you can change it in 1-minute increments to any value in the range from 0 to 99 minutes. The current conditions on the LCD screen advance along the time scale once every 3 seconds. When 10 minutes is exceeded, the screen will scroll leftward by 5 minutes.
- Exercise per training session should be for at least 15 minutes. If possible, a 20 to 30 minute session is better.
- If weight control (burning calories) is the purpose of your exercise, set the target pulse rate lower so that you can exercise easily. However, extend your exercise time longer, preferably to over 30 minutes.

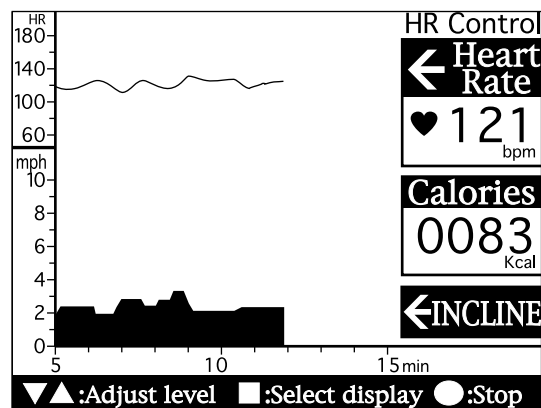

Hill profile training

- For this program, select the one of the three patterns that suits your needs. The incline is changed automatically depending on the shape of the mountain. The speed is not changed automatically, so you can adjust the speed however you like.
- The duration of one hill profile is 15 minutes. If your exercise time exceeds 15 minutes, the same hill profile will be repeated until the end of the session.
- Exercise per training session should be for at least 15 minutes. If possible, a 20 to 30 minute session is better.
- The exercise time (alarm) is initially set for 20 minutes, but you can change it in 1-minute increments to any value in the range from 0 to 99 minutes. The current conditions on the LCD screen advance along the time scale once every 3 seconds. When 10 minutes is exceeded, the screen will scroll leftward by 5 minutes.
- There may be those who choose to exercise beyond the pulse limit (200 - age) for their ages, depending on their training goals and physical conditions. If you choose to do so, use sufficient caution, and control your pulse rate.
- The incline is automatically changed to correspond to the shape of the hill profile. If needed, the incline can be further adjusted by pressing the INCLINE +/- buttons. Speed can be adjusted by pressing the SPEED +/- buttons. Maintain comfortable speeds to match the changing incline.

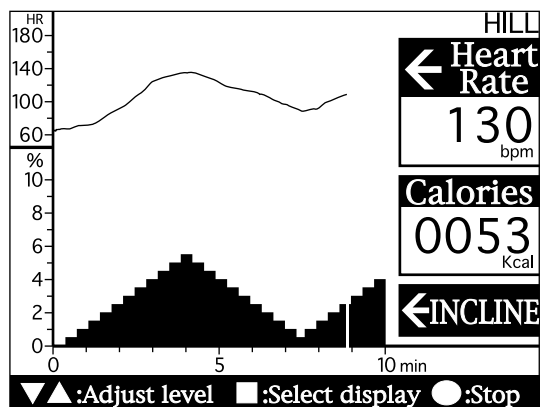

Interval training

- This program is intended for serious exercisers with training experience. This training automatically changes the speed between "exercise (maximum speed)" and "rest (minimum speed)." The incline does not change, so you can adjust the incline to suit your needs.
- Select one of the three patterns, depending on the training goal you are working for.
- This program is made up of repeated intervals of exercise (maximum speed) and rest (minimum speed). The rest speed is different depending on the pattern.

Pattern 1: Rest speed is 30% of exercise (maximum) speed.

Patterns 2, 3: Rest speed is 50% of exercise (maximum) speed.

- The incline can be adjusted by pressing the INCLINE +/- buttons. This program is hard training, so it is recommended that you try with zero incline at first.
- Exercise per training session should be for at least 15 minutes. If possible, a 20 to 30 minute session is better.
- The exercise time (alarm) is initially set for 20 minutes, but you can change it in 1-minute increments to any value in the range from 0 to 99 minutes. The current conditions on the LCD screen advance along the time scale once every 3 seconds. When 10 minutes is exceeded, the screen will scroll leftward by 5 minutes.
- There may be those who choose to exercise beyond the pulse limit (200 - age) for their ages, depending on their training goals and physical conditions. If you choose to do so, use sufficient caution, and control your pulse rate.
- The intensity of the training can be adjusted by changing the exercise (maximum) speed.

Caution: Although the speed can be adjusted when at rest (minimum) speed, this can sometimes result in the exercise (maximum) speed being increased to an unexpected high speed. The change of the speed should be kept small.

Quick start (manual training)

- This program is for basic treadmill training. By pressing the QUICK button, exercise begins at the lowest speed.
- This program is different from other training programs. In this program, the speed and incline are not pre-programmed; the speed and incline are adjusted by pressing the +/- buttons.
- Exercise per training session should be for at least 15 minutes. If possible, a 20 to 30 minutes exercise is better.
- Because the exercise time (alarm) is not set, you can end the program at any time. The current conditions on the LCD screen advance along the time scale once every 3 seconds. When 10 minutes is exceeded, the screen will scroll leftward by 5 minutes.
- There may be those who choose to exercise beyond the pulse limit (200 - age) for their ages, depending on their training goals and physical conditions. If you choose to do so, use sufficient caution, and control your pulse rate.

Checking your exercise record

After finishing your exercise, you can check the details (changes in speed, incline, and pulse rate) of your exercise on the LCD screen. If the exercise time exceeds 10 minutes, you can scroll the screen, by pressing either the INCLINE or SPEED +/- buttons, to view the details that are not shown on the screen.

- + button: Details that are concealed on the right side will appear
- - button: Details that are concealed on the left side will appear

Pressing the STOP button will end the program and erase the memory of your exercise.

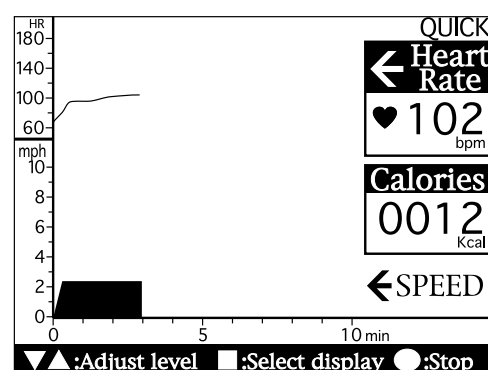
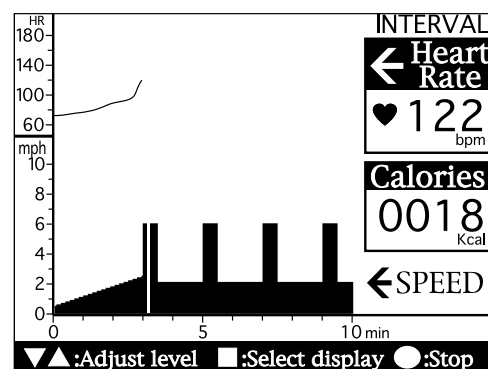

3

HR CONTROL TRAINING

1 Select the HR control training program.

- Put the chest-belt heart rate sensor around your chest. Press the HR control button to select the HR control training program.

Caution: If you do not put the chest-belt heart rate sensor around your chest, the HR control training cannot be performed.

2 Input training conditions.

- Input your age, target pulse rate, and exercise time in the above order on the LCD screen. The initial values, before anything has been input, are shown as in the illustration at right, with the initial age value displayed.

	Initial value	Setting range
Age	40 years	10 - 99 years
Exercise time	20 minutes	0 - 99 minutes
Target heart rate	120 bpm	60 - 189 bpm

The pulse rate upper limit is not displayed. Its initial value is 160 bpm, calculated by the formula "200 - age."

- The belt speed and incline pattern are not displayed on the LCD screen.
- The age input screen is displayed first.
- Figures can be adjusted by pressing the SPEED or INCLINE +/- buttons.
- Press the MODE button to proceed to the next screen.
- After inputting all the data, confirm the input data by pressing the MODE button.

Caution: If the START button is pressed during data input, exercise begins immediately and the belt will start moving.

Reference: You can start the exercise from any screen by pressing the START button.

3 Start the program.

- After the conditions have been input, get on the running belt and start the program by pressing the START button.
- The buzzer will sound and the running belt will start moving.

4 Start walking.

- The LCD screen displays "START WARMING-UP." Start walking, keeping pace with the speed of the belt.
- During the 3 minutes of warm-up, increase the speed by pressing the SPEED+ button, and try to bring your pulse rate close to the target.

Caution: During warm-up, you can adjust the speed to a maximum of 6.0 mph [9.6 km/h].

- The belt speed is shown on the lower part of the LCD screen. One dot on the horizontal axis represents 3 seconds of exercise time. One vertical dot represents 0.1 mph [0.1 km/h].
- Current pulse rate is displayed in the upper part of the LCD screen. One dot on the vertical axis represents 2 bpm.
- Every 3 seconds, a new row of dots will appear and blink on and off, showing the current training conditions.
- If the START button is pressed while warming-up, warm-up is skipped, and the warm-up display disappears. The program then begins to track the target pulse rate.

Selecting training program

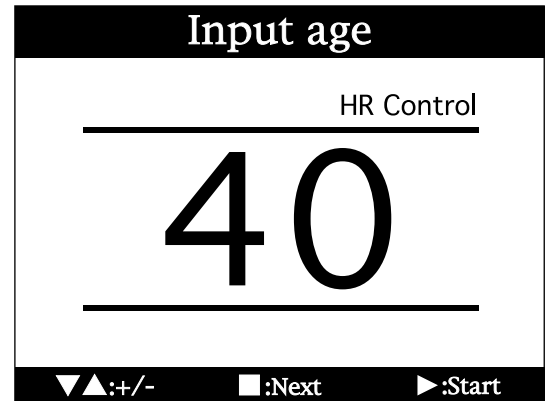
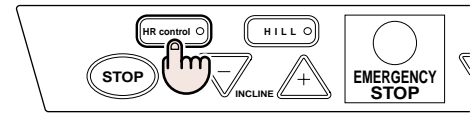

Increase or decrease of numbers

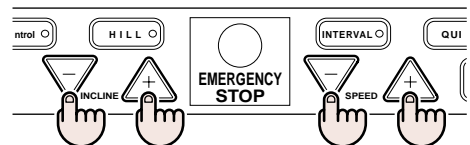

Changing item for input

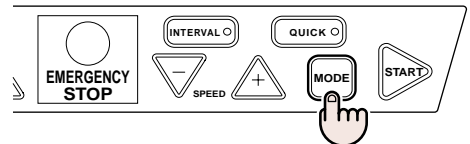

Starting program

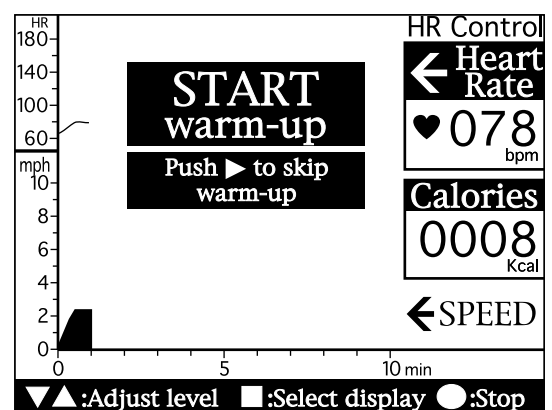
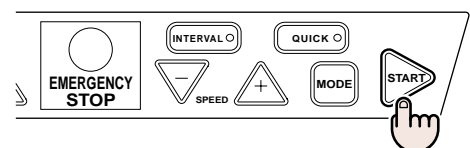

5

Perform training while maintaining the target heart rate.

- When the warm-up is completed and your pulse rate has reached the target pulse rate, the incline will be adjusted automatically according to your pulse rate, so you can train at your target pulse rate.
- The speed is not set automatically, so you can change the speed as you like by pressing the SPEED +/- buttons.
- By pressing the SPEED +/- buttons, you can change the exercise speed in 0.1 mph [0.1 km/h] increments in the range from 0.5 to 12 mph [1.0 to 18.0 km/h].
- You can switch from the incline display to the speed display screen by pressing the MODE button. One dot on the horizontal axis represents 3 seconds of exercise time, and 5 dots on the vertical axis represent 0.5% incline.

Caution: If at any time during the exercise, you cannot keep up with the belt speed, press the SPEED - button to lower the belt speed, and then continue training. If it is still too strenuous, press the EMERGENCY STOP button to end the training. When the EMERGENCY STOP button is pressed, the belt will quickly come to a stop, and the LCD screen will be returned to the initial screen. For safety reasons, the incline will remain at the current level when the machine is stopped by the EMERGENCY STOP button.

Reference: Only 10 minutes of data can be displayed on the LCD screen at one time. If the exercise time exceeds 10 minutes, the screen will scroll to the right, and the current position will be moved to the center.

6

Finish your training.

- The buzzer will sound at the specified time. However you can continue training if you wish.
- Pressing the STOP button will end your training and begin cool-down. The speed and incline will be reduced to the minimum.

Reference: If the STOP button is pressed by mistake, the program can be restarted by pressing the START button. When the program is restarted, both the incline and speed will be the minimums. So the speed should be increased to your desired level by pressing the SPEED + button.

- To cool down, continue to exercise. The distance and time data on the numerical display, and the calories-consumed data on the LCD display, will continue to be updated. The belt will automatically stop after 5 minutes, and the screen will be changed to the scrolling screen. The belt can be stopped immediately and the screen changed to the scrolling screen by pressing the STOP button at any time during the 5-minute cool-down.

Caution: The screen cannot be changed from the scrolling screen back to the cool-down screen or the exercise screen.

- You can see your exercise record on the scrolling screen by pressing either the SPEED or INCLINE +/- buttons.

7

End the program.

- Pressing the STOP button will return you to the initial screen.
- If you are completely finished with your exercise session, be sure to turn off the power switch on the front part of the main body.

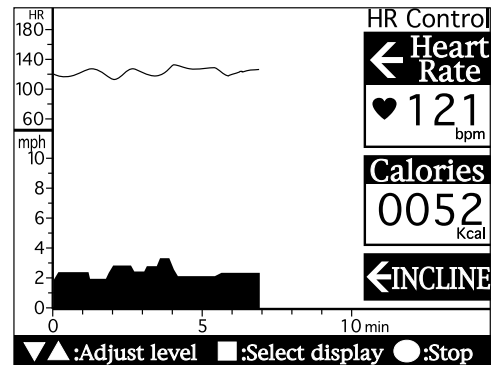

Changing the display

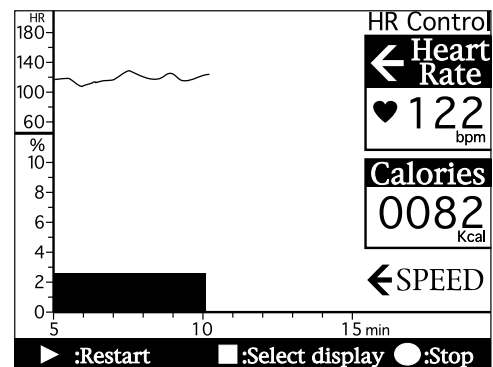
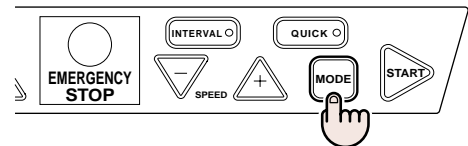

Finishing training

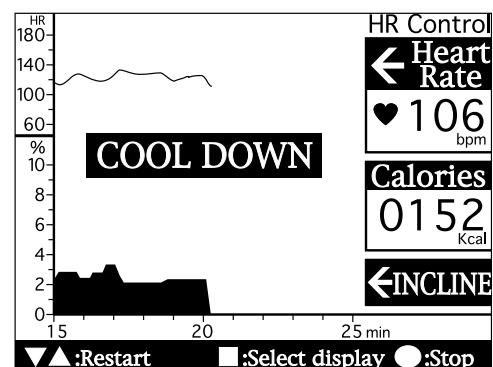
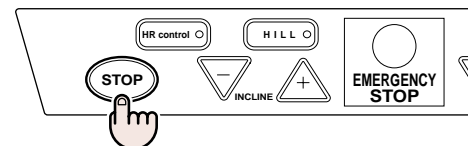

Ending program

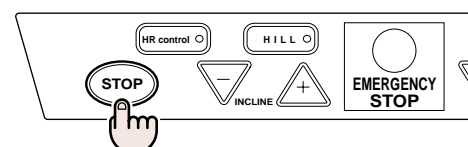

4

INTERVAL TRAINING

1 Select the Interval training program.

- Put the chest-belt sensor around your chest. Press the INTERVAL button to select the program.

Caution: Interval training can be done without the chest-belt heart rate sensor. However it can be dangerous. Therefore it is recommended that you put it on in order to monitor your pulse rate while exercising.

2 Input training conditions.

- Input the exercise pattern and exercise time in order on the LCD screen. If nothing is input, the initial values as shown below are displayed.

	Initial Value	Setting Range
Exercise pattern	1	1 - 3
Exercise time	20 minutes	0 - 99 minutes

Exercise patterns

PRF1: Dash strength training 15 seconds of exercise with 45 seconds of rest

PRF2: Speed training 30 seconds of exercise with 30 seconds of rest

PRF3: Stamina training 45 seconds of exercise with 15 seconds of rest



- The belt speed for each training pattern will be displayed in the lower part of the LCD screen.
- The training pattern input screen will be displayed first.
- Input the data by pressing the SPEED or INCLINE +/- buttons.
- You can proceed to the next input screen by pressing the MODE button.
- After all the data has been input, and the MODE button is pressed again, a screen appears for you to confirm the data you have input.

Caution: If the START button is pressed during data input, exercise begins immediately and the belt starts moving.

Reference: You can begin your exercise at any time during data input by pressing the START button.

3 Start the program.

- After all the conditions have been input, get on the running belt and start the program by pressing the START button.
- The buzzer will sound and the running belt will start moving.

4 Start walking.

- The LCD screen displays "START WARMING-UP." Start walking, keeping pace with the speed of the belt.
- During the 3-minute warm-up period, the belt speed will increase automatically to prepare you for interval training. If the speed is too slow for you, increase the speed by pressing the SPEED + button.

Caution: During warm-up, you can adjust the speed to a maximum of 6.0 mph [9.6 km/h].

- The belt speed is shown on the lower part of the LCD screen. One dot on the horizontal axis represents 3 seconds of exercise time. One vertical dot represents 0.1 mph [0.1 km/h].
- Current pulse rate is displayed in the upper part of the LCD screen. One dot on the vertical axis represents 2 bpm.
- Every 3 seconds, a new row of dots will appear and blink on and off, showing the current training conditions.
- If the START button is pressed while warming-up, warm-up is skipped. The warm-up display disappears, and interval training begins. The start time may be different depending on when the START button is pressed.
 - 0 - 59 seconds: interval training begins 1 minute after start.
 - 1 min - 1 min 59 secs: interval training begins 2 minutes after start.
 - 2 mins - 2 mins 59 secs: interval training begins 3 minutes after start.
- You can switch from the speed display to the incline display screen by pressing the MODE button. One dot on the horizontal axis represents 3 seconds of exercise time. One dot on the vertical axis represents 0.1 mph [0.1 km/h].

Selecting training program

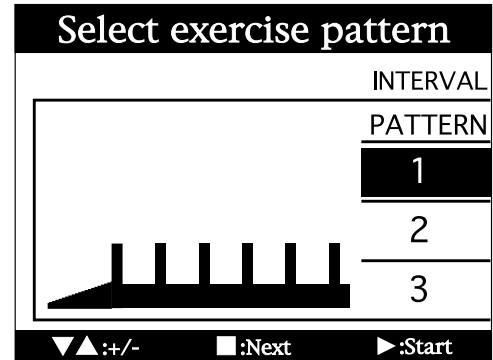
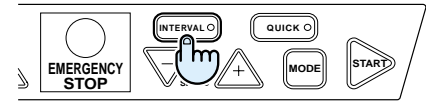

Increase or decrease of numbers

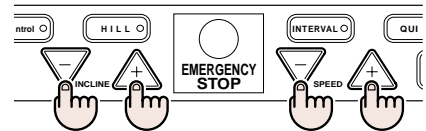

Changing item for input

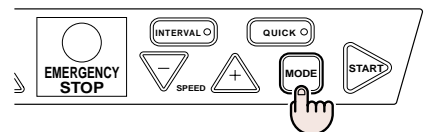

Starting program

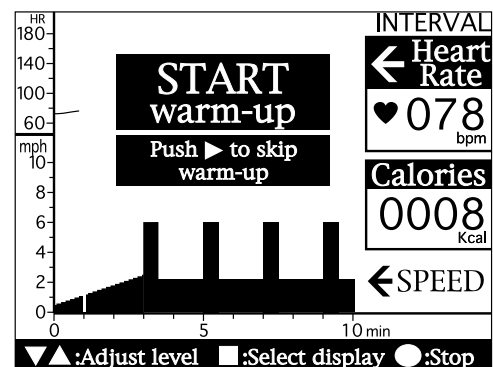
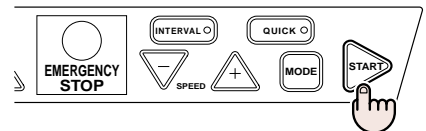

Switching display

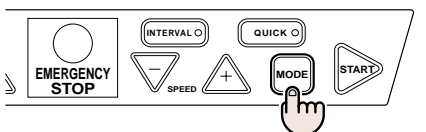

5

Continue the training by repeating "exercise" and "rest."

- The belt speed will change in cycles according to the training pattern. The incline is not changed automatically.
- The belt speed will be fast during "exercise (maximum speed)" and slow during "rest (minimum speed)."
- By pressing the SPEED +/- buttons, you can change the exercise speed in 0.1 mph [0.1 km/h] increments in the range from 0.5 to 12 mph [1.0 to 18.0 km/h].

Caution: Although the speed can be adjusted when at rest (minimum) speed, this can sometimes result in the exercise (maximum) speed being increased to an unexpected high speed. The change of the speed should be kept small.

- By pressing the INCLINE +/- button, you can change the incline in 0.5% increments in the range from 0 - 12%. Select your desired incline.

Caution: If at any time during the exercise, you cannot keep up with the belt speed, press the SPEED - button to lower the belt speed, and then continue training. If it is still too strenuous, press the EMERGENCY STOP button to end the training. When the EMERGENCY STOP button is pressed, the belt will quickly come to a stop, and the LCD screen will be returned to the initial screen. For safety reasons, the incline will remain at the current level when the machine is stopped by the EMERGENCY STOP button.

Reference: Only 10 minutes of data can be displayed on the LCD screen at one time. If the exercise time exceeds 10 minutes, the screen will scroll to the right, and the current position will be moved to the center.

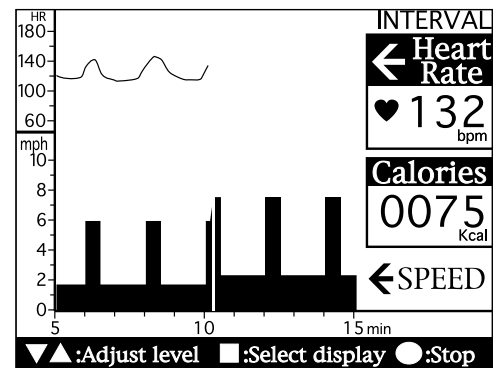

Increase or decrease of speed

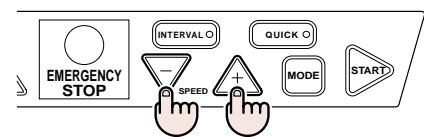

Increase or decrease of incline

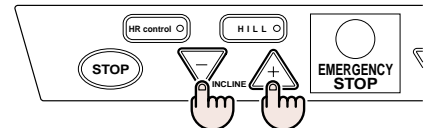

Finishing training

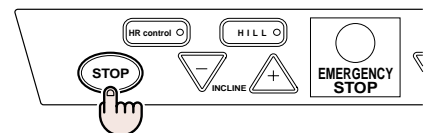

6

Finish your training.

- The buzzer will sound at the specified time. However you can continue training if you wish.
- Pressing the STOP button will end your training and begin cool-down. The speed and incline will be reduced to the minimum.

Reference: If the STOP button is pressed by mistake, the program can be restarted by pressing the START button. When the program is restarted, both the speed and incline will be the minimums. So the incline should be increased to your desired level by pressing the INCLINE + button.

- To cool down, continue to exercise. The distance and time data on the numerical display, and the calories-consumed data on the LCD display, will continue to be updated. The belt will automatically stop after 5 minutes, and the screen will be changed to the scrolling screen. The belt can be stopped immediately and screen changed to the scrolling screen by pressing the STOP button at any time during the 5-minute cool-down.

Caution: The screen cannot be changed from the scrolling screen back to the cool-down screen or the excise screen.

- The records of speed and pulse rate on the LCD can be scrolled by pressing the SPEED or INCLINE +/- buttons.

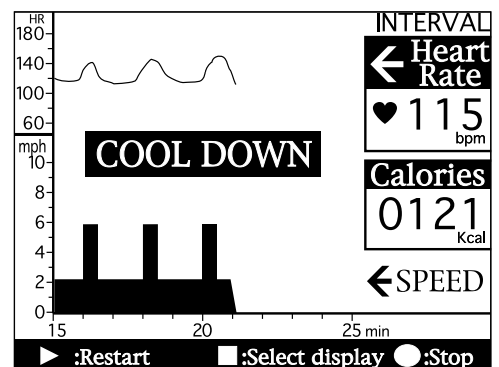

Ending program

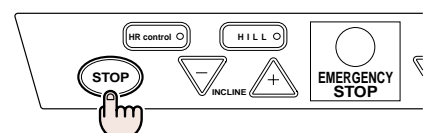

7

End the program.

- Pressing the STOP button will return you to the initial screen.
- If you are completely finished with your exercise session, be sure to turn off the power switch on the front part of the main body.

1 Select the Hill profile training program.

- Put on the chest-belt heart rate sensor and press the HILL button to select the program.

Caution: Hill profile training can be done without the chest-belt heart rate sensor. However it can be dangerous. Therefore it is recommended that you put it on in order to monitor your pulse rate while exercising.

2 Input training conditions.

- Input the exercise pattern and exercise time in order on the LCD screen. If nothing is input, the initial values as shown below are displayed.

	Initial Value	Setting Range
Exercise pattern	1	1 - 3
Exercise time	20 minutes	0 - 99 minutes

Exercise patterns

PRF1: Rockies PRF2: Cascades PRF3: Pyrenees



- The belt speed for each training pattern will be displayed in the lower part of the LCD.
- The exercise pattern input screen will be displayed first.
- Input the data by pressing the SPEED or INCLINE +/- buttons to increase or decrease the numbers.
- You can proceed to the next input screen by pressing the MODE button.
- After all the data has been input, and the MODE button is pressed again, a screen appears for you to confirm the data you have input.

Caution: If the START button is pressed during data input, exercise begins immediately and the belt starts moving.

Reference: You can begin your exercise at any time during data input by pressing the START button.

3 Start the program.

- After all the conditions have been input, get on the running belt and start the program by pressing the START button.
- The buzzer will sound and the belt will start moving.

4 Start walking.

- The hill pattern is displayed on the LCD screen. Start walking, keeping pace with the speed of the belt.

Reference: Warm-up function is not available for Hill profile training.

- Increase the belt speed to the desired level by pressing the SPEED + button.
 - The incline is shown on the lower part of the LCD. One dot on the horizontal axis represents 3 seconds of exercise time. 5 dots on the vertical axis represent 0.5% incline.
 - Current pulse rate is displayed in the upper part of the LCD, one dot on the vertical axis represents 2 bpm.
 - Every 3 seconds, a new row of dots will appear and blink on and off, showing the current training conditions.
- You can switch from the incline display to the speed display screen by pressing the MODE button. One dot on the horizontal axis represents 3 seconds of exercise time. One dot on the vertical axis represents 0.1 mph [0.1 km/h].

Selecting training program

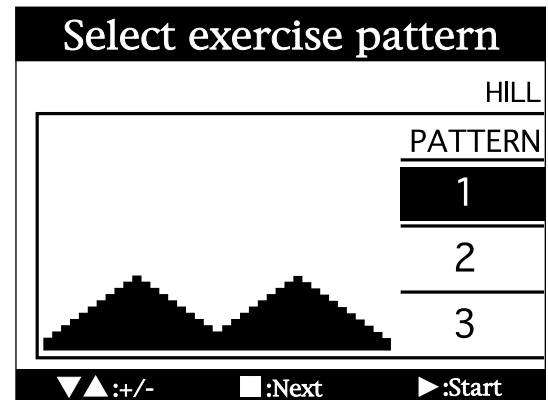
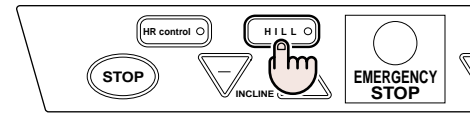

Increase or decrease of numbers

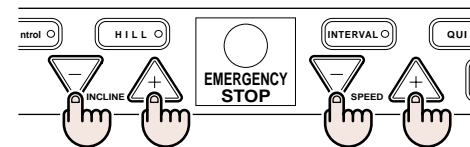

Changing item for input

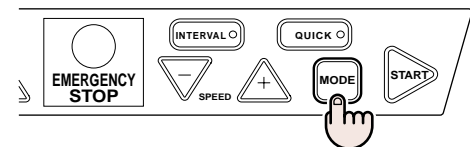

Starting program

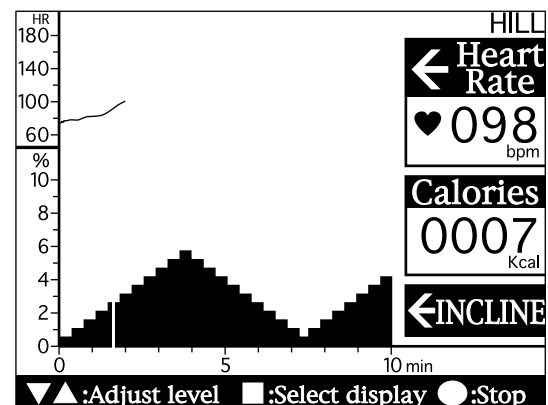
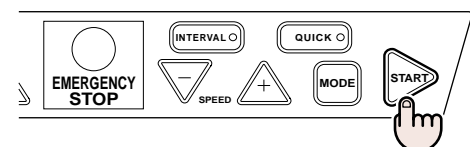

Switching display

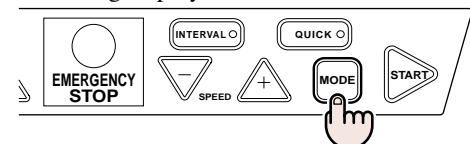

5

Continue the training.

- The incline will change automatically according to the training pattern. The speed is not changed automatically.
- The incline will become steeper as you come close to the top of a hill, and it will be gentler in the lower areas.
- By pressing the SPEED +/- buttons, you can change your exercise speed in 0.1 mph [0.1 km/h] increments in the range from 0.5 to 12 mph [1.0 to 18.0 km/h].
- By pressing the INCLINE +/- buttons, you can change the incline in 0.5% increments to change the shape of the hill pattern. The display of the hills not yet climbed will be altered to reflect this change.
- One hill pattern is set for 15 minutes. If your exercise time exceeds 15 minutes, the same hill shapes will repeat to match the training time.

Caution: If at any time during the exercise, you cannot keep up with the belt speed, press the SPEED - button to lower the belt speed, and then continue training. If it is still too strenuous, press the EMERGENCY STOP button to end the training. When the EMERGENCY STOP button is pressed, the belt will quickly come to a stop, and the LCD screen will be returned to the initial screen. For safety reasons, the incline will remain at the current level when the machine is stopped by the EMERGENCY STOP button.

Reference: Only 10 minutes of data can be displayed on the LCD screen at one time. If the exercise time exceeds 10 minutes, the screen will scroll to the right, and the current position will be moved to the center.

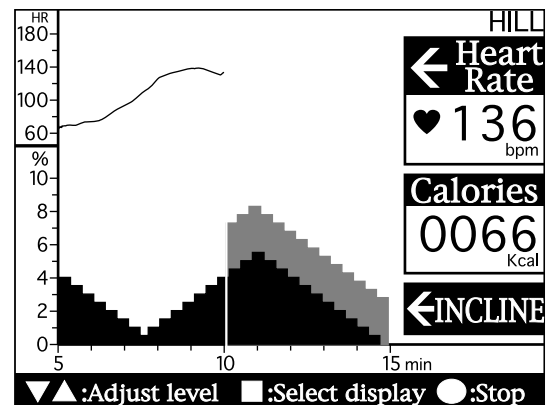

Increase or decrease of speed

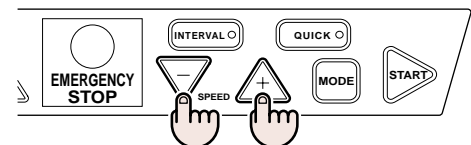

Increase or decrease of incline

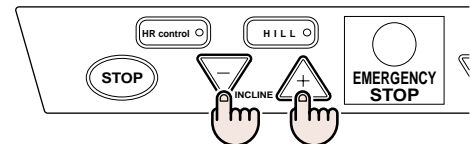

Finishing training

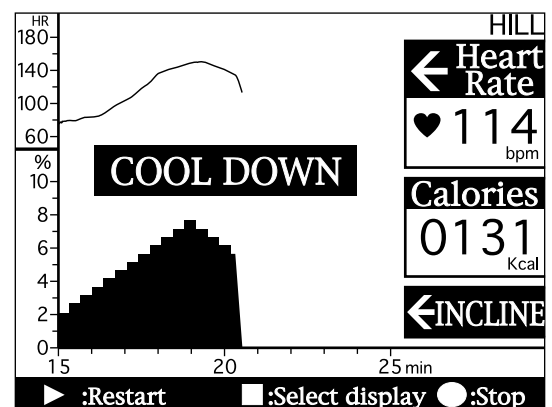
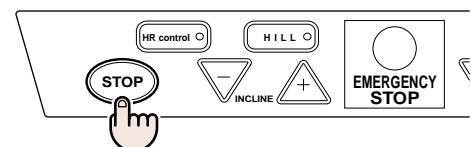

Ending program

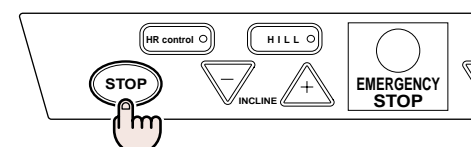

6

Finish your training.

- The buzzer will sound at the specified time. However you can continue training if you wish.
- Pressing the STOP button will end your training and begin cool-down. The speed and incline will be reduced to the minimum.

Reference: If the STOP button is pressed by mistake, the program can be restarted by pressing the START button. When the program is restarted, both the incline and speed will be the minimums. So the speed should be increased to your desired level by pressing the SPEED + button.

- To cool down, continue to exercise. The distance and time data on the numerical display, and the calories consumed data on the LCD display, will continue to be updated. The belt will automatically stop after 5 minutes, and the screen will be changed to the scrolling screen. The belt can be stopped immediately and screen changed to the scrolling screen by pressing the STOP button at any time during the 5-minute cool-down.

Caution: The screen cannot be changed from the scrolling screen back to the cool-down screen or the exercise screen.

- The records of speed and pulse rate on the LCD can be scrolled by pressing the SPEED or INCLINE +/- buttons.

7

End the program.

- Pressing the STOP button will return you to the initial screen.
- If you are completely finished with your exercise session, be sure to turn off the power switch on the front part of the main body.

6

QUICK START (MANUAL TRAINING)



- **Quick start can be done without the chest-belt heart rate sensor. However it can be dangerous. Therefore it is recommended that you put it on in order to monitor your pulse rate while exercising.**
- **When the QUICK on the training selection button is pressed, the belt will begin to move immediately.**

1 Select the Quick start program and start walking.

- Put the chest-belt heart rate sensor around your chest. Press the QUICK button to select the quick start program.
- The buzzer will sound and the belt will start moving.
- The screen will change to the quick start screen. Start walking, keeping pace with the speed of the belt.

Caution: Warm-up function is not available for quick start (manual training).

- Increase the speed and incline to the desired levels by pressing the SPEED + and INCLINE + buttons.
- By pressing the SPEED +/- buttons, you can change the exercise speed in 0.1 mph [0.1 km/h] increments in the range from 0.5 to 12 mph [1.0 to 18.0 km/h].
- By pressing the INCLINE +/- button, you can change the incline in 0.5% increments in the range from 0 - 12%.
 - The speed is shown on the lower part of the LCD screen. One dot on the horizontal axis represents 3 seconds of exercise time. One dot on the vertical axis represents 0.1 mph [0.1 km/h].
 - Current pulse rate is displayed in the upper part of the LCD screen. One dot on the vertical axis represents 2 bpm.
 - Every 3 seconds, a new row of dots will appear and blink on and off, showing the current training conditions.
- You can switch from the speed display to the incline display screen by pressing the MODE button. 5 dots on the vertical axis represent 0.5% incline.

Caution: If at any time during the exercise, you cannot keep up with the belt speed, press the SPEED - button to lower the belt speed, and then continue training. If it is still too strenuous, press the EMERGENCY STOP button to end the training. When the EMERGENCY STOP button is pressed, the belt will quickly come to a stop, and the LCD screen will be returned to the initial screen. For safety reasons, the incline will remain at the current level when the machine is stopped by the EMERGENCY STOP button.

Reference: Only 10 minutes of data can be displayed on the LCD screen at one time. If the exercise time exceeds 10 minutes, the screen will scroll to the right, and the current position will be moved to the center.

Selecting training program

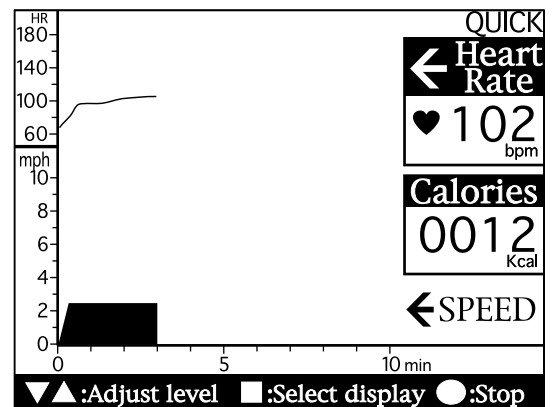
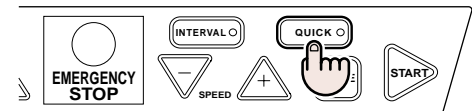

Increase or decrease of speed

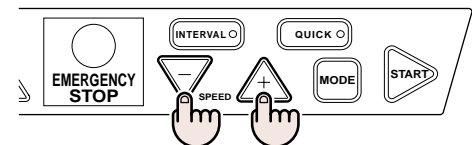

Increase or decrease of incline

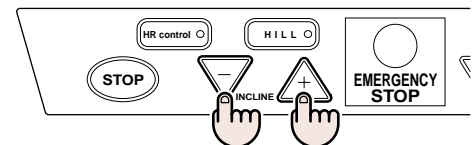

Switching display

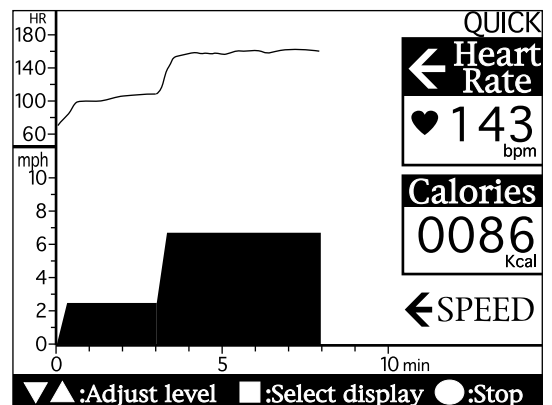
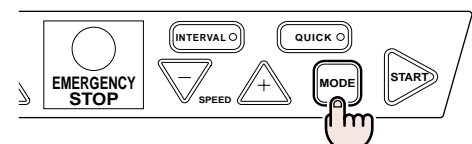

2

Finish your training.

- Press the STOP button when you want to finish. Your training will be stopped, and cool-down will begin. The speed and incline will be reduced to the minimums.

Reference: • Alarm (buzzer) function is not available for quick start.

- If the STOP button is pressed by mistake, the program can be restarted by pressing the START button. When the program is restarted, both the incline and speed will be the minimums. So the speed should be increased to your desired level by pressing the SPEED + button.
- To cool down, continue to exercise. The distance and time data on the numerical display, and the calories consumed data on the LCD display, will continue to be updated. The belt will automatically stop after 5 minutes, and the screen will be changed to the scrolling screen. The belt can be stopped immediately and screen changed to the scrolling screen by pressing the STOP button at any time during the 5-minute cool-down.

Caution: The screen cannot be changed from the scrolling screen back to the cool-down screen or the exercise screen.

- The records of speed and pulse rate on the LCD can be scrolled by pressing the SPEED or INCLINE +/- buttons.

3

End the program.

- Pressing the STOP button will return you to the initial screen.
- If you are completely finished with your exercise session, be sure to turn off the power switch on the front part of the main body.

Finishing training

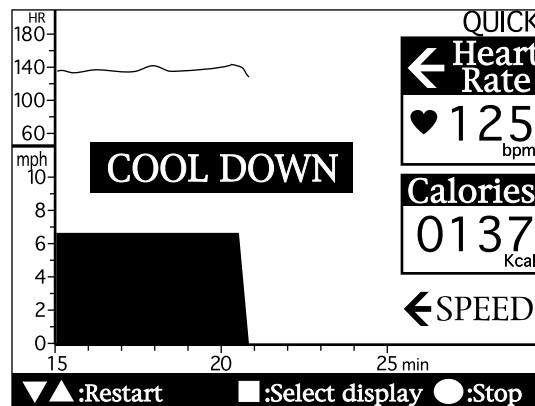
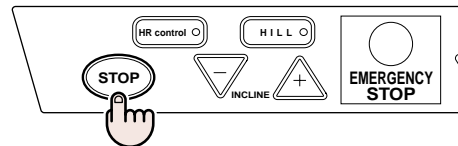

Ending program

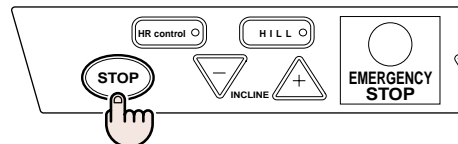

7

MAKING A DATA CARD

If you record your training conditions on this data card, you can set your training conditions by simply inserting the card into the card slot of the control unit.

You can start a program just by inserting the card, confirming your data, and pressing the START button.

To record your training conditions on the data card, use a coin or similar object to scratch off the silver parts in the appropriate positions on the back of the card. The optical sensor in the control unit will detect the exposed positions. Now, try making your own data card.

- Caution:**
- One data card is necessary for each set of training conditions. You cannot record more than one set of conditions on one card.
 - Each data card is covered with a protective film. After you have registered all of your training conditions, remove this film.
 - A data card cannot be used for quick start.

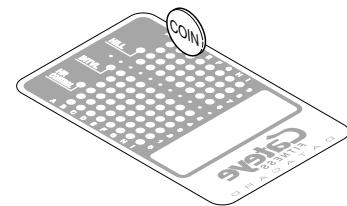
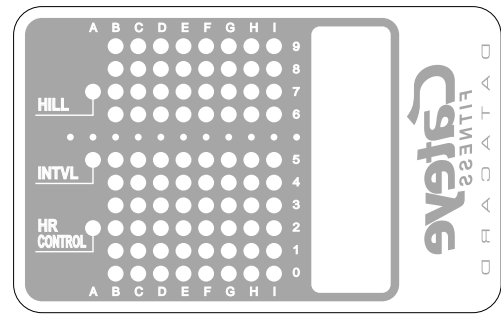

1 Select a program.

- In column A, select the desired program.

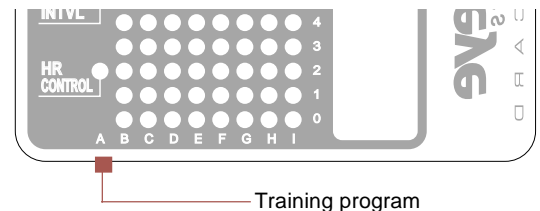

2 Indicate your age. (For HR control training only)

- Indicate your age in columns B and C.
- Column B is for the first digit of your age (tens' digit), and column C for the second digit (ones' digit).

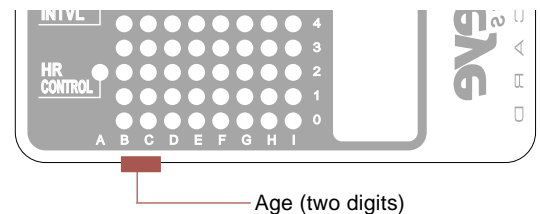

3 Specify the exercise time (alarm). (For all training modes)

- Specify the number of minutes of exercise time in columns D and E.
- Column D is for the first digit of the exercise time (tens' digit), and column E for the second (ones' digit).

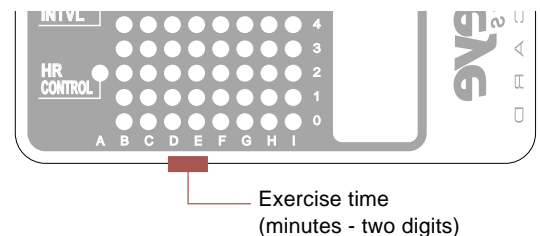

4 Select the training pattern. (For Hill profile training and Interval training)

- Select the desired training pattern in column F. The content of this column is different depending on the training program.

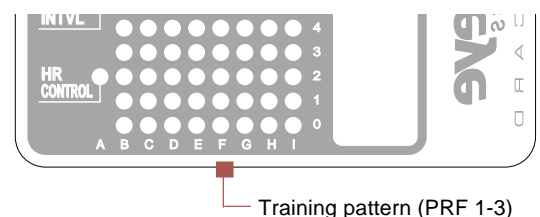

5

Indicate your target pulse rate. (For HR control training only)

Specify the training target in columns G, H and I.
G is for the first digit of the value (hundreds' column), H for the second digit (tens' column), and I for the third digit (ones' column).

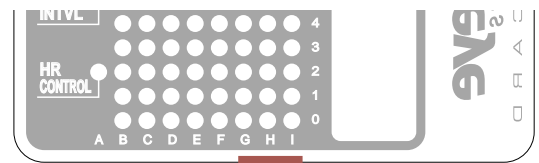

Target pulse rate
(bpm - 3 digits)

Sample data cards

HR control training

Age: 28 years
Exercise time: 35 minutes
Target pulse rate: 130 bpm

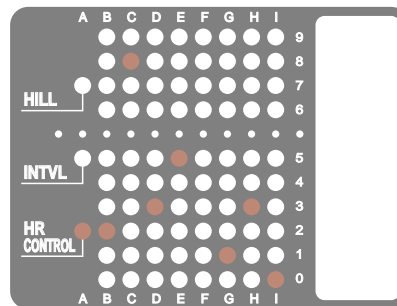

Interval training

Exercise time: 15 minutes
Training pattern: PRF 2

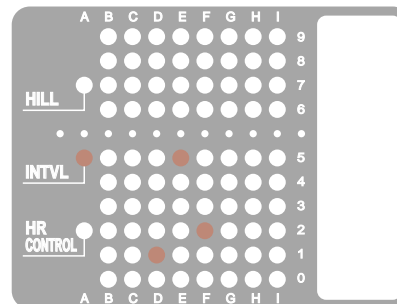

Hill profile training

Exercise time: 25 minutes
Training pattern: PRF 3

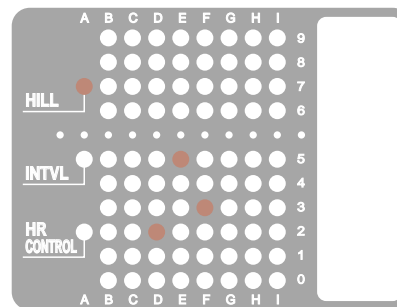

Cautions on Handling the Data Card

- Caution:**
- Treat the card with care. Do not bend the card. Do not allow the card to become wet.
 - Scratch off only the appropriate silver parts on the back of the card. If other parts have been scratched off, the sensor will not be able to read the data.
 - Wipe any remaining scraps of the scratched-off silver ink from the card before inserting the card into the control unit.
 - The blank memo space on the card can be used as to record the user's data, name, etc.
 - If "CARD ERROR" appears on the screen when the card is inserted, check whether any incorrect or unnecessary parts have been scratched off.
- If you have scratched off an area by mistake, use typing correction fluid (white-out) to cover the transparent space. Hold the card up to the light. If light doesn't pass through the space that you have covered up, the card can be used normally.

REFERENCE GUIDE

1	Maintenance of the chest-belt heart rate sensor	38
2	Other useful functions	39
3	Troubleshooting	40
4	Handling warnings	41
5	Repair service warranty/additional parts	42
6	Product specifications	43



Warning

After removing the battery from the sensor, dispose of it properly. Be sure to keep it out of the reach of small children. If through some accident it is swallowed, contact a physician immediately.

Replacing the battery

Battery life: approx. 2 years (if used for 1 hour per day)

* The battery life shown in this manual is not definitive and it varies depending on the use environment.

- Caution:**
- **The chest-belt heart rate sensor continues to consume battery while being attached to your body. When you are not measuring heart rate, remove it from your chest to save the battery life.**
 - **The battery cover seal is critical for maintaining its watertight capacity. Check the battery cover for proper fit and positioning closing.**

When the factory loaded battery has worn out, replace it with a new one according to the following instruction:

1. Remove the battery cover on the back of the transmitter with a coin.
2. Remove the battery and insert a new lithium battery (CR2032). Insert as shown in the picture, so that the + side is visible.
3. Close the battery cover tightly.

Replacing the electrode belt

The electrode belt will deteriorate after a long time of use. If there are cracks in the outer surface, or if measurement errors occur, follow the procedure below to change the electrode belt.

1. Loosen the 4 screws at the back of the transmitter.
2. Remove the spacers. Separate the transmitter from the electrode belt.
3. Wipe any dirt off of the two conducting parts of the transmitter, then insert it into a new electrode belt.

Caution: If there is dirt on the conducting parts, the heart rate sensor fail to detect the heart rate.

4. Fit the spacers on the right and left sides of the transmitter, and securely tighten the 4 screws.

Reference: When replacing the electrode belt, also check the transmitter's battery life.

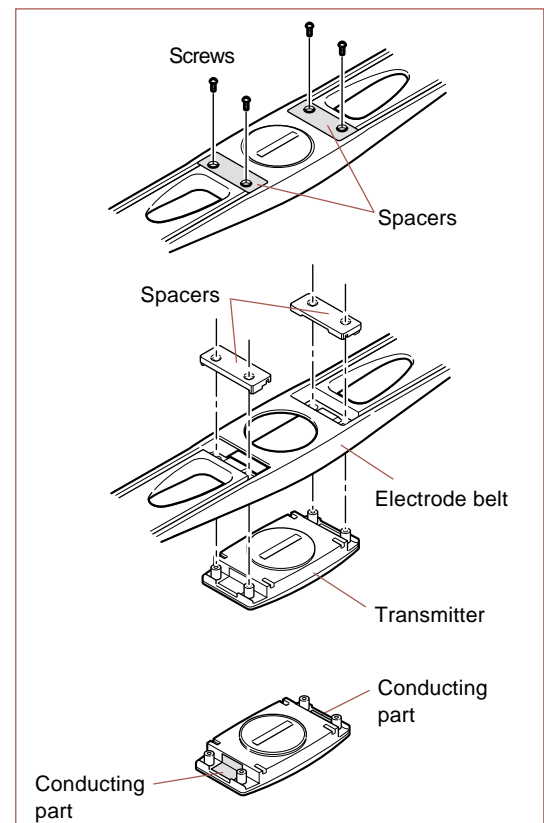
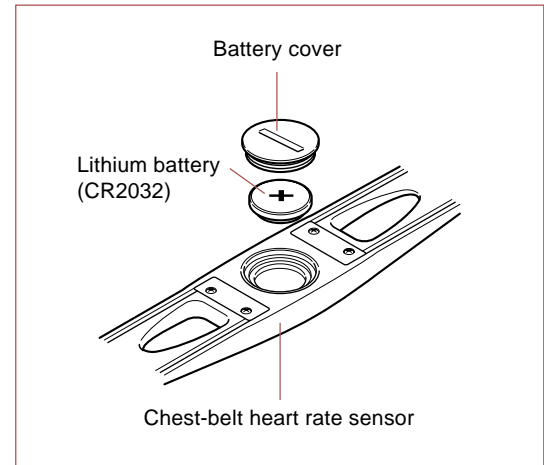

Maintenance of the chest-belt heart rate sensor

For daily maintenance of the sensor:

- If the chest-belt heart rate sensor is dirty, wash with water, or wipe with a diluted neutral detergent and a soft cloth. Then wipe it dry. Do not use organic solvents such as benzene and alcohol, which will damage the surface.
- The attachment belt will become particularly soaked with sweat. This can be unhygienic if left as is. Clean the belt with a neutral detergent.

2 OTHER USEFUL FUNCTIONS

Checking the total distances

The total distances which can be used as a guide for when to change the running belt can be checked.

- Press and hold the SPEED + button and the INCLINE + button together for 3 seconds to change to the total distance check display. The distance display will show the total distance traveled up until that time.

After checking the total distance, press the EMERGENCY STOP button to return to the initial screen.

Changing the language

- As mentioned on page 10 of the "Start Guide," the language can be changed from English to French, Spanish, or Japanese (or German) by the dip switches inside the control unit.
- For English specifications, the no. 1 and no. 2 switch of dip switch 2 (SW2) is ON, and all the others are OFF.
- Switches no. 3 and no. 4 are not used.
- After changing the dip switch settings, turn the power off and back on again for the change in settings to take effect.

Dip switch 2 (SW2)

No.1: ON	No. 2: ON	English
No.1: ON	No. 2: OFF	French
No.1: OFF	No. 2: ON	Japanese
		[German: 220V]
No.1: OFF	No. 2: OFF	Spanish

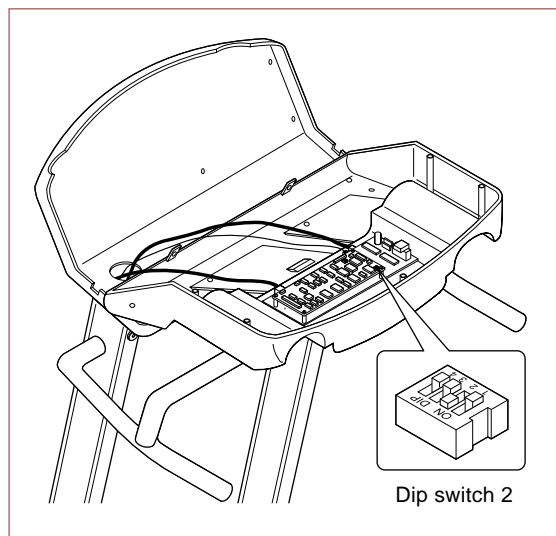

Switching between mph display and km/h display

- As mentioned on page 10 of the "Start Guide," the display can be switched between mph and km/h by the dip switches inside the control unit.
- When the no. 4 switch of dip switch 1 (SW1) is OFF, the display units are mph. When the no. 4 switch is turned ON, the display units are changed to km/h.
- Switches no. 1, no. 2, and no. 3 are not used.
- After changing the dip switch settings, turn the power off and back on again for the change in settings to take effect.

Dip switch 1 (SW1)

No. 4: ON	km/h
No. 4: OFF	mph

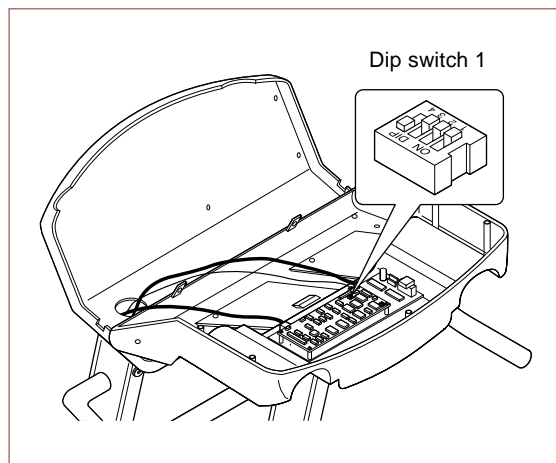

Setting the Safety Key Function

- As mentioned on page 10 of the "Start Guide," open the control unit and change the settings.
- When the no. 1 switch of dip switch 1 (SW1) is ON, the safety function is activated. When the no. 1 switch is turned OFF, the function is canceled.
- Switches no. 2, no. 3, and no. 4 are not used.
- After changing the dip switch settings, turn the power off and back on again for the change in settings to take effect.

Dip switch 1 (SW1)

No. 1: ON	Safety key function activated
No. 1: OFF	Safety key function canceled

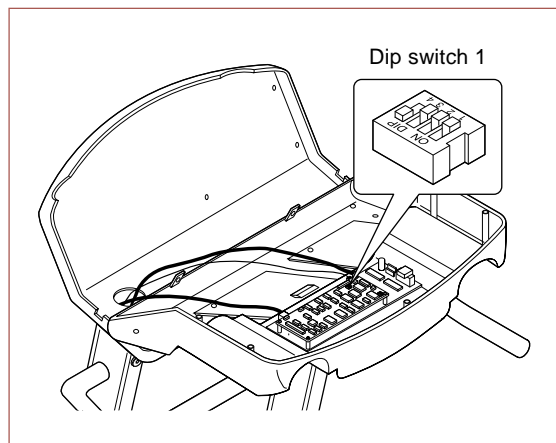

3

TROUBLESHOOTING

Troubleshooting

In the following cases, the machine is not broken. Be sure to check the following before asking for the machine to be serviced.

Trouble	Check items	Action
The LCD screen is completely blank.	Is the power source connected?	Check that the plug is inserted into an outlet.
	Is the power switch ON?	Turn the power switch ON.
	Are the cords all plugged in correctly?	Correctly connect all cords to the circuit board under the motor cover.
	Has the safety key function been activated?	Insert the safety key or card.
	Has the circuit breaker been tripped?	Next to the power switch on the front of the main unit there is a button for recovery when the breaker has been tripped. Press this button.
The data card is inserted, but nothing appears except "CARD ERROR" or strange displays.	Has the card been inserted correctly?	Insert the card slowly with the arrow on the card facing upward and in the direction indicated by the arrow.
	Were multiple programs selected? Or some unnecessary parts scratched off?	Refer to page 34. Be sure to record the data correctly.
The pulse rate is not measured. It shows only zero.	Has the chest-belt heart rate sensor been put on correctly?	Refer to page 12. Be sure the chest-belt heart rate sensor is worn properly.
The pulse rate is abnormally high.	Has the sensor's battery power run out?	Refer to page 38. Replace the chest-belt heart rate sensor battery.
	Is the distance too far for the receiver to detect?	Reception becomes poor when the distance from the control unit exceeds 80 centimeters. Exercise within an arm's reach distance from the control unit.
	Has the electrode belt been damaged?	Refer to page 38. Replace the electrode belt.
The screen display (language) is strange.	Are the dip switches in the wrong position?	Refer to page 39. Check the positions of the dip switches inside the control unit.
The exercise stops in the middle of HR control training.	During training, was the pulse rate upper limit exceeded and the pulse alarm function activated?	When the pulse rate upper limit has been exceeded, the machine decides that the pulse rate has reached a dangerous level. The safety mechanism automatically reduces speed and incline to the minimum levels. If this happens, rest for a while.
	Was your age and pulse rate upper limit input correctly?	Correctly set the age and pulse rate upper limit. Avoid reaching an unnecessarily high pulse rate.
The running belt is too close to one side or the other; or the running belt is rubbing against the side.	Has the belt-adjustment been done?	Refer to page 10. Adjust the belt so the balance between the left and right sides is improved.
The running belt moves abnormally.	Are two or more electric appliances connected to the power outlet?	This has happened due to a power voltage failure. Use a power socket directly, for example one on the wall. Never use multiple plugs in a single socket.

4

HANDLING WARNINGS

Handling warnings

Please observe the following to ensure that you will have many years of good use from your EC-T220 treadmill.



Caution

- **Do not disassemble the control unit or main body. If there is a problem, contact your dealer where the unit was purchased.**
- **Avoid using in locations with high temperature or high humidity, or in locations where it may get wet.**
- **Handle the power cable with care. If the cord is pulled, the connection may be severed.**
- **Connect the power plug directly to a power socket, for example one on the wall. If two or more machines are connected using an extension cord, etc, a power voltage failure may occur and the machine may not operate properly.**
- **When not using the machine, be sure to turn the power switch off and remove the plug from the outlet.**
- **If the running belt is rubbing against the side, the belt will wear more quickly. Adjust the running belt before use.**
- **Do not use paint thinner, kerosene, gasoline, alcohol, or other organic solvents to clean the main unit. For cleaning, wipe with a cloth and neutral detergent. Then dry well by rubbing with a dry cloth.**
- **Avoid placing in a location which receives direct sunlight.**

About the repair service warranty

- If trouble with this EC-T220 treadmill due to material of manufacturing defect should occur, under normal usage conditions, within one year from the date of purchase, Cat Eye Co., Ltd. will repair or replace the product/part, subject to the contents of the included warranty card.
- If service is necessary, please contact your dealer where the unit was purchased.
- Only the control unit and main body are covered by the warranty. The chest-belt heart rate sensor and other accessory items are not covered.

Accessories/Consumable Parts

Data cards (10 cards)
(Part no. 0298200)

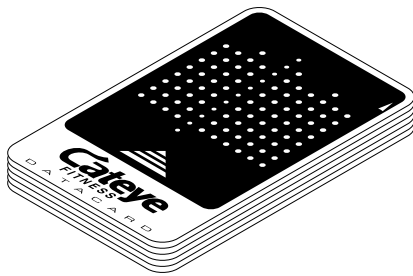

Chest-belt heart rate sensor (1699806)

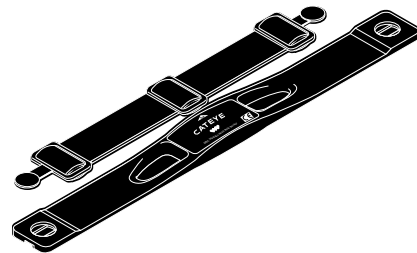

Replacement electrode belt
(1699826)

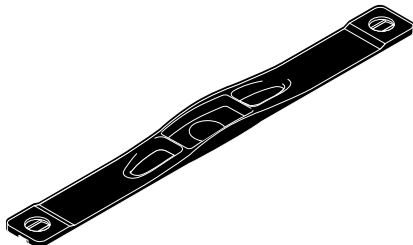

Mounting belt (1699816)

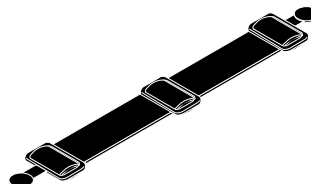

Lithium battery CR2032
(1665150)





PRODUCT SPECIFICATIONS

Item	Specification			
Power source	Home AC Power (For commercial use, dedicated circuit only) 115 volts 20 amps (for the 100V-120V area) 230 volta 10 amps (for the 220V-240V area)			
Power consumption	Max. approx. 1200 W			
Motor	2.5 hp Continuous Duty DC (Baldor) With Built-In Fun-Cooling System			
Display system	LCD screen	320 x 240 Full Dot Type Backlight LCD		
	Numeric display	Green LED display		
Display functions	LCD screen		Display range	
	Pulse Rate	Displayed in broken line graph Numeric display	60 - 180 bpm 0 (35) - 199 bpm	
	Calorie consumption	Numeric display	0 - 999 kcal (Estimated value)	
	Speed	Displayed in bar graph (the bar of the latest time section blinking)	0.5 - 12.0 mph [1.0 - 18.0 km/h]	
	Incline	Displayed in bar graph (the bar of the latest time section blinking)	0 - 12.0 %	
	Operation prompting	Displays instruction messages after each button operation		
	Other function	LCD screen can be scrolled back and forth after exercise.		
	Numeric display screen			
	Incline	0 - 12.0 % (0.5 %)		
	Speed	0.5 - 12 mph (0.1 mph) [1.0 - 18.0 km/h (0.1 km/h)]		
Elapse Time	0 - 99 min 59 sec			
Distance	0 - 99.99 mile [km]			
Data input System	Data card (Use specified cards only) and buttons			
Pulse Monitor	Chest Belt Type (Polar Compatible)			
Emergency System	1: Push Button			
	2: Safety key (Active/Cancel which can be selected with the dip switch)			
Exercise Programs	Program	Specifications		
	Quick Start (manual training)	Exercise under a constant speed and incline		
	Hill profile training	Auto adjustable for incline (3 Patterns)		
	Interval training	Auto adjustable for speed (3 Patterns)		
	HR control training	Exercise under a constant pulse rate	Program setting range:	MaxHR/55 - 85 %
		Upper pulse limit alarm:	Buzzer beeps and speed is reduced to the minimum.	
Alarm function	Signal for setting time			
Buzzer sound	Confirmation of button function, signal for starting the exercise			
Weight Capacity	400 lbs [180 kg]			
Measurement	Depth	80 inches [2031 mm]		
	Width	34-1/3 inches [872 mm]		
	Height	57-2/3 inches [1466 mm]		
	Running Area (W x L)	20 x 60 inches [510 x 1520 mm]		
	Weight	265 lbs [120 kg]		
Parts specifications	Motor	2.5 hp Continuous Duty DC (Baldor) With Built-In Fun-Cooling System		
	Cushion	8 pcs Cushions to absolute impact		
	Running Belt	1 inch Prewaxed Phenolic Mode		
	Belt Area	Siegling Cool-2-Ply Urethane High Conductivity		
	Roller	Crowed Roller & Guides		
	Elevation	0 - 12.0 % Grade Thrust Motor. Push Button.		
	Handlebars	Frame & Side Bars (Cateye Original)		
	Bottle Holder	2 x 1.5 L Water Bottle		

Copyright© 2000
Cateye Co., Ltd.
Printed in Japan
ECMET22-010226-2

Design Pat. Pending

* The specifications and design are subject to alteration without notice for improvement purpose.

** "CATEYE" is registered trademarks of CAT EYE CO., LTD.



CATEYE CO., LTD.

2-8-25, Kuwazu, Higashi Sumiyoshi-ku, OSAKA, 546-0041 JAPAN
PHONE: 81-6-6719-7781 FAX: 81-6-6719-2362

CE

066660011 (E)

Free Manuals Download Website

<http://myh66.com>

<http://usermanuals.us>

<http://www.somanuals.com>

<http://www.4manuals.cc>

<http://www.manual-lib.com>

<http://www.404manual.com>

<http://www.luxmanual.com>

<http://aubethermostatmanual.com>

Golf course search by state

<http://golfingnear.com>

Email search by domain

<http://emailbydomain.com>

Auto manuals search

<http://auto.somanuals.com>

TV manuals search

<http://tv.somanuals.com>