



CELESTRON



NexStar™ 4

INSTRUCTION MANUAL

INTRODUCTION	4
WARNING.....	4
QUICK SETUP	5
ASSEMBLY	8
ASSEMBLING THE NEXSTAR.....	8
<i>Powering the NexStar</i>	8
<i>The Hand Control</i>	9
<i>The Eyepiece</i>	9
<i>The Star Pointer Finderscope</i>	10
NEXSTAR HC MODEL	12
THE HAND CONTROL	12
<i>Rate Button</i>	13
<i>Utility Features</i>	13
<i>GuideStar Software</i>	14
NEXSTAR GT MODEL.....	15
HAND CONTROL OPERATION	16
<i>Alignment Procedure</i>	16
OBJECT CATALOG	18
<i>Selecting an Object</i>	18
<i>Slewing to an Object</i>	18
<i>Tour Mode</i>	19
DIRECTION BUTTONS	19
<i>Rate Button</i>	19
SETUP PROCEDURES.....	20
<i>Tracking Mode</i>	20
<i>Tracking Rate</i>	20
<i>Date/Time</i>	21
<i>User Defined Objects</i>	21
<i>Get RA/DEC</i>	21
<i>Get Alt-Az</i>	21
<i>Goto R.A/Dec</i>	21
<i>Goto Alt-Az</i>	22
UTILITY FEATURES	22
<i>Cord Wrap</i>	22
<i>Anti-backlash</i>	22
<i>Model Select</i>	22
<i>Hand Control Command Tree</i>	23
TELESCOPE BASICS	24
IMAGE ORIENTATION	24
FOCUSING	25
CALCULATING MAGNIFICATION.....	25
DETERMINING FIELD OF VIEW	25
GENERAL OBSERVING HINTS	26
ASTRONOMY BASICS.....	27
THE CELESTIAL COORDINATE SYSTEM	27
MOTION OF THE STARS	28

POLAR ALIGNMENT (WITH OPTIONAL WEDGE)	29
<i>Photography with the NexStar 4</i>	30
<i>Finding the North Celestial Pole</i>	31
CELESTIAL OBSERVING.....	32
OBSERVING THE MOON	32
OBSERVING THE PLANETS	32
OBSERVING THE SUN.....	33
OBSERVING DEEP SKY OBJECTS	33
SEEING CONDITIONS	33
<i>Transparency</i>	33
<i>Sky Illumination</i>	33
<i>Seeing</i>	34
TELESCOPE MAINTENANCE	35
CARE AND CLEANING OF THE OPTICS	35
OPTIONAL ACCESSORIES	36
APPENDIX A - TECHNICAL SPECIFICATIONS.....	39
APPENDIX B - GLOSSARY OF TERMS	40
APPENDIX C – MAPS OF TIME ZONES	43
SKY MAPS.....	45



Congratulations on your purchase of the Celestron NexStar! The NexStar ushers in a whole new generation of computer automated technology. Simple and friendly to use, the NexStar is up and running after locating just two alignment stars. It's the perfect combination of power and portability. If you are new to astronomy, you may wish to start off by using the NexStar's built-in Sky Tour feature, which commands the NexStar to find the most interesting objects in the sky and automatically slews to each one. Or if you are an experienced amateur, you will appreciate the comprehensive database of over 4,000 objects, including customized lists of all the best deep-sky objects, bright double stars and variable stars. No matter at what level you are starting out, the NexStar will unfold for you and your friends all the wonders of the Universe.

Some of the many standard features of the NexStar include:

- Incredible 4°/second slew speed.
- Fully enclosed motors and optical encoders for position location.
- Integrated hand controller – built into the side of the fork arm.
- Storage for programmable user defined objects; and

Many other high performance features!

The NexStar's deluxe features combine with Celestron's legendary optics to give amateur astronomers one of the most sophisticated and easy to use telescopes available on the market today.

Take time to read through this manual before embarking on your journey through the Universe. It may take a few observing sessions to become familiar with your NexStar, so you should keep this manual handy until you have fully mastered your telescope's operation. The NexStar hand control has built-in instructions to guide you through all the alignment procedures needed to have the telescope up and running in minutes. Use this manual in conjunction with the on-screen instructions provided by the hand control. The manual gives detailed information regarding each step as well as needed reference material and helpful hints guaranteed to make your observing experience as simple and pleasurable as possible.

Your NexStar telescope is designed to give you years of fun and rewarding observations. However, there are a few things to consider before using your telescope that will ensure your safety and protect your equipment.

Warning

- ❑ **Never look directly at the sun with the naked eye or with a telescope (unless you have the proper solar filter). Permanent and irreversible eye damage may result.**
- ❑ Never use your telescope to project an image of the sun onto any surface. Internal heat build-up can damage the telescope and any accessories attached to it.
- ❑ Never use an eyepiece solar filter or a Herschel wedge. Internal heat build-up inside the telescope can cause these devices to crack or break, allowing unfiltered sunlight to pass through to the eye.
- ❑ Never leave the telescope unsupervised, either when children are present or adults who may not be familiar with the correct operating procedures of your telescope.

CELESTRON® Quick Setup

1



Remove the NexStar from its packaging and place the base on a sturdy, level surface. Remove the accessories from their individual boxes.

2

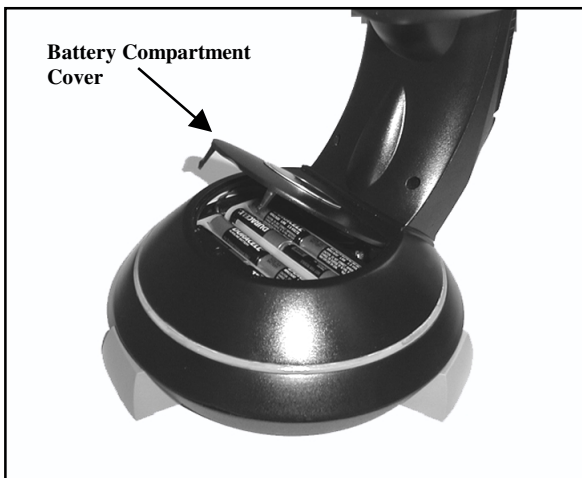

Rotate the tube so it is level with the ground. Lift the battery compartment cover to install batteries. Power the NexStar using the switch next to the 12v outlet at the base of the fork arm.

3

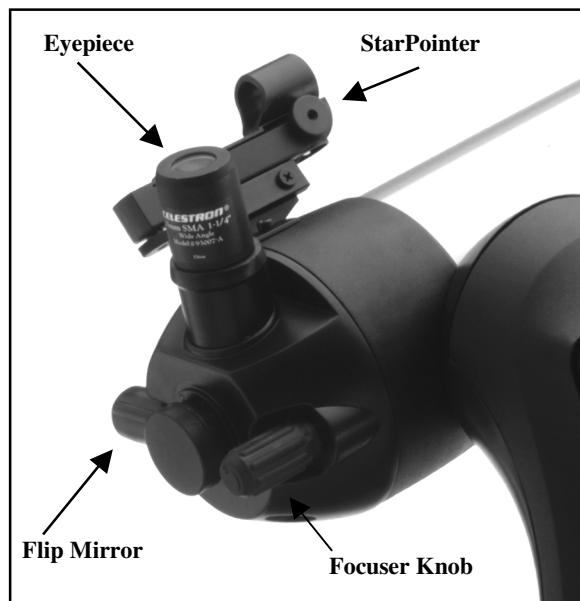

Attach the included accessories (eyepiece and StarPointer finderscope) and remove the front lens cover. Turn-on the Star Pointer by rotating the dial on the side. (For instructions on aligning the Star Pointer see the *Assembly* section of the manual).

4



Once powered on, the display will read *NexStar Ready*. Press ENTER to *AutoAlign* the NexStar. The hand control display will ask you to move the telescope tube so that it is level with the ground and facing the north horizon. Use the UP and Down arrow buttons to position the telescope North and level. (See *Astronomy Basics* for help on finding North). The first time the NexStar is powered-on, you may be prompted to select your telescope model. If so, see the section on hand control operation for instruction.

5

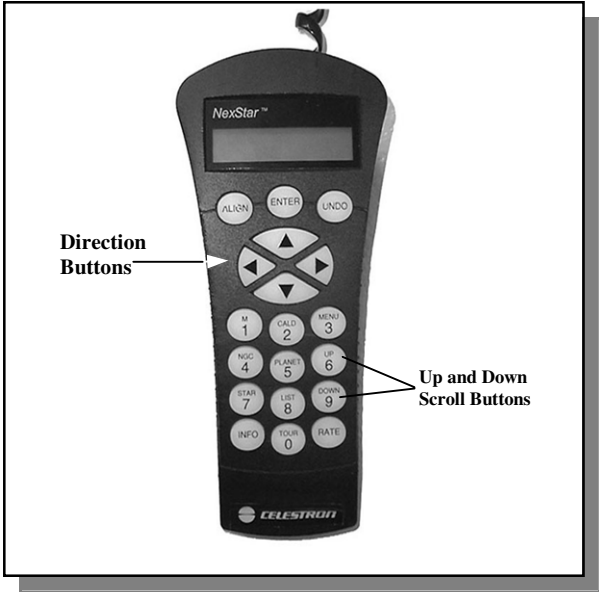

Input the necessary date and time information as instructed by the hand control. Press ENTER after each entry. The NexStar will also ask for time zone and location information. Use the UP and Down scroll buttons to select from the various options, pressing ENTER after each selection. (See *Hand Control* section for detailed alignment procedures).

7

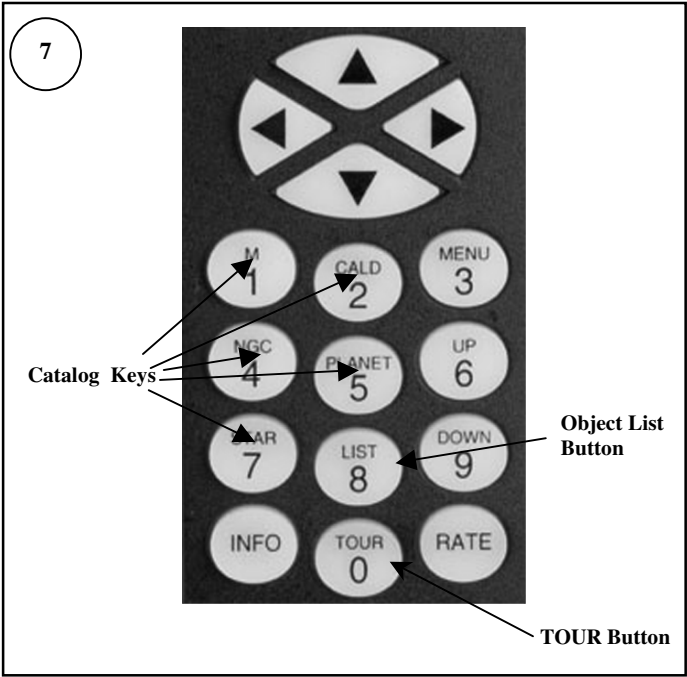

Press the TOUR button on the hand control. The hand control will display a list of objects that are visible for the date and location entered. Press INFO to read information about the object displayed. Press the DOWN scroll key to display the next object. Press ENTER to slew to (go to) the displayed object.

6

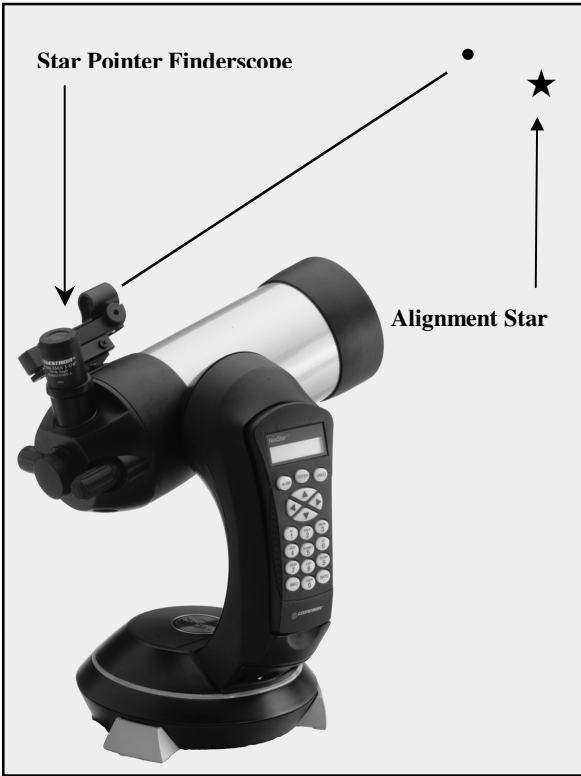

The NexStar will automatically pick an alignment star and slew the telescope close to that star. Once there, the display will ask you to use the arrow buttons to aim the Star Pointer at the star. If the star is not visible (perhaps behind a tree), press UNDO to select a new star. Next, center the star in the eyepiece and press ALIGN. Repeat these steps for the second star alignment. When complete, display will read "Alignment Successful".



1	Optical Tube	6	Focuser Knob
2	Liquid Crystal Display	7	Straight Through Photographic Adapter
3	Hand Control	8	Flip Mirror Control
4	ON/OFF Switch	9	Eyepiece
5	Battery Compartment	10	Star Pointer Finderscope



The NexStar 4 comes completely pre-assembled and can be operational in a matter of minutes. The NexStar is conveniently packaged in one reusable shipping carton that contains all of the following accessories:

- 25mm SMA Eyepiece – 1¼"
- Star Pointer Finderscope and Mounting Bracket
- *The Sky*® for Celestron Astronomy Software

Assembling the NexStar

Start by removing the telescope from its shipping carton and setting the round base on a flat table or surface. It is best to carry the telescope by holding it from the lower portion of the fork arm and from the bottom of the base. Remove all of the accessories from their individual boxes. Remember to save all of the containers so that they can be used to transport the telescope. Before the batteries can be installed, the telescope tube should be positioned horizontal to the ground. To do this, gently rotate the front of the tube upwards until it is level with the ground.

Powering the NexStar

The NexStar can be powered by eight AA batteries (not included), an optional 12v AC adapter or an optional car battery adapter. The battery compartment is located in the center of the telescope's base (see figure 3-1).

To power the NexStar with batteries:

1. Remove the battery cover from the center of the base by gently lifting up on the round portion of the cover.
2. Insert the batteries into the battery compartment of the base.
3. Reattach the battery compartment door by gently pushing down on the cover until it snaps into place.
4. Turn on the power to the NexStar by flipping the switch, located at the base of the fork arm, to the "On" position.

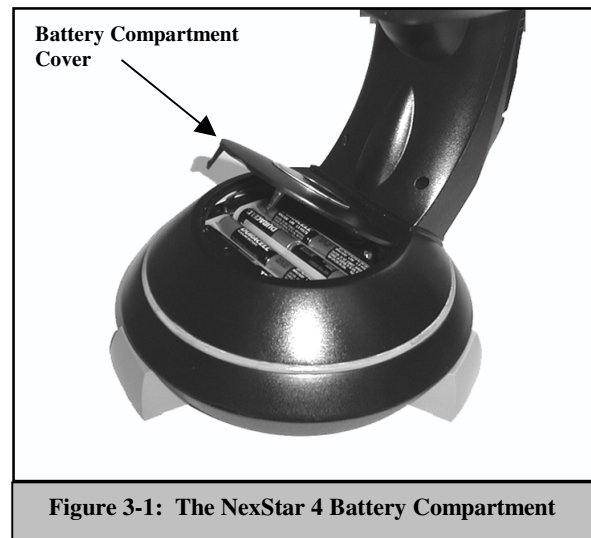

Figure 3-1: The NexStar 4 Battery Compartment

The Hand Control

The hand control is located on the side of the fork arm and can be removed and used remotely or used while attached to the fork. The hand control attaches to the fork arm by resting on two posts, located on the bottom of the hand control cradle, and a clip inside the fork arm. To remove the hand control from the fork arm cradle, gently lift the hand control upwards and pull out. To return the hand control into the fork arm, lower the hand control into the cradle so that the two holes in the bottom of the hand control go over the posts on the bottom of the cradle, and the opening in the back of the hand control slides over the clip inside the fork arm.

Once the telescope is powered up, the hand control can be used to move the optical tube in altitude (up and down) and azimuth (side to side).

- Press UNDO (for GT model only). This will bypass the normal alignment procedures and will still allow you to control the telescope.
- Use the Up arrow directional button to move the telescope tube until it is roughly parallel to the ground. This will make it more convenient to attach the necessary accessories as well as remove the front lens cover and install batteries when they are needed.

You are now ready to attach the included visual accessories onto the telescope optical tube.

The Eyepiece

The eyepiece, or ocular, is the optical element that magnifies the image focused by the telescope. The NexStar 4 has an internal diagonal mirror that diverts light to the eyepiece barrel on top of the telescope's rear cell. The eyepiece fits into the barrel built-in to the rear cell. To install the eyepiece:

1. Loosen the thumbscrew on the eyepiece barrel so it does not obstruct the inner diameter of the barrel.
2. Slide the chrome portion of the eyepiece into the eyepiece barrel.
3. Tighten the thumbscrew to hold the eyepiece in place.

To remove the eyepiece, loosen the thumbscrew on the star diagonal and slide the eyepiece out.

Eyepieces are commonly referred to by focal length and barrel diameter. The focal length of each eyepiece is printed on the eyepiece barrel. The longer the focal length (i.e., the larger the number) the lower the eyepiece power or magnification; and the shorter the focal length (i.e., the smaller the number) the higher the magnification. Generally, you will use low-to-moderate power when viewing. For more information on how to determine power, see the section on "Calculating Magnification."

Barrel diameter is the diameter of the barrel that slides into the telescope's eyepiece barrel. The NexStar uses eyepieces with a standard 1-1/4" barrel diameter.

Note:

As mentioned, the NexStar has an internal flip mirror that can divert light either through the eyepiece barrel at the top of the rear cell or directly through the photographic opening at the back of the rear cell. Make sure that the flip mirror is in the "up" position for viewing with an eyepiece and in the "down" position for taking photographs (see *Astronomy Basics* section of the manual).

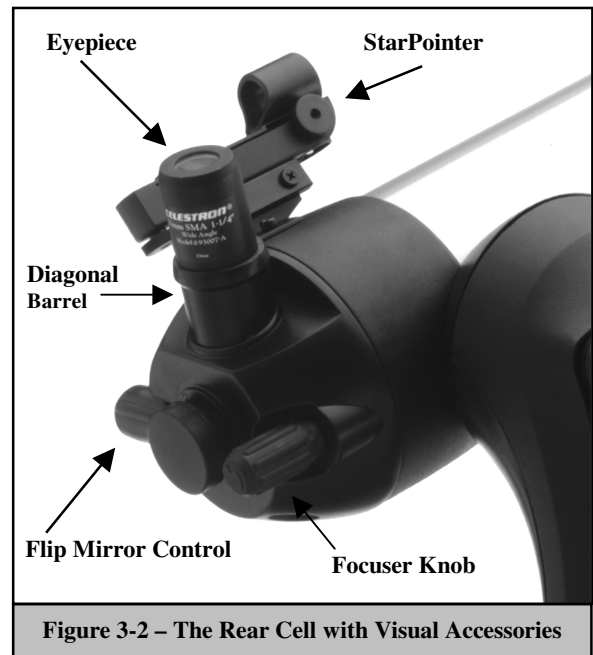
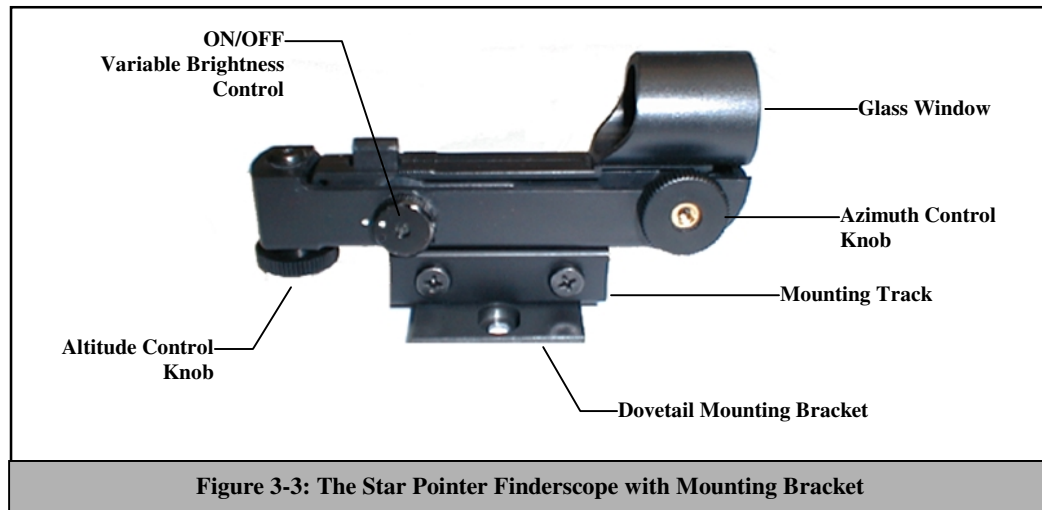

Figure 3-2 – The Rear Cell with Visual Accessories

The Star Pointer Finderscope

The Star Pointer is the quickest and easiest way to point your telescope exactly at a desired object in the sky. It's like having a laser pointer that you can shine directly onto the night sky. The Star Pointer is a zero magnification pointing tool that uses a coated glass window to superimpose the image of a small red dot onto the night sky. While keeping both eyes open when looking through the Star Pointer, simply move your telescope until the red dot, seen through the Star Pointer, merges with the object as seen with your unaided eye. The red dot is produced by a light-emitting diode (LED); it is not a laser beam and will not damage the glass window or your eye. The Star Pointer comes equipped with a variable brightness control, two axes alignment control and a quick-release dovetail mounting bracket. Before the Star Pointer is ready to be used, it must be attached to the telescope tube and properly aligned:



Star Pointer Installation

1. First, remove the two 8-32 x 1/4" screws located on the top portion of the telescope's rear cell.
2. Locate the square dovetail bracket that has the proper curvature for the NexStar tube and align the holes with the two holes in the telescope body.
3. Use the two 8-32 x 1/4" screws to tighten down the bracket to the rear cell.
4. Once the bracket is mounted, slide the mounting track at the bottom of the Star Pointer over the dovetail portion of the bracket. It may be necessary to loosen the two screws on the side of the mounting track before sliding it over the dovetail. The end of the Star Pointer with the glass window should be facing out towards the front of the telescope.
5. Tighten the two screws on the side of the mounting track to secure the Star Pointer to the dovetail bracket.

Star Pointer Operation

The star pointer is powered by a long life 3-volt lithium battery (#CR2032) located underneath the front portion of the Star Pointer. Like all finderscopes, the Star Pointer must be properly aligned with the main telescope before it can be used. This is a simple process using the azimuth and altitude control knobs located on the side and bottom of the Star Pointer. The alignment procedure is best done at night since the LED dot will be difficult to see during the day.

1. To turn on the Star Pointer, rotate the variable brightness control (see figure 3-3) clockwise until you here a "click". To increase the brightness level of the red dot, continue rotating the control knob about 180° until it stops.
2. Locate a bright star or planet and center it in a low power eyepiece in the main telescope.

3. With both eyes open, look through the glass window at the alignment star.
4. If the Star Pointer is perfectly aligned, you will see the red LED dot overlap the alignment star. If the Star Pointer is not aligned, take notice of where the red dot is relative to the bright star.
5. Without moving the main telescope, turn the Star Pointer's azimuth and altitude alignment controls until the red dot is directly over the alignment star.

If the LED dot is brighter than the alignment star, it may make it difficult to see the star. Turn the variable brightness control counterclockwise, until the red dot is the same brightness as the alignment star. This will make it easier to get an accurate alignment. The Star Pointer is now ready to be used . **Remember to remove the plastic cover over the battery, and always turn the power off after you have found an object. This will extend the life of both the battery and the LED.**

CELESTRON[®] NexStar HC

The NexStar 4 HC telescope is a precision scientific instrument that will allow you to enjoy viewing numerous objects in the night sky — planets, nebulae, star clusters, galaxies and more. Equipped with high speed motors and hand control, the NexStar HC allows you to remotely move your telescope to desired objects quickly and accurately. At a touch of a button, you can slew your telescope across the sky in a matter of seconds and continuously track objects as the Earth rotates beneath them. The NexStar HC is fully upgradeable and can be equipped with the optional NexStar Hand Control with a database of over 4,000 objects (see the Optional Accessories section of this manual).

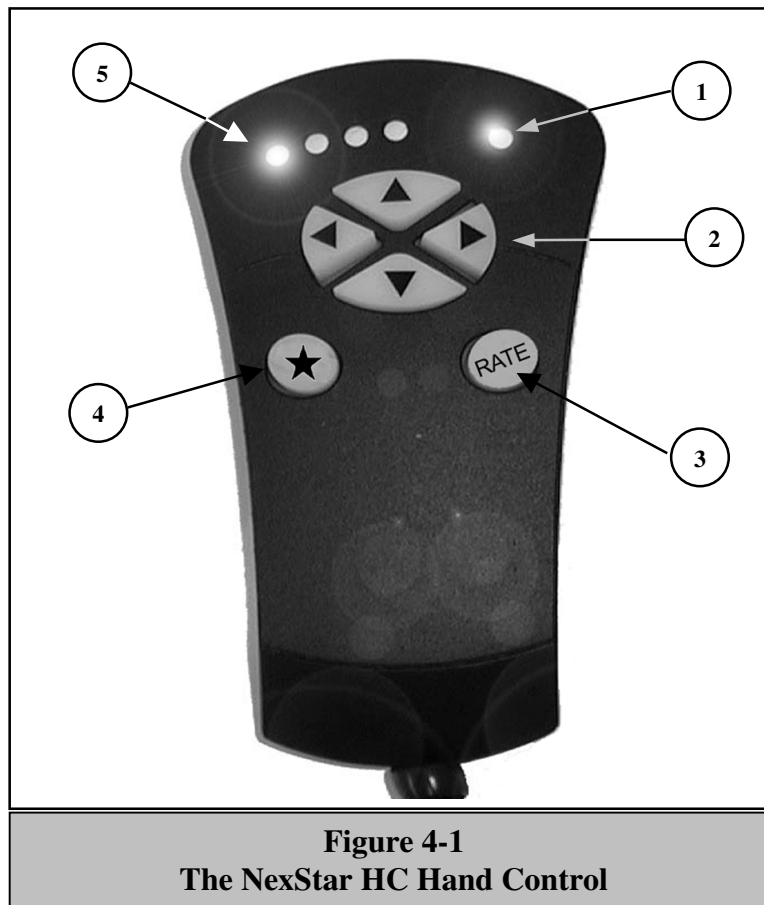

Figure 4-1
The NexStar HC Hand Control

The Hand Control

The NexStar HC has a removable hand control that gives the user quick access to all the motion controls the NexStar HC offers. Below is a brief description of the individual components of the NexStar HC hand controller:

1. **Star Key Activation Light:** Indicates that the **Star** button has been pressed and the utility functions on the hand control are active.
2. **Direction Buttons:** Allows complete control of the NexStar in any direction. Use the direction keys to move the telescope from object to object or for centering objects in the eyepiece.
3. **Rate:** Instantly changes the rate of speed of the motors when the direction buttons are pressed. Press this button repeatedly to cycle through the speeds of the motors.

4. **Star Key:** Gives the user access to the utility functions of the hand control, such as changing the direction of the arrow keys and backlash compensation.
5. **Hand Control Slew Rate Indicator Lights:** Displays the speed at which the telescope will move when each direction button is pressed.

Rate Button

Pressing the RATE key (3) allows you to instantly change the speed rate of the motors from high speed slew rate to precise centering rate or two speeds in between. Each rate corresponds to one of the indicator LED lights (5) on the hand control. From left to right, the corresponding speeds are as follows:

<i>Rate</i>	
1	For fine centering of objects in the eyepiece
2	For scanning around for objects in the eyepiece
3	For centering bright stars in the Star Pointer
4	For slewing around the sky from object to object

The hand control has a "double button" feature that allows you to instantly speed up the motors without having to choose a speed rate. To use this feature, simply press the arrow button that corresponds to the direction that you want to move the telescope. While holding that button down, press the opposite directional button. This will increase the slew rate to approximately 1.5° per second (equal to the third rate on the hand control). This feature will only function if the telescope is currently set at a speed rate of 1 or 2.

Utility Features

The NexStar HC hand control comes with a *Star* function key that allows you to change certain parameters of the hand controls functions, such as the directional logic of the arrow keys, backlash compensation of the motor gears and azimuth tracking.

Direction Buttons: When looking at a star through an eyepiece or star diagonal, the direction that the star moves when the Up and Down arrow buttons are pressed will be reversed from when the same object is being centered in the Star Pointer Finderscope. For example, when a star is being centered in the telescope's eyepiece, it may appear to move upward when the down arrow button is pressed (and visa-versa) even though the telescope tube is actually moving downward. This is why it is convenient to be able to change the arrow button direction when switching from using the Star Pointer to the eyepiece. To reverse the direction of the Up and Down arrow buttons:

1. Press the **STAR** key on the hand control. The activation light (1) on the hand control will light up to indicate that the button has been pressed. When the button has been pressed, the four direction buttons (2) will be non-operational until the button is pressed again.
2. Press the **RATE** button on the hand control.
3. Press the **STAR** key on the hand control to activate the direction buttons.

Anti-backlash – All mechanical gears have a certain amount of backlash or "play" between the gears. This play is evident by how long it takes for a star to move in the eyepiece when the hand control arrow buttons are pressed (especially when changing directions). The NexStar's anti-backlash feature allows the user to compensate for backlash by having the hand control quickly rewind the motors just enough to eliminate the play between gears. The amount of compensation needed depends on the slewing rate selected; the slower the slewing rate the longer it will take for the star to appear to move in the eyepiece. To change the backlash compensation:

1. Press the **STAR** key on the hand control.
2. Use the Right and Left arrow keys to speed up or slow down the initial speed of the azimuth motors when the arrow buttons are pressed. For example, if it takes a star too long to move in the eyepiece when the hand control arrow buttons are pressed, then press the Right arrow button to speed up the initial motor speed. The buttons can be pressed repeatedly to increase the initial motor speed even more.

3. Use the UP and Down arrow keys to speed up or slow down the initial speed of the altitude motors when the arrow buttons are pressed.
4. Press the **STAR** key on the hand control again to activate the direction buttons again.

GuideStar Software

The NexStar HC has an RS-232 port on the back of the hand control, allowing it to be controlled using the *GuideStar* telescope control software. Linking the NexStar to a computer requires the use of a RS-232 cable. Connect the phone jack connector to the RS-232 port in the hand control and the 9-pin connector to the back of your computer. Once connected, install the *GuideStar* CD-ROM onto your computer and follow the on-screen instruction. The *GuideStar* software gives you all the "Go-To" features of the NexStar GT hand control including a 4,000 object database, *AutoAlign* based on date and location, and helpful information for hundreds of objects. For information on using many of the *GuideStar* features, refer to the *AutoAlign* instructions in the NexStar GT section of the manual. The *GuideStar* software also has help buttons to explain many of the commonly used fields.



The NexStar GT has a removable hand controller built into the side of the fork arm designed to give you instant access to all the functions the NexStar has to offer. With automatic slewing to over 4,000 objects, and common sense menu descriptions, even a beginner can master its variety of features in just a few observing sessions. Below is a brief description of the individual components of the NexStar GT hand controller:

1. **Liquid Crystal Display (LCD) Window:** Has a dual-line, 16 character display screen that is backlit for comfortable viewing of telescope information and scrolling text.
2. **Align:** Instructs the NexStar to use a selected star or object as an alignment position.
3. **Direction Keys:** Allows complete control of the NexStar in any direction. Use the direction keys to move the telescope to the initial alignment stars or for centering objects in the eyepiece.

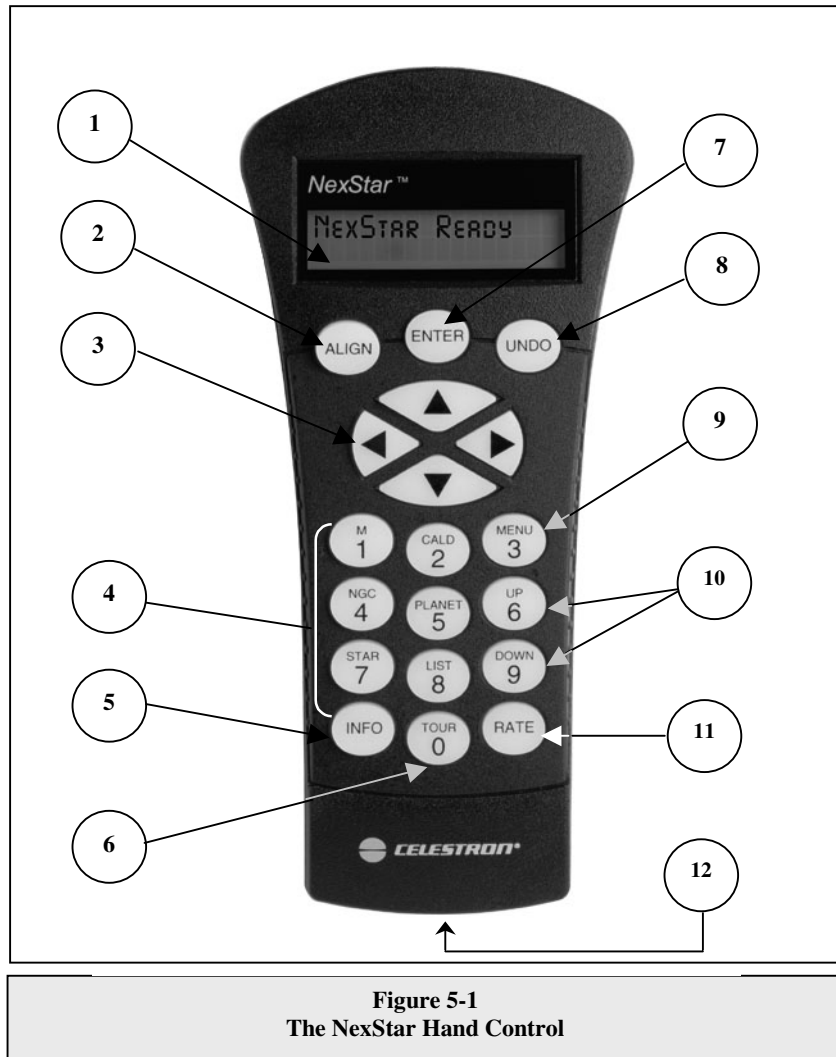

Figure 5-1
The NexStar Hand Control

4. **Catalog Keys:** The NexStar has keys on the hand control to allow direct access to each of the catalogs in its 4,000+ object database. The NexStar contains the following catalogs in its database:

Messier – Complete list of all Messier objects.

NGC – Complete list of all the deep-sky objects in the Revised New General Catalog.

Caldwell – A combination of the best NGC and IC objects.

Planets - All 8 planets in our Solar System plus the Sun and moon.

Stars – A compiled list of the brightest stars from the SAO catalog.

List – For quick access, all of the best and most popular objects in the NexStar database have been broken down into lists based on their type and/or common name:

Alignment Stars	Common name listing of the brightest stars in the sky.
Named Objects	Alphabetical listing of over 50 of the most popular deep sky objects.
Double Stars	Numeric-alphabetical listing of the most visually stunning double, triple and quadruple stars in the sky.
Variable Stars	Select list of the brightest variable stars with the shortest period of changing magnitude.
Asterisms	A unique list of some of the most recognizable star patterns in the sky.

5. **Info:** Displays coordinates and useful information about objects selected from the NexStar database.
6. **Tour:** Activates the tour mode, which seeks out all the best objects for a given month and automatically slews the NexStar to those objects.
7. **Enter:** Pressing *Enter* allows you to select any of the NexStar functions and accept entered parameters.
8. **Undo:** *Undo* will take you out of the current menu and display the previous level of the menu path. Press *Undo* repeatedly to get back to a main menu or use it to erase data entered by mistake.
9. **Menu:** Displays the many setup and utilities functions such as tracking rate and user defined objects and many others.
10. **Scroll Keys:** Used to scroll up and down within any of the menu lists. Using these keys will scroll through those sub-menus.
11. **Rate:** Instantly changes the rate of speed of the motors when the direction buttons are pressed.
12. **RS-232 Jack:** Allows you to interface with a computer and control the NexStar remotely.

Hand Control Operation

This section describes the basic hand control procedures needed to operate the NexStar. These procedures are grouped into three categories: Alignment, Setup and Utilities. The alignment section deals with the initial telescope alignment as well as finding objects in the sky; the setup section discusses changing parameters such as tracking mode and tracking rate; finally, the last section reviews all of the utilities functions such as cordwrap and backlash compensation.

The first time that the NexStar is used, it will request information to help identify the model of telescope. Once initialized (powered on), the hand control will display the message **Select Model**. Use the Up and Down menu keys (10) to scroll through the different NexStar models. Press ENTER when your NexStar model is displayed on the hand control. This information will be retained for future use and will not be displayed again. **Note: your hand control may have been pre set at the factory to operate with your NexStar model. If so, there will be an addendum packaged with the hand control. If your hand control has been pre-set, the display will read NexStar Ready - Custom, and you can simply press ENTER and continue to follow the Auto Align procedures below.**

Alignment Procedure

In order for the NexStar to accurately point to objects in the sky, it must first be aligned to two known positions (stars) in the sky. With this information, the telescope can create a model of the sky, which it uses to locate any object with known coordinates.

Auto-Align

Auto-Align is the easiest way to get the NexStar aligned and ready to observe. Even if you do not know a single star in the sky, the NexStar will align itself by guiding the user through the alignment procedure by asking for basic information about the date, time and location. The NexStar will then automatically choose two stars for alignment and roughly center the stars in the field of view of the Star Pointer. Before the telescope is ready to be aligned, it should be set up in an outside location

with all accessories (eyepiece and Star Pointer) attached and lens cover removed as described in the *Assembly* section of the manual.

1. Once the NexStar is powered on, Press ENTER to begin alignment.
2. Use the Up and Down scroll keys to select *AutoAlign* if it is not already displayed, and press ENTER.
3. The telescope will then ask you to use the arrow keys (3) to level the telescope tube and point the front of the telescope towards north. North can be found by finding the direction of the North Star (Polaris) or by using a compass. You do not need to point at the North Star, only the north horizon. Alignment only needs to be approximate, however a close alignment will make the auto alignment more accurate. Once the telescope is in the north and level position, press ENTER.
4. The hand control display will then ask for the following information:

Date - Enter the month, day and year of your observing session. The display will read: mm/dd/yy

Time - Enter the current local time for your area and select PM or AM.

- Choose between Standard time or Daylight Savings time. Use the Up and Down scroll buttons (10) to toggle between options.
- Select the time zone that you are observing from. Again, use the Up and Down buttons (10) to scroll through the choices. To enter a numeric time zone, select *Zone* and enter the number for the appropriate time zone. For time zone information, refer to the Time Zone map in the appendix of this manual.

Finally, you must enter the location of your observing site. The NexStar will display a list of cities to choose from. Choose the city from the database that is closest to your current observing site. The city you choose can be saved in the hand controls memory so that it only has to be entered once from any given location. Alternatively, if you know the exact longitude and latitude of your observing site, it can be entered directly into the hand control and remembered for future use as well. To choose a location city:

1. When **Select Method** is displayed on the hand control screen, use the Up and Down scroll keys to select **Choose City** if it is not already displayed, and press ENTER.
2. The hand control will allow you to choose from either U.S. or international locations. For a listing of U.S. locations by state and then by city, press ENTER while **United States** is displayed. For international locations, use the Up or Down scroll key to select **International** and press ENTER.
3. To display a list of local cities, first select your state from the alphabetical listing (or a list of countries if International locations was selected) and press ENTER.
4. Choose the closest city to your location from the displayed list and press ENTER.

The display will then ask if you would like to save this city for future use. If you press "Yes", the next time you AutoAlign the telescope, you can select **User Defined** instead of the **Choose City**. When **User Defined** is selected, the hand control will allow you to choose from either the location cities that were saved or any individual longitude/latitude that was saved. Use the UP and DOWN arrow keys to scroll through the stored cities, when the desired city is displayed, press ENTER. For saved locations (longitudes/latitudes), enter the number (1-9) of the location coordinates that were saved.

Based on this information, the NexStar will automatically select a bright star that is above the horizon and slew towards it. At this point the telescope is only roughly aligned, so the alignment star should only be close to the field of view of the Star Pointer finder. Once finished slewing, the display will ask you to use the arrow buttons to align the selected star with the red dot in the center of the Star Pointer's field of view. If for some reason the chosen star is not visible (perhaps behind a tree or building) you can press UNDO to select and slew to a different star. Once centered in the finder, press ENTER. The display will then instruct you to center the star in the field of view of the eyepiece. When the star is centered, press ALIGN to accept this star as your first alignment star. (There is no need to adjust the slewing rate of the motors after each alignment step. The NexStar automatically selects the best slewing rate for aligning objects in both the Star Pointer and the eyepiece). After the first alignment star has been entered the NexStar will automatically slew to a second alignment star and have you repeat this procedure for that star. When the telescope has been aligned to both stars the display will read **Alignment Successful**, and you are now ready to find your first object.

Trouble Shooting

If the wrong star was centered and aligned to, the NexStar display will read *Bad Alignment*. Should this occur, the display will automatically ask you to re-center the last alignment star and press ALIGN. If you believe that the wrong star may have been centered (remember the alignment star will always be the brightest star nearest the field of view of the finder), then re-center the star and press ALIGN. If you wish to try aligning on a different star, press UNDO and the NexStar will select two new alignment stars and automatically slew to the first star.

In order to accurately center the alignment star in the eyepiece, it may be necessary to decrease the slew rate of the motors for fine centering. This is done by pressing the RATE key (11) on the hand controller then selecting the number that corresponds to the speed you desire. (9 = fastest, 1 = slowest).

Third Star Alignment

The NexStar has a third star alignment feature which allows you to replace either of the two original alignment stars with a new star. This can be useful in several situations:

- If you are observing over a period of a few hours, you may notice that your original two alignment stars have drifted towards the west considerably. (Remember that the stars are moving at a rate of 15° every hour). Aligning on a new star that is in the eastern part of the sky will improve your pointing accuracy, especially on objects in that part of the sky.
- When trying to locate a very faint or small object that may be difficult to find in the eyepiece, you can improve your pointing accuracy by aligning to a third star that is nearest to the object you are trying to find.

To replace an existing alignment star with a new alignment star:

1. Locate and center the desired star in the eyepiece.
2. Select the centered star from the list of alignment stars in the hand control.
3. When the name of the centered star is displayed, press the ALIGN key on the hand control.
4. The display will then ask you which alignment star you want to replace.
5. Use the UP and Down scroll keys to select the alignment star to be replaced. It is usually best to replace the star closest to the new star. This will space out your alignment stars across the sky.
6. Press ENTER to make the change.

Object Catalog

Selecting an Object

Now that the telescope is properly aligned, you can choose an object from any of the catalogs in the NexStar's extensive database. The hand control has a key (4) designated for each of the catalogs in its database. There are two ways to select objects from the database: scrolling through the named object lists and entering object numbers.

1. Pressing the LIST key on the hand control will access all objects in the database that have common names or types. Each list is broken down into the following categories: Named Stars, Named Object, Double Stars, Variable Stars and Asterisms. Selecting any one of these options will display an alpha-numeric listing of the objects under that list. Pressing the Up and Down keys (10) allows you to scroll through the catalog to the desired object.
2. Pressing any of the catalog keys (M, CALD, NGC, or STAR) will display a blinking cursor below the name of the catalog chosen. Use the numeric key pad to enter the number of any object within these standardized catalogs. For example, to find the Orion Nebula, press the "M" key and enter "042".

To download a list of all the stars contained in the STAR Catalog with SAO number cross references, logon to our web site at www.celestron.com and go to the NexStar page.

**More
Information**

Slewing to an Object

Once the desired object is displayed in the hand control screen, you have two options:

1. **Press the INFO Key.** This will give you useful information about the selected object such as R.A. and declination, magnitude and most importantly, altitude above the horizon. (If a star alignment has not yet been performed, the altitude will not be displayed).

The speed at which information scrolls across the hand control display can be changed while the information is being viewed:

- Hold down the “1” key to speed up the scroll speed.
- Hold down the “4” key to slow down the scroll speed.
- Hold down the “7” key to freeze the information on the display.

2. **Press the ENTER Key.** This will automatically slew the telescope to the coordinates of the object.

Caution: Never slew the telescope when someone is looking into the eyepiece. The telescope can move at very fast slew speeds and may hit an observer in the eye.

Object information can be obtained without having to do a star alignment. After the telescope is powered on, press the UNDO key. Pressing any of the catalog keys allows you to scroll through object lists or enter catalog numbers as described above. However, information such as R.A. and declination of planets and altitude above the horizon will not be displayed unless the telescope is first properly aligned.

Tour Mode

The NexStar includes a tour feature which automatically allows the user to choose from a list of interesting objects based on the month in which you are observing. The Tour mode is activated by pressing the TOUR key (6) on the hand control. Once activated, simply use the scroll keys to select the current month and press ENTER. The NexStar will display from a list of the best objects to observe based on the month entered.

- To see information and data about the displayed object, press the INFO key.
- To slew to the object displayed, press ENTER.
- To see the next tour object, press the Up key.



**Observing
Tip**

When going through any of the object catalogs in the database, you can easily find out which objects are above the horizon and visible simply by pressing the INFO button when the desired object is displayed. This will display the objects altitude above the horizon based on the date and time entered. Pressing the UP button once will display any scrolling text associated with that object. The scrolling text can be viewed even if a star alignment has not been performed.

Direction Buttons

The NexStar has four direction buttons in the center of the hand control which control the telescope motion in altitude (up and down) and azimuth (left and right). The telescope can be controlled at nine different speed rates.

Rate Button

Pressing the RATE key (11) allows you to instantly change the speed rate of the motors from high speed slew rate to precise guiding rate or anywhere in between. Each rate corresponds to a number on the hand controller key pad. The number 9 is the fastest rate (4° per second, depending on power source) and is used for slewing between objects and locating alignment stars. The number 1 on the hand control is the slowest rate (1x sidereal) and can be used for accurate centering of objects in the eyepiece and photographic guiding. To change the speed rate of the motors:

- Press the RATE key on the hand control. The LCD will display the current speed rate.
- Press the number on the hand control that corresponds to the desired speed. The LCD will display "NexStar Ready" indicating that the rate has been changed.

The hand control has a "double button" feature that allows you to instantly speed up the motors without having to choose a speed rate. To use this feature, simply press the arrow button that corresponds to the direction that you want to move the telescope. While holding that button down, press the opposite directional button. This will increase the slew rate to approximately 1° per second (equal to rate 7 on the hand control). This feature will not function if the telescope is currently set at a speed rate of 8 or 9.

The slower slew rates (6 and lower) move the motors in the opposite direction than the faster slew rates (8 and 9). This is done so that an object will move in the appropriate direction when looking into the eyepiece (i.e. pressing the right arrow button will move the star towards the right in the field of view of the eyepiece). However, if any of the slower slew rates (rate 6 and below) are used to center an object in the Star Pointer, you may need to press the opposite directional button to make the telescope move in the correct direction.

<i>1 = 2x</i>	<i>6 = .5° / sec</i>
<i>2 = 4x</i>	<i>7 = 1° / sec</i>
<i>3 = 8x</i>	<i>8 = 2° / sec</i>
<i>4 = 16x</i>	<i>9 = 4° / sec</i>
<i>5 = 32x</i>	
Nine available slew speeds	

Setup Procedures

The NexStar contains many user defined setup functions designed to give the user control over the telescope's many advanced features. All of the setup and utility features can be accessed by pressing the MENU key and scrolling through the options:

Tracking Mode Once the NexStar is aligned the tracking motors will automatically turn on and begin tracking the sky. However, the tracking can be turned off for terrestrial use:

Alt-Az This is the default tracking rate and is used when the telescope is placed on a flat surface or tripod without the use of an equatorial wedge. The telescope must be aligned with two stars before it can track in Alt-Az.

EQ North Used to track the sky when the telescope is polar aligned using an equatorial wedge in the Northern Hemisphere.

EQ South Used to track the sky when the telescope is polar aligned using an equatorial wedge in the Southern Hemisphere.

Off When using the telescope for terrestrial (land) observation, the tracking can be turned off so that the telescope never moves.

Tracking Rate In addition to being able to move the telescope with the hand control buttons, the NexStar will continually track a celestial object as it moves across the night sky. The tracking rate can be changed depending on what type of object is being observed:

- Sidereal** This rate compensates for the rotation of the earth by moving the telescope at the same rate as the rotation of the earth, but in the opposite direction. When the telescope is polar aligned, this can be accomplished by moving the telescope in Right Ascension only. When mounted in Alt-Az mode, the telescope must make corrections in both R.A. and declination.
- Lunar** Used for tracking the moon when observing the lunar landscape.
- Solar** Used for tracking the Sun when solar observing using a proper solar filter.
- King** As light passes through our atmosphere, atmospheric refraction affects the apparent motion of objects across the sky. The King rate takes this into account and compensates for the refraction of the atmosphere.

User Objects

The NexStar can store up to 20 different user defined objects in its memory. The objects can be daytime land objects or an interesting celestial object that you discover that is not included in the regular database. There are several ways to save an object to memory depending on what type of object it is:

- Save Sky Object:** The NexStar stores celestial objects to its database by saving its right ascension and declination in the sky. This way the same object can be found each time the telescope is aligned. Once a desired object is centered in the eyepiece, simply scroll to the "**Save Sky Obj**" command and press ENTER. The display will ask you to enter a number between 1-9 to identify the object. Press ENTER again to save this object to the database.
- Save Land Object:** The NexStar can also be used as a spotting scope on terrestrial objects. Fixed land objects can be stored by saving their altitude and azimuth relative to the location of the telescope at the time of observing. Since these objects are relative to the location of the telescope, they are only valid for that exact location. To save land objects, once again center the desired object in the eyepiece. Scroll down to the "**Save Land Obj**" command and press ENTER. The display will ask you to enter a number between 1-9 to identify the object. Press ENTER again to save this object to the database.
- GoTo Sky Object:** To go to any of the user defined sky objects stored in the database, scroll down to "**GoTo Sky Obj**" and enter the number of the object you wish to select and press ENTER. NexStar will automatically retrieve the coordinates and slew to the object.
- GoTo Land Object:** To go to any of the user defined land objects stored in the database, scroll down to "**GoTo Land Obj**" and enter the number of the object you wish to select and press ENTER. NexStar will automatically retrieve the coordinates and slew to the object.

To replace the contents of any of the user defined objects, simply save a new object using one of the existing identification numbers; NexStar will replace the previous user defined object with the current one.

Get RA/DEC - Displays the right ascension and declination for the current position of the telescope.

Get Alt-Az - Displays the relative altitude and azimuth for the current position of the telescope.

Goto R.A/ Dec - Allows you to input a specific R.A. and declination and slew to it.

Goto Alt-Az - Allows you to enter a specific altitude and azimuth position and slew to it.

**Helpful
Hint**

To store a set of coordinates (R.A./Dec) permanently into the NexStar database, save it as a *User Defined Object* as described above.

Utility Features

Scrolling through the MENU options will also provide access to several advanced utility functions within the NexStar such as cord wrap and anti-backlash.

Cord Wrap – Cord wrap safeguards against the telescope slewing more than 360° in azimuth and wrapping the power cord around the base of the telescope. The cord wrap menu has two settings; batteries and power cord. By default, the cord wrap feature is set to "batteries" when the telescope is powered on. If using the NexStar with a AC adapter, change the setting to "power cord", this will activate the cord wrap feature.

Anti-backlash – All mechanical gears have a certain amount of backlash or play between the gears. This play is evident by how long it takes for a star to move in the eyepiece when the hand control arrow buttons are pressed (especially when changing directions). The NexStar's anti-backlash features allows the user to compensate for backlash by inputting a value which quickly rewinds the motors just enough to eliminate the play between gears. The amount of compensation needed depends on the slewing rate selected; the slower the slewing rate the longer it will take for the star to appear to move in the eyepiece. Therefore, the anti-backlash compensation will have to be set higher. You will need to experiment with different values; a value between 20 and 50 is usually best for most visual observing, whereas a higher value may be necessary for photographic guiding.

**Observing
Tip**

To set the anti-backlash value, scroll down to the **Azm Backlash** or **Alt Backlash** and press ENTER. Enter a value from 0-100 for both azimuth and altitude and press ENTER after each one to save these values. NexStar will remember these values and use them each time it is turned on until they are changed.

For the best possible pointing accuracy, always center the alignment stars using the up arrow button and the right arrow button. Approaching the star from this direction when looking through the eyepiece will eliminate much of the backlash between the gears and assure the most accurate alignment possible.

Model Select – When the NexStar is first powered on, the hand control display allows you to select your NexStar from a list of different models. If for some reason the incorrect model was selected, the *Model Select* utility feature allows you to re-select the proper NexStar model from the displayed list. Once the correct NexStar model has been selected the power needs to be restarted before beginning the alignment procedure. **NOTE:** If your hand control has been pre-set at the factory, it will say *NexStar Ready - Custom* when first turned-on. Do not use the Model Select feature to change the model type; doing so may alter the telescope's pointing accuracy.

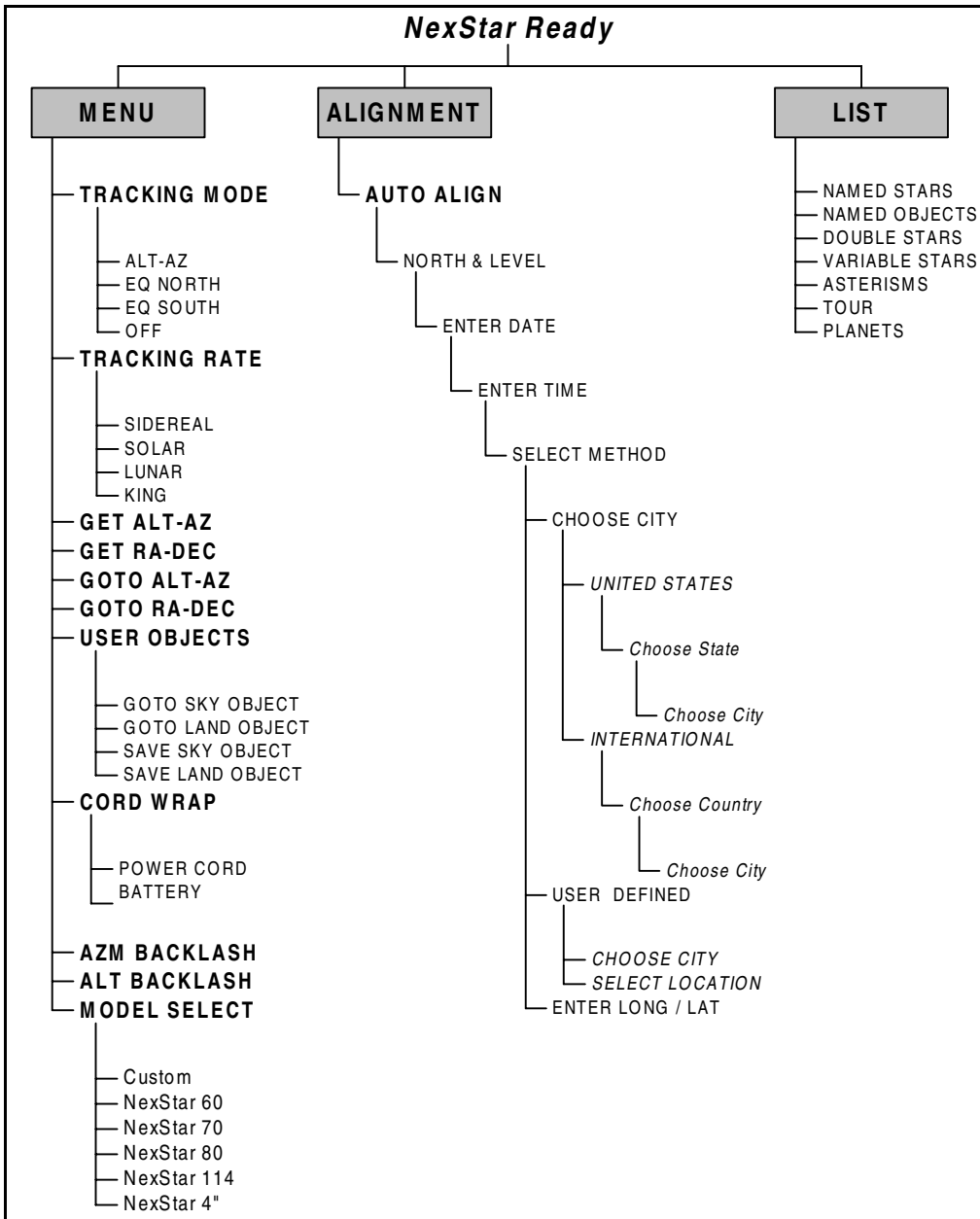

NexStar Menu Tree:

The following figure is a menu tree showing the sub-menus associated with the primary command functions



Telescope Basics

A telescope is an instrument that collects and focuses light. The nature of the optical design determines how the light is focused. Some telescopes, known as refractors, use lenses. Other telescopes, known as reflectors, use mirrors. The Maksutov-Cassegrain optical system uses a combination of mirrors and lenses and is referred to as a compound or catadioptric telescope. This unique design offers large-diameter optics while maintaining very short tube lengths, making them extremely portable. The Maksutov-Cassegrain system consists of a corrector plate, a spherical primary mirror, and a secondary mirror spot. Once light rays enter the optical system, they travel the length of the optical tube three times.

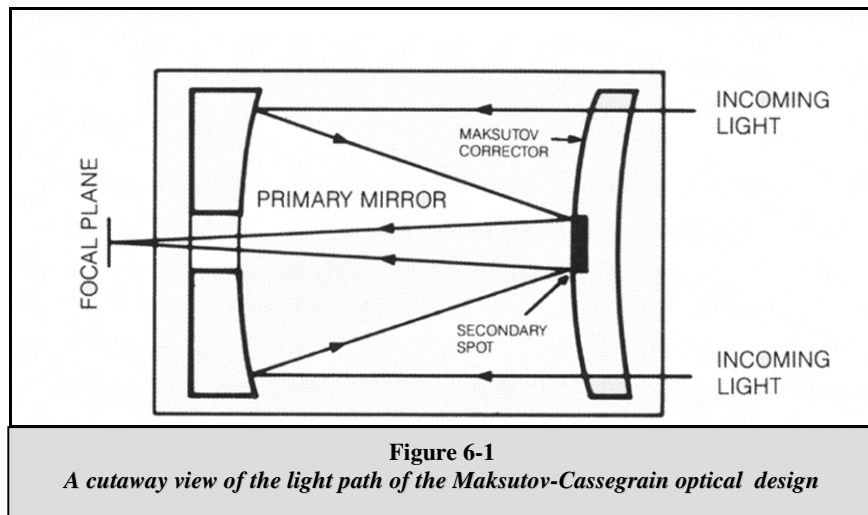

The optics of the NexStar have enhanced multi-layer coatings on the primary and secondary mirrors for increased reflectivity and a multi coated corrector for the finest anti-reflection characteristics.

Inside the optical tube, a black tube extends out from the center hole in the primary mirror. This is the primary baffle tube and it prevents stray light from passing through to the eyepiece or camera.

Image Orientation

The image orientation changes depending on how the eyepiece is inserted into the telescope. The NexStar uses three reflective surfaces to bounce the light to the eyepiece. This produces an image that is right-side-up, but reversed from left-to-right (i.e., reversed). This is normal for the Maksutov-Cassegrain design.



Fig 6-2a - Actual image orientation as seen with the unaided eye

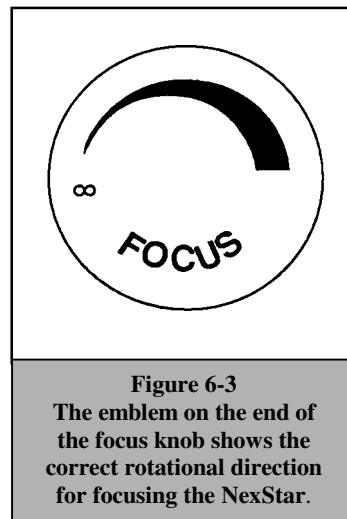

Fig 6-2b - Reversed from left to right, as viewed through the eyepiece

Focusing

The NexStar's focusing mechanism controls the primary mirror which is mounted on a ring that slides back and forth on the primary baffle tube. The focusing knob, which moves the primary mirror, is on the rear cell of the telescope just below the star diagonal and eyepiece. Turn the focusing knob until the image is sharp. If the knob will not turn, it has reached the end of its travel on the focusing mechanism. Turn the knob in the opposite direction until the image is sharp. Once an image is in focus, turn the knob clockwise to focus on a closer object and counterclockwise for a more distant object. A single turn of the focusing knob moves the primary mirror only slightly. Therefore, it will take many turns (about 25) to go from close focus (approximately 20 feet) to infinity.

For astronomical viewing, out of focus star images are very diffuse, making them difficult to see. If you turn the focus knob too quickly, you can go right through focus without seeing the image. To avoid this problem, your first astronomical target should be a bright object (like the Moon or a planet) so that the image is visible even when out of focus. Critical focusing is best accomplished when the focusing knob is turned in such a manner that the mirror moves against the pull of gravity. In doing so, any mirror shift is minimized. For astronomical observing, both visually and photographically, this is done by turning the focus knob counterclockwise.



Calculating Magnification

You can change the power of your telescope just by changing the eyepiece (ocular). To determine the magnification of your telescope, simply divide the focal length of the telescope by the focal length of the eyepiece used. In equation format, the formula looks like this:

$$\text{Magnification} = \frac{\text{Focal Length of Telescope (mm)}}{\text{Focal Length of Eyepiece (mm)}}$$

Let's say, for example, you are using the 25mm eyepiece. To determine the magnification you simply divide the focal length of your telescope (the NexStar has a focal length of 1300mm) by the focal length of the eyepiece, 25mm. Dividing 1300 by 25 yields a magnification of 52 power.

Although the power is variable, each instrument under average skies has a limit to the highest useful magnification. The general rule is that 60 power can be used for every inch of aperture. For example, the NexStar is 4" in diameter. Multiplying 4 by 60 gives a maximum useful magnification of 240 power. Although this is the maximum useful magnification, most observing is done in the range of 20 to 35 power for every inch of aperture which is 80 to 140 times for the NexStar telescope.

Determining Field of View

Determining the field of view is important if you want to get an idea of the angular size of the object you are observing. To calculate the actual field of view, divide the apparent field of the eyepiece (supplied by the eyepiece manufacturer) by the magnification. In equation format, the formula looks like this:

$$\text{True Field} = \frac{\text{Apparent Field of Eyepiece}}{\text{Magnification}}$$

As you can see, before determining the field of view, you must calculate the magnification. Using the example in the previous section, we can determine the field of view using the same 25mm eyepiece. The 25mm eyepiece has an apparent field of view of 52°. Divide the 52° by the magnification, which is 52 power. This yields an actual field of view of 1.0°.

To convert degrees to feet at 1,000 yards, which is more useful for terrestrial observing, simply multiply by 52.5. Continuing with our example, multiply the angular field 1.0° by 52.5. This produces a linear field width of 52.5 feet at a distance of one thousand yards. The apparent field of each eyepiece that Celestron manufactures is found in the Celestron Accessory Catalog (#93685).

General Observing Hints

When working with any optical instrument, there are a few things to remember to ensure you get the best possible image.

- Never look through window glass. Glass found in household windows is optically imperfect, and as a result, may vary in thickness from one part of a window to the next. This inconsistency can and will affect the ability to focus your telescope. In most cases you will not be able to achieve a truly sharp image, while in some cases, you may actually see a double image.
- Never look across or over objects that are producing heat waves. This includes asphalt parking lots on hot summer days or building rooftops.
- Hazy skies, fog, and mist can also make it difficult to focus when viewing terrestrially. The amount of detail seen under these conditions is greatly reduced. Also, when photographing under these conditions, the processed film may come out a little grainier than normal with lower contrast and underexposed.
- If you wear corrective lenses (specifically glasses), you may want to remove them when observing with an eyepiece attached to the telescope. When using a camera, however, you should always wear corrective lenses to ensure the sharpest possible focus. If you have astigmatism, corrective lenses must be worn at all times.

Astronomy Basics

Up to this point, this manual covered the assembly and basic operation of your NexStar telescope. However, to understand your telescope more thoroughly, you need to know a little about the night sky. This section deals with observational astronomy in general and includes information on the night sky and polar alignment.

The Celestial Coordinate System

To help find objects in the sky, astronomers use a celestial coordinate system that is similar to our geographical coordinate system here on Earth. The celestial coordinate system has poles, lines of longitude and latitude, and an equator. For the most part, these remain fixed against the background stars.

The celestial equator runs 360 degrees around the Earth and separates the northern celestial hemisphere from the southern. Like the Earth's equator, it bears a reading of zero degrees. On Earth this would be latitude. However, in the sky this is referred to as declination, or DEC for short. Lines of declination are named for their angular distance above and below the celestial equator. The lines are broken down into degrees, minutes of arc, and seconds of arc. Declination readings south of the equator carry a minus sign (-) in front of the coordinate and those north of the celestial equator are either blank (i.e., no designation) or preceded by a plus sign (+).

The celestial equivalent of longitude is called Right Ascension, or R.A. for short. Like the Earth's lines of longitude, they run from pole to pole and are evenly spaced 15 degrees apart. Although the longitude lines are separated by an angular distance, they are also a measure of time. Each line of longitude is one hour apart from the next. Since the Earth rotates once every 24 hours, there are 24 lines total. As a result, the R.A. coordinates are marked off in units of time. It begins with an arbitrary point in the constellation of Pisces designated as 0 hours, 0 minutes, 0 seconds. All other points are designated by how far (i.e., how long) they lag behind this coordinate after it passes overhead moving toward the west.

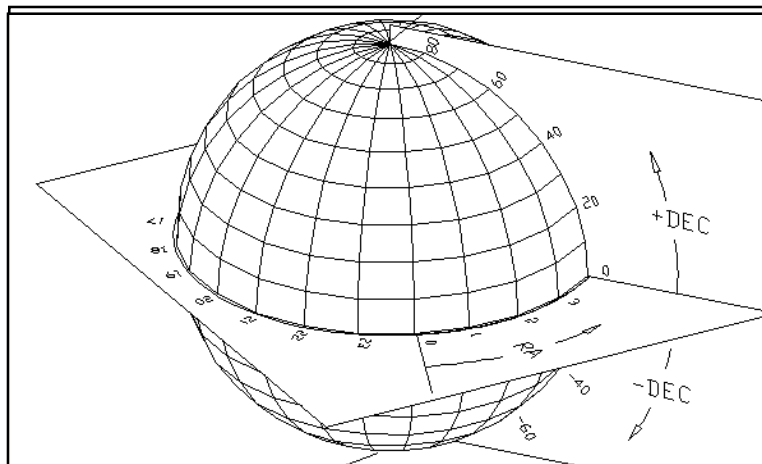
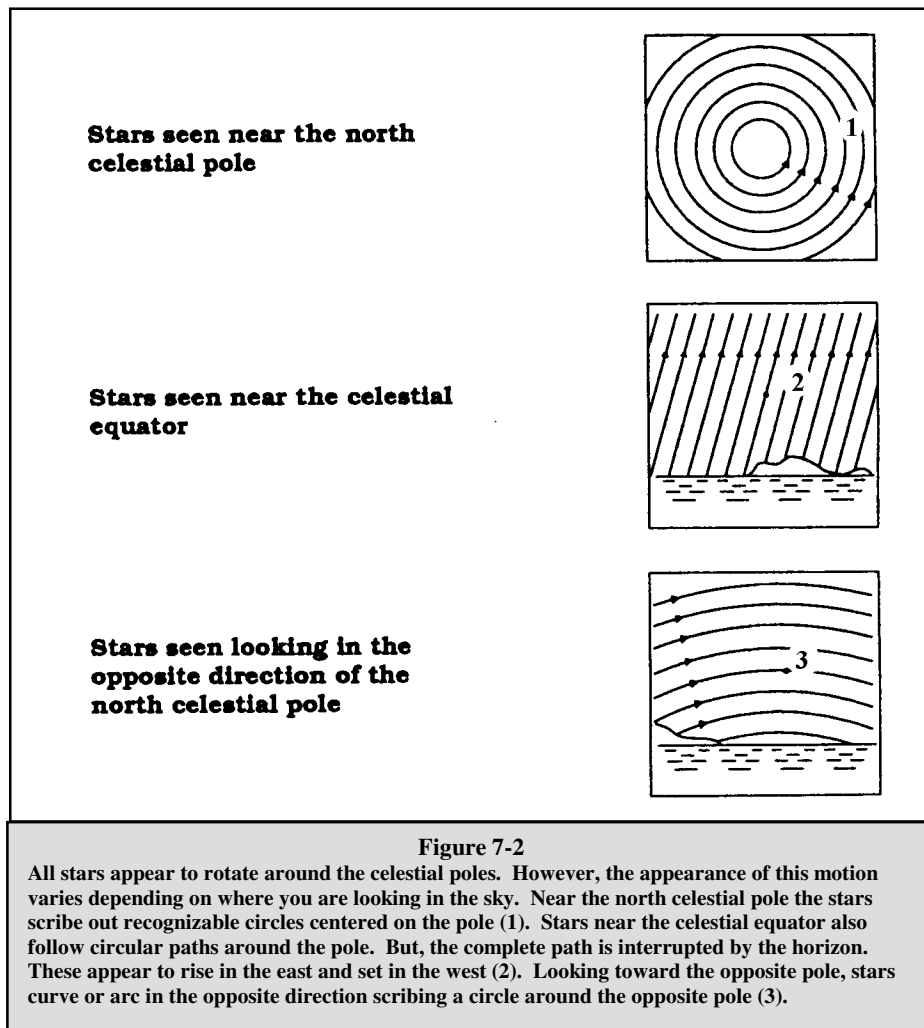

Figure 7-1
The celestial sphere seen from the outside showing R.A. and DEC.

Motion of the Stars

The daily motion of the Sun across the sky is familiar to even the most casual observer. This daily trek is not the Sun moving as early astronomers thought, but the result of the Earth's rotation. The Earth's rotation also causes the stars to do the same, scribing out a large circle as the Earth completes one rotation. The size of the circular path a star follows depends on where it is in the sky. Stars near the celestial equator form the largest circles rising in the east and setting in the west. Moving toward the north celestial pole, the point around which the stars in the northern hemisphere appear to rotate, these circles become smaller. Stars in the mid-celestial latitudes rise in the northeast and set in the northwest. Stars at high celestial latitudes are always above the horizon, and are said to be circumpolar because they never rise and never set. You will never see the stars complete one circle because the sunlight during the day washes out the starlight. However, part of this circular motion of stars in this region of the sky can be seen by setting up a camera on a tripod and opening the shutter for a couple hours. The processed film will reveal semicircles that revolve around the pole. (This description of stellar motions also applies to the southern hemisphere except all stars south of the celestial equator move around the south celestial pole.)



Polar Alignment (with optional Wedge)

Even though the NexStar can precisely track a celestial object while in the Alt-Az position, it is still necessary to align the polar axis of the telescope (the fork arm) to the Earth's axis on rotation in order to attempt long exposure astro photography. To do an accurate polar alignment, the NexStar requires an optional equatorial wedge (#93658) between the telescope and a tripod. Celestron also offers a steel tripod with an attached wedge tilt plate (#93497). This allows the telescope's tracking motors to rotate the telescope around the celestial pole, the same way as the stars. Without the equatorial wedge, you would notice the stars in the eyepiece would slowly rotate around the center of the field of view. Although this gradual rotation would go unnoticed when viewing with an eyepiece, it would be very noticeable on film.

Polar alignment is the process by which the telescope's axis of rotation (called the polar axis) is aligned (made parallel) with the Earth's axis of rotation. Once aligned, a telescope with a clock drive will track the stars as they move across the sky. The result is that objects observed through the telescope appear stationary (i.e., they will not drift out of the field of view). If not using the clock drive, all objects in the sky (day or night) will slowly drift out of the field. This motion is caused by the Earth's rotation.

Warning!

Remember, whenever attaching the NexStar to the NexStar tripod or wedge, always use the bolts that come with the accessory. Never use bolts that thread more than 3/8" into the bottom of the NexStar base. Threading bolts more than 3/8" into the base will damage the internal gears.

Whether you are using your NexStar in the Alt-Az configuration or polar aligned, it will be necessary to locate where north is and more specifically where the North Star is.

Definition

The polar axis is the axis around which the telescope rotates when moved in right ascension. This axis points the same direction even when the telescope moves in right ascension and declination.

Aligning the NexStar 4 on a Wedge

In order to do a star alignment while using the NexStar on an equatorial wedge it will be necessary to alter some of the alignment procedures when doing the AutoAlign. Before the NexStar is attached to the wedge, slew the telescope so that the tube is pointed straight up overhead (the tube should be parallel to the fork arm). Attach the telescope to the wedge and angle the wedge so that the NexStar's fork arm is pointing towards Polaris. Move the tripod side to side and tilt the wedge up and down until Polaris is aligned in the StarPointer and visible in the eyepiece. Now recycle the power on the NexStar and begin the AutoAlign procedure as follows:

1. When the hand control asks you to point the tube north and level, use the arrow keys to rotate the telescope tube downward until the tube is perpendicular (at 90°) with the fork arm.
2. Continue to enter the date and time as requested. When asked to "choose location", you must scroll down to the *Enter Long / Lat* option. Since the telescope's fork arm is pointed at the celestial pole (Polaris), you will need to enter location information as if you were doing an Alt-Az alignment from the North Pole. To accomplish this, when asked for your locations latitude, input the number +89° (-89° for observing in the southern hemisphere). When asked for longitude, input the longitude for your current location. A list of longitudes and latitudes can be obtained in most Atlases or on the Celestron web site. You will probably want to save this location in the database if you will be observing often from an equatorial wedge.

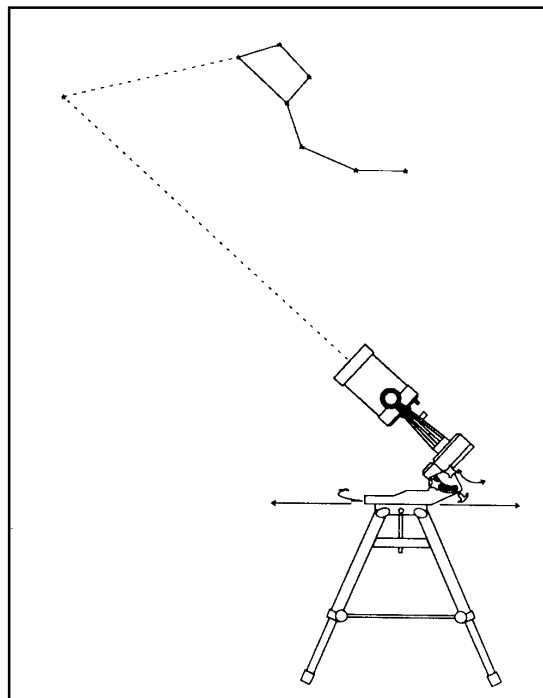

Figure 7-3

This is how the telescope is to be set up for polar alignment. The tube should be parallel to the fork arm which should be pointed to Polaris.

3. Once complete the NexStar will automatically slew to the first alignment star. If the star that is chosen is in the north, it may be below the horizon. If so, abort the slew by pressing any of the arrow direction buttons before the telescope tube comes into contact with the base. Press the UNDO button to select an alignment star that is above the horizon. Use the hand control to center the alignment star with the Star Pointer and press ENTER, then center the star in the eyepiece and press ALIGN. Repeat this step with the second alignment star. For complete *AutoAlign* procedures, see *NexStar GT* section of this manual.
4. Now that the NexStar is polar aligned switch the tracking mode to *EQ North*. This will turn off the altitude motor and allow the Azimuth motor to track like a right ascension tracking motor. To switch to *EQ North* tracking, press the MENU button and press ENTER at the Tracking Mode sub-menu. Use the scroll buttons to select *EQ North* and press ENTER.

Photography with the NexStar 4

After looking at the night sky for a while you may want to try photographing it. In addition to the specific accessories required for celestial photography, there is the need for a camera - but not just any camera. The camera does not have to have many of the features offered on today's state-of-the-art equipment. For example, you don't need auto focus capability or mirror lock up. Here are the mandatory features a camera needs for celestial photography. First, a "B" setting which allows for time exposures. This excludes point and shoot cameras and limits the selection to SLR cameras, the most common type of 35mm camera on the market today.

Second, the "B" or manual setting should NOT run off the battery. Many new electronic cameras use the battery to keep the shutter open during time exposures. Once the batteries are drained, usually after a few minutes, the shutter closes, whether you were finished with the exposure or not. Look for a camera that has a manual shutter when operating in the time exposure mode. Olympus, Nikon, Minolta, Pentax, Canon and others have made such camera bodies.

The camera must have interchangeable lenses so you can attach it to the telescope and so you can use a variety of lenses for piggyback photography. If you can't find a new camera, you can purchase a used camera body that is not 100-percent functional. The light meter, for example, does not have to be operational since you will be determining the exposure length manually.

You also need a cable release with a locking function to hold the shutter open while you do other things. Mechanical and air release models are available.

Attaching a Camera to the NexStar

The NexStar 4 has a special adaptor port located on the back of the rear cell to connect a 35mm camera body. Attaching a camera to the NexStar requires the use of the optional T-adaptor (#93635-A) and a T-ring specific to the brand of camera being used. To attach the photographic accessories:

1. Remove the screw-on cover from the photo adaptor port on the rear cell.
2. Thread the T-adaptor securely onto the photo adaptor port.
3. Thread the T-ring onto the exposed end of the T-adaptor.
4. Remove any lens from the body of your camera.
5. Attach the camera body to the T-ring by aligning the red dot on the side of the T-ring with the dot on the camera body and twisting.

Before attempting photography through your NexStar make sure that the flip mirror is in the "down" position. This will allow the light path to go straight through the optical tube and pass directly into the camera.

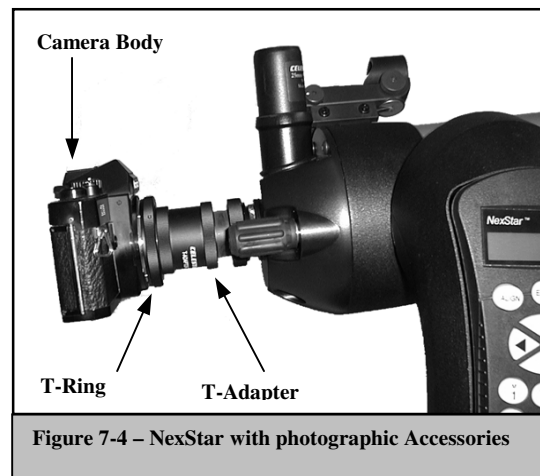

Figure 7-4 – NexStar with photographic Accessories

Finding the North Celestial Pole

In each hemisphere, there is a point in the sky around which all the other stars appear to rotate. These points are called the celestial poles and are named for the hemisphere in which they reside. For example, in the northern hemisphere all stars move around the north celestial pole. When the telescope's polar axis is pointed at the celestial pole, it is parallel to the Earth's rotational axis.

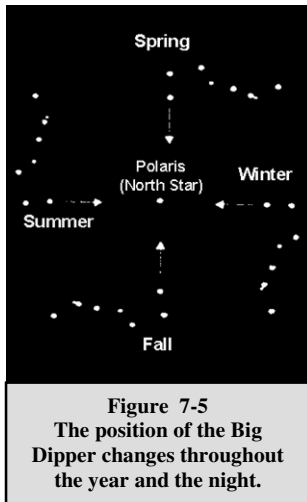

Figure 7-5
The position of the Big Dipper changes throughout the year and the night.

Many methods of polar alignment require that you know how to find the celestial pole by identifying stars in the area. For those in the northern hemisphere, finding the celestial pole is not too difficult. Fortunately, we have a naked eye star less than a degree away. This star, Polaris, is the end star in the handle of the Little Dipper. Since the Little Dipper (technically called Ursa Minor) is not one of the brightest constellations in the sky, it may be difficult to locate from urban areas. If this is the case, use the two end stars in the bowl of the Big Dipper (the pointer stars). Draw an imaginary line through them toward the Little Dipper. They point to Polaris (see Figure 7-5). The position of the Big Dipper changes during the year and throughout the course of the night (see Figure 7-5). When the Big Dipper is low in the sky (i.e., near the horizon), it may be difficult to locate. During these times, look for Cassiopeia (see Figure 7-6). Observers in the southern hemisphere are not as fortunate as those in the northern hemisphere. The stars around the south celestial pole are not nearly as bright as those around the north. The closest star that is relatively bright is Sigma Octantis. This star is just within naked eye limit (magnitude 5.5) and lies about 59 arc minutes from the pole.

Definition

The north celestial pole is the point in the northern hemisphere around which all stars appear to rotate. The counterpart in the southern hemisphere is referred to as the south celestial pole.

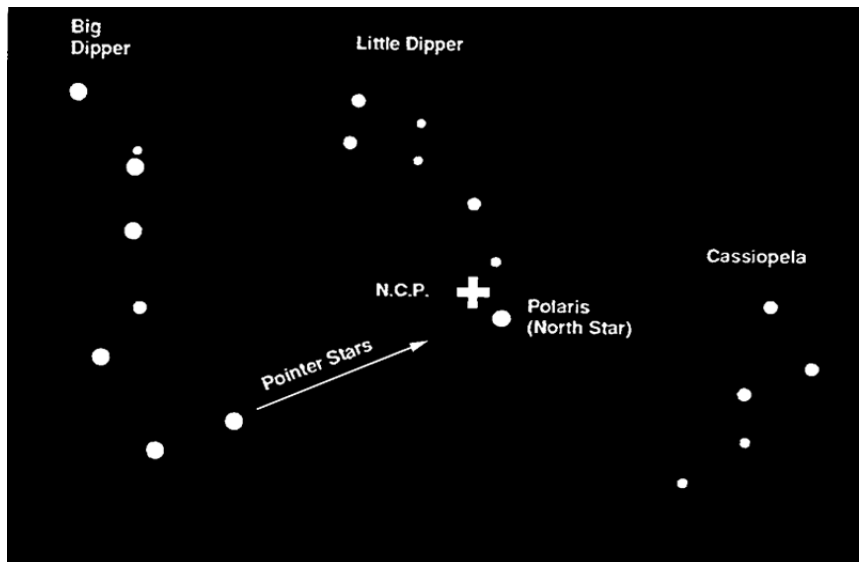

Figure 7-6
The two stars in the front of the bowl of the Big Dipper point to Polaris which is less than one degree from the true (north) celestial pole. Cassiopeia, the "W" shaped constellation, is on the opposite side of the pole from the Big Dipper. The North Celestial Pole (N.C.P.) is marked by the "+" sign.

CELESTRON **Celestial Observing**

With your telescope set up, you are ready to use it for observing. This section covers visual observing hints for both solar system and deep sky objects as well as general observing conditions which will affect your ability to observe.

Observing the Moon

Often, it is tempting to look at the Moon when it is full. At this time, the face we see is fully illuminated and its light can be overpowering. In addition, little or no contrast can be seen during this phase.

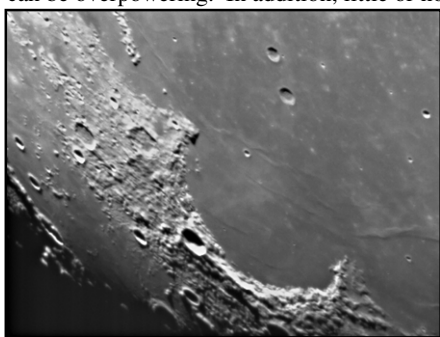

One of the best times to observe the Moon is during its partial phases (around the time of first or third quarter). Long shadows reveal a great amount of detail on the lunar surface. At low power you will be able to see most of the lunar disk at one time. Change to higher power (magnification) to focus in on a smaller area. Choose the *lunar* tracking rate from the NexStar's MENU tracking rate options to keep the moon centered in the eyepiece even at high magnifications.

Lunar Observing Hints

- To increase contrast and bring out detail on the lunar surface, use filters. A yellow filter works well at improving contrast while a neutral density or polarizing filter will reduce overall surface brightness and glare.

Observing the Planets

Other fascinating targets include the five naked eye planets. You can see Venus go through its lunar-like phases. Mars can reveal a host of surface detail and one, if not both, of its polar caps. You will be able to see the cloud belts of Jupiter and the great Red Spot (if it is visible at the time you are observing). In addition, you will also be able to see the moons of Jupiter as they orbit the giant planet. Saturn, with its beautiful rings, is easily visible at moderate power.

Planetary Observing Hints

- Remember that atmospheric conditions are usually the limiting factor on how much planetary detail will be visible. So, avoid observing the planets when they are low on the horizon or when they are directly over a source of radiating heat, such as a rooftop or chimney. See the "*Seeing Conditions*" section later in this section.
- To increase contrast and bring out detail on the planetary surface, try using Celestron eyepiece filters.

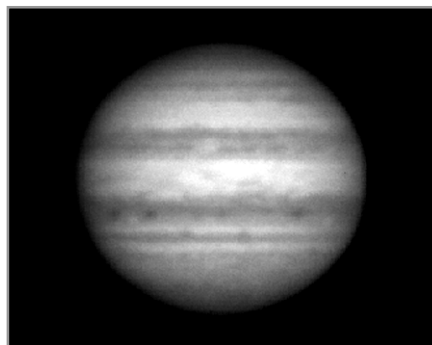

Observing the Sun

Although overlooked by many amateur astronomers, solar observation is both rewarding and fun. However, because the Sun is so bright, special precautions must be taken when observing our star so as not to damage your eyes or your telescope.

Never project an image of the Sun through the telescope. Because of the folded optical design, tremendous heat build-up will result inside the optical tube. This can damage the telescope and/or any accessories attached to the telescope.

For safe solar viewing, use a solar filter that reduces the intensity of the Sun's light, making it safe to view. With a filter you can see sunspots as they move across the solar disk and faculae, which are bright patches seen near the Sun's edge.

Solar Observing Hints

- The best time to observe the Sun is in the early morning or late afternoon when the air is cooler.
- To center the Sun without looking into the eyepiece, watch the shadow of the telescope tube until it forms a circular shadow.
- To ensure accurate tracking, be sure to select solar tracking rate.

Observing Deep Sky Objects

Deep-sky objects are simply those objects outside the boundaries of our solar system. They include star clusters, planetary nebulae, diffuse nebulae, double stars and other galaxies outside our own Milky Way. Most deep-sky objects have a large angular size. Therefore, low-to-moderate power is all you need to see them. Visually, they are too faint to reveal any of the color seen in long exposure photographs. Instead, they appear black and white. And, because of their low surface brightness, they should be observed from a dark-sky location. Light pollution around large urban areas washes out most nebulae making them difficult, if not impossible, to observe. Light Pollution Reduction filters help reduce the background sky brightness, thus increasing contrast.

Seeing Conditions

Viewing conditions affect what you can see through your telescope during an observing session. Conditions include transparency, sky illumination, and seeing. Understanding viewing conditions and the effect they have on observing will help you get the most out of your telescope.

Transparency

Transparency is the clarity of the atmosphere which is affected by clouds, moisture, and other airborne particles. Thick cumulus clouds are completely opaque while cirrus can be thin, allowing the light from the brightest stars through. Hazy skies absorb more light than clear skies making fainter objects harder to see and reducing contrast on brighter objects. Aerosols ejected into the upper atmosphere from volcanic eruptions also affect transparency. Ideal conditions are when the night sky is inky black.

Sky Illumination

General sky brightening caused by the Moon, aurorae, natural airglow, and light pollution greatly affect transparency. While not a problem for the brighter stars and planets, bright skies reduce the contrast of extended nebulae making them difficult, if not impossible, to see. To maximize your observing, limit deep sky viewing to moonless nights far from the light polluted skies found around major urban areas. LPR filters enhance deep sky viewing from light polluted areas by blocking unwanted light while transmitting light from certain deep sky objects. You can, on the other hand, observe planets and stars from light polluted areas or when the Moon is out.

Seeing

Seeing conditions refers to the stability of the atmosphere and directly affects the amount of fine detail seen in extended objects. The air in our atmosphere acts as a lens which bends and distorts incoming light rays. The amount of bending depends on air density. Varying temperature layers have different densities and, therefore, bend light differently. Light rays from the same object arrive slightly displaced creating an imperfect or smeared image. These atmospheric disturbances vary from time-to-time and place-to-place. The size of the air parcels compared to your aperture determines the "seeing" quality. Under good seeing conditions, fine detail is visible on the brighter planets like Jupiter and Mars, and stars are pinpoint images. Under poor seeing conditions, images are blurred and stars appear as blobs.

The conditions described here apply to both visual and photographic observations.

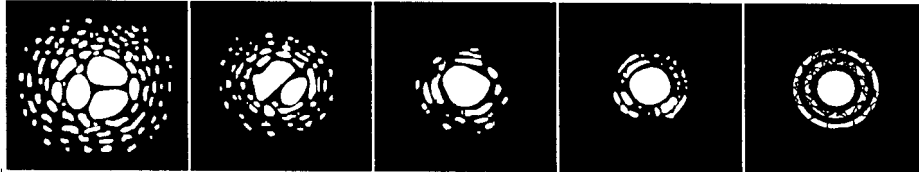

Figure 8-1

Seeing conditions directly affect image quality. These drawings represent a point source (i.e., star) under bad seeing conditions (left) to excellent conditions (right). Most often, seeing conditions produce images that lie some where between these two extremes.



While your NexStar telescope requires little maintenance, there are a few things to remember that will ensure your telescope performs at its best.

Care and Cleaning of the Optics

Occasionally, dust and/or moisture may build up on the corrector plate of your telescope. Special care should be taken when cleaning any instrument so as not to damage the optics.

If dust has built up on the corrector plate, remove it with a brush (made of camel's hair) or a can of pressurized air. Spray at an angle to the lens for approximately two to four seconds. Then, use an optical cleaning solution and white tissue paper to remove any remaining debris. Apply the solution to the tissue and then apply the tissue paper to the lens. Low pressure strokes should go from the center of the corrector to the outer portion. **Do NOT rub in circles!**

You can use a commercially made lens cleaner or mix your own. A good cleaning solution is isopropyl alcohol mixed with distilled water. The solution should be 60% isopropyl alcohol and 40% distilled water. Or, liquid dish soap diluted with water (a couple of drops per one quart of water) can be used.

Occasionally, you may experience dew build-up on the corrector plate of your telescope during an observing session. If you want to continue observing, the dew must be removed, either with a hair dryer (on low setting) or by pointing the telescope at the ground until the dew has evaporated.

If moisture condenses on the inside of the corrector, remove the accessories from the rear cell of the telescope. Place the telescope in a dust-free environment and point it down. This will remove the moisture from the telescope tube.

To minimize the need to clean your telescope, replace all lens covers once you have finished using it. Since the rear cell is NOT sealed, the cover should be placed over the opening when not in use. This will prevent contaminants from entering the optical tube.

Internal adjustments and cleaning should be done only by the Celestron repair department. If your telescope is in need of internal cleaning, please call the factory for a return authorization number and price quote.



CELESTRON

Optional Accessories

You will find that additional accessories enhance your viewing pleasure and expand the usefulness of your telescope. For ease of reference, all the accessories are listed in alphabetical order.

Adapter, AC (#18770) – Allows DC (battery) powered telescopes to be converted for use with 120 volt AC power. The adapter attaches to any standard wall outlet.

Adapter, Car Battery (#18769) -

Celestron offers the Car Battery Adapter that allows you to run the NexStar drive off an external power source. The adapter attaches to the cigarette lighter of your car, truck, van, or motorcycle.



Barlow Lens - A Barlow lens is a negative lens that increases the focal length of a telescope. Used with any eyepiece, it doubles the magnification of that eyepiece. Celestron offers two Barlow lens in the 1-1/4" size for the NexStar. The 2x Ultima Barlow (#93506) is a compact triplet design that is fully multicoated for maximum light transmission and parfocal when used with the Ultima eyepieces. Model #93507 is a compact achromatic Barlow lens that is under three inches long and weighs only 4 oz. It works very well with all Celestron eyepieces.

Carrying Case (#302080) - This case fits both the NexStar 4 and NexStar 5 and is made of sturdy ABS plastic. It is completely lined with pick-n-pluck foam for a customized and secure fit to safely transport and store your scope and accessories..

Eyepieces - Like telescopes, eyepieces come in a variety of designs. Each design has its own advantages and disadvantages. For the 1-1/4" barrel diameter there are four different eyepiece designs available.

- **Super Modified Achromatic (SMA) Eyepieces: 1 1/4"**

The SMA design is an improved version of the Kellner eyepiece. SMA's are very good, economical, general purpose eyepieces that deliver a wide apparent field, good color correction and an excellent image at the center of the field of view. Celestron offers SMA eyepieces in 1-1/4" sizes in the following focal lengths: 6mm, 10mm, 12mm, 17mm and 25mm.

- **Plössl** - Plössl eyepieces have a 4-element lens designed for low-to-high power observing. The Plössls offer razor sharp views across the entire field, even at the edges! In the 1-1/4" barrel diameter, they are available in the following focal lengths: 3.6mm, 6mm, 8mm, 10mm, 13mm, 17mm, 25mm, 32mm and 40mm.

- **Ultima** - Ultima is not really a design, but a trade name for our 5-element, wide field eyepieces. In the 1-1/4" barrel diameter, they are available in the following focal lengths: 5mm, 7.5mm, 12.5mm, 18mm, 30mm, 35mm, and 42mm. These eyepieces are all parfocal. The 35mm Ultima gives the widest possible field of view with a 1-1/4" diagonal .

- **Lanthanum Eyepieces (LV Series)** - Lanthanum is a unique rare earth glass used in one of the field lenses of this new eyepiece. The Lanthanum glass reduces aberrations to a minimum. All are fully multicoated and have an astounding 20mm of eye relief — perfect for eyeglass wearers! In the 1-1/4" barrel diameter, they are available in the following focal lengths: 2.5mm, 4mm, 5mm, 6mm, 9mm, 10mm, 12mm and 15mm. Celestron also offers the LV Zoom eyepiece (#3777) with a focal length of 8mm to 24mm. It offers an apparent field of 40° at 24mm and 60° at 8mm. Eye relief ranges from 15mm to 19mm.



Eyepiece Filters - To enhance your visual observations of solar system objects, Celestron offers a wide range of colored filters that thread into the 1-1/4" oculars. Available individually are: #12 deep yellow, #21 orange, #25 red, #58 green, #80A light blue, #96 neutral density - 25%T, #96 neutral density - 13%T, and polarizing. These and other filters are also sold in sets.



Night Vision Flashlight - (#93588) - Celestron's premium model for astronomy, using two red LED's to preserve night vision better than red filters or other devices. Brightness is adjustable. Operates on a single 9 volt battery (included).

Red Astro Lite - (#93590) - An economical squeeze-type flashlight fitted with a red cap to help preserve your night vision. Remove the red cap for normal flashlight operation. Very compact size and handy key chain.

Light Pollution Reduction (LPR) Filter - These filters are designed to enhance your views of deep sky astronomical objects when viewed from urban areas. LPR Filters selectively reduce the transmission of certain wavelengths of light, specifically those produced by artificial lights. This includes mercury and high and low pressure sodium vapor lights. In addition, they also block unwanted natural light (sky glow) caused by neutral oxygen emission in our atmosphere. Celestron offers a model for 1-1/4" eyepieces (#94126A).

Hand Control, Upgrade (#93961) - Plugs into your NexStar HC to give you instant access to over 4,000 celestial objects. Combined with your telescope's built-in slew motors, your NexStar will have the ability to automatically find all the Messier objects, dozens of double stars and all the planets at a touch of a button. Hand control comes with built-in RS-232 communication port capable of interfacing with popular astronomy software.



Moon Filter (#94119-A) - Celestron's Moon Filter is an economical eyepiece filter for reducing the brightness of the moon and improving contrast, so greater detail can be observed on the lunar surface. The clear aperture is 21mm and the transmission is about 18%.

Planisphere (#93720) - A simple and inexpensive tool for all levels of observers, from naked eye viewers to users of highly sophisticated telescopes. The Celestron Planisphere makes it easy to locate stars for observing and is a great planet finder as well. A map of the night sky, oriented by month and day, rotates within a depiction of the 24 hours of the day, to display exactly which stars and planets will be visible at any given time. Ingeniously simple to use, yet quite effective. Made of durable materials and coated for added protection. Celestron Planispheres come in three different models, to match the latitude from which you're observing:

For 20° to 40° of latitude	#93720-30
For 30° to 50° of latitude	#93720-40
For 40° to 60° of latitude	#93720-50

Polarizing Filter Set (#93608) - The polarizing filter set limits the transmission of light to a specific plane, thus increasing contrast between various objects. This is used primarily for terrestrial, lunar and planetary observing.

Sky Maps (#93722) - Celestron Sky Maps are the ideal teaching guide for learning the night sky. You wouldn't set off on a road trip without a road map, and you don't need to try to navigate the night sky without a map either. Even if you already know your way around the major constellations, these maps can help you locate all kinds of fascinating objects.

T-Adapter (#93635-A) - T-Adapter (with additional T-Ring) allows you to attach your SLR camera to the rear cell of your Celestron NexStar. This turns your NexStar into a 1300mm telephoto lens perfect for terrestrial photography and short exposure lunar and filtered solar photography.



T-Ring - The T-Ring couples your 35mm SLR camera body to the T-Adapter. This accessory is mandatory if you want to do photography through the telescope. Each camera make (i.e., Minolta, Nikon, Pentax, etc.) has its own unique mount and therefore, its own T-Ring. Celestron has 8 different models for 35mm cameras.



Tripod, NexStar - A stable tripod is a must for serious astronomical observing and photography. This steel field tripod (#93497) folds down to a compact 8"x28". It is equipped with a built on wedge tilt plate for quick equatorial use and astrophotography. It has a metal center brace and accessory tray for added stability.

Vibration Suppression Pads (#93503) - These pads rest between the ground and tripod feet of your telescope. They reduce the amplitude and vibration time of your telescope when shaken by the wind or an accidental bump. This accessory is a must for long exposure prime focus photography.

A full description of all Celestron accessories can be found in the Celestron Accessory Catalog (#93685).

Appendix A - Technical Specifications

Optical Specification

Design	Maksutov-Cassegrain Catadioptric
Aperture	4 inches (102mm)
Focal Length	52 inches (1325mm)
F/ratio of the Optical System	13
Primary Mirror: Diameter Coatings	102mm Multi-layer coating process
Secondary Mirror Spot Size Secondary Obstruction	1.25" 34.4% by diameter; 11% by area
Corrector Plate: Material Coatings	BK-7 Optical Glass A-R Coatings both sides
Highest Useful Magnification	240x (~ 6mm eyepiece)
Lowest Useful Magnification (7mm exit pupil)	15x (~ 80mm eyepiece)
Resolution: Rayleigh Criterion Dawes Limit	1.36 arc seconds 1.14 arc seconds
Photographic Resolution	140 lines/mm
Light Gathering Power	212x unaided eye
Near Focus standard eyepiece or camera	~ 20 feet
Field of View: Standard Eyepiece : 35mm Camera	1.0° 1.51° x 1.04°
Linear Field of View (at 1000 yds)	52.5 feet
Magnification: Standard Eyepiece : Camera	55x 27x
Optical Tube Length	13.5 inches
Weight of Telescope	11 Lbs.

Electronic Specifications

Input Voltage Maximum Minimum	12 V DC Nominal 18 V DC Max. 8 V DC Min.
Batteries Required	8 AA Alkaline
Power Supply Requirements	12 VDC-750 mA (Tip positive)

Mechanical Specifications

Motor: Type Resolution	DC Servo motors with encoders, both axes .26 arc sec
Slew speeds	Nine slew speeds: 4°/sec, 2°/sec, 1°/sec, .5/sec, 32x, 16x, 8x, 4x, 2x
Hand Control	Double line, 16 character Liquid Crystal Display 19 fiber optic backlit LED buttons
Fork Arm	Cast aluminum, with integrated hand control receptacle

Software Specifications

Software Precision	16 bit, 20 arc sec. calculations
Ports	RS-232 communication port on hand control
Tracking Rates	Sidereal, Solar, Lunar and King
Tracking Modes	Alt-Az, EQ North & EQ South
Alignment Procedures	AutoAlign (2-star alignment)
Database	25 user defined programmable object. Enhanced information on over 100 objects
Total Object Database	4,033

Appendix B - Glossary of Terms

A-

Absolute magnitude	The apparent magnitude that a star would have if it were observed from a standard distance of 10 parsecs, or 32.6 light-years. The absolute magnitude of the Sun is 4.8. at a distance of 10 parsecs, it would just be visible on Earth on a clear moonless night away from surface light.
Airy disk	The apparent size of a star's disk produced even by a perfect optical system. Since the star can never be focused perfectly, 84 per cent of the light will concentrate into a single disk, and 16 per cent into a system of surrounding rings.
Alt-Azimuth Mounting	A telescope mounting using two independent rotation axis allowing movement of the instrument in Altitude and Azimuth.
Altitude	In astronomy, the altitude of a celestial object is its Angular Distance above or below the celestial horizon.
Aperture	the diameter of a telescope's primary lens or mirror; the larger the aperture, the greater the telescope's light-gathering power.
Apparent Magnitude	A measure of the relative brightness of a star or other celestial object as perceived by an observer on Earth.
Arcminute	A unit of angular size equal to 1/60 of a degree.
Arcsecond	A unit of angular size equal to 1/3,600 of a degree (or 1/60 of an arcminute).
Asterism	A small unofficial grouping of stars in the night sky.
Asteroid	A small, rocky body that orbits a star.
Astrology	The pseudoscientific belief that the positions of stars and planets exert an influence on human affairs; astrology has nothing in common with astronomy
Astronomical unit (AU)	The distance between the Earth and the Sun. It is equal to 149,597,900 km., usually rounded off to 150,000,000 km.
Aurora	The emission of light when charged particles from the solar wind slams into and excites atoms and molecules in a planet's upper atmosphere.
Azimuth	The angular distance of an object eastwards along the horizon, measured from due north, between the astronomical meridian (the vertical line passing through the center of the sky and the north and south points on the horizon) and the vertical line containing the celestial body whose position is to be measured. .

B -

Binary Stars	Binary (Double) stars are pairs of stars that, because of their mutual gravitational attraction, orbit around a common Center of Mass. If a group of three or more stars revolve around one another, it is called a multiple system. It is believed that approximately 50 percent of all stars belong to binary or multiple systems. Systems with individual components that can be seen separately by a telescope are called visual binaries or visual multiples. The nearest "star" to our solar system, Alpha Centauri, is actually our nearest example of a multiple star system, it consists of three stars, two very similar to our Sun and one dim, small, red star orbiting around one another.
--------------	---

C -

Celestial Equator	The projection of the Earth's equator on to the celestial sphere. It divides the sky into two equal hemispheres.
Celestial pole	The imaginary projection of Earth's rotational axis north or south pole onto the celestial sphere.
Celestial Sphere	An imaginary sphere surrounding the Earth, concentric with the Earth's center.
Collimation	The act of putting a telescope's optics into perfect alignment.

D -

Declination (DEC)	The angular distance of a celestial body north or south of the celestial equator. It may be said to correspond to latitude on the surface of the Earth.
-------------------	---

E -

Ecliptic	The projection of the Earth's orbit on to the celestial sphere. It may also be defined as "the apparent yearly path of the Sun against the stars".
Equatorial mount	A telescope mounting in which the instrument is set upon an axis which is parallel to the axis of the Earth; the angle of the axis must be equal to the observer's latitude.

F - Focal length	The distance between a lens (or mirror) and the point at which the image of an object at infinity is brought to focus. The focal length divided by the aperture of the mirror or lens is termed the focal ratio.
J - Jovian Planets	Any of the four gas giant planets that are at a greater distance from the sun than the terrestrial planets.
K - Kuiper Belt	A region beyond the orbit of Neptune extending to about 1000 AU which is a source of many short period comets.
L - Light-Year (ly)	A light-year is the distance light traverses in a vacuum in one year at the speed of 299,792 km/ sec. With 31,557,600 seconds in a year, the light-year equals a distance of 9.46 X 1 trillion km (5.87 X 1 trillion mi).
M - Magnitude	Magnitude is a measure of the brightness of a celestial body. The brightest stars are assigned magnitude 1 and those increasingly fainter from 2 down to magnitude 5. The faintest star that can be seen without a telescope is about magnitude 6. Each magnitude step corresponds to a ratio of 2.5 in brightness. Thus a star of magnitude 1 is 2.5 times brighter than a star of magnitude 2, and 100 times brighter than a magnitude 5 star. The brightest star, Sirius, has an apparent magnitude of -1.6, the full moon is -12.7, and the Sun's brightness, expressed on a magnitude scale, is -26.78. The zero point of the apparent magnitude scale is arbitrary.
Meridian	A reference line in the sky that starts at the North celestial pole and ends at the South celestial pole and passes through the zenith. If you are facing South, the meridian starts from your Southern horizon and passes directly overhead to the North celestial pole.
Messier	A French astronomer in the late 1700's who was primarily looking for comets. Comets are hazy diffuse objects and so Messier cataloged objects that were not comets to help his search. This catalog became the Messier Catalog, M1 through M110.
N - Nebula	Interstellar cloud of gas and dust. Also refers to any celestial object that has a cloudy appearance.
North Celestial Pole	The point in the Northern hemisphere around which all the stars appear to rotate. This is caused by the fact that the Earth is rotating on an axis that passes through the North and South celestial poles. The star Polaris lies less than a degree from this point and is therefore referred to as the "Pole Star".
Nova	Although Latin for "new" it denotes a star that suddenly becomes explosively bright at the end of its life cycle.
O - Open Cluster	One of the groupings of stars that are concentrated along the plane of the Milky Way. Most have an asymmetrical appearance and are loosely assembled. They contain from a dozen to many hundreds of stars.
P - Parallax	Parallax is the difference in the apparent position of an object against a background when viewed by an observer from two different locations. These positions and the actual position of the object form a triangle from which the apex angle (the parallax) and the distance of the object can be determined if the length of the baseline between the observing positions is known and the angular direction of the object from each position at the ends of the baseline has been measured. The traditional method in astronomy of determining the distance to a celestial object is to measure its parallax.
Parfocal	Refers to a group of eyepieces that all require the same distance from the focal plane of the telescope to be in focus. This means when you focus one parfocal eyepiece all the other parfocal eyepieces, in a particular line of eyepieces, will be in focus.
Parsec	The distance at which a star would show parallax of one second of arc. It is equal to 3.26 light-years, 206,265 astronomical units, or 30,800,000,000,000 km. (Apart from the Sun, no star lies within one parsec of us.)
Point Source	An object which cannot be resolved into an image because it is too far away or too small is considered a point source. A planet is far away but it can be resolved as a disk. Most stars cannot be resolved as disks, they are too far away.
R - Reflector	A telescope in which the light is collected by means of a mirror.

Resolution	The minimum detectable angle an optical system can detect. Because of diffraction, there is a limit to the minimum angle, resolution. The larger the aperture, the better the resolution.
Right Ascension: (RA)	The angular distance of a celestial object measured in hours, minutes, and seconds along the Celestial Equator eastward from the Vernal Equinox.
S -	
Sidereal Rate	This is the angular speed at which the Earth is rotating. Telescope tracking motors drive the telescope at this rate. The rate is 15 arc seconds per second or 15 degrees per hour.
T -	
Terminator	The boundary line between the light and dark portion of the moon or a planet.
U -	
Universe	The totality of astronomical things, events, relations and energies capable of being described objectively.
V -	
Variable Star	A star whose brightness varies over time due to either inherent properties of the star or something eclipsing or obscuring the brightness of the star.
W -	
Waning Moon	The period of the moon's cycle between full and new, when its illuminated portion is decreasing.
Waxing Moon	The period of the moon's cycle between new and full, when its illuminated portion is increasing.
Z -	
Zenith	The point on the Celestial Sphere directly above the observer.
Zodiac	The zodiac is the portion of the Celestial Sphere that lies within 8 degrees on either side of the Ecliptic. The apparent paths of the Sun, the Moon, and the planets, with the exception of some portions of the path of Pluto, lie within this band. Twelve divisions, or signs, each 30 degrees in width, comprise the zodiac. These signs coincided with the zodiacal constellations about 2,000 years ago. Because of the Precession of the Earth's axis, the Vernal Equinox has moved westward by about 30 degrees since that time; the signs have moved with it and thus no longer coincide with the constellations.

Appendix C - Maps of Time Zones

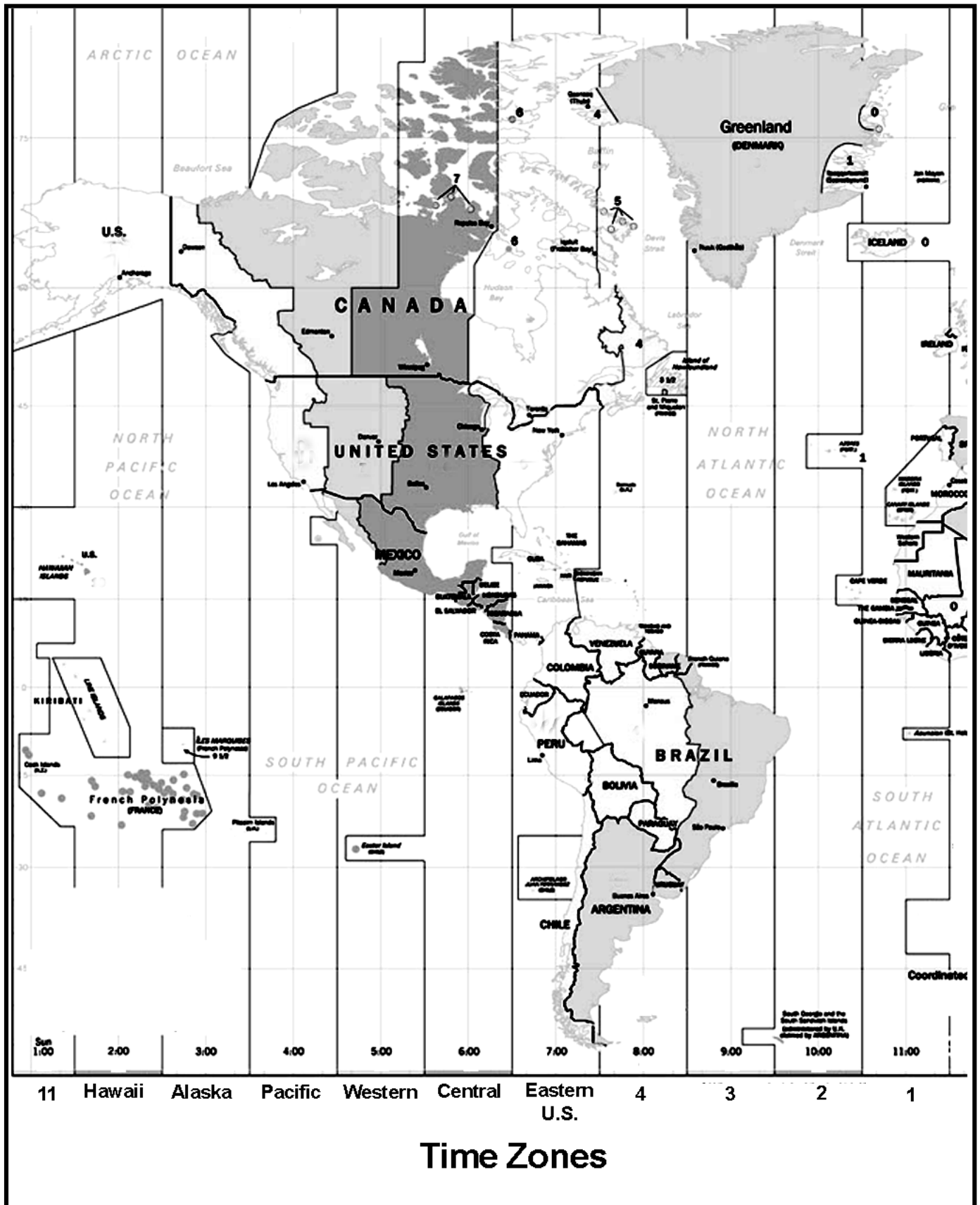

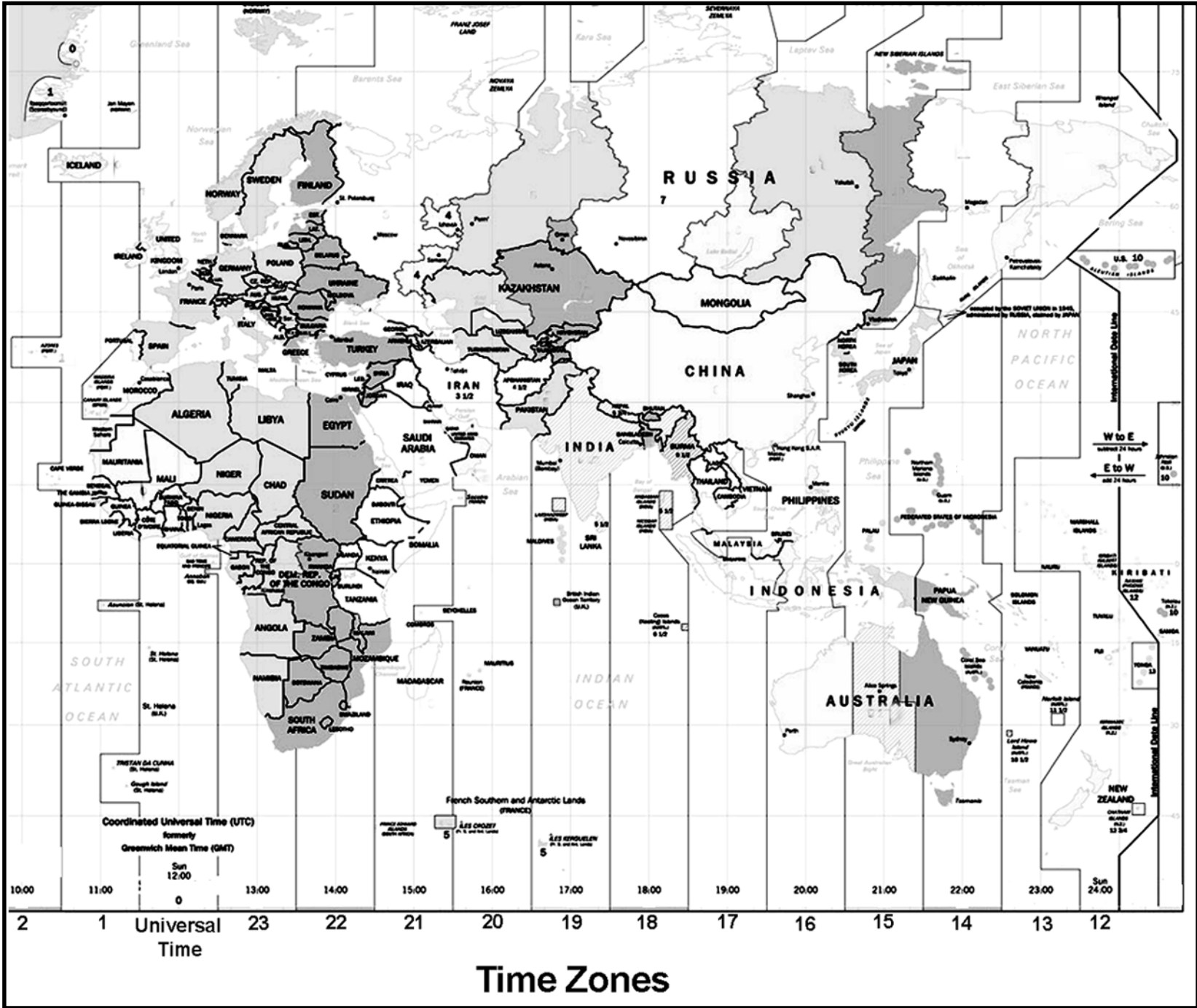

January - February Sky

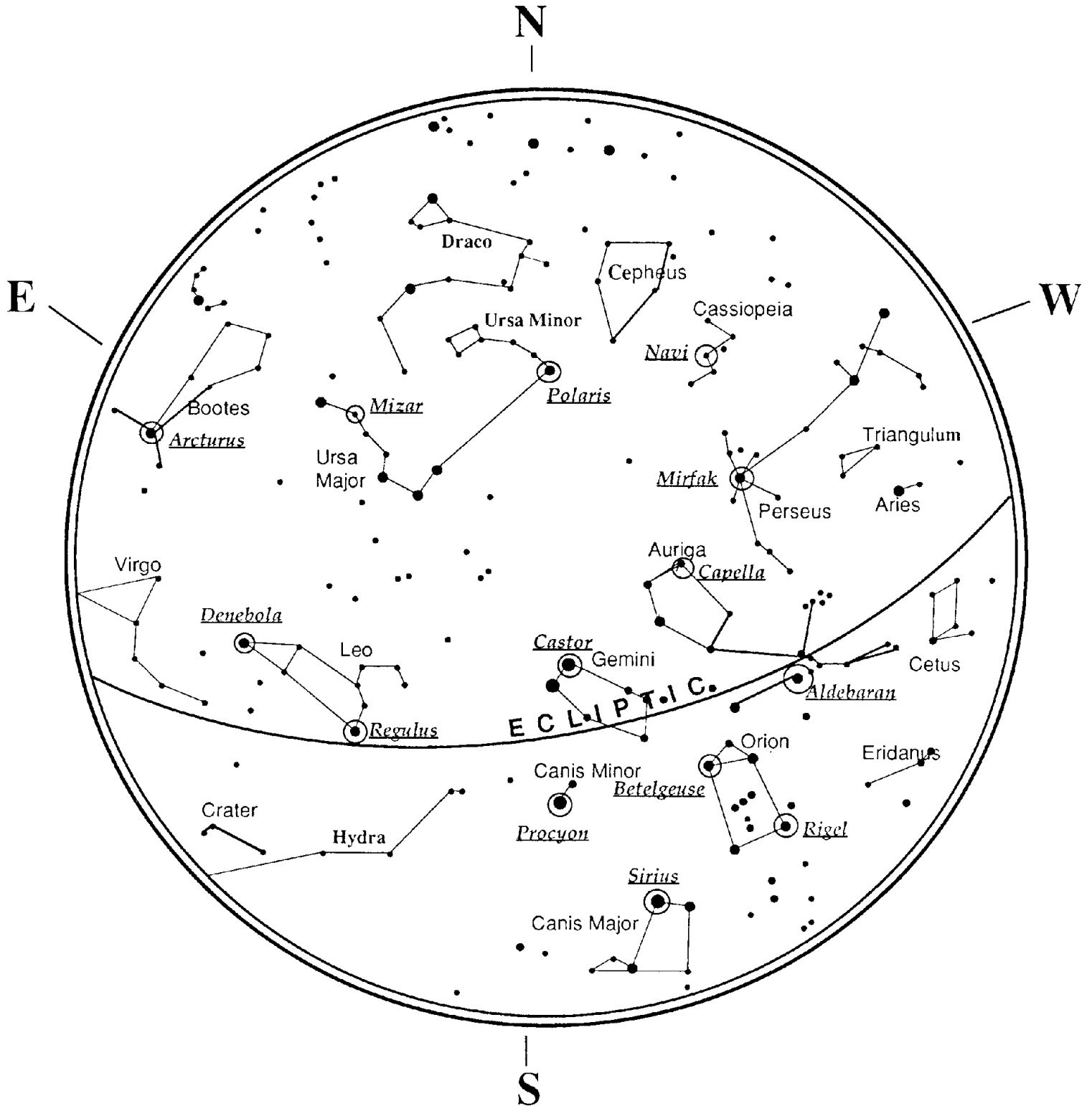

March - April Sky

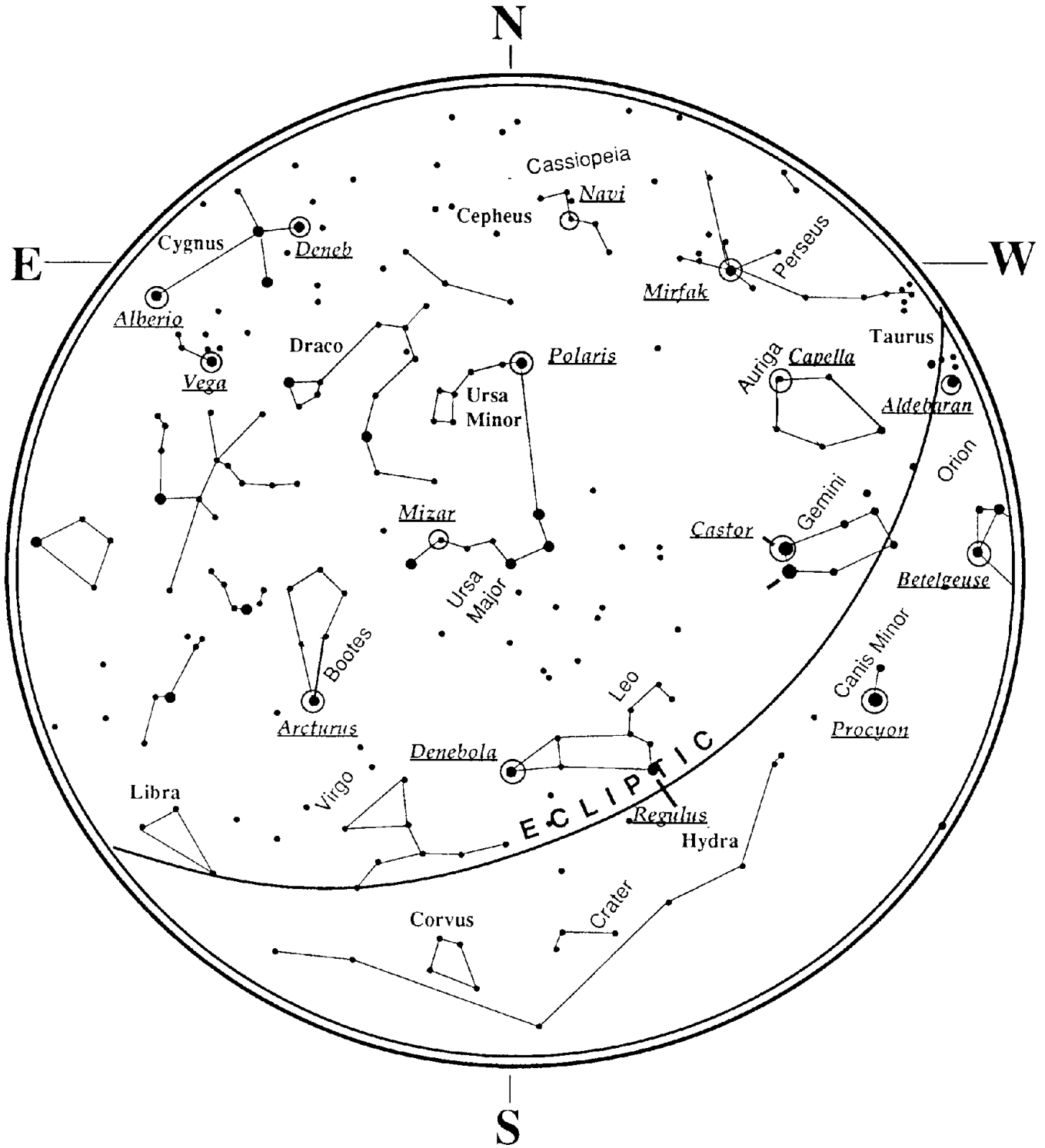

May - June Sky

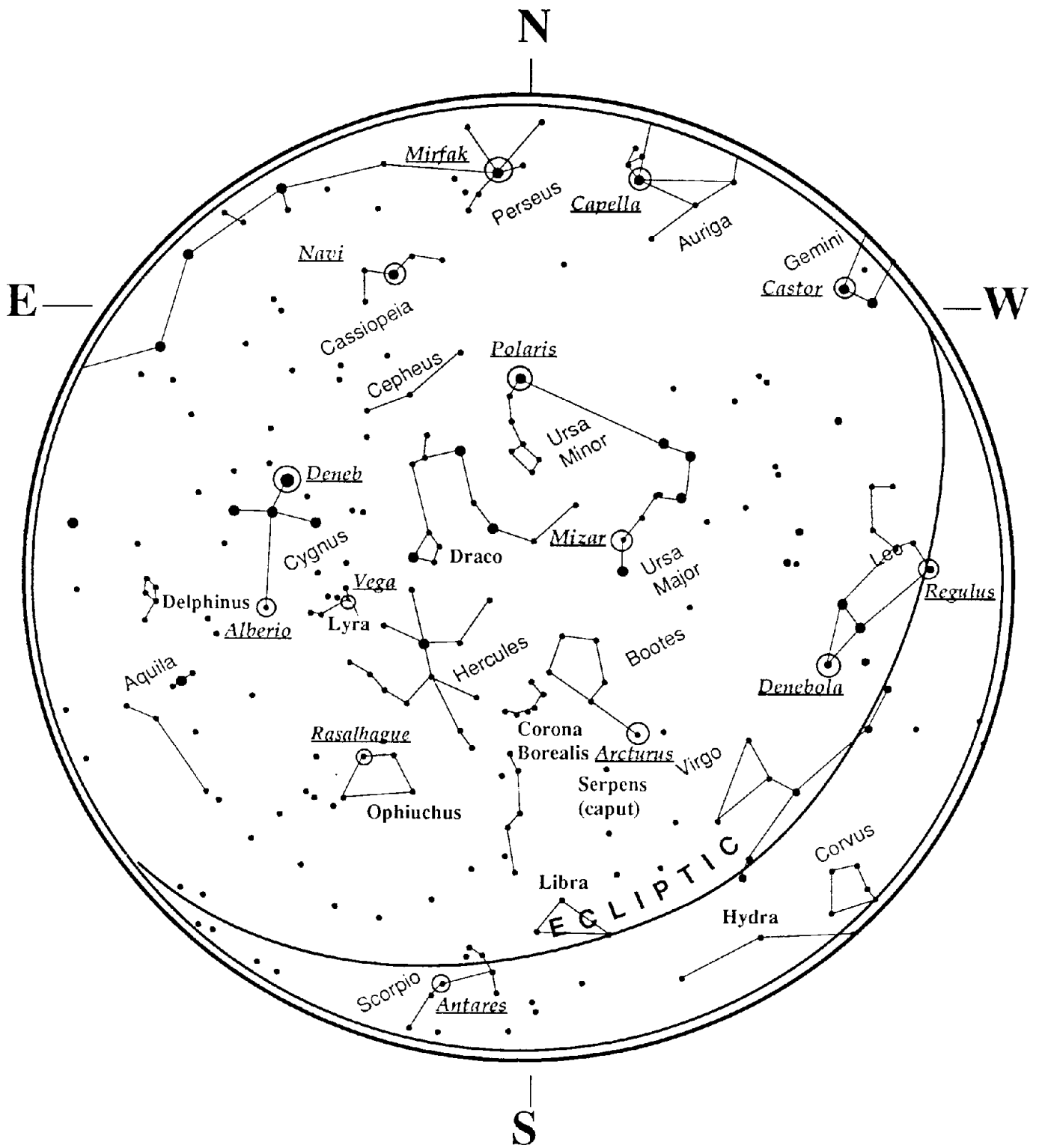

July - August Sky

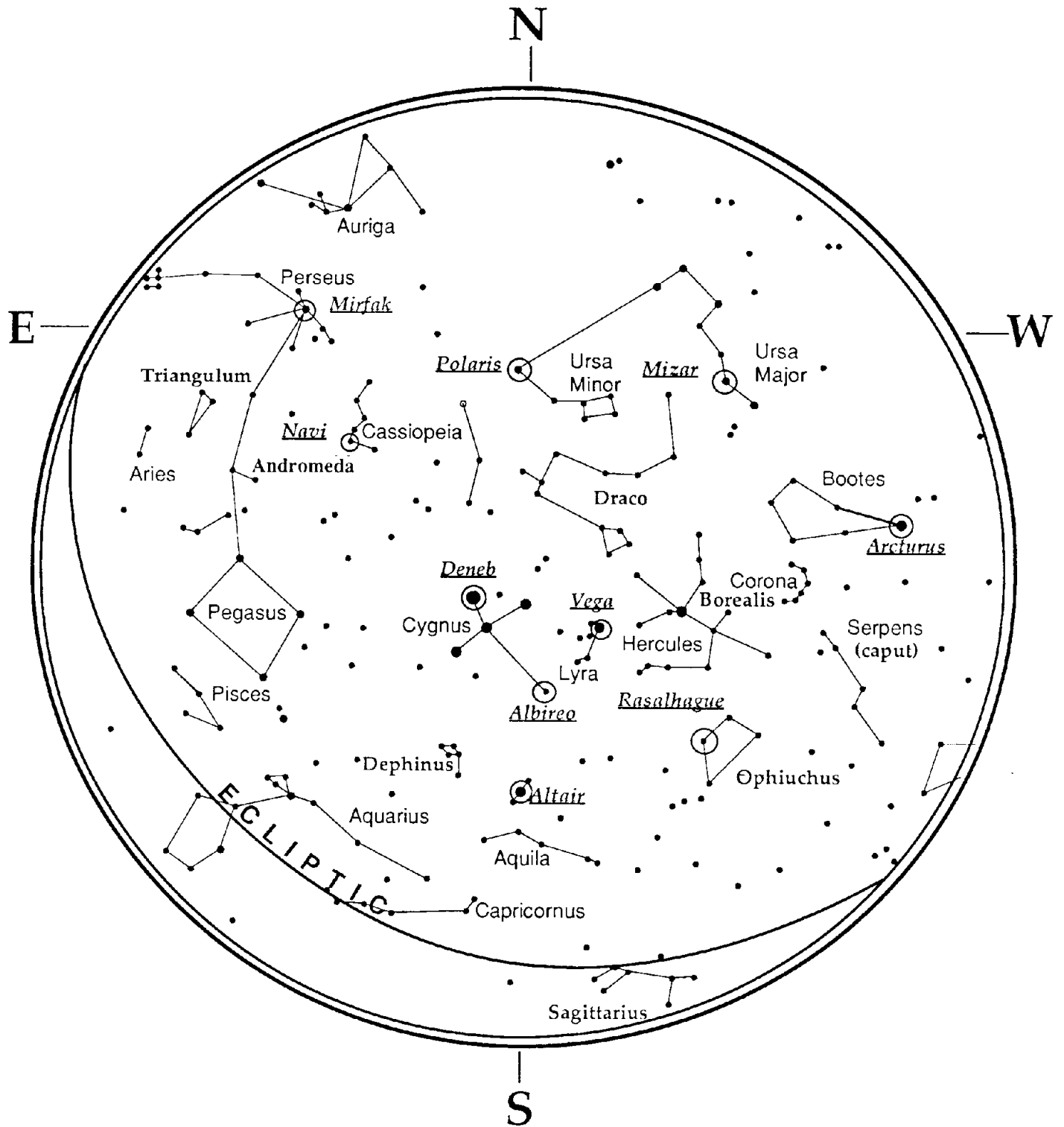

September - October Sky

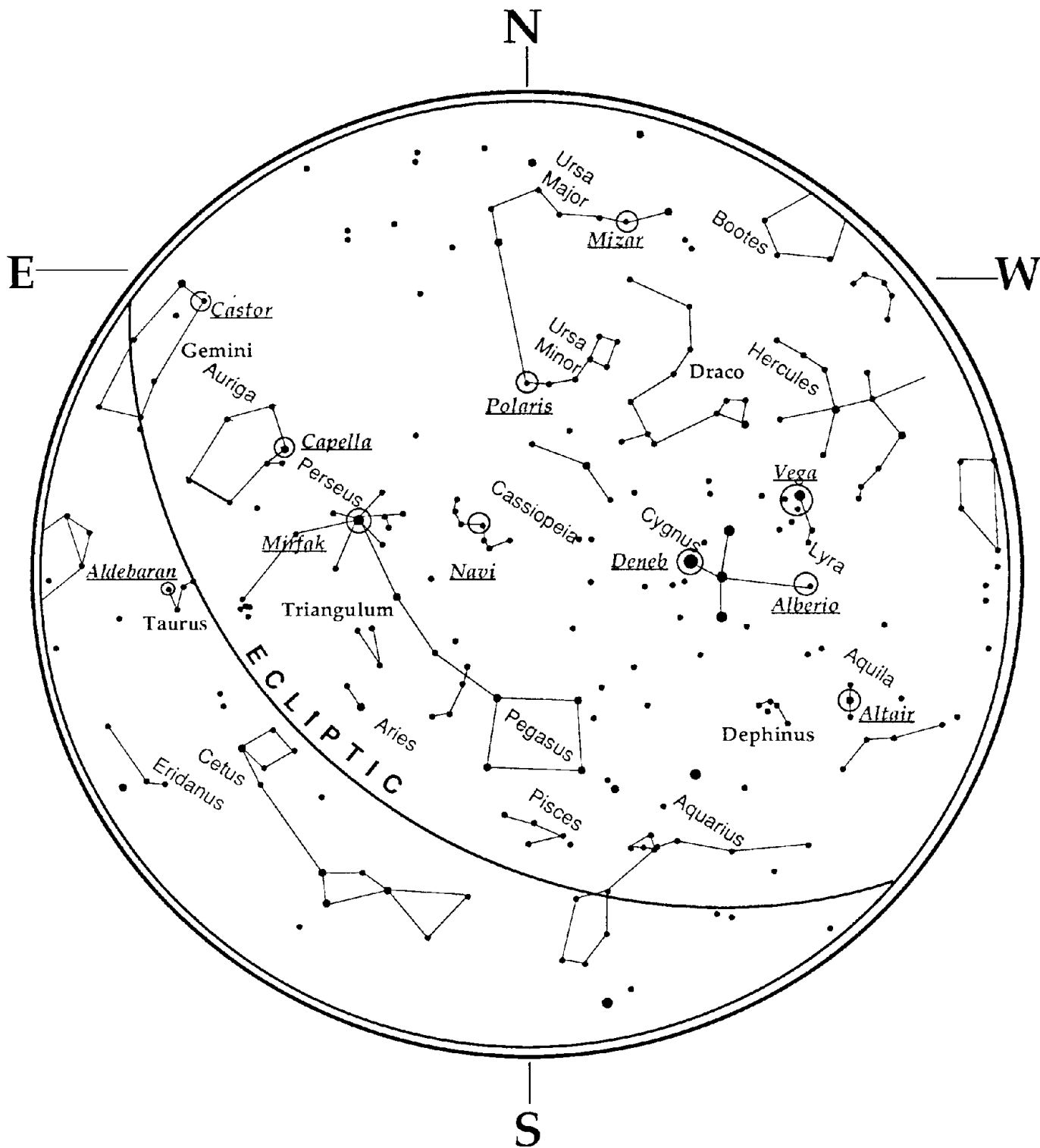

November - December Sky

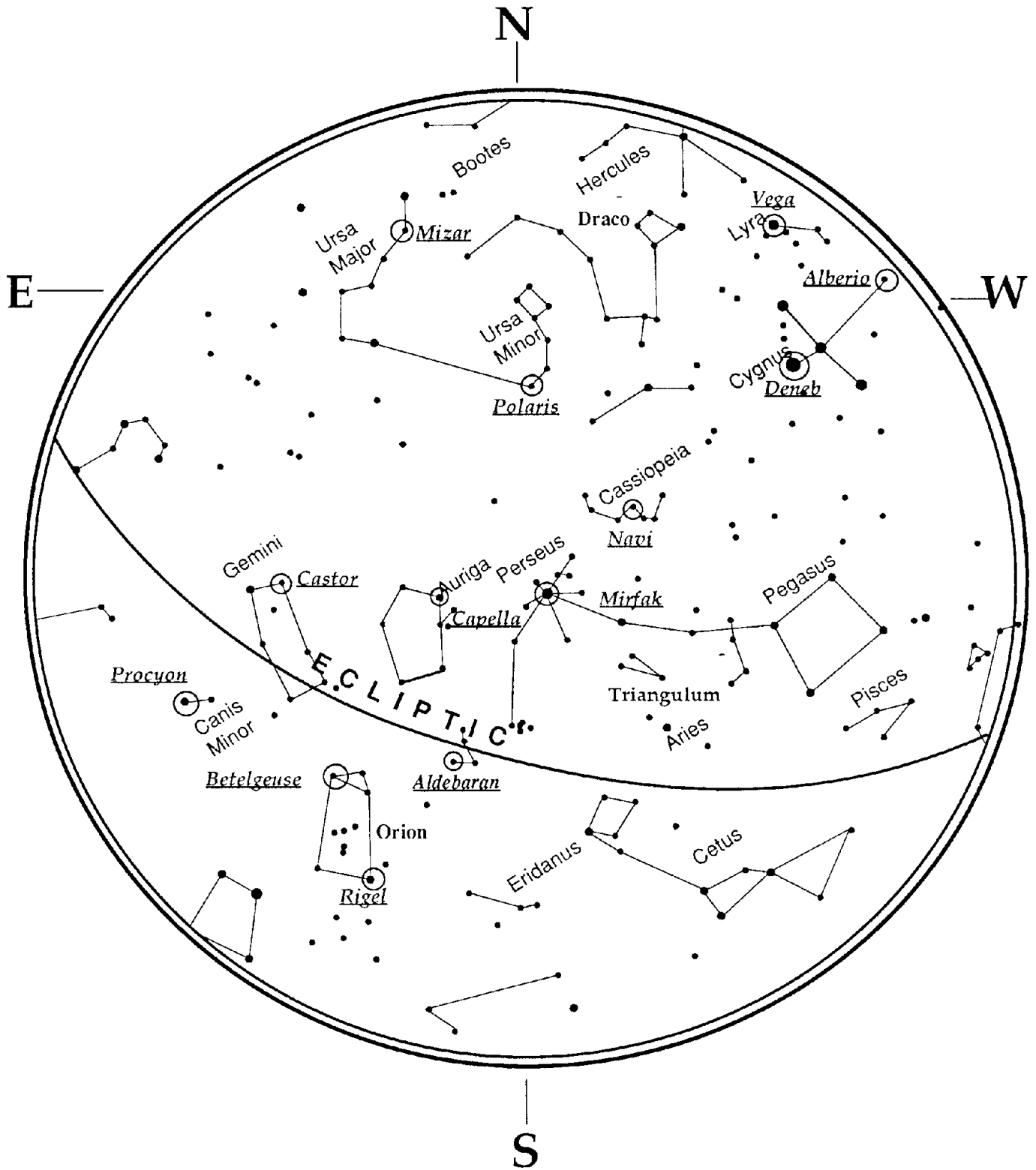

CELESTRON ONE YEAR WARRANTY

- A. Celestron International (CI) warrants this telescope to be free from defects in materials and workmanship for one year. CI will repair or replace such product or part thereof which, upon inspection by CI, is found to be defective in materials or workmanship. As a condition to the obligation of CI to repair or replace such product, the product must be returned to CI together with proof-of-purchase satisfactory to CI.
- B. The Proper Return Authorization Number must be obtained from CI in advance of return. Call Celestron at (310) 328-9560 to receive the number to be displayed on the outside of your shipping container.

All returns must be accompanied by a written statement setting forth the name, address, and daytime telephone number of the owner, together with a brief description of any claimed defects. Parts or product for which replacement is made shall become the property of CI.

The customer shall be responsible for all costs of transportation and insurance, both to and from the factory of CI, and shall be required to prepay such costs.

CI shall use reasonable efforts to repair or replace any telescope covered by this warranty within thirty days of receipt. In the event repair or replacement shall require more than thirty days, CI shall notify the customer accordingly. CI reserves the right to replace any product which has been discontinued from its product line with a new product of comparable value and function.

This warranty shall be void and of no force of effect in the event a covered product has been modified in design or function, or subjected to abuse, misuse, mishandling or unauthorized repair. Further, product malfunction or deterioration due to normal wear is not covered by this warranty.

CI DISCLAIMS ANY WARRANTIES, EXPRESS OR IMPLIED, WHETHER OF MERCHANTABILITY OF FITNESS FOR A PARTICULAR USE, EXCEPT AS EXPRESSLY SET FORTH HEREIN.

THE SOLE OBLIGATION OF CI UNDER THIS LIMITED WARRANTY SHALL BE TO REPAIR OR REPLACE THE COVERED PRODUCT, IN ACCORDANCE WITH THE TERMS SET FORTH HEREIN. CI EXPRESSLY DISCLAIMS ANY LOST PROFITS, GENERAL, SPECIAL, INDIRECT OR CONSEQUENTIAL DAMAGES WHICH MAY RESULT FROM BREACH OF ANY WARRANTY, OR ARISING OUT OF THE USE OR INABILITY TO USE ANY CI PRODUCT. ANY WARRANTIES WHICH ARE IMPLIED AND WHICH CANNOT BE DISCLAIMED SHALL BE LIMITED IN DURATION TO A TERM OF ONE YEAR FROM THE DATE OF ORIGINAL RETAIL PURCHASE.

Some states do not allow the exclusion or limitation of incidental or consequential damages or limitation on how long an implied warranty lasts, so the above limitations and exclusions may not apply to you.

This warranty gives you specific legal rights, and you may also have other rights which vary from state to state.

CI reserves the right to modify or discontinue, without prior notice to you, any model or style telescope.

If warranty problems arise, or if you need assistance in using your telescope contact:

Celestron International
Customer Service Department
2835 Columbia Street
Torrance, CA 90503
Tel. (310) 328-9560
Fax. (310) 212-5835
Monday-Friday 8AM-4PM PST

This warranty supersedes all other product warranties.

NOTE: This warranty is valid to U.S.A. and Canadian customers who have purchased this product from an Authorized CI Dealer in the U.S.A. or Canada. Warranty outside the U.S.A. and Canada is valid only to customers who purchased from a CI International Distributor or Authorized CI Dealer in the specific country and please contact them for any warranty service.



Celestron International
2835 Columbia Street
Torrance, CA 90503
Tel. (310) 328-9560
Fax. (310) 212-5835
Web site at <http://www.celestron.com>

Copyright 2000 Celestron International
All rights reserved.

(Products or instructions may change
without notice or obligation.)

This device complies with Part 15 of the FCC Rule. Operation is subject to the following two conditions: 1) This device may not cause harmful interference, and 2) This device must accept any interference received, including interference that may cause undesired operations.

#11041-I
Printed in China
\$10.00
10-00

ADDENDUM TO NEXSTAR 4 TELESCOPE MANUAL

This document contains useful information about your NexStar 4 telescope that may not have been included in your instruction manual at the time of printing. Listed below is information regarding the utility features described under the hand control section of the manual. Please refer to this addendum when using your NexStar 4 hand control.

Demo and Approach Length - These features are only used at the factory as diagnostic tools for quality control purposes and although they may appear on the hand control display they can not be accessed by the user.

Light Control – This feature allows some NexStar models to turn off both the red key pad light and LCD display for daytime use and to help preserve your night vision. This feature is not activated on the NexStar 4 model.

Model Select – The first time the NexStar is powered on, the hand control display allows you to select your NexStar from a list of different models. If for some reason the incorrect model was selected, the *Model Select* utility feature allows you to reset the hand control to its factory default settings.

The *Model Select* feature has a *Custom* option that allows you to enter the exact encoder-gear ratio for your individual NexStar model. For best possible pointing accuracy, this numeric gear ratio should be entered into the hand control should you ever need to re-select the telescope model. To enter the custom encoder-gear ratio for your NexStar model, follow the steps below:

1. When the hand control is turned-on, the display will read NexStar Ready, press the UNDO button to by-pass the AutoAlign procedure.
2. Press the MENU button and use the Up and Down scroll keys until *Model Select* is displayed on the screen, and press ENTER.
3. Use the Up and Down scroll keys to select *Custom* and press ENTER.
4. The display will read Azm = ???????. For the NexStar 4 model, enter the number 1059334 and press ENTER. Now enter the same number for altitude as you did for azimuth, Alt = 1059334 and press ENTER.
5. The hand control will now say Recycle Power. Re-start the power to the telescope to save the changes.

The telescope will now recognize your NexStar model as long as the custom setting is not changed.

Celestron International
Technical Support Department
2835 Columbia Street
Torrance, CA 90503
310-328-9560
310-212-5835 Fax
Monday – Friday 8am-4pm PST

Free Manuals Download Website

<http://myh66.com>

<http://usermanuals.us>

<http://www.somanuals.com>

<http://www.4manuals.cc>

<http://www.manual-lib.com>

<http://www.404manual.com>

<http://www.luxmanual.com>

<http://aubethermostatmanual.com>

Golf course search by state

<http://golfingnear.com>

Email search by domain

<http://emailbydomain.com>

Auto manuals search

<http://auto.somanuals.com>

TV manuals search

<http://tv.somanuals.com>