

# NEXT *step*™

*deluxe series*

## Instruction Manual



[www.centuryproducts.com](http://www.centuryproducts.com)

4001-5-02 40010502

**Avoid injury or death -  
Read and understand this manual!**

Download from [Www.Somanuals.com](http://Www.Somanuals.com). All Manuals Search And Download.

# TABLE OF CONTENTS

## W Before You Begin

Important Information.....	1
Warnings.....	2
Basic Information.....	4
What is <b>LATCH?</b> .....	5
<b>LATCH</b> System.....	6

## W Use

Height and Weight Limits.....	7
Installation <b>with</b> harness system and Vehicle Seat Belt.....	8
Installation <b>without</b> harness system and Vehicle Lap/Shoulder Belt.....	9
Installation <b>with</b> harness system and <b>LATCH</b> ...	10
Placing Child in Car Seat <b>with</b> harness system.....	12
Placing Child in Car Seat <b>without</b> harness system.....	14

Operations and Adjustments .....	16
• Harness Straps	
• Harness Tie	
• Buckle	
• Recline	
• Armrests	
• Tether Strap	
• Changing Harness Strap Slots	
• Changing Crotch Strap Slots	
Harness System– removal and re-assembly.....	20

## W Special Information

Vehicle Seat Belts.....	22
Locking Clip.....	29
Additional Information.....	30
• <b>LATCH</b> Storage	
• Tether Storage	
• Cup Holder	
• Care and Cleaning	
• Aircraft Use	
• Second Hand Car Seat	
Replacement Parts.....	36

# IMPORTANT INFORMATION

*NO CAR SEAT CAN GUARANTEE PROTECTION FROM INJURY IN EVERY SITUATION. HOWEVER, PROPER USE OF THIS CAR SEAT REDUCES THE RISK OF SERIOUS INJURY OR DEATH TO YOUR CHILD.*

**READ THIS MANUAL CAREFULLY.**

## W Registration Information

Child restraints (car seats) could be recalled for safety reasons. You must register this restraint to be reached in the event of a recall. Fill out the registration card attached to the car seat and mail today or send your name, address, and the restraint's model number and manufacturing date to:

Century Products  
P.O. Box 551  
Elverson, PA 19520-9973  
or call 1-800-837-4044

For recall information:

- Call the U.S. Government's Auto Safety Hotline at 1-800-424-9393 (202-366-0123 in D.C. area)
- [www.nhtsa.dot.gov](http://www.nhtsa.dot.gov)
- Call Century Products at 1-800-837-4044

## W Safety First Check List

- ( Read and understand instruction manual and car seat labels.
- ( A vehicle combination lap/shoulder belt **MUST** be used when using car seat without harness system.
- ( **DO NOT** use vehicle "lap-only" belt or **LATCH** belt across front of child.
- ( Secure children in back seat whenever possible.
- ( Never leave child unattended.
- ( Install car seat securely with vehicle belt or **LATCH**.
- ( **DO NOT** use after date molded on back of car seat.
- ( **DO NOT** allow anyone (babysitter, relatives, etc.) to use car seat without first understanding all instructions.

## **WARNINGS** - Prevent serious injury or death:

Failure to follow these instructions and car seat labels can result in child striking the vehicle's interior during a sudden stop or accident. Secure child restraint with a vehicle seat belt or **LATCH** as shown in this manual.

Not all vehicle seat belts can be used with car seat. Read "Vehicle Seat Belts" section:

- Car seat with harness system **MUST** be held securely at all times by a lap belt (or lap belt portion of a lap/shoulder belt) or **LATCH** belt that will not change length while vehicle is in motion.
- Car seat without harness system **MUST ONLY** be used with a lap/shoulder belt.

Never put a car seat in a front vehicle seat unless recommended by vehicle owner's manual. National Highway Traffic Safety Administration (NHTSA) alerts vehicle owners that according to accident statistics, children up to age 12 are safer in the back seat. For vehicle's with air bags, refer to vehicle owner's manual for child restraint installation information.

If car seat is in a crash, it must be replaced. **DO NOT use it again!** A crash can cause unseen damage and using it again could cause serious injury or death.

## **WARNINGS** - *Prevent serious injury or death (continued):*

**DO NOT** use car seat if it is damaged or has missing parts.

**DO NOT** use accessories or parts other than those provided by Century or Graco. Their use could alter the function of the car seat.

**Never leave child unattended, even when sleeping.**

If using vehicle seat belt to secure car seat, **LATCH** connectors must be stored. (see section "**LATCH** storage")

**Never attach two LATCH connectors to one vehicle lower anchor point unless specifically allowed by the vehicle manufacturer.**

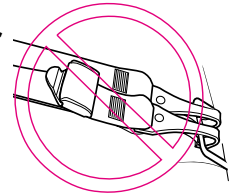

# BASIC INFORMATION

---

## W Certification

### *With Harness System:*

Car seat meets or exceeds all applicable requirements of Federal Motor Vehicle Safety Standard 213 for use in motor vehicles and aircraft.

### *Without Harness System:*

Belt-Positioning Booster seat is certified for use in motor vehicles.

Belt-Positioning Booster seat is **NOT** certified for use in aircraft.

## W Car Seat Useful Life

**STOP** using car seat and throw it away after the date **molded** into the underside of the car seat.

**Look for:**    **Do not use this car seat after December**    **Year**

## W Dangerous Vehicle Seats

Do not use car seat on rear-facing or side-facing vehicle seats.

## W Unoccupied Car Seat

Always secure car seat with a vehicle seat belt or **LATCH** even when unoccupied. An unsecured car seat can injure passengers.

## W Warm Weather

Car seat parts can get very hot in the sun or warm weather.

*To avoid burns, always check seat before putting child in car seat.*

## W Vehicle Seat Protection

Protect vehicle seat. Use a car seat mat, towel or thin blanket under and behind car seat.

# WHAT IS LATCH?

United States Federal Motor Vehicle Safety Standards have defined a new system for installing car seats in vehicles. The system is called **LATCH**. **LATCH** stands for:

Lower Anchorage and Tether for Children.

## LATCH System for Vehicles:

**LATCH** in the vehicle consists of a top tether anchor point and two lower anchor points.

Some vehicle owner manuals use the term **ISOFIX** to identify the new car seat anchorage system. This carseat with **LATCH** can also be used in vehicle seating positions equipped with **ISOFIX**.

Newer vehicles may have one or more seating positions equipped with **LATCH** anchor points.

If vehicle is equipped with **LATCH**, the vehicle lower anchor points may be visible at the vehicle seat crease. If not visible, they may be marked with a symbol (Fig. a) or a colored dot.

See your vehicle owner's manual for exact locations, anchor identification, and requirements for use with a car seat.

Check vehicle owner's manual for vehicle top tether anchor locations. They may be identified using one of the anchor symbols (Fig. b or Fig. c).

Typical seat in a passenger vehicle. Other vehicle types may have different **LATCH** locations.

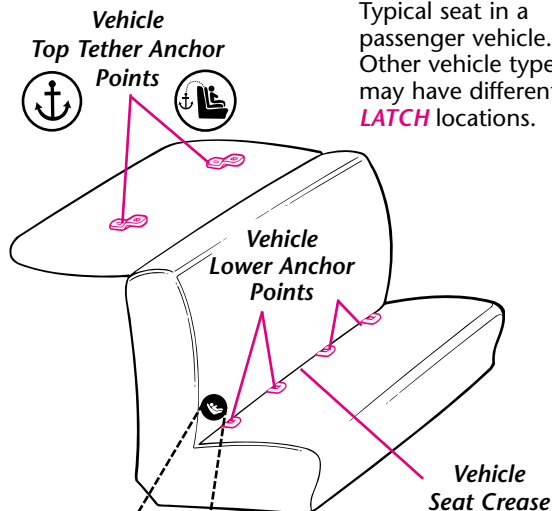

(Fig. a)



(Fig. b)



(Fig. c)

# LATCH SYSTEM

## LATCH System:

**LATCH** consists of a permanently attached lower anchorage belt and a top tether strap (Fig. a).

**ONLY** use **LATCH** in a seating position recommended by vehicle manufacturer.

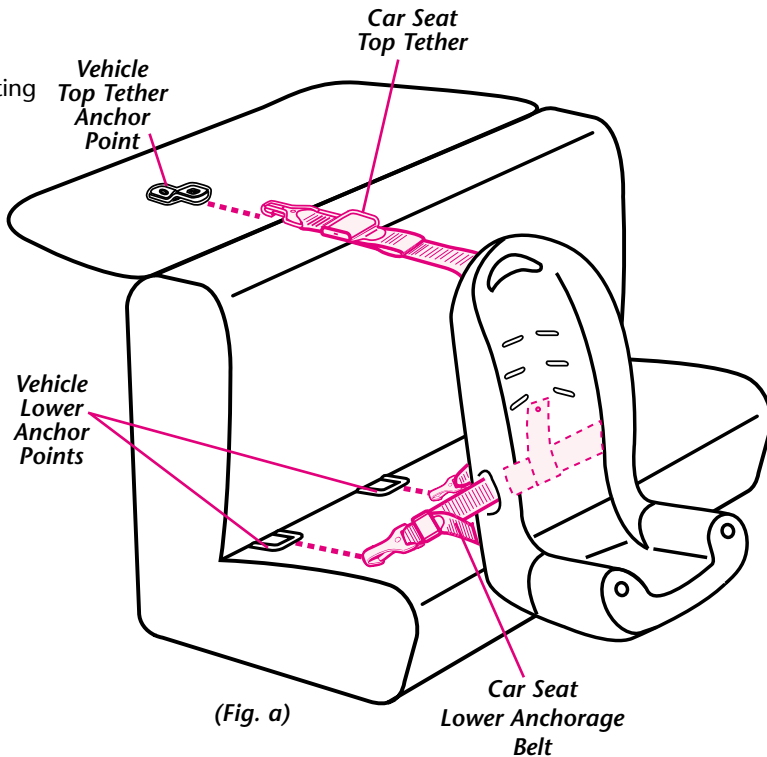

(Fig. a)



# HEIGHT and WEIGHT LIMITS

## With Harness System

Child **MUST** meet all of the following requirements:

- Weight is 20 - 40 lbs. (9 - 18 kg).
- Height is 27 - 43 inches (69 - 110 cm) tall.
- Child is able to sit upright unassisted ✱.
- Child's shoulders are *below* top harness slots.

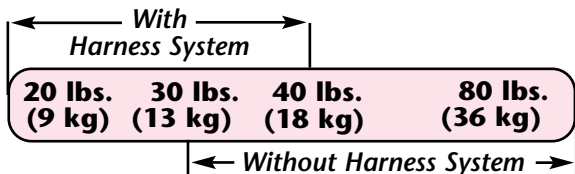

## Without Harness System

Child **MUST** meet all of the following requirements:

- Weight is 30 - 80 lbs. (13.6 - 36.3 kg).
- Height is 35 - 52 inches (89 - 132 cm) tall.
- Child is able to sit upright unassisted ✱.
- Top of child's ears are *not* above top of booster seat.

✱The American Academy of Pediatrics recommends that children should be at least one year of age before being positioned forward facing.

## Outgrowing Car Seat

### **WARNING**

To avoid injuries from whiplash, top of child's ears must be below top edge of headrest.

# INSTALLATION - *with harness system and Vehicle Seat Belt*

- 1 Adjust car seat to **upright** or **semi-upright** position and armrests to **up** position.
- 2 Place **forward-facing** on vehicle seat.
- 3 Lift seat pad flap (on certain models), thread vehicle seat belt through openings and buckle belt (**fig. a**).
- 4 Press down firmly in center of car seat to compress vehicle seat cushion while tightening vehicle seat belt.  
Use your knee to press down in center of car seat (**fig. b**).
- 5 Pull front to back and left to right to check for secure installation (**fig. c**).  
If not secure, see "Vehicle Seat Belts" section, page 22.
- 6 Attach tether hook (**A**) to anchor hardware (**B**) and tighten strap to remove any slack (**fig. d**).

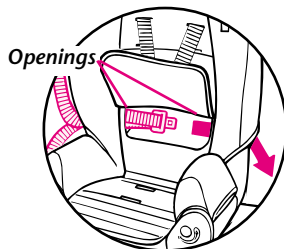
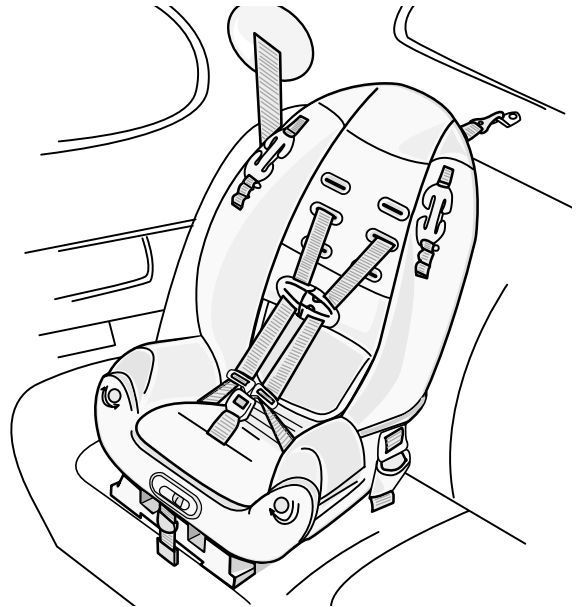

(fig. a)

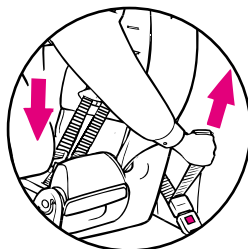

(fig. b)

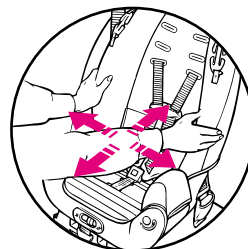

(fig. c)

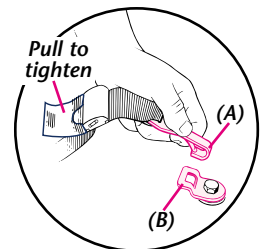

(fig. d)

# INSTALLATION - *without* harness system and Vehicle Lap/Shoulder Belt

- 1 Adjust car seat to *upright* or *semi-upright* position and armrests to *up* or *down* position.
- 2 Place *forward-facing* on vehicle seating position with a vehicle lap/shoulder belt.

To use as a **BELT-POSITIONING BOOSTER**, the following items need to be removed:

Crotch Strap - (see page 19, fig. g and fig. h)

Harness System - (see page 20)

**LATCH BELT** - (see page 30)

Tether - (see page 31)

Store all items for future use.

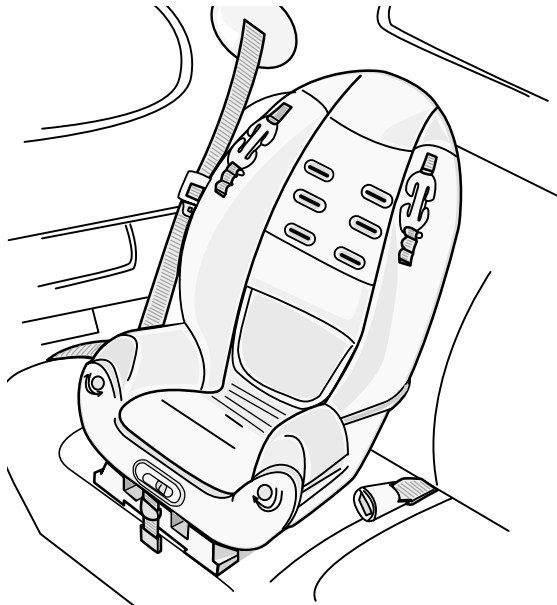

# INSTALLATION - *with harness system and LATCH*

- 1 Place *forward-facing* on vehicle seat.
- 2 Lift seat pad flap (on certain models), check to make sure **LATCH** belt is properly routed through openings and attach **LATCH** belt to lower anchorage points (*fig. a*).
- 3 Press down firmly in center of car seat to compress vehicle seat cushion while tightening **LATCH** belt.  
Use your knee to press down in center of car seat (*fig. b*).
- 4 Pull front to back and left to right to check for secure installation (*fig. c*). **LATCH** belt **MUST** stay tight.
- 5 Attach tether hook (**A**) to anchor hardware (**B**) and tighten strap to remove any slack (*fig. d*).

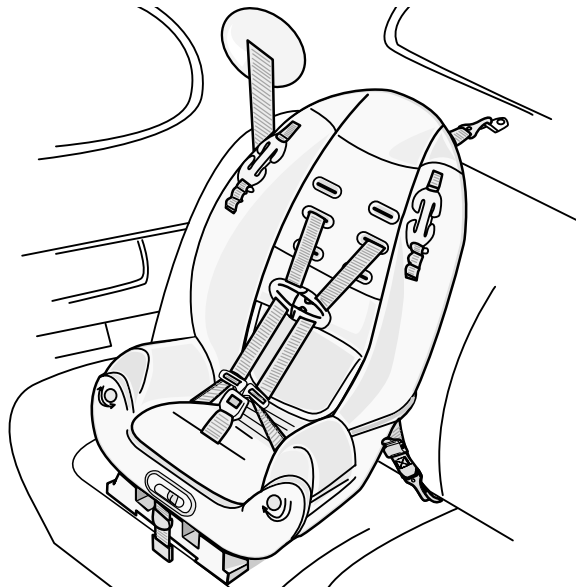

# INSTALLATION - *with harness system and LATCH*

Opening

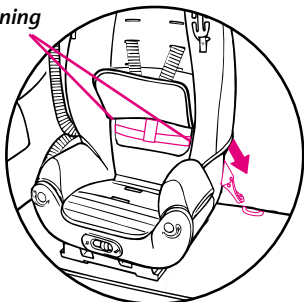

(fig. a)

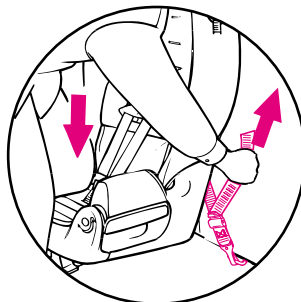

(fig. b)

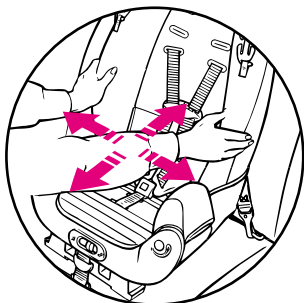

(fig. c)

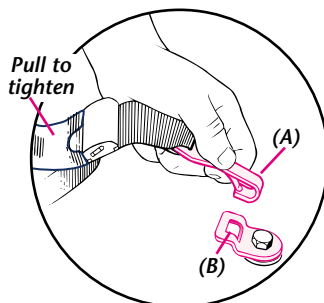

(fig. d)

# PLACING CHILD IN CAR SEAT - *with harness system*

## **WARNING**

**To prevent serious injury or death:**

- **Vehicle seat belt must be routed through back of car seat when using harness system.**
- **Never place vehicle belt in front of child when using harness system.**
- **Do not use strap covers, blankets, cushions, or padding under harness straps or child unless provided by Century or Graco.**
- **Do not use harness straps that are loose or unbuckled. They must be snug and positioned over shoulders and thighs.**

Adjust harness system:

Harness straps *must* be through slots *at* or just *above* shoulders.

- 1** Place child in car seat with child's back flat against back of car seat.
- 2** Place harness straps over child's shoulders and lock tongues into buckle.  
Pull up on tongues to be sure buckle is locked.
- 3** Close harness tie:  
Position harness tie at arm pit level.
- 4** Tighten harness straps so that they are snug with just enough room to insert one finger between child's chest and harness straps (*fig. a*).  
Thigh straps must also be snug (*fig. b*).
- 5** Position Head Support (on certain models) in center of car seat with ends pointing down and snap into belt slots above harness straps (*fig. c*).

# PLACING CHILD IN CAR SEAT - *with harness system* (continued)

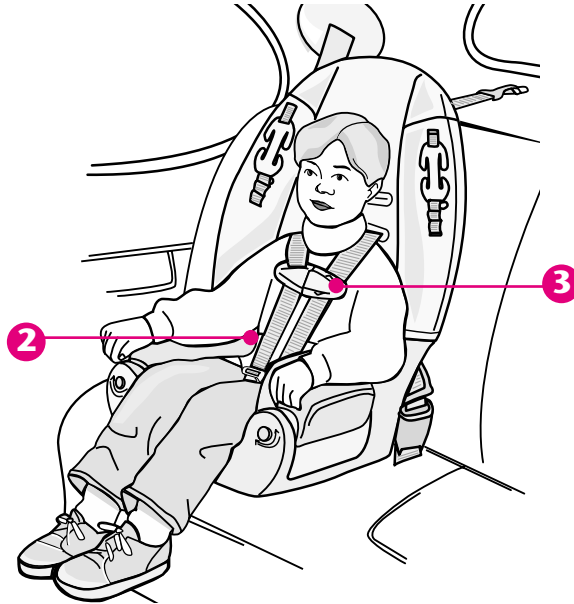

(fig. a)

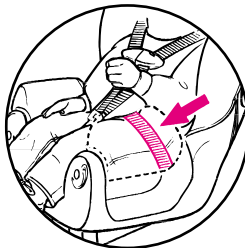

(fig. b)

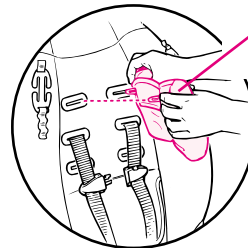

(fig. c)

# PLACING CHILD IN CAR SEAT - *without harness system*

## **WARNING**

**To prevent serious injury or death:**

- Use **ONLY** the vehicles Lap/Shoulder Belt system when restraining the child in this booster seat.
- Shoulder belt **MUST** be properly positioned over shoulder (**NOT** touching child's neck and **NOT** low off shoulder).
- Lap/shoulder belt **MUST** be properly positioned exactly as shown in illustration.
- Always tighten shoulder belt. **NEVER** position belt under child's arms (*fig. a*).
- Never use a vehicle "lap-only" belt across front of child.
- **DO NOT** allow child to slide down in car seat which could position lap belt across child's abdomen and shoulder belt over neck or face.
- If child will not keep vehicle shoulder belt properly positioned, **DO NOT** use this booster car seat. Use a different child restraint system.
- Vehicle belts **MUST** lay flat against child and **MUST** not be twisted.

Remove harness system (see "Harness System - removal and re-assembly" section, page 20).

- 1** Place child in car seat with child's back flat against back of car seat.
- 2** Place shoulder belt across child's chest.
- 3** Buckle belt and pull shoulder belt to adjust lap belt snugly.

Shoulder belt **MUST** lay across child's shoulder in red zone as shown (*fig. b*). If outside of red zone, see next steps for Comfort Clip® use.

### **CAUTION:**

Some shoulder belts with (emergency locking) retractors allow a child to pull belt out and change position of belt. Use of Comfort Clip® helps prevent child from pulling belt out.

- 4** Thread shoulder belt through Comfort Clip® **exactly** as shown and hook end of Comfort Clip® through proper loop of webbing (*fig. c*).
- 5** Check to be sure shoulder belt is properly positioned over shoulder in red zone and snug against child.
- 6** Position Head Support (on certain models) in center of car seat with ends pointing down and snap into belt slots (*fig. d*).



# PLACING CHILD IN CAR SEAT *-without harness system* (continued)

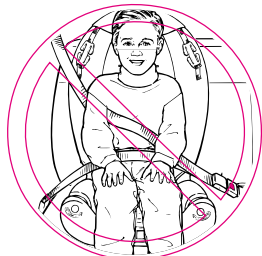
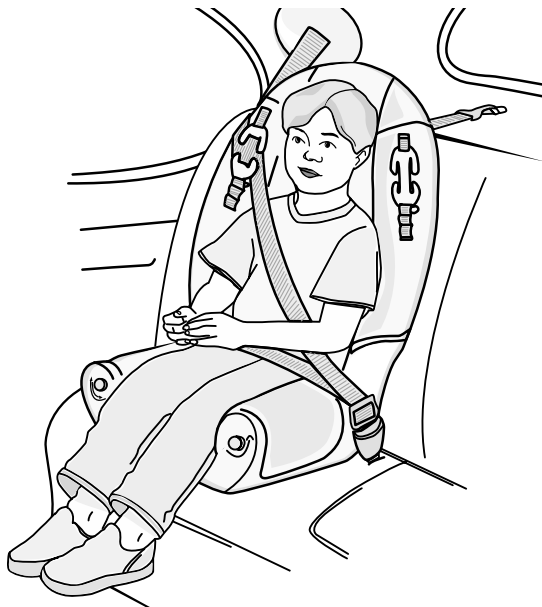

(fig. a)

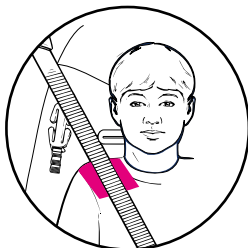

(fig. b)

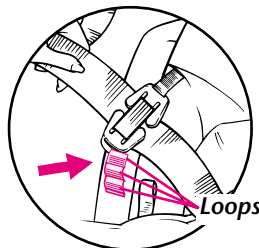

(fig. c)

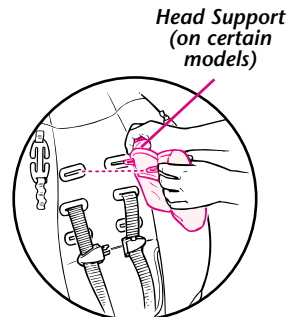

(fig. d)

# OPERATIONS and ADJUSTMENTS

---

## 1 **Harness Straps (fig. a):**

- To tighten: Pull lower belt tab.
- To loosen: Pull upper belt tab while pulling harness straps.

## 2 **Harness Tie:**

- To open: Press tab and pull apart (*fig. b*).
- To close: Snap halves together. Make sure harness tie is locked by pulling out on each half.

## 3 **Buckle:**

- To lock: Insert both tongues into buckle. Pull up on tongues to be sure they are locked.
- To unlock: Press red button and pull tongues out of buckle.

## 4 **Recline (fig. c):**

- Recline: Slide tab on front of car seat to allow recline foot to drop down.
- Upright: Slide and hold tab on front of car seat while pushing recline foot up. Release tab to lock foot.

## 5 **Armrests (fig. d):**

- Push in button on front side of car seat and rotate armrest *up* or *down*.

## 6 **Tether Strap (fig. e):**

- To tighten: Pull loose end of strap.
- To loosen: Lift adjuster

# OPERATIONS and ADJUSTMENTS (continued)

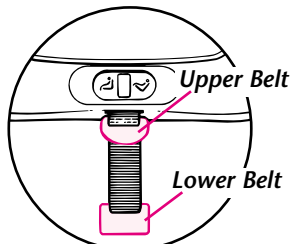
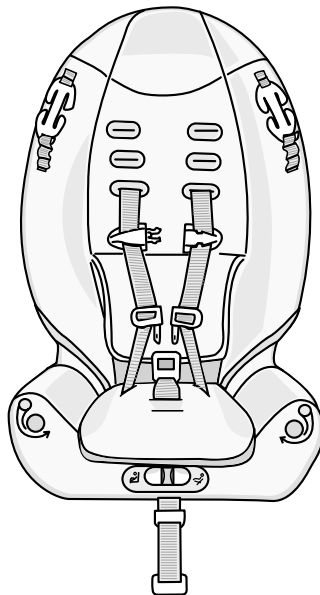

(fig. a)

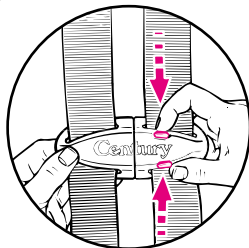

(fig. b)

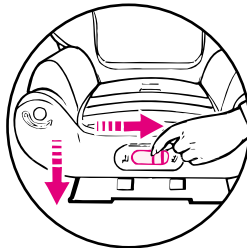

(fig. c)

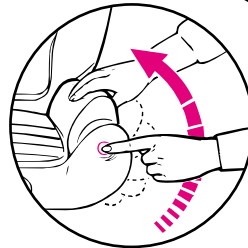

(fig. d)

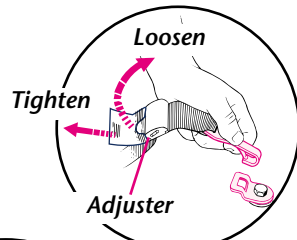

(fig. e)

# OPERATIONS and ADJUSTMENTS (continued)

## 7 Changing Harness Strap Slots:

**MUST** use slots **at** or just **above** shoulders.

- A** Loosen harness straps.
- B** Remove both harness strap loops from Splitter Plate on back of car seat (*fig. f*).
- C** Change harness strap slots.

Make sure harness straps are threaded through matching slot of seat pad and car seat.

It may be necessary to remove seat pad from top of car seat.

- D** Put right strap loop on Splitter Plate first, then attach left strap loop. (*fig. f*).

**NOTE:** Make sure straps are **NOT** twisted.

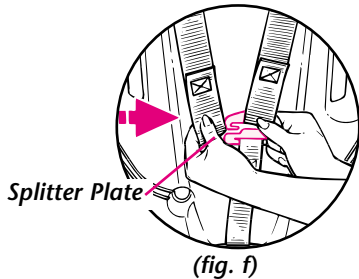

# OPERATIONS and ADJUSTMENTS (continued)

## 8 Changing Crotch Strap Slots:

**MUST** be in slot **closest** to but not under child.

- A** Turn car seat upside down, pry metal rod loose using screwdriver and pull rod out of crotch strap end (*fig. g*).
- B** Turn car seat upright and pull crotch strap and buckle out.
- C** Change crotch strap slots.

Thread looped end of crotch strap through slots in seat pad and shell (*fig. h*).

- D** Slide metal rod through loop in crotch strap and press rod into car seat shell (*fig. i*).

**NOTE:** Use a hammer to tap rod in place if necessary.

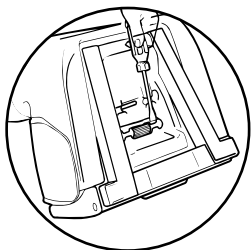

(*fig. g*)

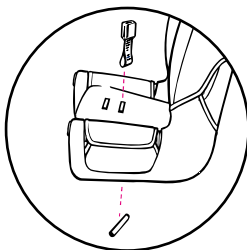

(*fig. h*)

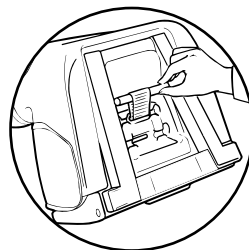

(*fig. i*)

# HARNESSE SYSTEM - *removal and re-assembly*

---

## *Harness Removal:*

- Remove harness strap loops from Splitter Plates on **back** of car seat.
- Pull harness strap out of car seat, harness tie and tongues.  
  
Store all parts for future use.
- Remove crotch strap (see page 19).

*When re-assembling harness system, be sure harness straps are not twisted.*

## *Harness Re-assembly:*

- 1** Thread end of harness strap down through slot in seat pad and car seat and back up through slot in opposite side of car seat pad, through harness tongues and harness tie.

**IMPORTANT:** Harness strap **MUST** be threaded over adjustment strap on bottom of car seat as shown in illustrations.

Thread ends of harness straps through matching shoulder slots in back of seat pad and car seat.

- 2** Re-attach harness straps to Splitter Plate on bottom

Put right strap loop on Splitter Plate first, then attach left strap loop.

- 3** Re-attach crotch strap (see page 19).

# HARNES SYSTEM - *removal and re-assembly (continued)*

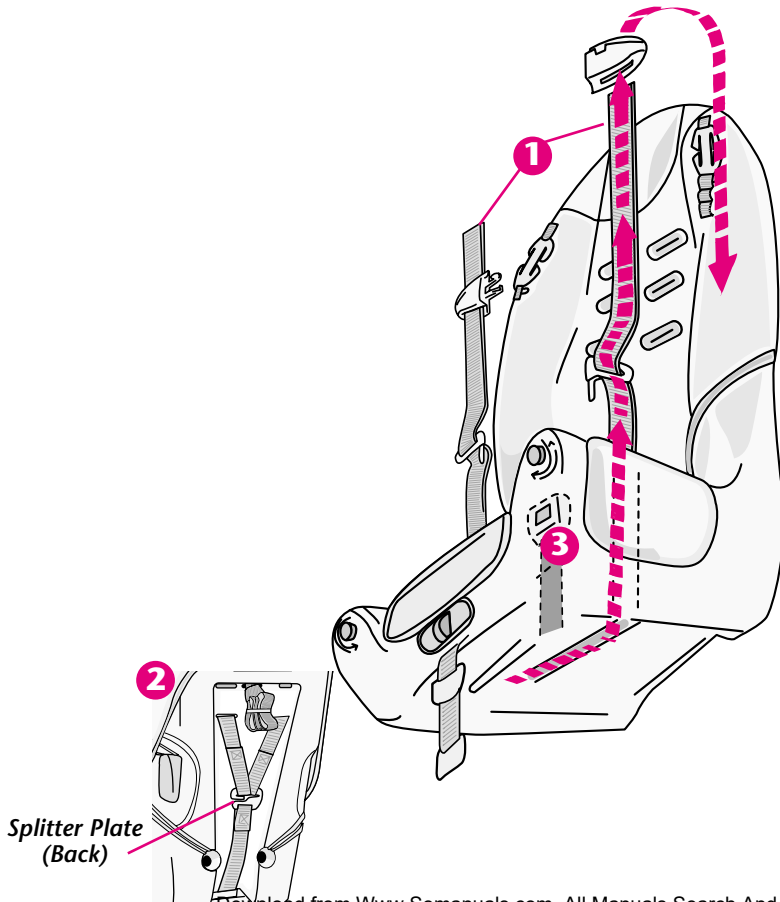

# VEHICLE SEAT BELTS

---

## **WARNING**

**Not all vehicle seat belts can be used with a car seat:**

- **Car seat with harness system MUST be held securely at all times by a lap belt (or lap belt portion of a lap/shoulder belt) that will not change length while driving.**
- **Car seat without harness system MUST be used with a lap/shoulder belt.**

If car seat is not held securely after following instructions in this manual, vehicle seat belt labels, and vehicle owner's manual:

- Move car seat to another seating location and try again, or
- Contact vehicle dealer for possible seat belt modification parts.

To provide the most secure installation of the car seat:

- Read the vehicle owner's manual regarding car seat installation and seat belt use with car seat.
- Follow all instruction labels on vehicle seat belt and car seat.



# VEHICLE SEAT BELTS (continued)

## W Lap Belts - Manually Adjustable

### *With Harness System:*

The locking latch plate on some seat belts may slip and loosen after being buckled on car seat if positioned at a certain angle. If this happens, flip latch plate over (*fig. a*) and re-buckle. Test installation again to see if this works. If not, move car seat to another seating position.

### *Without Harness System:*

**DO NOT** use this type of vehicle seat belt to secure child and booster car seat.

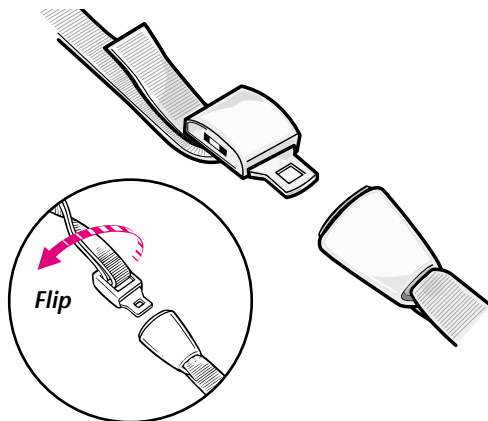

(*fig. a*)

# VEHICLE SEAT BELTS (continued)

## Lap Belts - With Retractor

### With Harness System:

Lap belts with retractors may or may not hold a car seat securely.

Follow these steps to determine if you have a retractor system that will hold car seat securely:

- Pull belt all the way out.
- Allow belt to retract about 6 inches (15 cm).
- Pull out on belt again.

If belt is locked and you **cannot** pull the belt out any further, you have an Automatic Locking Retractor which may be used with a car seat. Remember, when installing a car seat, pull belt all the way out, buckle belt, and then tighten.

If you **can** pull the belt out again (step c), you have an Emergency Locking Retractor which **must not** be used with a car seat.

### Without Harness System:

**DO NOT** use this type of vehicle seat belt to secure child and booster car seat.

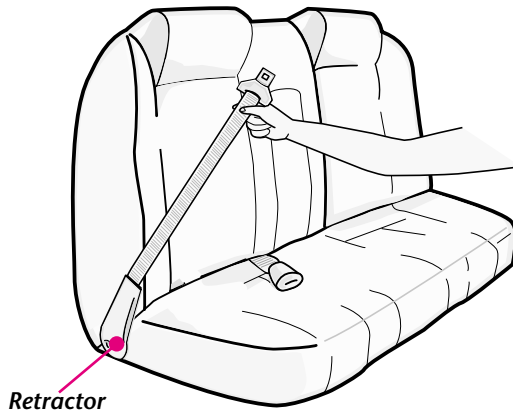

# VEHICLE SEAT BELTS (continued)

## W Passive Restraint - Lap Belt with Motorized Shoulder Belt

With or Without Harness System:

**DO NOT** use with any car seat.

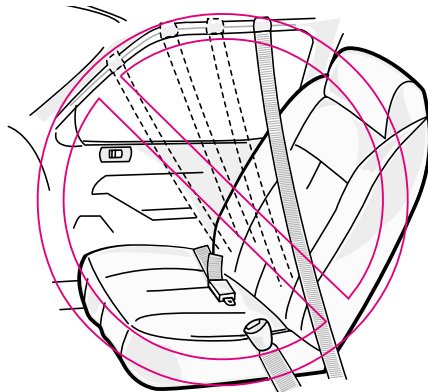

## W Passive Restraint - Lap or Shoulder Belt Mounted on Door

With or Without Harness System:

**DO NOT** use with any car seat. Belts will not stay tight while driving.

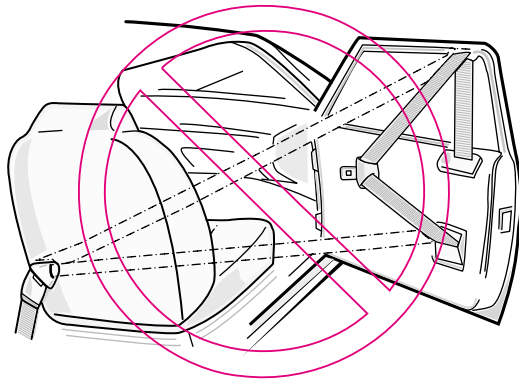

# VEHICLE SEAT BELTS (continued)

## W Belts Forward of Seat Crease

### With Harness System:

Vehicle seat belts located forward of seat crease may not securely hold car seat. Check vehicle owner's manual or see vehicle dealer for car seat installation requirements.

*If approved for use with car seat by vehicle manufacturer, install car seat and check for secure installation by pulling car seat front to back. If car seat slides forward, **DO NOT** use these seat belts.*

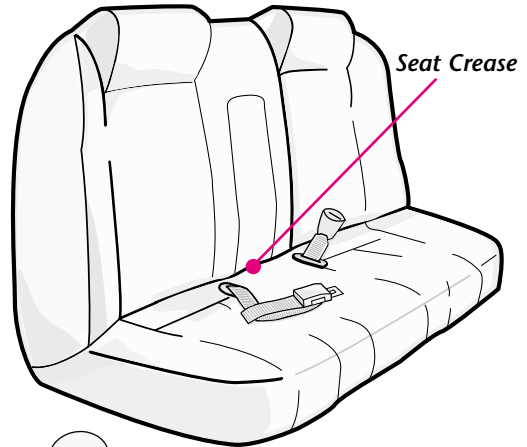

### Without Harness System:

**OK** to use. Follow vehicle owner's manual for specific instructions on how to use vehicle seat belts.

**DO NOT** use lap only belts.

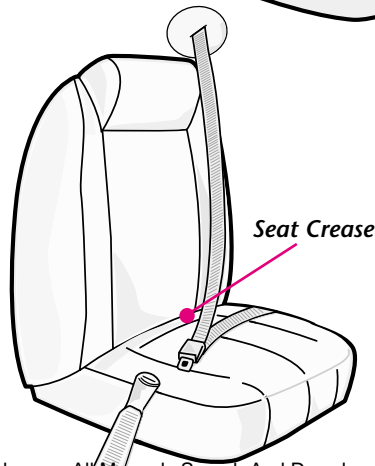

# VEHICLE SEAT BELTS (continued)

## W Combination Lap/Shoulder Belt with Locking Latch Plate

### *With Harness System:*

**OK** to use. Follow vehicle owner's manual for specific instructions on how to use vehicle seat belts.

The locking latch plate on some seat belts may slip and loosen after being buckled on car seat if positioned at a certain angle. If this happens, flip the latch plate over (**fig. b**) and re-buckle. Test installation again to see if this works. If not, move car seat to another seating position.

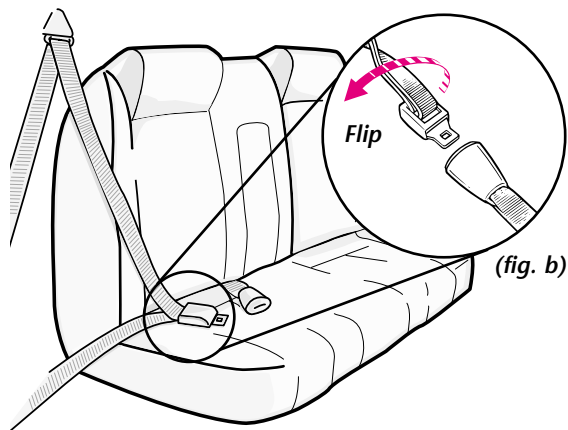

### *Without Harness System:*

**OK** to use. Follow vehicle owner's manual for specific instructions on how to use vehicle seat belts.

# VEHICLE SEAT BELTS (continued)

## W Combination Lap/Shoulder Belt with Sliding Latch Plate

### With Harness System:

Pull on latch plate (*fig. a*). If belt slides freely through latch plate, a locking clip **MUST** be used. (See "Locking Clip" section, page 29.)

### Without Harness System:

This vehicle seat belt system is **OK** to use with booster car seat.

Movement of the seat belt through the latch plate can allow an active toddler to slide down in car seat and re-position lap belt over abdomen and shoulder belt over neck or face which is dangerous.

A Locking Clip may be used on this type of vehicle seat belt to prevent movement of seat belt through latch plate limiting toddler's movement,(See page 29).

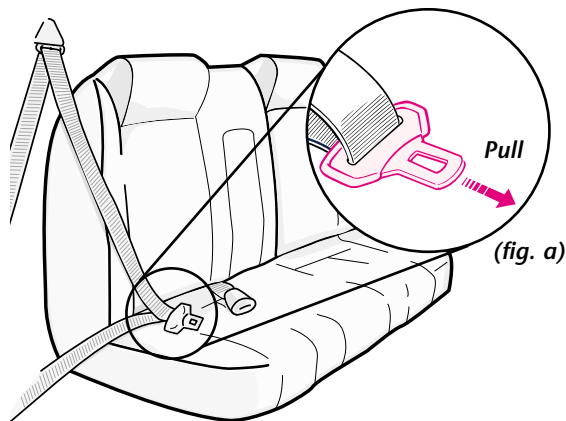

# VEHICLE SEAT BELTS (continued)

## W Locking Clip

### WARNING

**Avoid serious injury or death:**

- **Failure to use locking clip where required will result in car seat not being securely held in place.**
- **Remove locking clip from seat belts when not being used with car seat.**
- **DO NOT use locking clip as a vehicle seat belt shortener.**

You **MUST** use locking clip provided with car seat with a vehicle seat belt that slides freely through the latch plate or the lap belt cannot be tightly secured.

- 1** Install car seat and tighten vehicle seat belt.
- 2** Hold seat belts together at latch plate (*fig. a*) then unbuckle.
- 3** Slide locking clip on seat belts approximately 1/2 inch (1 cm) away from latch plate.
- 4** Re-buckle seat belt.

- 5** Test installation to see if car seat is secure. If not secure, additional belt tightening may be required:
  - Unbuckle vehicle seat belt.
  - Hold belts together and remove locking clip.
  - Shorten length of lap belt portion slightly by pulling belt through latch plate.
  - Re-attach locking clip.
  - Buckle vehicle seat belt.

Press car seat further down into vehicle seat cushion to help buckle vehicle seat belt.

Test installation to see if car seat is secure. If not secure, repeat above steps until secure.

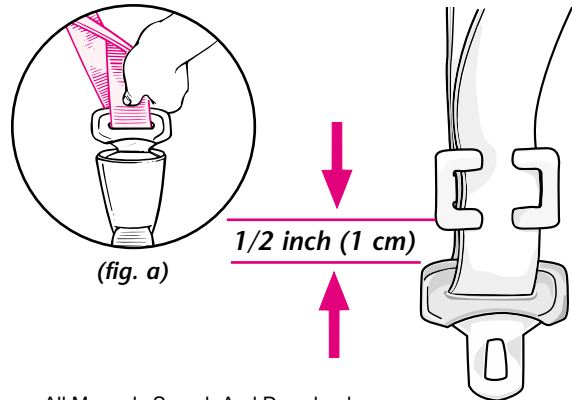

# ADDITIONAL INFORMATION

## W/LATCH Storage

**ALWAYS STORE LATCH WHEN NOT IN USE.**

- Locate **LATCH** storage loops on the underside of car seat pad (*fig. a*).
- Fasten **LATCH** onto storage loops as shown (*fig. b*)

Repeat for other connector.

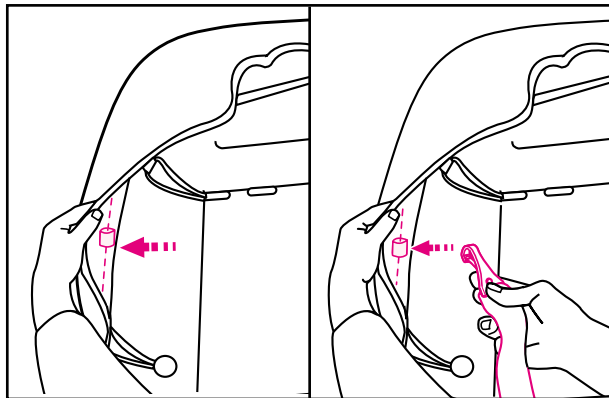

(fig. a)

(fig. b)

## W/LATCH Removal

**REMOVE LATCH FOR BELT-POSITIONING BOOSTER**

- Locate **LATCH** belt UNDER seat pad.
- Unscrew fastener holding **LATCH** belt in place. (*fig. c*)

Store for future use.

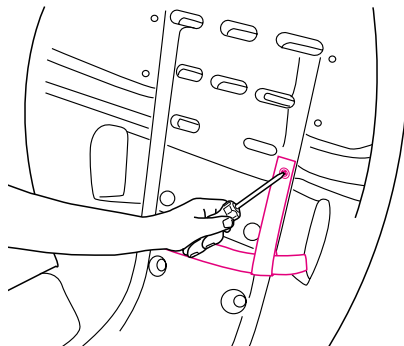

(fig. c)



# ADDITIONAL INFORMATION (continued)

## W Tether Storage

Tether strap may be used with car seats when used as a belt positioning booster (*without harness*) to help keep the upper portion of the car seat stabilized.

Read and follow instruction manual for use of car seat as a belt positioning booster.

For storage of tether hook if not used with a belt positioning booster:

- Adjust tether strap length so hook end is as *short* as possible.
- Roll up loose end of strap.
- Place rolled up strap on top of adjuster and place rubber band around bundle.

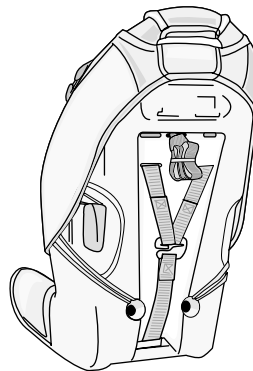

## W Tether Removal

Remove tether by loosening strap and pushing tether hook through loop as shown (*fig. d*).

Pull tether from seat and roll up loose tether to store.

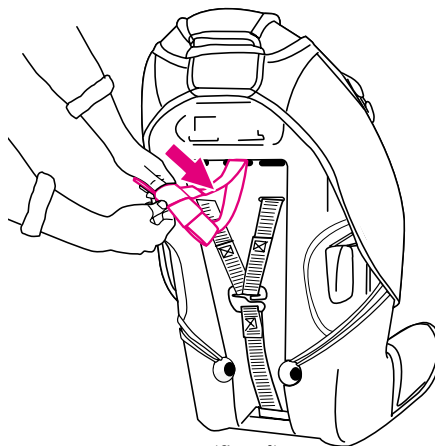

(fig. d).

## ADDITIONAL INFORMATION (continued)

---

### W Cup holder

A cupholder has been provided with this carseat.

For maintenance, follow care and cleaning instructions for seat pad and armrest pads.

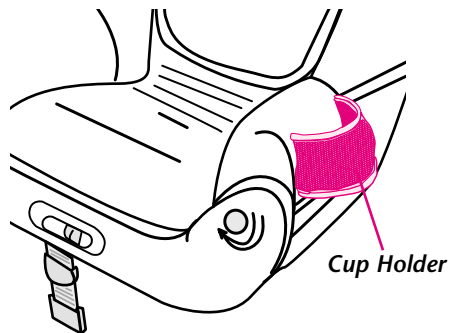

# ADDITIONAL INFORMATION (continued)

## W Care & Cleaning

### Removing Seat Pads:

If using harness system, remove harness system (see Harness System - removing and re-assembly" section, page 20).

- 1 Slide "J" hooks out of front slots.
- 2 Unhook elastic from "J" hooks.
- 3 Pull two button clips out (located on inside of seat pad) and pull pad off.

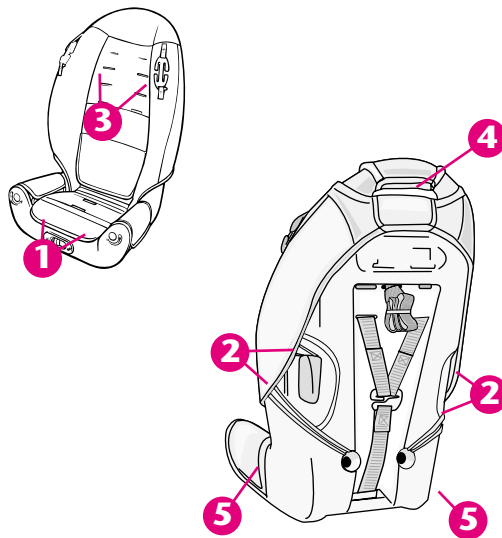

### Removing Armrest Pads and Top Head Pad (available on some models):

- 4 Pull head pad attachment strips apart and pull pads off.
- 5 Pull armrest attachment strips apart and pull pads off.

Reverse above steps for replacing pads and harness system.



# ADDITIONAL INFORMATION (continued)

## Seat Pad and Armrest Pads:

Machine-wash separately on gentle cycle and drip dry.

## Harness Straps:

Surface wash only with mild soap and damp cloth.

If harness straps are frayed or heavily soiled, they **MUST** be replaced.

## Shell:

Wipe with mild solution of soap and water. Avoid wetting labels.

Never use household detergents, they can weaken plastic.

## Buckle:

Rinse buckle with warm water. **DO NOT** use household detergents. Never lubricate buckle.

## W Aircraft Use

### With Harness System:

This car seat is certified for use on aircraft when used **with** harness system (see label on car seat). Contact airline about their policy.

Use this car seat only on forward-facing aircraft seats.

Install car seat on an aircraft the **same way** it is installed in a vehicle except **DO NOT** use tether strap.

### Without Harness System:

When used **without** harness system as a belt positioning booster seat, this restraint is **not** certified for use in aircraft because there is no shoulder belt available.

## W Second Hand Car Seat

Century advises against loaning or passing along car seat.

## WARNING

**Prevent serious injury or death:**

- **Buckle must be properly latched.**
- **Periodically inspect and clean buckle to remove objects or debris that could prevent latching.**

# NOTES

---

# PARTS LIST

---

## How to Order:

Complete the form on the following page. Your infant restraint model and serial numbers **MUST** be included on the form to ensure proper replacement parts. Your model number can be found on a sticker on the underside of your car seat. **Payment must accompany your order.**

Parts may also be ordered from Century's web site at [www.centuryproducts.com](http://www.centuryproducts.com).

- Fabric Seat Pad with Comfort Clips® .....\$35.00
- Armrest Pads (2) .....\$10.00
- Shield with Harness Straps.....\$16.00
- Tongues (2) .....\$5.00
- Harness Strap .....\$5.00
- Buckle and Crotch Strap .....\$10.00
- Metal Rod for Crotch Strap .....\$5.00
- 2-Piece Harness Tie .....\$5.00
- Locking Clip (*All models*) .....\$5.00
- LATCH** Belt .....\$20.00
- Tether System .....\$10.00
- Instruction Manual (*All models*) .....**FREE**

**Model No.**

*(Both Numbers Required)*

**Serial No.**

**SHIP TO:**

Name

Address

City, State, Zip Code

Telephone (including Area Code)

Check or money order enclosed  
(payable to Century Products)

Charge to credit card

Visa    MasterCard    Discover

Account #

Expiration date

Signature

- Fabric Seat Pad with Comfort Clips® .....\$35.00
- Armrest Pads (2) .....\$10.00
- Shield with Harness Straps.....\$16.00
- Tongues (2) .....\$5.00
- Harness Strap .....\$5.00
- Buckle and Crotch Strap .....\$10.00
- Metal Rod for Crotch Strap .....\$5.00
- 2-Piece Harness Tie .....\$5.00
- Locking Clip (*All models*) .....\$5.00
- LATCH** Belt .....\$20.00
- Tether System .....\$10.00
- Instruction Manual (*All models*) .....**FREE**

Subtotal:

Shipping & handling\*: \$5.00

Sales tax\*\*:

Total:

\* \$15.00 outside the continental U.S.

\*\*CA 7.25%, IL 6.25%, IN 5%, NY 8.25%, OH 5.75%, PA 6%, SC 5%

**MAIL ORDER TO:**

**CENTURY PRODUCTS**

P.O. BOX 100

ELVERSON, PA 19520-9974

ATTN: CUSTOMER SERVICE DEPARTMENT

**OR FAX ORDER TO:**

(610) 286-4555

## 1 Fold instruction manual.

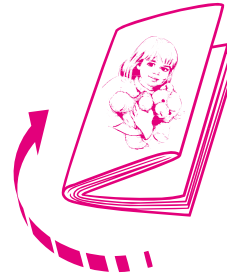

## 2 Store in pocket.

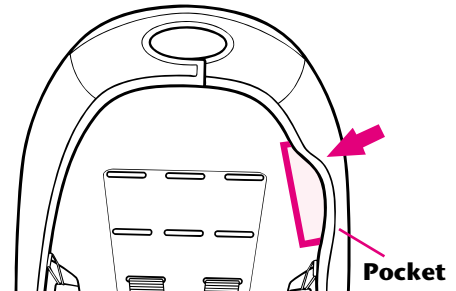

If a part is damaged, missing, or you need help or replacement parts, **DO NOT** return car seat to the store.

### CALL US FIRST

Call toll-free 1-800-837-4044 from anywhere in the U.S. or Canada or fax at 1-610-286-4555.

### or write us at:

Century Products  
P.O. Box 100  
Elverson, PA 19520-9974

Attention: Customer Service  
Department



Century Products  
Graco Children's Products Inc.  
A Division of Newell Rubbermaid



## Free Manuals Download Website

<http://myh66.com>

<http://usermanuals.us>

<http://www.somanuals.com>

<http://www.4manuals.cc>

<http://www.manual-lib.com>

<http://www.404manual.com>

<http://www.luxmanual.com>

<http://aubethermostatmanual.com>

Golf course search by state

<http://golfingnear.com>

Email search by domain

<http://emailbydomain.com>

Auto manuals search

<http://auto.somanuals.com>

TV manuals search

<http://tv.somanuals.com>