



CHANGHONG

LCD COLOR TELEVISION

LT1512E

LT1712E

LT2012E

LT2612E

LT3212E

INSTRUCTION MANUAL

Please read this manual carefully before operation.

CONTENTS

Important Safety Instructions	3
Using the Remote Control	5
Batteries for Remote Control	5
<hr/>	
Packing List	6
General Information	6
Brief Introduction	8
Remote Control	10
Overview of the Remote Control	10
TV Function Except Teletext Function	11
Teletext Function	12
<hr/>	
Installation	13
General Operation	13
Menu Operation	14
Function Introduction	14
Picture	14
Sound	14
Setup	15
Tune	15
Clock	16
PC Setup	16
Other Functions	17
Volume Control	17
Sound Mode Selection	17
Picture Mode Selection	18
Recall	18
<hr/>	
Signal Switch	18
Channel Switch	19
Sleep Function	19
Indicator Light	19
TROUBLESHOOTING	20
SPECIFICATIONS	21

Note: Due to ongoing upgrades all the On Screen Displays and illustrations in this manual may be somewhat different from the actual situation. Please take the ones on the PDP Colour TV as the standard.

Important Safety Instructions

Electrical energy can perform many useful functions, but it can also cause personal injuries and property damage if improperly handled. This product has been engineered and manufactured with the highest priority on safety. But **IMPROPER USE CAN RESULT IN POTENTIAL ELECTRICAL SHOCK OR FIRE HAZARD**. In order to prevent potential danger, please observe the following instructions when installing, operating and cleaning the product. To ensure your safety and prolong the service life of your LCDTV product, please read the following precautions carefully before using the product.

1. **Read these instructions**---All operating instructions must be read and understood before the product is operated.
2. **Keep these instructions**---These safety and operating instructions must be kept in a safe place for future reference.
3. **Heed all warnings**--- All warnings on the product and in the instructions must be observed closely.
4. **Follow all instructions**---All operating instructions must be followed.
5. **Attachments**---Only use attachments/accessories specified by the manufacturer. Do not use attachments not recommended by the manufacturer. Use of improper attachments can result in accidents.
6. **Power source**---This product is intended to be supplied by a listed power supply indicated on the marking label. If you are not sure of the type of power supply to your home, consult your product dealer or local power company. For added protection for this product during a lightning storm, or when it is left unattended and unused for long periods of time, unplug it from the wall outlet and disconnect the cable system.
7. **Power cord protection** ---Protect the power cord from being walked on or pinched particularly at plugs, convenience receptacles, and the point where they exit from the apparatus.
8. **Overloading**---Do not overload wall outlets, extension cords, or convenience receptacles on other equipment as this can result in a risk of fire or electric shock.
9. **Entering of objects and liquids**---Never insert an object into the product through vents or openings. High voltage flows in the product, and inserting an object can cause electric shock and/or short internal parts. For the same reason, do not spill water or liquid on the product.
10. **Servicing**---Refer all servicing to qualified service personnel. Servicing is required when the apparatus has been damaged in any way, such as power-supply cord or plug is damaged, liquid has been spilled or objects have fallen into the apparatus, the apparatus has been exposed to rain or moisture, does not operate normally, or has been dropped.
11. **Damage requiring service**---If any of the following conditions occurs, unplug the power cord from the AC outlet, and request a qualified service person to perform repairs.
 - a. When the power cord or plug is damaged.
 - b. When a liquid is spilled on the product or when objects have fallen into the product.
 - c. When the product has been exposed to rain or water.
 - d. When the product does not operate properly as described in the operating instructions.

Do not touch the controls other than those described in the operating instructions. Improper adjustment of controls not described in the instructions can cause damage, which often requires extensive adjustment work by a qualified technician.
 - e. If the product has been dropped or the cabinet has been damaged in any way.
 - f. When the product displays an abnormal condition or exhibits a distinct change in performance. Any

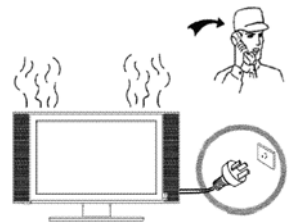

noticeable abnormality in the product indicates that the product needs servicing.

12. **Replacement parts**---In case the product needs replacement parts, make sure that the service person uses replacement parts specified by the manufacturer, or those with the same characteristics and performance as the original parts. Use of unauthorized parts can result in fire, electric shock and/or other danger.
13. **Safety checks**---Upon completion of service or repair work, request the service technician to perform safety checks to ensure that the product is in proper operating condition.
14. **Wall mounting**---When mounting the product on a wall, be sure to install the product according to the method recommended by the manufacturer. This is a safety feature.
14. **Stand**---Use only with the cart, stand, tripod, bracket, or table specified by the manufacturer, or sold with the apparatus. Do not place the product on an unstable trolley, stand, tripod or table. Placing the product on an unstable base can cause the product to fall, resulting in serious personal injuries as well as damage to the product. When mounting the product on a wall, be sure to follow the manufacturer's instructions. Use only the mounting hardware recommended by the manufacturer.
15. **Careful move**---When a cart is used, use caution when moving the cart/apparatus combination to avoid injury from tip-over. Sudden stops, excessive force and uneven floor surfaces can cause the product to fall from the trolley.
17. **Lightning**---Unplug this apparatus during lightning storms or when unused for long periods of time.
For added protection for this television equipment during a lightning storm, or when it is left unattended and unused for long periods of time, unplug it from the wall outlet and disconnect the antenna. This will prevent damage to the equipment due to lightning and power-line surges.
18. **Do not use this apparatus near water**---for example, near a bathtub, washbowl, kitchen sink, or laundry tub, in a wet basement, or near a swimming pool, and the like.
Do not use immediately after moving from a low temperature to high temperature environment, as this causes condensation, which may result in fire, electric shock, or other hazards.
19. **Clean only with dry cloth**---Unplug this product from the wall outlet before cleaning. Do not use liquid cleaners or aerosol cleaners. Use a damp cloth for cleaning.
20. **Ventilation**---Do not block any ventilation openings. Install in accordance with the manufacturer instructions. The vents and other openings in the cabinet are designed for ventilation. Do not cover or block these vents and openings since insufficient ventilation can cause overheating and/or shorten the life of the product. Do not place the product on a bed, sofa, rug or other similar surface, since they can block ventilation openings. This product is not designed for built-in installation; do not place the product in an enclosed place such as a bookcase or rack, unless proper ventilation is provided or the manufacturer's instructions are followed.
21. **Heat sources**---Do not install near any heat sources such as radiators, heat registers, stoves, or other apparatus (including amplifiers) that produce heat.
22. **Panel protection**---The LCD panel used in this product is made of glass.

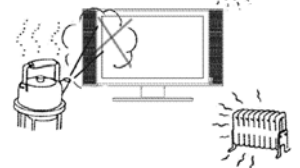
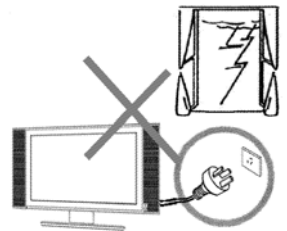
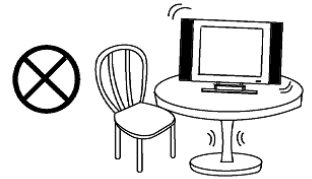

Therefore, it can break when the product is dropped or impacted upon by other objects. Be careful not to be injured by broken glass pieces in case the LCD panel breaks.

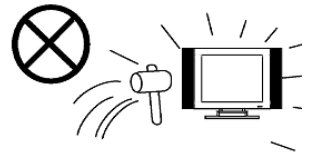

23.Pixel defect---The LCD panel is a very high technology product, giving you finely detailed pictures. Occasionally, a few non-active pixels may appear on the screen as a fixed point of blue, green or red. Please note that this does not affect the performance of your product.

! CAUTION!

The AC adapter specially supplied for 15 inch LCD TV is for indoor use only; please do not spill liquid or other objects into the product, do not cover or press the body of the AC adapter with anything, and do not pull or pluck the wire when you use the product. Please do not use the wire, which has been snapped for any reasons.

Using the Remote Control

● Use the remote control by pointing it towards the remote sensor window of the set. Objects between the remote control and sensor window may prevent proper operation.

Note: the illustration is for your reference only, the remote sensor may locate differently with different model.

Cautions regarding use of remote control

- Do not expose the remote control to shock. In addition, do not expose the remote control to liquids, and do not place in an area with high humidity.
- Do not install or place the remote control under direct sunlight. The heat may cause deformation of the unit.
- The remote control may not work properly if the remote sensor window of the main unit is under direct sunlight or strong lighting. In such a case, change the angle of the lighting or LCD TV set, or operate the remote control closer to the remote sensor window.

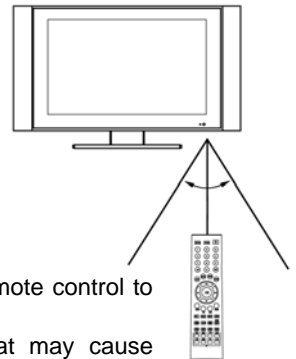

Batteries for Remote Control

If the remote control fails to operate the LCDTV functions, replace the batteries in the remote control.

1 Open the battery cover.

2 Insert two size-AAA batteries.

● Place the batteries with their terminals corresponding to the (+) and (-) indications in the battery compartment.

3 Replace the cover .

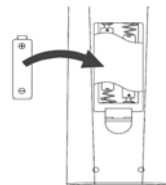

Precaution on battery use

Improper use of batteries can result in a leakage of chemicals and/or explosion. Be sure to follow the instructions below.

- Place batteries with their terminals corresponding to the (+) and (-) indications.
- Different types of batteries have different characteristics. Do not mix batteries of different types.
- Do not mix old and new batteries. Mixing old and new batteries can shorten the life of new batteries

and/or cause old batteries to leak chemicals.

- Remove batteries as soon as they are non-operable. Chemicals that leak from batteries can cause a rash. If chemical leakage is found, wipe with a cloth.
- The batteries supplied with the product may have a shorter life expectancy due to storage conditions. If the remote control is not used for an extended period of time, remove the batteries from the remote control.

Packing List

LCD TV	1
Operation Manual	1
Power Adapter	1(only for 1512E)
Power Cable	1
Infrared Remote Control	1
AAA Batteries	2

Note: Please keep the wrapping box and the packing materials well for future convenience of transport.

General Information

■ Radio Frequency input

It can store up to 100 TV programs (the program number range from 0 to 99)

■ AV input

In scart mode, the system can automatically activate scart detection to identify signal input modes (CVBS or RGB) and input signal character (16:9 or 4:3); Capable of receiving PAL, NTSC, SECAM color systems; convenient to watch VCR (video cassette recorder), Pickup Camera and other Disc's programs

■ YPbPr input

Capable of receiving high definition YPbPr signal in 480i, 480p, 576i, 576p, 720p(50/60Hz), 1080i(50/60Hz), and 1080p(50/60Hz) formats

■ ACI function (Auto channel Installation)

■ Stereo and digital accompanying sound processing

Auto detect and demodulation IGR, and decode NICAM digital accompanying sound

■ VGA input

- Connecting with the host computer
- Use it as a display terminal
- Connect the 3.5mm(diameter) audio cord to your computer's audio main board, music can be transmitted from the host computer

■ Program & Child Lock

Capable of locking your favorite TV programs and the function button on the front panel

■ Timer function

In TV mode, the LCD TV will automatically power off within 15 minutes without any signal input; in PC mode, it will enter into the Power Energy Saving Mode if there is no signal input. When a valid signal is received, it will power up again

■ Blue background without signal

In TV, AV, RGB and YPbPr modes, screen displays soft blue background if there is no signal input

- **Multi Language On-Screen Display menu**

Ordinary and graphical user interface makes the menu operation user-friendly

- **Power Energy Saving Mode (Power management mode)**

When used as PC display terminal without PC signal output, the LCD TV will automatically power off within 30 seconds and enter into the Power Energy Saving Mode. It will power up again when it receives a signal from PC. Otherwise, you can press the number buttons or **【】** / **【P+】** / **【P-】** on the remote control.

- **Plug and Play**

No installation software is needed to use the TV as computer terminal display equipment

- **Adjusts the picture quality automatically**

- **No flicker and radiation**

- **Auto on/off when time is set**

- **Zoom mode**

Full-screen, 16:9(4:3 screen), Film, Subtitle

- **Legerity, convenient, low power consumption**

- **Picture enhancement function**

Dynamic complexion adjustment: improve the anamorphic complexion to make it more appealing

Black field prolongation: darken the large part of black section to enhance picture contrast in dim backgrounds

Colorful edge adjustment: increase edge gradient of color signals to make the silhouette clearer

Brightness edge adjustment: increase edge gradient of brightness signals to make the silhouette clearer

- **Super definition display panel**

- **Dynamic comb filter**

- **10-page teletext storage**

- **Earphone output**

Brief Introduction

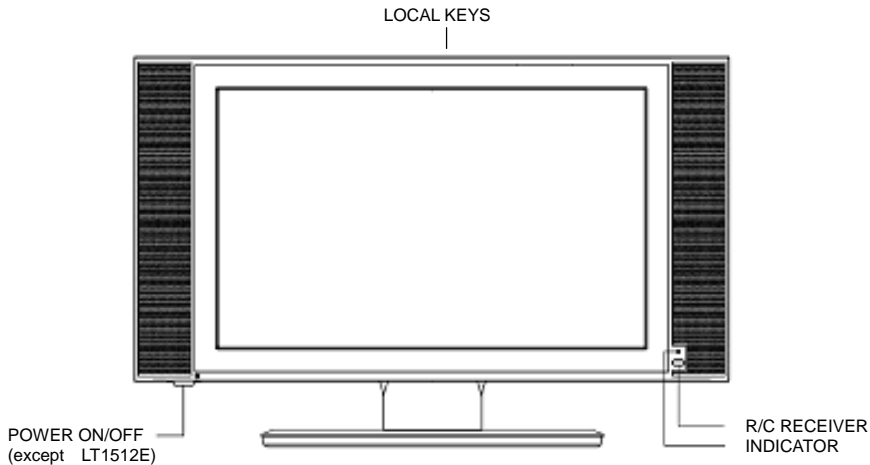

Front Panel

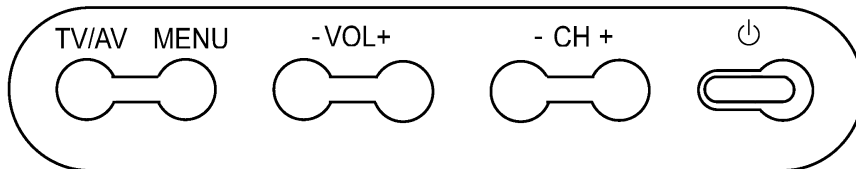

The button names and functions are as follows:

Panel buttons



Button	Description
【TV/AV】	Switch between TV, AV, RGB, YPbPr, and PC signal sources The same function to 【AV】 on the remote control
【MENU】	Enter or exit the OSD (On-Screen Display) menu The same function to 【MENU】 on the remote control
【VOL-】	Decrease the sound volume. Adjust functions in menu operation. The same function to 【V-】 on remote control
【VOL+】	Increase the sound volume. Adjust functions in menu operation. The same function to 【V+】 on the remote control
【CH-】	1. In TV mode, decrease the channel number 2. Select functions in menu operation 3. The same function to 【P-】 on the remote control
【CH+】	1. In TV mode, increase the channel number 2. Select functions in menu operation 3. The same function to 【P+】 on the remote control
【】	Power on or put the LCD TV to standby mode The same function to 【】 on the remote control

Note: In this operation manual, **【】** symbol means Button.

Rear Panel

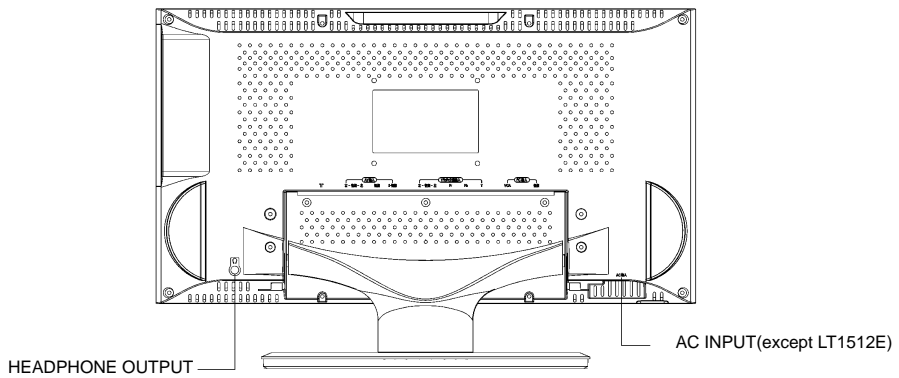
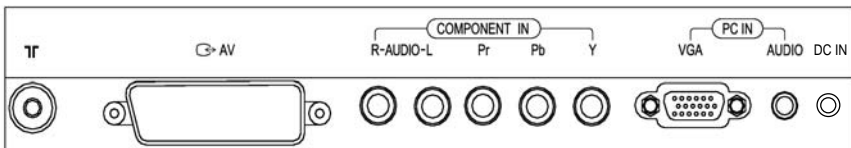

Illustration of Signal Input Ports



Note: The port of DC IN is only for LT1512E.

Remote Control



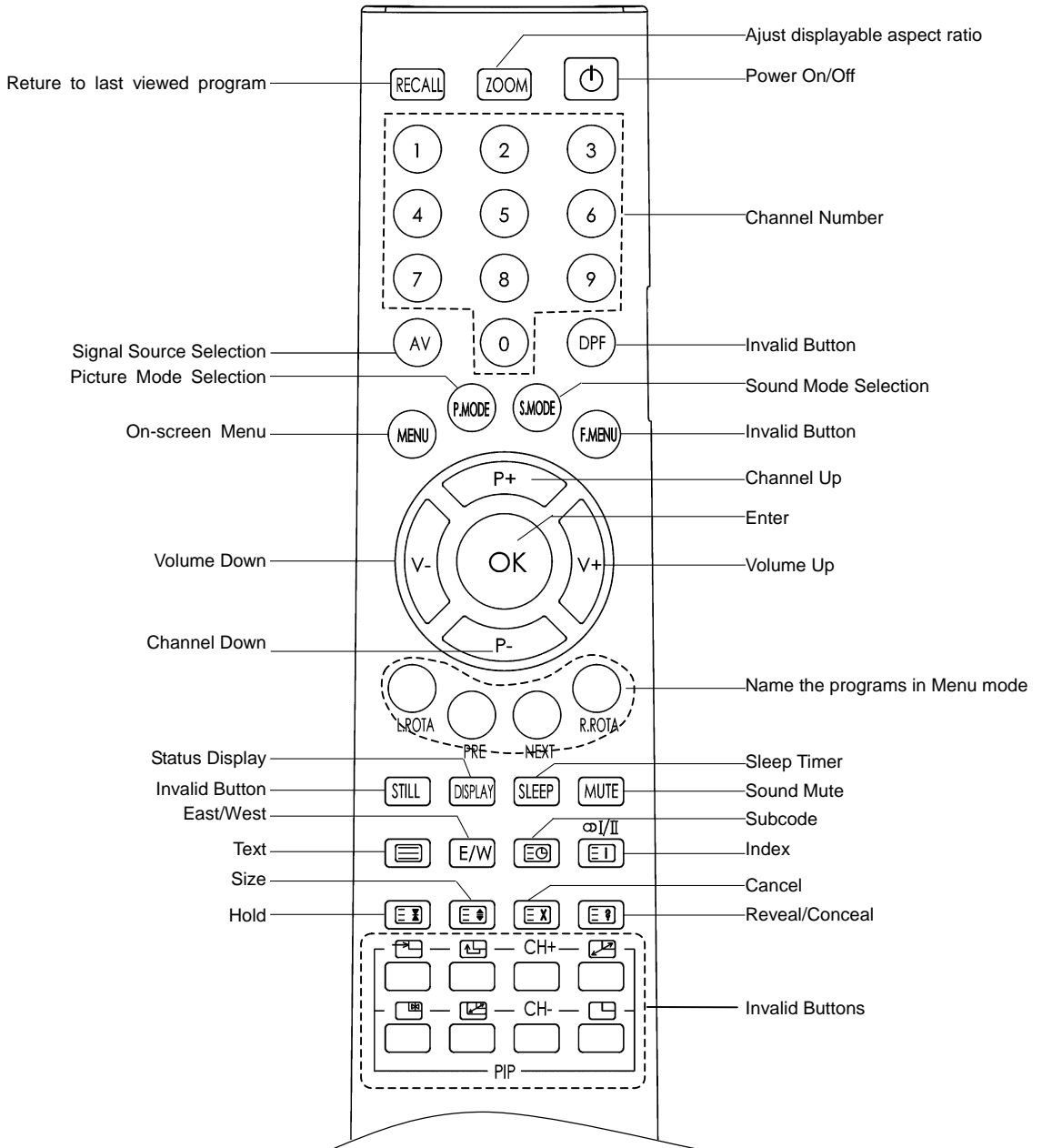





Overview of the Remote Control



TV Functions Except Teletext Function

- 1 . **RECALL** : Return to last viewed program
- 2 . **ZOOM** : Adjust displayable aspect ratio
- 3 . **POWER ON/OFF** : Switch on or off TV set
- 4 . **0-9 Channel Keys** : Key in the alphanumeric digits to switch to the designated channel directly
- 5 . **TV/AV** : Toggle between different signal sources available
- 6 . **MENU** : To go to the On Screen Display(OSD) menus
- 7 . **P MODE** : Select different modes of picture settings
- 8 . **S MODE** : Select different modes of sound settings
- 9 . **P+** : Scroll to next channel
- 10 . **P-** : Scroll to previous channel
- 11 . **V-** :Decrease audio volume
- 12 . **V+** : Increase audio volume
- 13 . **OK** : Select or confirm menu item
- 14 . **DISPLAY** : Show info of current program
- 15 . **SLEEP** : Select time of TV to sleep mode
- 16 . **MUTE** : Mute sound
- 17 . **∞I/II**: Select between mono/stereo sound or dual I/II soundtrack
- 18 . **HOLD** : Freeze screen

Teletext Function

- 1. 0-9 Channel Keys** : Key in the alphanumeric digits to go to the designated page directly
- 2. P+ Keys** : Press **【P+】** to scroll to the next page
- 3. P- Keys** : Press **【P-】** to the previous page
- 4. L.ROTA Key** : RED Teletext Button
- 5. PRE Key** : GREEN Teletext Button
- 6. NEXT Key** : YELLOW Teletext Button
- 7. R.ROTA Key** : CYAN Teletext Button
- 8. TEXT Key**  : Switch between teletext on, mix and teletext off.
- 9. EAST/WEST Key**  : Switch between different languages
- 10. SUBCODE Key**  : Switch between secondary pages by entering the four digit number
- 11. INDEX Key**  : Go to index page directly
- 12. HOLD Key**  : Retain the current teletext page and again to cancel the function
- 13. SIZE Key**  : Switch between zooming to the upper half, lower half and in full
- 14. CANCEL Key**  : Exit from the teletext mode
- 15. REVEAL/CONCEAL Key**  : Reveal or conceal hidden text for quizzes etc

Installation

1. Remove the LCD TV from the box and place it on a flat surface in a well-ventilated location.
2. Connect the output terminal of RF cable to the corresponding TV RF signal input terminal. The LCD TV is a high-tech digital product. Do use quality RF cable to obtain optimal results.
3. Connect the output terminal of the AV devices such as YPbPr, DVD to the corresponding terminal of the LCD TV.
4. Connect one end of the VGA terminal to the corresponding signal source terminal, and connect the other end to the corresponding LCD TV terminal. Screw down the screws on both sides to secure it.
5. Ensure that every AV signal cord is correctly connected to the corresponding interface.
6. Connect one end of the AC power/power adapter cord to the power input jack of the LCD TV, then plug the other end to the corresponding jack.
7. The panel can be tilted upwards by no more than 10⁰ to achieve better visual angle. When doing so, rotate the TV with two hands, one to fix the pedestal while the other to tilt the panel. Take great care and do this in a moderate pressure in case any accidents happen.(only for LT1512E LT1712E LT2012E)

General Operation

Switching the TV On

1. In Standby mode, press  on the remote control or front panel to enter to Power On mode.
- 2 The indicator is red when the TV is in Standby mode.

Switching the TV Off

1. Press  on the remote control or on the front panel to switch off the TV
2. Unplug the AC power/power adapter cord from the power outlet supply after turning off the power to switch the TV off completely.

Caution: The TV will be shut off automatically when the power trips. Do unplug the power cord from the AC outlet if so. The last TV mode will appear when power resumes

Do not turn on/off the TV too often

Auto Off If there is no Signal Input

The TV will enter into Standby mode after 15 minutes when there is no signal input in TV source; The TV enter into power saving mode after 30 seconds when there is no signal input in PC source.

Menu Operation

1. Use the On Screen Display menu to set and adjust functions
2. Use **【P+】** / **【P-】** to select the desired menu after pressing **【MENU】**, then press **【V+】** / **【OK】** to enter the corresponding menu option and use **【P+】** / **【P-】** to choose from the options; Use **【V+】** / **【V-】** to adjust the options value and return to the previous menu by pressing **【MENU】** again. The menu will disappear without any operation within 10 seconds.

Function Introduction

In TV, AV, RGB, YPbPr and PC modes

I Picture

- **Brightness**
To adjust the picture's brightness
- **Contrast**
To adjust the picture's contrast.
- **Sharpness**
To adjust the picture's definition.
- **Color**
To adjust the picture's color.
- **Tint**
To adjust the picture's tint. (For NTSC signal only)

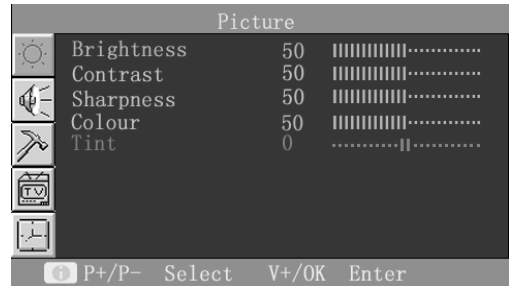

Note: Picture menu options in other signal sources. AV/RGB: the same as in TV mode YPbPr/PC: only two options of Brightness and Contrast

II Sound

- **Volume**
To increase or decrease the volume.
- **Balance**
To balance the volume between the left and right speakers.
- **Woofer**
To turn on/off the woofer.
- **Spatial**
To turn on/off the surround.
- **Equalizer (submenu)**
Use **【OK】** / **【V+】** to enter the Equalizer (submenu), you can increase or decrease the value of the sound output in every frequency band preferred

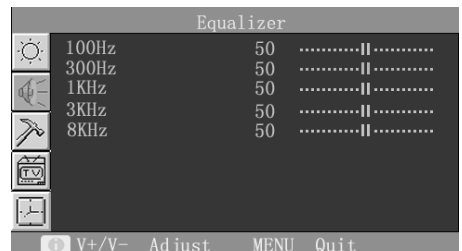
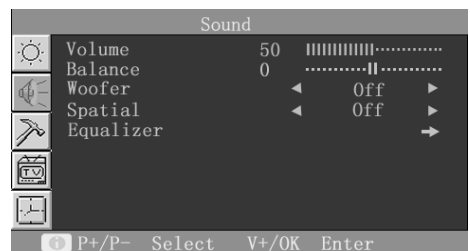

Note: The Audio menu options are the same in TV signal as well as in other signal sources

III Setup

- Language

To select the different language displayed.

- Blue Back

In this mode, a blue background will appear when there is no signal input.

- Program Lock

In the submenu of Program Lock, the Enter Password menu appears (this menu will appear when you switch to a channel after it was locked once);. Input the default password of 1235, the submenu of Program Lock will be displayed if the password is correct.

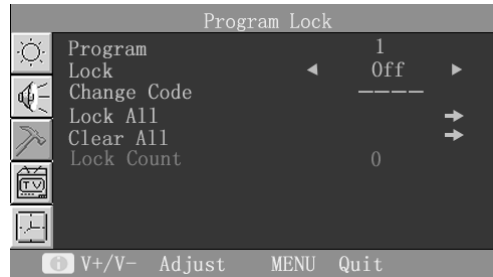
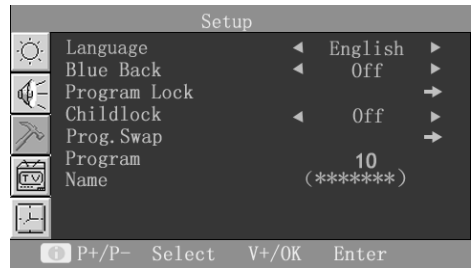

(a) When changing the password, the password will be updated after four digits are input twice. The word "OK" will then appear. Otherwise, the word "Failed" will appear if two passwords are different.

(a) Unlock all the locked programs when Clear All is entered.

(b) When some locked channels are switched to after exiting from the Program Lock menu, the picture and sound will be locked unless the correct password is entered. The unlocked status will remain until the TV is turned off. Password must be re-keyed after switching on the TV to the locked channels again.

(c) Operating Auto Search will cancel the current locked status.

(d) The default password will always be effective.

(e) Entering the default password allows you to go to the Program Lock menu, then change the password while the default password is still effective. The branch menu cannot be entered if a wrong password was keyed in, therefore the previous menu needs to be reverted by pressing **【MENU】**

(f) There will be a short pause when entering the functions of Lock All and Clear All.

(g) All programs would be locked when Lock All is entered.

- Childlock

In Child Lock On mode, local buttons on TV do not work. A prompt "keyboard locked" will be displayed. However, the remote control buttons will still function. When the TV is on and the Child Lock is on, a prompt "Locked, power off after 6s" will appear, using the remote control can solve this. Otherwise, it will automatically enter into Standby mode.

- Prog. Swap (submenu)

Swap between two programs and their channels. This can be done by pressing Switch button after two different channels are selected.

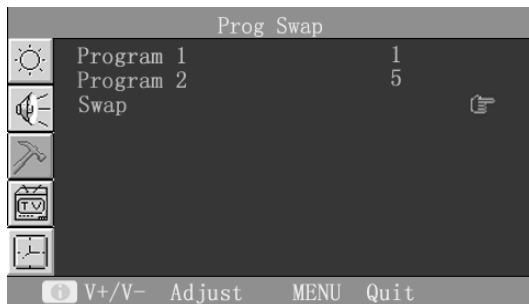

- Program

Display the current program's channel number

- Name

Rename the program with four colored buttons on the remote control

【Red】 for Capitalized English letters

【Green】 for Alphanumeric numbers from 0 to 9

【Yellow】 for special characters as “#”

【Blue】 Resuming “*” in unnamed mode

Use 【V+】 / 【V-】 to input and select the characters

Note: In PC signal mode, there are 2 options of Language and Child Lock in the Setup menu. In AV/RGB/YPbPr signal mode, there are 3 options of Language, Blue Back and Child Lock.

IV Tune

Press 【P+】/【P-】to select the Tune menu. There are altogether 7 items to adjust: Auto Search, Search, Band, Fine Tune, Color System, Sound System and Skip.

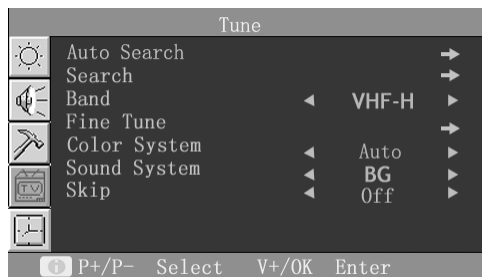

- Auto Search

In Auto Search mode

1. The TV does auto-search and stores programs from VHF-L to UHF.
2. During search, all programs searched are automatically stored.
3. When the search is done or when all 100-program positions are occupied, or you have pressed 【MENU】 during the search process, the search will halt and the TV will return to the Tune menu with channel 0.

- Search

In Search mode, press 【V+】 / 【V-】 so that the TV manually searches the lower or upper program position until one program was searched and automatic storage will commence. If the program is not needed, then press 【V+】 / 【V-】 again. After pressing 【MENU】 , the TV will exit from Search and return to the menu.

- Band

To set which band the current program belongs to.

- Fine Tune

In Fine Tune mode, press 【V+】/【V-】to until the best picture and sound is achieved. After adjusting, the TV will auto-store the channels. Press 【MENU】 to exit and return to the Tune menu.

- Color System

To set the color system of the current program and use **【V+】 / 【V-】** to switch between PAL, NTSC,N4.43, SECAM and AUTO systems.

- Sound System

To switch between D/K,L, B/G and I sound systems.

- Skip

Skipping the unwanted program can dramatically quicken program selection.

1. Turn Skip on, pressing **【P+】 / 【P-】** can not select this program.
2. Input the program number directly to locate the program.

Note: There is only Color System for the Tune Menu in AV, RGB and signal sources. There is PC Setup menu for the Tune menu in PC signal source. There is no Tune menu in YPbPr signal source.

V Clock

- Current Time

The current time can be set by using the number buttons (0-9) or **【V+】 / 【V-】** .

- On Time

The function of On Time can be effective when On Mode is on. Press the number buttons or **【V+】 / 【V-】** to set the time.

- On Mode

When this function is on, a preset time can be programmed to turn on the TV.

- On Prog

To enter a selected program directly after Timer On is set.

- Off Time

The function of Off Time can be effective only when Off Mode is on. Press the number buttons (0-9) or **【V+】 / 【V-】** to adjust the time.

- Off Mode

When this function is on, a preset time can be programmed to turn off the TV.

Note: The TV can only be turned on automatically when it is in standby mode. The Clock menu is applicable in all signal sources.

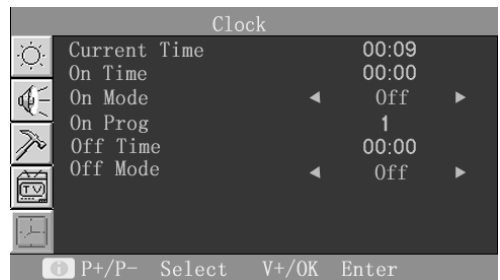

VI PC Setup

- H Position

To adjust picture position horizontally.

- V Position

To adjust picture position vertically.

- Clock

To adjust picture clock position.

- Phase

To adjust picture phase.

- Colour Temp

Four modes of Warm, Normal, Cool and User can be chosen with **【V+】 / 【V-】** in cycle. Only in User mode can adjustments be made to the three options: Red, Green and Blue.

- Auto Adjust

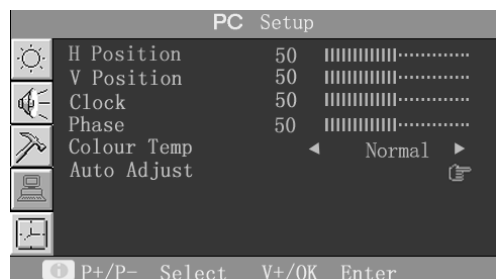

To automatically adjust the picture position, clock, phase and color temperature to a preset optimum value. This mode is invalid in DOS mode.

Note: The PC Setup menu is only available in the PC signal source.

Other Functions .

● **Volume Control**

1. Press **【V+】** to increase or **【V-】** to decrease the volume when there is no menu on the screen. The Volume bar will disappear if there left idle for more than 6 seconds.
2. Press the **【MUTE】** button on the remote control to turn On/Off the MUTE mode. In Mute mode, a sign of “Mute” in red will appear on the upper-right corner of the screen. This symbol is hidden when the menu operation is entered, but the feature is still valid. It appears again when the menu operation is exited. When there is no valid signal input, the TV will be mute (but no mute symbol) with a blue background.

● **Sound Mode Selection**

Press **【S.MODE】** to select between Personal, News, Theater and Music modes and activate the Picture Mode. The latter three modes are default setting that cannot be adjusted. Entering the Personal mode allows setting to the preferred mix.

Sound Mode	Sound Quality
Personal	For the user’s preference
News	For general programs of conversations and news report
Theater	For better audience effect as soft, magnificent and vivid
Music	For general music programs

Note: The operation and setting of the Volume Control are applicable to all the signal sources.

● **Picture Mode Selection**

Press **【P.MODE】** to Switch among Personal, Soft, Normal and Rich modes.

Picture Mode	Picture Quality
Personal	For the user’s preference
Soft	For more mellow pictures
Normal	For general programs
Rich	For better visual effect such as magnificent and vivid

Note: The setting of this selection is in the same state are applicable to all the signal sources.

● **Recall**

In TV mode, press **【RECALL】** on the remote control to return to the previous channel or signal source.

● **Signal Switch**

Press **【AV】** on the remote control to select between the signal sources: TV, AV, RGB, YPbPr and PC. The order is as below:

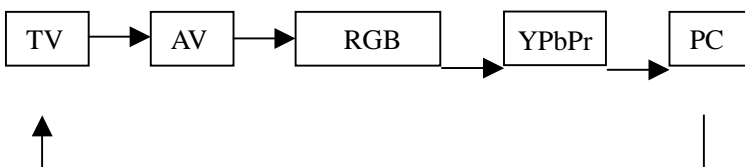

● **Channel Switch**

Use the number buttons to choose the desired channel directly or press **【CH+】** / **【CH-】** on the panel or **【P+】** / **【P-】** on the remote control to select the channel number. If a channel number is in SKIP ON mode, the next channel will be displayed.

A maximum of 2 digits can be keyed in at one time, the number button on the remote control is used. The symbol of “- -” on the upper-right corner represent tens and one respectively. The range is 0~99. The first input number is for tens, if it is “1”, “1-” appears on screen. The TV will switch to channel 1 if no additional number is keyed in within 3 seconds. Alternatively, press **【OK】** to switch to the desired channel after the corresponding number is keyed in.

Note: This function is only available in TV mode

● **Sleep Function**

Press **【SLEEP】** on the remote control once to activate the function and subsequent keying in to select the sleep time of 0, 15, 30, 45, 60,90, 120, 150,180, 240 and 0 minutes. This is will be reflected in the top right hand corner of the screen. After this step is done, press **【SLEEP】**to view the set sleep. See the illustration in the right.

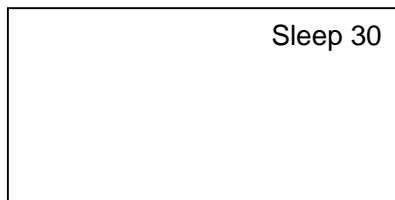



● **Indicator Light**

Status	Light Color	Description
On/Off	Off	The TV works normally/is power off
Standby	Red	In Standby Mode
Timer On/Off Or Sleep	Green	Timer On/Off is valid or Sleep is on
Sleep (PC)	Yellow	Sleep for power-saving;
Receives signal from the remote control	Flickering	The indicator will flicker when the TV receives signal from the remote control

●TROUBLESHOOTING

Before calling a technician, please check the following table to see if the below mentioned symptoms can be diagnosed and fixed.

Symptoms	Possible Causes	Solution
No picture, no sound, and no indicator light on	1.The power cord is not plugged in 2.The power is off	1.Plug the power cord in 2.Turn the power on
No picture, no sound, but the green light indicator	Functions of ON/OFF TIME and SLEEP have been set	Press  to turn on the TV
No picture, no sound, but the yellow light indicator	1.PC is in VGA Mode without any PC signal input 2.The signal cord is not connected properly	1.Press  or input the PC signal 2.Connect the signal cord properly
Picture and sound with abnormality	1.Contrast, sharpness, and color are not set properly 2.Color system is not set properly 3.Sound system is not set properly	1.Adjust the value of Contrast, sharpness, and color 2.Set the Color system to the country broadcasting standard 3.Set the Sound system to the country broadcasting standard
Picture is fuzzy or with interference	Signal source is weak or RF cable is faulty	Use a stronger signal or change a new RF cable
Blue background	No Video signal or the signal cord is not properly or not connected	Connect the signal cord properly
Picture is unclear, crawls or have black stripes on horizontal position in PC mode	Picture is not well adjusted	Adjust automatically by selecting Auto Adjust or alternatively adjust Clock and Phase manually via PC Setting menu
PC Picture is not in the middle of the screen	Picture is not well adjusted	Adjust pictures automatically by resetting H Position, V Position, Phase and Clock
No sound	No Audio signal or the signal cord is not properly or not connected	1.Connect the audio signal cord correctly 2.Set the sound system correctly
The remote control does not work	Batteries are not correctly installed or are flat	1.Make sure the positive and the negative polarities are correct 2.Reattach the battery lid 3.Replace with new batteries

● SPECIFICATIONS

LT1512E

Items	Specifications
Size (diagonal)	15.0 inch
Color System	PAL, SECAM, NTSC
Sound System	D/K, I, B/G, L/L'
PC Displayable Input Format	VGA / SVGA /XGA
YPbPr Input Format	480i, 480p, 576i, 576p, 720p, 1080i, 1080p(50Hz, 60Hz)
Audio Power Output	2 x 2.0 W
AV-Audio Input	1 (shared with RGB)
AV-Video Input	1
Earphone Output	1
PAL/NTSC Digital Comb Filter	YES
RGB Input	1
YPbPr Input	1 (with audio input)
VGA Video Input	1
VGA Audio Input	1
AC Voltage Input	Please refer to the back label
Rated Power Consumption	
Standby Power Consumption	≤1.5W
Unit Dimension	454mm(W)×343mm(H)×166mm(D) (including the pedestal stand)
Unit Weight	4.5kg(Approx.)

LT1712E

Items	Specifications
Size (diagonal)	17 inch
Color System	PAL, SECAM, NTSC
Sound System	D/K, I, B/G, L
PC Displayable Input Format	VGA / SVGA /XGA
YPbPr Input Format	480i, 480p, 576i, 576p, 720p, 1080i, 1080p(50Hz, 60Hz)
Audio Power Output	2 x 2.0 W
AV-Audio Input	1 (shared with RGB)
AV-Video Input	1
Earphone Output	1
PAL/NTSC Digital Comb Filter	YES
RGB Input	1
YPbPr Input	1 (with audio input)
VGA Video Input	1
VGA Audio Input	1
AC Voltage Input	Please refer to the back label
Rated Power Consumption	
Standby Power Consumption	≤1.5W
Unit Dimension	525mm(W)×350mm(H)×230mm(D) (including the pedestal stand)
Unit Weight	7.5kg(Approx.)

Items	Specifications
Size (diagonal)	20 inch
Color System	PAL, SECAM, NTSC
Sound System	D/K, I, B/G, L
PC Displayable Input Format	VGA / SVGA
YPbPr Input Format	480i, 480p, 576i, 576p, 720p, 1080i, 1080p(50Hz, 60Hz)
Audio Power Output	2 x 2.0 W
AV-Audio Input	1 (S-Video is using in communtiy)
AV-Video Input	1
Earphone Output	1
PAL/NTSC Digital Comb Filter	YES
RGB Input	1
YPbPr Input	1 (with audio input)
VGA Video Input	1
VGA Audio Input	1
AC Voltage Input	Please refer to the back label
Rated Power Consumption	
Standby Power Consumption	≤1.5W
Unit Dimension	590mm(W)×435mm(H)×230mm(D) (including the pedestal stand)
Unit Weight	10kg(Approx.)

LT2612E

Items	Specifications
Size (diagonal)	26 inch
Color System	PAL, SECAM, NTSC
Sound System	D/K, I, B/G, L
PC Displayable Input Format	VGA / SVGA / XGA / WXGA 60HZ
YPbPr Input Format	480i, 480p, 576i, 576p, 720p, 1080i, 1080p(50Hz, 60Hz)
Audio Power Output	2 x 5 W
AV(S-Video)Input	2 (audio is using in communtiy)
YPbPr Input	1
PC Input	1
AC Voltage Input	Please refer to the back label
Rated Power Consumption	
Standby Power Consumption	≤2W
Unit Dimension	804mm(W)×510mm(H)×294mm(D)
	804mm(W)×436mm(H)×106mm(D) (not including the pedestal stand)
Unit Weight	17.5kg(Approx.)

Items	Specifications
Size (diagonal)	31.56 inch
Color System	PAL, SECAM, NTSC
Sound System	D/K, I, B/G, L
PC Displayable Input Format	VGA / SVGA / XGA / WXGA 60HZ
YPbPr Input Format	480i, 480p, 576i, 576p, 720p, 1080i, 1080p(50Hz, 60Hz)
Audio Power Output	2 x 5 W
AV(S-Video)Input	2 (audio is using in communtiy)
YPbPr Input	1
PC Input	1
AC Voltage Input	Please refer to the back label
Rated Power Consumption	
Standby Power Consumption	
Unit Dimension	954mm(W) × 579mm(H) × 314mm(D) (including the pedestal stand) 954mm(W) × 502mm(H) × 105mm(D) (not including the pedestal stand)
Unit Weight	21.5kg(Approx.)

All the features and specifications are subject to change without notice.

LT1512E LT1712E LT2012E LT2612E LT3212E

Free Manuals Download Website

<http://myh66.com>

<http://usermanuals.us>

<http://www.somanuals.com>

<http://www.4manuals.cc>

<http://www.manual-lib.com>

<http://www.404manual.com>

<http://www.luxmanual.com>

<http://aubethermostatmanual.com>

Golf course search by state

<http://golfingnear.com>

Email search by domain

<http://emailbydomain.com>

Auto manuals search

<http://auto.somanuals.com>

TV manuals search

<http://tv.somanuals.com>