



REAR PROJECTION TELEVISION

OPERATION MANUAL

43AP75

51APB5

51AP95

51AP15W

43APB1W

43APG1W

Contents

SETTING UP

For your safety—Some do's and don'ts for you to be aware of	1
Installation and other points to follow	3
Your new television's remote control—on at-a-glance guide	4
Connecting and turning on your new TV	5
Choosing the language and Auto Tuning	6
Manually Tuning your TV —an alternative to Auto tuning	7
Sorting programme positions	8
Fine Tuning and skip	9

USING YOUR TV

General controls—changing programme position, still picture	10
Sound controls—volume, sound mute, bass boost, bass/treble/balance	10
Picture controls—picture preferences,digital noise reduction(DNR),adjusting the aspect ratio ..	11
Picture controls—Automatic Convergence Adjustment	12
Picture controls—Manual Convergence Adjustment	13
Picture controls—PIP Controls	14

ADDITIONAL FEATURES

The timer and display—informing the TV to turn on/off and time display	15
Panel lock—disabling the buttons on the front of the TV	15
Stereo and bilingual transmissions—stereo or dual languages broadcasts	15
Sleep Timer	15
AV connections and input selection—input Selection and output signal	16

TELETEXT

Auto and List modes—Moving around, Auto, List	17
Control buttons	18

CONNECTING OTHER EQUIPMENT

Side or front connections and controls	20
Back connections	21

FOR YOUR GUIDANCE

The on screen Menus—a display of the main on—screen menus for your reference	22
Questions and Answers	23

OTHER INFORMATION

Notes—a page for you to record your own information	25
---	----

※ The OSD and figures shown in this manual may be somewhat different from the actual situation.

SETTING UP

For your safety

This equipment has been designed and manufactured to meet international safety standards, but like any electrical equipment, care must be taken if you are to obtain the best results and safety is to be assured. So, please read the points below for your own safety. They are of a general nature, intended to help you with all your electronic consumer products and some points may not apply to the goods you have just purchased.

Air Circulation...

Leave at least 10cm clearance around the television to allow adequate ventilation. This will prevent the TV from overheating and consequential possible damage to the TV. Dusty places should also be avoided.

Heat Damage...

Damage may occur if you leave the TV in direct sunlight or near a heater. Avoid places subject to extremely high temperatures or humidity, or locations where the temperature is likely to fall below 5°C(41 °F).

Mains Supply...

The mains supply required for this equipment is described in Specifications and Accessories table. Never connect to a DC supply or any other power source. DO ensure that the TV is not standing on the mains lead. DO NOT cut off the mains plug from this equipment, this incorporates a special Radio Interference Filter, the removal of which will impair its performance. The fuse should only be replaced by a correctly rated and approved type and the fuse cover must be refitted. IF IN DOUBT PLEASE CONSULT A COMPETENT ELECTRICIAN.

Do...

DO read the operating instructions before you attempt to use the equipment.

DO ensure that all electrical connections (including the mains plug, extension leads and inter-connections between pieces of equipment) are properly made and in accordance with the manufacturers' instructions. Switch off and withdraw the mains plug before making or changing connections.

DO consult your dealer if you are ever in doubt about the installation, operation or safety of your equipment.

DO be careful with glass panels or doors on equipment.

DO use the Auto Convergence Adjustment function (See page 12) or press SMART FOCUS button on side or front AV panel (See page 20), When this projection TV is installed first time or it has been moved or its direction has been changed.

After this Auto adjustment, if the picture effect is still not satisfactory, please adjust it by using Manual Convergence Adjustment function (See page 13).

DO Switch off your projection TV if the picture becomes abnormal and then switch it on. If the picture is still abnormal, please do switch off your TV immediately in order not to cause any further damage to this TV and then contact professional personnel for service.

SETTING UP

For your safety

Do not...

DON'T remove any fixed cover as this may expose dangerous voltages.

DON'T obstruct the ventilation openings of the equipment with items such as newspapers, tablecloths, curtains, etc. Overheating will cause damage and shorten the life of the equipment.

DON'T allow electrical equipment to be exposed to dripping or splashing or objects filled with liquids, such as vases, to be placed on the equipment.

DON'T place hot objects or naked flame sources, such as lighted candles or nightlights on, or close to equipment. High temperatures can melt plastic and lead to fires.

DON'T use makeshift stands and **NEVER** fix legs with wood screws. To ensure complete safety, always fit the manufacturer's approved stand or legs with the fixings provided according to the instructions.

DON'T listen to headphones at high volume, as such use can permanently damage your hearing.

DON'T leave equipment switched on when it is unattended, unless it is specifically stated that it is designed for unattended operation or has a standby mode. Switch off using the switch on the equipment and make sure your family know how to do this. Special arrangements may need to be made for infirm or handicapped people.

DON'T continue to operate the equipment if you are in any doubt about it working normally, or it is damaged in any way. Switch off, withdraw the mains plug and consult your dealer.

ABOVE ALL NEVER let anyone, especially children, push anything into holes, slots or any other openings. This could result in a fatal electric shock.

NEVER guess or take chances with electrical equipment of any kind. It is better to be safe than sorry.

SETTING UP

Installation and other points to follow

Where to install

Locate the television away from direct sunlight and strong lights. Soft, indirect lighting is recommended for comfortable viewing. Place the TV directly on the floor or a sturdy platform. The mounting surface should be flat and steady. If you install the TV onto a soft floor covering, make sure that the covering will not be damaged by the weight of the TV.

Use curtains or blinds to prevent direct sunlight falling on the screen.

Always take great care when moving this TV as it could mark polished floor surfaces or damage floor coverings.

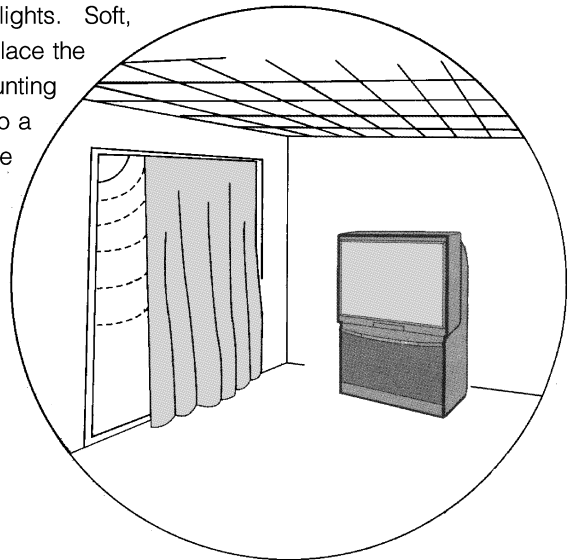

WARNING!
**NEVER LEAVE A STATIONARY
IMAGE ON THE SCREEN.**

If stationary images generated by TELETEXT, CHANNEL IDENTIFICATION LOGOS, COMPUTER DISPLAYS, VIDEO GAMES, ON SCREEN MENUS, etc. are left on the TV screen for any length of time, they will become permanently ingrained.

If you use your television to display completely still images, or moving pictures which have a permanent still image superimposed e.g. broadcast network logos, it is always advisable to reduce BOTH the brightness and contrast settings.

THIS DAMAGE IS EXPENSIVE TO REPAIR AND IS NOT PROTECTED BY YOUR WARRANTY AS IT IS THE RESULT OF MISUSE.

Cleaning the screen

The PTV uses slap-up exactitude optical screen. Please pay much attention to:

1. Keep environment clean; reduce dust or other pollution of the screen.
2. Avoid any liquid splash the screen that cannot get rid of completely.
3. Do not wipe the screen. Please cut off the power first, then pat the screen with soft clean cloth or blow the screen with blower in cold wind far away from the screen's surface if necessary. Avoid lacerate the screen carefully.

Disposal...

When the set reaches the end of its useful life please dispose of it in accordance with Local Government Regulations or at a recycling centre.

Please don't turn on/off the TV repeatedly and rapidly, otherwise your TV may not work properly.

SETTING UP

Your new television's remote control

Simple, at-a-glance reference of your remote control's buttons...

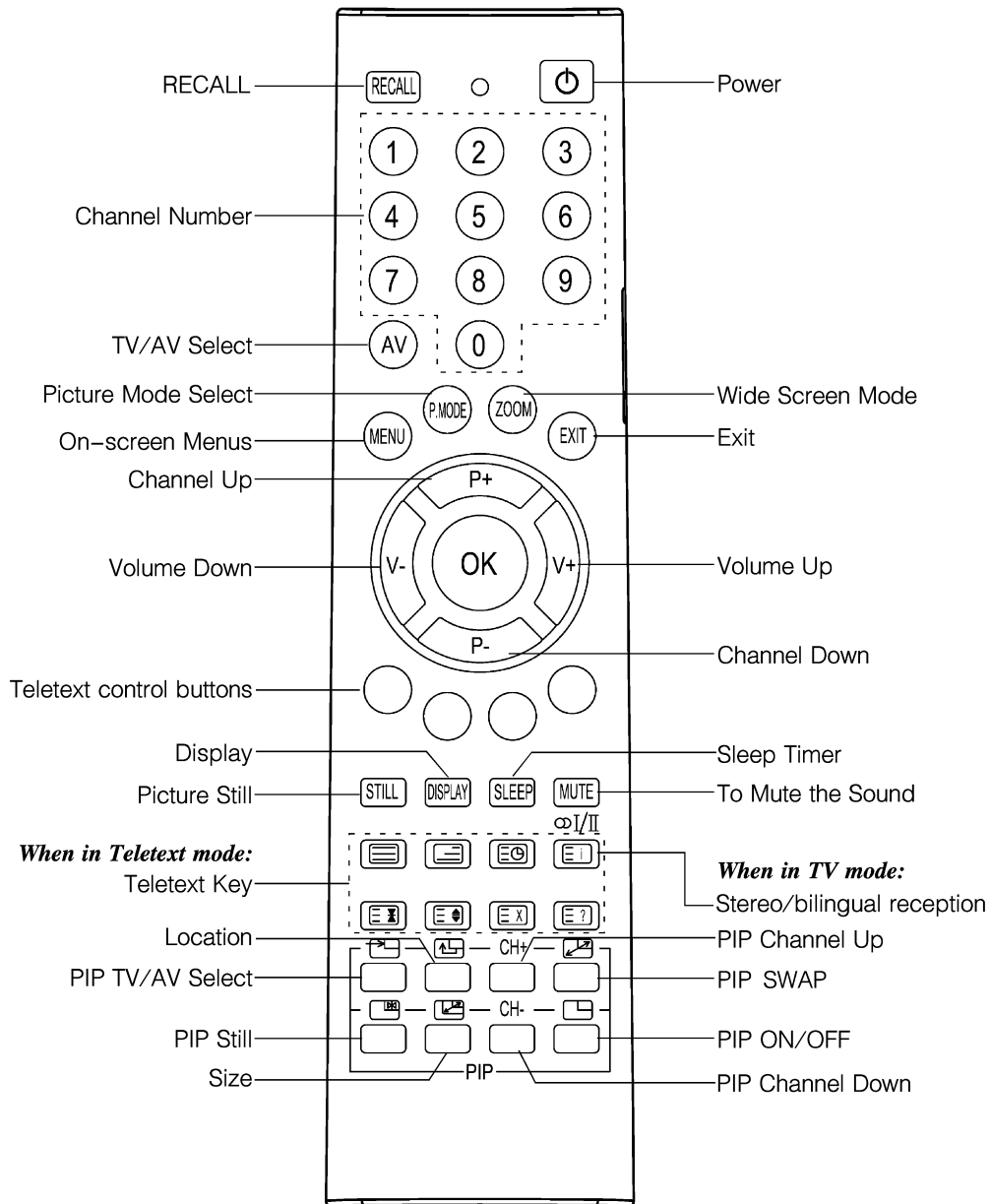

The batteries... and the effective range of the remote...

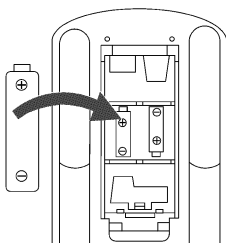

Remove the back cover to reveal the battery compartment and make sure you insert the batteries the right way round.

Suitable battery types for this remote are R03 or AAA.

Do not throw your old batteries into a fire, dispose of them in a designated disposal area. Do not combine a used, old battery with a new one or mix battery types.

The performance of the remote control will deteriorate beyond a distance of five metres or outside an angle of 30 degrees from the centre of the TV.

SETTING UP

Connecting and turning on your new TV

To conserve energy it is best to turn your TV off and not to leave it in Standby, unless the timer has been set.

The TV back connections...

Connect the aerial to the socket on the rear of the television.

the rear of your TV

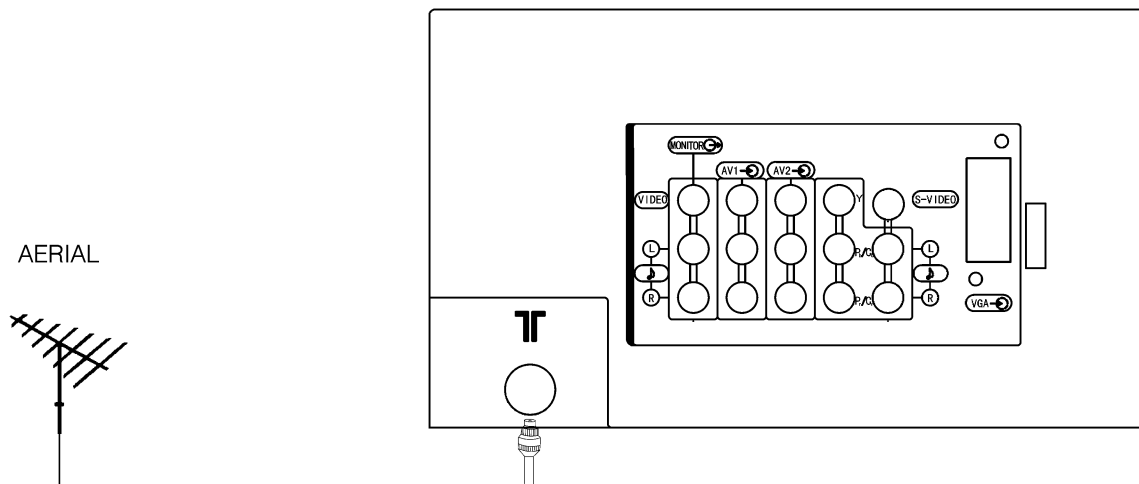

... and switching your new TV on/off

1 TURNING ON

a. Stand-By Mode

Press the on/off button in the front of your television. Your television goes to turning on mode.

b. Turning TV ON

When the TV is in stand-by mode, you can turn it on by pressing  button on the remote control or CH+/CH- keys on the panel of TV.

2 TURNING OFF

a. Turning TV OFF

When you wish to turn off your television, press the on/off button on it.

b. Stand-By Mode

To turn TV off for a short while, press  button on the remote control .

SETTING UP

Choosing the language and Auto Tuning

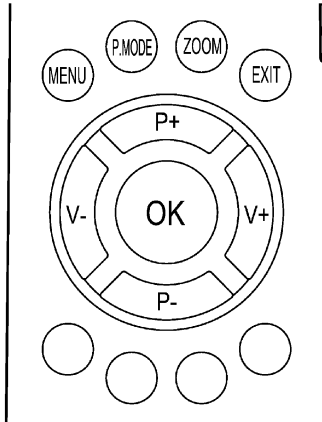

- 1** To choose your language, press the **MENU** button, and use the **V +** button to select **Tuning** from the top bar.

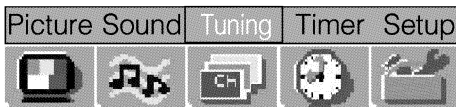

- 2** Now press the **P -** button to highlight **language** in the **Tuning** menu options.

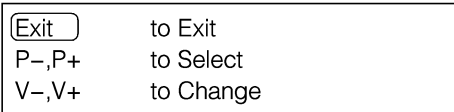
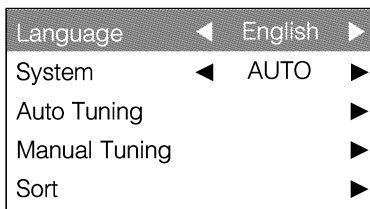

- 3** Press the **V -** or **V +** button to view the language options available. As you view each language, the words on the menus will automatically change for you.

- 4** Now press the **P -** button to highlight **Auto Tuning**.

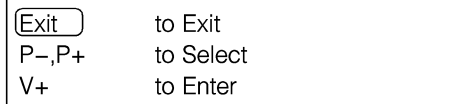
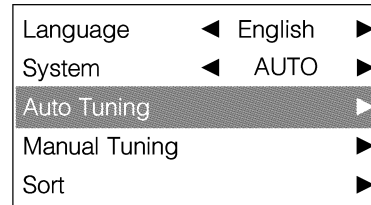

- 5** Then the **V +** button to go to the **Auto Tuning** screen.

- 6** Press **V +** button to select your country.

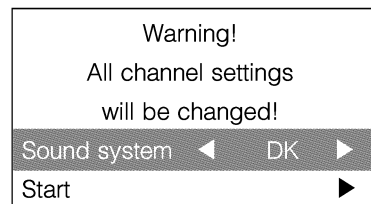

- 7** Press the **P -** button highlight **Start** and then press the **V +** button.

- 8** The search will begin for all available stations. **▶▶▶▶** will flash.

- 9** When the search is complete the TV will automatically return to programme position1. This may not be a clear picture, so you may wish to change the station order, using **Sort**, on page 8.

SETTING UP

Manually Tuning your TV

As an alternative to *Auto Tuning*, you can tune-in your television manually using *Manual Tuning*. For example: if you have used *Auto Tuning* but wish to tune-in a station on another *System*.

Manual Tuning

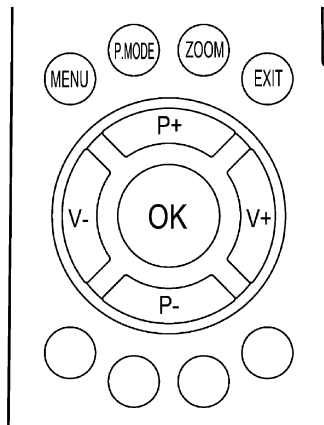

These options will appear as you select the "Manual Tuning" item in Tuning menu options.

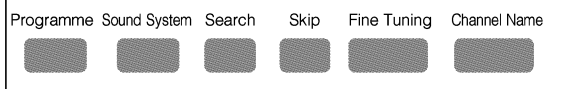

- Programme: The number to be pressed on the remote control.
- Sound System: Specific to certain areas.
- Search: Search up and down for a signal.
 - Skip: * means nothing has been stored or the facility to *skip* the channel is ON. see page 9.
- Fine Tuning: Only used if you experience interference/weak signal. See page 9.
- Channel Name: Station identification. You can use the P+ and P- or V+ and V- buttons to enter up to seven characters.

- From the top menu bar select *Tuning* and with the P- button highlight *Manual Tuning* and the v+ button to select.

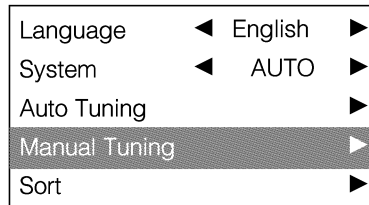
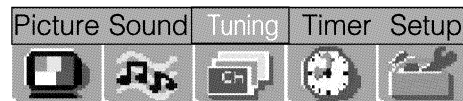

- Exit to Exit
- P-, P+ to Select
- V+ to Enter

- Using the P+ or P- button, highlight the programme position you require e.g. we suggest **prog. 0** for your video.

- Press the v+ button to select *Sound System* and use P+ or P- to change (if required).

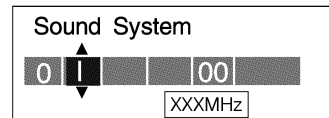

- Ok to Store
- Exit to Exit
- Menu to Previous menu

XXXMHz: the frequency data of current channel.

- Press the v+ button to select *Search*.

- Press the P+ or P- button to begin the search.

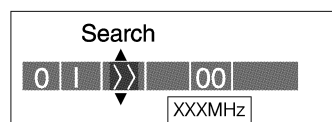

- Ok to Store
- Exit to Exit
- Menu to Previous menu

Manually Tuning your TV continued Sorting programme positions

6 On finding a signal it will show on the television, if it is not your desire, press the P+ or P- button again to restart the search.

7 When the signal is found, press the v+ button to move along to *Channel Name*. With the v+, v-, P+ and P- buttons, put in the required characters, e.g. VCR.

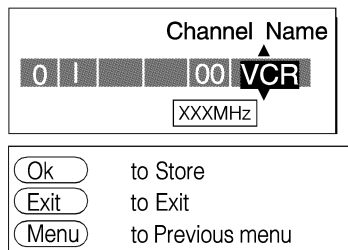

8 Now press OK to store.

9 Repeat for each *programme position* you want to tune, e.g. to tune to *Programme Position 6* press the p+ or p- button repeatedly to select 6 then repeat from step 3. Or, press MENU to return to and select the next number to tune.

10 Press EXIT when you have finished tuning in.

To sort programme positions

After tuning, if you want to change the position of certain programmes you can. *Sort* is an easy way of storing each channel on the programme position of your choice.

1 Press the MENU button and then the V- or V+ button to select the *Tuning* option from the top bar.

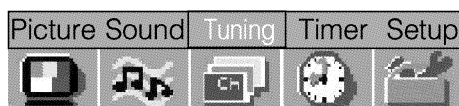

2 Press P- to highlight *Sort*.

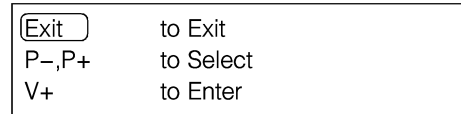
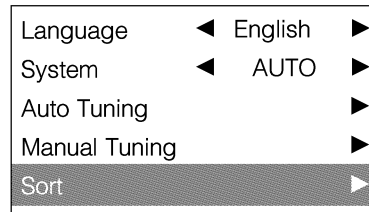

3 Press V+ to enter, the list of stations is now showing. With the P- or P+ button highlight the station you want to move and press OK to select.

Sort	
30	376M
31	384M
32	400M
33	425M
34	432M

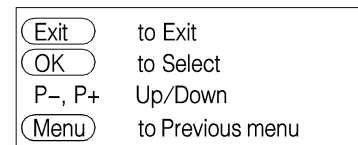

4 Use the P- or P+ button to move through the list to your preferred position. As you do so the other stations will move to make room.

5 Now press the OK button to set your move.

6 Repeat as necessity and then press EXIT.

Fine Tuning and skip

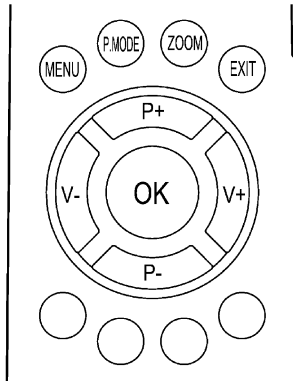

This TV doesn't have Microsearch functions, If you aren't satisfied with the picture quality after Auto Search, please use Fine Tuning under Manual Tuning to get better picture.

Fine Tuning

Fine Tuning should not be required unless you experience interference or a weak signal.

- 1 Select **Manual Tuning** from the **Tuning** menu.
- 2 Press V+ button to enter. Use P- or P+ button to select a programme position for fine tuning.
- 3 Press the V+ button repeatedly until the words **Fine Tuning** are showing.

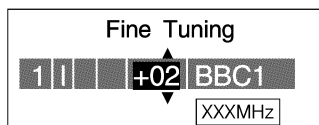

Ok to Store
Exit to Exit
Menu to Previous menu

- 4 With the P+ or P- button adjust to get the best picture and sound.
- 5 Press OK to store and then EXIT.

Skip

To prevent certain programmes from being viewed, for example, a certain film by your children whilst you are out for the evening, you can skip the programme position and take the remote control with you. The television will still function as normal using the controls on the front of it, but the set will not show the skipped programme position.

- 1 Press the MENU button and from the top menu bar select **Tuning**.
- 2 With the P- button highlight **Manual Tuning** And press the V+ button to select the **Manual Tuning** screen.
- 3 Use the P- or P+ button to select programme position to be skipped.
- 4 With the V+ button move along to **skip**.
- 5 Use the P+ or P- button to turn skip: On/Off, Press OK to store.

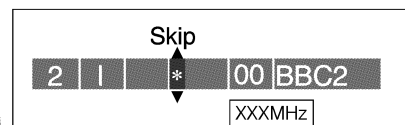

on the screen indicates a skipped programme position.

Ok to Store
Exit to Exit
Menu to Previous menu

- 6 Then press the MENU button and either repeat from Step 3 or press EXIT to finish.

Each programme position has to be INDIVIDUALLY selected and set with **Programme skip On or Off**.

The **skipped** programme positions cannot now be selected by the P+ and P- buttons or by the controls on the front of the TV, but can still be accessed by the number buttons on the remote control. To turn **skip OFF**, repeat the procedure on the chosen channel.

General and sound controls

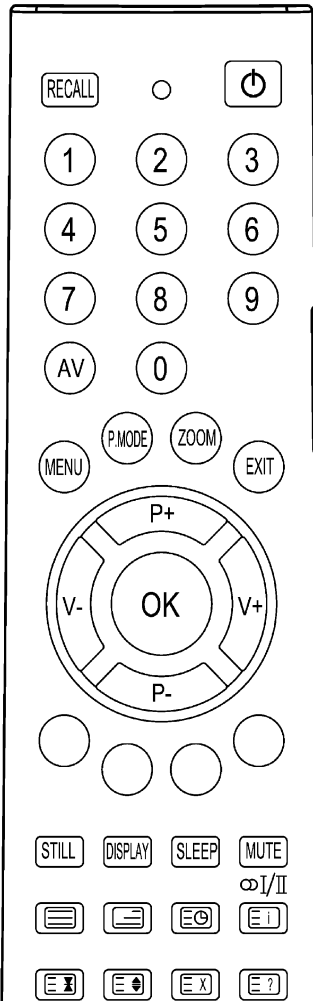

Selecting and changing programme position

Enter the desired programme position number using the numbered buttons on the remote control.

For programme positions below 10 use 0 and the required number e.g. 01 for programme position 1.

You can also change the programme position by using the P+ and P- buttons.

Use the **RECALL** button to revert to the previous programme position.

The programme position will be displayed on the screen with the Stereo/Mono **Stereo** Indicator, described on page 15.

Still Picture

Using the latest technology this television's 100Hz double scanning plus digital picture processing produces a flicker reduced picture. In addition, a still picture—similar to freeze frame on a VCR—can be held on the screen.

Pressing the **STILL** button will hold an image on the screen.

Press **STILL** again to return to TV mode.

Sound control

Volume

Press the V- or V+ button to adjust the volume.

Volume 33



Sound Mute

Press the **MUTE** button turn the sound off.

Press it again and the sound will return.

Bass, treble and balance adjustments

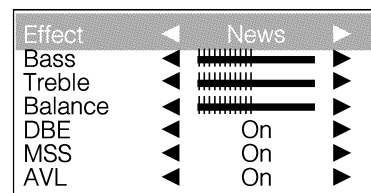
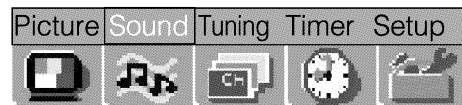

Exit	to Exit
P-,P+	to Select
V-,V+	to Change

Press the MENU button on the remote control, and the V+ or V- button to select the **Sound** option from the top bar.

Press the P- button to highlight **Bass**, **Treble** or **Balance** from the **Sound** menu and the V+ or V- button to change the setting.

DBE MSS AVL

Select **DBE MSS AVL** from the **Sound** menu. Select between ON and OFF to obtain the best sound. The differences may not always be noticeable.

Picture controls

This television offers you the choice of personalising the picture style to suit your own preference.

Picture Preferences, Digital Noise Reduction and Zoom

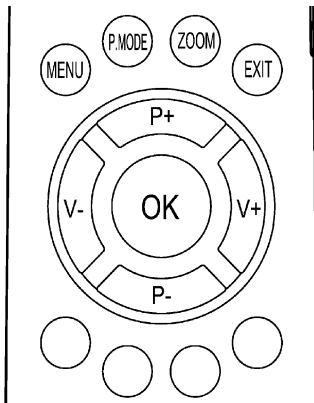

Picture preferences

By pressing the **P.MODE** button you can view the different standard picture styles available: *STANDARD, SHARP, SOFT* preset options and *USER* is for your own settings:

- 1 So, to set your own, choose **Picture** from the top menu bar.

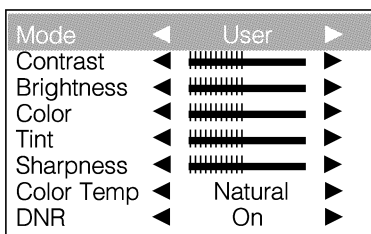
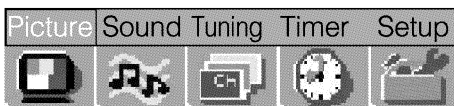

Exit to Exit
P-,P+ to Select
V-,V+ to Change

Within this **Picture** menu you have the options to adjust the **Contrast, Brightness, Colour, Tint** and **Sharpness**.

- 2 Using the **V+** or **V-** button alter to suit your taste.

DNR—Digital Noise Reduction

DNR enables you to 'soften' the screen representation of a weak signal.

Select **DNR** from the **Picture** menu. Select between **ON** and **OFF** to obtain the best picture. The differences may not always be noticeable.



Adjusting the aspect ratio

If the picture you are watching is out of proportion it can be adjusted.

Press the **ZOOM** button to choose the proportions best suited to the picture on screen.

※ For 16:9 aspect model only.

The Tint can only be adjusted on a signal from an NTSC video recorder when the television is in AUTO colour mode.

Picture controls continued

The picture may blur because of magnetic field on the Earth if you change the location or direction of the projection TV (due to poor convergence of three projection tubes). You could adjust convergence *AUTO* or *MANUAL*.

Automatic Convergence Adjustment

- 1 From the *setup* menu select *convergence* (press "SMART FOCUS" button can also adjust convergence automatically).
- 2 Press V+ button to select *AUTO* .

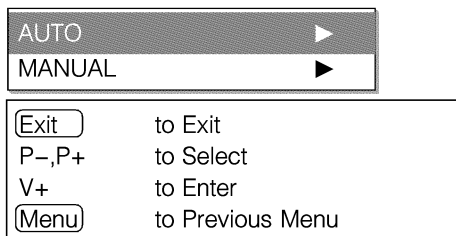

- 3 Use the V+ button to change. The projection TV will auto return to normal viewing picture mode after adjusting.

Picture controls continued

Manual Convergence Adjustment

1 From the *setup* menu select *Convergence*.

2 Press V+ button to enter and press P- button to select **MANUAL**.

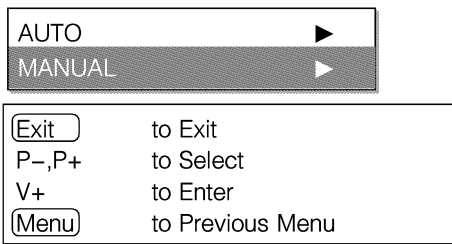

3 Press "5" to select the center point where you wish to adjust shown as the right figure.

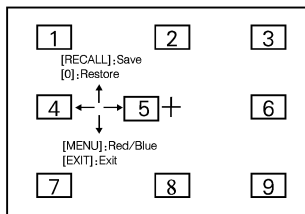

4 Press MENU to select red or blue convergence.

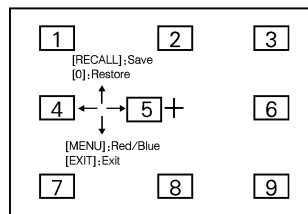

5 Press P- or P+ and V- or V+ to make the red/blue line at the cursor align up with the green reference line.

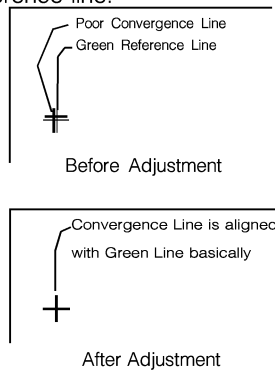

6 After complete the above adjustment, press "1", "2", "3", "4", "6", "7", "8" and "9" to adjust convergence for the other areas.

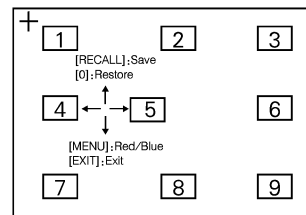

7 Repeat Step 4 and 5 to make the adjusting line up with the green reference line.

8 To save the adjusted data, press **RECALL**.

9 To give up the adjusted data by pressing **EXIT** directly.



USING YOUR TV

Picture controls continued

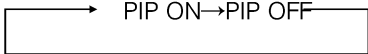
PIP Controls

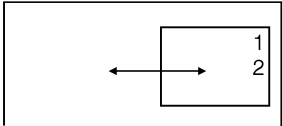
1  Press repeatedly to scan through the following modes:

2  Press to switch between the main and sub-pictures.

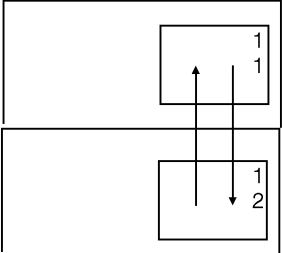

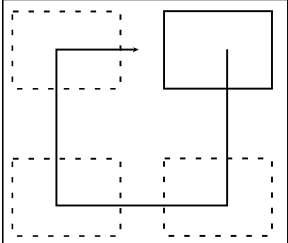
3   Press to select an upper or lower number for PIP.

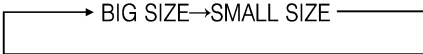
4  Press to change the position of a sub-picture.

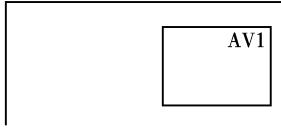
5  Press to scan through the following modes:

6  Press to switch between AV and TV for sub-picture.

This feature allows you to specify the type of signal going into AV1,AV2 on the back of the television and AV3 on the side for PIP. Please refer to the manufacturer's instructions for the connected equipment.

7  Press to make sub-picture still.

※ With PIP on, signal from the YPbPr (or YCbCr) and VGA jack can't be displayed on the sub-picture.

The timer, display, panel lock, stereo/bilingual transmissions and sleep Timer

The Timer

You can tell the TV to turn itself ON or OFF after a certain time.

- 1 Select the **Timer** option from the top menu bar.

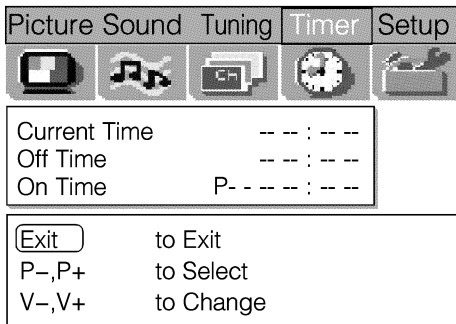

※ P:PROGRAM

- 2 Press P+/P- to select settings.
Press V+/V- to set the figure.
eg. **On Time** setting
Select the **On Time** option, a sub -menu will appear on the screen, then you can set the TV turn -on time and the programme number you want to watch using the button of P+/P- and V+/V- on the remote control.

- 3 Press "Exit" after setting done.

- 4 To cancel the **On timer**, enter zero in each position including the programme position.

The Display

The display facility allows you to see programme No. and Stereo/Mono on the TV screen.

If you press the **DISPLAY** button on the remote control while watching a normal TV broadcast you will see some informations.

It will remain on the screen for about 6 seconds.

Panel Lock

Panel lock allows you to disable the buttons on the front of the TV set. You can though, still use all of the buttons on the remote control.

From the **Setup** menu select **Panel lock** and choose On or OFF with the V- or V+ buttons.

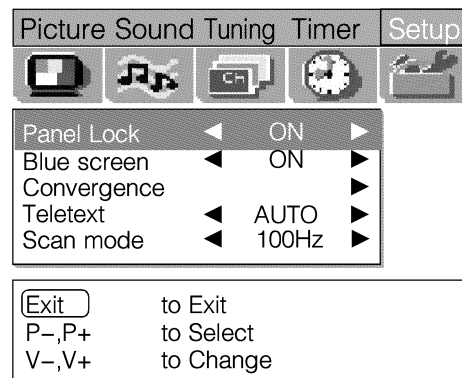

When **Panel lock** is **ON**, you will be reminded on the screen when you press any of the front panel buttons. Once the set has been switched off it can **ONLY** be brought out of standby using the remote control. If RC lost, **Panel lock** is on, Please press **EXIT** button on the panel of TV 10 seconds, **Panel lock** will be off.

Stereo and Bilingual transmissions

If stereo or dual language broadcasts are transmitted the word **Stereo** or **Dual** will appear on the screen, disappearing after a few seconds. The display will reappear each time you change programme positions, provided that the broadcast is in stereo. If the broadcast is not in stereo the word **Mono** will appear.

Stereo... Choose the required programme number. Press the **ST** button repeatedly, to select between **stereo** and **Mono**.

Bilingual ... Bilingual transmissions are rare. If they are transmitted the word **Dual** will display. Choose the required programme number and if the word **Dual** does appear press the **ST** button to select between **Dual 1**, **Dual 2** or **Mono**.

Sleep Timer

The sleep timer facility allows you tell the TV to itself OFF after a certain time.

Press **SLEEP** button repeat to select sleep timer OFF , 15 min to 180 min.

AV connections and input selection

...Please see page 21 for a clear view of the back connection recommendations...

Defining your INPUT and OUTPUT sockets so that your television recognises connected equipment.

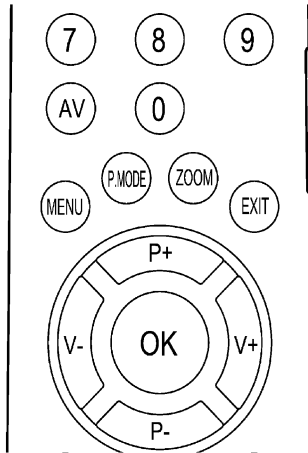

Input Selection

- 1 Press the **AV** button to bring up AV1 on the screen. This will display the CVBS or Y/C signal coming in through AV1.
- 2 Press the **AV** button again to select the equipment connected to AV2. This will display the CVBS signal coming in through AV2.
- 3 And press the **AV** button again for AV3, it will display the CVBS or Y/C signal coming in through AV3, and again for YPbPr and again for VGA.
- 4 To return to TV mode simply press one of the numbered buttons on the remote control. To view the external equipment once again, simply press the **AV** button until you see your external source.

Output signal

Video out jack can output the video image signal from TV, AV1, AV2, AV3.

Teletext

-Auto and List modes

Moving around the teletext pages in AUTO and LIST modes and selecting favourite pages

Moving around

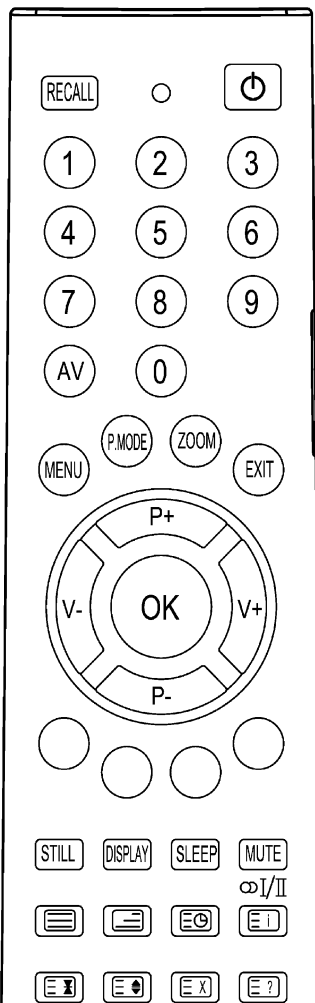

There are two Modes: **AUTO** will display **FASTTEXT**, if available. **LIST** will display your four favourite pages. In either mode, as an alternative to the coloured buttons you can access a page by entering a 3-digit number, using the buttons on the remote control, or to advance to the next page of teletext, press the **P+** button, to go back to the previous page press the **P-** button.

From the **SETUP** select **Teletext** and with the V+ or V- button select either Auto or List

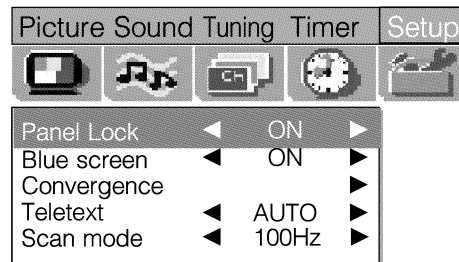

Auto

Press the  button to access teletext.

In **AUTO** mode, if **FASTTEXT**, is available, you will see four coloured titles at the base of the screen.

To access one of the four given subjects, press the relevant coloured button on the remote control, corresponding to the title.

For further information on your particular text system(s), see the broadcast teletext index page .

List

In **LIST** mode, the four choices at the bottom of the screen are now numbers – 100, 101, 102 and 899, which have been programmed into the TV's memory.

To view these pages use the coloured prompt buttons e.g. press the **GREEN** button to view page 200.

If you want to change these stored pages press the coloured button for the colour you want to change, e.g. **GREEN** and enter the 3 digit number.

This number will change in the top left of the screen and in the coloured highlight.

The rest of the text control buttons are explained on the next page...

Teletext continued –control buttons

Using the buttons on the remote control

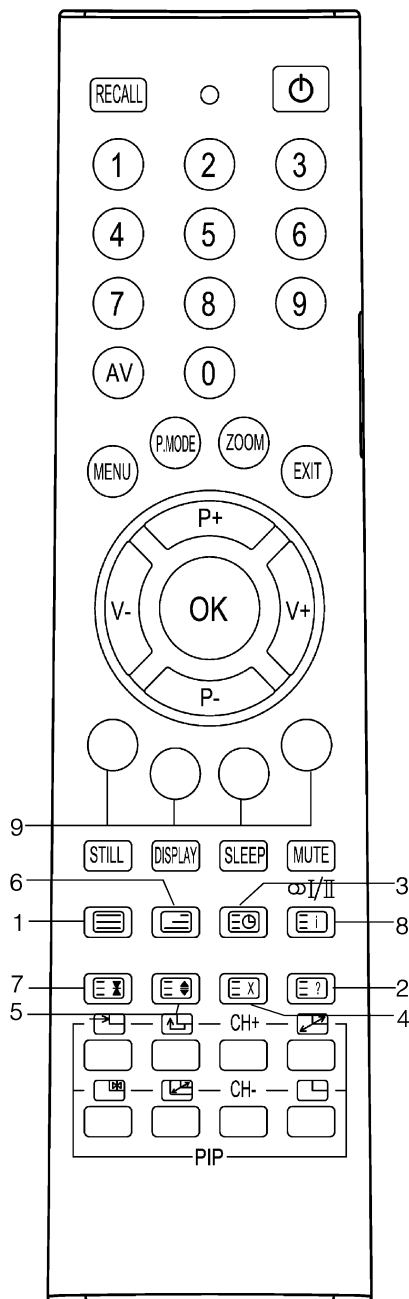

- 1** Teletext key
moves to the teletext broadcast in the channel you view.
- 2** Reveal/Conceal (answering) key
When in the teletext position, it enables display or hiding of some information hidden in the text broadcast.
- 3** Teletext timer (calling sub pages) key
In the teletext mode, it is used for accessing the sub pages directly.
For example; you are in the 500th teletext page. If 1/2 is observed at the bottom of the screen, 1 denotes the sub page that we are in, 2 denotes the total amount of the remaining sub pages. At this state, when the teletext timer key is pressed, _ _ _ _ signs are displayed instead of the teletext page number. Using the 0..9 numerals on the remote control, the sub page number that you want to go is entered. For example, if you want to go to sub page number that you want to go is entered. For example, if you want to go to sub page 2, the 0, 0, 0, 2 keys are pressed consecutively.
- 4** Cancel (updating) key
If you press this button while in teletext mode, TV broadcast will be displayed. But teletext is still active and if you enter a page number, it continues to search for it. When the page is found, a message to show that is displayed. If you press this button again, teletext will be displayed.
- 5** Size (page expanding) key
This button enables you to view the teletext page in 3 different formats. Normal size, upper part enlarged two times, down part enlarged two times.

Teletext continued

-control buttons

Now you have set up teletext, below is a guide to the remote control teletext buttons and their functions.

Using the buttons on the remote control

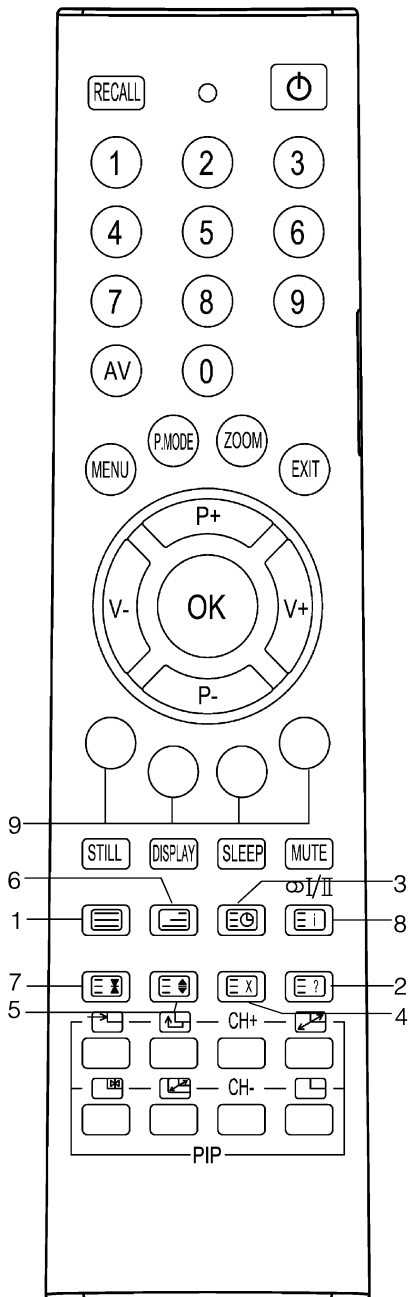

- 6** Mix (viewing TV and Teletext information together) key. In teletext mode, TV broadcast and teletext will be displayed at the same time. If you push the button again, it will be back to normal.
- 7** Hold (holding sub page) key
If a teletext page has bottom pages, these pages are displayed with certain time intervals. In such case, the current page is hold constantly. STOP icon will appear at the left upper corner of the page when you do this. Press the button again, to deactivate the function.
- 8** Index (main page) key
This button takes you directly to the index page of the teletext.
- 9** Color (red, green, yellow, blue) keys
(This feature applies to fast teletext broadcast). You can scan the teletext information more easily using these four color text buttons.

EXAMPLE:

Press **RED** button to receive TV information

↓
TV GUIDE

Press **YELLOW** key to receive the news

↓
NEWS

Press **GREEN** key to receive Sports Information

↓
SPORTS

Press **BLUE** key to receive weather forecast

↓
WEATHER

(The information above is given as example. The information corresponding to the colors changes according to the page being investigated).

NOTE:Some models do not have TELETEXT feature.

CONNECTING OTHER EQUIPMENT

Side connections and front controls

You can connect a wide variety of external equipment via the sockets located behind the flap on the side or front of the TV. Press flap to open it.

※ Position of AV panel rest on the TV model. This manual takes side AV connections for example. Even so, the marks indicate the same connections of sakets, Please reference to the introduction.

Side connections

! Please always refer to the owner's manual of the equipment to be connected for full details.

! Don't use Side Video IN and S-Video IN at the same time.

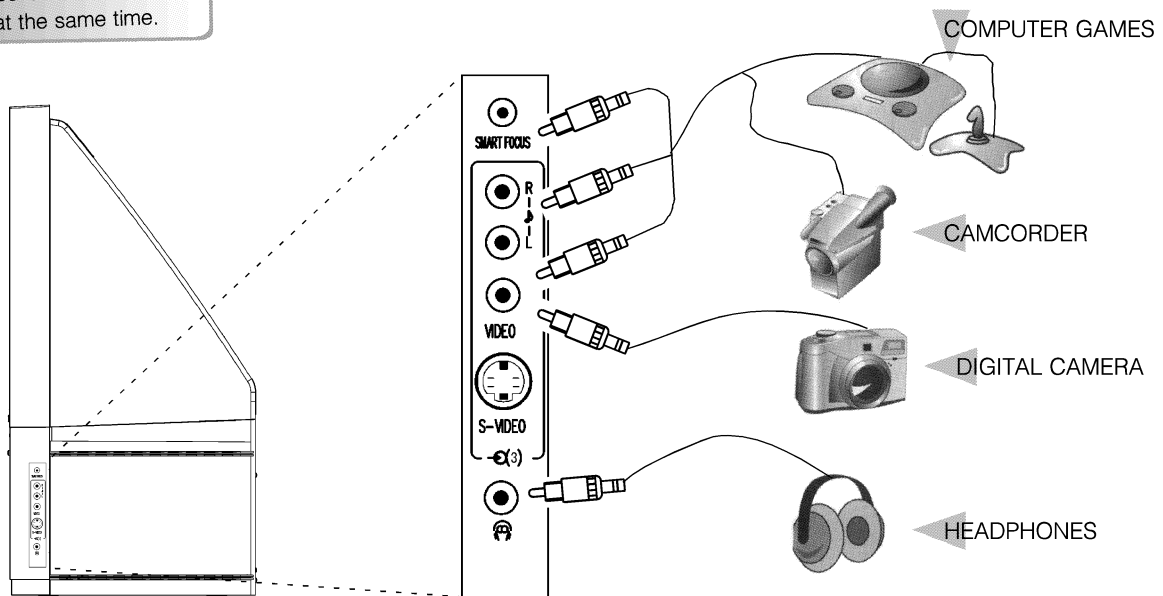

Before connecting any external equipment, turn off all main power switches.

To select the side Inputs, press the **(AV)** button until the display shows **AV3**.

Please note: Inserting the headphone jack will mute the sound from all speakers.

You can press "**(AV)**" button on the remote control to select "DUAL-1" for Left Audio Channel; "DUAL-2" for Right Audio Channel; "STEREO" for Separate Left and Right Audio Channel Signal input.

For Example, When you connect the Audio Signal of any external equipment to only "L" or "R" socket of AV Input of this TV, you will hear only Left loudspeaker or Right loudspeaker working respectively.

If you want the Left loudspeaker and Right loudspeaker of this TV sound simultaneously, Please press "**(AV)**" button on the remote control

and then select "DUAL-1" while only "L" socket of AV Input connected, or select "DUAL-2" while only "R" socket of Input connected.

Front controls

While all the necessary adjustments and controls for your new TV are made using the remote control, the buttons on the front of the TV may be used for some functions...

For example, to alter the volume press the **VOL+**, **VOL-** buttons, and to alter the programme position press the **CH+**, **CH-** buttons.

...press the **MENU** button and control the picture and sound options with the **CH+**, **CH-**, **VOL+** and **VOL-** buttons.

CONNECTING OTHER EQUIPMENT

Back connections

! Don't use Back AV1 Video IN and S-Video IN at the same time.

Back connections

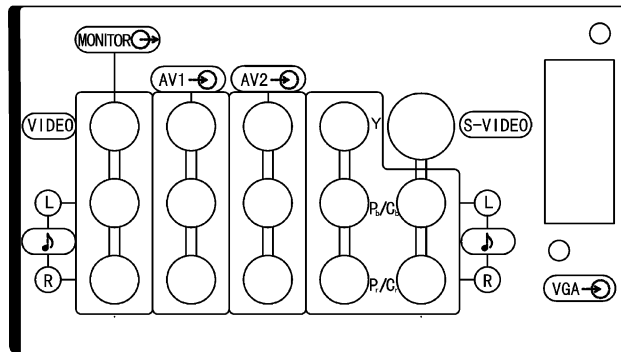

AV Interfaces	Description
MONITOR	The monitoring signal output of the TV can be used as the signal resource, it can be connected to video tape recorders or other AV equipments which can do REC(only when pictures display in HDTV component or VGA mode without any monitoring signal output).
AV1 AV2	Used to connect AV equipments such as VCD 、 DVD and other AV output. Connect video image signals to the yellow port while audio signals are connected to the white(left track) and the red(right track) ports.
YPbPr(YCbCr)	Used to connect AV equipments with component signal output ports such as settop box and DVD etc. Y(brightness) signal is connected to the green port , B-Y (U chromatism)signal to the blue port, R-Y (V chromatism)signal to the red port and AV signal to the white(left track) and the red (right track) ports.
S-VIDEO	Used to connect AV equipments such as DVD with S port output(Y/C component signal output port),the audio interface is using in community with AV1(back S-Video) or AV3(Side S-Video).
VGA	Used to connect PC signal input ,supporting many formats of 640×480(60/75Hz) 、 800×600(60/75Hz) and 1024×768(60Hz)

Before connecting any external equipment, turn off all main power switches.

If your TV switches over to monitor the external equipment you can return to normal TV simply by pressing the desired programme position button.

To recall the external equipment, press the (AV) button repeatedly to select between AV1, AV2, AV3 or YPbPr, VGA.

The on-screen menus

Press the **MENU** button on the remote control to see your top menu bar. This white menu bar will show five different topics shown in symbols. As you select each symbol by pressing the V- or V+ button, its respective options will appear below. To use the options press the P- button on the remote control to move you down through them.

Using the Menus

The functions of each menu are described in detail throughout this Manual.

The Picture Menu

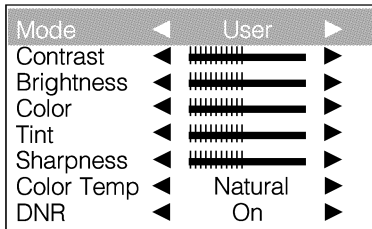
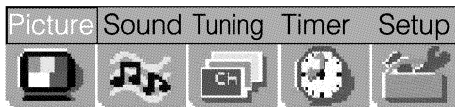

Exit to Exit
 P-,P+ to Select
 V-,V+ to Change

The Sound Menu

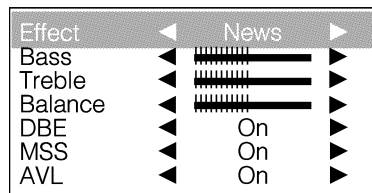
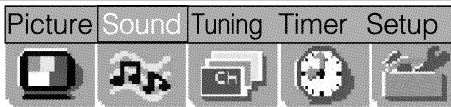

Exit to Exit
 P-,P+ to Select
 V-,V+ to Change

The Tuning Menu

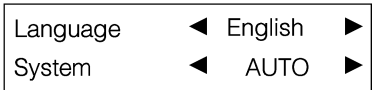
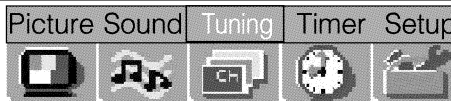

Exit to Exit
 P-,P+ to Select
 V-,V+ to Change

When watching an external source...

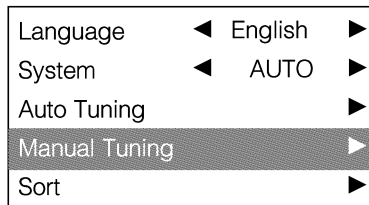
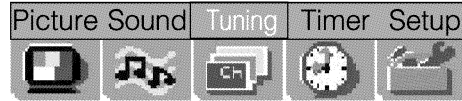

Exit to Exit
 P-,P+ to Select
 V+ to Enter

When watching a TV broadcast...

The Timer Menu

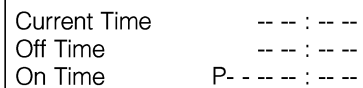
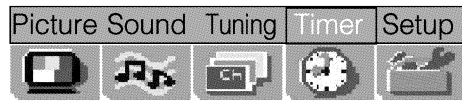

Exit to Exit
 P-,P+ to Select
 V-,V+ to Change

The SETUP Menu

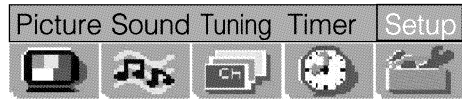

Exit to Exit
 P-,P+ to Select
 V-,V+ to Change

Questions and Answers...

If you experience what seem like problems operating your TV, we recommend you read through these simple checks.

Q Why is there no sound or picture?

A Check that the mains switch is on and check all the connections. Press the Power button on the remote control to make sure that the TV is not in Standby mode.

Q There is a picture, but why is there little or no colour?

A There is little or no colour...
When using an external source, for instance, a poor quality video tape, if there is little or no colour, improvements sometimes will be achieved. The television is factory set to **Auto Tuning** in the **Tuning** menu to automatically display the best colour system.

To check that you have the best colour...

1 From the **Tuning** menu select System.

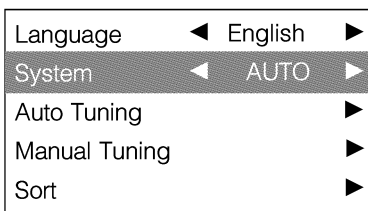
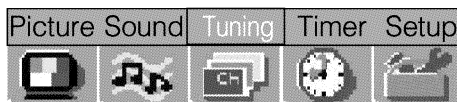

Exit	to Exit
P-,P+	to Select
V-,V+	to Change

2 With the v+ or v- button, choose between **AUTO**, **PAL**, **SECAM**, **NTSC4.43** or **3.58**.

Q Why are there distorted images/faded colours?

A This is sometimes due to condensation if the room temperature rises rapidly or if the TV is moved from a cold room to a warm room. Leaving the set turned on for a while should improve the images.

Q Can anything else cause a poor picture?

A Yes, interference or a weak signal. Try a different TV station.
Fine Tuning may help.

Q Why can't I see the video/DVD I am playing?

A Make sure you have connected the VCR or the DVD player to the TV as shown on page 21, then select the correct input using the **(AV)** button.

Q Why is the video/DVD in black and white?

A Check that the correct input has been chosen; **S-VIDEO** or **AV**. See **AV connections**.

Q Why doesn't the remote control work?

A Check that the batteries aren't dead and that they are inserted correctly.

Q I have a picture, but why have I no sound?

A Press the volume button v+ or the sound **(MUTE)** button.

Q Why don't the controls on the front of the TV work?

A Check that **panel lock** is not ON

Q Why is there a message permanently on the screen?

A Remove it by pressing the **(DISPLAY)** button.

Questions and Answers... continued

Q Why has my screen turned blue?

A Blue screen in the setup menu is ON. When no signal is being received, the TV will turn off the sound and switch the TV screen to blue. After 5 minutes the TV will switch to Standby mode.

Q Why am I having problems with teletext?

A Good performance of text depends on a good strong broadcast signal. This normally requires a roof or loft aerial. If the Text is unreadable or garbled, check your aerial. Go to the main index page of the teletext service and look for the User Guide. This will explain the basic operation of teletext in some detail. If you need further information on how to use text see the teletext section.

Q Why do I not have any teletext sub-pages?

A There are no broadcast or they have not yet been loaded.

OTHER INFORMATION

For your own reference...

Notes

.....

Specifications and Accessories

Rated voltage	160–250V~, 50/60Hz
Rated power consumption	~230W
Dimensions (wXhXd)	43AP75: 942mm×1255mm×487mm 43APB1W: 1016mm×1015mm×530mm 43APG1W: 1016mm×1015mm×530mm 51APB5: 1308mm×1404mm×526mm 51AP95: 1100mm×1384mm×560mm 51AP15W: 1193mm×1265mm×542mm
Weight	43AP75: 61kg 43APB1W: 58kg 43APG1W: 58kg 51APB5: 73.5kg 51AP95: 68kg 51AP15W: 68kg
Projection screen(w×h)	43AP75: 876mm×656mm 43APB1W: 952mm×536mm 43APG1W: 952mm×536mm 51APB5: 1035mm×778mm 51AP95: 1035mm×778mm 51AP15W: 1129mm×639mm
Channel coverage	PAL-I UHF UK21–UK69 PAL-B/G UHF E21–E69 VHF E2–E12, S1–S41 SECAM-L UHF R21–R69 VHF R1–R12
Programme positions	100
Stereo	Nicam/A2
Video input	PAL, SECAM, NTSC 3.58/4.43
Audio output	13W+13W (THD=10%)
Accessories supplied	Operation manual Remote controller AAA alkaline batteries (2) Packing List Versatile Wheel pads (43APB1W:0 43APG1W:0 51AP15W:4 43AP75:4 51AP95:4 51APB5:4)

JUT6.491.1087

Free Manuals Download Website

<http://myh66.com>

<http://usermanuals.us>

<http://www.somanuals.com>

<http://www.4manuals.cc>

<http://www.manual-lib.com>

<http://www.404manual.com>

<http://www.luxmanual.com>

<http://aubethermostatmanual.com>

Golf course search by state

<http://golfingnear.com>

Email search by domain

<http://emailbydomain.com>

Auto manuals search

<http://auto.somanuals.com>

TV manuals search

<http://tv.somanuals.com>