

# ChannelPlus Telephone Entry Module

## IMPORTANT INSTRUCTIONS

When using your telephone equipment, basic precautions should always be followed to reduce the risk of fire, electric shock and injury to persons, including the following:

1. Read and understand all instructions
2. Do not use this product near water, for example, near a bath tub, wash bowl, kitchen sink, or laundry tub, in a wet basement, or near a swimming pool.
3. Never push objects of any kind into this product through cabinet slots as they may touch dangerous voltages.
4. Use only UL listed cabinets like the H218 or H236.
5. **SAVE THESE INSTRUCTIONS**

The H611 Telephone Entry Module provides a superior method of telephone connection to your system. Each unit provides surge suppression for all four lines, a master disconnect, and an RJ-31X for connection to alarm systems. Also, each line has an LED status indicator to warn you of a surge event.

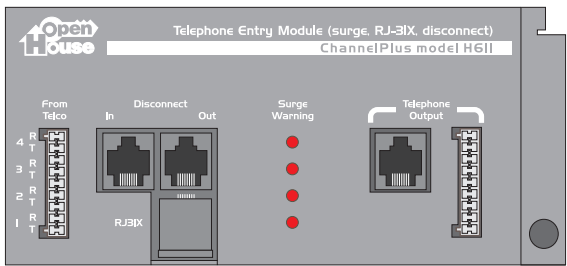

## Typical Installation

Install this jumper for normal operation. Remove to disconnect telephone service from the system.

Each line is individually surge protected to 50 Joules and 4000 Amps. Some surges contain sufficient energy that although your system has been protected, the surge circuit will be unable to provide additional protection. When this happens, the red light for that line will turn on and the module needs to be returned for service.

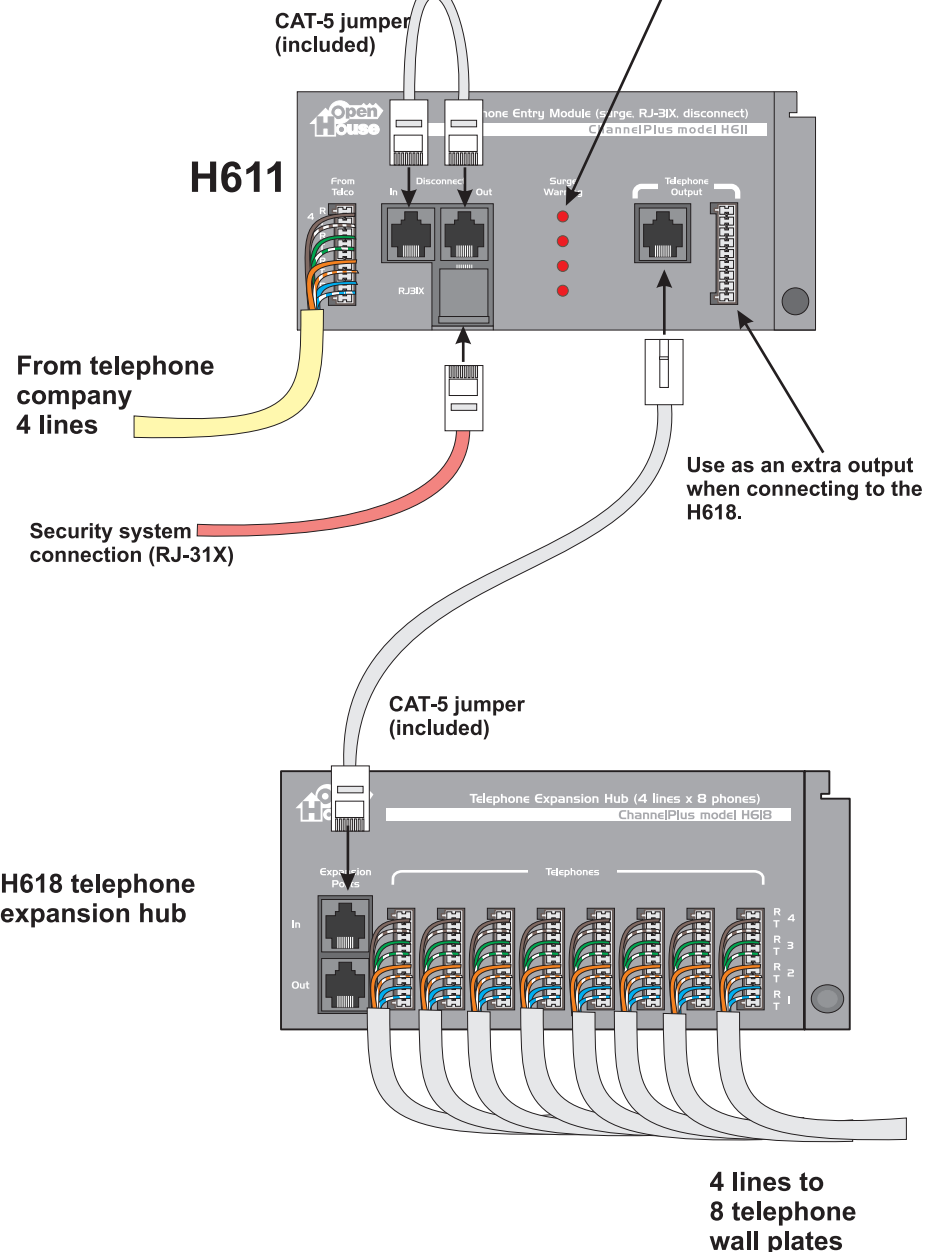

## SAFETY INFORMATION:

- a) Never install telephone wiring during a lightning storm.
- b) Never install telephone jacks in wet locations.
- c) Never touch uninsulated telephone wires or terminals unless the telephone line has been disconnected at the network interface.
- d) Use caution when installing or modifying telephone lines.

OpenHouse™ modules attach from the top

- 1) Hook from the top
- 2) Swing into place
- 3) Push button to

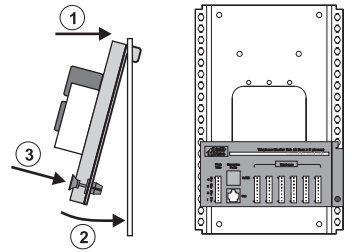

## Wire Color Codes

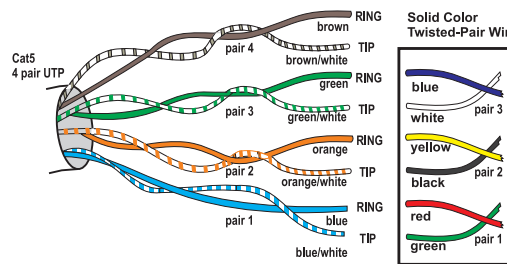

## Modular connectors

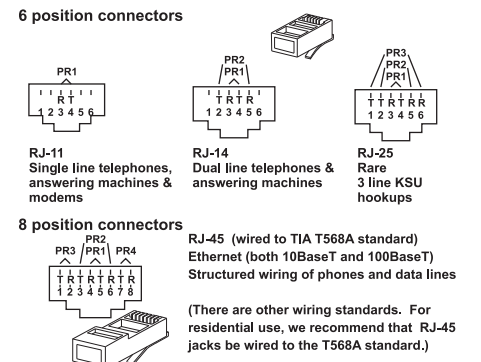

## Wiring a 110 connector

Keep sheath close to connector Untwist .5" max.

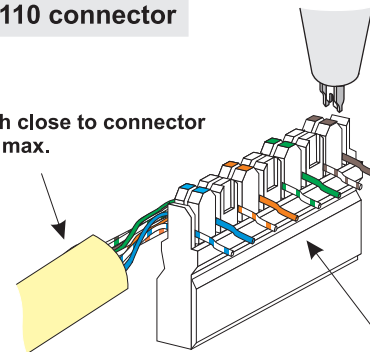

110 punch down tool

The 110 is a sophisticated insulation displacement connection system. To push the wire between the contact blades, use only a 110 punch down tool. Using a screwdriver or needle nose pliers may not seat the wire properly and can damage the contacts.

Note order of colors

## Wiring a telephone wall plate

Cable Color	Pin #	Connector Color
White/Orange	Pin 1	N/C
Blue	Pin 2	White/Orange
White/Blue	Pin 3	Blue
Orange	Pin 4	White/Blue
	Pin 5	Orange
	Pin 6	N/C

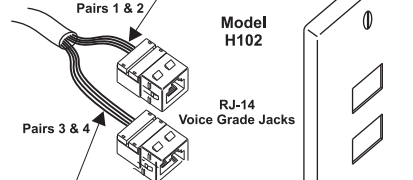

Option: old style wall plate

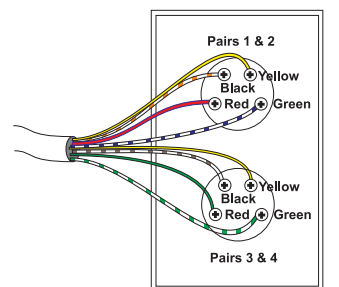

Cable Color	Pin #	Connector Color
White/Brown	Pin 1	N/C
Green	Pin 2	White/Orange
White/Green	Pin 3	Blue
Brown	Pin 4	White/Blue
	Pin 5	Orange
	Pin 6	N/C

## Wiring a Cat-5 jack

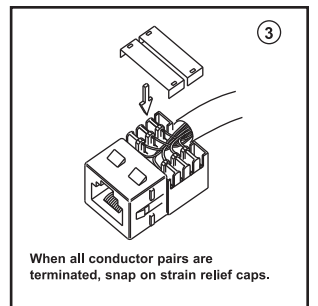
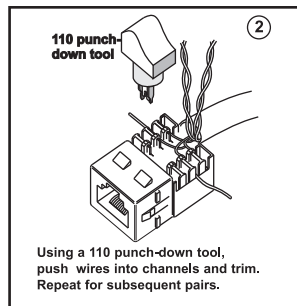
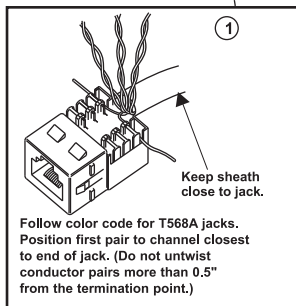

## Colors of OpenHouse™ wiring

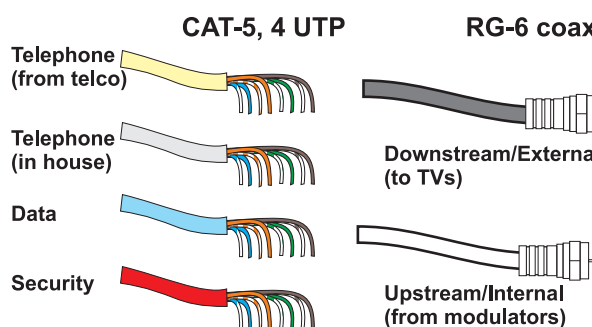

## Wiring Modular Plug (T568A)

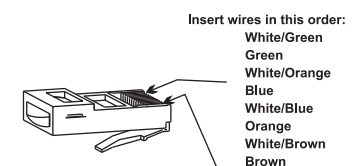



Compatible

# ChannelPlus Enclosures, Modules, Accessories & Wall Plates

## Service center enclosures

A full line of OpenHouse compatible enclosures, from simple, inexpensive mounting plates to high capacity in-wall cabinets. AC outlets can be mounted inside the cabinets using a UL listed accessory.

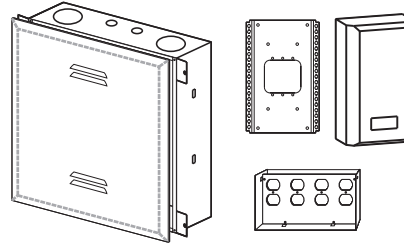

## Starter systems

RF splitters and telephone punch downs. When it is time to upgrade, just snap this module out and replace with one of more of the more sophisticated units.

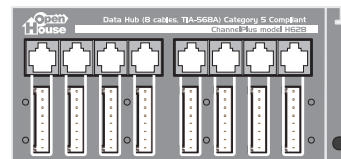
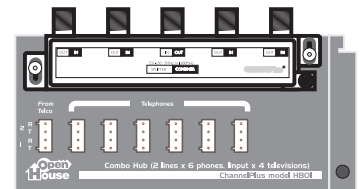

## Data hubs

Termination blocks for the CAT-5 cables, Ethernet hubs. Bring the Internet to any room in the home. Or create a home data network.

## Telephone hubs

Connections for 1-4 phone lines to every room. Starter hub adds RJ-31X jack for security system dialer.

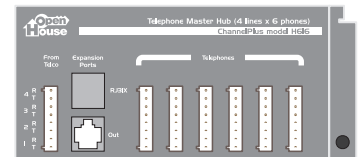

## Wall plates

Wall plate systems for all rooms. The typical room gets TV and telephone. The Home office wall plate adds data ports. The media center wall plate adds satellite feeds.

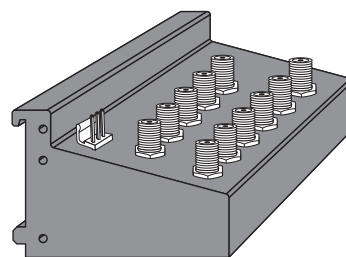

## Coax panels

Distribute antenna or cable TV to every room of the house. Some models include bi-directional amplifiers for interactive cable systems. Some models include modulator inputs and IR engines.

**AV modulators (for service center)**  
Create a new TV channel for a front door camera. Some models feature Cat-5 input connections.

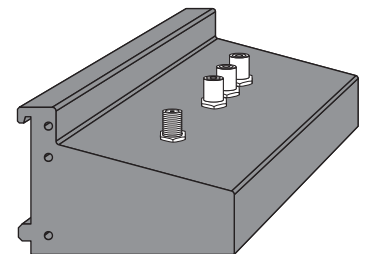

## AV modulators (for media center)

Create new TV channels for DVD, VCR, or a satellite receiver. These modulators sit in the media center. Some offer true MTS stereo.

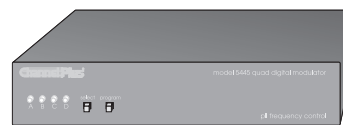

## IR Accessories

Control video devices from any room.

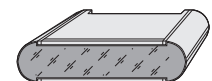

New OpenHouse products are added all the time.

Visit our website to learn more:

[www.openhousesystems.com](http://www.openhousesystems.com)

Good ...  
Typical room - phone, TV  
Media center - phone, satellite receiver, AV modulators  
Home office - phone, TV, cable modem  
Better ...  
Typical room - phone, TV, ethernet  
Media center - phone, TV, ethernet, satellite receiver, AV modulators  
Home office - phone, TV, ethernet, cable modem  
Best ...  
Typical room - phone, TV, ethernet, satellite receiver  
Media center - phone, TV, ethernet, satellite receiver, AV modulators, hi-speed data  
Home office - phone, TV, ethernet, satellite receiver, cable modem, hi-speed data

	Good	Better	Best
Typical Room	1 Cat-5 1 RG-6	2 Cat-5 1 RG-6	2 Cat-5 2 RG-6
Media Center	1 Cat-5 3 RG-6	2 Cat-5 3 RG-6	3 Cat-5 3 RG-6
Home Office	1 Cat-5 2 RG-6	2 Cat-5 2 RG-6	3 Cat-5 3 RG-6

## Wiring a house for OpenHouse

The cables in an OpenHouse run from the various rooms of the house directly to the service center location. This is known as 'home run' wiring. Two types of wire are used for communication and entertainment: Cat-5, 4-UTP (4 Unshielded Twisted Pairs) wire handles data or 1 to 4 telephone lines. RG-6 coax handles television signals. (An AV modulator creates new TV channels for front door camera, DVD player, a VCR or a satellite receiver.) We recommend the following pre-wire schemes. Run these wires from the service center to the rooms indicated.

## Telephone Entry Module ChannelPlus Model H611



**Linear**  
(760) 438-7000 USA & Canada (800) 996-5225  
Toll Free FAX (800) 468-1340  
[www.openhousesystem.com](http://www.openhousesystem.com)

### LIMITED WARRANTY STATEMENT

Linear LLC warrants this product to be free from defects in material and workmanship for 2 years. The time period will be measured using the date code labeled on the product. Linear LLC is not responsible for damage to the product resulting from the buyer's improper handling, stocking or warehousing of the product. Any implied warranty arising from the sale of the product including implied warranties of merchantability and fitness for purpose are limited. Linear LLC shall not be responsible for any losses, damages or expenses, whether direct, consequential, or incidental arising from the use or the inability to use the product. Some states and countries do not allow limitations or how long an implied warranty lasts or the exclusion or limitation or incidental or consequential damages, so the above exclusions may not apply. The Linear LLC warranty gives specific legal rights in addition to other rights, which may exist and vary from state to state and country to country.

The warranty is limited to repair or replacement of products returned, freight prepaid, to Linear LLC, there is NO PROVISION FOR LABOR COST OR OTHER REIMBURSEMENTS OF ANY KIND.

- Failures due to product abuse, such as negligence, improper use, and electrical surge including damage from lightning, water damage or other damage due to natural disasters are not covered by the warranty. The most common form of product abuse is surge damage caused by lightning.
- The warranty shall also be voided by any tampering with the date code, labels or other markings on the product.
- Products that are damaged in transit to Linear LLC due to improper packaging or by the carrier (shipping company) will not be covered under the warranty. If the product was damaged or lost by the carrier, it is the sender's responsibility to create a claim against the carrier.
- The user is responsible for all labor costs associated with removing, reinstalling and returning the product to Linear LLC.

Linear LLC, at its option, will repair or replace the defective product. Replacements will be made from B-Stock, if an exact replacement is not available, Linear LLC, at its option, will select the nearest equivalent product. The user is responsible for freight charges to Linear LLC. Linear LLC will return warranted repaired or replacements by UPS Ground or an equivalent service. A customer may pay the additional costs for second-day or next-day service.

All products returned for warranty service require a Return Product Authorization Number (RPA#). Contact Linear Technical Services at 1-800-421-1587 for an RPA# and other important details.

## Free Manuals Download Website

<http://myh66.com>

<http://usermanuals.us>

<http://www.somanuals.com>

<http://www.4manuals.cc>

<http://www.manual-lib.com>

<http://www.404manual.com>

<http://www.luxmanual.com>

<http://aubethermostatmanual.com>

Golf course search by state

<http://golfingnear.com>

Email search by domain

<http://emailbydomain.com>

Auto manuals search

<http://auto.somanuals.com>

TV manuals search

<http://tv.somanuals.com>