

ChannelPlus Telephone Entry Module

IMPORTANT INSTRUCTIONS

When using your telephone equipment, basic precautions should always be followed to reduce the risk of fire, electric shock and injury to persons, including the following:

1. Read and understand all instructions
2. Do not use this product near water, for example, near a bath tub, wash bowl, kitchen sink, or laundry tub, in a wet basement, or near a swimming pool.
3. Never push objects of any kind into this product through cabinet slots as they may touch dangerous voltages.
4. **SAVE THESE INSTRUCTIONS**

The **H612 Telephone Entry Module** provides a superior method of telephone connection to your system. Each unit provides surge suppression for two lines and a master disconnect. Also, each line has an LED status indicator to warn you of a surge event.

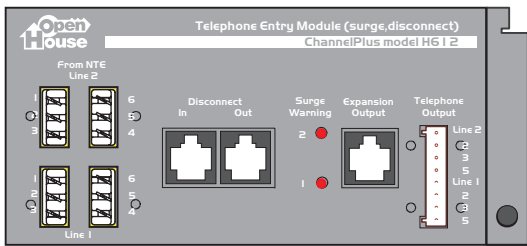

Typical Installation

Install this jumper for normal operation. Remove to disconnect telephone service from the system.

Each line is individually surge protected to 50 Joules and 4000 Amps. Some surges contain sufficient energy that although your system has been protected, the surge circuit will be unable to provide additional protection. When this happens, the red light for that line will turn on and the module needs to be returned for service.

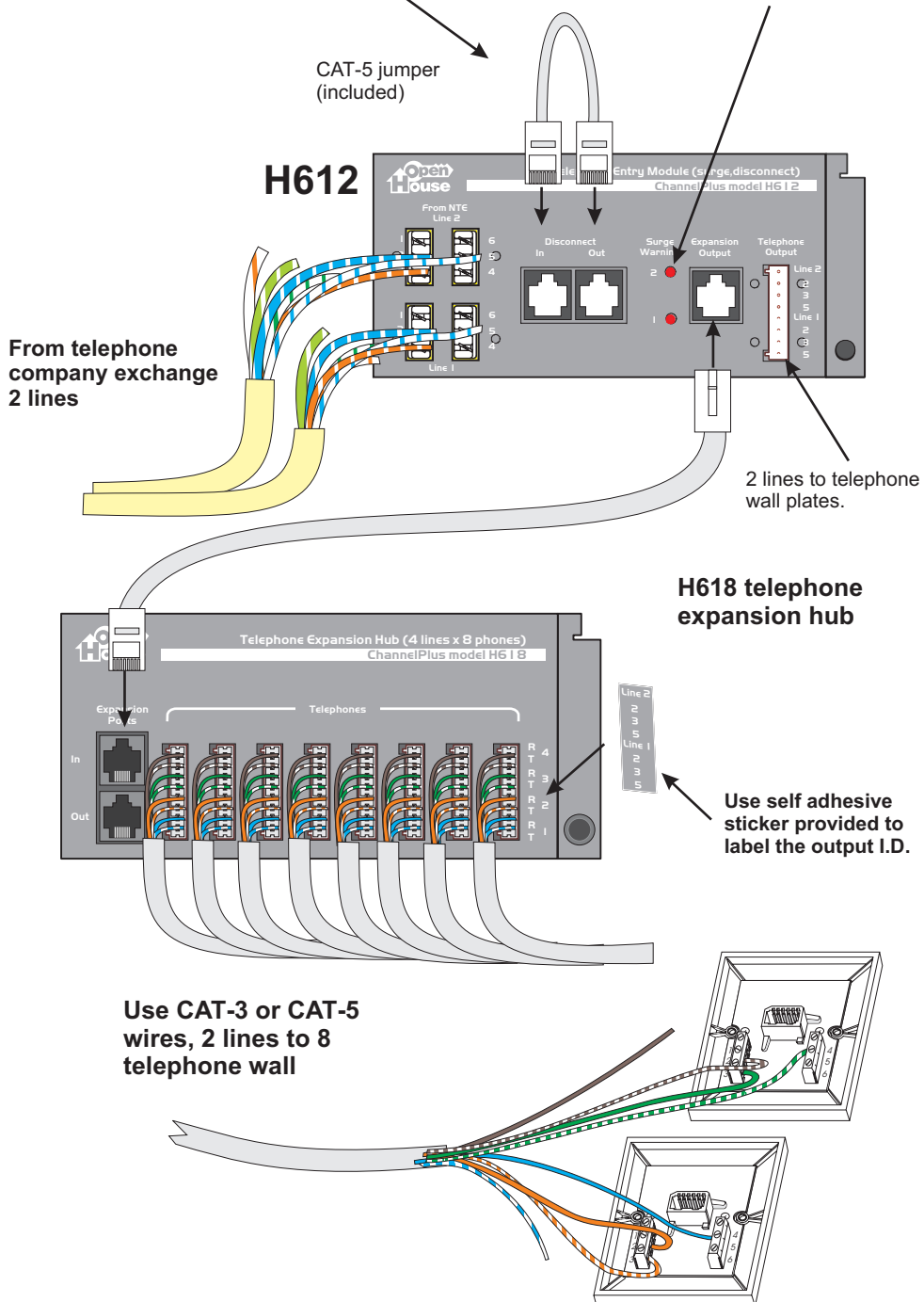

SAFETY INFORMATION:

- a) Never install telephone wiring during a lightning storm.
- b) Never install telephone jacks in wet locations.
- c) Never touch uninsulated telephone wires or terminals unless the telephone line has been disconnected at the network interface.
- d) Use caution when installing or modifying telephone lines.

OpenHouse™ modules attach from the top

- 1) Hook from the top
- 2) Swing into place
- 3) Push button to lock

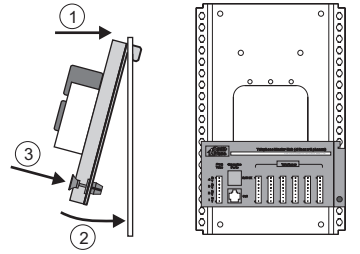

Wire Color Codes

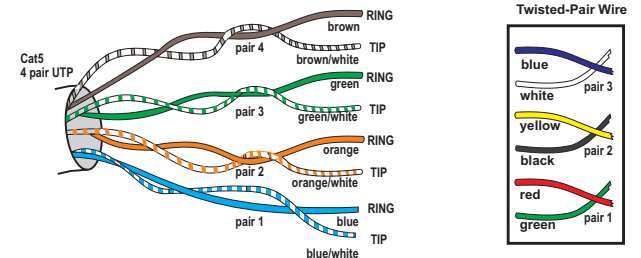

Modular connectors

6 position connectors

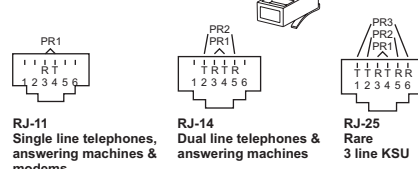

8 position connectors

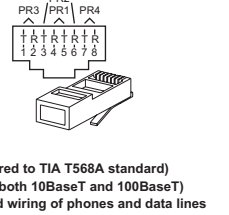

(There are other wiring standards. For residential use, we recommend that RJ-45 jacks be wired to the T568A standard.)

Wiring a 110 connector

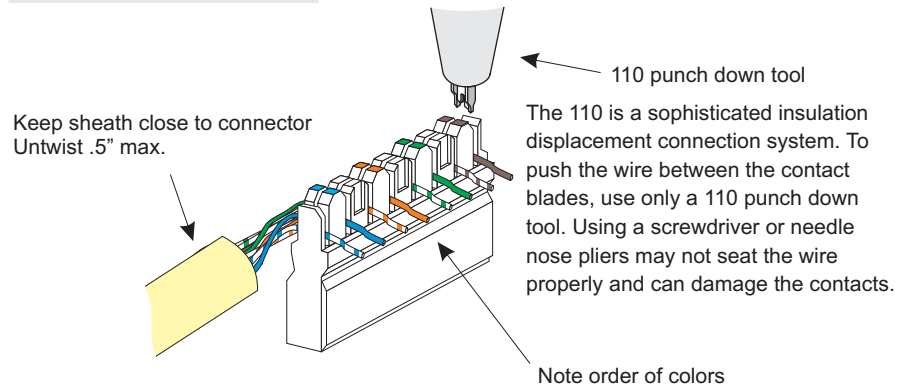

Wiring a Cat-5 jack

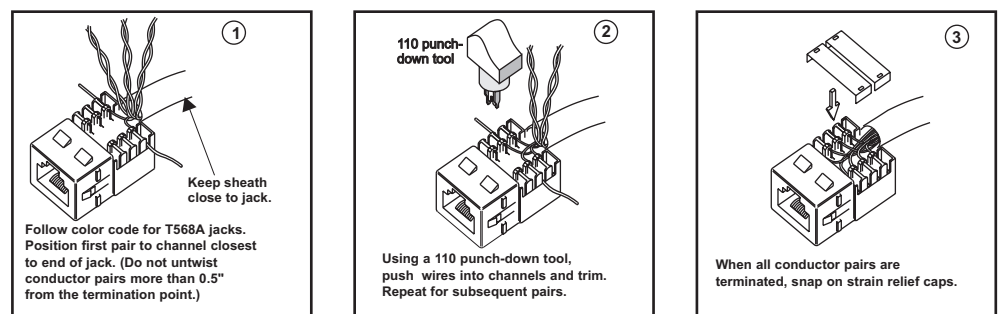

Colors of OpenHouse™ wiring

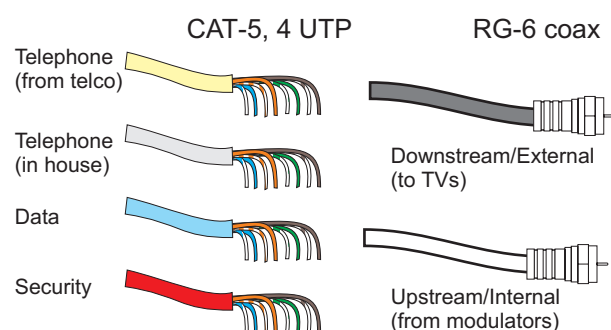

Wiring Modular Plug (T568A)

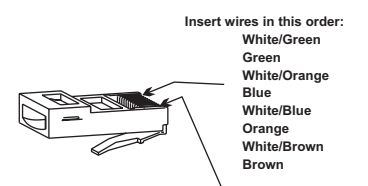



ChannelPlus Enclosures, Modules, Accessories & Wall Plates

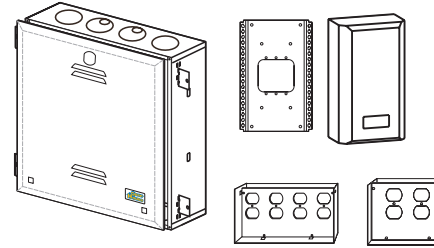

Service center enclosures

A full line of OpenHouse compatible enclosures, from simple, inexpensive mounting plates to high capacity in-wall cabinets. AC outlets can be mounted inside the cabinets using a UL listed accessory.

Starter systems

RF splitters and telephone punch downs. When it is time to upgrade, just snap this module out and replace with one of more of the more sophisticated units.

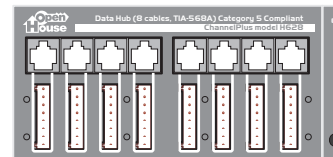
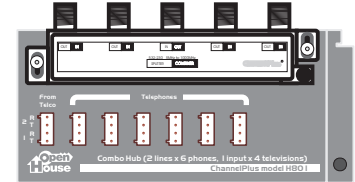

Data hubs

Termination blocks for the CAT-5 cables, Ethernet hubs. Bring the Internet to any room in the home. Or create a home data network.

Telephone hubs

Connections for 1-4 phone lines to every room. Starter hub adds RJ-31X jack for security system dialer.

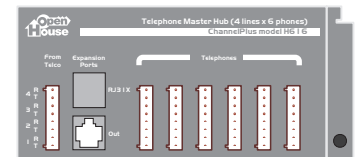

Wall plates

Wall plate systems for all rooms. The typical room gets TV and telephone. The Home office wall plate adds data ports. The media center wall plate adds satellite feeds.

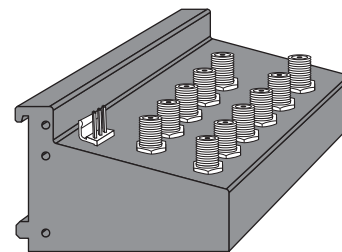

Coax panels

Distribute antenna or cable TV to every room of the house. Some models include bi-directional amplifiers for interactive cable systems. Some models include modulator inputs and IR engines.

AV modulators (for service center)

Create a new TV channel for a front door camera. Some models feature Cat-5 input connections.

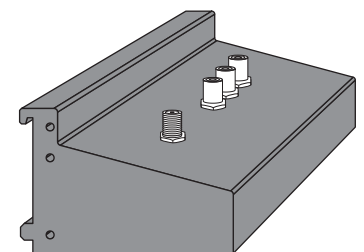

AV modulators (for media center)

Create new TV channels for DVD, VCR, or a satellite receiver. These modulators sit in the media center. Some offer true MTS stereo.

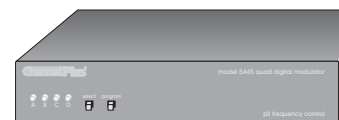

IR Accessories

Control video devices from any room.

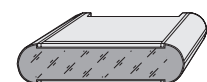

New OpenHouse products are added all the time. Visit our website to learn more: www.openhousesystems.com

- Good ...
- Typical room - phone, TV
- Media center - phone, satellite receiver, AV modulators
- Home office - phone, TV, cable modem
- Better ...
- Typical room - phone, TV, ethernet
- Media center - phone, TV, ethernet, satellite receiver, AV modulators
- Home office - phone, TV, ethernet, cable modem
- Best ...
- Typical room - phone, TV, ethernet, satellite receiver
- Media center - phone, TV, ethernet, satellite receiver, AV modulators, hi-speed data
- Home office - phone, TV, ethernet, satellite receiver, cable modem, hi-speed data

	Good	Better	Best
Typical Room	1 Cat-5 1 RG-6	2 Cat-5 1 RG-6	2 Cat-5 2 RG-6
Media Center	1 Cat-5 3 RG-6	2 Cat-5 3 RG-6	3 Cat-5 3 RG-6
Home Office	1 Cat-5 2 RG-6	2 Cat-5 2 RG-6	3 Cat-5 3 RG-6

Wiring a house for OpenHouse
The cables in an OpenHouse run from the various rooms of the house directly to the service center location. (This is known as 'home run' wiring.) Two types of wire are used for communication and entertainment: Cat-5, 4-UTP (4 Unshielded Twisted Pairs) wire handles data or 1 to 4 telephone lines. RG-6 coax handles television (antenna or cable), satellite dish, cable modem, or AV modulator signals. (An AV modulator creates new TV channels for front door camera, DVD player, a VCR or a satellite receiver.) We recommend the following pre-wire schemes. Run these wires from the service center to the rooms indicated.



www.openhousesystems.com

Warranty

Multiplex Technology, Inc. warrants this product to be free from defects in materials and workmanship for a period of one year from the date of purchase or MTI will repair, or at its option, replace the defective product. To obtain warranty service, call MTI for a return material authorization (RMA) number and return the product prepaid. Attention: Customer Service. Please put the RMA number on the outside of the carton.

Any implied warranty arising from the sale of the product including implied warranties of merchantability and fitness for purpose are limited to the warranty stated above. MTI shall not be responsible for losses or damages or expenses, whether direct, consequential or incidental arising from the use of or the inability to use this product. Some states do not allow limitations on how long the implied warranty lasts or the exclusion or limitation or incidental or consequential damages, so the above limitations and exclusions may not apply to you. This warranty gives you specific legal rights, and you may have other rights which may vary from state to state.

Free Manuals Download Website

<http://myh66.com>

<http://usermanuals.us>

<http://www.somanuals.com>

<http://www.4manuals.cc>

<http://www.manual-lib.com>

<http://www.404manual.com>

<http://www.luxmanual.com>

<http://aubethermostatmanual.com>

Golf course search by state

<http://golfingnear.com>

Email search by domain

<http://emailbydomain.com>

Auto manuals search

<http://auto.somanuals.com>

TV manuals search

<http://tv.somanuals.com>