



## **Catalyst 3560-C and 2960-C Switch Hardware Installation Guide**

March 2013

### **Americas Headquarters**

Cisco Systems, Inc.  
170 West Tasman Drive  
San Jose, CA 95134-1706  
USA  
<http://www.cisco.com>  
Tel: 408 526-4000  
800 553-NETS (6387)  
Fax: 408 527-0883

Text Part Number: OL-23803-02

THE SPECIFICATIONS AND INFORMATION REGARDING THE PRODUCTS IN THIS MANUAL ARE SUBJECT TO CHANGE WITHOUT NOTICE. ALL STATEMENTS, INFORMATION, AND RECOMMENDATIONS IN THIS MANUAL ARE BELIEVED TO BE ACCURATE BUT ARE PRESENTED WITHOUT WARRANTY OF ANY KIND, EXPRESS OR IMPLIED. USERS MUST TAKE FULL RESPONSIBILITY FOR THEIR APPLICATION OF ANY PRODUCTS.

THE SOFTWARE LICENSE AND LIMITED WARRANTY FOR THE ACCOMPANYING PRODUCT ARE SET FORTH IN THE INFORMATION PACKET THAT SHIPPED WITH THE PRODUCT AND ARE INCORPORATED HEREIN BY THIS REFERENCE. IF YOU ARE UNABLE TO LOCATE THE SOFTWARE LICENSE OR LIMITED WARRANTY, CONTACT YOUR CISCO REPRESENTATIVE FOR A COPY.

The following information is for FCC compliance of Class A devices: This equipment has been tested and found to comply with the limits for a Class A digital device, pursuant to part 15 of the FCC rules. These limits are designed to provide reasonable protection against harmful interference when the equipment is operated in a commercial environment. This equipment generates, uses, and can radiate radio-frequency energy and, if not installed and used in accordance with the instruction manual, may cause harmful interference to radio communications. Operation of this equipment in a residential area is likely to cause harmful interference, in which case users will be required to correct the interference at their own expense.

The following information is for FCC compliance of Class B devices: This equipment has been tested and found to comply with the limits for a Class B digital device, pursuant to part 15 of the FCC rules. These limits are designed to provide reasonable protection against harmful interference in a residential installation. This equipment generates, uses and can radiate radio frequency energy and, if not installed and used in accordance with the instructions, may cause harmful interference to radio communications. However, there is no guarantee that interference will not occur in a particular installation. If the equipment causes interference to radio or television reception, which can be determined by turning the equipment off and on, users are encouraged to try to correct the interference by using one or more of the following measures:

- Reorient or relocate the receiving antenna.
- Increase the separation between the equipment and receiver.
- Connect the equipment into an outlet on a circuit different from that to which the receiver is connected.
- Consult the dealer or an experienced radio/TV technician for help.

Modifications to this product not authorized by Cisco could void the FCC approval and negate your authority to operate the product.

The Cisco implementation of TCP header compression is an adaptation of a program developed by the University of California, Berkeley (UCB) as part of UCB's public domain version of the UNIX operating system. All rights reserved. Copyright © 1981, Regents of the University of California.

NOTWITHSTANDING ANY OTHER WARRANTY HEREIN, ALL DOCUMENT FILES AND SOFTWARE OF THESE SUPPLIERS ARE PROVIDED "AS IS" WITH ALL FAULTS. CISCO AND THE ABOVE-NAMED SUPPLIERS DISCLAIM ALL WARRANTIES, EXPRESSED OR IMPLIED, INCLUDING, WITHOUT LIMITATION, THOSE OF MERCHANTABILITY, FITNESS FOR A PARTICULAR PURPOSE AND NONINFRINGEMENT OR ARISING FROM A COURSE OF DEALING, USAGE, OR TRADE PRACTICE.

Cisco and the Cisco logo are trademarks or registered trademarks of Cisco and/or its affiliates in the U.S. and other countries. To view a list of Cisco trademarks, go to this URL: [www.cisco.com/go/trademarks](http://www.cisco.com/go/trademarks). Third-party trademarks mentioned are the property of their respective owners. The use of the word partner does not imply a partnership relationship between Cisco and any other company. (1110R)

Any Internet Protocol (IP) addresses used in this document are not intended to be actual addresses. Any examples, command display output, and figures included in the document are shown for illustrative purposes only. Any use of actual IP addresses in illustrative content is unintentional and coincidental.

*Catalyst 3560-C and 2960-C Switch Hardware Installation Guide*  
© 2011–2013 Cisco Systems, Inc. All rights reserved.



# CONTENTS

## **Preface**   vii

Related Publications   i-viii

Obtaining Documentation and Submitting a Service Request   i-viii

---

## **CHAPTER 1**

## **Product Overview**   1-1

Switch Models   1-1

Front Panel   1-2

    10/100 and 10/100/1000 Fast Ethernet Downlink Ports   1-5

    PoE Ports (Switches with PoE Ports)   1-5

        PoE Pass-Through   1-6

        PoE Uplink Ports (Catalyst 2960CPD-8TT-L, 2960CPD-8PT-L, and 3560CPD-8PT-S)   1-8

        PoE-Capable Downlink Ports (Catalyst 2960CPD-8PT-L, 3560CG-8PC-S, 3560CPD-8PT-S, 2960C-8PC-L, 2960C-12PC-L, 3560C-8PC-S, and 3560C-12PC-S)   1-9

    USB Type A Port   1-9

    Dual-Purpose Ports   1-9

        SFP Modules   1-9

    Management Ports   1-11

    LEDs   1-12

        Switch Panel LEDs   1-12

        System LED   1-13

        Console LEDs   1-13

        Modes for Port LEDs   1-14

        Port LEDs   1-14

        PoE LED   1-15

        PD LED   1-15

        Dual-Purpose Port LEDs   1-15

Rear Panel   1-16

    Internal Power Supply   1-17

    Auxiliary Power Adapter   1-17

    Security Slots   1-18

    Reset Button   1-18

Management Options   1-18

Network Configurations   1-19

**CHAPTER 2**

**Switch Installation 2-1**

- Preparing for Installation 2-1
  - Warnings 2-1
  - Installation Guidelines 2-3
  - Equipment That You Supply 2-4
  - Box Contents 2-4
- Powering the Switch 2-4
- Verifying Switch Operation 2-5
- Mounting the Switch 2-5
  - On a Desk or Shelf (without Mounting Screws) 2-6
  - Desk, Shelf, or Wall (with Mounting Screws) 2-6
    - Desk- or Shelf-Mounting 2-6
    - Under the Desk- or Shelf-Mounting 2-8
    - Wall-Mounting 2-10
  - With a Mounting Tray 2-13
    - Mounting Tray with Screws 2-13
    - Mounting Tray with a Magnet 2-15
  - In a Rack 2-18
    - Attaching Brackets to the Switch 2-18
    - Mounting the Switch in a Rack 2-19
  - On a DIN Rail 2-20
    - Attaching the DIN-Mount Tray to the Switch 2-20
    - Mounting the Switch on a DIN Rail 2-21
    - Removing the Switch from a DIN Rail 2-23
- Installing a Cover for the Reset Button (Optional) 2-24
- Installing the Power Cord Retainer (Optional) 2-25
- Installing the Cable Guard (Optional) 2-28
- After Installing the Switch 2-31
- Installing SFP Modules 2-31
- Removing SFP Modules 2-32
- Connecting Devices to the Ethernet Ports 2-33
  - Connecting to the 10/100 and 10/100/1000 Ports 2-33
  - Connecting to the PoE Ports 2-34
- Where to Go Next 2-35

**CHAPTER 3**

**Troubleshooting 3-1**

- Diagnosing Problems 3-1
  - Switch POST Results 3-1

Switch LEDs	3-2
Switch Connections	3-2
Bad or Damaged Cable	3-2
Ethernet and Fiber-Optic Cables	3-2
Link Status	3-2
10/100 and 10/100/1000 Port Connections	3-3
10/100 PoE or PoE+ Port Connections	3-3
SFP Module	3-3
Interface Settings	3-3
Ping End Device	3-3
Spanning Tree Loops	3-4
Switch Performance	3-4
Speed, Duplex, and Autonegotiation	3-4
Autonegotiation and Network Interface Cards	3-4
Cabling Distance	3-4
Resetting the Switch	3-5
Finding the Switch Serial Number	3-5

**APPENDIX A****Technical Specifications** A-1**APPENDIX B****Connector and Cable Specifications** B-1

Connector Specifications	B-1
10/100 and 10/100/1000 Ports	B-1
SFP Module Connectors	B-2
Dual-Purpose Ports	B-2
Cables and Adapters	B-3
SFP Module Cables	B-3
Cable Pinouts	B-4
Console Port Adapter Pinouts	B-5

**APPENDIX C****Configuring the Switch with the CLI Setup Program** C-1

Accessing the CLI Through the Console Port	C-1
RJ-45 Console Port	C-1
USB Mini-Type B Console Port	C-3
Installing the Cisco Microsoft Windows USB Device Drivers	C-4
Installing the Cisco Microsoft Windows XP USB Driver	C-4
Installing the Cisco Microsoft Windows 2000 USB Driver	C-5
Installing the Cisco Microsoft Windows Vista and Windows 7 USB Driver	C-5
Uninstalling the Cisco Microsoft Windows USB Drivers	C-6

Uninstalling the Cisco Microsoft Windows XP and 2000 USB Driver **C-6**  
Uninstalling the Cisco Microsoft Windows Vista and Windows 7 USB Driver **C-6**  
Entering the Initial Configuration Information **C-7**  
    IP Settings **C-7**  
    Completing the Setup Program **C-7**



## Preface

---

This guide describes the hardware features of the Catalyst 3560-C and 2960-C switches. It describes the physical and performance characteristics of the switch, explains how to install it, and provides troubleshooting information.

This guide does not describe system messages that you might receive or how to configure your switch. See the switch software configuration guide, the switch command reference, and the switch system message guide on Cisco.com.



---

**Note**

Means *reader take note*. Notes contain helpful suggestions or references to materials not contained in this manual.

---



---

**Caution**

Means *reader be careful*. In this situation, you might do something that could result in equipment damage or loss of data.

---



---

**Warning**

---

**IMPORTANT SAFETY INSTRUCTIONS**

**This warning symbol means danger. You are in a situation that could cause bodily injury. Before you work on any equipment, be aware of the hazards involved with electrical circuitry and be familiar with standard practices for preventing accidents. Use the statement number provided at the end of each warning to locate its translation in the translated safety warnings that accompanied this device.** Statement 1071

---

**SAVE THESE INSTRUCTIONS**

---

The safety warnings for this product are translated into several languages in the *Regulatory Compliance and Safety Information for the Catalyst 3560-C and 2960-C Switches* that is available on Cisco.com. The EMC regulatory statements are also included in that guide.

## Related Publications

[http://www.cisco.com/go/cat3560c\\_docs](http://www.cisco.com/go/cat3560c_docs)

[http://www.cisco.com/go/cat2960c\\_docs](http://www.cisco.com/go/cat2960c_docs)




---

**Note** Before installing, configuring, or upgrading the switch, see the release notes on Cisco.com for the latest information.

---

- *Release Notes for the Catalyst 3560-C Switch*
- *Release Notes for the Catalyst 2960-C Switch*
- *Catalyst 3560-C and 2960-C Switch Getting Started Guide*
- *Regulatory Compliance and Safety Information for the Catalyst 3560-C and 2960-C Switches*
- *Catalyst 2960 and 2960-S Switch Software Configuration Guide*
- *Catalyst 2960 and 2960-S Switch Command Reference*
- *Catalyst 3560 Switch Software Configuration Guide*
- *Catalyst 3560 Switch Command Reference*
- *Catalyst 3750, 3560, 3550, 2975, 2970, 2960, and 2960-S Switch System Message Guide*

For other information about related products, see these documents:

- *Smart Install Configuration Guide*
- *Auto Smartports Configuration Guide*
- *Cisco EnergyWise Configuration Guide*

Cisco SFP module documents:

[http://www.cisco.com/en/US/products/hw/modules/ps5455/prod\\_installation\\_guides\\_list.html](http://www.cisco.com/en/US/products/hw/modules/ps5455/prod_installation_guides_list.html)

SFP module compatibility matrix documents:

[http://www.cisco.com/en/US/products/hw/modules/ps5455/products\\_device\\_support\\_tables\\_list.html](http://www.cisco.com/en/US/products/hw/modules/ps5455/products_device_support_tables_list.html)

## Obtaining Documentation and Submitting a Service Request

For information on obtaining documentation, submitting a service request, and gathering additional information, see the monthly *What's New in Cisco Product Documentation*, which also lists all new and revised Cisco technical documentation, at:

<http://www.cisco.com/en/US/docs/general/whatsnew/whatsnew.html>

Subscribe to the *What's New in Cisco Product Documentation* as a Really Simple Syndication (RSS) feed and set content to be delivered directly to your desktop using a reader application. The RSS feeds are a free service and Cisco currently supports RSS version 2.0.





# CHAPTER 1

## Product Overview

The Catalyst 3560-C and 2960-C of switches, also referred to as the *switch*, are Ethernet switches to which you can connect devices such as Cisco IP Phones, Cisco Wireless Access Points, workstations, and other network devices such as servers, routers, and other switches.

You can deploy these switches outside of the traditional wiring closet environment, such as in office workspaces, hotel rooms, slot machines, kiosks, and classrooms. The switch is suitable for deployments where there are space and power constraints (access to power outlets).

See the switch software configuration guide for deployment examples.

- [Switch Models, page 1-1](#)
- [Front Panel, page 1-2](#)
- [Rear Panel, page 1-16](#)
- [Management Options, page 1-18](#)

## Switch Models

**Table 1-1**      **Switch Model Descriptions**

Switch Model	Description
Catalyst 2960CPD-8TT-L	8 10/100 Ethernet ports and 2 10/100/1000BASE-T PD uplink copper ports.
Catalyst 2960CPD-8PT-L	8 10/100 PoE <sup>1</sup> ports and 2 10/100/1000BASE-T PD uplink copper ports.
Catalyst 2960CG-8TC-L	8 10/100/1000 Ethernet ports and 2 dual-purpose ports (1 10/100/1000BASE-T copper port and 1 SFP <sup>2</sup> module slot).
Catalyst 2960C-8TC-L	8 10/100 Ethernet ports and 2 dual-purpose ports.
Catalyst 2960C-8TC-S	8 10/100 Ethernet ports and 2 dual-purpose ports.
Catalyst 2960C-8PC-L	8 10/100 PoE ports and 2 dual-purpose ports.
Catalyst 2960C-12PC-L	12 10/100 PoE ports and 2 dual-purpose ports.
Catalyst 3560CG-8PC-S	8 10/100/1000 PoE+ ports and 2 dual-purpose ports.
Catalyst 3560CG-8TC-S	8 10/100/1000 Ethernet ports and 2 dual-purpose ports.
Catalyst 3560CPD-8PT-S	8 10/100/1000 PoE ports and 2 10/100/1000BASE-T PD uplink copper ports.

**Table 1-1** Switch Model Descriptions (continued)

Switch Model	Description
Catalyst 3560C-8PC-S	8 10/100 PoE+ ports and 2 dual-purpose ports.
Catalyst 3560C-12PC-S	12 10/100 PoE+ ports and 2 dual-purpose ports.

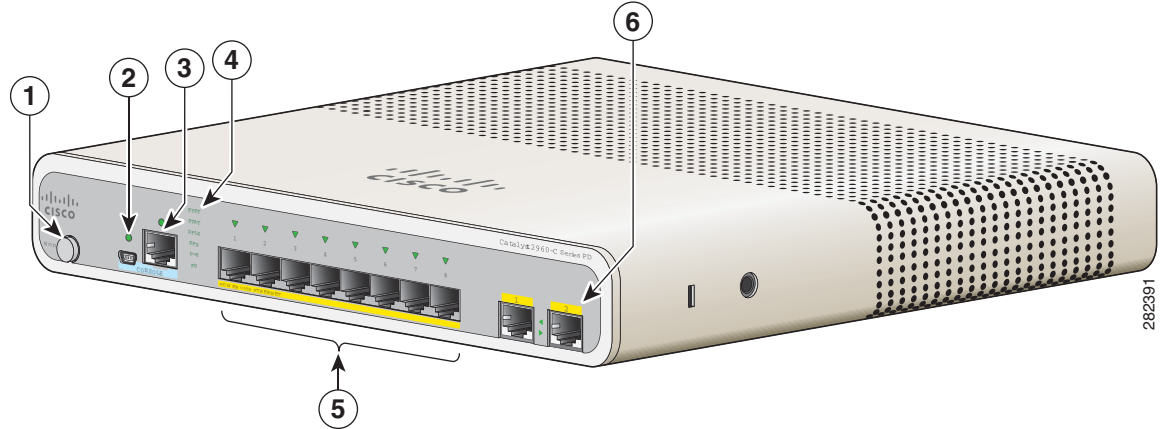
1. PoE = Power over Ethernet
2. SFP = small form-factor pluggable

## Front Panel

- 8 or 12 downlink Ethernet ports of one of these types:
  - 10/100
  - 10/100/1000
  - 10/100 PoE
  - 10/100 PoE+
  - 10/100/1000 PoE
  - 10/100/1000 PoE+
- Two 10/100/1000 uplink ports or two dual purpose ports
- RJ-45 console port
- USB mini-Type B (console) port
- USB Type A port (available on the Catalyst 3560CPD-8PT-S, 2960CG-8TC-L, 3560CG-8PC-S, and 3560CG-8TC-S switches)
- LEDs

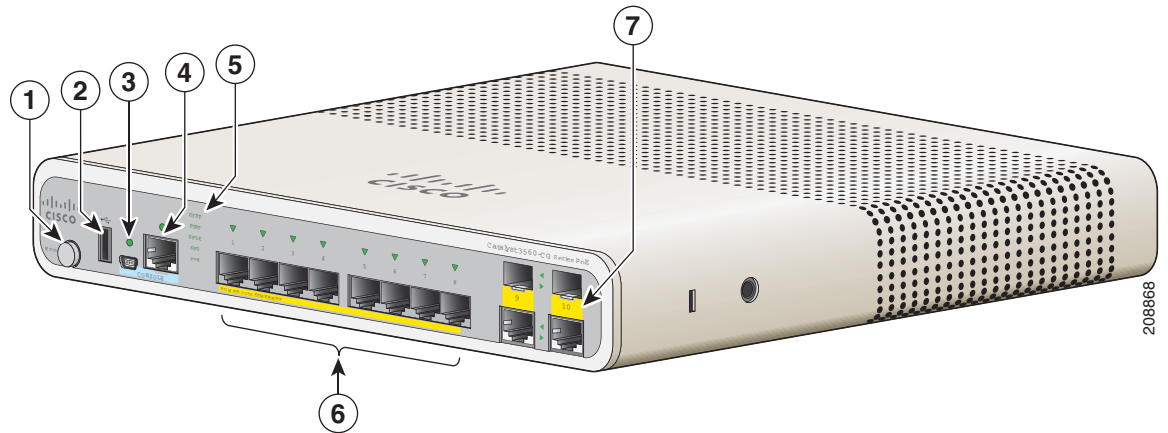
All the 8-port and 12-port switches have similar components. See [Figure 1-1](#), [Figure 1-2](#), [Figure 1-3](#), [Figure 1-4](#), and [Figure 1-5](#) for examples.

Figure 1-1 Catalyst 2960CPD-8PT-L Front Panel View



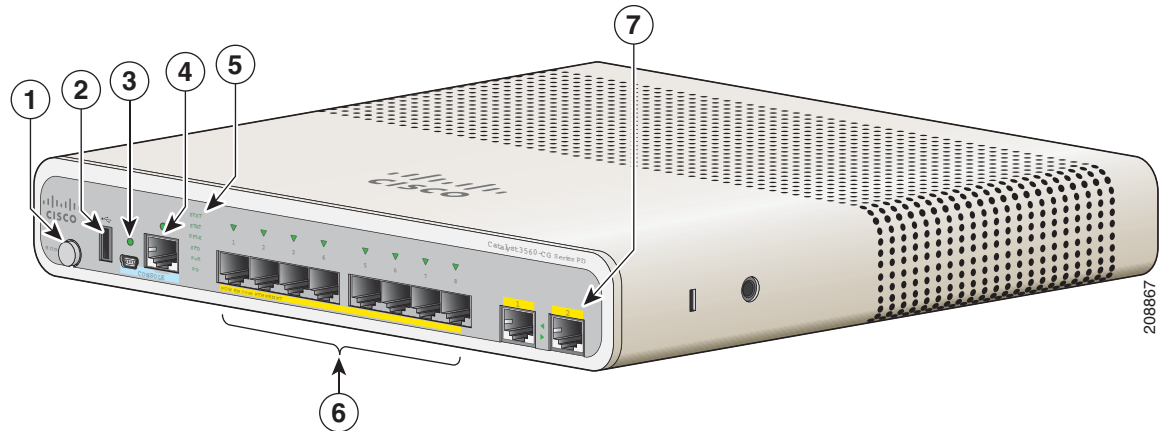
1	Mode button	4	LEDs
2	USB mini-Type B (console) port	5	10/100 PoE ports
3	RJ-45 console port	6	10/100/1000 uplink ports

Figure 1-2 Catalyst 3560CG-8PC-S Front Panel View



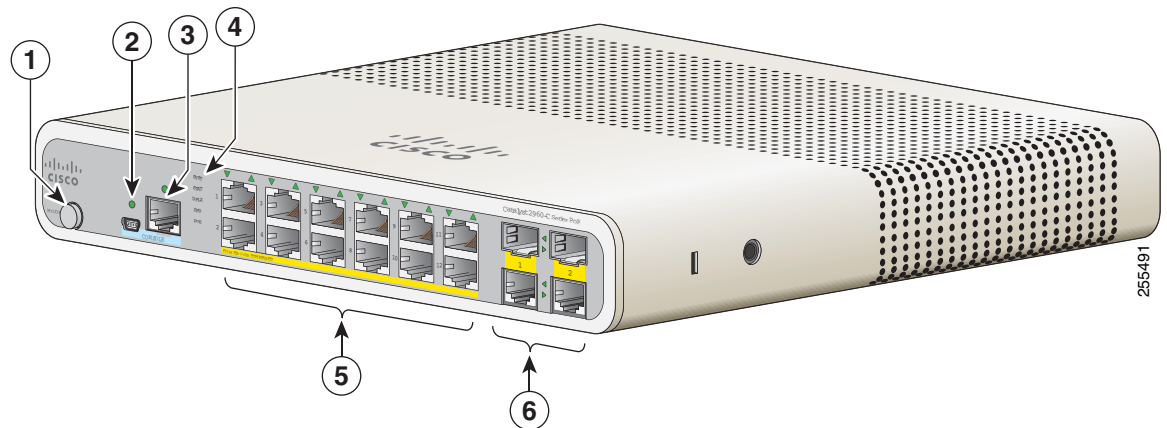
1	Mode button	5	LEDs
2	USB Type A port	6	10/100/1000 PoE+ ports
3	USB mini-Type B (console) port	7	Dual-purpose ports
4	RJ-45 console port		

Figure 1-3 Catalyst 3560CPD-8PT-S Front Panel View



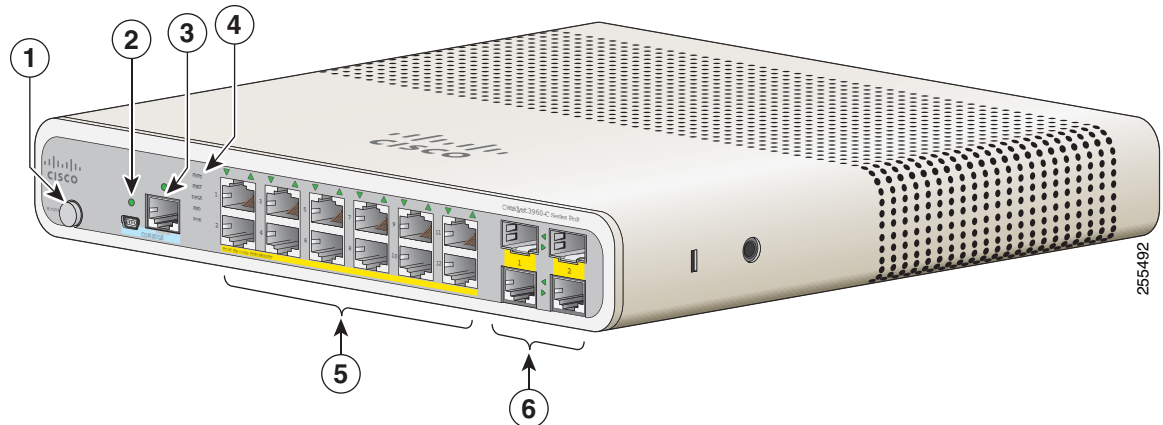
1	Mode button	5	LEDs
2	USB Type A port	6	10/100/1000 PoE ports
3	USB mini-Type B (console) port	7	10/100/1000 uplink ports
4	RJ-45 console port		

Figure 1-4 Catalyst 2960C-12PC-L Front Panel View



1	Mode button	4	LEDs
2	USB mini-Type B (console) port	5	10/100 PoE ports
3	RJ-45 console port	6	Dual-purpose ports

Figure 1-5 Catalyst 3560C-12PC-S Front Panel View



1	Mode button	4	LEDs
2	USB mini-Type B (console) port	5	10/100 PoE ports
3	RJ-45 console port	6	Dual-purpose ports

## 10/100 and 10/100/1000 Fast Ethernet Downlink Ports

You can set the 10/100 ports to operate at 10 or 100 Mb/s in full-duplex or half-duplex mode. You can set the 10/100/1000 ports to operate at 10, 100, or 1000 Mb/s in full-duplex or half-duplex mode. You can also set these ports for speed and duplex autonegotiation. (The default setting is autonegotiate.)

Automatic medium-dependent interface crossover (auto-MDIX) is a feature that allows the switch interface to detect the required cable connection type (straight-through or crossover) and automatically configure the connection appropriately. With auto-MDIX enabled, you can use either a straight-through or crossover type cable to connect to the other device, and the interface automatically corrects for any incorrect cabling. In all cases, the attached device must be within 328 feet (100 meters)

The 10/100/1000 ports use RJ-45 connectors with Ethernet pinouts. The maximum cable length is 328 feet (100 meters). The 100BASE-TX and 1000BASE-T traffic requires Category 5, Category 5e, or Category 6 unshielded twisted pair (UTP) cable. The 10BASE-T traffic can use Category 3 or Category 4 UTP cable.

For information about port connections and port specifications, see the [“Connecting to the 10/100 and 10/100/1000 Ports”](#) section on page 2-33.

## PoE Ports (Switches with PoE Ports)

The PoE and PoE+ ports provide PoE support for devices compliant with 802.3af and 802.3at and also provide Cisco prestandard PoE and PoE+ support for Cisco IP Phones and Cisco Aironet Access Points.

All 8 downlink ports on the Catalyst 2960CPD-8PT-L, 2960C-8PC-L, 2960C-12-PC-L, and the 3560CPD-8PT-S and are PoE-capable. Each port can supply 15.4 W of PoE per port.

The maximum switch power output for the Catalyst 2960CPD-8PT-L is 22.4 W, and for the Catalyst 3560CPD-8PT-S is 15.4 W. The maximum switch power output for the Catalyst 2960C-8PC-L and the 2960C-12-PC-L is 123.2 W.

All 8 or 12 downlink ports on the Catalyst, 3560CG-8PC-S, 3560C-8PC-S, and 3560C-12PC-S switches are PoE+ capable. The maximum switch power output is 123.2 W. You can budget the PoE and PoE+:

- 15.4 W of PoE output on eight ports
- 30 W of PoE+ on four ports

On a per-port basis, you control whether or not a port automatically provides power when an IP phone or an access point is connected.

The 10/100/1000 PoE ports use RJ-45 connectors with Ethernet pinouts. The maximum cable length is 328 feet (100 meters). The 100BASE-TX and 1000BASE-T traffic requires Category 5, Category 5e, or Category 6 unshielded twisted pair (UTP) cable. The 10BASE-T traffic can use Category 3 or Category 4 UTP cable.

Cisco intelligent power management capabilities include enhanced power negotiation, power reservation, and per-port power policing. For information about configuring and monitoring PoE ports, see the switch software configuration guide on Cisco.com.

For information about port connections and port specifications, see the [“Connecting to the 10/100 and 10/100/1000 Ports”](#) section on page 2-33.

**Note**

---

The output of the PoE circuit has been evaluated as a Limited Power Source (LPS) per IEC 60950-1.

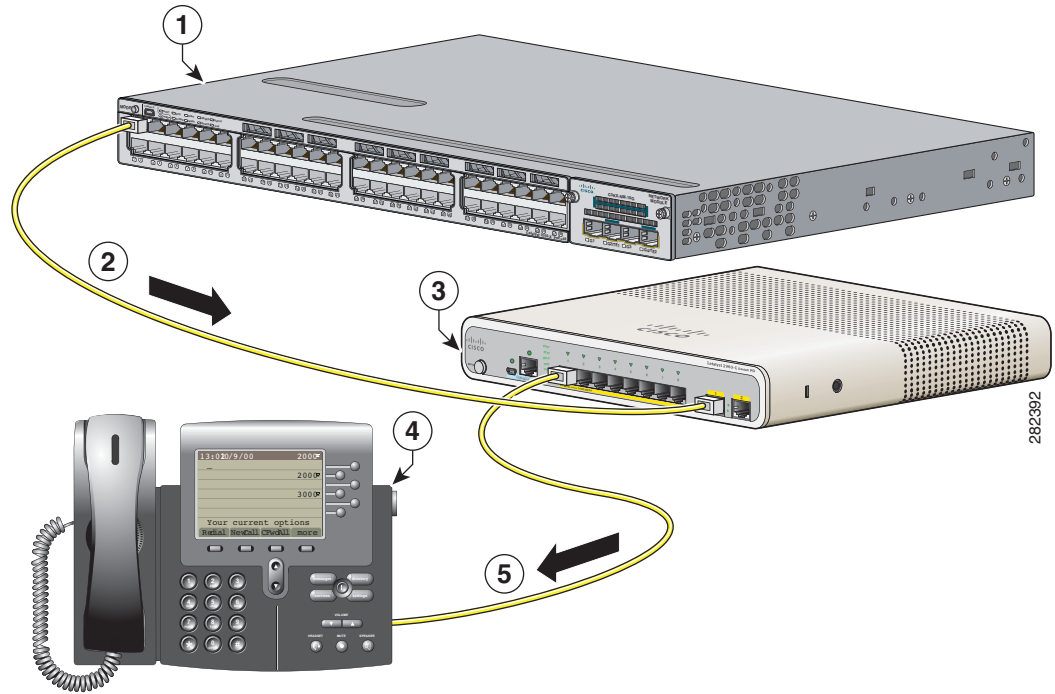
---

## PoE Pass-Through

The Catalyst 2960CPD-8PT-L and 3560CPD-8PT-S switches provide PoE pass-through. The Catalyst 2960CPD-8PT-L is powered either through the 10/100/1000 PoE uplink ports receiving power from a PoE or PoE+ switch or through an auxiliary power adapter. The Catalyst 3560CPD-8PT-S is powered through the 10/100/1000 PoE uplink ports receiving power from a PoE+ switch or through an auxiliary power adapter. If the switch has surplus power (see [Table 1-2](#)), it can power other PoE-capable devices such as IP phones, access points, and so on. See [Figure 1-6](#).

See the [“Powering the Switch”](#) section on page 2-4 for information on powering the switches.

**Figure 1-6 PoE Pass-Through**



1	PoE or PoE+ uplink switch (Catalyst 3750-X shown as an example.)	4	Catalyst 2960-C providing power through its downlink port to the IP phone.
2	Catalyst 2960-C switch receiving power from the PoE+ switch	5	IP phone receiving power from the PoE downlink port
3	Catalyst 2960-C switch		

The available switch PoE budget depends upon the PoE sent from the uplink switch. See [Table 1-2](#).

**Table 1-2 PoE Budgeting for the Catalyst 2960CPD-8PT-L**

Powering Options on the Uplink Ports	Power Sent from Uplink Switches	Available PoE budget
1 PoE uplink	15.4 W	–
2 PoE uplinks	30.8 W	7 W
1 PoE+ uplink	30 W	7 W
2 PoE+ uplinks	60 W	22.4 W
1 PoE and 1 PoE+ uplink	45.4 W	15.4 W
1 Cisco UPOE uplink	60 W	30.8 W <sup>1</sup>
2 Cisco UPOE uplinks	120 W	30.8 W <sup>1</sup>
Auxiliary power input	–	22.4 W (30.8 <sup>2</sup> )

1. The second UPOE uplink is a backup.
2. When the Auxiliary AC input is used as a backup to a Cisco UPOE powered switch.

**Table 1-3 PoE Budgeting for the Catalyst 3560CPD-8PT-S Switch**

Powering Options on the Uplink Ports	Power Sent from Uplink Switches	Available PoE budget
1 PoE+ uplink	30 W	–
2 PoE+ uplinks	60 W	15.4 W
1 Cisco UPOE uplink	60 W	23.8 W <sup>1</sup>
2 Cisco UPOE uplinks	120 W	23.8 W <sup>1</sup>
Auxiliary power input	–	15.4 W (23.8 W <sup>2</sup> )

1. The second UPOE uplink is a backup.
2. When the Auxiliary AC input is used as a backup to a Cisco UPOE powered switch.

## PoE Uplink Ports (Catalyst 2960CPD-8TT-L, 2960CPD-8PT-L, and 3560CPD-8PT-S)

The 10/100/1000 PoE uplink ports on the Catalyst 2960CPD-8TT-L and 2960CPD-8PT-L can receive power from a PoE or PoE+ switch. The 10/100/1000 PoE uplink ports on the Catalyst 3560CPD-8PT-S can receive power from a PoE+ switch. You can connect each of the uplink ports to different PoE switches or to the same PoE switch. See [Figure 1-6](#).



**Note** You can also use an external auxiliary power adapter that connects to the rear of the switch. You can order it from your Cisco representative. See the [“Auxiliary Power Adapter”](#) section on [page 1-17](#) for information.



## PoE-Capable Downlink Ports (Catalyst 2960CPD-8PT-L, 3560CG-8PC-S, 3560CPD-8PT-S, 2960C-8PC-L, 2960C-12PC-L, 3560C-8PC-S, and 3560C-12PC-S)

Depending upon the available PoE budget, these switches can power other PoE-capable devices such as IP phones, access points, and so on. See [Table 1-2](#) for PoE budgeting information. See [Figure 1-6](#).

For information on powering the switches, see the “[Powering the Switch](#)” section on [page 2-4](#).

## USB Type A Port

Some models have an USB Type A port. This port provides access to external Cisco USB flash devices (also known as thumb drives or USB keys). The port supports Cisco USB flash drives with capacities from 64 MB to 1 GB.

Cisco IOS software provides standard file system access to the flash device: read, write, erase, and copy, as well as the capability to format the flash device with a FAT file system.

For more information about the switch management ports, see the switch software configuration guide and the command reference on Cisco.com.

## Dual-Purpose Ports

You can configure the dual-purpose ports on the switch as either 10/100/1000 ports or as SFP-module ports. You can set the 10/100/1000 ports to autonegotiate, or you can configure them as fixed 10, 100, or 1000 Mb/s (Gigabit) Ethernet ports.

By default, the switch selects the medium for each dual-purpose port (10/100/1000BASE-T or SFP). When a link is achieved on one media type, the switch disables the other media type until the active link goes down. If links are active on both media, the SFP-module port has priority, but you can use the **media-type** interface configuration command to manually designate the port as an RJ-45 port or an SFP port.

You can configure the speed and duplex settings consistent with the selected media type. For information on configuring interfaces, see the switch software configuration guide.

## SFP Modules

The switch Ethernet SFP modules provide connections to other devices. These field-replaceable transceiver modules provide the uplink interfaces. The modules have LC connectors for fiber-optic connections or RJ-45 connectors for copper connections.

You can use any combination of these supported SFP modules:

- GLC-LH-SM=
- GLC-SX-MM=
- GLC-ZX-SM=
- GLC-BX-D=
- GLC-BX-U=
- GLC-FE-100FX=
- GLC-FE-100LX=
- GLC-FE-100BX-D=

- GLC-FE-100BX-U=
- CWDM SFPs

For information about SFP modules, see your SFP module documentation and the [“Installing SFP Modules” section on page 2-31](#). For cable specifications, see the [“SFP Module Cables” section on page B-3](#).

## Management Ports

You can connect the switch to a PC running Microsoft Windows or to a terminal server through either the RJ-45 console port or the USB mini-Type B console port, also referred to as the *USB-mini console port*.

- RJ-45 console port. The RJ-45 connection uses an RJ-45-to-DB-9 female cable.
- USB-mini console port (5-pin connector). The USB connection uses a USB Type A-to-5-pin mini-Type B cable.

The USB-mini console interface speeds are the same as the RJ-45 console interface speeds.

To use the USB-mini console port, you must install the Cisco Windows USB device driver on the device that is connected to the USB-mini console port and that is running Microsoft Windows.



### Note

For information about downloading the Cisco USB device driver, see the [“Installing the Cisco Microsoft Windows USB Device Drivers” section on page C-4](#).

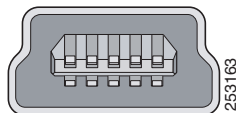
With the Cisco Windows USB device driver, connecting and disconnecting the USB cable from the console port does not affect Windows HyperTerminal operations. Mac OS X or Linux require no special drivers.



### Note

The 5-pin mini-Type B connectors resemble the 4-pin mini-Type B connectors. They are not compatible. Use only the 5-pin mini-Type B. See [Figure 1-7](#).

**Figure 1-7**      **USB Mini-Type B Port**



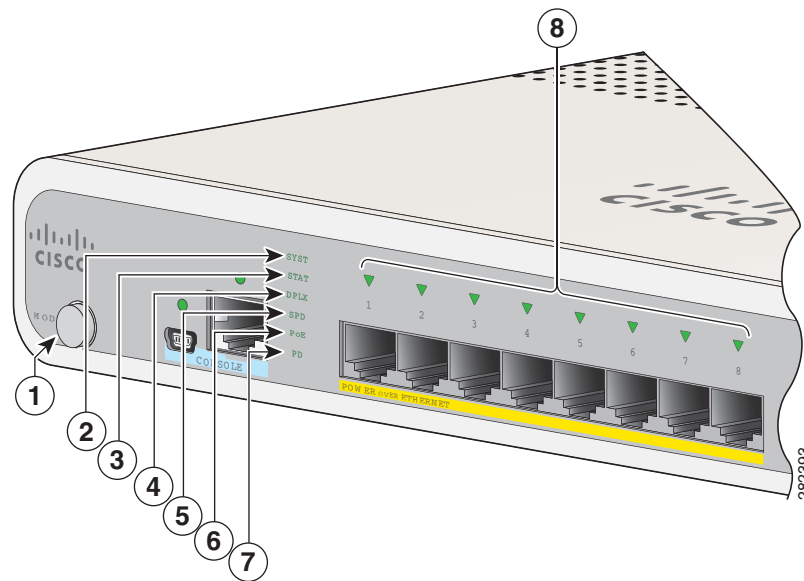
The configurable inactivity timeout reactivates the RJ-45 console port if the USB-mini console port is activated, but no input activity occurs for a specified time period. When the USB-mini console port deactivates due to a timeout, you can restore its operation by disconnecting and reconnecting the USB cable. For information on using the CLI to configure the USB-mini console interface, see the switch software guide.

## LEDs

You can use the switch system and port LEDs to monitor switch activity and performance.

### Switch Panel LEDs

**Figure 1-8** Switch LEDs



<b>1</b>	Mode button	<b>5</b>	SPD LED (speed)
<b>2</b>	SYST LED (system)	<b>6</b>	PoE LED <sup>1</sup>
<b>3</b>	STAT LED (status)	<b>7</b>	PD LED <sup>2</sup> (powered device)
<b>4</b>	DPLX LED (duplex)	<b>8</b>	Port LEDs

1. Applicable to switches with PoE ports.
2. Only the Catalyst 2960CPD-8PT-L and 3560PD-8PT-S switches have the PD LED.

## System LED

**Table 1-4 System LED**

Color	System Status
Off	System is not powered on.
Green	System is operating normally.
Amber	System is receiving power but is not operating properly.

## Console LEDs

The console LEDs show which console port is in use. See [Figure 1-1](#) and [Figure 1-2](#) for the LED locations.

If you connect a cable to a console port, the switch automatically uses that port for console communication. If you connect two console cables, the USB-mini console port has priority.

**Table 1-5 RJ-45 and USB-Mini Console Port LEDs**

LED	Color	Description
RJ-45 console port	Green	RJ-45 console port is active. USB-mini console port LED is not active.
	Off	Port is not active. USB-mini console port is active.
USB-mini console port	Green	USB-mini console port is active. RJ-45 console port LED is not active.
	Off	Port is not active. RJ-45 console port is active.

## Modes for Port LEDs

The port LEDs, as a group or individually, display information about the switch and about the individual ports (Table 1-5).

**Table 1-6 Modes for Port LEDs**

LED	Port Mode	Description
STAT	Port status	The port status. This is the default mode.
DUPLX	Port duplex status	The port duplex mode: full duplex or half duplex.
SPD	Port speed	The port operating speed: 10, 100, or 1000 Mb/s.
PD <sup>1</sup>	Powered device	The status of the uplink port.
PoE	PoE port power	The PoE status.

1. Only the Catalyst 2960CPD-8PT-L and 3560PD-8PT-S switches have the PD LED.

## Port LEDs

RJ-45 ports and SFP-module slots have port LEDs. These LEDs, as a group or individually, provide information about the switch and about the individual ports.

**Table 1-7 Meaning of Port LED Colors**

LED Color	Meaning
Off	No link or port was administratively shut down.
Green	Link present but is not sending or receiving data.
Blinking green	Activity. Port is sending or receiving data.
Alternating green-amber	Link fault. Error frames can affect connectivity, and errors such as excessive collisions, CRC errors, and alignment and jabber errors are monitored for link faults.
Amber	Port is blocked by Spanning Tree Protocol (STP) and is not forwarding data. After a port is reconfigured, the port LED is amber for up to 30 seconds as STP searches for loops.

## PoE LED

Even if the PoE mode is not selected, the LED shows PoE problems when they are detected (Table 1-8). The PoE LED is only on the switches that support PoE.

**Table 1-8 PoE LED**

Color	Meaning
Off	PoE is not enabled.
Green	PoE is enabled. Ports are functioning correctly.
Blinking amber	<ul style="list-style-type: none"> <li>• PoE mode is not selected.</li> <li>• At least one of the 10/100 or 10/100/100 PoE ports has been denied power.</li> <li>or</li> <li>• At least one of the ports has a PoE fault.</li> </ul>

## PD LED

Applies only to the Catalyst 2960CPD-8PT-L and 3560PD-8PT-S switches. (Table 1-9).

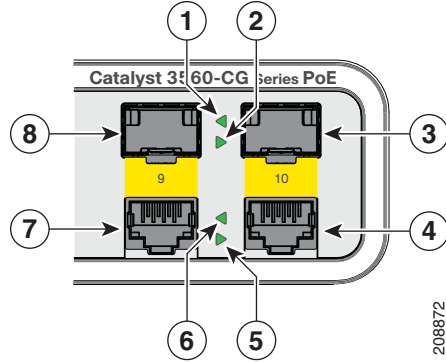
**Table 1-9 PD LED**

Color	Meaning
Off	Switch is not powered up.
Blinking amber	Switch is receiving power from a PoE device, but it is insufficient to power up the switch.
Amber	Switch is powered by only the auxiliary power adapter.
Amber/green	Switch is powered by the auxiliary power but is also receiving power from a PoE device.
Green	Switch is powered by a PoE switch through a PoE uplink port.

## Dual-Purpose Port LEDs

The dual-purpose port LEDs identify the connection as either a copper-based connector or an SFP module. The ports can autonegotiate, or you can manually configure each dual-purpose port as either 10/100/1000 with copper connectors or as an SFP-module port, but not as both types at the same time. See Table 1-7 for LED descriptions.

Figure 1-9 Dual-Purpose LEDs

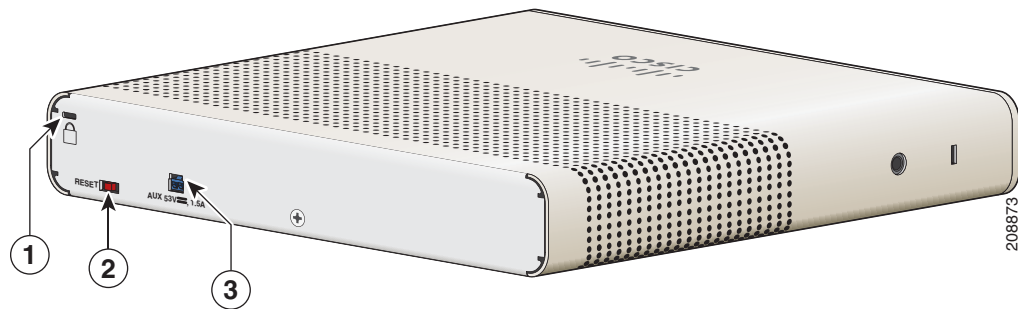


1	SFP module port LED	5	RJ-45 port LED
2	SFP module port LED	6	RJ-45 port LED
3	SFP module slot	7	RJ-45 connector
4	RJ-45 connector	8	SFP module slot

## Rear Panel

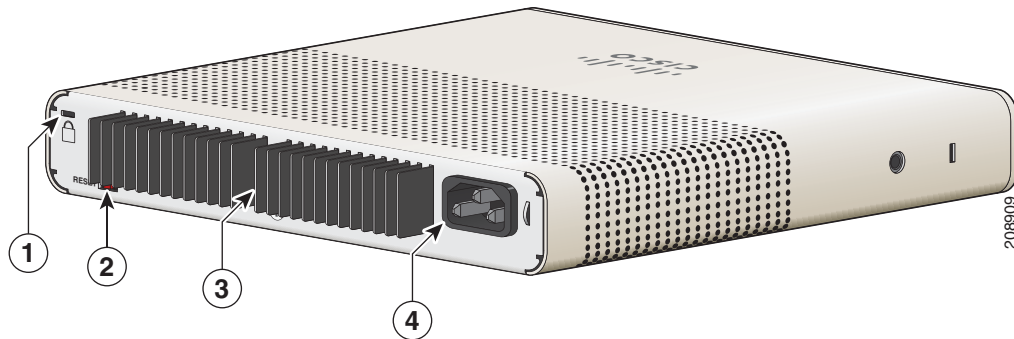
- A reset button
- A security slot
- An AC power connector or a power adapter connector
- Heat sink fins (Catalyst 3560CG-8PC-S, 2960C-8PC-L, 2960C-12PC-L, 3560C-8PC-S, and 3560C-12PC-S switches)

Figure 1-10 Catalyst 2960CPD-8PT-L Switch Rear Panel



1	Security slot	3	Power adapter connector
2	Reset button		

Figure 1-11 Catalyst 3560CG-8PC-S Switch Rear Panel



1	Security slot	3	Heat sink fins
2	Reset button	4	AC power connector

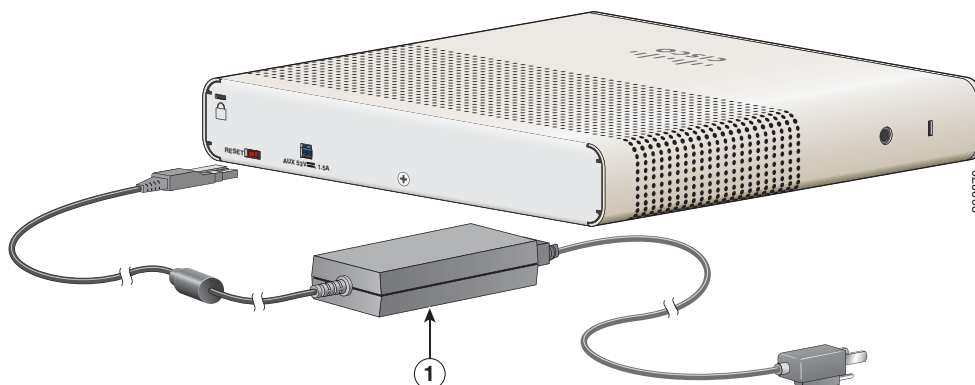
## Internal Power Supply

All switches except the Catalyst 2960CPD-8TT-L, 2960CPD-8PT-L, and 3560CPD-8PT-S are powered through their internal power supplies. The internal power supply is an autoranging unit that supports input voltages between 100 and 240 VAC. Plug the AC power cord into the AC power connector and into an AC power outlet.

## Auxiliary Power Adapter

The Catalyst 2960CPD-8TT-L, 2960CPD-8PT-L, and 3560CPD-8PT-S switches do not have an internal power supply. You can power the switch through either the 10/100/1000 uplink ports or through an auxiliary power adapter. You can order the auxiliary power adapter (PWR-ADPT) with the switch, or you can order it (PWR-ADPT=) later from your Cisco representative.

Figure 1-12 Connecting Through an External Auxiliary Power Adapter



1	Auxiliary power adapter
---	-------------------------

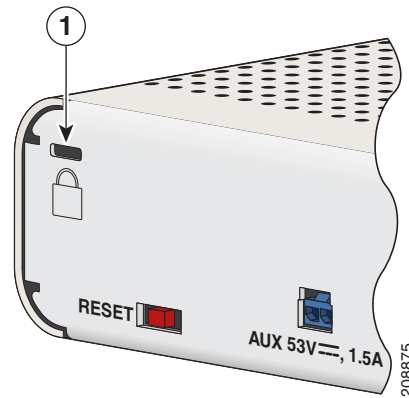


## Security Slots

The switches have security slots on the rear panel. You can install an optional cable lock, such as the type that is used to secure a laptop computer, to secure the switch.

Figure 1-13 shows the slot on a rear panel.

**Figure 1-13** Switch Left Panel



1	Security slot
---	---------------

## Reset Button

You can use press the reset button to power-cycle the switch. See Figure 1-13.

## Management Options

- Cisco Network Assistant

Network Assistant is a PC-based network management GUI with centralized management of Cisco LAN switches, core switches, routers, access points, IP phones, and PIX firewalls.

Network Assistant is available at no cost and can be downloaded from this URL:

[http://www.cisco.com/en/US/products/ps5931/tsd\\_products\\_support\\_series\\_home.html](http://www.cisco.com/en/US/products/ps5931/tsd_products_support_series_home.html)

For information on starting Network Assistant, see the *Getting Started with Cisco Network Assistant* guide on Cisco.com. See the switch release notes for information on CNA support.

- Device manager

You can use the device manager, which is in the switch memory, to manage individual and standalone switches. Device manager is a web interface that offers quick configuration and monitoring. You can access the device manager from anywhere in your network through a web browser. For more information, see the device manager online help.

- Cisco IOS CLI

The switch CLI is based on Cisco IOS software and supports desktop-switching features. You can configure and monitor the switch and switch cluster members from the CLI. You can access the CLI either by connecting your management station directly to the switch console port or by using Telnet from a remote management station. See the switch command reference on Cisco.com for more information.

For setup instructions that use the CLI, go to [Appendix C, “Configuring the Switch with the CLI Setup Program.”](#)

- CiscoView application

The CiscoView device-management application displays the switch image that you can use to set configuration parameters and to view switch status and performance information. The CiscoView application, which you purchase separately, can be a standalone application or part of a Simple Network Management Protocol (SNMP) platform. See the CiscoView documentation for more information.

- SNMP network management

You can use SNMP management applications such as CiscoWorks LAN Management Solution (LMS) and HP OpenView to configure and manage the switch. You also can manage it from an SNMP-compatible workstation that is running platforms such as HP OpenView or SunNet Manager.

The Cisco Configuration Engine is a network management device that works with embedded CNS agents in the switch software. You can use the Cisco Configuration Engine to automate initial configurations and configuration updates on the switch.

## Network Configurations

See the switch software configuration guide on Cisco.com for an explanation of network configuration concepts. The software configuration guide also provides network configuration examples for creating dedicated network segments that are interconnected through Ethernet connections.



## CHAPTER 2

# Switch Installation

---

This chapter describes how to start your switch and how to interpret the power-on self-test (POST) that ensures proper operation. It also describes how to install the switch.

Read the topics and perform the procedures in this order:

- [Preparing for Installation, page 2-1](#)
- [Verifying Switch Operation, page 2-5](#)
- [Mounting the Switch, page 2-5](#)
- [Installing a Cover for the Reset Button \(Optional\), page 2-24](#)
- [Installing the Power Cord Retainer \(Optional\), page 2-25](#)
- [Installing the Cable Guard \(Optional\), page 2-28](#)
- [Connecting Devices to the Ethernet Ports, page 2-33](#)

## Preparing for Installation

- [Warnings, page 2-1](#)
- [Installation Guidelines, page 2-3](#)
- [Equipment That You Supply, page 2-4](#)
- [Box Contents, page 2-4](#)
- [Powering the Switch, page 2-4](#)

## Warnings

These warnings are translated into several languages in the *Regulatory Compliance and Safety Information for the Catalyst 3560-C and the 2960-C Switches* guide.



Warning

---

**Before working on equipment that is connected to power lines, remove jewelry (including rings, necklaces, and watches). Metal objects will heat up when connected to power and ground and can cause serious burns or weld the metal object to the terminals.** Statement 43

---

**Warning**

**Read the wall-mounting instructions carefully before beginning installation. Failure to use the correct hardware or to follow the correct procedures could result in a hazardous situation to people and damage to the system.** Statement 378

**Warning**

**Do not work on the system or connect or disconnect cables during periods of lightning activity.** Statement 1001

**Warning**

**Read the installation instructions before connecting the system to the power source.** Statement 1004

**Warning**

**This product relies on the building's installation for short-circuit (overcurrent) protection. Ensure that the protective device is rated not greater than: 20 A** Statement 1005

**Warning**

**To prevent bodily injury when mounting or servicing this unit in a rack, you must take special precautions to ensure that the system remains stable. The following guidelines are provided to ensure your safety:**

- **This unit should be mounted at the bottom of the rack if it is the only unit in the rack.**
- **When mounting this unit in a partially filled rack, load the rack from the bottom to the top with the heaviest component at the bottom of the rack.**
- **If the rack is provided with stabilizing devices, install the stabilizers before mounting or servicing the unit in the rack.** Statement 1006

**Warning**

**Class 1 laser product.** Statement 1008

**Warning**

**This equipment must be grounded. Never defeat the ground conductor or operate the equipment in the absence of a suitably installed ground conductor. Contact the appropriate electrical inspection authority or an electrician if you are uncertain that suitable grounding is available.** Statement 1024

**Warning**

**Ultimate disposal of this product should be handled according to all national laws and regulations.** Statement 1040

**Warning**

**For connections outside the building where the equipment is installed, the following ports must be connected through an approved network termination unit with integral circuit protection: 10/100/1000 Ethernet.** Statement 1044

**Warning**

**To prevent the system from overheating, do not operate it in an area that exceeds the maximum recommended ambient temperature of: 113°F (45°C)**  
Statement 1047

**Note**

For Catalyst 3560CG-8PC-S, 3560CG-8TC-S, and 2960CG-8TC-L switches, the maximum recommended ambient temperature is: 104°F (40°C).

**Warning**

**No user-serviceable parts inside. Do not open.** Statement 1073

**Warning**

**Installation of the equipment must comply with local and national electrical codes.** Statement 1074

**Warning**

**To prevent airflow restriction, allow clearance around the ventilation openings to be at least: 3 in. (7.6 cm)** Statement 1076

**Warning**

**Hot surface.** Statement 1079

**Note**

Applies to the Catalyst 3560CG-8PC-S switch.

## Installation Guidelines

Before installing the switch, these guidelines must be met:

- The operating environment must be within the ranges listed in [Appendix A, “Technical Specifications.”](#)
- Cabling is away from sources of electrical noise, such as radios, power lines, and fluorescent lighting fixtures. Make sure that the cabling is away from other devices that might damage the cables.
- Airflow around the switch and through the vents must be unrestricted. We strongly recommend that you allow at least 3 in. (7.6 cm) of clearance from the left, right, and top sides of the switch to avoid any flow blockage. If you are installing the switch in a rack, allow at least 1.75 in. (4 cm) of empty rack space above each switch.
- Catalyst 3560CG-8PC-S, 2960C-8PC-L, 2960C-12PC-L, 3560C-8PC-S, and 3560C-12PC-S switches: Allow at least 1.75 in. (4 cm) clearance from the ends of the external heat sink fins.

- Temperature around the unit does not exceed 113°F (45°C).  
If the switch is installed in a closed environment or in a multirack assembly, the temperature around it might be greater than normal room temperature.
- Humidity around the switch must not exceed 95 percent.
- Altitude at the installation site must not be greater than 10,000 feet (3,049 meters).
- Do not place any items on the top of the switch.
- Do not wall-mount the switch with its front panel facing up. Following safety regulations, wall-mount the switch with its front panel facing down or to the side to prevent airflow restriction and to provide easier access to the cables.
- Clearance to the switch front and rear panels meets these conditions:
  - You can easily read the front-panel LEDs.
  - Access to ports is sufficient for unrestricted cabling.
  - The AC power cord can reach from the AC power outlet to the connector on the switch rear panel.
- For 10/100 and 10/100/1000 fixed ports, cable lengths from the switch to connected devices are not more than 328 feet (100 meters).
- For cable lengths for small form-factor pluggable (SFP)-module connections, see the [“SFP Module Connectors” section on page B-2](#) and the module documentation.

## Equipment That You Supply

You might need this equipment to install the switch:

- Number-2 Phillips screwdriver
- Drill with a #27 drill bit (0.144-inch [3.7 mm])

## Box Contents

The switch getting started guide on Cisco.com describes the box contents. If any item is missing or damaged, contact your Cisco representative or reseller for support.

## Powering the Switch

Before installing the switch in a rack, on a desk, a shelf, or a wall, you should power on the switch and verify that it passes POST.

Power the switch:

Catalyst 2960CPD-8PT-L and 2960CPD-8TT-L

- Connect a 10/100/1000 uplink port to a PoE or PoE+ switch, such as a Catalyst 3750-X.  
Or
- Plug the auxiliary power adapter cord into the switch AUX power connector and into an AC power outlet.



---

**Note** You can use both the uplink port and the auxiliary power adapter. However, the auxiliary power input takes precedence.

---

Catalyst 3560CPD-8PT-S

- Connect a 10/100/1000 uplink port to a PoE+ switch, such as a Catalyst 3750-X.
- Or
- Plug the auxiliary power adapter cord into the switch AUX power connector and into an AC power outlet.



---

**Note** You can use both the uplink port and the auxiliary power adapter. However, the auxiliary power input takes precedence.

---

All models (except the Catalyst 2960CPD-8PT-L, 2960CPD-8TT-L, and 3560CPD-8PT-S)

- Plug the AC power cord to the switch AC power connector and into an AC power outlet.

## Verifying Switch Operation

As the switch powers on, it begins the POST, a series of tests that runs automatically to ensure that the switch functions properly. LEDs blink during the test, which lasts approximately 1 minute. When the switch begins POST, the System, Status, Duplex, and Speed LEDs turn green. The System LED blinks green, and the other LEDs remain green.

When the POST completes successfully, the System LED turns green. The other LEDs turn off and then reflect the switch operating status. If a switch fails POST, the System LED turns amber.

POST failures are usually fatal. Call Cisco technical support representative if your switch fails POST.

After a successful POST, unplug the power cord from the switch. Mount the switch in a rack on a desk or shelf, under a desk or shelf, or on a wall, as described in the [“Mounting the Switch” section on page 2-5](#).

## Mounting the Switch

- [On a Desk or Shelf \(without Mounting Screws\)](#)
- [Desk, Shelf, or Wall \(with Mounting Screws\)](#)
- [With a Mounting Tray](#)
- [In a Rack](#)
- [On a DIN Rail](#)

## On a Desk or Shelf (without Mounting Screws)

- Step 1** Locate the adhesive strip with the rubber feet in the accessory kit.
- Step 2** Remove the four rubber feet from the adhesive strip, and attach them to the recessed areas on the bottom of the unit. This prevents the switch from sliding on the desk or shelf.



**Note** We strongly recommend that you attach the rubber feet. Doing so helps prevent airflow restriction and overheating.

- Step 3** Place the switch on the desk or shelf.



**Warning**

**To prevent airflow restriction, allow clearance around the ventilation openings to be at least: 3 in. (7.6 cm)** Statement 1076

After you mount the switch, see the [“After Installing the Switch”](#) section on page 2-31 for information about the switch configuration.

## Desk, Shelf, or Wall (with Mounting Screws)

You can use the mounting screws to mount the switch:

- On a desk or a shelf
- Under a desk or a shelf
- On a wall

### Desk- or Shelf-Mounting

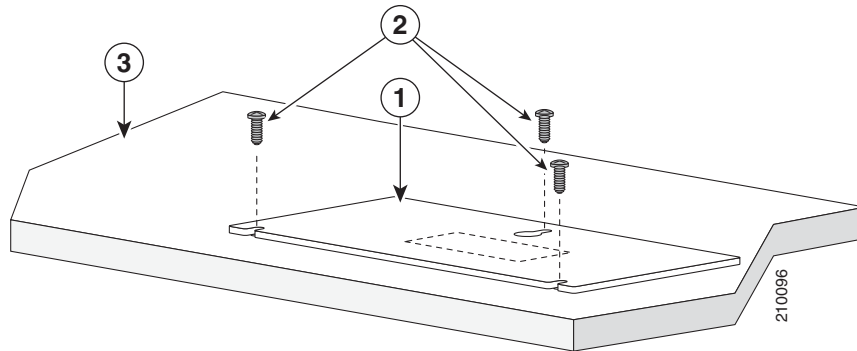
- Step 1** Use the screw template to align the mounting screw holes and also as a guide to make sure that you install the screws into the desk or shelf with proper clearance.
- Step 2** Position the screw template on top of the desk or shelf so that the two side-by-side slots face the *front* of the desk or shelf, as shown in [Figure 2-1](#). This ensures that the power cord faces the *rear* of the desk or shelf after the switch is installed.



**Note** Wait before you attach the screw template to the desk or shelf.



**Figure 2-1** Installing the Mounting Screws on Top of a Desk or a Shelf



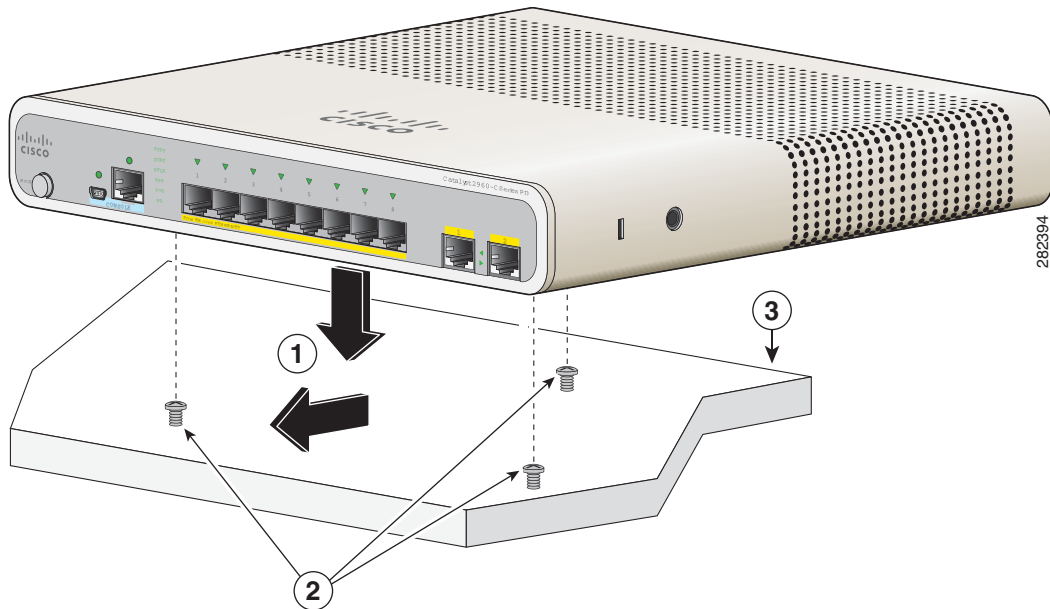
<b>1</b>	Screw template	<b>3</b>	Desk or shelf
<b>2</b>	Screws		

- Step 3** Peel the adhesive strip off the bottom of the screw template, and attach it to the top of the desk or shelf.
- Step 4** Use a 0.144-inch (3.7 mm) or a #27 drill bit to drill a 1/2-inch (12.7 mm) hole in the three screw template slots.
- Step 5** Insert three screws in the slots on the screw template, and tighten them until they touch the top of the screw template.
- Step 6** Remove the screw template from the desk or shelf.
- Step 7** Place the switch onto the mounting screws, and slide it forward until it locks in place. See [Figure 2-2](#).

  
**Warning**

**To prevent airflow restriction, allow clearance around the ventilation openings to be at least: 3 in. (7.6 cm)** Statement 1076

**Figure 2-2** Mounting the Switch on Top of a Desk or Shelf



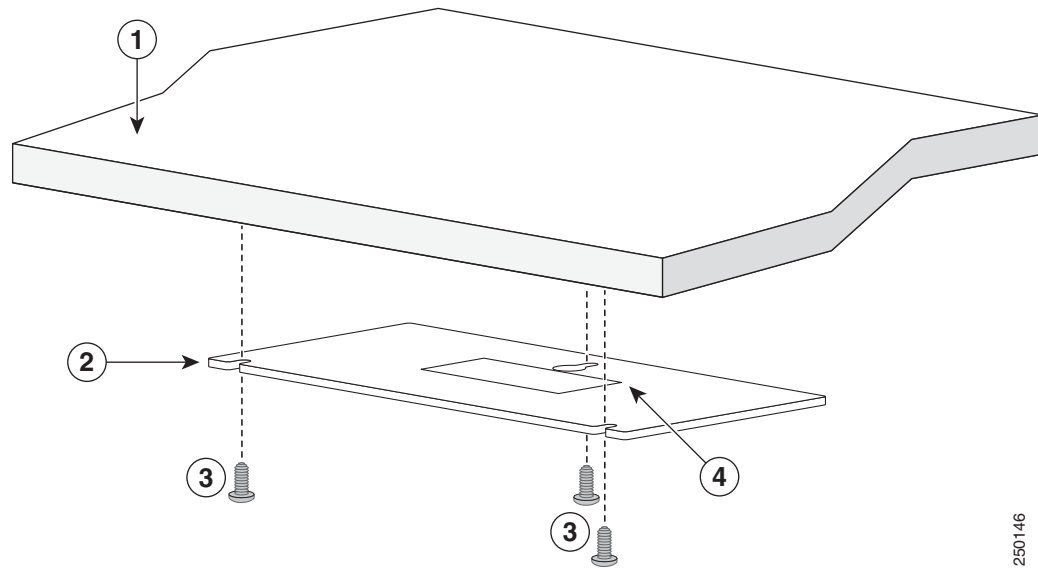
<b>1</b>	Slides on this way	<b>3</b>	Desk or shelf
<b>2</b>	Screws		

After you mount the switch, see the “[After Installing the Switch](#)” section on page 2-31 for information about configuring the switch.

## Under the Desk- or Shelf-Mounting

- Step 1** Use the screw template to align the mounting screw holes and also as a guide to make sure the screws are installed under the desk or shelf with proper clearance.
- Step 2** Position the screw template underneath the desk or shelf so that the two side-by-side slots face the *front* of the desk or shelf, as shown in [Figure 2-3](#). This ensures that the power cord faces the *rear* of the desk or shelf after the switch is mounted.
- Step 3** Peel the adhesive strip off the bottom of the screw template, and attach it to the underside of the desk or shelf.

**Figure 2-3** *Installing the Mounting Screws Under a Desk or Shelf*



250146

<b>1</b>	Desk or shelf	<b>3</b>	Screws
<b>2</b>	Screw template	<b>4</b>	Adhesive

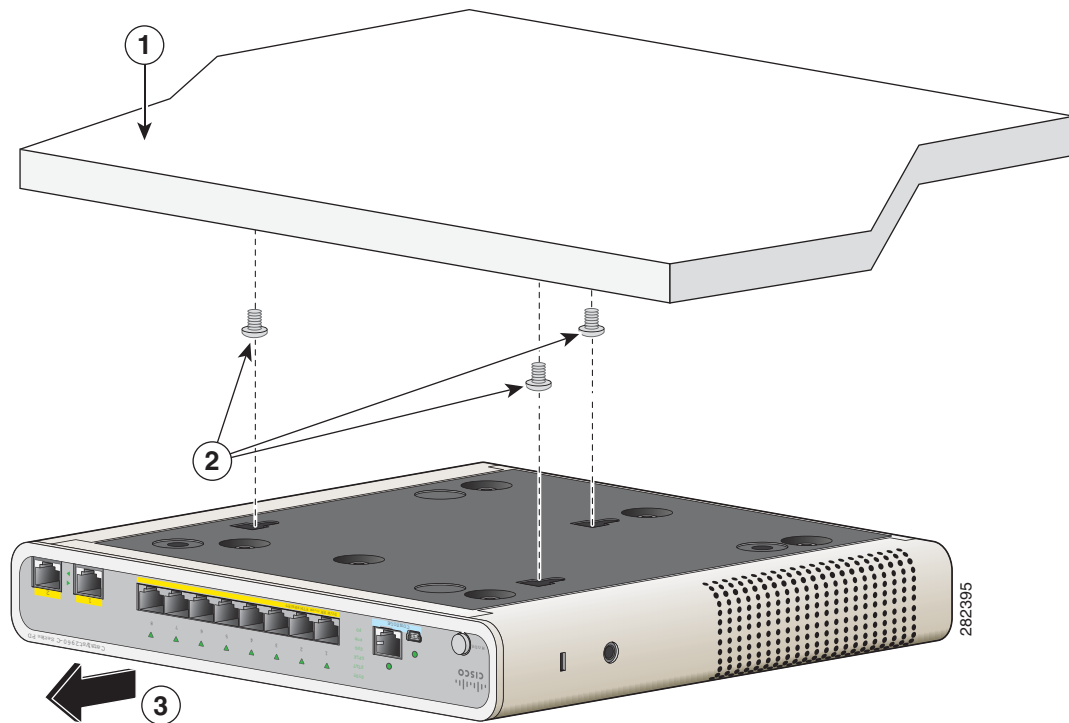
- Step 4** Use a 0.144-inch (3.7 mm) or a #27 drill bit to drill a 1/2-inch (12.7 mm) hole in the three screw template slots.
- Step 5** Insert three screws in the slots on the screw template, and tighten until they touch the top of the screw template.
- Step 6** Remove the screw template from underneath the desk or shelf.
- Step 7** Place the switch upside down onto the mounting screws, and slide it forward until it locks in place. See [Figure 2-4](#).



**Warning**

**To prevent airflow restriction, allow clearance around the ventilation openings to be at least: 3 in. (7.6 cm)** Statement 1076

Figure 2-4 Mounting the Switch Under a Desk or Shelf



1	Desk or shelf	3	Slides on this way
2	Screws		

After you mount the switch, see the “[After Installing the Switch](#)” section on page 2-31 for information about configuring the switch.

## Wall-Mounting



### Warning

**Read the wall-mounting instructions carefully before beginning installation. Failure to use the correct hardware or to follow the correct procedures could result in a hazardous situation to people and damage to the system.** Statement 378



### Caution

Do not wall-mount the switch with its front panel facing up. Following safety regulations, wall-mount the switch with its front panel facing down or to the side to prevent airflow restriction and to provide easier access to the cables.

**Step 1** Locate the screw template. The template is used to align the mounting screw holes.



**Note** Figure 2-5 shows the measurements for the location of the screws on the switch.

**Step 2** Position the screw template so that the two side-by-side slots face toward the floor, as shown in Figure 2-6.

For the best support of the switch and cables, make sure that you attach the switch securely to a wall stud or to a firmly attached plywood mounting backboard.

**Step 3** Peel the adhesive strip off the bottom of the screw template.

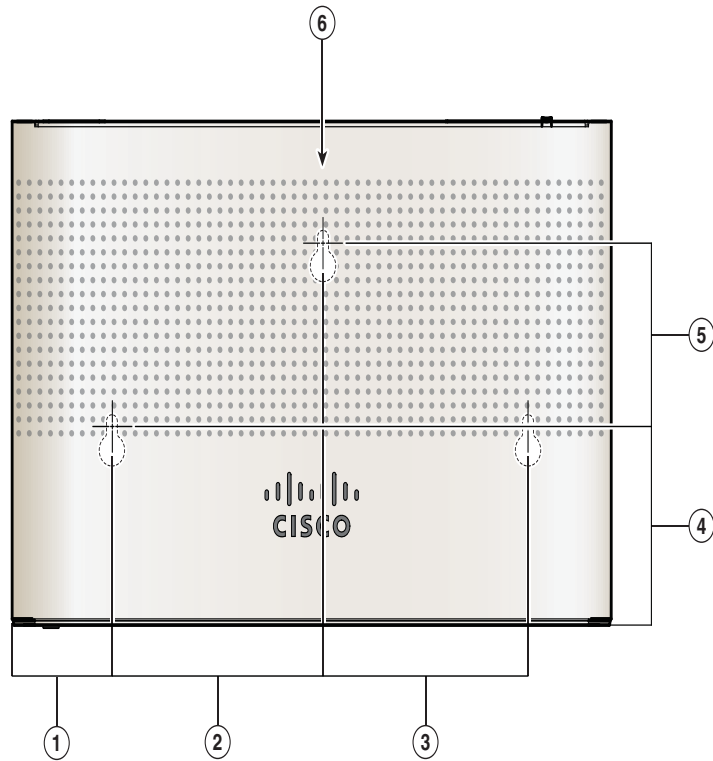
**Step 4** Attach the screw template to the wall.

**Step 5** Use a 0.144-inch (3.7 mm) or a #27 drill bit to drill a 1/2-inch (12.7 mm) hole in the three screw template slots.

**Step 6** Insert three screws in the slots on the screw template, and tighten until they touch the top of the screw template.

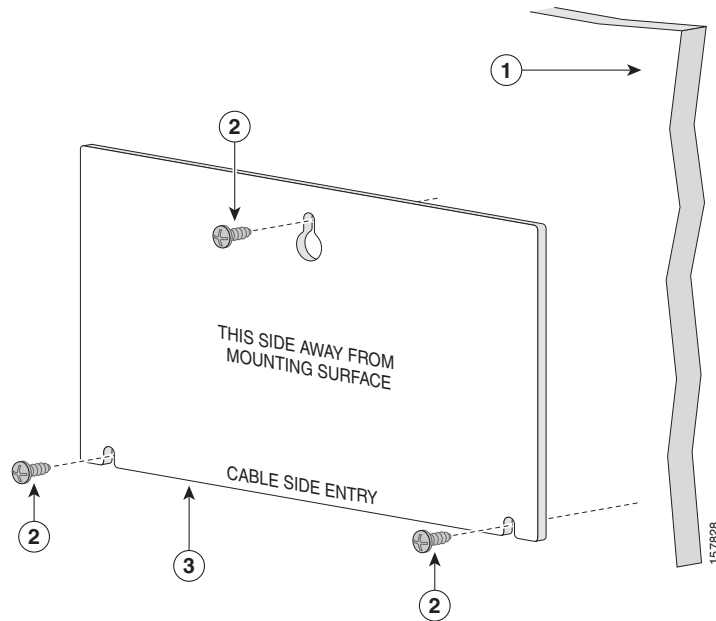
**Step 7** Remove the screw template from the wall.

**Figure 2-5** Location of the Mounting Holes on the Switch

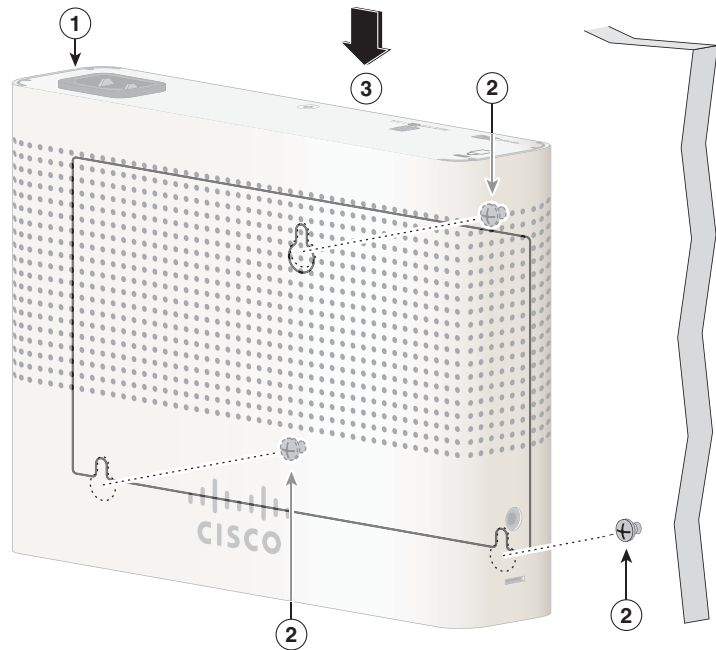


<b>1</b>	1.77 in. (4.49 cm)	<b>4</b>	2.67 in. (6.78)
<b>2</b>	3.72 in. (9.44 cm)	<b>5</b>	2.46 in. (6.24)
<b>3</b>	3.62 in. (9.19 cm)	<b>6</b>	Switch

**Figure 2-6** Installing the Mounting Screws on the Wall



**Figure 2-7** Installing the Switch on a Wall



**Step 8** Place the switch onto the mounting screws, and slide it down until it locks in place. See [Figure 2-7](#).

## With a Mounting Tray

The mounting kit (part number CMP-MGNT-TRAY=) is optional. You can order it when you order your switch, or you can order it later from your Cisco representative.

The mounting kit ships contents:

- Two number-10 Phillips pan-head screws
- Three number-8 Phillips pan-head screws
- Mounting tray
- Magnet

You can use the mounting tray by itself with mounting screws, or with a magnet.

## Mounting Tray with Screws

You can use the mounting tray to secure the switch:

- On a desk or shelf
- Under a desk or shelf
- On a wall



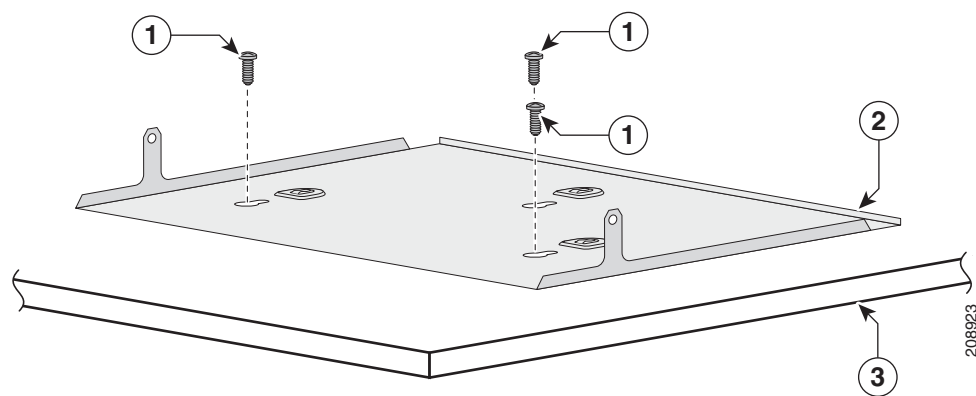
### Caution

Do not wall-mount the switch with its front panel facing up. Following safety regulations, wall-mount the switch with its front panel facing down or to the side, to allow sufficient airflow and to provide easier access to the cables.

This example shows you how to mount the switch on a desk or shelf. You can use a similar procedure to mount the switch under a desk or on a wall.

- Step 1** Place the mounting tray on the desk.
- Step 2** Use a 0.144-in. (3.7 mm) or a #27 drill bit to drill three 1/2-in. (12.7 mm) holes in the desk. See [Figure 2-8](#).
- Step 3** Insert the three number-8 Phillips pan-head screws in the slots on the mounting tray, and tighten them.

**Figure 2-8** Attaching the Tray to the Desk or Shelf

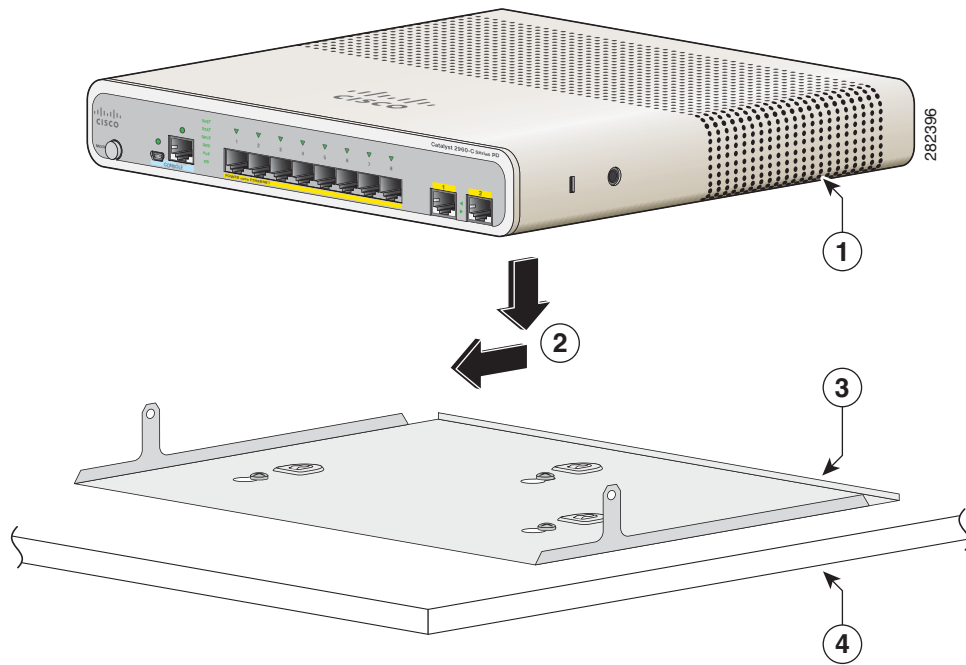


## Mounting the Switch

1	Number-8 Phillips pan-head screws	3	Desk or shelf
2	Mounting tray		

**Step 4** Place the switch onto the mounting screws, and slide the switch until it locks into place. See [Figure 2-9](#).

**Figure 2-9** Installing the Switch on the Mounting Tray

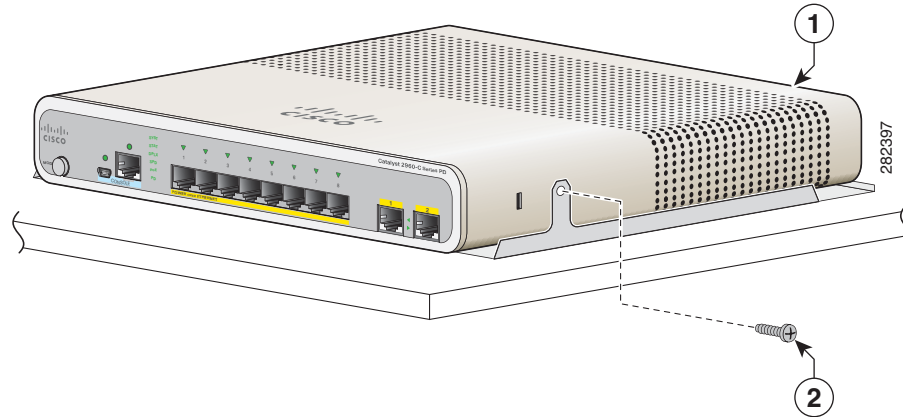


1	Switch	3	Mounting tray
2	Sliding direction	4	Desk



- Step 5** Use the two number-10 Phillips pan-head screws to secure the mounting tray to the switch. See [Figure 2-10](#).

**Figure 2-10** Securing the Mounting Tray to the Switch



<b>1</b>	Switch	<b>2</b>	Number-10 Phillips pan-head screws
----------	--------	----------	------------------------------------

**Warning**

To prevent airflow restriction, allow clearance around the ventilation openings to be at least: **3 in. (7.6 cm)** Statement 1076

## Mounting Tray with a Magnet

You can use a magnet with the mounting tray to mount the switch:

- On a metal surface
- Under a metal surface
- On a metal wall

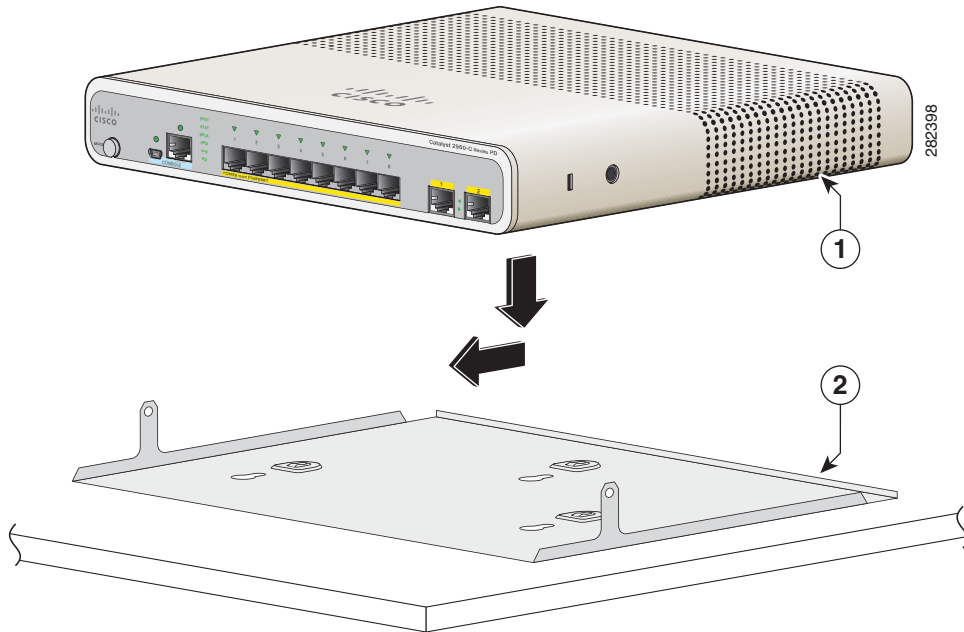
**Caution**

Do not use the magnet without a mounting tray.

This example shows you how to mount the switch on a metal wall. You can use a similar procedure to mount the switch under a metal desk or on a metal desk.

**Step 1** Place the switch on the mounting tray. See [Figure 2-11](#).

**Figure 2-11** *Placing the Switch on the Mounting Tray*

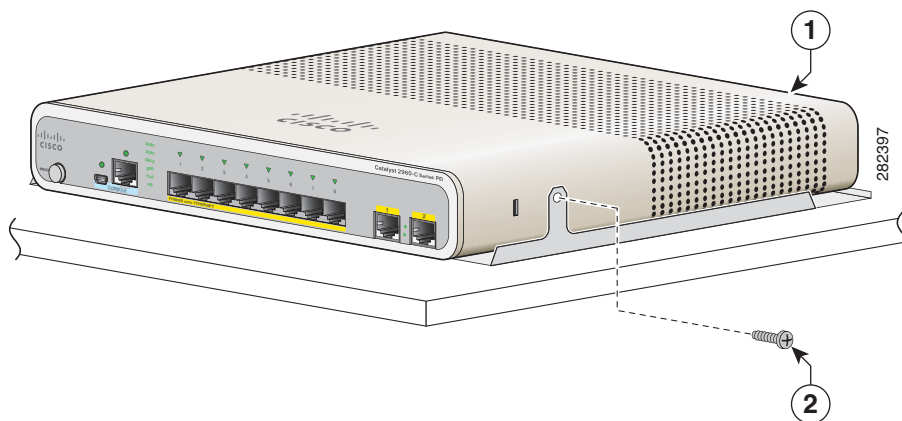


**1** Switch

**2** Mounting tray

**Step 2** Use the two number-10 Phillips pan-head screws to secure the mounting tray to the switch. See [Figure 2-12](#).

**Figure 2-12** *Securing the Mounting Tray to the Switch*



**1** Switch

**2** Number-10 Phillips pan-head screws

**Step 3** Place one side of the magnet against the bottom of the mounting tray, as shown in [Figure 2-13](#). Mount the magnet and switch on a metal wall.

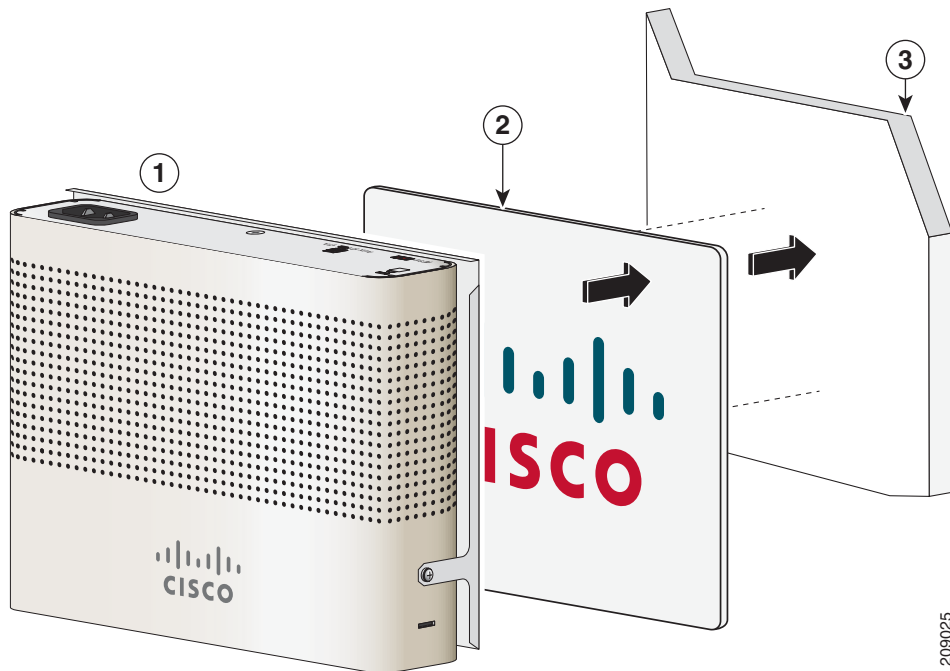
  
**Warning**

**Read the wall-mounting instructions carefully before beginning installation. Failure to use the correct hardware or to follow the correct procedures could result in a hazardous situation to people and damage to the system.** Statement 378

  
**Caution**

Do not wall-mount the switch with its front panel facing up. Following safety regulations, wall-mount the switch with its front panel facing down or to the side, to allow sufficient airflow and to provide easier access to the cables.

**Figure 2-13 Wall-Mounting with a Magnet**



1	Switch with the mounting tray attached	3	Metal wall
2	Magnet		

  
**Warning**

**To prevent airflow restriction, allow clearance around the ventilation openings to be at least: 3 in. (7.6 cm)** Statement 1076

After you mount the switch, see the [“After Installing the Switch”](#) section on page 2-31 for information about configuring the switch.

## In a Rack

Installing the switch in a rack requires an optional bracket kit that is not included with the switch. You can order these kits from your Cisco representative:

- 19-inch rack-mounting brackets (RCKMNT-19-CMPCT=)
- 23- and 24-inch rack-mounting brackets (RCKMNT-23-CMPCT=)



### Warning

**To prevent bodily injury when mounting or servicing this unit in a rack, you must take special precautions to ensure that the system remains stable. The following guidelines are provided to ensure your safety:**

- **This unit should be mounted at the bottom of the rack if it is the only unit in the rack.**
- **When mounting this unit in a partially filled rack, load the rack from the bottom to the top with the heaviest component at the bottom of the rack.**
- **If the rack is provided with stabilizing devices, install the stabilizers before mounting or servicing the unit in the rack.** Statement 1006

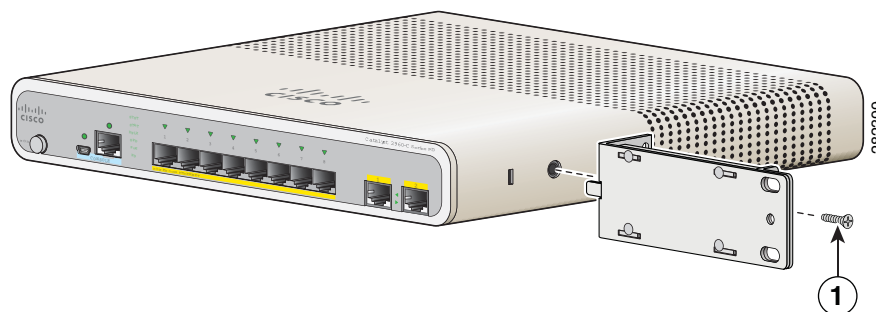
To install the switch in a rack, follow the instructions described in these sections:

- [Attaching Brackets to the Switch, page 2-18](#)
- [Mounting the Switch in a Rack, page 2-19](#)

## Attaching Brackets to the Switch

Figure 2-14 shows how to attach a 19-inch bracket to one side of the switch. Follow the same steps to attach the second bracket to the opposite side.

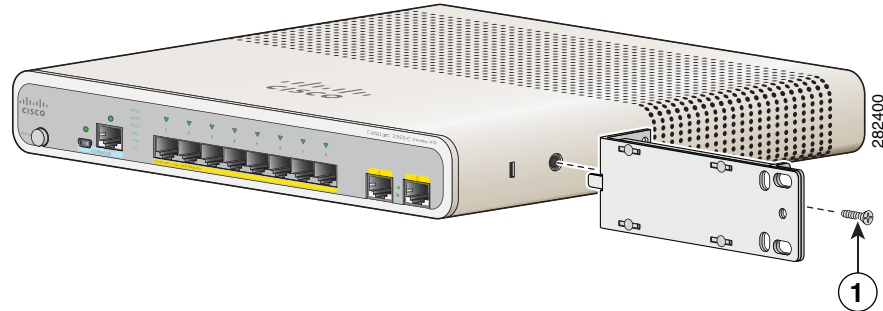
**Figure 2-14 Attaching the 19-inch Brackets for Rack-Mounting**



- |          |                          |
|----------|--------------------------|
| <b>1</b> | Phillips flat-head screw |
|----------|--------------------------|

Figure 2-15 shows how to attach a 23-inch bracket to one side of the switch. Follow the same steps to attach the second bracket to the opposite side.

**Figure 2-15 Attaching the 23-inch Brackets for Rack-Mounting**



<b>1</b>	Phillips flat-head screw
----------	--------------------------

## Mounting the Switch in a Rack

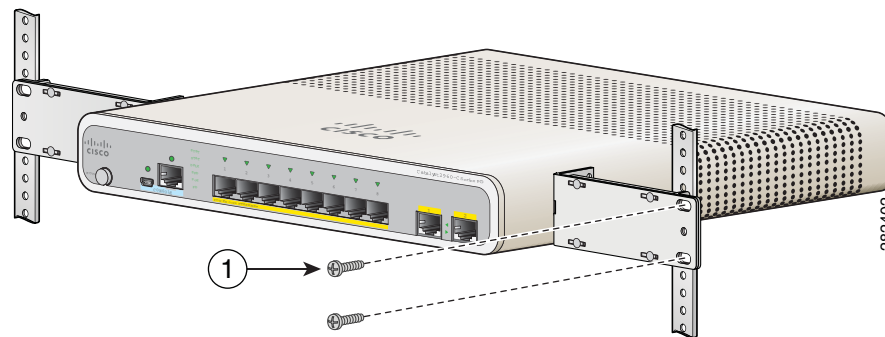
After the brackets are attached to the switch, insert the switch into the rack, and align the bracket in the rack. Use either the number-12 or number-10 Phillips machine screws to secure the switch in the rack. See Figure 2-16.



**Warning**

**To prevent airflow restriction, allow clearance around the ventilation openings to be at least: 3 in. (7.6 cm) Statement 1076**

**Figure 2-16 Mounting the Switch in a Rack**



<b>1</b>	Phillips machine screws
----------	-------------------------

After you mount the switch, see the “After Installing the Switch” section on page 2-31 for information about the switch configuration.

## On a DIN Rail

The DIN-mount kit (part number CMP-DIN-MNT=) is optional. You can order it when you order your switch, or you can order it later from your Cisco representative.

The DIN-mount kit contains:

- Two number-10 Phillips pan-head screws
- DIN rail mount

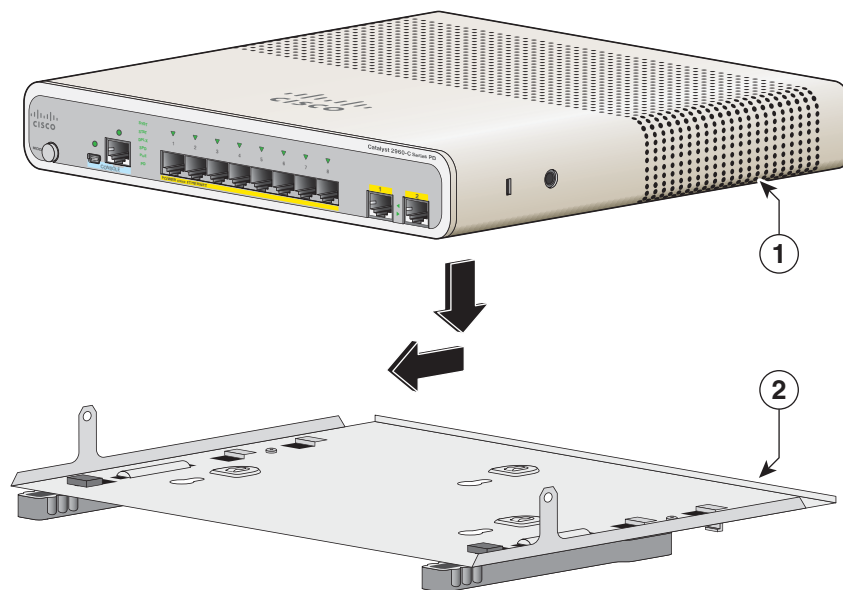
To install the switch on a DIN rail, follow the instructions described in these sections:

- [Attaching the DIN-Mount Tray to the Switch, page 2-20](#)
- [Mounting the Switch on a DIN Rail, page 2-21](#)
- [Removing the Switch from a DIN Rail, page 2-23](#)

### Attaching the DIN-Mount Tray to the Switch

**Step 1** Place the switch on the DIN rail mount. See [Figure 2-17](#).

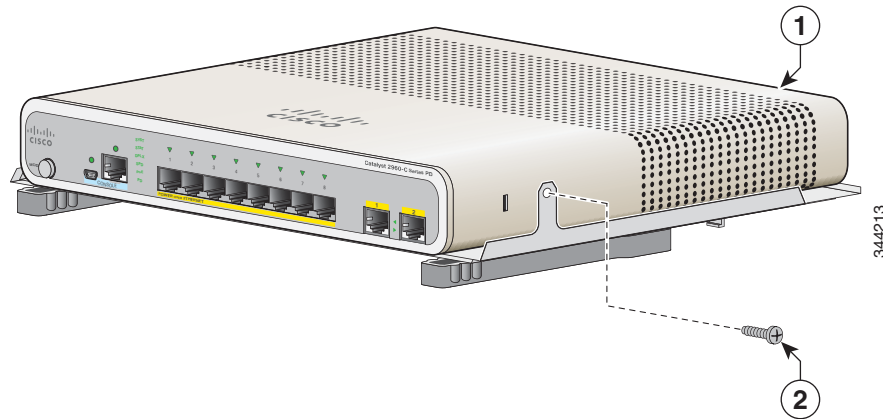
**Figure 2-17** *Placing the Switch on the DIN-Mount Tray*



<b>1</b>	Switch	<b>2</b>	DIN rail mount
----------	--------	----------	----------------

- Step 2** Use the two number-10 Phillips pan-head screws to secure the DIN rail mount to the switch. See [Figure 2-18](#).

**Figure 2-18** Securing the DIN-Mount Tray to the Switch



<b>1</b>	Switch	<b>2</b>	Number-10 Phillips pan-head screws
----------	--------	----------	------------------------------------

## Mounting the Switch on a DIN Rail

  
**Caution**

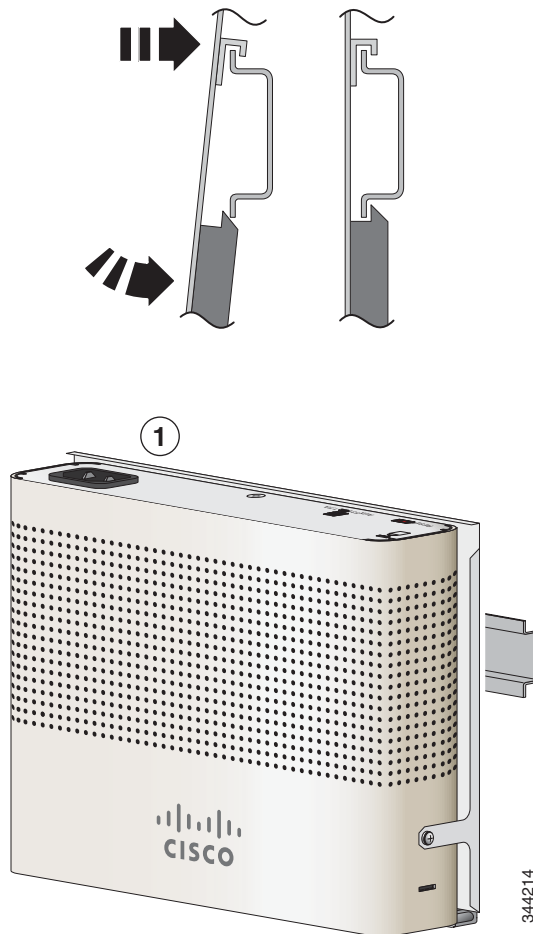
Do not install the switch with its front panel facing up. Following safety regulations, install the switch with its front panel facing down, to allow sufficient airflow and to provide easier access to the cables.

  
**Warning**

**To prevent airflow restriction, allow clearance around the ventilation openings to be at least: 3 in. (7.6 cm)** Statement 1076

- Step 1** Position the switch directly in front of the DIN rail, making sure that the top of the DIN rail mount clip hooks over the top of the DIN rail. See [Figure 2-19](#).

**Figure 2-19** Mounting the Switch on a DIN Rail



<b>1</b>	Switch
----------	--------

**Step 2** Rotate the switch down toward the DIN rail until the release tabs on the DIN rail mount clicks.

**Step 3** Lift lightly on the bottom of the switch to ensure that it is firmly locked in place.

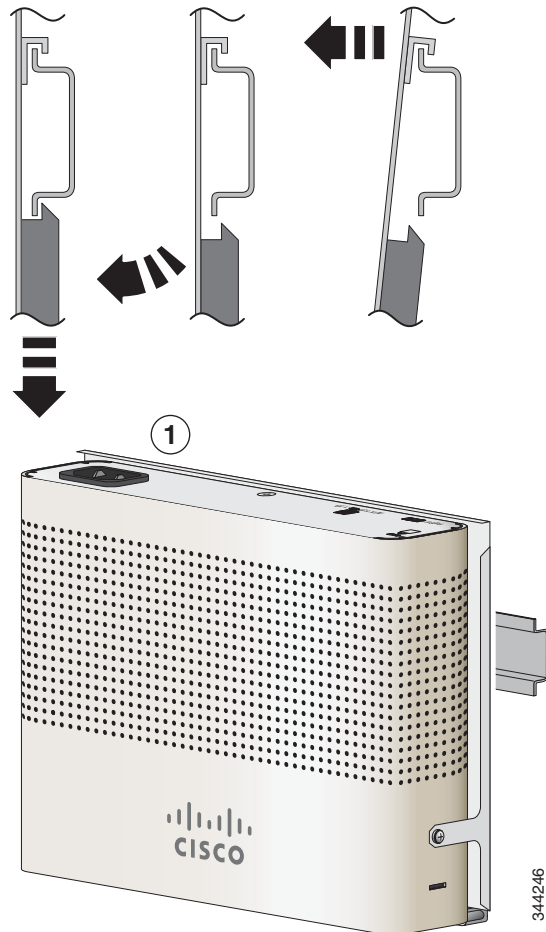
After you install the switch, see the [“After Installing the Switch”](#) section on page 2-31 for information about the switch configuration.



## Removing the Switch from a DIN Rail

- Step 1** Ensure that power is removed from the switch, and disconnect all cables and connectors from the front panel of the switch.
- Step 2** Pull down on the DIN rail mount release tabs. As the clips release, lift the bottom of the switch. See [Figure 2-20](#).

**Figure 2-20** Switch Removal



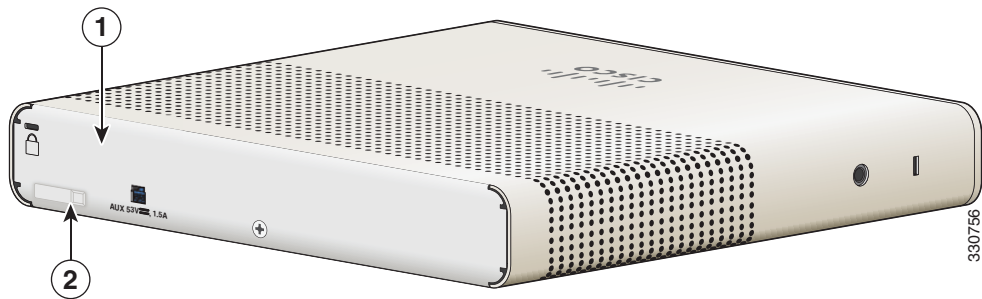
<b>1</b>	Switch
----------	--------

## Installing a Cover for the Reset Button (Optional)

You can cover the reset button to prevent accidental or unauthorized reset of your switch. To install a cover on the reset button:

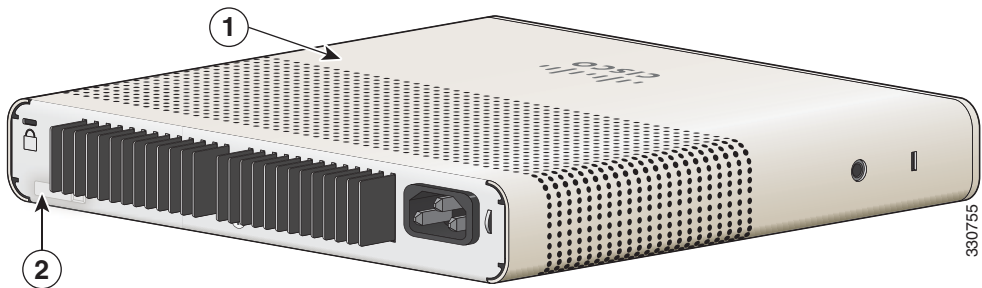
1. Locate the cover (in the accessory kit).
2. Remove the adhesive sticker from the back of the cover.
3. Apply the cover on the switch. See [Figure 2-21](#) and [Figure 2-22](#) as examples. You can apply the cover to other switch models as well.

**Figure 2-21** Reset Cover on the Catalyst 2960CPD-8PT-L Switch



1	Switch	2	Reset button cover
---	--------	---	--------------------

**Figure 2-22** Reset Cover on the Catalyst 2960CG-8PC-S Switch



1	Switch	2	Reset button cover
---	--------	---	--------------------

# Installing the Power Cord Retainer (Optional)

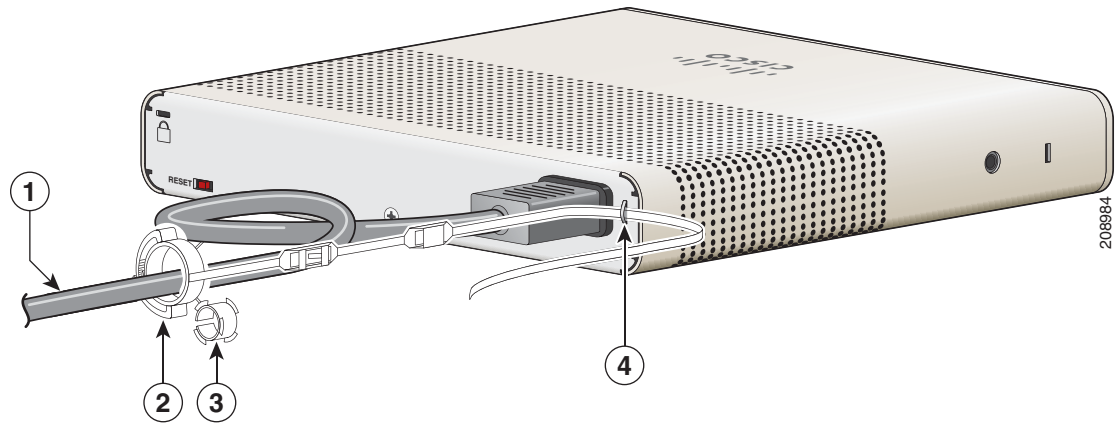

**Note**

This section applies to switches with an AC power connector.

The power cord retainer part number (PWR-CLP=) is optional. You can order it when you order your switch, or you can order it later from your Cisco representative.

- Step 1** Choose the sleeve size of the power cord retainer based on the thickness of the cord. The smaller sleeve can be snapped off and used for thin cords. See [Figure 2-26](#).
- Step 2** Slide the retainer around the AC power cord, and pass it around the loop on the switch. See [Figure 2-23](#).

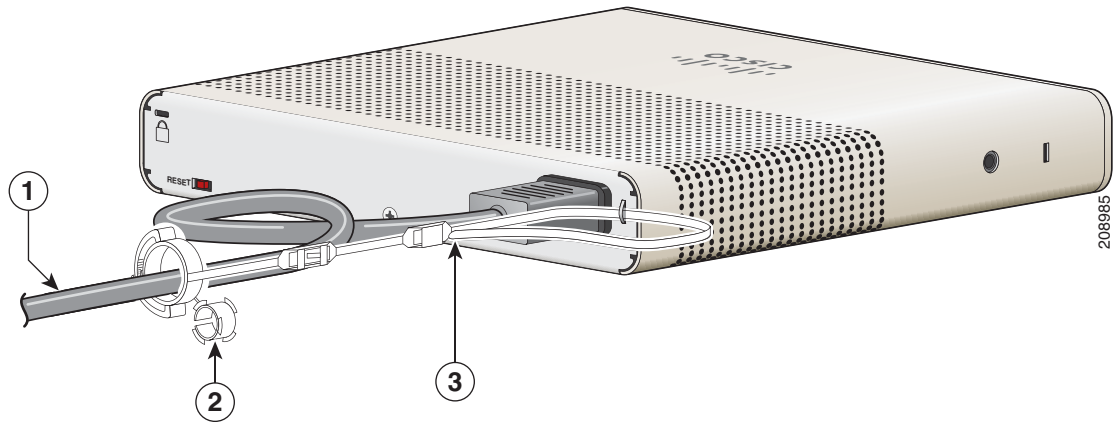
**Figure 2-23** Inserting the Retainer through the Lanced Loop



1	AC power cord	3	Sleeve for thinner power cords
2	Power cord retainer	4	Loop

**Step 3** Slide the retainer through the first latch. See [Figure 2-24](#).

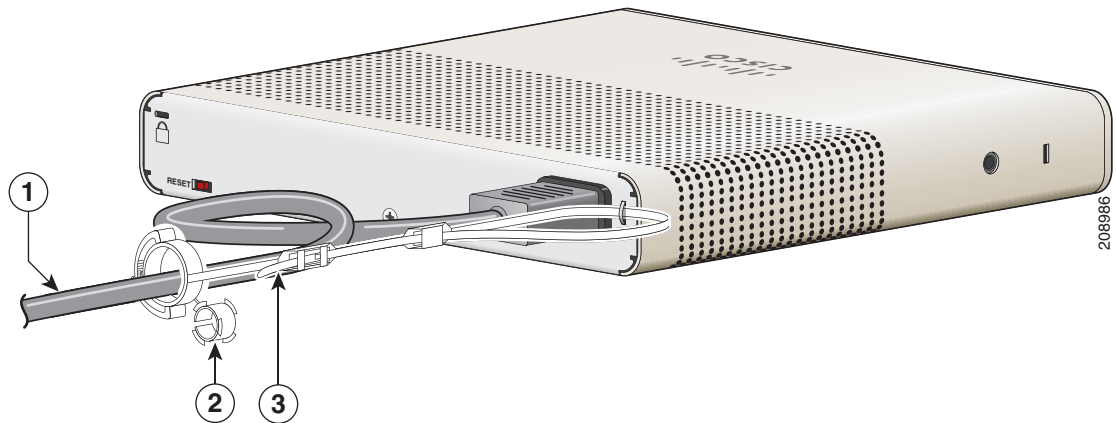
**Figure 2-24** Sliding the Retainer Through the Latch



<b>1</b>	AC power cord	<b>3</b>	Latch
<b>2</b>	Smaller sleeve for thin power cords		

**Step 4** Slide the retainer through the other latches to lock it. See [Figure 2-25](#).

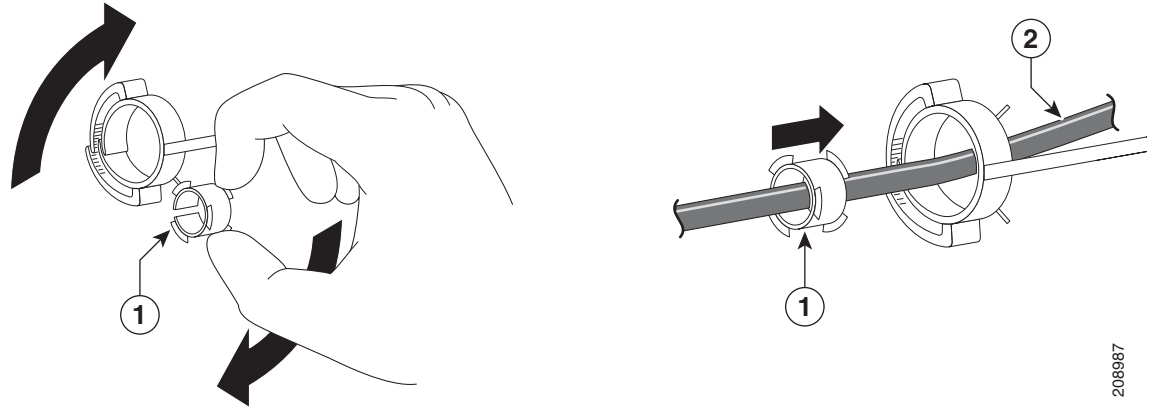
**Figure 2-25** Locking the Retainer



<b>1</b>	AC power cord	<b>3</b>	Latches
<b>2</b>	Sleeve for thin power cords		

**Step 5** (Optional) Use the small sleeve for thin power cords. Use the small sleeve to provide greater stability for thin cords. Detach the sleeve, and slide it over the power cord. See [Figure 2-26](#).

**Figure 2-26** Sleeve Around the Power Cord

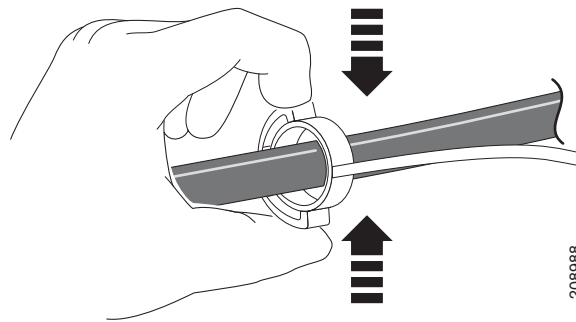


208987

1 Sleeve for thin power cords	2 AC power cord
-------------------------------	-----------------

**Step 6** Secure the AC power cord by pressing on the retainer. See [Figure 2-27](#).

**Figure 2-27** Securing the Power Cord in the Retainer



208988

## Installing the Cable Guard (Optional)

The cable guard prevents tampering with the cables after the cables are installed. The cable guard (CMP-CBLE-GRD=) is not included with the switch, but you can order it from your Cisco representative.


**Note**

You can use the cable guard when the switch is mounted on a desk, under a desk, or on a wall.

The cable guard is shipped with these items:

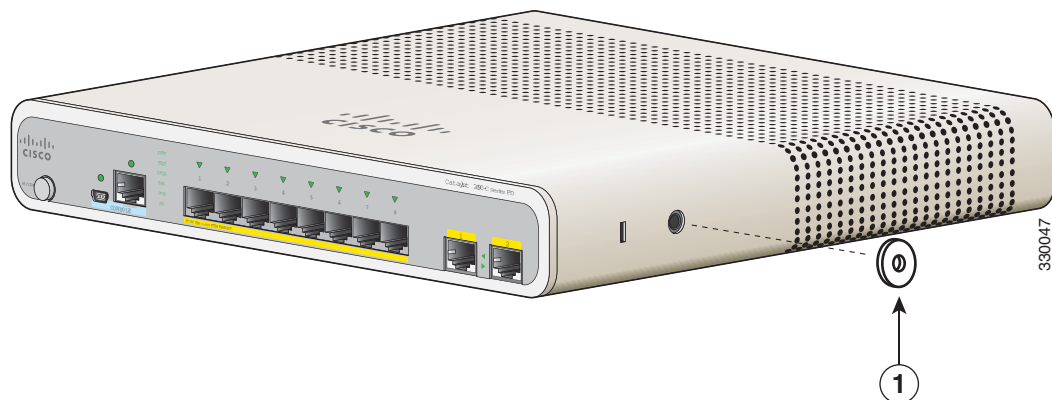
- Two 0.5 in. (12.7 mm) number-8 Phillips wood screws
- Two number-10 Phillips pan-head screws
- Two washers

**Step 1** (Optional) Attach the supplied washers before you install the cable guard. See [Figure 2-28](#).


**Note**

This is only required if you are not installing the wall-mount brackets.

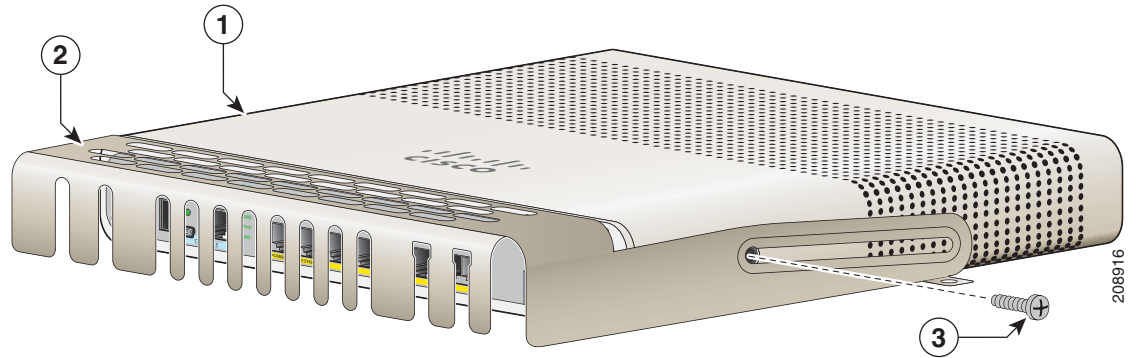
**Figure 2-28** Using the Washer



<b>1</b>	Washer
----------	--------

**Step 2** Use the supplied number-10 pan-head screws to attach the cable guard to the switch. See [Figure 2-29](#).

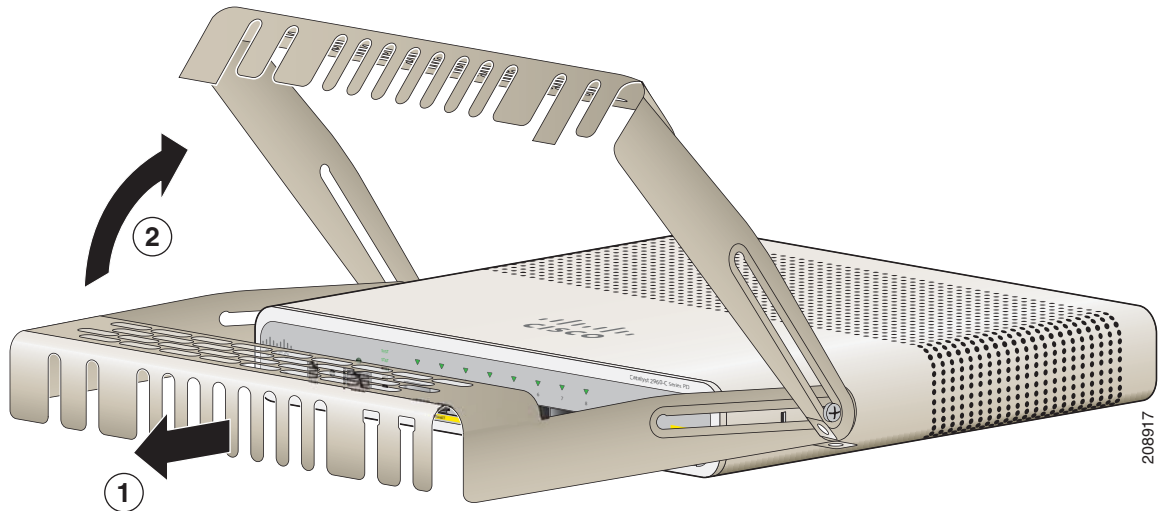
**Figure 2-29 Attaching the Cable Guard to the Switch**



<b>1</b>	Switch	<b>3</b>	Two number-10 Phillips pan-head screws
<b>2</b>	Cable guard		

**Step 3** Loosen the number-10 Phillips pan-head screws, slide the cable guide out, and pivot it upwards so that you can install the cables. See [Figure 2-30](#).

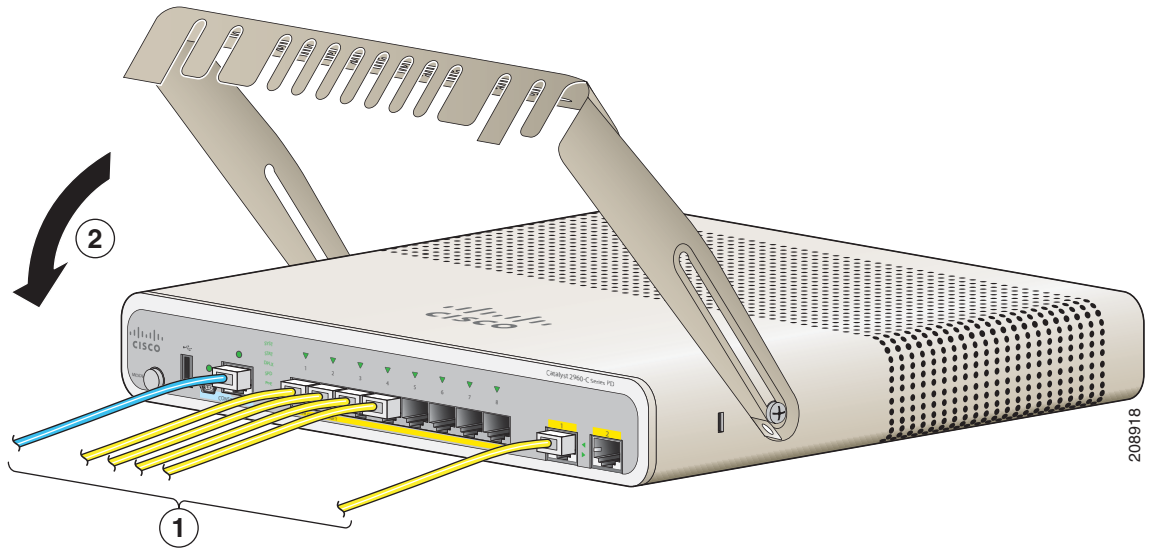
**Figure 2-30 Pivoting the Cable Guard Upwards**



<b>1</b>	Cable guard	<b>2</b>	Pivot direction for cable guard pivots
----------	-------------	----------	--

Attach the cables to the switch. See [Figure 2-31](#).

**Figure 2-31 Attaching the Cables to the Switch**

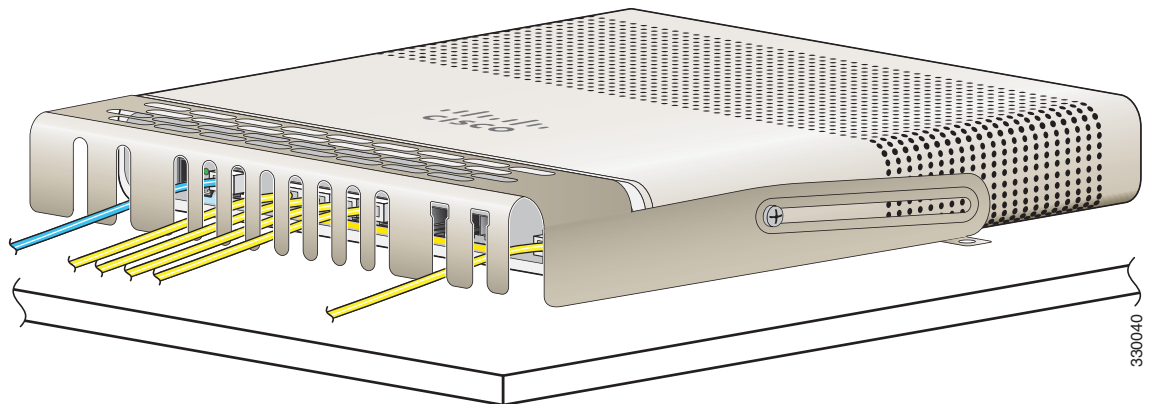


**1** Cable guard

**2** Pivot direction for cable guard pivots

**Step 4** Guide the connected cables through the slots in the front of the cable guard. Slide the cable guide in as shown in [Figure 2-33](#). Tighten the screws.

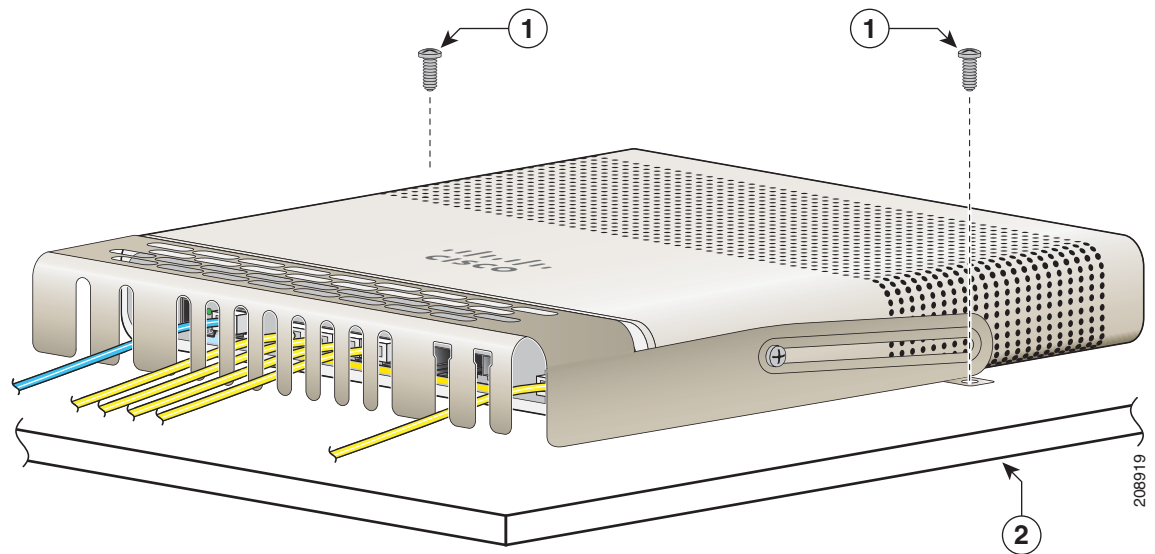
**Figure 2-32 Guiding the Cables through the Guard**





- Step 5** (Optional) To attach the cable guard to the desk or wall, use a 0.144-inch (3.7 mm) or a #27 drill bit to drill 1/2-inch (12.7 mm) holes at each of the two mounting locations. Insert the supplied 0.5 in. (12.7 mm) number-8 Phillips wood screws and tighten them as shown in [Figure 2-33](#).

**Figure 2-33** Securing the Cable Guard to the Desk



1	Number-8 Phillips wood screws	2	Desk or shelf
---	-------------------------------	---	---------------

## After Installing the Switch

1. Power on the switch. See the [“Verifying Switch Operation”](#) section on page 2-5.
2. Connect to a 10/100 or 10/100/1000 port, and run Express Setup. See the switch getting started guide for instructions.
3. Connect to the ports. See the [“Connecting Devices to the Ethernet Ports”](#) section on page 2-33 to complete the installation.

For configuration instructions about using the CLI setup program, go to [Appendix C, “Configuring the Switch with the CLI Setup Program.”](#)

## Installing SFP Modules

When installing SFP modules, observe these guidelines:

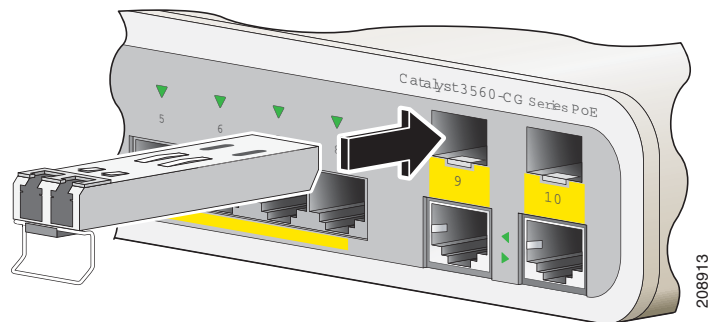
- Removing and installing an SFP module can shorten its useful life. Do not remove and insert any module more often than is absolutely necessary.
- To prevent ESD damage, follow your normal board and component handling procedures when connecting cables to the switch and other devices.

**Warning**

**Class 1 laser product.** Statement 1008

- 
- Step 1** Attach an ESD-preventive wrist strap to your wrist and to a bare metal surface.
- Step 2** Find the send (TX) and receive (RX) markings on the module top.  
On some SFP modules, the TX and RX markings might be replaced by arrows that show the direction of the connection, either send or receive.
- Step 3** If the module has a bale-clasp latch, move it to the open, unlocked position.
- Step 4** Align the module in front of the slot opening, and push until you feel the connector snap into place.
- Step 5** If the module has a bale-clasp latch, close it.
- Step 6** For fiber-optic SFP modules, remove the dust plugs and save.
- Step 7** Connect the SFP cables.

**Figure 2-34** Installing an SFP Module

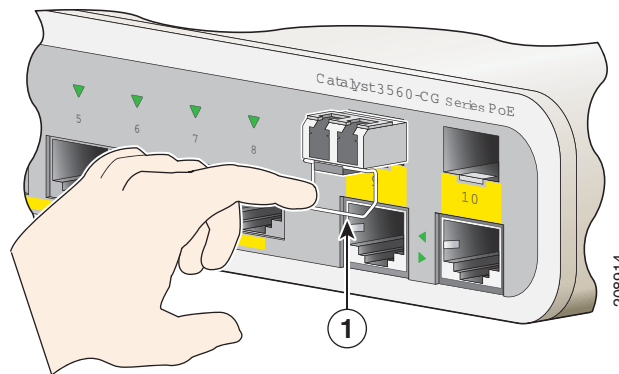
**Caution**

Do not remove the dust plugs from the fiber-optic SFP module port or the rubber caps from the fiber-optic cable until you are ready to connect the cable. The plugs and caps protect the SFP module ports and cables from contamination and ambient light.

## Removing SFP Modules

- 
- Step 1** Attach an ESD-preventive wrist strap to your wrist and to a bare metal surface.
- Step 2** Disconnect the cable from the SFP module. For reattachment, note which cable connector plug is send (TX) and which is receive (RX).
- Step 3** Insert a dust plug into the optical ports of the SFP module.
- Step 4** If the module has a bale-clasp latch, pull the bale out and down to eject it. If the latch is obstructed and you cannot use your finger, use a small, flat-blade screwdriver or other long, narrow instrument.
- Step 5** Grasp the SFP module, and carefully remove it from the slot.
- Step 6** Place the module in an antistatic bag or other protective environment.

**Figure 2-35** Removing a Bale-Clasp Latch SFP Module



<b>1</b>	Bale clasp
----------	------------

## Connecting Devices to the Ethernet Ports

- [Connecting to the 10/100 and 10/100/1000 Ports, page 2-33](#)
- [Connecting to the PoE Ports, page 2-34](#)

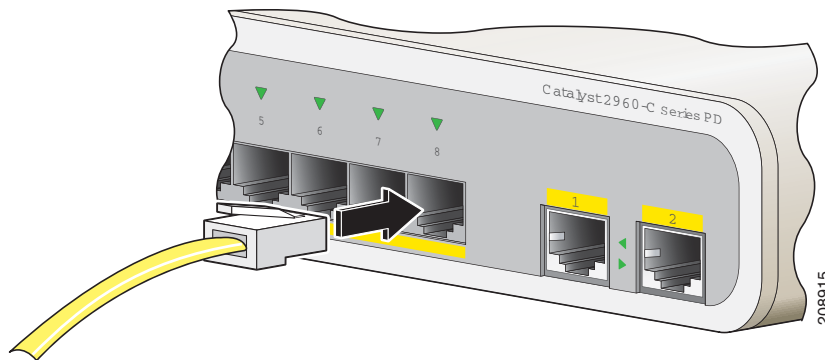
### Connecting to the 10/100 and 10/100/1000 Ports

The 10/100 and 10/100/1000 Ethernet ports use RJ-45 connectors with Ethernet pinouts. The maximum cable length is 328 feet (100 meters). The 100BASE-TX and 1000BASE-T traffic requires Category 5, Category 5e, or Category 6 UTP cable. The 10BASE-T traffic uses Category 3 or Category 4 cable.

The autonegotiation feature is enabled by default on the switch. At this setting, the switch ports configure themselves to operate at the speed of the attached device. If the device does not support autonegotiation, you can set the switch port speed and duplex parameters. To maximize performance, either let the ports autonegotiate both speed and duplex, or set the port speed and duplex parameters on both ends of the connection.

See the switch software configuration guide or the switch command reference on Cisco.com for more information about autonegotiation and auto-MDIX.

If auto-MDIX is disabled, use the guidelines in [Table 2-1](#) to select the cable for connecting the 10/100/1000 Ethernet ports to other devices. See the “[Cables and Adapters](#)” section on [page B-3](#) for cable-pinout descriptions. See [Figure 2-36](#).

**Figure 2-36** Connecting to an Ethernet Port**Table 2-1** Ethernet Cables (Auto-MDIX Disabled)

Device	Crossover Cable <sup>1</sup>	Straight-Through Cable <sup>1</sup>
Switch to switch	Yes	No
Switch to hub	Yes	No
Switch to computer or server	No	Yes
Switch to router	No	Yes
Switch to IP phone	No	Yes

1. 100BASE-TX and 1000BASE-T traffic requires twisted four-pair, Category 5, Category 5e, or Category 6 cable. 10BASE-T traffic uses Category 3 or Category 4 cable.

## Connecting to the PoE Ports

The 10/100 PoE ports have the same autonegotiation settings and cabling requirements as those in the “Connecting to the 10/100 and 10/100/1000 Ports” section on page 2-33. These ports provide PoE power.

See the “PoE Ports (Switches with PoE Ports)” section on page 1-5 for information on the cables and connectors.

The ports provide PoE support for 802.3af-compliant devices and also provide Cisco prestandard PoE support for Cisco IP Phones and Cisco Aironet Access Points.

On a per-port basis, you can control whether or not a port automatically provides power to a connected IP phone or an access point.

To access an advanced PoE planning tool, use the Cisco Power Calculator on Cisco.com:

<http://tools.cisco.com/20/launch.jsp>

You can use this application to calculate the power supply requirements for a specific PoE configuration. The results show output current, output power, and heat dissipation.



### Warning

**Voltages that present a shock hazard may exist on Power over Ethernet (PoE) circuits if interconnections are made using uninsulated exposed metal contacts, conductors, or terminals. Avoid using such interconnection methods, unless the exposed metal parts are located within a**

**restricted access location and users and service people who are authorized within the restricted access location are made aware of the hazard. A restricted access area can be accessed only through the use of a special tool, lock and key or other means of security.** Statement 1072

---

**Caution**

Category 5e and Category 6 cables can store high levels of static electricity. Always ground the cables to a suitable and safe earth ground before connecting them to the switch or other devices.

---

## Where to Go Next

To change the switch settings, you can use the switch default configuration or use any of the management options described in the [“Management Options”](#) section.





## CHAPTER 3

# Troubleshooting

---

- [Diagnosing Problems, page 3-1](#)
- [Resetting the Switch, page 3-5](#)
- [Finding the Switch Serial Number, page 3-5](#)

## Diagnosing Problems

The switch LEDs provide troubleshooting information about the switch. They show POST failures, port-connectivity problems, and overall switch performance. You can also get statistics from the device manager, the CLI, or an SNMP workstation. See the software configuration guide, the switch command reference guide on Cisco.com, or the documentation that came with your SNMP application for details.

## Switch POST Results

See the [“Verifying Switch Operation”](#) section on page 2-5 for information on POST.



**Note**

---

POST failures are usually fatal. Contact your Cisco technical support representative if your switch does not pass POST.

---

## Switch LEDs

Look at the port LEDs information when troubleshooting the switch. See the “LEDs” section on page 1-12 for a description of the LED colors and their meanings.

## Switch Connections

### Bad or Damaged Cable

Always examine the cable for marginal damage or failure. A cable might be just good enough to connect at the physical layer, but it could corrupt packets as a result of subtle damage to the wiring or connectors. You can identify this problem because the port has many packet errors or it constantly flaps (loses and regains link).

- Exchange the copper or fiber-optic cable with a known good cable.
- Look for broken or missing pins on cable connectors.
- Rule out any bad patch panel connections or media convertors between the source and the destination. If possible, bypass the patch panel, or eliminate media convertors (fiber-optic-to-copper).
- Try the cable in another port to see if the problem follows the cable.

### Ethernet and Fiber-Optic Cables

Make sure that you have the correct cable:

- For Ethernet, use Category 3 copper cable for 10 Mb/s UTP connections. Use either Category 5, Category 5e, or Category 6 UTP for 10/100 or 10/100/1000 Mb/s connections.
- Verify that you have the correct fiber-optic cable for the distance and port type. Make sure that the connected device ports match and use the same type encoding, optical frequency, and fiber type.
- Determine if a copper crossover cable was used when a straight-through was required or the reverse. Enable auto-MDIX on the switch, or replace the cable. See [Table 2-1](#) for recommended Ethernet cables.

### Link Status

Verify that both sides have link. A broken wire or a shutdown port can cause one side to show link even though the other side does not have link.

A port LED that is on does not guarantee that the cable is functional. It might have encountered physical stress, causing it to function at a marginal level. If the port LED does not turn on:

- Connect the cable from the switch to a known good device.
- Make sure that both ends of the cable are connected to the correct ports.
- Verify that both devices have power.
- Verify that you are using the correct cable type. See [Appendix B, “Connector and Cable Specifications”](#) for information.
- Look for loose connections. Sometimes a cable appears to be seated but is not. Disconnect the cable, and then reconnect it.



## 10/100 and 10/100/1000 Port Connections

A port appears to malfunction:

- Verify the status of all ports. See [Table 1-7 on page 1-14](#) for descriptions of the LEDs and their meanings.
- Use the **show interfaces** privileged EXEC command to see if the port is error-disabled, disabled, or shut down. Re-enable the port if necessary.
- Verify the cable type. See [Appendix B, “Connector and Cable Specifications.”](#)

## 10/100 PoE or PoE+ Port Connections

A powered device connected to a PoE or PoE+ port does not receive power:

- Verify the status of all the ports. See [Table 1-7](#) for descriptions of the LEDs and their meanings.
- Use the **show interfaces** privileged EXEC command to see if the port is error-disabled, disabled, or shutdown. Re-enable the port if necessary.
- Verify the cable type. Many legacy powered devices, including older Cisco IP phones and access points that do not fully support 802.3af might not support PoE when connected to the switch by a crossover cable. Replace the crossover cable with a straight-through cable.



### Caution

---

Noncompliant cabling or powered devices can cause a PoE port fault. Use only compliant cabling to connect Cisco prestandard IP Phones, and wireless access points, or 802.3af-compliant devices.

---

## SFP Module

Use only Cisco SFP modules. Each Cisco module has an internal serial EEPROM that is encoded with security information. This encoding verifies that the module meets the requirements for the switch.

- Inspect the SFP module. Exchange the suspect module with a known good module.
- Verify that the module is supported on this platform. (The switch release notes on Cisco.com list the SFP modules that the switch supports.)
- Use the **show interfaces** privileged EXEC command to see if the port or module is error-disabled, disabled, or shutdown. Re-enable the port if needed.
- Make sure that all fiber-optic connections are clean and securely connected.

## Interface Settings

Verify that the interface is not disabled or powered off. If an interface is manually shut down on either side of the link, it does not come up until you re-enable the interface. Use the **show interfaces** privileged EXEC command to see if the interface is error-disabled, disabled, or shut down on either side of the connection. If needed, re-enable the interface.

## Ping End Device

Ping from the directly connected switch first, and then work your way back port by port, interface by interface, trunk by trunk, until you find the source of the connectivity issue. Make sure that each switch can identify the end device MAC address in its Content-Addressable Memory (CAM) table.

## Spanning Tree Loops

STP loops can cause serious performance issues that look like port or interface problems.

A unidirectional link can cause loops. It occurs when the traffic sent by the switch is received by the neighbor, but the traffic from the neighbor is not received by the switch. A broken cable, other cabling problems, or a port issue could cause this one-way communication.

You can enable UniDirectional Link Detection (UDLD) on the switch to help identify unidirectional link problems. For information about enabling UDLD on the switch, see the “Understanding UDLD” section in the switch software configuration guide on Cisco.com.

## Switch Performance

### Speed, Duplex, and Autonegotiation

Port statistics that show a large amount of alignment errors, frame check sequence (FCS), or late-collisions errors, might mean a speed or duplex mismatch.

A common issue occurs when duplex and speed settings are mismatched between two switches, between a switch and a router, or between the switch and a workstation or server. Mismatches can happen when manually setting the speed and duplex or from autonegotiation issues between the two devices.

To maximize switch performance and to ensure a link, follow one of these guidelines when changing the duplex or the speed settings.

- Let both ports autonegotiate both speed and duplex.
- Manually set the speed and duplex parameters for the interfaces on both ends of the connection.
- If a remote device does not autonegotiate, use the same duplex settings on the two ports. The speed parameter adjusts itself even if the connected port does not autonegotiate.

### Autonegotiation and Network Interface Cards

Problems sometimes occur between the switch and third-party network interface cards (NICs). By default, the switch ports and interfaces autonegotiate. Laptops or other devices are commonly set to autonegotiate, yet sometimes issues occur.

To troubleshoot autonegotiation problems, try manually setting both sides of the connection. If this does not solve the problem, there could be a problem with the firmware or software on the NIC. You can resolve this by upgrading the NIC driver to the latest version.

### Cabling Distance

If the port statistics show excessive FCS, late-collision, or alignment errors, verify that the cable distance from the switch to the connected device meets the recommended guidelines. See the [“Cables and Adapters” section on page B-3](#).

# Resetting the Switch

**Note**

Resetting the switch reboots the switch.

To reset the switch:

1. At the switch prompt, enter **enable**, and press **Return** or **Enter**.
2. At the Privileged EXEC prompt, `switch#`, enter **setup** and press **Return** or **Enter**.

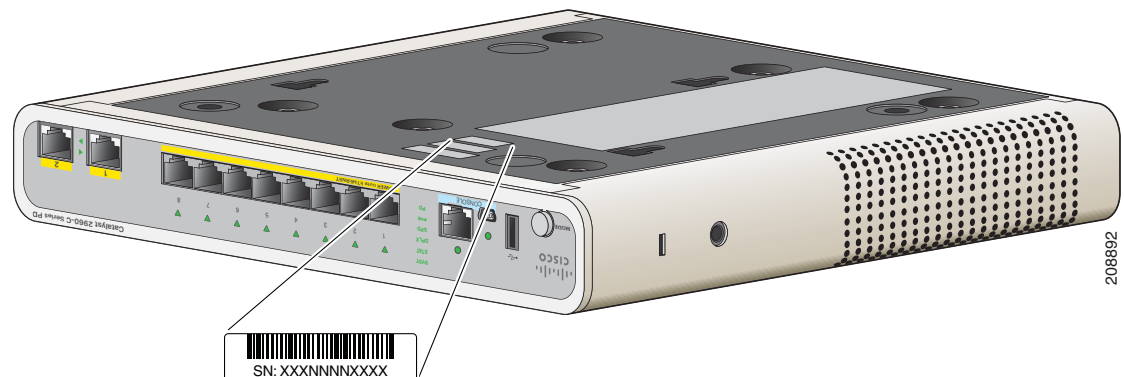
The switch displays the prompt to run the initial configuration dialog. See [Appendix C, “Configuring the Switch with the CLI Setup Program.”](#)

Alternatively, you can press the Reset button on the rear of the switch to power cycle the switch.

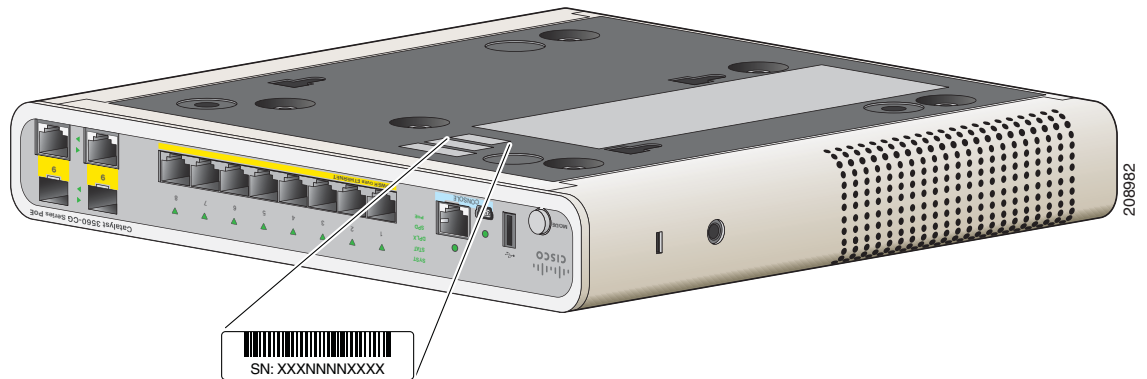
# Finding the Switch Serial Number

If you contact Cisco Technical Assistance, you need to know the switch serial number. [Figure 3-1](#) and [Figure 3-2](#) show the serial number locations. You can also use the **show version** privileged EXEC command to see the switch serial number.

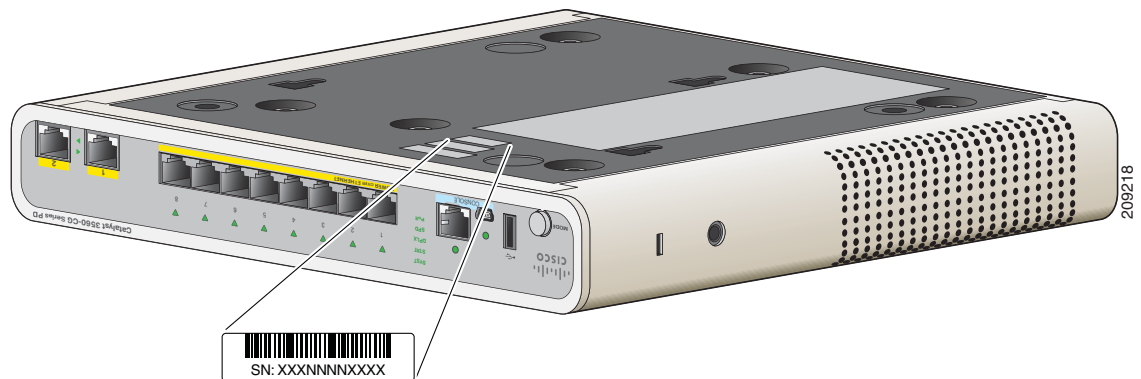
**Figure 3-1** Serial Number Location for the Catalyst 2960CPD-8TT-L and the 2960CPD-8PT-L



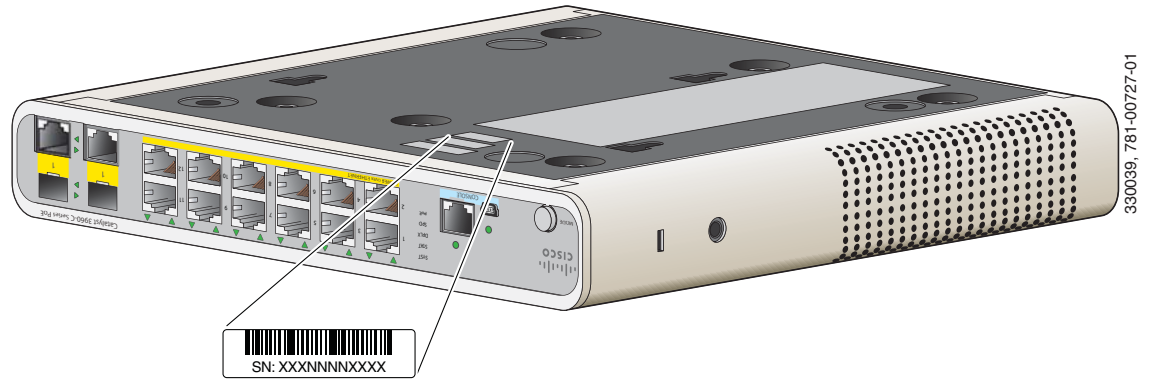
**Figure 3-2** Serial Number Location for the Catalyst 3560CG-8PC-S, 3560CG-8PC-S, and the 3560CG-8TC-S



**Figure 3-3** Serial Number Location for the Catalyst 3560CPD-8PT-S Switch



**Figure 3-4** Serial Number Location for the Catalyst 2960C-8TC-L, 2960C-8TC-S, 2960C-8PC-L, 2960C-12PC-L, 3560C-8PC-S, and 3560C-12PC-S Switches







# APPENDIX **A**

## Technical Specifications

**Table A-1** *Environmental and Physical Specifications for the Catalyst 3560-C and 2960-C Switches*

<b>Environmental Ranges</b>	
Operating temperature	
Catalyst 2960CPD-8TT-L	23 to 113°F (–5 to 45°C) up to 5000 ft (1524 m)
Catalyst 2960CPD-8PT-L	
Catalyst 2960C-8TC-L	
Catalyst 2960C-8TC-S	
Catalyst 2960C-8PC-L	
Catalyst 2960C-12PC-L	
Catalyst 3560C-8PC-S	
Catalyst 3560C-12PC-S	
Catalyst 2960CG-8TC-L	23 to 104°F (–5 to 40°C) up to 5000 ft (1524 m)
Catalyst 3560CG-8PC-S	
Catalyst 3560CG-8TC-S	
Catalyst 3560CPD-8PT-S	
Storage temperature	–22 to 158°F (–30 to 70°C) up to 15,000 ft (4573 m)
Relative humidity	5 to 95% (noncondensing)
Operating altitude	Up to 10,000 ft (3049 m)
Storage altitude	Up to 15,000 ft (4570 m)

**Table A-1 Environmental and Physical Specifications for the Catalyst 3560-C and 2960-C Switches**

<b>Environmental Ranges</b>	
<b>Physical Specifications</b>	
<b>Weight</b>	
Catalyst 2960CPD-8TT-L	2.4 lb (1.08 kg)
Catalyst 2960CPD-8PT-L	2.4 lb (1.08 kg)
Catalyst 2960CG-8TC-L	3.0 lb (1.35 kg)
Catalyst 2960C-8TC-L	2.8 lb (1.27 kg)
Catalyst 2960C-8TC-S	2.8 lb (1.27 kg)
Catalyst 2960C-8PC-L	4.1 lb (1.86 kg)
Catalyst 2960C-12PC-L	4.1 lb (1.86 kg)
Catalyst 3560CG-8PC-S	4.3 lb (1.92 kg)
Catalyst 3560CG-8TC-S	3.0 lb (1.35 kg)
Catalyst 3560CPD-8PT-S	3.3 lb (1.50 kg)
Catalyst 3560C-8PC-S	4.1 lb (1.86 kg)
Catalyst 3560C-12PC-S	4.1 lb (1.86 kg)
<b>Dimensions (H x D x W)</b>	
Catalyst 2960CPD-8TT-L	1.75 x 6.8 x 10.6 in. (4.4 x 17.2 x 26.9 cm)
Catalyst 2960CPD-8PT-L	1.75 x 6.8 x 10.6 in. (4.4 x 17.2 x 26.9 cm)
Catalyst 2960CG-8TC-L	1.75 x 8.4 x 10.6 in. (4.4 x 21.3 x 26.9 cm)
Catalyst 2960C-8TC-L	1.75 x 8.4 x 10.6 in. (4.4 x 21.3 x 26.9 cm)
Catalyst 2960C-8TC-S	1.75 x 8.4 x 10.6 in. (4.4 x 21.3 x 26.9 cm)
Catalyst 2960C-8PC-L	1.75 x 9.4 x 10.6 in. (4.4 x 23.8 x 26.9 cm)
Catalyst 2960C-12PC-L	1.75 x 9.4 x 10.6 in. (4.4 x 23.8 x 26.9 cm)
Catalyst 3560CG-8PC-S	1.75 x 9.4 x 10.6 in. (4.4 x 23.9 x 26.9 cm)
Catalyst 3560CG-8TC-S	1.75 x 8.4 x 10.6 in. (4.4 x 21.3 x 26.9 cm)
Catalyst 3560CPD-8PT-S	1.75 x 7.6 x 10.6 in. (4.4 x 19.4 x 26.9 cm)
Catalyst 3560C-8PC-S	1.75 x 9.4 x 10.6 in. (4.4 x 23.8 x 26.9 cm)
Catalyst 3560C-12PC-S	1.75 x 9.4 x 10.6 in. (4.4 x 23.8 x 26.9 cm)



**Table A-2 Catalyst 3560-C and 2960-C Switch Specifications**

<b>Power Requirements</b>	
AC input voltage	100 to 240 VAC (autoranging) <ul style="list-style-type: none"> <li>• Catalyst 2960CPD-8TT-L: 0.2 to 0.13 A, 50 to 60 Hz</li> <li>• Catalyst 2960CPD-8PT-L: 0.5 to 0.25 A, 50 to 60 Hz</li> <li>• Catalyst 2960CG-8TC-L: 0.34 to 0.2 A, 50 to 60 Hz</li> <li>• Catalyst 2960C-8TC-L: 0.21 to 0.1 A, 50 to 60 Hz</li> <li>• Catalyst 2960C-8TC-S: 0.21 to 0.1 A, 50 to 60 Hz</li> <li>• Catalyst 2960C-8PC-L: 1.59 to 0.8 A, 50 to 60 Hz</li> <li>• Catalyst 2960C-12PC-L: 1.6 to 0.8 A, 50 to 60 Hz</li> <li>• Catalyst 3560CG-8PC-S: 1.68 to 0.8 A, 50 to 60 Hz</li> <li>• Catalyst 3560CG-8TC-S: 0.37 to 0.2 A, 50 to 60 Hz</li> <li>• Catalyst 3560CPD-8PT-S: 0.5 to 0.25 A, 50 to 60 Hz</li> <li>• Catalyst 3560C-8PC-S: 1.6 to 0.8 A, 50 to 60 Hz</li> <li>• Catalyst 3560C-12PC-S: 1.61 to 0.8 A, 50 to 60 Hz</li> </ul>
DC input voltage	Unspecified when power adapter installed <ul style="list-style-type: none"> <li>• Catalyst 2960CPD-8TT-L: 37 to 57 VDC, 0.01 to 0.3 A</li> <li>• Catalyst 2960CPD-8PT-L: 37 to 57 VDC, 0.01 to 0.6 A</li> <li>• Catalyst 3560CPD-8PT-S: 37 to 57 VDC, 0.01 to 0.6 A</li> </ul>

**Table A-2 Catalyst 3560-C and 2960-C Switch Specifications (continued)**

Power consumption <sup>1</sup>	<ul style="list-style-type: none"> <li>• Catalyst 2960CPD-8TT-L: 15 W, 51 BTUs per hour (AC) 14.5 W, 50 BTUs per hour (DC PD)</li> <li>• Catalyst 2960CPD-8PT-L: 44 W, 74 BTUs per hour (AC) 43 W, 70 BTUs per hour (DC PD)</li> <li>• Catalyst 2960CG-8TC-L: 17.6 W, 60 BTUs per hour</li> <li>• Catalyst 2960C-8TC-L: 11 W, 38 BTUs per hour</li> <li>• Catalyst 2960C-8TC-S: 11 W, 38 BTUs per hour</li> <li>• Catalyst 2960C-8PC-L: 157 W, 88 BTUs per hour</li> <li>• Catalyst 2960C-12PC-L: 158 W, 91 BTUs per hour</li> <li>• Catalyst 3560CG-8PC-S: 165 W, 109 BTUs per hour</li> <li>• Catalyst 3560CG-8TC-S: 19.6 W, 67 BTUs per hour</li> <li>• Catalyst 3560CPD-8PT-S: 41.1 W, 88 BTUs per hour (AC) 40 W, 84 BTUs per hour (DC PD)</li> <li>• Catalyst 3560C-8PC-S: 158 W, 74 BTUs per hour</li> <li>• Catalyst 3560C-12PC-S: 159 W, 85 BTUs per hour</li> </ul>
Power rating	<ul style="list-style-type: none"> <li>• Catalyst 2960CPD-8TT-L: 0.02 KVA</li> <li>• Catalyst 2960CPD-8PT-L: 0.05 KVA</li> <li>• Catalyst 2960CG-8TC-L: 0.04 KVA</li> <li>• Catalyst 2960C-8TC-L: 0.03 KVA</li> <li>• Catalyst 2960C-8TC-S: 0.03 KVA</li> <li>• Catalyst 2960C-8PC-L: 0.16 KVA</li> <li>• Catalyst 2960C-12PC-L: 0.16 KVA</li> <li>• Catalyst 3560CG-8PC-S: 0.17 KVA</li> <li>• Catalyst 3560CG-8TC-S: 0.05 KVA</li> <li>• Catalyst 3560CPD-8PT-S: 0.05 KVA</li> <li>• Catalyst 3560C-8PC-S: 0.16 KVA</li> <li>• Catalyst 3560C-12PC-S: 0.16 KVA</li> </ul>

1. BTU values are switch dissipation only (excludes PoE which is dissipated at the end device).

**Table A-3 PoE Power Consumption**

Switch	Consumption without PoE	Consumption with PoE	Available PoE
Catalyst 2960CPD-8PT-L	14.5 W	43 W <sup>1</sup> 51 W <sup>2</sup>	22.4 W <sup>1</sup> 30.8 <sup>2</sup>
Catalyst 2960C-8PC-L	17.1 W	157 W	123.2 W
Catalyst 2960C-12PC-L	18.6 W	158 W	123.2 W
Catalyst 3560CPD-8PT-S	21.7 W	40 W <sup>1</sup> 51 W <sup>2</sup>	15.4 W <sup>1</sup> 23.8 <sup>2</sup>
Catalyst 3560CG-8PC-S	23.9 W	158 W	123.2 W
Catalyst 3560C-8PC-S	17.3 W	158 W	123.2 W
Catalyst 3560C-12PC-S	19.1 W	159 W	123.2 W

1. Requires both the uplink ports to be connected to PoE+ inputs.
2. Requires the uplink port to be connected to Cisco UPOE switch input.





# APPENDIX **B**

## Connector and Cable Specifications

- [Connector Specifications, page B-1](#)
- [Cables and Adapters, page B-3](#)

### Connector Specifications

- [10/100 and 10/100/1000 Ports, page B-1](#)
- [SFP Module Connectors, page B-2](#)
- [Dual-Purpose Ports, page B-2](#)
- [Cables and Adapters, page B-3](#)

### 10/100 and 10/100/1000 Ports

The 10/100 and 10/100/1000 Ethernet ports on switches use RJ-45 connectors and Ethernet pinouts with internal crossovers. [Figure B-1](#) and [Figure B-2](#) show the pinouts.

**Figure B-1** 10/100 Port Pinouts

Pin	Label	1	2	3	4	5	6	7	8
1	RD+								
2	RD-								
3	TD+								
4	NC								
5	NC								
6	TD-								
7	NC								
8	NC								

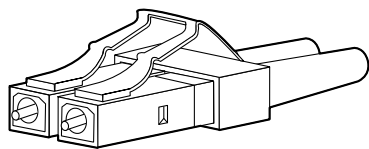
**Figure B-2 10/100/1000 Port Pinouts**

Pin	Label	1 2 3 4 5 6 7 8
1	TP0+	
2	TP0-	
3	TP1+	
4	TP2+	
5	TP2-	
6	TP1-	
7	TP3+	
8	TP3-	

60915

## SFP Module Connectors

**Figure B-3 Fiber-Optic SFP Module LC Connector**



58476



**Warning**

**Invisible laser radiation may be emitted from disconnected fibers or connectors. Do not stare into beams or view directly with optical instruments. Statement 1051**

## Dual-Purpose Ports

The 10/100/1000 Ethernet ports on the dual-purpose ports use RJ-45 connectors.

**Figure B-4 10/100/1000 Port Pinouts**

Pin	Label	1 2 3 4 5 6 7 8
1	TP0+	
2	TP0-	
3	TP1+	
4	TP2+	
5	TP2-	
6	TP1-	
7	TP3+	
8	TP3-	

60915

# Cables and Adapters

- [SFP Module Cables, page B-3](#)
- [Cable Pinouts, page B-4](#)
- [Console Port Adapter Pinouts, page B-5](#)

## SFP Module Cables

Each port must match the wave-length specifications on each end of the cable, and for reliable communications, the cable must not exceed the allowable length. Copper 1000BASE-T SFP transceivers use standard four twisted-pair, Category 5 (or greater) cable at lengths up to 328 feet (100 meters).

**Table B-1** Fiber-Optic SFP Module Port Cabling Specifications

Type of SFP Module	Wavelength (nanometers)	Fiber Type	Core Size/Cladding Size (micron)	Modal Bandwidth (MHz/km) <sup>1</sup>	Cable Distance
1000BASE-LX/LH (GLC-LH-SM)	1310	MMF <sup>2</sup>	62.5/125	500	1804 feet (550 m)
			50/125	400	1804 feet (550 m)
		SMF	50/125	500	1804 feet (550 m)
			G.652 <sup>2</sup>	—	32,810 feet (10 km)
1000BASE-SX (GLC-SX-MM)	850	MMF	62.5/125	160	722 feet (220 m)
			62.5/125	200	902 feet (275 m)
			50/125	400	1640 feet (500 m)
			50/125	500	1804 feet (550 m)
1000BASE-ZX (GLC-ZX-SM)	1550	SMF	G.652 <sup>2</sup>	—	43.4 to 62 miles (70 to 100 km) <sup>3</sup>
1000BASE-BX10-U (GLC-BX-U)	1310 TX 1490 RX	SMF	G.652 <sup>2</sup>	—	32,810 feet (10 km)
1000BASE-BX10-D (GLC-BX-D)	1490 TX 1310 RX	SMF	G.652 <sup>4</sup>	—	32,810 feet (10 km)
100BASE-FX (GLC-FE-100FX)	1310	MMF	50/125	500	6,562 feet (2 km)
			62.5/125	500	6,562 feet (2 km)
100BASE-LX (GLC-FE-100LX)	1310	SMF	G.652 <sup>2</sup>	—	32,810 feet (10 km)
100BASE-BX (GLC-FE-100BX-D GLC-FE-100BX-U)	1310 TX 1550 RX	SMF	G.652 <sup>2</sup>	—	32,810 feet (10 km)
CWDM	1470, 1490, 1510, 1530, 1550, 1570, 1590, 1610	SMF	G.652 <sup>2</sup>	—	62 miles (100 km)

1. Modal bandwidth applies only to multimode fiber.
2. A mode-conditioning patch cord is required. Using an ordinary patch cord with MMF, 1000BASE-LX/LH SFP modules, and a short link distance can cause transceiver saturation, resulting in an elevated bit error rate (BER). When using the LX/LH SFP module with 62.5-micron diameter MMF, you must also install a mode-conditioning patch cord between the SFP module and the MMF cable on both the sending and receiving ends of the link. The mode-conditioning patch cord is required for link distances greater than 984 feet (300 m).

3. 1000BASE-ZX SFP modules can send data up to 62 miles (100 km) by using dispersion-shifted SMF or low-attenuation SMF; the distance depends on the fiber quality, the number of splices, and the connectors.
4. A mode-field diameter/cladding diameter = 9 micrometers/125 micrometers.

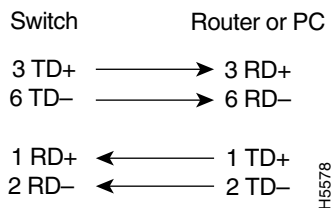


**Note**

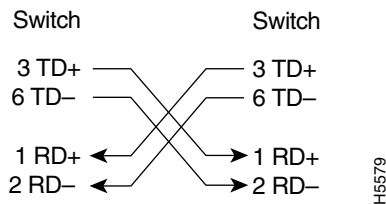
When the fiber-optic cable span is less than 15.43 miles (25 km), insert a 5-decibel (dB) or 10-dB inline optical attenuator between the fiber-optic cable plant and the receiving port on the 1000BASE-ZX SFP module.

## Cable Pinouts

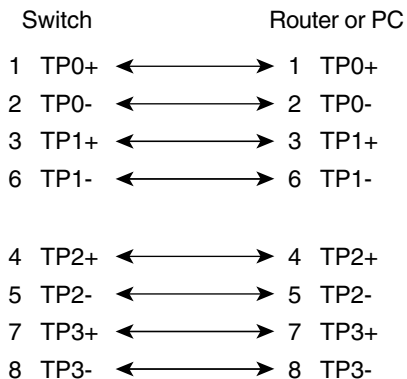
**Figure B-5 Two Twisted-Pair Straight-Through Cable Schematic for 10/100 Ports**



**Figure B-6 Two Twisted-Pair Crossover Cable Schematic for 10/100 Ports**

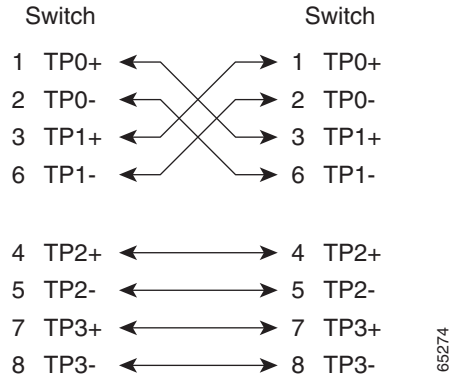


**Figure B-7 Four Twisted-Pair Straight-Through Cable Schematic for 1000BASE-T Ports**



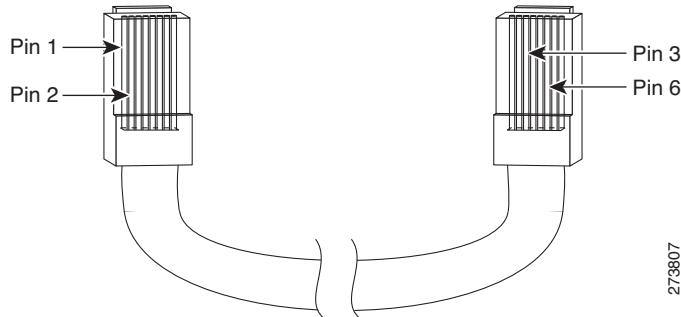


**Figure B-8 Four Twisted-Pair Crossover Cable Schematics for 1000BASE-T Ports**



To identify a crossover cable, hold the cable ends side-by-side, with the tab at the back. The wire connected to pin 1 on the left end should be the same color as the wire connected to pin 3 on the right end. The wire connected to pin 2 on the left end should be the same color as the wire connected to pin 6 on the right end.

**Figure B-9 Identifying a Crossover Cable**



## Console Port Adapter Pinouts

The console port uses an 8-pin RJ-45 connector, which is described in [Table B-2](#) and [Table B-3](#). If you did not order a console cable, you need to provide an RJ-45-to-DB-9 adapter cable to connect the switch console port to a PC console port. You need to provide an RJ-45-to-DB-25 female DTE adapter if you want to connect the switch console port to a terminal. You can order an adapter (part number ACS-DSBUASYN=). For console port and adapter pinout information, see [Table B-2](#) and [Table B-3](#).

[Table B-2](#) lists the pinouts for the console port, the RJ-45-to-DB-9 adapter cable, and the console device.

**Table B-2 Console Port Signaling Using a DB-9 Adapter**

Switch Console Port (DTE)	RJ-45-to-DB-9 Terminal Adapter	Console Device
Signal	DB-9 Pin	Signal
RTS	8	CTS
DTR	6	DSR

**Table B-2** Console Port Signaling Using a DB-9 Adapter (continued)

Switch Console Port (DTE)	RJ-45-to-DB-9 Terminal Adapter	Console Device
Signal	DB-9 Pin	Signal
TxD	2	RxD
GND	5	GND
RxD	3	TxD
DSR	4	DTR
CTS	7	RTS

Table B-3 lists the pinouts for the switch console port, RJ-45-to-DB-25 female DTE adapter, and the console device.

**Note**

The RJ-45-to-DB-25 female DTE adapter is not supplied with the switch. You can order this adapter from Cisco (part number ACS-DSBUASYN=).

**Table B-3** Console Port Signaling Using a DB-25 Adapter

Switch Console Port (DTE)	RJ-45-to-DB-25 Adapter	Console Device
Signal	DB-25 Pin	Signal
RTS	5	CTS
DTR	6	DSR
TxD	3	RxD
GND	7	GND
RxD	2	TxD
DSR	20	DTR
CTS	4	RTS



## APPENDIX **C**

# Configuring the Switch with the CLI Setup Program

---

This appendix provides a command-line interface (CLI) setup procedure for a standalone switch. To set up the switch by using Express Setup, see the *Catalyst 3560-C and 2960-C Switch Getting Started Guide*. Before connecting the switch to a power source, review the safety warnings in [Chapter 2, “Switch Installation.”](#)

## Accessing the CLI Through the Console Port

You can enter Cisco IOS commands and parameters through the CLI. Use one of these options to access the CLI:

- [RJ-45 Console Port](#)
- [USB Mini-Type B Console Port](#)

### RJ-45 Console Port

---

- Step 1** Connect the RJ-45-to-DB-9 adapter cable to the 9-pin serial port on the PC. Connect the other end of the cable to the switch console port.
- Step 2** Start the terminal-emulation program on the PC or the terminal. The program, frequently a PC application such as HyperTerminal or ProcommPlus, makes communication between the switch and your PC or terminal possible.

**Figure C-1** Connecting the Console Cable

<b>1</b>	RJ-45 console port	<b>2</b>	Console cable (RJ-45-to-DB-9 adapter cable)
----------	--------------------	----------	---

**Step 3** Configure the baud rate and character format of the PC or terminal to match the console port characteristics:

- 9600 baud
- 8 data bits
- 1 stop bit
- No parity
- None (flow control)

**Step 4** Connect power to the switch as described in [Chapter 2, “Switch Installation.”](#)

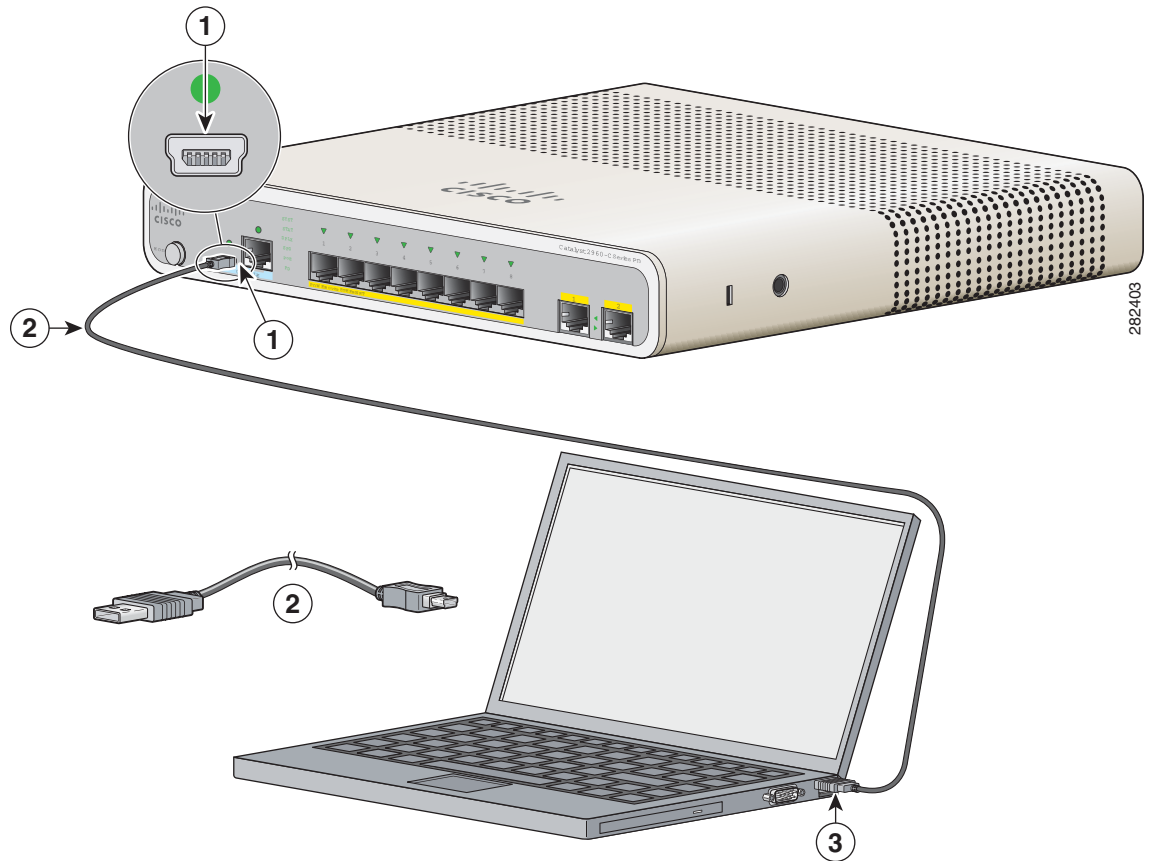
**Step 5** The PC or terminal displays the bootloader sequence. Press **Enter** to display the setup prompt. Follow the steps in the [“Completing the Setup Program”](#) section on page C-7.

## USB Mini-Type B Console Port

**Step 1** If you are connecting the switch USB-mini console port to a Windows-based PC for the first time, install a USB driver. See [Figure C-2](#).

- “Installing the Cisco Microsoft Windows XP USB Driver” section on page C-4
- “Installing the Cisco Microsoft Windows 2000 USB Driver” section on page C-5
- “Installing the Cisco Microsoft Windows Vista and Windows 7 USB Driver” section on page C-5

**Figure C-2** Connecting the USB-Mini Console Cable



<b>1</b>	USB-mini console port	<b>3</b>	USB port on the PC
<b>2</b>	USB cable		

**Step 2** Connect an USB cable to the PC USB port. Connect the other end of the cable to the switch mini-B (5-pin-connector) USB-mini console port. See [Figure C-2](#).

**Step 3** To identify the COM port assigned to the USB-mini console port:  
 Choose **Start > Control Panel > Systems**.  
 Click the **Hardware** tab and choose **Device Manager**. Expand the **Ports** section. The assigned COM port appears in parenthesis at the end of the line with this entry: Cisco USB System Management Console.

- Step 4** Start the terminal-emulation program on the PC or the terminal. The program, frequently a PC application such as HyperTerminal or ProcommPlus, makes communication possible between the switch and your PC or terminal.
- Step 5** Configure the COM port.
- Step 6** Configure the baud rate and character format of the PC or terminal to match the console port characteristics:
- 9600 baud
  - 8 data bits
  - 1 stop bit
  - No parity
  - None (flow control)
- Step 7** Connect power to the switch as described in [Chapter 2, “Switch Installation.”](#)
- Step 8** The PC or terminal displays the bootloader sequence. Press **Enter** to display the setup prompt. Follow the steps in the [“Completing the Setup Program”](#) section on page C-7.
- 

## Installing the Cisco Microsoft Windows USB Device Drivers

### Installing the Cisco Microsoft Windows XP USB Driver

- 
- Step 1** Obtain the file Cisco\_usbconsole\_driver.zip from Cisco.com, and unzip it.



---

**Note** You can download the driver file from the Cisco.com software download site.

---

- Step 2** If using 32-bit Windows XP, double-click the setup.exe file in the Windows\_32 folder. If using 64-bit Windows XP, double-click the setup(x64).exe file in the Windows\_64 folder.
- Step 3** The Cisco Virtual Com InstallShield Wizard begins.
- Step 4** The Ready to Install the Program window appears. Click **Install**.
- Step 5** The InstallShield Wizard Completed window appears. Click **Finish**.
- Step 6** Connect the USB cable to the PC and to the switch console port. The USB-mini console port LED turns green, and the Found New Hardware Wizard appears. Follow the instructions to complete the driver installation.
-

## Installing the Cisco Microsoft Windows 2000 USB Driver

---

**Step 1** Obtain the file Cisco\_usbconsole\_driver.zip from Cisco.com, and unzip it.



---

**Note** You can download the driver file from the Cisco.com software download site.

---

**Step 2** Double-click the setup.exe file.

**Step 3** The Cisco Virtual Com InstallShield Wizard begins. Click **Next**.

**Step 4** The Ready to Install the Program window appears. Click **Install**.

**Step 5** The InstallShield Wizard Completed window appears. Click **Finish**.

**Step 6** Connect the USB cable to the PC and to the switch console port. The USB-mini console port LED turns green, and the Found New Hardware Wizard appears. Follow the instructions to complete the driver installation.

---

## Installing the Cisco Microsoft Windows Vista and Windows 7 USB Driver

---

**Step 1** Obtain the file Cisco\_usbconsole\_driver.zip from Cisco.com, and unzip it.



---

**Note** You can download the driver file from the Cisco.com software download site.

---

**Step 2** If using 32-bit Windows Vista or Windows 7, double-click the setup.exe file in the Windows\_32 folder. If using 64-bit Windows Vista or Windows 7, double-click the setup(x64).exe file in the Windows\_64 folder.

**Step 3** The Cisco Virtual Com InstallShield Wizard begins. Click **Next**.

**Step 4** The Ready to Install the Program window appears. Click **Install**.



---

**Note** If a User Account Control warning appears, click *Allow - I trust this program*.

---

**Step 5** The InstallShield Wizard Completed window appears. Click **Finish**.

**Step 6** Connect the USB cable to the PC and to the switch console port. The USB-mini console port LED turns green, and the Found New Hardware Wizard appears. Follow the instructions to complete the driver installation.

---

## Uninstalling the Cisco Microsoft Windows USB Drivers

### Uninstalling the Cisco Microsoft Windows XP and 2000 USB Driver

You can uninstall the driver by using the Windows Add or Remove Programs utility or by using the setup.exe file.

#### Using the Add or Remove Programs Utility



---

**Note** Disconnect the switch console terminal before uninstalling the driver.

---

- Step 1** Choose **Start > Control Panel > Add or Remove Programs**.
  - Step 2** Scroll to Cisco Virtual Com, and click **Remove**.
  - Step 3** When the Program Maintenance window appears, select the **Remove** radio button. Click **Next**.
- 

#### Using the Setup.exe Program



---

**Note** Disconnect the switch console terminal before uninstalling the driver.

---

- Step 1** Run setup.exe for 32-bit Windows or setup(x64).exe for 64-bit Windows. Click **Next**.
  - Step 2** The InstallShield Wizard for Cisco Virtual Com appears. Click **Next**.
  - Step 3** When the Program Maintenance window appears, click the **Select the** radio button. Click **Next**.
  - Step 4** When the Remove the Program window appears, select **Remove**.
  - Step 5** When the InstallShield Wizard Completed window appears, click **Finish**.
- 

### Uninstalling the Cisco Microsoft Windows Vista and Windows 7 USB Driver



---

**Note** Disconnect the switch console terminal before uninstalling the driver.

---

- Step 1** Run setup.exe for 32-bit Windows or setup(x64).exe for 64-bit Windows. Click **Next**.
- Step 2** The InstallShield Wizard for Cisco Virtual Com appears. Click **Next**.
- Step 3** When the Program Maintenance window appears, select the **Remove** radio button. Click **Next**.



**Step 4** When the Remove the Program window appears, click **Remove**.



**Note** If a User Account Control warning appears, click *Allow - I trust this program* to proceed.

**Step 5** When the InstallShield Wizard Completed window appears, click **Finish**.

## Entering the Initial Configuration Information

To set up the switch, you need to complete the setup program, which runs automatically after the switch powers on. You must assign an IP address and other configuration information necessary for the switch to communicate with the local routers and the Internet.

### IP Settings

You need this information:

- Switch IP address
- Subnet mask (IP netmask)
- Default gateway (router)
- Enable secret password
- Enable password
- Telnet password

### Completing the Setup Program

Follow these steps to complete the setup program and to create an initial configuration for the switch:

**Step 1** Enter **Yes** at these two prompts.

```
Would you like to enter the initial configuration dialog? [yes/no]: yes
```

At any point you may enter a question mark '?' for help.  
Use ctrl-c to abort configuration dialog at any prompt.  
Default settings are in square brackets '['].

Basic management setup configures only enough connectivity  
for management of the system, extended setup will ask you  
to configure each interface on the system.

```
Would you like to enter basic management setup? [yes/no]: yes
```

**Step 2** Enter a host name for the switch, and press **Return**.

On a command switch, the host name is limited to 28 characters and on a member switch to 31 characters. Do not use *-n*, where *n* is a number, as the last character in a host name for any switch.

```
Enter host name [Switch]: host_name
```

- Step 3** Enter an enable secret password, and press **Return**.

The password can be from 1 to 25 alphanumeric characters, can start with a number, is case sensitive, allows spaces, but ignores leading spaces. The secret password is encrypted, and the enable password is in plain text.

```
Enter enable secret: secret_password
```

- Step 4** Enter an enable password, and press **Return**.

```
Enter enable password: enable_password
```

- Step 5** Enter a virtual terminal (Telnet) password, and press **Return**.

The password can be from 1 to 25 alphanumeric characters, is case sensitive, allows spaces, but ignores leading spaces.

```
Enter virtual terminal password: terminal-password
```

- Step 6** (Optional) Configure Simple Network Management Protocol (SNMP) by responding to the prompts. You can also configure SNMP later through the CLI. To configure SNMP later, enter **no**.

```
Configure SNMP Network Management? [no]: no
```

- Step 7** Enter the interface name (physical interface or VLAN name) of the interface that connects to the management network, and press **Return**. For this release, always use `vlan1` as that interface.

```
Enter interface name used to connect to the
management network from the above interface summary: vlan1
```

- Step 8** Configure the interface by entering the switch IP address and subnet mask and pressing **Return**. The IP address and subnet masks shown below are examples.

```
Configuring interface vlan1:
Configure IP on this interface? [yes]: yes
IP address for this interface: 10.4.120.106
Subnet mask for this interface [255.0.0.0]: 255.0.0.0
```

- Step 9** Enter **Y** to configure the switch as the cluster command switch. Enter **N** to configure it as a member switch or as a standalone switch.

If you enter **N**, you can configure the switch as a command switch later through the CLI. To configure it later, enter **no**.

```
Would you like to enable as a cluster command switch? [yes/no]: no
```

You have completed the initial configuration of the switch, and the switch displays its configuration. This is an example of the configuration output:

```
The following configuration command script was created:
hostname switch1
enable secret 5 $1$U1q8$D1A/OiaEb190WcBPd9cOn1
enable password enable_password
line vty 0 15
password terminal-password
no snmp-server
!
no ip routing

!
interface Vlan1
no shutdown
ip address 10.4.120.106 255.0.0.0
!
interface FastEthernet1/0/1
```

```
!  
interface FastEthernet1/0/2  
  
interface FastEthernet1/0/3  
!  
...<output abbreviated>  
end
```

**Step 10** These choices appear:

- [0] Go to the IOS command prompt without saving this config.
- [1] Return back to the setup without saving this config.
- [2] Save this configuration to nvram and exit.

If you want to save the configuration and use it the next time the switch reboots, select option 2 to save it in NVRAM.

Enter your selection [2]:**2**

Make your selection, and press **Return**.

---

After you complete the setup program, the switch can run the default configuration that you created. To change this configuration or to perform other management tasks, enter commands at the `Switch>` *prompt*.

■ Entering the Initial Configuration Information

## Free Manuals Download Website

<http://myh66.com>

<http://usermanuals.us>

<http://www.somanuals.com>

<http://www.4manuals.cc>

<http://www.manual-lib.com>

<http://www.404manual.com>

<http://www.luxmanual.com>

<http://aubethermostatmanual.com>

Golf course search by state

<http://golfingnear.com>

Email search by domain

<http://emailbydomain.com>

Auto manuals search

<http://auto.somanuals.com>

TV manuals search

<http://tv.somanuals.com>